

Digitized by the Internet Archive
in 2009

<http://www.archive.org/details/encyclopdiaabri06chisrich>

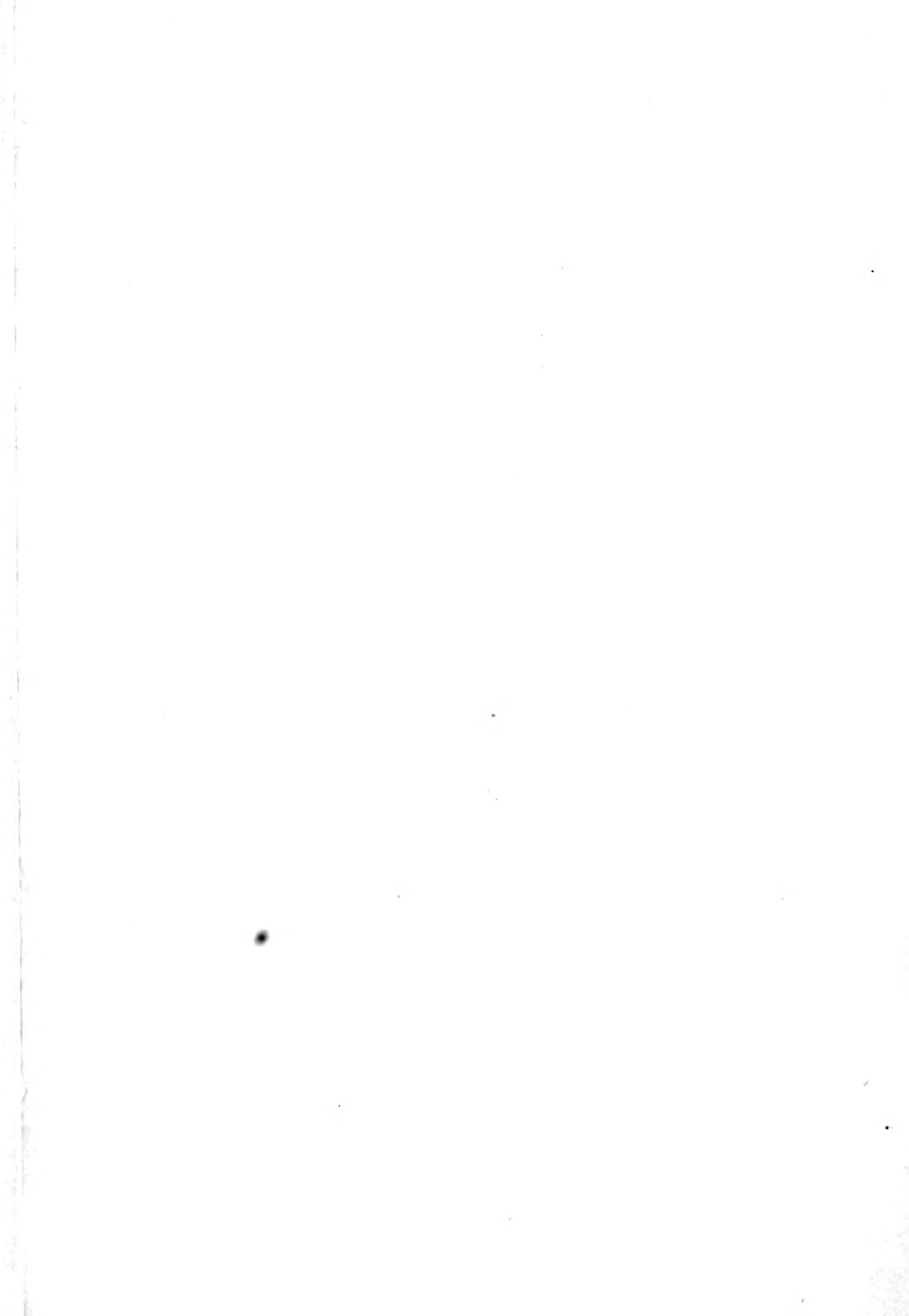

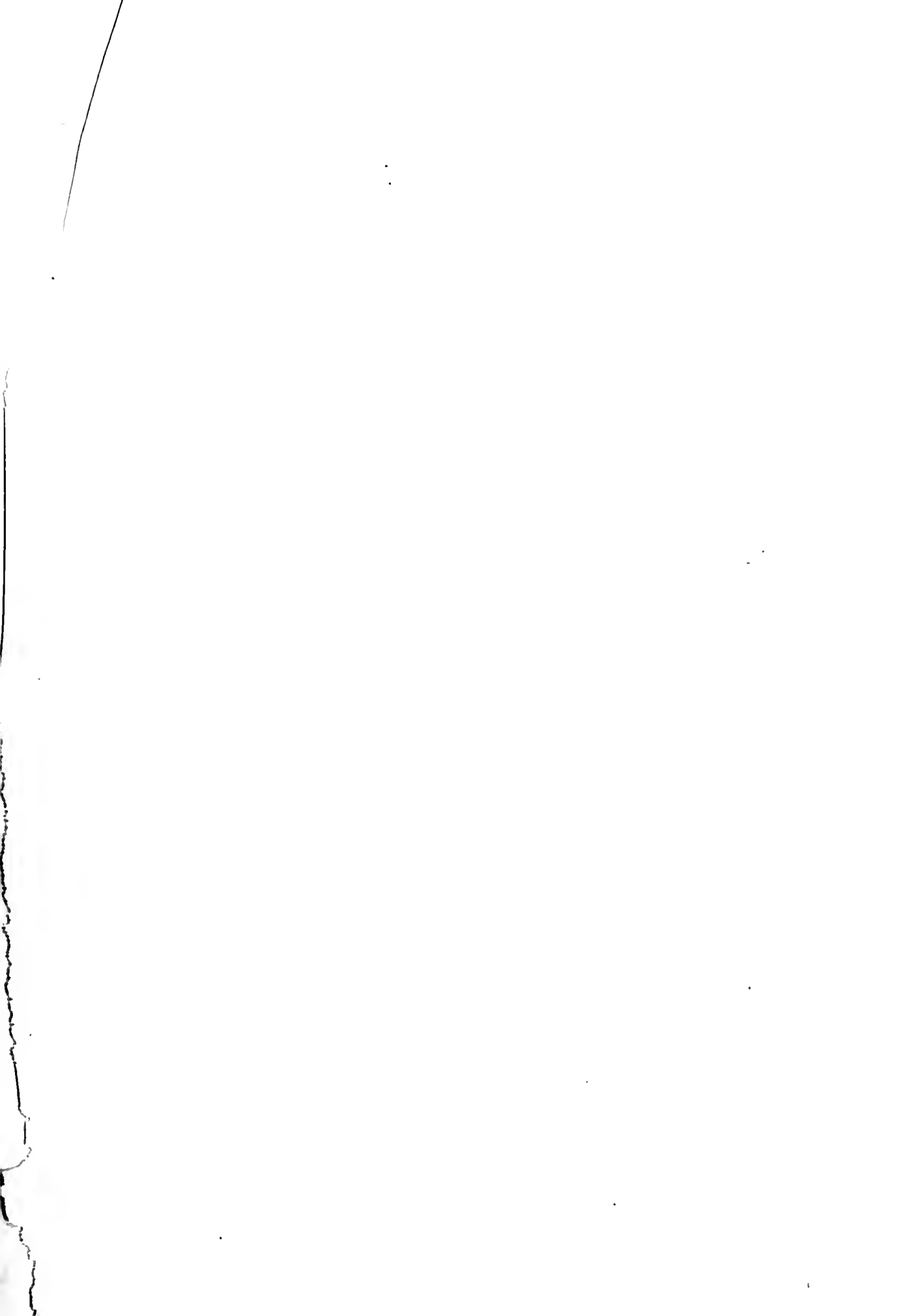

THE ENCYCLOPÆDIA BRITANNICA

ELEVENTH EDITION

FIRST	edition, published in three	volumes,	1768—1771.
SECOND	” ” ten	”	1777—1784.
THIRD	” ” eighteen	”	1788—1797.
FOURTH	” ” twenty	”	1801—1810.
FIFTH	” ” twenty	”	1815—1817.
SIXTH	” ” twenty	”	1823—1824.
SEVENTH	” ” twenty-one	”	1830—1842.
EIGHTH	” ” twenty-two	”	1853—1860.
NINTH	” ” twenty-five	”	1875—1889.
TENTH	” ninth edition and eleven supplementary volumes,		1902—1903.
ELEVENTH	” published in twenty-nine volumes,		1910—1911.

THE
ENCYCLOPÆDIA BRITANNICA

A
DICTIONARY
OF
ARTS, SCIENCES, LITERATURE AND GENERAL
INFORMATION

ELEVENTH EDITION

VOLUME VI
CHÂTELET to CONSTANTINE

NEW YORK
THE ENCYCLOPÆDIA BRITANNICA COMPANY
1910

1911

ENCYCLOPEDIA BRITANNICA

THIRTEENTH EDITION

IN TWENTY VOLUMES

1911

Copyright, in the United States of America, 1910,

by

The Encyclopædia Britannica Company.

CHICAGO

1911

PRINTED BY

THE ENCYCLOPEDIA BRITANNICA COMPANY, CHICAGO, ILL.

INITIALS USED IN VOLUME VI. TO IDENTIFY INDIVIDUAL
CONTRIBUTORS,¹ WITH THE HEADINGS OF THE
ARTICLES IN THIS VOLUME SO SIGNED.

A. Bo.*	AUGUSTE BOUDINHON, D.D., D.C.L. Professor of Canon Law in the Catholic University of Paris. Editor of the <i>Canoniste contemporain</i> . Author of <i>Biens d'église et peines canoniques</i> ; &c.	{ Conclave; Concordat; Consistory.
A. B. G.*	ALICE B. GOMME. Hon. Member of the Folk-lore Society. Author of <i>Dictionary of Traditional Games of Great Britain and Ireland</i> ; <i>Children's Singing Games</i> .	{ Children's Games.
A. B. R.	ALFRED BARTON RENDLE, M.A., D.Sc., F.R.S., F.L.S. Keeper, Department of Botany, British Museum. Author of <i>Text Book on Classification of Flowering Plants</i> ; &c.	{ Cocoa: Botany; Coffee: Botany.
A. C. Be.	ARTHUR CHRISTOPHER BENSON, C.V.O., M.A., F.R.HIST.S. See the biographical article: BENSON, EDWARD WHITE.	{ Church, Dean.
A. C. C.	ALBERT CURTIS CLARK, M.A. Fellow and Tutor of Queen's College, Oxford, and University Reader in Latin. Editor of <i>Cicero's Speeches</i> (Clarendon Press).	{ Cicero.
A. C. McG.	ARTHUR CUSHMAN MCGIFFERT, D.D., PH.D., M.A. Professor of Church History in Union Theological Seminary, New York. Author of <i>A History of Christianity in the Apostolic Age</i> ; &c.	{ Church History (<i>in part</i>).
A. C. S.	ALGERNON CHARLES SWINBURNE. See the biographical article: SWINBURNE, A. C.	{ Congreve, William.
A. D.	AUSTIN DOBSON. See the biographical article: DOBSON, HENRY AUSTIN.	{ Chesterfield, 4th Earl of.
A. E. B.	REV. ANDREW EWBANK BURN, M.A., D.D. Vicar of Halifax and Prebendary of Lichfield. Author of <i>An Introduction to the Creeds and the Te Deum</i> ; <i>Niceta of Remesiana</i> ; &c.	{ Church.
A. F. L.	ARTHUR FRANCIS LEACH, M.A. Barrister-at-Law, Middle Temple. Charity Commissioner for England and Wales. Formerly Assistant Secretary of the Board of Education. Fellow of All Souls' College, Oxford, 1874-1881. Stanhope Prizeman, 1872.	{ Chicheley.
A. G.	MAJOR ARTHUR GEORGE FREDERICK GRIFFITHS (d. 1908). H.M. Inspector of Prisons, 1878-1896. Author of <i>The Chronicles of Newgate</i> ; <i>Secrets of the Prison House</i> ; &c.	{ Children's Courts.
A. Go.*	REV. ALEXANDER GORDON, M.A. Lecturer on Church History in the University of Manchester.	{ Chemnitz; Cochlaeus.
A. H.*	ALBERT HAUCK, D.Th., Ph.D., D.Juris. Professor of Church History in the University of Leipzig. Director of the Collection of Ecclesiastical Archaeology. Member of the Royal Saxon Society of Arts and Sciences. Formerly Professor in the University of Erlangen. Editor of the 3rd edition of Herzog-Hauck's <i>Realencyklopädie für protestantische Theologie und Kirche</i> . Author of <i>Kirchengeschichte Deutschlands</i> ; <i>Tertullians Leben und Schriften</i> ; &c.	{ Church History (<i>in part</i>).
A. He.*	AUGUSTINE HENRY, M.A., F.L.S. Reader in Forestry, Cambridge University. Formerly Official in Chinese Imperial Maritime Customs. Explorer of the Flora of the interior of China, Formosa and Hainan.	{ China: Flora.
A. H. J. G.	ABEL HENDY JONES GREENIDGE, M.A., D.LITT. (Oxon.) (d. 1905). Formerly Fellow and Lecturer of Hertford College, Oxford, and of St John's College, Oxford. Author of <i>Infamia in Roman Law</i> ; <i>Handbook of Greek Constitutional History</i> ; <i>Roman Public Life</i> ; <i>History of Rome</i> . Joint-author of <i>Sources of Roman History, 133-70 B.C.</i>	{ Comitia.
A. J. G.	REV. ALEXANDER JAMES GRIEVE, M.A., B.D. (Lond.). Professor of New Testament and Church History, Yorkshire United Independent College, Bradford. Sometime Registrar of Madras University and Member of Mysore Educational Service.	{ Clement I. (<i>in part</i>).

¹ A complete list, showing all individual contributors, appears in the final volume.

- A. J. L.** ANDREW JACKSON LAMOUREUX.
Librarian, College of Agriculture, Cornell University. Editor of the *Rio News* (Rio de Janeiro), 1879-1901
- A. Lo.** AUGUSTE LONGNON.
Professor at the Collège de France. Director of the École des Hautes Études. Chevalier of the Legion of Honour. Member of the Institute. Author of *Géographie de la Gaule au VI^e siècle*.
- A. W. C.** ARTHUR WILLIAM CLAYDEN, M.A.
Christ's College, Cambridge. Principal of the Royal Albert Memorial College, Exeter. Author of *Cloud Studies*; *The Clouds of Venus*; &c.
- A. W. Po.** ALFRED WILLIAM POLLARD, M.A.
Assistant Keeper of Printed Books, British Museum. Fellow of King's College, London. Hon. Secretary, Bibliographical Society. Editor of *Books about Books* and *Bibliographica*. Joint-editor of the *Library*. Chief Editor of the "Globe" *Chaucer*.
- A. W. R.** ALEXANDER WOOD RENTON, M.A., LL.B.
Puisne Judge of the Supreme Court of Ceylon. Editor of *Encyclopædia of the Laws of England*.
- C.** EARL OF CREWE.
See the biographical article: CREWE, EARL OF.
- C. A. MacM.** CHARLES ALEXANDER MACMUNN, M.A., M.D., F.C.S.
Formerly Physician and Pathologist to Wolverhampton General Hospital. Author of *Outlines of Clinical Chemistry*; *The Spectroscope in Medicine*; &c.
- C. B.*** CHARLES BÉMONT, D.LITT. (Oxon.).
See the biographical article: BÉMONT, C.
- C. Bi.** REV. CHARLES BIGG, M.A., D.D. (1840-1908).
Regius Professor of Ecclesiastical History, Oxford, 1901-1908. Examining Chaplain to Bishop of London. Author of *Neoplatonism*; *The Christian Platonists of Alexandria*; &c. Editor of *St Augustine's Confessions*; *De Imitatione*; &c.
- C. E.*** CHARLES EVERITT, M.A., F.C.S., F.G.S., F.R.A.S.
Sometime Scholar of Magdalen College, Oxford.
- C. E. A.** C. E. AKERS.
Formerly *Times* Correspondent in Buenos Aires. Author of *A History of South America, 1854-1904*.
- C. H. Ha.** CARLTON HUNTLEY HAYES, D.D.
Assistant Professor of History in Columbia University, New York City. Member of the American Historical Association. Author of *An Introduction to the Sources relating to the Barbarian Invasions*.
- C. J. H.** CHARLES JOHN HOLMES, M.A.
Director, Keeper and Secretary of the National Portrait Gallery. Slade Professor of Fine Art, Oxford, 1904-1910. Author of *Constable*; *Constable and his Influence on Landscape Painting*; *Notes on the Science of Picture Making*; &c.
- C. M. K.** SIR CHARLES MALCOLM KENNEDY, K.C.M.G., C.B. (1831-1908).
Head of Commercial Department, Foreign Office, 1872-1893. Lecturer on International Law, University College, Bristol. Commissioner in the Levant, 1870-1871; at Paris, 1872-1886. Plenipotentiary, Treaty of the Hague, 1882. Author of *Diplomacy and International Law*.
- C. Pf.** CHRISTIAN PFISTER, D. ÈS L.
Professor at the Sorbonne, Paris. Chevalier of the Legion of Honour. Author of *Études sue le règne de Robert le Pieux*; &c.
- C. R. B.** CHARLES RAYMOND BEAZLEY, M.A., D.LITT., F.R.G.S., F.R.HIST.S.
Professor of Modern History in the University of Birmingham. Formerly Fellow of Merton College, Oxford, and University Lecturer in the History of Geography. Lothian Prizeman, Oxford, 1889. Lowell Lecturer, Boston, 1908. Author of *Henry the Navigator*; *The Dawn of Modern Geography*; &c.
- C. S.** HON. CARL SCHURZ, LL.D.
See the biographical article: SCHURZ, CARL.
- C. W. R. C.** CHARLES WALLWYN RADCLIFFE COOKE.
President, National Association of English Cider-makers. M.P. for Walworth, 1885-1892, and for Hereford, 1893-1900. Author of *A Book about Cider and Perry*.
- C. W. W.** SIR CHARLES WILLIAM WILSON, K.C.B., K.C.M.G., F.R.S. (1836-1907).
Major-General, Royal Engineers. Secretary to the North American Boundary Commission, 1858-1862. British Commissioner on the Servian Boundary Commission. Director-General of the Ordnance Survey, 1886-1894. Director-General of Military Education, 1895-1898. Author of *From Korti to Khartoum*; *Life of Lord Clive*; &c.
- D. F. T.** DONALD FRANCIS TOVEY.
Balliol College, Oxford. Author of *Essays in Musical Analysis, comprising the Classical Concerto*; *The Goldberg Variations*; and analyses of many other classical works.
- Chile: Geography and Statistics;**
Colombia: Geography and Statistics.
- Châtillon.**
- Cloud.**
- Chaucer;**
Colophon.
- Compensation.**
- Cherbuliez.**
- Colours of Animals:**
Chemistry.
- Chronicle;**
Communes.
- Clement of Alexandria**
(in part).
- Chemistry;**
Circle (in part).
- Chile: History (in part).**
- Clement VI.;**
Clement VIII.: antipope.
- China: Chinese Art (Sculpture);**
Constable, John.
- Commercial Treaties.**
- Childebert; Chilperic;**
Clotaire; Clotilda, Saint;
Clovis.
- Columbus, Christopher.**
- Clay, Henry.**
- Clder.**
- Cilicia (in part).**
- Cherubini;**
Chorale;
Concerto.

- D. G. H.** DAVID GEORGE HOGARTH, M.A.
Keeper of the Ashmolean Museum, Oxford. Fellow of Magdalen College, Oxford. Fellow of the British Academy. Excavated at Paphos, 1888; Naukratis, 1899 and 1903; Ephesus, 1904-1905; Assiut, 1906-1907. Director, British School at Athens, 1897-1900; Director, Cretan Exploration Fund, 1899. { Cilicia (*in part*);
Colophon;
Comana.
- D. H.** DAVID HANNAY.
Formerly British Vice-Consul at Barcelona. Author of *Short History of Royal Navy, 1217-1688*; *Life of Emilio Castelar*; &c. { Chioggia;
Church, Sir Richard;
Coastguard;
Codrington, Sir Edward.
- D. Mn.** REV. DUGALD MACFADYEN, M.A.
Minister of South Grove Congregational Church, Highgate. Director of the London Missionary Society. Author of *Constructive Congregational Ideals*. { Concordance.
- E. B. P.** EDWARD BAGNALL POULTON, M.A., D.Sc., LL.D., F.R.S.
Hope Professor of Zoology in the University of Oxford. Fellow of Jesus College, Oxford. Author of *The Colours of Animals*; *Essays on Evolution*; *Darwin and the Original Species*; &c. { Colours of Animals.
Bionomics.
- E. C. B.** RIGHT REV. EDWARD CUTHBERT BUTLER, O.S.B., D.LITT. (Dublin).
Abbot of Downside Abbey, Bath. { Cistercians; Clara, Saint;
Clares, Poor; Cluny.
- E. C. Q.** EDMUND CROSBY QUIGGIN, M.A.
Fellow and Lecturer in Modern Languages and Monro Lecturer in Celtic, Gonville and Caius College, Cambridge. { Columba, Saint.
- E. E. H.** EDWARD EVERETT HALE
See the biographical article: HALE, E. E. { Clarke, James Freeman.
- E. G.** EDMUND GOSSE, LL.D.
See the biographical article: GOSSE, E. { Choriambic Verse; Clanvowe;
Collins, William;
Conscience, Hendrik;
Constable, Henry.
- E. G. J. M.** E. G. J. MOYNA, F.R.G.S.
New College, Oxford. { Chile: *History (in part)*.
- E. Gr.** ERNEST ARTHUR GARDNER, M.A.
See the biographical article: GARDNER, PERCY. { Chios (*in part*);
Cithaeron; Clazomenae.
- E. H. M.** ELLIS HOVELL MINNS, M.A.
Lecturer in Palaeography in the University of Cambridge. Lecturer and Assistant Librarian, and formerly Fellow of Pembroke College, Cambridge. { Chersonese;
Cimmerii.
- E. K. C.** EDMUND KERCHEVER CHAMBERS.
Assistant Secretary, Board of Education. Sometime Scholar of Corpus Christi College, Oxford. Chancellor's English Essayist, 1891. Author of *The Medical Stage*. Editor of the "Red Letter" *Shakespeare*; *Donne's Poems*; *Vaughan's Poems*; &c. { Clough, A. H.
- E. Ma.** EDWARD MANSON.
Barrister-at-Law, Middle Temple. Joint-editor of *Journal of Comparative Legislation*; *Law of Trading Companies*; *Practical Guide to Company Law*; &c. { Company.
- Ed. M.** EDUARD MEYER, D.LITT. (OXON.), PH.D., LL.D.
Professor of Ancient History in the University of Berlin. Member of the Royal Prussian Academy. Author of *Geschichte des Alterthums*; *Forschungen zur alten Geschichte*; &c. { Chosroes.
- E. O.*** EDMUND OWEN, M.B., F.R.C.S., LL.D., D.Sc.
Consulting Surgeon to St Mary's Hospital, London, and to the Children's Hospital, Great Ormond Street. Author of *A Manual of Anatomy for Senior Students*. { Cleft Palate and Hare Lip.
- E. V.** REV. EDMUND VENABLES, M.A., D.D. (1819-1895).
Canon and Precentor of Lincoln. Author of *Episcopal Palaces of England*. { Cloister.
- E. W. C.** ETTRICK WILLIAM CREAK, C.B., F.R.S., F.R.G.S.
Captain, R.N. Formerly Superintendent of Compasses, Hydrographic Department, Admiralty. Author of many papers on magnetic subjects. { Compass (*in part*).
- F. C. G.** FREDERICK CORNWALLIS CONYBEARE, M.A., D.TH. (Giessen).
Fellow of the British Academy. Formerly Fellow of University College, Oxford. Author of *The Ancient Armenian Texts of Aristotle*; *Myth, Magic and Morals*; &c. { Christmas;
Consecration.
- F. E. W.-S.** FRANCIS EDWARD WENTWORTH-SHEILDS, M.INST.C.E.
Docks Engineer, London & South-Western Railway. { Concrete
- F. G. M. B.** FREDERICK GEORGE MEESON BECK, M.A.
Fellow and Lecturer in Classics, Clare College, Cambridge. { Cimbri;
Cænwulf.
- F. G. P.** FREDERICK GYMER PARSONS, F.R.C.S., F.Z.S., F.R.ANTHROP.INST.
Vice-President, Anatomical Society of Great Britain and Ireland. Lecturer on Anatomy at St Thomas's Hospital and the London School of Medicine for Women. Formerly Hunterian Professor at the Royal College of Surgeons. { Coelom and Serous Membranes.
- F. H.*** FREDERICK HIRTH, PH.D.
Professor of Chinese in Columbia University, New York. Author of *China and the Roman Orient*; *The Ancient History of China to the End of the Ghôn Dynasty*; &c. { China: *History (in part)*.
- F. H. B.** FRANCIS H. BUTLER, M.A.
Associate of the Royal School of Mines. { Compass (*in part*).
- F. J. J.-S.** REV. FREDERICK JOHN JERVIS-SMITH, M.A., F.R.S., F.R.A.S.
Millard Lecturer in Experimental Mechanics and Engineering, Trinity College, Oxford. Formerly University Lecturer in Mechanics. { Chronograph.

F. K.	FRIEDRICH WILHELM EDUARD KEUTGEN, Ph.D. Professor of History in the University of Hamburg. Formerly Professor of Medieval and Modern History in the University of Jena. Author of <i>Die Hanse und England im 14. Jahrhundert; Untersuchungen über den Ursprung der deutschen Stadtverfassung; Urkunden zur städtischen Verfassungsgeschichte; Ämter und Zünfte; &c.</i>	Commune: Medieval.
F. LL. G.	FRANCIS LLEWELLYN GRIFFITH, M.A., Ph.D. (Leipzig), F.S.A. Reader in Egyptology, Oxford University. Formerly Scholar of Queen's College, Oxford. Editor of the <i>Archaeological Survey and Archaeological Reports of the Egypt Exploration Fund</i> . Fellow of Imperial German Archaeological Institute.	Cheops.
F. N. M.	COL. FREDERIC NATUSCH MAUDE, C.B. Lecturer in Military History, Manchester University. Author of <i>War and the World's Policy; The Leipzig Campaign; The Jena Campaign.</i>	Conscription.
F. R. C.	FRANK R. CANA. Author of <i>South Africa from the Great Trek to the Union.</i>	Congo; Congo Free State (in part).
F. W. R.*	FREDERICK WILLIAM RUDLER, I.S.O., F.G.S. Curator and Librarian of the Museum of Practical Geology, London, 1879-1902. President of the Geologists' Association, 1887-1889.	Chrysoberyl; Chrysoprase; Cinnabar.
G.	LORD GRIMTHORPE. See the biographical article: GRIMTHORPE, 1ST BARON.	Clock (in part).
G. A. B.	GEORGE A. BOULENGER, F.R.S. In charge of the Collections of Reptiles and Fishes, Department of Zoology, British Museum. Vice-President of the Zoological Society of London.	Cichlid; Cod.
G. C. W.	GEORGE CHARLES WILLIAMSON, Litt.D. Chevalier of the Legion of Honour. Author of <i>Portrait Miniatures; Life of Richard Cosway, R.A.; George Engleheart; Portrait Drawings; &c.</i> Editor of new edition of Bryan's <i>Dictionary of Painters and Engravers.</i>	Clouet, François; Clouet, Jean.
G. E.	REV. GEORGE EDMUNDSON, M.A., F.R.HIST.S. Formerly Fellow and Tutor of Brasenose College, Oxford. Ford's Lecturer, 1909. Employed by British Government in preparation of the British case in the British Guiana-Venezuelan and British Guiana-Brazilian boundary arbitrations.	Chile: History (in part); Colombia: History.
G. Fa.	G. FAUR.	Conjuring (in part).
G. G. Co.	GEORGE GORDON COULTON, M.A. Birkbeck Lecturer in Ecclesiastical History, Trinity College, Cambridge. Author of <i>Medieval Studies; Chaucer and his England; &c.</i>	Concubinage.
G. H. C.	GEORGE HERBERT CARPENTER, M.R.I.A. Professor of Zoology in the Royal College of Science, Dublin. Author of <i>Insects: their Structure and Life.</i>	Coleoptera.
G. H. Fo.	GEORGE HERBERT FOWLER, Ph.D., F.Z.S., F.I.S. Formerly Berkeley Fellow of Owens College, Manchester, and Assistant Professor of Zoology at University College, London. Member of Council of Linnean Society.	Coelentera.
G. J.	GEORGE JAMIESON, C.M.G., M.A. Formerly Consul-General at Shanghai, and Consul and Judge of the Supreme Court, Shanghai.	China (in part).
G. J. T.	GEORGE JAMES TURNER. Barrister-at-Law, Lincoln's Inn. Editor of <i>Select Pleas of the Forests for the Selden Society; &c.</i>	Clarendon, Constitutions of.
G. L.	GEORG LUNGE, Ph.D., F.C.S. See the biographical article: LUNGE, GEORG.	Coal-Tar.
G. S. C.	SIR GEORGE SYDENHAM CLARKE, G.C.M.G., G.C.I.E., F.R.S. Governor of Bombay. Author of <i>Imperial Defence; Russia's Great Sea Power; The Last Great Naval War; &c.</i>	Coaling-Stations.
G. W. Kn.	REV. GEORGE WILLIAM KNOX, D.D., LL.D. Professor of Philosophy and History of Religion, Union Theological Seminary, New York. Author of <i>The Religion of Jesus; The Direct and Fundamental Proofs of the Christian Religion; &c.</i>	Christianity.
H. A. Gl.	HERBERT ALLEN GILES, M.A., LL.D. Professor of Chinese in the University of Cambridge. Member of the China Consular Service, 1867-1893. Author of a <i>Chinese-English Dictionary; A Chinese Biographical Dictionary; History of Chinese Literature.</i>	China: Language, Literature, Religion.
H. B.	HILARY BAUERMANN, F.G.S. (d. 1909). Formerly Lecturer on Metallurgy at the Ordnance College, Woolwich. Author of <i>A Treatise on the Metallurgy of Iron.</i>	Coal (in part); Coke.
H. C. H.	REV. HORACE CARTER HOVEY, A.M., D.D. Fellow of the American Association for the Advancement of Science, Geological Society of America, National Geographic Society and Société de Spéléologie (France). Author of <i>Celebrated American Caverns; Handbook of Mammoth Cave of Kentucky; &c.</i>	Colossal Cavern.
H. E. W.	HENRY EDWARD WATTS. Editor of the <i>Melbourne Argus</i> . Author of <i>Life of Cervantes</i> . Translator of <i>Don Quixote</i> .	Cid, The.
H. H. C.	SIR HENRY HARDINGE CUNYNGHAME, K.C.B., M.A. Assistant Under-Secretary, Home Office; Vice-President, Institute of Electrical Engineers. Author of various works on Enamelling, Electric Lighting, &c.	Clock.

- H. L. C.** HUGH LONGBOURNE CALLENDAR, LL.D., F.R.S.
Professor of Physics, Royal College of Science, London. Formerly Professor of Physics in McGill College, Montreal, and in University College, London. { Conduction of Heat.
- H. M. R.** HUGH MUNRO ROSS.
Formerly Exhibitioner of Lincoln College, Oxford. Editor of "The Times" Engineering Supplement. Author of *British Railways*. { Coal (in part).
- H. M. W.** HARRY MARSHALL WARD, F.R.S., D.Sc. (d. 1905).
Formerly Professor of Botany, Cambridge University. President of the British Mycological Society. Author of *Timber and some of its Diseases*; *The Oak*; *Diseases in Plants*; &c. { Cohn, Ferdinand Julius.
- H. M. Wo.** HAROLD MELLOR WOODCOCK, D.Sc.
Assistant to the Professor of Proto-Zoology, London University. Fellow of University College, London. Author of "Haemoflagellates" in Professor Ray Lankester's *Treatise of Zoology*, and of various scientific papers. { Coccidia.
- H. S. J.** HENRY STUART JONES, M.A.
Formerly Fellow of Trinity College, Oxford. Director of the British School at Rome, 1903-1905. Author of *The Roman Empire*; &c. { Constantine I.
- H. St.** HENRY STURT, M.A.
Author of *Idola Theatri*; *The Idea of a Free Church*; *Personal Idealism*; &c. { Condillac.
- H. S. Wl.** HENRY SMITH WILLIAMS, M.D., B.Sc.
Formerly Lecturer in the Hartford School of Sociology, U.S.A. Editor of *The Historians' History of the World*. Author of *The Story of Nineteenth Century Science*; *The History of the Art of Writing*; *The Lesson of Heredity*; &c. { Chronology (in part); Civilization.
- H. Wh.** HORACE WHITE, LL.D.
Formerly Editor of the *New York Evening Post*. Sometime Editor of *Chicago Tribune*. Author of *Money and Banking Illustrated by American History*; *The Tariff Question*; *The Gold Question*; *The Silver Question*; &c. { Cleveland, Grover.
- H. W. S.** H. WICKHAM STEED.
Correspondent of *The Times* at Rome, 1897-1902, and at Vienna. { Cialdini.
- H. Y.** SIR HENRY YULE, K.C.S.I., C.B.
See the biographical article: YULE, SIR HENRY. { China: History (in part).
- I. A.** ISRAEL ABRAHAMS, M.A.
Reader in Talmudic and Rabbinic Literature in the University of Cambridge. Formerly President of the Jewish Historical Society of England. Author of *A Short History of Jewish Literature*; *Jewish Life in the Middle Ages*; *Judaism*; &c. Edited *Jewish Quarterly Review*, 1888-1908. { Circumcision.
- J. A. Cl.** JOHN ALGERNON CLARKE.
Author of *Fen Sketches*; &c. { Conjuring (in part).
- J. A. F.** JOHN AMBROSE FLEMING, M.A., D.Sc., F.R.S., M.I.E.E.
Pender Professor of Electrical Engineering in the University of London. Fellow of University College, London. Formerly Fellow of St John's College, Cambridge, and Lecturer on Applied Mechanics in the University. Author of *Magnets and Electric Currents*. { Conduction, Electric.
- J. A. H.** JOHN ALLEN HOWE, B.Sc.
Curator and Librarian of the Museum of Practical Geology, London. { Clay-with-Flints.
- J. A. R.** VERY REV. JOSEPH ARMITAGE ROBINSON, D.D.
Dean of Westminster. Fellow of the British Academy. Hon. Fellow of Christ's College, Cambridge. Formerly Fellow of Christ's College, Cambridge, and Norrisian Professor of Divinity in the University. Author of *Some Thoughts on the Incarnation*; &c. { Clement I. (in part).
- J. C. Sc.** JOHN CHRISTOPHER SCHWAB, A.M., Ph.D.
Librarian, Yale University. Editor of *Yale Review*. Author of *The Confederate States of America*; *History of New York Property Tax*; &c. { Confederate States of America.
- J. D.** SIR JAMES DONALDSON.
See the biographical article: DONALDSON, SIR J. { Clement of Alexandria (in part).
- J. D. v. d. W.** JOHANNES DIDERIK VAN DER WAALS, Ph.D.
Professor of Physics at the University of Amsterdam. Author of *The Continuity of the Liquid and Gaseous States*. { Condensation of Gases.
- J. E. F.** REV. JAMES EVERETT FRAME, A.M. (Harvard).
Edward Robinson Professor of Biblical Theology in Union Theological Seminary, New York. Author of *Purpose of New Testament Theology*. { Colossians, Epistle to the.
- J. E. S.*** JOHN EDWIN SANDYS, M.A., Litt.D., LL.D.
Public Orator in the University of Cambridge. Fellow of St John's College, Cambridge. Fellow of the British Academy. Author of *History of Classical Scholarship*; &c. { Classics.
- J. H. R.** JOHN HORACE ROUND, LL.D. (Edin.).
Author of *Feudal England*; *Studies in Peerage and Family History*; *Peerage and Pedigree*; &c. { Clare: Family.
- J. J. T.** SIR JOSEPH JOHN THOMSON, M.A., D.Sc., F.R.S., LL.D., Ph.D.
Cavendish Professor of Experimental Physics, Cambridge. Professor of Physics, Royal Institution, London. Fellow of Trinity College, Cambridge. President of the British Association, 1909-1910. Awarded Nobel Prize for Physics, 1906. Author of *Conduction of Electricity through Gases*; *Recent Researches in Electricity and Magnetism*; *Application of Dynamics to Physics and Chemistry*; &c. { Conduction, Electric: Through Gases.

- J. Le.** REV. JAMES LEGGE.
See the biographical article: LEGGE, JAMES. { Confucius.
- J. L. M.** JOHN LINTON MYRES, M.A., F.S.A.
Wykeham Professor of Ancient History in the University of Oxford. Formerly Gladstone Professor of Greek and Lecturer in Ancient Geography, University of Liverpool. Lecturer in Classical Archaeology in University of Oxford. { Citium.
- J. Mo.** VISCOUNT MORLEY OF BLACKBURN.
See the biographical article: MORLEY, VISCOUNT. { Comte.
- J. M. M.** JOHN MALCOLM MITCHELL.
Formerly Scholar of Queen's College, Oxford. Lecturer on Classics at East London College (University of London). Joint-editor of Grote's *History of Greece*. { Cimon;
Cleisthenes;
Colchis.
- J. M. Ro.** JOHN MACKINNON ROBERTSON, M.P.
Author of *Montaigne and Shakespeare*; *Modern Humanists*; *Buckle and his Critics*; &c. M.P., Tyneside Division of Northumberland. { Coleridge, Samuel Taylor.
- J. N. M.** JOHN NEVIL MASKELYNE.
Author of *Modern Spiritualism*; *Sharps and Flats*; &c. { Conjuring (in part).
- J. P.-B.** JAMES GEORGE JOSEPH PENDEREL-BRODHURST.
Editor of the *Guardian*, London. { Chippendale;
Clock (in part).
- J. P. E.** JEAN PAUL HIPPOLYTE EMMANUEL ADHÉMAR ESMEIN.
Professor of Law in the University of Paris. Officer of the Legion of Honour. Member of the Institute of France. Author of *Cours élémentaire d'histoire du droit français*; &c. { Châtelet;
Code Napoléon.
- J. R. C.** JOSEPH ROGERSON COTTER, M.A.
Assistant to the Professor of Physics, Trinity College, Dublin. Editor of 2nd edition of Preston's *Theory of Heat*. { Colour.
- J. S. F.** JOHN SMITH FLETT, D.Sc., F.G.S.
Petrographer to the Geological Survey. Formerly Lecturer on Petrology in Edinburgh University. Neill Medallist of the Royal Society of Edinburgh. Bigsby Medallist of the Geological Society of London. { Clay;
Concretion;
Conglomerate.
- J. S. K.** JOHN SCOTT KELTIE, LL.D., F.S.S., F.S.A. (Scot.).
Secretary, Royal Geographical Society. Knight of Swedish Order of North Star. Commander of the Norwegian Order of St Olaf. Hon. Member, Geographical Societies of Paris, Berlin, Rome, &c. Editor of *Statesman's Year Book*. Editor of the *Geographical Journal*. { Congo Free State (in part).
- J. T. C.** JOSEPH THOMAS CUNNINGHAM, M.A., F.Z.S.
Lecturer on Zoology at South-Western Polytechnic, London. Formerly Fellow of University College, Oxford, and Assistant Professor of Natural History in the University of Edinburgh. Naturalist to the Marine Biological Association. { Chiton;
Cockle.
- J. T. S.*** JAMES THOMSON SHOTWELL, Ph.D.
Professor of History in Columbia University, New York City. { Colbert, Jean Baptiste.
- J. V. B.** JAMES VERNON BARTLET, M.A., D.D. (St Andrews).
Professor of Church History, Mansfield College, Oxford. Author of *The Apostolic Age*; &c. { Clementine Literature;
Congregationalism.
- K. S.** KATHLEEN SCHLESINGER.
Author of *The Instruments of the Orchestra*. { Chelys; Cheng; Chorus;
Cithara; Cittern; Clarina;
Clarinet; Clavichord;
Clavicytherium; Concertina.
- L. B.** LAURENCE BINYON.
See the biographical article: BINYON, L. { China: Chinese Art.
- L. D.*** LOUIS DUCHESNE.
See the biographical article: DUCHESNE, L. M. O. { Clement II.
- L. Gi.** LIONEL GILES, M.A.
Assistant, Oriental Department, British Museum. Author of *Sun Tzu on the Art of War*. { China: Language (in part).
- L. J. S.** LEONARD JAMES SPENCER, M.A.
Assistant, Department of Mineralogy, British Museum. Formerly Scholar of Sidney Sussex College, Cambridge, and Harkness Scholar. Editor of the *Mineralogical Magazine*. { Childrenite; Chlorite;
Chromite; Chrysocolla;
Clintonite; Cobaltite;
Colemanite; Columbite.
- L. V.*** LUIGI VILLARI.
Italian Foreign Office (Emigration Department). Formerly Newspaper Correspondent in East of Europe. Italian Vice-Consul in New Orleans, 1906; Philadelphia, 1907; and Boston, U.S.A., 1907-1910. Author of *Italian Life in Town and Country*; &c. { Cibrario; Colleoni;
Colletta; Colonna: Family;
Colonna, Vittoria;
Confalonieri.
- M. E. S.** MICHAEL ERNEST SADLER, M.A., LL.D.
Professor of the History and Administration of Education in the University of Manchester. Formerly Director of Special Enquiries and Reports to the Board of Education. Student and Steward of Christ Church, Oxford. Editor of *Continuation Schools in England and elsewhere*; *Moral Instruction and Training in Schools*; &c. { Co-education.

- M. G. D.** RT. HON. SIR MOUNTSTUART ELPHINSTONE GRANT-DUFF, G.C.S.I., F.R.S. (1829-1906).
M.P. for the Elgin Burghs, 1857-1881. Under-Secretary of State for India, 1868-1874. Under-Secretary of State for the Colonies, 1880-1881. Governor of Madras, 1881-1886. President of the Royal Geographical Society, 1889-1893. President of the Royal Historical Society, 1892-1899. Author of *Studies in European Politics*; *Notes from a Diary*; &c. } Coleridge, J. D. C., 1st Baron.
- M. N. T.** MARCUS NIEBUHR TOD, M.A.
Fellow and Tutor of Oriel College, Oxford. University Lecturer in Epigraphy. Joint-author of *Catalogue of the Sparta Museum*. } Cleomenes.
- M. O. B. C.** MAX OTTO BISMARCK CASPARI, M.A.
Reader in Ancient History at London University. Lecturer in Greek at Birmingham University, 1905-1908. } Chios (in part).
- N. V.** JOSEPH MARIE NOEL VALOIS.
Member of Académie des Inscriptions et Belles-Lettres, Paris. Honorary Archivist at the Archives Nationales. Formerly President of the Société de l'Histoire de France and the Société de l'École de Chartes. Author of *La France et le grand schisme d'Occident*; &c. } Clement VII.: antipope.
Constance, Council of.
- N. W. T.** NORTHCOTE WHITBRIDGE THOMAS, M.A.
Government Anthropologist to Southern Nigeria. Corresponding Member of the Société d'Anthropologie de Paris. Author of *Thought Transference*; *Kinship and Marriage in Australia*; &c. } Clairvoyance.
- O. Ba.** OSWALD BARRON, F.S.A.
Editor of the *Ancestor*, 1902-1905. Hon. Genealogist to Standing Council of the Honourable Society of the Baronetage. } Collar.
- O. J. R. H.** OSBERT JOHN RADCLIFFE HOWARTH, M.A.
Christ Church, Oxford. Geographical Scholar, 1901. Assistant Secretary of the British Association. } Coal (in part).
- O. M.*** OCTAVE MAUS, LL.D. (Brussels).
Advocate of the Court of Appeal at Brussels. Director of *L'Art Moderne* and of *La Libre Esthétique*. President of the Association of Belgian writers. Officer of the Legion of Honour. Author of *Le Théâtre de Bayreuth*; *Aux Ambassadeurs*; *Malta, Constantinople et la Crimée*; &c. } Clays, Paul Jean.
- P. A. M.** PERCY ALEXANDER MACMAHON, D.Sc., F.R.S.
Late Major, R.A. Deputy Warden of the Standards, Board of Trade. Joint General Secretary of the British Association. Formerly Professor of Physics, Ordnance College. President of London Mathematical Society, 1894-1896. } Combinatorial Analysis.
- P. C. Y.** PHILIP CHESNEY YORKE, M.A.
Magdalen College, Oxford. } Clanricarde, 1st Earl of;
Clanricarde, Marquess of;
Clarendon, 1st Earl of;
Clifford of Chudleigh;
Colepeper.
- P. La.** PHILIP LAKE, M.A., F.G.S.
Lecturer on Physical and Regional Geography in Cambridge University. Formerly of the Geological Survey of India. Author of *Monograph of British Cambrian Trilobites*. Translator and Editor of Kayser's *Comparative Geology*. } China: Geology.
- R. de C. W.** ROBERT DE COURCY WARD, A.M. (Harvard).
Assistant Professor of Climatology in the University of Harvard. Fellow of Royal Meteorological Society, London. Sometime Editor of *American Meteorological Journal*. Author of *Climate considered especially in Relation to Man*; &c. } Climate and Climatology.
- R. H.*** SIR ROBERT HUNTER, C.B., M.A.
Solicitor to the Post Office. Author of *The Preservation of Open Spaces and of Footpaths and other Rights of Way*; &c. } Commons.
- R. J. M.** RONALD JOHN MCNEILL, M.A.
Christ Church, Oxford. Barrister-at-Law. Formerly Editor of the *St James's Gazette*, London. } Chichester of Belfast;
Clare, 1st Earl of.
- R. K. D.** SIR ROBERT KENNAWAY DOUGLAS.
Formerly Professor of Chinese, King's College, London. Keeper of Oriental Printed Books and MSS. at British Museum, 1892-1907. Member of the Chinese Consular Service, 1858-1865. Author of *The Language and Literature of China*; *China; Europe and the Far East*; &c. } China: History (in part).
- R. L.*** RICHARD LYDEKKER, F.R.S., F.G.S., F.Z.S.
Member of the Staff of the Geological Survey of India, 1874-1882. Author of *Catalogues of Fossil Mammals, Reptiles and Birds in British Museum*; *The Deer of all Lands*; &c. } Chevrotain; Chimpanzee;
China: Fauna;
Chiroptera; Chiru;
Clouded Leopard.
- R. N. B.** ROBERT NISBET BAIN (d. 1909).
Formerly Assistant Librarian, British Museum. Author of *Scandinavia: the Political History of Denmark, Norway and Sweden, 1513-1900*; *The First Romanovs, 1613 to 1725*; *Slavonic Europe: the Political History of Poland and Russia from 1469 to 1796*; &c. } Chmielnicki;
Chodkiewicz;
Christian II., III., IV.;
Christina of Sweden.
- R. P. S.** R. PHENÉ SPIERS, F.S.A., F.R.I.B.A.
Formerly Master of Architectural School and Surveyor, Royal Academy, London. Past President of Architectural Association. Associate and Fellow of King's College, London. Corresponding Member of the Institute of France. Editor of *Fergusson's History of Architecture*. Author of *Architecture: East and West*; &c. } Chimney (in part);
Chimney-piece;
Choir;
Column.

- S. A. C.** STANLEY ARTHUR COOK, M.A.
Editor for Palestine Exploration Fund. Lecturer in Hebrew and Syriac, and formerly Fellow, Gonville and Caius College, Cambridge. Examiner in Hebrew and Aramaic, London University, 1904-1908. Author of *Glossary of Aramaic Inscriptions; The Laws of Moses and Code of Hammurabi; Critical Notes on Old Testament History; Religion of Ancient Palestine; &c.*
- S. J. L.** SIDNEY JAMES LOW, M.A.
Fellow of King's College, London. Barrister-at-Law, Inner Temple. Formerly Editor of the *St James's Gazette*. Joint-editor of the *Dictionary of English History*. Author of *The Governance of England*. Joint-author of vol. xii. of Longman's *Political History of England, 1837-1901*.
- S. N.** SIMON NEWCOMB, D.Sc., D.C.L.
See the biographical article: NEWCOMB, SIMON.
- S. P. T.** SILVANUS PHILLIPS THOMPSON, M.D., D.Sc., F.R.S.
Principal and Professor of Physics in the City and Guilds Technical College, Finsbury. Formerly President of Physical Society, of Institution of Electrical Engineers, and of Röntgen Society. Author of *Lectures on Light; Michael Faraday; &c.*
- T. A. I.** THOMAS ALLAN INGRAM, M.A., LL.D.
Trinity College, Dublin.
- T. As.** THOMAS ASHBY, M.A., D.LITT. (Oxon.), F.S.A.
Formerly Scholar of Christ Church, Oxford. Director of British School of Archaeology at Rome. Member of the German Imperial Archaeological Institute. Craven Fellow, Oxford, 1897.
- T. Ba.** SIR THOMAS BARCLAY, M.P.
Member of the Institute of International Law. Member of the Supreme Council of the Congo Free State. Officer of the Legion of Honour. Author of *Problems of International Practice and Diplomacy; &c.* M.P. for Blackburn, 1910.
- T. F. C.** DR THEODORE FRELINGHUYSEN COLLIER, PH.D.
Assistant Professor of History, Williams College, Williamstown, Mass., U.S.A.
- T. G. Br.** THOMAS GREGOR BRODIE, M.D., F.R.S.
Professor of Physiology in the University of Toronto. Author of *Essentials of Experimental Physiology*.
- T. H. H.*** COL. SIR THOMAS HUNGERFORD HOLDICH, K.C.M.G., K.C.I.E., D.Sc.
Superintendent Frontier Surveys, India, 1892-1898. Gold Medallist, R.G.S., London, 1887. Author of *The Indian Borderland; The Countries of the King's Award; India; Tibet; &c.*
- T. K. C.** REV. THOMAS KELLY CHEYNE, D.D., D.LITT.
See the biographical article: CHEYNE, T. K.
- T. Mu.** THOMAS MUIR, C.M.G., M.A., LL.D., F.R.S., F.R.S. (Edin.).
Superintendent-General of Education in Cape Colony. Formerly Assistant Professor of Mathematics in the University of Glasgow. Vice-Chancellor of the University of the Cape of Good Hope till 1901. Author of *Theory of Determinants in the Historical Order of Development; History of Determinants; Text-Book of Determinants; &c.*
- T. Se.** THOMAS SECCOMBE, M.A.
Balliol College, Oxford. Lecturer in History, East London and Birkbeck Colleges, University of London. Assistant Editor, *Dictionary of National Biography*, 1891-1900. Author of *The Age of Johnson; &c.*
- V. C.** VALENTINE CHIROL.
Director of the Foreign Department of *The Times*. Author of *The Middle Eastern Question; The Far Eastern Question; &c.*
- W. A. B. C.** REV. WILLIAM AUGUSTUS BREVOORT COOLIDGE, M.A., F.R.G.S., D.Ph. (Bern).
Fellow of Magdalen College, Oxford. Professor of English History, St David's College, Lampeter, 1880-1881. Author of *Guide du Haut Dauphiné; The Range of the Todi; Guide to Grindelwald; Guide to Switzerland; The Alps in Nature and in History; &c.* Editor of the *Alpine Journal*, 1880-1889, &c.
- W. A. P.** WALTER ALISON PHILLIPS, M.A.
Formerly Exhibitioner of Merton College and Senior Scholar of St John's College, Oxford. Author of *Modern Europe; The War of Greek Independence; &c.*
- W. B. B.** W. BAKER BROWN.
Lieut.-Col., Commanding Royal Engineers at Malta.
- W. C. D. W.** WILLIAM CECIL DAMPIER WHETHAM, M.A., F.R.S.
Fellow and Tutor of Trinity College, Cambridge. Author of *Theory of Solution; Recent Development of Physical Science; &c.*
- W. F. C.** WILLIAM FEILDEN CRAIES, M.A.
New College, Oxford. Barrister-at-Law, Inner Temple. Lecturer on Criminal Law, King's College, London. Author of *Craies on Statute Law*. Editor of Archbold's *Criminal Pleading* (23rd edition).
- W. G. F.** WILLIAM GEORGE FREEMAN, B.Sc. (London), A.R.C.S.
Joint-author of *Nature Teaching; The World's Commercial Products*. Joint-editor of *Science Progress in the Twentieth Century*.
- Chronicles, Books of
(in part).
- Churchill, Lord Randolph.
- Comet.
- Compass (in part).
- Child, Sir Josiah; Children,
Law Relating to (in part);
Chiltern Hundreds; Clearing
House; Confession: Law.
- Chioggia (in part);
Circeius Mons; Clodia, Via;
Clusium; Collatia; Como;
Concordia.
- Conquest.
- Clement VIII.-XIV.
- Connective Tissues.
- Chitral.
- Cherubim.
- Circle (in part).
- Chénier, André de.
- China: History (in part).
- Chaux de Fonds, La;
Coire; Como, Lake of;
Constance;
Constance, Lake of.
- Chimere; Choir;
Church History (in part);
Clement VII.;
Confessional; Congress;
Constable.
- Coast Defence.
- Conduction, Electric;
in Liquids.
- Children, Law relating to
(in part).
- Cocoa;
Coffee.

W. K. S.	WILLIAM KIRBY SULLIVAN, PH.D., D.Sc. President of Queen's College, Cork, 1873-1890. Author of <i>Celtic Studies</i> ; &c.	{ Clan.
W. L. R. C.	WILLIAM LIEST READWIN CATES (1821-1895). Editor of <i>Dictionary of General Biography</i> . Author of <i>A History of England from the Death of Edward the Confessor to the Death of King John</i> ; &c. Part author of <i>Encyclopaedia of Chronology</i> .	{ Chronology (<i>in part</i>).
W. M. R.	WILLIAM MICHAEL ROSSETTI. See the biographical article: ROSSETTI, D. G.	{ Cimabue; Claude of Lorraine.
W. N.	WALTER NERNST, PH.D. Professor of Physical Chemistry in the University of Berlin. Director of the Physico-Chemical Institute in the University. Member of the Royal Prussian Academy of Science. Author of <i>Theoretische Chemie</i> ; &c.	{ Chemical Action.
W. O. B.	VEN. WINFRID OLDFIELD BURROWS, M.A. Archdeacon of Birmingham. Tutor of Christ Church, Oxford, 1884-1891, and Principal of Leeds Clergy School, 1891-1900.	{ Confession: <i>Religion</i> ; Confirmation.
W. R. S.*	WILLIAM ROY SMITH, M.A., PH.D. Associate Professor of History, Bryn Mawr College, Pennsylvania. Author of <i>Sectionalism in Pennsylvania during the Revolution</i> ; &c.	{ Compromise Measures of 1850.
W. R. S.	WILLIAM ROBERTSON SMITH, LL.D. See the biographical article: SMITH, W. R.	{ Chronicles, Books of (<i>in part</i>).
W. W. F.*	WILLIAM WARDE FOWLER, M.A. Fellow of Lincoln College, Oxford. Sub-Rector, 1881-1904. Gifford Lecturer, Edinburgh University, 1908. Author of <i>The City-State of the Greeks and Romans</i> ; <i>The Roman Festivals of the Republican Period</i> ; &c.	{ Club: <i>Greek and Roman</i> .
W. W. R.*	WILLIAM WALKER ROCKWELL, LIC.THEOL. Assistant Professor of Church History, Union Theological Seminary, New York. Author of <i>Die Doppelhe des Landgrafen Philipp von Hessen</i> .	{ Clement III., IV., V.

 PRINCIPAL UNSIGNED ARTICLES

Chatham, Earl of.
Chatterji.
Chatterton.
Cheering.
Chess.
Chicago.
Child.
Chilean Civil War.
Chile-Peruvian War.
Chillingworth.
Chino-Japanese War.
Chlorine.
Cholera.

Chopin.
Christian Science.
Chrysanthemum.
Chrysostom.
Churchill, Charles.
Gibber.
Cinque Ports.
Civil List.
Civil Service.
Clausewitz.
Clayton-Bulwer Treaty.
Clemenceau.

Clive, Lord.
Club-foot.
Cnossus.
Cobbett.
Cobden.
Cock-fighting.
Coco-nut Palm.
Code.
Coke, Sir Edward.
Collier, Jeremy.
Colony.
Colorado.

Colours, Military.
Commerce.
Common Order, Book of.
Communism.
Compositae.
Condorcet.
Condottiere.
Confirmation of Bishops.
Congreve, Sir William.
Conic Section.
Connecticut.
Conservative Party.

ENCYCLOPÆDIA BRITANNICA

ELEVENTH EDITION

VOLUME VI

CHÂTELET (from Med. Lat. *castella*), the word, sometimes also written *castillet*, used in France for a building designed for the defence of an outwork or gate, sometimes of great strength or size, but distinguished from the *château*, or castle proper, in being purely defensive and not residential. In Paris, before the Revolution, this word was applied both to a particular building and to the jurisdiction of which it was the seat. This building, the original Châtelet, had been first a castle defending the approach to the Cité. Tradition traced its existence back to Roman times, and in the 18th century one of the rooms in the great tower was still called the *chambre de César*. The jurisdiction was that of the provostship (*prévôté*) and viscountship of Paris, which was certainly of feudal origin, probably going back to the counts of Paris.

It was not till the time of Saint Louis that, with the appointment of Étienne Boileau, the provostship of Paris became a *prévôté en garde*, i.e. a public office no longer put up to sale. When the *baillis* (see BAILIFF AND BAILIE) were created, the provost of Paris naturally discharged the duties and functions of a *bailli*, in which capacity he heard appeals from the seigniorial and inferior judges of the city and its neighbourhood, keeping, however, his title of provost. When under Henry II. certain *bailliages* became presidial jurisdictions (*présidiaux*), i.e. received to a certain extent the right of judging without appeal, the Châtelet, the court of the provost of Paris, was made a presidial court, but without losing its former name. Finally, various tribunals peculiar to the city of Paris, i.e. courts exercising jurisdictions outside the common law or corresponding to certain *cours d'exception* which existed in the provinces, were united with the Châtelet, of which they became divisions (*chambres*). Thus the lieutenant-general of police made it the seat of his jurisdiction, and the provost of the Île de France, who had the same criminal jurisdiction as the provosts of the marshals of France in other provinces, sat there also. As to the *personnel* of the Châtelet, it was originally the same as in the *bailliages*, except that after the 14th century it had some special officials, the auditors and the examiners of inquests. Like the *baillis*, the provost had lieutenants who were deputies for him, and in addition gradually acquired a considerable body of *ex officio* councillors. This last staff, however, was not yet in existence at the end of the 14th century, for it is not mentioned in the *Registre criminel du Châtelet* (1389-1392), published by the Société des Bibliophiles Français. In 1674 the whole *personnel* was doubled, at the time when the new Châtelet was established side by side with the old, the two being soon after amalgamated. On the eve of the Revolution it comprised, beside the provost whose office had become practically honorary, the *lieutenant civil*, who presided over the *chambre de prévôté au parc civil* or court of first instance; the *lieutenant criminel*, who presided over the criminal

court; two *lieutenants particuliers*, who presided in turn over the *chambre du présidial* or court of appeal from the inferior jurisdictions, a *juge auditeur*; sixty-four councillors (*conseillers*); the *procureur du roi*, four *avocats du roi*, and eight *substituts*, i.e. deputies of the *procureur* (see PROCURATOR), beside a host of minor officials. The history of the Châtelet under the Revolution may be briefly told: the Constituent Assembly empowered it to try cases of *lèse-nation*, and it was also before this court that was opened the inquiry following on the events of the 5th and 6th of August 1789. It was suppressed by the law of the 16th of August 1790, together with the other tribunals of the *ancien régime*. (J. P. E.)

CHÂTELLERAULT, a town of western France, capital of an arrondissement in the department of Vienne, 19 m. N.N.E. of Poitiers on the Orleans railway between that town and Tours. Pop. (1906) 15,214. Châtellerault is situated on the right and eastern bank of the Vienne; it is connected with the suburb of Châteauneuf on the opposite side of the river by a stone bridge of the 16th and 17th centuries, guarded at the western extremity by massive towers. The manufacture of cutlery is carried on on a large scale in villages on the banks of the Clain, south of the town. Of the other industrial establishments the most important is the national small-arms factory, which was established in 1815 in Châteauneuf, and employs from 1500 to 5500 men. Châtellerault (or Châtelherault: *Castellum Aivaldi*) derives its name from a fortress built in the 10th century by Airaud, viscount of its territory. In 1515 it was made a duchy in favour of François de Bourbon, but it was not long after this date that it became reunited to the crown. In 1548 it was bestowed on James Hamilton, 2nd earl of Arran (see HAMILTON).

CHATHAM, WILLIAM PITT, 1ST EARL OF (1708-1778), English statesman, was born at Westminster on the 15th of November 1708. He was the younger son of Robert Pitt of Boconnoc, Cornwall, and grandson of Thomas Pitt (1653-1726), governor of Madras, who was known as "Diamond" Pitt, from the fact of his having sold a diamond of extraordinary size to the regent Orleans for something like £135,000. It was mainly by this fortunate transaction that the governor was enabled to raise his family, which was one of old standing, to a position of wealth and political influence. The latter he acquired by purchasing the burgate tenures of Old Sarum.

William Pitt was educated at Eton, and in January 1727 was entered as a gentleman commoner at Trinity College, Oxford. There is evidence that he was an extensively read, if not a minutely accurate classical scholar; and it is interesting to know that Demosthenes was his favourite author, and that he diligently cultivated the faculty of expression by the practice of translation and re-translation. An hereditary gout, from which

he had suffered even during his school-days, compelled him to leave the university without taking his degree, in order to travel abroad. He spent some time in France and Italy, but the disease proved intractable, and he continued subject to attacks of growing intensity at frequent intervals till the close of his life. In 1727 his father had died, and on his return home it was necessary for him, as the younger son, to choose a profession. Having chosen the army, he obtained through the interest of his friends a cornet's commission in the dragoons. But his military career was destined to be short. His elder brother Thomas having been returned at the general election of 1734 both for Oakhampton and for Old Sarum, and having preferred to sit for the former, the family borough fell to the younger brother by the sort of natural right usually recognized in such cases. Accordingly, in February 1735, William Pitt entered parliament as member for Old Sarum. Attaching himself at once to the formidable band of discontented Whigs known as the Patriots, whom Walpole's love of exclusive power had forced into opposition under Pulteney, he became in a very short time one of its most prominent members. His maiden speech was delivered in April 1736, in the debate on the congratulatory address to the king on the marriage of the prince of Wales. The occasion was one of compliment, and there is nothing striking in the speech as reported; but it served to gain for him the attention of the house when he presented himself, as he soon afterwards did, in debates of a party character. So obnoxious did he become as a critic of the government, that Walpole thought fit to punish him by procuring his dismissal from the army. Some years later he had occasion vigorously to denounce the system of cashiering officers for political differences, but with characteristic loftiness of spirit he disdained to make any reference to his own case. The loss of his commission was soon made up to him. The heir to the throne, as was usually the case in the house of Hanover, if not in reigning families generally, was the patron of the opposition, and the ex-cornet became groom of the bed-chamber to the prince of Wales. In this new position his hostility to the government did not, as may be supposed, in any degree relax. He had all the natural gifts an orator could desire—a commanding presence, a graceful though somewhat theatrical bearing, an eye of piercing brightness, and a voice of the utmost flexibility. His style, if occasionally somewhat turgid, was elevated and passionate, and it always bore the impress of that intensity of conviction which is the most powerful instrument a speaker can have to sway the convictions of an audience. It was natural, therefore, that in the series of stormy debates, protracted through several years, that ended in the downfall of Walpole, his eloquence should have been one of the strongest of the forces that combined to bring about the final result. Specially effective, according to contemporary testimony, were his speeches against the Hanoverian subsidies, against the Spanish convention in 1739, and in favour of the motion in 1742 for an investigation into the last ten years of Walpole's administration. It must be borne in mind that the reports of these speeches which have come down to us were made from hearsay, or at best from recollection, and are necessarily therefore most imperfect. The best-known specimen of Pitt's eloquence, his reply to the sneers of Horatio Walpole at his youth and declamatory manner, which has found a place in so many handbooks of elocution, is evidently, in form at least, the work, not of Pitt, but of Dr Johnson, who furnished the report to the *Gentleman's Magazine*. Probably Pitt did say something of the kind attributed to him, though even this is by no means certain in view of Johnson's repentant admission that he had often invented not merely the form, but the substance of entire debates.

In 1742 Walpole was at last forced to succumb to the long-continued attacks of opposition, and was succeeded as prime minister by the earl of Wilmington, though the real power in the new government was divided between Carteret and the Pelhams. Pitt's conduct on the change of administration was open to grave censure. The relentless vindictiveness with which he insisted on the prosecution of Walpole, and supported the bill of indemnity to witnesses against the fallen minister, was in itself not magnanimous; but it appears positively un-

worthy when it is known that a short time before Pitt had offered, on certain conditions, to use all his influence in the other direction. Possibly he was embittered at the time by the fact that, owing to the strong personal dislike of the king, caused chiefly by the contemptuous tone in which he had spoken of Hanover, he did not by obtaining a place in the new ministry reap the fruits of the victory to which he had so largely contributed. The so-called "broad-bottom" administration formed by the Pelhams in 1744, after the dismissal of Carteret, though it included several of those with whom he had been accustomed to act, did not at first include Pitt himself even in a subordinate office. Before the obstacle to his admission was overcome, he had received a remarkable accession to his private fortune. The eccentric duchess of Marlborough, dying in 1744, at the age of ninety, left him a legacy of £10,000 as an "acknowledgment of the noble defence he had made for the support of the laws of England and to prevent the ruin of his country." As her hatred was known to be at least as strong as her love, the legacy was probably as much a mark of her detestation of Walpole as of her admiration of Pitt. It may be mentioned here, though it does not come in chronological order, that Pitt was a second time the object of a form of acknowledgment of public virtue which few statesmen have had the fortune to receive even once. About twenty years after the Marlborough legacy, Sir William Pynsent, a Somersetshire baronet to whom he was personally quite unknown, left him his entire estate, worth about three thousand a year, in testimony of approval of his political career.

It was with no very good grace that the king at length consented to give Pitt a place in the government, although the latter did all he could to ingratiate himself at court, by changing his tone on the questions on which he had made himself offensive. To force the matter, the Pelhams had to resign expressly on the question whether he should be admitted or not, and it was only after all other arrangements had proved impracticable, that they were reinstated with the obnoxious politician as vice-treasurer of Ireland. This was in February 1746. In May of the same year he was promoted to the more important and lucrative office of paymaster-general, which gave him a place in the privy council, though not in the cabinet. Here he had an opportunity of displaying his public spirit and integrity in a way that deeply impressed both the king and the country. It had been the usual practice of previous paymasters to appropriate to themselves the interest of all money lying in their hands by way of advance, and also to accept a commission of $\frac{1}{2}\%$ on all foreign subsidies. Although there was no strong public sentiment against the practice, Pitt altogether refused to profit by it. All advances were lodged by him in the Bank of England until required, and all subsidies were paid over without deduction, even though it was pressed upon him, so that he did not draw a shilling from his office beyond the salary legally attaching to it. Conduct like this, though obviously disinterested, did not go without immediate and ample reward, in the public confidence which it created, and which formed the mainspring of Pitt's power as a statesman.

The administration formed in 1746 lasted without material change till 1754. It would appear from his published correspondence that Pitt had a greater influence in shaping its policy than his comparatively subordinate position would in itself have entitled him to. His conduct in supporting measures, such as the Spanish treaty and the continental subsidies, which he had violently denounced when in opposition, had been much criticized; but within certain limits, not indeed very well defined, inconsistency has never been counted a vice in an English statesman. The times change, and he is not blamed for changing with the times. Pitt in office, looking back on the commencement of his public life, might have used the plea "A good deal has happened since then," at least as justly as some others have done. Allowance must always be made for the restraints and responsibilities of office. In Pitt's case, too, it is to be borne in mind that the opposition with which he had acted gradually dwindled away, and that it ceased to have any organized existence after the death of the prince of Wales in 1751. Then in regard to the important question with Spain as to the right of search,

Pitt has disarmed criticism by acknowledging that the course he followed during Wapole's administration was indefensible. All due weight being given to these various considerations, it must be admitted, nevertheless, that Pitt did overstep the limits within which inconsistency is usually regarded as venial. His one great object was first to gain office, and then to make his tenure of office secure by conciliating the favour of the king. The entire revolution which much of his policy underwent in order to effect this object bears too close a resemblance to the sudden and inexplicable changes of front habitual to placemen of the Tadpole stamp to be altogether pleasant to contemplate in a politician of pure aims and lofty ambition. Humiliating is not too strong a term to apply to a letter in which he expresses his desire to "efface the past by every action of his life," in order that he may stand well with the king.

In 1754 Henry Pelham died, and was succeeded at the head of affairs by his brother, the duke of Newcastle. To Pitt the change brought no advancement, and he had thus an opportunity of testing the truth of the description of his chief given by Sir Robert Walpole, "His name is treason." But there was for a time no open breach. Pitt continued at his post; and at the general election which took place during the year he even accepted a nomination for the duke's pocket borough of Aldborough. He had sat for Seaford since 1747. When parliament met, however, he was not long in showing the state of his feelings. Ignoring Sir Thomas Robinson, the political nobody to whom Newcastle had entrusted the management of the Commons, he made frequent and vehement attacks on Newcastle himself, though still continuing to serve under him. In this strange state matters continued for about a year. At length, just after the meeting of parliament in November 1751, Pitt was dismissed from office, having on the debate on the address spoken at great length against a new system of continental subsidies, proposed by the government of which he was a member. Fox, who had just before been appointed secretary of state, retained his place, and though the two men continued to be of the same party, and afterwards served again in the same government, there was henceforward a rivalry between them, which makes the celebrated opposition of their illustrious sons seem like an inherited quarrel.

Another year had scarcely passed when Pitt was again in power. The inherent weakness of the government, the vigour and eloquence of his opposition, and a series of military disasters abroad combined to rouse a public feeling of indignation which could not be withstood, and in December 1756 Pitt, who now sat for Okehampton, became secretary of state, and leader of the Commons under the premiership of the duke of Devonshire. He had made it a condition of his joining any administration that Newcastle should be excluded from it, thus showing a resentment which, though natural enough, proved fatal to the lengthened existence of his government. With the king unfriendly, and Newcastle, whose corrupt influence was still dominant in the Commons, estranged, it was impossible to carry on a government by the aid of public opinion alone, however emphatically that might have declared itself on his side. In April 1757, accordingly, he found himself again dismissed from office on account of his opposition to the king's favourite continental policy. But the power that was insufficient to keep him in office was strong enough to make any arrangement that excluded him impracticable. The public voice spoke in a way that was not to be mistaken. Probably no English minister ever received in so short a time so many proofs of the confidence and admiration of the public, the capital and all the chief towns voting him addresses and the freedom of their corporations. From the political deadlock that ensued relief could only be had by an arrangement between Newcastle and Pitt. After some weeks' negotiation, in the course of which the firmness and moderation of "the Great Commoner," as he had come to be called, contrasted favourably with the characteristic tortuosities of the crafty peer, matters were settled on such a basis that, while Newcastle was the nominal, Pitt was the virtual head of the government. On his acceptance of office he was chosen member for Bath.

This celebrated administration was formed in June 1757, and continued in power till 1761. During the four years of its existence it has been usual to say that the biography of Pitt is the history of England, so thoroughly was he identified with the great events which make this period, in so far as the external relations of the country are concerned, one of the most glorious in her annals. A detailed account of these events belongs to history; all that is needed in a biography is to point out the extent to which Pitt's personal influence may really be traced in them. It is scarcely too much to say that, in the general opinion of his contemporaries, the whole glory of these years was due to his single genius; his alone was the mind that planned, and his the spirit that animated the brilliant achievements of the British arms in all the four quarters of the globe. Posterity, indeed, has been able to recognize more fully the independent genius of those who carried out his purposes. The heroism of Wolfe would have been irrepressible, Clive would have proved himself "a heaven-born general," and Frederick the Great would have written his name in history as one of the most skilful strategists the world has known, whoever had held the seals of office in England. But Pitt's relation to all three was such as to entitle him to a large share in the credit of their deeds. It was his discernment that selected Wolfe to lead the attack on Quebec, and gave him the opportunity of dying a victor on the heights of Abraham. He had personally less to do with the successes in India than with the other great enterprises that shed an undying lustre on his administration; but his generous praise in parliament stimulated the genius of Clive, and the forces that acted at the close of the struggle were animated by his indomitable spirit. Pitt, the first real Imperialist in modern English history, was the directing mind in the expansion of his country, and with him the beginning of empire is rightly associated. The Seven Years' War might well, moreover, have been another Thirty Years' War if Pitt had not furnished Frederick with an annual subsidy of £700,000, and in addition relieved him of the task of defending western Germany against France.

Contemporary opinion was, of course, incompetent to estimate the permanent results gained for the country by the brilliant foreign policy of Pitt. It has long been generally agreed that by several of his most costly expeditions nothing was really won but glory. It has even been said that the only permanent acquisition that England owed directly to him was her Canadian dominion; and, strictly speaking, this is true, it being admitted that the campaign by which the Indian empire was virtually won was not planned by him, though brought to a successful issue during his ministry. But material aggrandizement, though the only tangible, is not the only real or lasting effect of a war policy. More may be gained by crushing a formidable rival than by conquering a province. The loss of her Canadian possessions was only one of a series of disasters suffered by France, which radically affected the future of Europe and the world. Deprived of her most valuable colonies both in the East and in the West, and thoroughly defeated on the continent, her humiliation was the beginning of a new epoch in history. The victorious policy of Pitt destroyed the military prestige which repeated experience has shown to be in France as in no other country the very life of monarchy, and thus was not the least considerable of the many influences that slowly brought about the French Revolution. It effectually deprived her of the lead in the councils of Europe which she had hitherto arrogated to herself, and so affected the whole course of continental politics. It is such far-reaching results as these, and not the mere acquisition of a single colony, however valuable, that constitute Pitt's claim to be considered as on the whole the most powerful minister that ever guided the foreign policy of England.

The first and most important of a series of changes which ultimately led to the dissolution of the ministry was the death of George II on the 25th of October 1760, and the accession of his grandson, George III. The new king had, as was natural, new counsellors of his own, the chief of whom, Lord Bute, was at once admitted to the cabinet as a secretary of state. Between Bute and Pitt there speedily arose an occasion of serious difference.

The existence of the so-called family compact by which the Bourbons of France and Spain bound themselves in an offensive alliance against England having been brought to light, Pitt urged that it should be met by an immediate declaration of war with Spain. To this course Bute would not consent, and as his refusal was endorsed by all his colleagues save Temple, Pitt had no choice but to leave a cabinet in which his advice on a vital question had been rejected. On his resignation, which took place in October 1761, the king urged him to accept some signal mark of royal favour in the form most agreeable to himself. Accordingly he obtained a pension of £3000 a year for three lives, and his wife, Lady Hester Grenville, whom he had married in 1754, was created Baroness Chatham in her own right. In connexion with the latter gracefully bestowed honour it may be mentioned that Pitt's domestic life was a singularly happy one.

Pitt's spirit was too lofty to admit of his entering on any merely factious opposition to the government he had quitted. On the contrary, his conduct after his retirement was distinguished by a moderation and disinterestedness which, as Burke has remarked, "set a seal upon his character." The war with Spain, in which he had urged the cabinet to take the initiative, proved inevitable; but he scorned to use the occasion for "altercation and recrimination," and spoke in support of the government measures for carrying on the war. To the preliminaries of the peace concluded in February 1763 he offered an indignant resistance, considering the terms quite inadequate to the successes that had been gained by the country. When the treaty was discussed in parliament in December of the preceding year, though suffering from a severe attack of gout, he was carried down to the House, and in a speech of three hours' duration, interrupted more than once by paroxysms of pain, he strongly protested against its various conditions. The physical cause which rendered this effort so painful probably accounts for the infrequency of his appearances in parliament, as well as for much that is otherwise inexplicable in his subsequent conduct. In 1763 he spoke against the obnoxious tax on cider, imposed by his brother-in-law, George Grenville, and his opposition, though unsuccessful in the House, helped to keep alive his popularity with the country, which cordially hated the excise and all connected with it. When next year the question of general warrants was raised in connexion with the case of Wilkes, Pitt vigorously maintained their illegality, thus defending at once the privileges of Parliament and the freedom of the press. During 1765 he seems to have been totally incapacitated for public business. In the following year he supported with great power the proposal of the Rockingham administration for the repeal of the American Stamp Act, arguing that it was unconstitutional to impose taxes upon the colonies. He thus endorsed the contention of the colonists on the ground of principle, while the majority of those who acted with him contented themselves with resisting the disastrous taxation scheme on the ground of expediency. The Repeal Act, indeed, was only passed *pari passu* with another censuring the American assemblies, and declaring the authority of the British parliament over the colonies "in all cases whatsoever"; so that the House of Commons repudiated in the most formal manner the principle Pitt laid down. His language in approval of the resistance of the colonists was unusually bold, and perhaps no one but himself could have employed it with impunity at a time when the freedom of debate was only imperfectly conceded.

Pitt had not been long out of office when he was solicited to return to it, and the solicitations were more than once renewed. Unsuccessful overtures were made to him in 1763, and twice in 1765, in May and June—the negotiator in May being the king's uncle, the duke of Cumberland, who went down in person to Hayes, Pitt's seat in Kent. It is known that he had the opportunity of joining the marquis of Rockingham's short-lived administration at any time on his own terms, and his conduct in declining an arrangement with that minister has been more generally condemned than any other step in his public life. In July 1766 Rockingham was dismissed, and Pitt was entrusted by the king with the task of forming a government entirely on his

own conditions. The result was a cabinet, strong much beyond the average in its individual members, but weak to powerlessness in the diversity of its composition. Burke, in a memorable passage of a memorable speech, has described this "chequered and speckled" administration with great humour, speaking of it as "indeed a very curious show, but utterly unsafe to touch and unsure to stand on." Pitt chose for himself the office of lord privy seal, which necessitated his removal to the House of Lords; and in August he became earl of Chatham and Viscount Pitt.

By the acceptance of a peerage the great commoner lost at least as much and as suddenly in popularity as he gained in dignity. One significant indication of this may be mentioned. In view of his probable accession to power, preparations were made in the city of London for a banquet and a general illumination to celebrate the event. But the celebration was at once countermanded when it was known that he had become earl of Chatham. The instantaneous revulsion of public feeling was somewhat unreasonable, for Pitt's health seems now to have been beyond doubt so shattered by his hereditary malady, that he was already in old age though only fifty-eight. It was natural, therefore, that he should choose a sinecure office, and the ease of the Lords. But a popular idol nearly always suffers by removal from immediate contact with the popular sympathy, be the motives for removal what they may.

One of the earliest acts of the new ministry was to lay an embargo upon corn, which was thought necessary in order to prevent a dearth resulting from the unprecedentedly bad harvest of 1766. The measure was strongly opposed, and Lord Chatham delivered his first speech in the House of Lords in support of it. It proved to be almost the only measure introduced by his government in which he personally interested himself. His attention had been directed to the growing importance of the affairs of India, and there is evidence in his correspondence that he was meditating a comprehensive scheme for transferring much of the power of the company to the crown, when he was withdrawn from public business in a manner that has always been regarded as somewhat mysterious. It may be questioned, indeed, whether even had his powers been unimpaired he could have carried out any decided policy on any question with a cabinet representing interests so various and conflicting; but, as it happened, he was incapacitated physically and mentally during nearly the whole period of his tenure of office. He scarcely ever saw any of his colleagues though they repeatedly and urgently pressed for interviews with him, and even an offer from the king to visit him in person was declined, though in the language of profound and almost abject respect which always marked his communications with the court. It has been insinuated both by contemporary and by later critics that being disappointed at his loss of popularity, and convinced of the impossibility of co-operating with his colleagues, he exaggerated his malady as a pretext for the inaction that was forced upon him by circumstances. But there is no sufficient reason to doubt that he was really, as his friends represented, in a state that utterly unfitted him for business. He seems to have been freed for a time from the pangs of gout only to be afflicted with a species of mental alienation bordering on insanity. This is the most satisfactory, as it is the most obvious, explanation of his utter indifference in presence of one of the most momentous problems that ever pressed for solution on an English statesman. Those who are able to read the history in the light of what occurred later may perhaps be convinced that no policy whatever initiated after 1766 could have prevented or even materially delayed the declaration of American independence; but to the politicians of that time the coming event had not yet cast so dark a shadow before as to paralyse all action, and if any man could have allayed the growing discontent of the colonists and prevented the ultimate dismemberment of the empire, it would have been Lord Chatham. The fact that he not only did nothing to remove existing difficulties, but remained passive while his colleagues took the fatal step which led directly to separation, is in itself clear proof of his entire incapacity. The imposition

of the import duty on tea and other commodities was the project of Charles Townshend, and was carried into effect in 1767 without consultation with Lord Chatham, if not in opposition to his wishes. It is probably the most singular thing in connexion with this singular administration, that its most pregnant measure should thus have been one directly opposed to the well-known principles of its head.

For many months things remained in the curious position that he who was understood to be the head of the cabinet had as little share in the government of the country as an unfranchised peasant. As the chief could not or would not lead, the subordinates naturally chose their own paths and not his. The lines of Chatham's policy were abandoned in other cases besides the imposition of the import duty; his opponents were taken into confidence; and friends, such as Amherst and Shelburne, were dismissed from their posts. When at length in October 1768 he tendered his resignation on the ground of shattered health, he did not fail to mention the dismissal of Amherst and Shelburne as a personal grievance.

Soon after his resignation a renewed attack of gout freed Chatham from the mental disease under which he had so long suffered. He had been nearly two years and a half in seclusion when, in July 1769, he again appeared in public at a royal levee. It was not, however, until 1770 that he resumed his seat in the House of Lords. He had now almost no personal following, mainly owing to the grave mistake he had made in not forming an alliance with the Rockingham party. But his eloquence was as powerful as ever, and all its power was directed against the government policy in the contest with America, which had become the question of all-absorbing interest. His last appearance in the House of Lords was on the 7th of April 1778, on the occasion of the duke of Richmond's motion for an address praying the king to conclude peace with America on any terms. In view of the hostile demonstrations of France the various parties had come generally to see the necessity of such a measure. But Chatham could not brook the thought of a step which implied submission to the "natural enemy" whom it had been the main object of his life to humble, and he declaimed for a considerable time, though with sadly diminished vigour, against the motion. After the duke of Richmond had replied, he rose again excitedly as if to speak, pressed his hand upon his breast, and fell down in a fit. He was removed to his seat at Hayes, where he died on the 11th of May. With graceful unanimity all parties combined to show their sense of the national loss. The Commons presented an address to the king praying that the deceased statesman might be buried with the honours of a public funeral, and voted a sum for a public monument which was erected over his grave in Westminster Abbey. Soon after the funeral a bill was passed bestowing a pension of £4000 a year on his successors in the earldom. He had a family of three sons and two daughters, of whom the second son, William, was destined to add fresh lustre to a name which is one of the greatest in the history of England.

Dr Johnson is reported to have said that "Walpole was a minister given by the king to the people, but Pitt was a minister given by the people to the king," and the remark correctly indicates Chatham's distinctive place among English statesmen. He was the first minister whose main strength lay in the support of the nation at large as distinct from its representatives in the Commons, where his personal following was always small. He was the first to discern that public opinion, though generally slow to form and slow to act, is in the end the paramount power in the state; and he was the first to use it not in an emergency merely, but throughout a whole political career. He marks the commencement of that vast change in the movement of English politics by which it has come about that the sentiment of the great mass of the people now tells effectively on the action of the government from day to day,—almost from hour to hour. He was well fitted to secure the sympathy and admiration of his countrymen, for his virtues and his failings were alike English. He was often inconsistent, he was generally intractable and overbearing, and he was always pompous and affected to a

degree which, Macaulay has remarked, seems scarcely compatible with true greatness. Of the last quality evidence is furnished in the stilted style of his letters, and in the fact recorded by Seward that he never permitted his under-secretaries to sit in his presence. Burke speaks of "some significant, pompous, creeping, explanatory, ambiguous matter, in the true Chathamian style." But these defects were known only to the inner circle of his associates. To the outside public he was endeared as a statesman who could do or suffer "nothing base," and who had the rare power of transfusing his own indomitable energy and courage into all who served under him. "A spirited foreign policy" has always been popular in England, and Pitt was the most popular of English ministers, because he was the most successful exponent of such a policy. In domestic affairs his influence was small and almost entirely indirect. He himself confessed his unfitness for dealing with questions of finance. The commercial prosperity that was produced by his war policy was in a great part delusive, as prosperity so produced must always be, though it had permanent effects of the highest moment in the rise of such centres of industry as Glasgow. This, however, was a remote result which he could have neither intended nor foreseen.

The correspondence of Lord Chatham, in four volumes, was published in 1838-1840; and a volume of his letters to Lord Camelford in 1804. The Rev. Francis Thackeray's *History of the Rt. Hon. William Pitt, Earl of Chatham* (2 vols., 1827), is a ponderous and shapeless work. Frederic Harrison's *Chatham*, in the "Twelve English Statesmen" series (1905), though skillfully executed, takes a rather academic and modern Liberal view. A German work, *William Pitt, Graf von Chatham*, by Albert von Ruville (3 vols., 1905; English trans. 1907), is the best and most thorough account of Chatham, his period, and his policy, which has appeared. See also the separate article on William Pitt, and the authorities referred to, especially the Rev. William Hunt's appendix i. to his vol. x. of *The Political History of England* (1905).

CHATHAM, also called **MIRAMICHI**, an incorporated town and port of entry in Northumberland county, New Brunswick, Canada, on the Miramichi river, 24 m. from its mouth and 10 m. by rail from Chatham junction on the Intercolonial railway. Pop. (1901) 5000. The town contains the Roman Catholic pro-cathedral, many large saw-mills, pulp-mills, and several establishments for curing and exporting fish. The lumber trade, the fisheries, and the manufacture of pulp are the chief industries.

CHATHAM, a city and port of entry of Ontario, Canada, and the capital of Kent county, situated 64 m. S.W. of London, and 11 m. N. of Lake Erie, on the Thames river and the Grand Trunk, Canadian Pacific and Lake Erie & Detroit River railways. Pop. (1901) 9068. It has steamboat connexion with Detroit and the cities on Lakes Huron and Erie. It is situated in a rich agricultural and fruit-growing district, and carries on a large export trade. It contains a large wagon factory, planing and flour mills, manufactories of fanning mills, binder-twine, woven wire goods, engines, windmills, &c.

CHATHAM, a port and municipal and parliamentary borough of Kent, England, on the right bank of the Medway, 34 m. E.S.E. of London by the South-Eastern & Chatham railway. Pop. (1891) 31,657; (1901) 37,057. Though a distinct borough it is united on the west with Rochester and on the east with Gillingham, so that the three boroughs form, in appearance, a single town with a population which in 1901 exceeded 110,000. With the exception of the dockyards and fortifications there are few objects of interest. St Mary's church was opened in 1903, but occupies a site which bore a church in Saxon times, though the previous building dated only from 1786. A brass commemorates Stephen Borough (d. 1584), discoverer of the northern passage to Archangel in Russia (1553). St Bartholomew's chapel, originally attached to the hospital for lepers (one of the first in England), founded by Gundulph, bishop of Rochester, in 1070, is in part Norman. The funds for the maintenance of the hospital were appropriated by decision of the court of chancery to the hospital of St Bartholomew erected in 1863 within the boundaries of Rochester. The almshouse established in 1592 by Sir John Hawkins for decayed seamen and shipwrights is still extant, the building having been re-erected in the 19th century; but the fund called the Chatham Chest, originated by Hawkins and Drake in

1588, was incorporated with Greenwich Hospital in 1802. In front of the Royal Engineers' Institute is a statue (1890) of General Gordon, and near the railway station another (1888) to Thomas Waghorn, promoter of the overland route to India. In 1905 King Edward VII. unveiled a fine memorial arch commemorating Royal Engineers who fell in the South African War. It stands in the parade ground of the Brompton barracks, facing the Crimean arch. There are numerous brickyards, lime-kilns and flour-mills in the district neighbouring to Chatham; and the town carries on a large retail trade, in great measure owing to the presence of the garrison. The fortifications are among the most elaborate in the kingdom. The so-called Chatham Lines enclose New Brompton, a part of the borough of Gillingham. They were begun in 1758 and completed in 1807, but have been completely modernized. They are strengthened by several detached forts and redoubts. Fort Pitt, which rises above the town to the west, was built in 1779, and is used as a general military hospital. It was regarded as the principal establishment of the kind in the country till the foundation of Netley in Hampshire. The lines include the Chatham, the Royal Marine, the Brompton, the Hut, St Mary's and naval barracks; the garrison hospital, Melville hospital for sailors and marines, the arsenal, gymnasium, various military schools, convict prison, and finally the extensive dockyard system for which the town is famous. This dockyard covers an area of 516 acres, and has a river frontage of over 3 m. It was brought into its present state by the extensive works begun about 1867. Before that time there was no basin or wet-dock, though the river Medway to some extent answered the same purpose, but a portion of the adjoining salt-marshes was then taken in, and three basins have been constructed, communicating with each other by means of large locks, so that ships can pass from the bend of the Medway at Gillingham to that at Upnor. Four graving docks were also formed, opening out of the first (Upnor) basin. Subsequent improvements included dredging operations in the Medway to improve the approach, and the provision of extra dry-dock accommodation under the Naval Works Acts.

The parliamentary borough returns one member. The town was incorporated in 1890, and is governed by a mayor, six aldermen and eighteen councillors. Area, 4355 acres. The borough includes the suburb (an ecclesiastical parish) of Luton, in which are the waterworks of Chatham and the adjoining towns.

Chatham (*Cetcham, Chetham*) belonged at the time of the Domesday Survey to Odo, bishop of Bayeux. During the middle ages it formed a suburb of Rochester, but Henry VIII. in founding a regular navy began to establish dockyards, and the harbour formed by the deep channel of the Medway was utilized by Elizabeth, who built a dockyard and established an arsenal here. The dockyard was altered and improved by Charles I. and Charles II., and became the chief naval station of England. In 1708 an act was passed for extending the fortifications of Chatham. During the excavations on Chatham Hill after 1758 a number of tumuli containing human remains, pottery, coins, &c., suggestive of an ancient settlement, were found. Chatham was constituted a parliamentary borough by the Reform Bill of 1832. In the time of Edward III. the lord of the manor had two fairs, one on the 24th of August and the other on the 8th of September. A market to be held on Tuesday, and a fair on the 4th, 5th and 6th of May, were granted by Charles II. in 1679, and another provision market on Saturday by James II. in 1688. In 1738 fairs were held on the 4th of May and the 8th of September, and a market every Saturday.

CHATHAM ISLANDS, a small group in the Pacific Ocean, forming part of New Zealand, 536 m. due E. of Lyttelton in the South Island, about 44° S.; 177° W. It consists of three islands, a large one called Whairikauri, or Chatham Island, a smaller one, Rangihau, or Pitt Island, and a third, Rangatira, or South-east Island. There are also several small rocky islets. Whairikauri, whose highest point reaches about 1000 ft., is remarkable for the number of lakes and tarns it contains, and for the extensive bogs which cover the surface of nearly the whole of the uplands. It is of very irregular form, about 38 m. in

length and 25 m. in extreme breadth, with an area of 321 sq. m.—a little larger than Middlesex. The geological formation is principally of volcanic rocks, with schists and tertiary limestone; and an early physical connexion of the islands with New Zealand is indicated by their geology and biology. The climate is colder than that of New Zealand. In the centre of Whairikauri is a large brackish lake called Tewanga, which at the southern end is separated from the sea by a sandbank only 150 yds. wide, which it occasionally bursts through. The southern part of the island has an undulating surface, and is covered either with an open forest or with high ferns. In general the soil is extremely fertile, and where it is naturally drained a rich vegetation of fern and flax occurs. On the north-west are several conical hills of basalt, which are surrounded by oases of fertile soil. On the south-western side is Petre Bay, on which, at the mouth of the river Mantagu, is Waitangi, the principal settlement.

The islands were discovered in 1791 by Lieutenant W. R. Broughton (1762-1821), who gave them the name of Chatham from the brig which he commanded. He described the natives as a bright, pleasure-loving people, dressed in sealskins or mats, and calling themselves Morioris or Maiorioris. In 1831 they were conquered by 800 Maoris who were landed from a European vessel. They were almost exterminated, and an epidemic of influenza in 1839 killed half of those left; ten years later there were only 90 survivors out of a total population of 1200. They subsequently decreased still further. Their language was allied to that of the Maoris of New Zealand, but they differed somewhat from them in physique, and they were probably a cross between an immigrating Polynesian group and a lower indigenous Melanesian stock. The population of the islands includes about 200 whites of various races and the same number of natives (chiefly Maoris). Cattle and sheep are bred, and a trade is carried on in them with the whalers which visit these seas. The chief export from the group is wool, grown upon runs farmed both by Europeans and Morioris. There is also a small export by the natives of the flesh of young albatrosses and other sea-birds, boiled down and cured, for the Maoris of New Zealand, by whom it is reckoned a delicacy. The imports consist of the usual commodities required by a population where little of the land is actually cultivated.

There are no indigenous mammals; the reptiles belong to New Zealand species. The birds—the largest factor in the fauna—have become very greatly reduced through the introduction of cats, dogs and pigs, as well as by the constant persecution of every sort of animal by the natives. The larger bell-bird (*Anthornis melanoccephala*) has become quite scarce; the magnificent fruit-pigeon (*Carpophaga chathamensis*), and the two endemic rails (*Nesolimnas dieffenbachii* and *Cabalus modestus*), the one of which was confined to Whairikauri and the other to Mangare Island, are extinct. Several fossil or subfossil avian forms, very interesting from the point of view of geographical distribution, have been discovered by Dr H. O. Forbes, namely, a true species of raven (*Palaeocorax moriorum*), a remarkable rail (*Diaphorapteryx*), closely related to the extinct *Aphanapteryx* of Mauritius, and a large coot (*Palaeolimnas chathamensis*). There have also been discovered the remains of a species of swan belonging to the South American genus *Chenopsis*, and of the tuatara (*Hatteria*) lizard, the unique species of an ancient family now surviving only in New Zealand. The swan is identical with an extinct species found in caves and kitchen-middens in New Zealand, which was contemporaneous with the prehistoric Maoris and was largely used by them for food. One of the finest of the endemic flowering plants of the group is the boraginaceous "Chatham Island lily" (*Mysisitidium nobile*), a gigantic forget-me-not, which grows on the shingly shore in a few places only, and always just on the high-water mark, where it is daily deluged by the waves; while dracophyllums, leucopogons and arborescent ragworts are characteristic forms in the vegetation.

See Bruno Weiss, *Fünfzig Jahre auf Chatham Island* (Berlin, 1900); H. O. Forbes, "The Chatham Islands and their Story," *Fortnightly Review* (1893), vol. liii. p. 669, "The Chatham Islands, their relation to a former Southern Continent." *Supplementary*

Papers, R.G.S., vol. iii. (1893); J. H. Scott, "The Osteology of the Maori and the Moriori," *Trans. New Zealand Institute*, vol. xxvi. (1893); C. W. Andrews, "The Extinct Birds of the Chatham Islands," *Novitates Zoológicae*, vol. ii. p. 73 (1896).

CHÂTILLON, the name of a French family whose history has furnished material for a large volume in folio by A. du Chesne, a learned Frenchman, published in 1621. But in spite of its merits this book presents a certain number of inaccurate statements, some of which it is important to notice. If, for instance, it be true that the Châtillons came from Châtillon-sur-Marne (Marne, arrondissement of Reims), it is now certain that, since the 11th century, this castle belonged to the count of Champagne, and that the head of the house of Châtillon was merely tenant in that place. One of them, however, Gaucher of Châtillon, lord of Crécy and afterwards constable of France, became in 1290 lord of Châtillon-sur-Marne by exchange, but since 1303 a new agreement allotted to him the countship of Porcien, while Châtillon reverted to the domain of the counts of Champagne. It may be well to mention also that, in consequence of a resemblance of their armorial bearings, du Chesne considered wrongly that the lords of Bazoches and those of Château-Porcien of the 12th and 13th centuries drew their descent from the house of Châtillon.

The most important branches of the house of Châtillon were those of (1) St Pol, beginning with Gaucher III. of Châtillon, who became count of St Pol in right of his wife Isabelle in 1205, the last male of the line being Guy V. (d. 1360); (2) Blois, founded by the marriage of Hugh of Châtillon-St Pol (d. 1248) with Mary, daughter of Margaret of Blois (d. 1230),—this branch became extinct with the death of Guy II. in 1397; (3) Porcien, from 1303 to 1400, when Count John sold the countship to Louis, duke of Orleans; (4) Penthièvre, by the marriage of Charles of Blois (d. 1364) with Jeanne (d. 1384), heiress of Guy, count of Penthièvre (d. 1331), the male line becoming extinct in 1457.

See A. du Chesne, *Histoire généalogique de la maison de Châtillon-sur-Marne* (1621); Anselme, *Histoire généalogique de la maison royale de France*, vi. 91-124 (1730). (A. Lo.)

CHÂTILLON-SUR-SEINE, a town of eastern France, capital of an arrondissement in the department of Côte-d'Or, on the Eastern and Paris-Lyon railways, 67 m. N.N.W. of Dijon, between that city and Troyes. Pop. (1906) 4430. It is situated on both banks of the upper Seine, which is swelled at its entrance to the town by the Douix, one of the most abundant springs in France. Châtillon is constructed on ample lines and rendered attractive by beautiful promenades. Some ruins on an eminence above it mark the site of a château of the dukes of Burgundy. Near by stands the church of St Vorle of the 10th century, but with many additions of later date; it contains a sculptured Holy Sepulchre of the 16th century and a number of frescoes. In a fine park stands a modern château built by Marshal Marmont, duke of Ragusa, born at Châtillon in 1774. It was burnt in 1871, and subsequently rebuilt. The town preserves several interesting old houses. Châtillon has a sub-prefecture, tribunals of first instance and of commerce, a school of agriculture and a communal college. Among its industries are brewing, iron-founding and the manufacture of mineral and other blacks. It has trade in wood, charcoal, lithographic and other stone. Châtillon anciently consisted of two parts, Chaumont, belonging to the duchy of Burgundy, and Bourg, ruled by the bishop of Langres; it did not coalesce into one town till the end of the 16th century. It was taken by the English in 1360 and by Louis XI. in 1475, during his struggle with Charles the Bold. Châtillon was one of the first cities to adhere to the League, but suffered severely from the oppression of its garrisons and governors, and in 1595 made voluntary submission to Henry IV. In modern times it is associated with the abortive conference of 1814 between the representatives of Napoleon and the Allies.

CHATSWORTH, a village of Derbyshire, England, containing a seat belonging to the duke of Devonshire, one of the most splendid private residences in England. Chatsworth House is situated close to the left bank of the river Derwent, 2½ m. from Bakewell. It is Ionic in style, built foursquare, and enclosing a large open courtyard, with a fountain in the centre. In front,

a beautiful stretch of lawn slopes gradually down to the riverside, and a bridge, from which may best be seen the grand façade of the building, as it stands out in relief against the wooded ridge of Bunker's Hill. The celebrated gardens are adorned with sculptures by Gabriel Cibber; Sir Joseph Paxton designed the great conservatory, unrivalled in Europe, which covers an acre; and the fountains, which include one with a jet 260 ft. high, are said to be surpassed only by those at Versailles. Within the house there is a very fine collection of pictures, including the well-known portraits by Reynolds of Georgiana, duchess of Devonshire. Other paintings are ascribed to Holbein, Dürer, Murillo, Jan van Eyck, Dolci, Veronese and Titian. Hung in the gallery of sketches there are some priceless drawings attributed to Michelangelo, Leonardo da Vinci, Raffaele, Correggio, Titian and other old masters. Statues by Canova, Thorwaldsen, Chantrey and R. J. Wyatt are included among the sculptures. In the state apartments the walls and window-panes are in some cases inlaid with marble or porphyry; the woodcarving, marvellous for its intricacy, grace and lightness of effect, is largely the work of Samuel Watson of Heanor (d. 1715). Chatsworth Park is upwards of 11 m. in circuit, and contains many noble forest-trees, the whole being watered by the Derwent, and surrounded by high moors and uplands. Beyond the river, and immediately opposite the house, stands the model village of Edensor, where most of the cottages were built in villa style, with gardens, by order of the 6th duke. The parish church, restored by the same benefactor, contains an old brass in memory of John Beaton, confidential servant to Mary, queen of Scots, who died in 1570; and in the churchyard are the graves of Lord Frederick Cavendish, murdered in 1882 in Phoenix Park, Dublin, and of Sir Joseph Paxton.

Chatsworth (*Chetsworde*, *Chetelsworde*, "the court of Chetel") took its name from Chetel, one of its Saxon owners, who held it of Edward the Confessor. It belonged to the crown and was entrusted by the Conqueror to the custody of William Peverell. Chatsworth afterwards belonged for many generations to the family of Leech, and was purchased in the reign of Elizabeth by Sir William Cavendish, husband of the famous Bess of Hardwick. In 1557 he began to build Chatsworth House, and it was completed after his death by his widow, then countess of Shrewsbury. Here Mary, queen of Scots, spent several years of her imprisonment under the care of the earl of Shrewsbury. During the Civil War, Chatsworth was occasionally occupied as a fortress by both parties. It was pulled down, and the present house begun by William, 1st duke of Devonshire in 1688. The little village consists almost exclusively of families employed upon the estate.

CHATTANOOGA, a city and the county-seat of Hamilton county, Tennessee, U.S.A., in the S.E. part of the state, about 300 m. S. of Cincinnati, Ohio, and 150 m. S.E. of Nashville, Tennessee, on the Tennessee river, and near the boundary line between Tennessee and Georgia. Pop. (1860) 2545; (1870) 6093; (1880) 12,892; (1890) 29,100; (1900) 30,154, of whom 994 were foreign-born and 13,122 were negroes; (U. S. census, 1910) 44,604. The city is served by the Alabama Great Southern (Queen and Crescent), the Cincinnati Southern (leased by the Cincinnati, New Orleans & Texas Pacific railway company), the Nashville, Chattanooga & St Louis (controlled by the Louisville & Nashville), and its leased line, the Western & Atlantic (connecting with Atlanta, Ga.), the Central of Georgia, and the Chattanooga Southern railways, and by freight and passenger steamboat lines on the Tennessee river, which is navigable to and beyond this point during eight months of the year. That branch of the Southern railway extending from Chattanooga to Memphis was formerly the Memphis & Charleston, under which name it became famous in the American Civil War. Chattanooga occupies a picturesque site at a sharp bend of the river. To the south lies Lookout Mountain, whose summit (2126 ft. above the sea; 1495 ft. above the river) commands a magnificent view. To the east rises Missionary Ridge. Fine driveways and electric lines connect with both Lookout Mountain (the summit of which is reached by an inclined plane on which cars are operated by

cable) and Missionary Ridge, where there are Federal reservations, as well as with the National Military Park (15 sq. m.; dedicated 1895) on the battlefield of Chickamauga (q.v.); this park was one of the principal mobilization camps of the United States army during the Spanish-American War of 1898. Among the principal buildings are the city hall, the Federal building, the county court house, the public library, the high school and the St Vincent's and the Baroness Erlanger hospitals. Among Chattanooga's educational institutions are two commercial colleges, the Chattanooga College for Young Ladies (non-sectarian), the Chattanooga Normal University, and the University of Chattanooga, until June 1907, United States Grant University (whose preparatory department, "The Athens School," is at Athens, Tenn.), a co-educational institution under Methodist Episcopal control, established in 1867; it has a school of law (1899), a medical school (1889), and a school of theology (1888). East of the city is a large national cemetery containing more than 13,000 graves of Federal soldiers. Chattanooga is an important produce, lumber, coal and iron market, and is the principal trade and jobbing centre for a large district in Eastern Tennessee and Northern Georgia and Alabama. The proximity of coalfields and iron mines has made Chattanooga an iron manufacturing place of importance, its plants including car shops, blast furnaces, foundries, agricultural implement and machinery works, and stove factories; the city has had an important part in the development of the iron and steel industries in this part of the South. There are also flour mills, tanneries (United States Leather Co.), patent medicine, furniture, coffin, woodenware and wagon factories, knitting and spinning mills, planing mills, and sash, door and blind factories—the lumber being obtained from logs floated down the river and by rail. The value of the city's factory products increased from \$10,517,886 in 1900 to \$15,193,909 in 1905 or 44.5%.

Chattanooga was first settled about 1835, and was long known as Ross's Landing. It was incorporated in 1851 as Chattanooga, and received a city charter in 1866. Its growth for the three decades after the Civil War was very rapid. During the American Civil War it was one of the most important strategic points in the Confederacy, and in its immediate vicinity were fought two great battles. During June 1862 it was threatened by a Federal force under General O. M. Mitchel, but the Confederate army of General Braxton Bragg was transferred thither by rail from Corinth, Miss., before Mitchel was able to advance. In September 1863, however, General W. S. Rosecrans, with the Union Army of the Cumberland out-maneuvred Bragg, concentrated his numerous columns in the Chickamauga Valley, and occupied the town, to which, after the defeat of Chickamauga (q.v.), he retired.

From the end of September to the 24th of November the Army of the Cumberland was then invested in Chattanooga by the Confederates, whose position lay along Missionary Ridge from its north end near the river towards Rossville, whence their entrenchments extended westwards to Lookout Mountain, which dominates the whole ground, the Tennessee running directly beneath it. Thus Rosecrans was confined to a semicircle of low ground around Chattanooga itself, and his supplies had to make a long and difficult *détour* from Bridgeport, the main road being under fire from the Confederate position on Lookout and in the Wauhatchie valley adjacent. Bragg indeed expected that Rosecrans would be starved into retreat. But the Federals once more, and this time on a far larger scale, concentrated in the face of the enemy. The XI. and XII. corps from Virginia under Hooker were transferred by rail to reinforce Rosecrans; other troops were called up from the Mississippi, and on the 16th of October the Federal government reconstituted the western armies under the supreme command of General Grant. The XV. corps of the Army of the Tennessee, under Sherman, was on the march from the Mississippi. Hooker's troops had already arrived when Grant reached Chattanooga on the 23rd of October. The Army of the Cumberland was now under Thomas, Rosecrans having been recalled. The first action was fought at Brown's Ferry in the Wauhatchie valley, where Hooker executed with

complete precision a plan for the revictualling of Chattanooga, established himself near Wauhatchie on the 28th, and repulsed a determined attack on the same night. But Sherman was still far distant, and the Federal forces at Knoxville, against which a large detachment of Bragg's army under Longstreet was now sent, were in grave danger. Grant waited for Sherman's four divisions, but prepared everything for battle in the meantime. His plan was that Thomas in the Chattanooga lines should contain the Confederate centre on Missionary Ridge, while Hooker on the right at Wauhatchie was to attack Lookout Mountain, and Sherman farther up the river was to carry out the decisive attack against Bragg's extreme right wing at the end of Missionary Ridge. The last marches of the XV. corps were delayed by stormy weather, Bragg reinforced Longstreet, and telegraphic communication between Grant and the Federals at Knoxville had already ceased. But Grant would not move forward without Sherman, and the battle of Chattanooga was fought more than two months after Chickamauga. On the 23rd of November a forward move of Thomas's army, intended as a

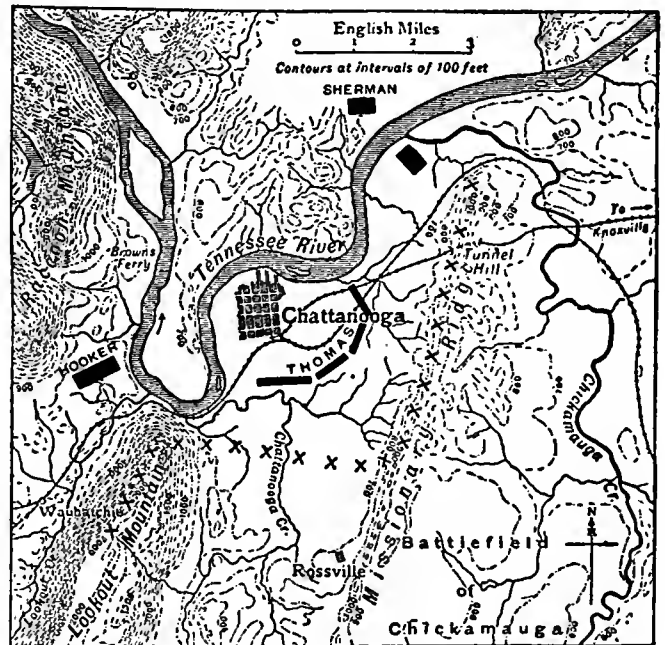

Confederate line of defence X X X X Union troops .■■■

demonstration, developed into a serious and successful action, whereby the first line of the Confederate centre was driven in for some distance. Bragg was now much weakened by successive detachments having been sent to Knoxville, and on the 24th the real battle began. Sherman's corps was gradually brought over the river near the mouth of Chickamauga Creek, and formed up on the east side.

The attack began at 1 P.M. and was locally a complete success. The heights attacked were in Sherman's hands, and fortified against counter-attack, before nightfall. Hooker in the meanwhile had fought the "Battle above the Clouds" on the steep face of Lookout Mountain, and though opposed by an equal force of Confederates, had completely driven the enemy from the mountain. The 24th then had been a day of success for the Federals, and the decisive attack of the three armies in concert was to take place on the 25th. But the maps deceived Grant and Sherman as they had previously deceived Rosecrans. Sherman had captured, not the north point of Missionary Ridge, but a detached hill, and a new and more serious action had to be fought for the possession of Tunnel Hill, where Bragg's right now lay strongly entrenched. The Confederates used every effort to hold the position and all Sherman's efforts were made in vain. Hooker, who was moving on Rossville, had not progressed far, and Bragg was still free to reinforce his right. Grant therefore directed Thomas to move forward on the centre to relieve the

pressure on Sherman. The Army of the Cumberland was, after all, to strike the decisive blow. About 3.30 P.M. the centre advanced on the Confederate's trenches at the foot of Missionary Ridge. These were carried at the first rush, and the troops were ordered to lie down and await orders. Then occurred one of the most dramatic episodes of the war. Suddenly, and without orders either from Grant or the officers at the front, the whole line of the Army of the Cumberland rose and rushed up the ridge. Two successive lines of entrenchments were carried at once. In a short time the crest was stormed, and after a last attempt at resistance the enemy's centre fled in the wildest confusion. The pursuit was pressed home by the divisional generals, notably by Sheridan. Hooker now advanced in earnest on Rossville, and by nightfall the whole Confederate army, except the troops on Tunnel Hill, was retreating in disorder. These too were withdrawn in the night, and the victory of the Federals was complete. Bragg lost 8684 men killed, wounded and prisoners out of perhaps 34,000 men engaged; Grant, with 60,000 men, lost about 6000.

CHATTEL (for derivation see **CATTLE**), a term used in English law as equivalent to "personal property," that is, property which, on the death of the owner, devolves on his executor or administrator to be distributed (unless disposed of by will) among the next of kin according to the Statutes of Distributions. Chattels are divided into *chattels real* and *chattels personal*. Chattels real are those interests in land for which no "real action" (see **ACTION**) lies; estates which are less than freehold (estates for years, at will, or by sufferance) are chattels real. Chattels personal are such things as belong immediately to the person of the owner, and for which, if they are injuriously withheld from him, he has no remedy other than by a personal action. Chattels personal are divided into *choses in possession* and *choses in action* (see **CHOSE**).

A chattel mortgage, in United States law, is a transfer of personal property as security for a debt or obligation in such form that the title to the property will pass to the mortgagee upon the failure of the mortgagor to comply with the terms of the contract. At common law a chattel mortgage might be made without writing, and was valid as between the parties, and even as against third parties if accompanied by possession in the mortgagee, but in most states of the Union legislation now requires a chattel mortgage to be in writing and duly recorded in order to be valid against third parties. At common law a mortgage can be given only of chattels actually in existence and belonging to the mortgagor, though if he acquired title afterwards the mortgage would be good as between the parties, but not as against subsequent purchasers or creditors. In equity, on the other hand, a chattel mortgage, though not good as a conveyance, is valid as an executory agreement.

Goods and chattels is a phrase which, in its widest signification, includes any property other than freehold. The two words, however, have come to be synonymous, and the expression, now practically confined to wills, means merely things movable in possession.

CHATTERIS, a market town in the Wisbech parliamentary division of Cambridgeshire, England, 25½ m. N. by W. of Cambridge by the Great Eastern railway. Pop. of urban district (1901) 4711. It lies in the midst of the flat Fen country. The church of St Peter is principally Decorated; and there are fragments of a Benedictine convent founded in the 10th century and rebuilt after fire in the first half of the 14th. The town has breweries, and engineering and rope-making works. To the north runs the great Forty-foot Drain, also called Vermuyden's, after the Dutch engineer whose name is associated with the fen drainage works of the middle of the 17th century.

CHATTERJI, BANKIM CHANDRA [**BANKIMACHANDRA CHATTĀRADH-YĀYA**] (1838-1894), Indian novelist, was born in the district of the Twenty-four Parganas in Bengal on the 27th of June 1838, and was by caste a Brahman. He was educated at the Hugli College, at the Presidency College in Calcutta, and at Calcutta University, where he was the first to take the degree of B.A. (1858). He entered the Indian civil service, and served

as deputy magistrate in various districts of Bengal, his official services being recognized, on his retirement in 1891, by the title of rai bahadur and the C.I.E. He died on the 8th of April 1894.

Bankim Chandra was beyond question the greatest novelist of India during the 19th century, whether judged by the amount and quality of his writings, or by the influence which they have continued to exercise. His education had brought him into touch with the works of the great European romance writers, notably Sir Walter Scott, and he created in India a school of fiction on the European model. His first historical novel, the *Durges-Nandini* or *Chief's Daughter*, modelled on Scott, made a great sensation in Bengal; and the *Kapala-Kundala* and *Mrinalini*, which followed it, established his fame as a writer whose creative imagination and power of delineation had never been surpassed in India. In 1872 he brought out his first social novel, the *Bisha-Brikha* or *Poison Tree*, which was followed by others in rapid succession. It is impossible to exaggerate the effect they produced; for over twenty years Bankim Chandra's novels were eagerly read by the educated public of Bengal, including the Hindu ladies in the zenanas; and though numerous works of fiction are now produced year by year in every province of India, his influence has increased rather than diminished. Of all his works, however, by far the most important from its astonishing political consequences was the *Ananda Math*, which was published in 1882, about the time of the agitation arising out of the Ilbert Bill. The story deals with the Sannyasi (*i.e.* fakir or hermit) rebellion of 1772 near Purmea, Tirhut and Dinapur, and its culminating episode is a crushing victory won by the rebels over the united British and Mussulman forces, a success which was not, however, followed up, owing to the advice of a mysterious "physician" who, speaking as a divinely-inspired prophet, advises Satyananda, the leader of "the children of the Mother," to abandon further resistance, since a temporary submission to British rule is a necessity; for Hinduism has become too speculative and unpractical, and the mission of the English in India is to teach Hindus how to reconcile theory and speculation with the facts of science. The general moral of the *Ananda Math*, then, is that British rule and British education are to be accepted as the only alternative to Mussulman oppression, a moral which Bankim Chandra developed also in his *Dharmatattwa*, an elaborate religious treatise in which he explained his views as to the changes necessary in the moral and religious condition of his fellow-countrymen before they could hope to compete on equal terms with the British and Mahomedans. But though the *Ananda Math* is in form an apology for the loyal acceptance of British rule, it is none the less inspired by the ideal of the restoration, sooner or later, of a Hindu kingdom in India. This is especially evident in the occasional verses in the book, of which the *Bande Mataram* is the most famous.

As to the exact significance of this poem a considerable controversy has raged. *Bande Mataram* is the Sanskrit for "Hail to thee, Mother!" or more literally "I reverence thee, Mother!" and according to Dr G. A. Grierson (*The Times*, Sept. 12, 1906) it can have no other possible meaning than an invocation of one of the "mother" goddesses of Hinduism, in his opinion Kali "the goddess of death and destruction." Sir Henry Cotton, on the other hand (*ib.* Sept. 13, 1906), sees in it merely an invocation of the "mother-land" Bengal, and quotes in support of this view the free translation of the poem by the late W. H. Lee, a proof which, it may be at once said, is far from convincing. But though, as Dr Grierson points out, the idea of a "mother-land" is wholly alien to Hindu ideas, it is quite possible that Bankim Chandra may have assimilated it with his European culture, and the true explanation is probably that given by Mr J. D. Anderson in *The Times* of September 24, 1906. He points out that in the 11th chapter of the 1st book of the *Ananda Math* the Sannyasi rebels are represented as having erected, in addition to the image of Kali, "the Mother who Has Been," a white marble statue of "the Mother that Shall Be," which "is apparently a representation of the mother-land."

The *Bande Mataram* hymn is apparently addressed to both idols."

The poem, then, is the work of a Hindu idealist who personified Bengal under the form of a purified and spiritualized Kali. Of its thirty-six lines, partly written in Sanskrit, partly in Bengali, the greater number are harmless enough. But if the poet sings the praise of the "Mother"

"As Lachmi, bowed in the flower
That in the water grows,"

he also praises her as "Durga, bearing ten weapons," and lines 10, 11 and 12 are capable of very dangerous meanings in the mouths of unscrupulous agitators. Literally translated these run, "She has seventy millions of throats to sing her praise, twice seventy millions of hands to fight for her, how then is Bengal powerless?" As S. M. Mitra points out (*Indian Problems*, London, 1908), this language is the more significant as the *Bande Mataram* in the novel was the hymn by singing which the Sannyasis gained strength when attacking the British forces.

During Bankim Chandra Chatterji's lifetime the *Bande Mataram*, though its dangerous tendency was recognized, was not used as a party war-cry; it was not raised, for instance, during the Ilbert Bill agitation, nor by the students who flocked round the court during the trial of Surendra Nath Banerji in 1883. It has, however, obtained an evil notoriety in the agitations that followed the partition of Bengal. That Bankim Chandra himself foresaw or desired any such use of it is impossible to believe. According to S. M. Mitra, he composed it "in a fit of patriotic excitement after a good hearty dinner, which he always enjoyed. It was set to Hindu music, known as the *Mallar-Kawali-Tal*. The extraordinarily stirring character of the air, and its ingenious assimilation of Bengali passages with Sanskrit, served to make it popular."

Circumstances have made the *Bande Mataram* the most famous and the most widespread in its effects of Bankim Chandra's literary works. More permanent, it may be hoped, was the wholesome influence he exercised on the number of literary men he gathered round him, who have left their impress on the literature of Bengal. In his earlier years he served his apprenticeship in literature under Iswar Chandra Vidyasagar, the chief poet and satirist of Bengal during the earlier half of the 19th century. Bankim Chandra's friend and colleague, Dina Bandhu Mitra, was virtually the founder of the modern Bengali drama. Another friend of his, Hem Chandra Banerji, was a poet of recognized merit and talent. And among the younger men who venerated Bankim Chandra, and benefited by his example and advice, may be mentioned two distinguished poets, Nalcin Chandra Sen and Rabindra Nath Tagore.

Of Bankim Chandra's novels some have been translated into English by H. A. D. Phillips and by Mrs M. S. Knight.

CHATTERTON, THOMAS (1752-1770), English poet, was born at Bristol on the 20th of November 1752. His pedigree has a curious significance. The office of sexton of St Mary Redcliffe, at Bristol, one of the most beautiful parish churches in England, had been transmitted for nearly two centuries in the Chatterton family; and throughout the brief life of the poet it was held by his uncle, Richard Phillips. The poet's father, Thomas Chatterton, was a musical genius, somewhat of a poet, a numismatist, and a dabbler in occult arts. He was one of the sub-chanters of Bristol cathedral, and master of the Pyle Street free school, near Redcliffe church. But whatever hereditary tendencies may have been transmitted from the father, the sole training of the boy necessarily devolved on his mother, who was in the fourth month of her widowhood at the time of his birth. She established a girls' school, took in sewing and ornamental needlework, and so brought up her two children, a girl and a boy, till the latter attained his eighth year, when he was admitted to Colston's Charity. But the Bristol blue-coat school, in which the curriculum was limited to reading, writing, arithmetic and the Church Catechism, had little share in the education of its marvellous pupil. The hereditary race of sextons had come to regard the church of St Mary Redcliffe as their own peculiar

domain; and, under the guidance of his uncle, the child found there his favourite haunt. The knights, ecclesiastics and civic dignitaries, recumbent on its altar tombs, became his familiar associates; and by and by, when he was able to spell his way through the inscriptions graven on their monuments, he found a fresh interest in certain quaint oaken chests in the muniment room over the porch on the north side of the nave, where parchment deeds, old as the Wars of the Roses, long lay unheeded and forgotten. They formed the child's playthings almost from his cradle. He learned his first letters from the illuminated capitals of an old musical folio, and learned to read out of a black-letter Bible. He did not like, his sister said, reading out of small books. Wayward, as it seems, almost from his earliest years, and manifesting no sympathy with the ordinary pastimes of children, he was regarded for a time as deficient in intellect. But he was even then ambitious of distinction. His sister relates that on being asked what device he would like painted on a bowl that was to be his, he replied, "Paint me an angel, with wings, and a trumpet, to trumpet my name over the world."

From his earliest years he was liable to fits of abstraction, sitting for hours in seeming stupor, or yielding after a time to tears, for which he would assign no reason. He had no one near him to sympathize in the strange world of fancy which his imagination had already called into being; and circumstances helped to foster his natural reserve, and to beget that love of mystery which exercised so great an influence on the development of his genius. When the strange child had attained his sixth year his mother began to recognize his capacity; at eight he was so eager for books that he would read and write all day long if undisturbed; and in his eleventh year he had become a contributor to *Felix Farley's Bristol Journal*. The occasion of his confirmation inspired some religious poems published in this paper. In 1763 a beautiful cross of curious workmanship, which had adorned the churchyard of St Mary Redcliffe for upwards of three centuries, was destroyed by a churchwarden. The spirit of veneration was strong in the boy, and he sent to the local journal on the 7th of January 1764 a clever satire on the parish Vandal. But his delight was to lock himself in a little attic which he had appropriated as his study; and there, with books, cherished parchments, saved from the loot of the muniment room of St Mary Redcliffe, and drawing materials, the child lived in thought with his 15th-century heroes and heroines. The first of his literary mystifications, the duologue of "Elinoure and Juga," was written before he was twelve years old, and he showed his poem to the usher at Colston's hospital, Thomas Phillips, as the work of a 15th-century poet.

Chatterton remained an inmate of Colston's hospital for upwards of six years, and the slight advantages gained from this scanty education are traceable to the friendly sympathy of Phillips, himself a writer of verse, who encouraged his pupils to write. Three of Chatterton's companions are named as youths whom Phillips's taste for poetry stimulated to rivalry; but Chatterton held aloof from these contests, and made at that time no confidant of his own more daring literary adventures. His little pocket-money was spent in borrowing books from a circulating library; and he early ingratiated himself with book collectors, by whose aid he found access to Weever, Dugdale and Collins, as well as to Speght's edition of Chaucer, Spenser and other books.

His "Rowleian" jargon appears to have been chiefly the result of the study of John Kersey's *Dictionary Anglo-Britannicum*, and Prof. W. W. Skeat seems to think his knowledge of even Chaucer was very slight. His holidays were mostly spent at his mother's house; and much of them in the favourite retreat of his attic study there. He had already conceived the romance of Thomas Rowley, an imaginary monk of the 15th century, and lived for the most part in an ideal world of his own, in that elder time when Edward IV. was England's king, and Master William Canynge—familiar to him among the recumbent effigies in Redcliffe church—still ruled in Bristol's civic chair. Canynge is represented as an enlightened patron of literature, and Rowley's dramatic interludes were written for

performance at his house. In order to escape a marriage urged by the king, Canynge retired to the college of Westbury in Gloucestershire, where he enjoyed the society of Rowley, and eventually became dean of the institution. In "The Storie of William Canynge," one of the shorter pieces of his ingenious romance, his early history is recorded.

"Straight was I carried back to times of yore,
 Whilst Canynge swathed yet in fleshly bed,
 And saw all actions which had been before,
 And all the scroll of Fate unravelled;
 And when the fate-marked babe acome to sight,
 I saw him eager gasping after light.
 In all his sheepen gambols and child's play,
 In every merrymaking, fair, or wake,
 I kenn'd a perpled light of wisdom's ray;
 He ate down learning with the wastel-cake;
 As wise as any of the aldermen,
 He'd wit enow to make a mayor at ten."

This beautiful picture of the childhood of the ideal patron of Rowley is in reality that of the poet himself—"the fate-marked babe," with his wondrous child-genius, and all his romantic dreams realized. The literary masquerade which thus constituted the life-dream of the boy was wrought out by him in fragments of prose and verse into a coherent romance, until the credulous scholars and antiquaries of his day were persuaded into the belief that there had lain in the parish chest of Redcliffe church for upwards of three centuries, a collection of MSS. of rare merit, the work of Thomas Rowley, an unknown priest of Bristol in the days of Henry VI. and his poet laureate, John Lydgate.

Among the Bristol patrons of Chatterton were two pewterers, George Catcott and his partner Henry Burgum. Catcott was one of the most zealous believers in Rowley, and continued to collect his reputed writings long after the death of their real author. On Burgum, who had risen in life by his own exertions, the blue-coat boy palmed off the de Bergham pedigree, and other equally apocryphal evidences of the pewterer's descent from an ancestry old as the Norman Conquest. The de Bergham quartering, blazoned on a piece of parchment doubtless recovered from the Redcliffe muniment chest, was itself supposed to have lain for centuries in that ancient depository. The pedigree was professedly collected by Chatterton from original records, including "The Rowley MSS." The pedigree still exists in Chatterton's own handwriting, copied into a book in which he had previously transcribed portions of antique verse, under the title of "Poems by Thomas Rowley, priest of St. John's, in the city of Bristol"; and in one of these, "The Tournament," Syrr Johan de Berghamme plays a conspicuous part. The ennobled pewterer rewarded Chatterton with five shillings, and was satirized for this valuation of a noble pedigree in some of Chatterton's latest verse.

On the 1st of July 1767, Chatterton was transferred to the office of John Lambert, attorney, to whom he was bound apprentice as a clerk. There he was left much alone; and after fulfilling the routine duties devolving on him, he found leisure for his own favourite pursuits. An ancient stone bridge on the Avon, built in the reign of Henry II., and altered by many later additions into a singularly picturesque but inconvenient thoroughfare, had been displaced by a structure better adapted to modern requirements. In September 1768, when Chatterton was in the second year of his apprenticeship, the new bridge was partially opened for traffic. Shortly afterwards the editor of *Felix Farley's Journal* received from a correspondent, signing himself *Dunelmus Bristolensis*, a "description of the mayor's first passing over the old bridge," professedly derived from an ancient MS. William Barrett, F.S.A., surgeon and antiquary, who was then accumulating materials for a history of Bristol, secured the original manuscript, which is now preserved in the British Museum, along with other Chatterton MSS., most of which were ultimately incorporated by the credulous antiquary into a learned quarto volume, entitled the *History and Antiquities of the City of Bristol*, published nearly twenty years after the poet's death. It was at this time that the definite story made its appearance—over

which critics and antiquaries wrangled for nearly a century—of numerous ancient poems and other MSS. taken by the elder Chatterton from a coffer in the muniment room of Redcliffe church, and transcribed, and so rescued from oblivion, by his son. The pieces include the "Bristowe Tragedie, or the Dethe of Syr Charles Bawdin," a ballad celebrating the death of the Lancastrian knight, Charles Baldwin; "Ælla," a "Tragycal Enterlude," as Chatterton styles it, but in reality a dramatic poem of sustained power and curious originality of structure; "Goddwyn," a dramatic fragment; "Tournament," "Battle of Hastings," "The Parliament of Sprites," "Balade of Charitie," with numerous shorter pieces, forming altogether a volume of poetry, the rare merit of which is indisputable, wholly apart from the fact that it was the production of a mere boy. Unfortunately for him, his ingenious romance had either to be acknowledged as his own creation, and so in all probability be treated with contempt, or it had to be sustained by the manufacture of spurious antiques. To this accordingly Chatterton resorted, and found no difficulty in gulling the most learned of his credulous dupes with his parchments.

The literary labours of the boy, though diligently pursued at his desk, were not allowed to interfere with the duties of Mr Lambert's office. Nevertheless the Bristol attorney used to search his apprentice's drawer, and tear up any poems or other manuscripts that he could lay his hands upon; so that it was only during the absences of Mr Lambert from Bristol that he was able to expend his unemployed time in his favourite pursuits. But repeated allusions, both by Chatterton and others, seem to indicate that such intervals of freedom were of frequent occurrence. Some of his modern poems, such as the piece entitled "Resignation," are of great beauty; and these, with the satires, in which he took his revenge on all the local celebrities whose vanity or meanness had excited his ire, are alone sufficient to fill a volume. The Catcotts, Burgum, Barrett and others of his patrons, figure in these satires, in imprudent yet discriminating caricature, along with mayor, aldermen, bishop, dean and other notabilities of Bristol. Towards Lambert his feelings were of too keen a nature to find relief in such sarcasm.

In December 1768, in his seventeenth year, he wrote to Dodsley, the London publisher, offering to procure for him "copies of several ancient poems, and an interlude, perhaps the oldest dramatic piece extant, wrote by one Rowley, a priest in Bristol, who lived in the reigns of Henry VI. and Edward IV." To this letter he appended the initials of his favourite pseudonym, *Dunelmus Bristolensis*, but directed the answer to be sent to the care of Thomas Chatterton, Redcliffe Hill, Bristol. To this, as well as to another letter enclosing an extract from the tragedy of "Ælla," no answer appears to have been returned. Chatterton, conceiving the idea of finding sympathy and aid at the hand of some modern Canynge, bethought him of Horace Walpole, who not only indulged in a medieval renaissance of his own, but was the reputed author of a spurious antique in the *Castle of Otranto*. He wrote to him offering him a document entitled "The Ryse of Peynceteyne yn Englande, wroten by T. Rowleie, 1469, for Mastre Canynge," accompanied by notes which included specimens of Rowley's poetry. To this Walpole replied with courteous acknowledgments. He characterized the verses as "wonderful for their harmony and spirit," and added, "Give me leave to ask you where Rowley's poems are to be had? I should not be sorry to print them; or at least a specimen of them, if they have never been printed." Chatterton replied, enclosing additional specimens of antique verse, and telling Walpole that he was the son of a poor widow, and clerk to an attorney, but had a taste for more refined studies; and he hinted a wish that he might help him to some more congenial occupation. Walpole's manner underwent an abrupt change. The specimens of verse had been submitted to his friends Gray and Mason, the poets, and pronounced modern. They did not thereby forfeit the wonderful harmony and spirit which Walpole had already professed to recognize in them. But he now coldly advised the boy to stick to the attorney's office; and "when he should have made a fortune," he might betake himself to more favourite

studies. Chatterton had to write three times before he recovered his MSS. Walpole has been loaded with more than his just share of responsibility for the fate of the unhappy poet, of whom he admitted when too late, "I do not believe there ever existed so masterly a genius."

Chatterton now turned his attention to periodical literature and politics, and exchanged *Felix Farley's Bristol Journal* for the *Town and County Magazine* and other London periodicals. Assuming the vein of Junius—then in the full blaze of his triumph—he turned his pen against the duke of Grafton, the earl of Bute, and the princess of Wales. He had just despatched one of his political diatribes to the *Middlesex Journal*, when he sat down on Easter Eve, 17th April 1770, and penned his "Last Will and Testament," a strange satirical compound of jest and earnest, in which he intimated his intention of putting an end to his life the following evening. Among his satirical bequests, such as his "humility" to the Rev. Mr Camplin, his "religion" to Dean Barton, and his "modesty" along with his "prosody and grammar" to Mr Burgum, he leaves "to Bristol all his spirit and disinterestedness, parcels of goods unknown on its quay since the days of Canynge and Rowley." In more genuine earnestness he recalls the name of Michael Clayfield, a friend to whom he owed intelligent sympathy. The will was probably purposely prepared in order to frighten his master into letting him go. If so, it had the desired effect. Lambert cancelled his indentures; his friends and acquaintance made him up a purse; and on the 25th or 26th of the month he arrived in London.

Chatterton was already known to the readers of the *Middlesex Journal* as a rival of Junius, under the *nom de plume* of Decimus. He had also been a contributor to Hamilton's *Town and County Magazine*, and speedily found access to the *Freeholder's Magazine*, another political miscellany strong for Wilkes and liberty. His contributions were freely accepted; but the editors paid little or nothing for them. He wrote in the most hopeful terms to his mother and sister, and spent his first earnings in buying gifts for them. His pride and ambition were amply gratified by the promises and interested flattery of editors and political adventurers; Wilkes himself had noted his trenchant style, "and expressed a desire to know the author"; and Lord Mayor Beckford graciously acknowledged a political address of his, and greeted him "as politely as a citizen could." But of actual money he received but little. He was extremely abstemious, his diligence was great, and his versatility wonderful. He could assume the style of Junius or Smollett, reproduce the satiric bitterness of Churchill, parody Macpherson's Ossian, or write in the manner of Pope, or with the polished grace of Gray and Collins. He wrote political letters, eclogues, lyrics, operas and satires, both in prose and verse. In June 1770—after Chatterton had been some nine weeks in London—he removed from Shoreditch, where he had hitherto lodged with a relative, to an attic in Brook Street, Holborn. But for most of his productions the payment was delayed; and now state prosecutions of the press rendered letters in the Junius vein no longer admissible, and threw him back on the lighter resources of his pen. In Shoreditch, as in his lodging at the Bristol attorney's, he had only shared a room; but now, for the first time, he enjoyed uninterrupted solitude. His bed-fellow at Mr Walmsley's, Shoreditch, noted that much of the night was spent by him in writing; and now he could write all night. The romance of his earlier years revived, and he transcribed from an imaginary parchment of the old priest Rowley his "Excelente Balade of Charitie." This fine poem, perversely disguised in archaic language, he sent to the editor of the *Town and County Magazine*, and had it rejected.

The high hopes of the sanguine boy had begun to fade. He had not yet completed his second month in London, and already failure and starvation stared him in the face. Mr Cross, a neighbouring apothecary, repeatedly invited him to join him at dinner or supper; but he refused. His landlady also, suspecting his necessity, pressed him to share her dinner, but in vain. "She knew," as she afterwards said, "that he had not eaten anything for two or three days." But he was offended at her urgency, and assured her that he was not hungry. The note of his actual

receipts, found in his pocket-book after his death, shows that Hamilton, Fell and other editors who had been so liberal in flattery, had paid him at the rate of a shilling for an article, and somewhat less than eightpence each for his songs; while much which had been accepted was held in reserve, and still unpaid for. The beginning of a new month revealed to him the indefinite postponement of the publication and payment of his work. He had wished, according to his foster-mother, to study medicine with Barrett; in his desperation he now reverted to this, and wrote to Barrett for a letter to help him to an opening as a surgeon's assistant on board an African trader. He appealed also to Mr Catcott to forward his plan, but in vain. On the 24th of August 1770, he retired for the last time to his attic in Brook Street, carrying with him the arsenic which he there drank, after tearing into fragments whatever literary remains were at hand.

He was only seventeen years and nine months old; but the best of his numerous productions, both in prose and verse, require no allowance to be made for the immature years of their author, when comparing him with the ablest of his contemporaries. He pictures Lydgate, the monk of Bury St Edmunds, challenging Rowley to a trial at versmaking, and under cover of this fiction, produces his "Songe of Ælla," a piece of rare lyrical beauty, worthy of comparison with any antique or modern production of its class. Again, in his "Tragedy of Goddwyn," of which only a fragment has been preserved, the "Ode to Liberty," with which it abruptly closes, may claim a place among the finest martial lyrics in the language. The collection of poems in which such specimens occur furnishes by far the most remarkable example of intellectual precocity in the whole history of letters. Collins, Burns, Keats, Shelley and Byron all awaken sorrow over the premature arrestment of their genius; but the youngest of them survived to his twenty-fifth year, while Chatterton was not eighteen when he perished in his miserable garret. The death of Chatterton attracted little notice at the time; for the few who then entertained any appreciative estimate of the Rowley poems regarded him as their mere transcriber. He was interred in a burying-ground attached to Shoe Lane Workhouse, in the parish of St Andrew's, Holborn, which has since been converted into a site for Farringdon Market. There is a discredited story that the body of the poet was recovered, and secretly buried by his uncle, Richard Phillips, in Redcliffe Churchyard. There a monument has since been erected to his memory, with the appropriate inscription, borrowed from his "Will," and so supplied by the poet's own pen—"To the memory of Thomas Chatterton. Reader! judge not. If thou art a Christian, believe that he shall be judged by a Superior Power. To that Power only is he now answerable."

BIBLIOGRAPHY.—*Poems supposed to have been written at Bristol by Thomas Rowley and others, in the Fifteenth Century (1777)* was edited by Thomas Tyrwhitt; Thomas Warton, in his *History of English Poetry* (1778), vol. ii. section viii., gives Rowley a place among the 15th century poets; but neither of these critics believed in the antiquity of the poems. In 1782 a new edition of Rowley's poems appeared, with a "Commentary, in which the antiquity of them is considered and defended," by Jeremiah Milles, dean of Exeter. The controversy which raged round the Rowley poems is discussed in A. Kippis, *Biographia Britannica* (vol. iv., 1789), where there is a detailed account by G. Gregory of Chatterton's life (pp. 573-619). This was reprinted in the edition (1803) of Chatterton's *Works* by R. Southey and J. Cottle, published for the benefit of the poet's sister. The neglected condition of the study of earlier English in the 18th century alone accounts for the temporary success of Chatterton's mystification. It has long been agreed that Chatterton was solely responsible for the Rowley Poems, but the language and style are analysed in confirmation of this view by Prof. W. W. Skeat in an introductory essay prefaced to vol. ii. of *The Poetical Works of Thomas Chatterton (1871)* in the "Aldine Edition of the British Poets." This, which is the most convenient edition, also contains a memoir of the poet by Edward Bell. The spelling of the Rowley poems is there modernized, and many of the archaic words are replaced by modern equivalents provided in many cases from Chatterton's own notes, the theory being that Chatterton usually composed in modern English, and inserted his peculiar words and his complicated orthography afterwards. For some criticism of Prof. Skeat's success in the very difficult task of reconstituting the text, see H. B. Forman, *Thomas Chatterton and his latest Editor (1874)*.

The Chatterton MSS., originally in the possession of William Barrett of Bristol, were left by his heir to the British Museum in 1800. Others are preserved in the Bristol library.

Chatterton's genius and his tragic death are commemorated by Shelley in *Adonais*, by Wordsworth in "Resolution and Independence," by Coleridge in "A Monody on the Death of Chatterton," by D. G. Rossetti in "Five English Poets," and John Keats inscribed *Endymion* "to the memory of Thomas Chatterton." Alfred de Vigny's drama of *Chatterton* gives an altogether fictitious account of the poet. Herbert Croft (*q.v.*), in his *Love and Madness*, interpolated a long and valuable account of Chatterton, giving many of the poet's letters, and much information obtained from his family and friends (pp. 125-244, letter li.). There is a valuable collection of "Chattertoniana" in the British Museum, consisting of separate works by Chatterton, newspaper cuttings, articles, dealing with the Rowley controversy and other subjects, with MS. notes by Joseph Haslewood, and several autograph letters.

Among biographies of Chatterton may be mentioned *Chatterton: A Biographical Study* (1869), by Daniel Wilson; *Chatterton: A Biography* (1899; first printed 1856 in a volume of essays), by D. Masson; "Thomas Chatterton" (1900), by Helene Richter, in *Wiener Beiträge zur engl. Philologie*; *Chatterton*, by C. E. Russell (1909).

CHATTI, an ancient German tribe inhabiting the upper reaches of the rivers Weser, Eder, Fulda and Werra, a district approximately corresponding to Hesse-Cassel, though probably somewhat more extensive. They frequently came into conflict with the Romans during the early years of the 1st century. Eventually they formed a portion of the Franks and were incorporated in the kingdom of Clovis probably with the Ripuarii, at the beginning of the 6th century.

Tacitus, *Annals*, i. 2, 11, 12, 13; *Germania*, 30-31; Strabo p. 291 f.

CHAUCER, GEOFFREY (? 1340-1400), English poet. The name Chaucer, a French form of the Latin *calcearius*, a shoemaker, is found in London and the eastern counties as early as the second half of the 13th century. Some of the London Chaucers lived in Cordwainer Street, in the shoemakers' quarter; several of them, however, were vintners, and among others the poet's father John, and probably also his grandfather Robert. Legal pleadings inform us that in December 1324 John Chaucer was not much over twelve years old, and that he was still unmarried in 1328, the year which used to be considered

that of Geoffrey's birth. The poet was probably born from eight to twelve years later, since in 1386, when giving evidence in Sir Richard le Scrope's suit against Sir Robert Grosvenor as to the right to bear certain arms, he was set down as "del age de xl ans et plus, armez par xxvij ans." At a later date, and probably at the time of the poet's birth, his father lived in Thames Street, and had to wife a certain Agnes, niece of Hamo de Compton, whom we may regard as Geoffrey Chaucer's mother. In 1357 Geoffrey is found, apparently as a lad, in the service of Elizabeth, countess of Ulster, wife of Lionel, duke of Clarence, entries in two leaves of her household accounts, accidentally preserved, showing that she paid in April, May and December various small sums for his clothing and expenses. In 1359, as we learn from his deposition in the Scrope suit, Chaucer went to the war in France. At some period of the campaign he was at "Retters," *i.e.* Rethel, near Reims, and subsequently had the ill luck to be taken prisoner. On the 1st of March 1360 the king contributed £16 to his ransom, and by a year or two later Chaucer must have entered the royal service, since on the 20th of June 1367 Edward granted him a pension of twenty marks for his past and future services. A pension of ten marks had been granted by the king the previous September to a Philippa Chaucer for services to the queen as one of her "domicellae" or "damoiselles," and it seems probable that at this date Chaucer was already married and this Philippa his wife, a conclusion which used to be resisted on the ground of allusions in his early poems to a hopeless love-affair, now reckoned part of his poetical outfit. Philippa is usually said to have been one of two daughters of a Sir Payne Roet, the other being Katherine, who after the death of her first husband, Sir Hugh de Swynford, in 1372, became governess to John of Gaunt's children, and subsequently his mistress and (in 1396) his wife. It is possible that Philippa was sister to Sir Hugh and sister-in-law to

Katherine. In either case the marriage helps to account for the favour subsequently shown to Chaucer by John of Gaunt.

In the grant of his pension Chaucer is called "dilectus vellectus noster," our beloved yeoman; before the end of 1368 he had risen to be one of the king's esquires. In September of the following year John of Gaunt's wife, the duchess Blanche, died at the age of twenty-nine, and Chaucer wrote in her honour *The Book of the Duchesse*, a poem of 1334 lines in octosyllabic couplets, the first of his undoubtedly genuine works which can be connected with a definite date. In June 1370 he went abroad on the king's service, though on what errand, or whither it took him, is not known. He was back probably some time before Michaelmas, and seems to have remained in England till the 1st of December 1372, when he started, with an advance of 100 marks in his pocket, for Italy, as one of the three commissioners to treat with the Genoese as to an English port where they might have special facilities for trade. The accounts which he delivered on his return on the 23rd of May 1373 show that he had also visited Florence on the king's business, and he probably went also to Padua and there made the acquaintance of Petrarch.

In the second quarter of 1374 Chaucer lived in a whirl of prosperity. On the 23rd of April the king granted him a pitcher of wine daily, subsequently commuted for an annuity of 20 marks. From John of Gaunt, who in August 1372 had granted Philippa Chaucer £10 a year, he himself now received (June 13) a like annuity in reward for his own and his wife's services. On the 8th of June he was appointed Comptroller of the Custom and Subsidy of Wools, Hides and Woodfells and also of the Petty Customs of Wine in the Port of London. A month before this appointment, and probably in anticipation of it, he took (May 10, 1374) a lease for life from the city of London of the dwelling-house above the gate of Aldgate, and here he lived for the next twelve years. His own and his wife's income now amounted to over £60, the equivalent of upwards of £1000 in modern money. In the next two years large windfalls came to him in the form of two wardships of Kentish heirs, one of whom paid him £104, and a grant of £71: 4: 6; the value of some confiscated wool. In December 1376 he was sent abroad on the king's service in the retinue of Sir John Burley; in February 1377 he was sent to Paris and Montreuil in connexion probably with the peace negotiations between England and France, and at the end of April (after a reward of £20 for his good services) he was again despatched to France.

On the accession of Richard II. Chaucer was confirmed in his offices and pensions. In January 1378 he seems to have been in France in connexion with a proposed marriage between Richard and the daughter of the French king; and on the 28th of May of the same year he was sent with Sir Edward de Berkeley to the lord of Milan and Sir John Hawkwood to treat for help in the king's wars, returning on the 19th of September. This was his last diplomatic journey, and the close of a period of his life generally considered to have been so unproductive of poetry that little beyond the Clerk's "Tale of Grisilde," one or two other of the stories afterwards included in the *Canterbury Tales*, and a few short poems, are attributed to it, though the poet's actual absences from England during the eight years amount to little more than eighteen months. During the next twelve or fifteen years there is no question that Chaucer was constantly engaged in literary work, though for the first half of them he had no lack of official employment. Abundant favour was shown him by the new king. He was paid £22 as a reward for his later missions in Edward III.'s reign, and was allowed an annual gratuity of 10 marks in addition to his pay of £10 as comptroller of the customs of wool. In April 1382 a new comptrollership, that of the petty customs in the Port of London, was given him, and shortly after he was allowed to exercise it by deputy, a similar licence being given him in February 1385, at the instance of the earl of Oxford, as regards the comptrollership of wool. In October 1385 Chaucer was made a justice of the peace for Kent. In February 1386 we catch a glimpse of his wife Philippa being admitted to the fraternity of Lincoln cathedral in the company of Henry, earl of

Derby (afterwards Henry IV.), Sir Thomas de Swynford and other distinguished persons. In August 1386 he was elected one of the two knights of the shire for Kent, and with this dignity, though it was one not much appreciated in those days, his good fortune reached its climax. In December of the same year he was superseded in both his comptrollerships, almost certainly as a result of the absence of his patron, John of Gaunt, in Spain, and the supremacy of the duke of Gloucester. In the following year the cessation of Philippa's pension suggests that she died between Midsummer and Michaelmas. In May 1388 Chaucer surrendered to the king his two pensions of 20 marks each, and they were re-granted at his request to one John Scalby. The transaction was unusual and probably points to a pressing need for ready money, nor for the next fourteen months do we know of any source of income possessed by Chaucer beyond his annuity of £10 from John of Gaunt.

In July 1389, after John of Gaunt had returned to England, and the king had taken the government into his own hands, Chaucer was appointed clerk of the works at various royal palaces at a salary of two shillings a day, or over £31 a year, worth upwards of £500 present value. To this post was subsequently added the charge of some repairs at St George's Chapel, Windsor. He was also made a commissioner to maintain the banks of the Thames between Woolwich and Greenwich, and was given by the earl of March (grandson of Lionel, duke of Clarence, his old patron) a sub-forestership at North Petherton, Devon, obviously a sinecure. While on the king's business, in September 1390, Chaucer was twice robbed by highwaymen, losing £20 of the king's money. In June 1391 he was superseded in his office of clerk of the works, and seems to have suffered another spell of misfortune, of which the first alleviation came in January 1393 when the king made him a present of £10. In February 1394 he was granted a new pension of £20. It is possible, also, that about this time, or a little later, he was in the service of the earl of Derby. In 1397 he received from King Richard a grant of a butt of wine yearly. For this he appears to have asked in terms that suggest poverty, and in May 1398 he obtained letters of protection against his creditors, a step perhaps rendered necessary by an action for debt taken against him earlier in the year. On the accession of Henry IV. a new pension of 40 marks was conferred on Chaucer (13th of October 1399) and Richard II.'s grants were formally confirmed. Henry himself, however, was probably straitened for ready money, and no instalment of the new pension was paid during the few months of his reign that the poet lived. Nevertheless, on the strength of his expectations, on the 24th of December 1399 he leased a tenement in the garden of St Mary's Chapel, Westminster, and it was probably here that he died, on the 25th of the following October. He was buried in Westminster Abbey, and his tomb became the nucleus of what is now known as Poets' Corner.

The portrait of Chaucer, which the affection of his disciple, Thomas Hoccleve, caused to be painted in a copy of the latter's *Regement of Princes* (now Harleian MS. 4866 in the British Museum), shows him an old man with white hair; he has a fresh complexion, grey eyes, a straight nose, a grey moustache and a small double-pointed beard. His dress and hood are black, and he carries in his hands a string of beads. We may imagine that it was thus that during the last months of his life he used to walk about the precincts of the Abbey.

Henry IV.'s promise of an additional pension was doubtless elicited by the *Compleynt to his Purs*, in the envoy to which

Chaucer addresses him as the "conquerour of Brutes Albioun." Thus within the last year of his life the poet was still writing. Nevertheless, as early as 1393-1394, in lines to his friend Scogan, he had written as if his day for poetry were past, and it seems probable that his longer poems were all composed before this date. In the preceding fifteen—or, if another view be taken, twenty—years, his literary activity was very great, and with the aid of the lists of his works which he gives in the *Legende of Good Women* (lines 414-431), and the talk on the road which precedes the "Man of Law's Tale" (*Canterbury Tales*, B. 46-76), the order in which his main works were written

can be traced with approximate certainty,¹ while a few both of these and of the minor poems can be connected with definite dates.

The development of his genius has been attractively summed up as comprised in three stages, French, Italian and English, and there is a rough approximation to the truth in this formula, since his earliest poems are translated from the French or based on French models, and the two great works of his middle period are borrowed from the Italian, while his latest stories have no such obvious and direct originals and in their humour and freedom anticipate the typically English temper of Henry Fielding. But Chaucer's indebtedness to French poetry was no passing phase. For various reasons—a not very remote French origin of his own family may be one of them—he was in no way interested in older English literature or in the work of his English contemporaries, save possibly that of "the moral Gowr." On the other hand he knew the *Roman de la rose* as modern English poets know Shakespeare, and the full extent of his debt to his French contemporaries, not merely in 1369, but in 1385 and in 1393 (the dates are approximate), is only gradually being discovered. To be in touch throughout his life with the best French poets of the day was much for Chaucer. Even with their stimulus alone he might have developed no small part of his genius. But it was his great good fortune to add to this continuing French influence, lessons in plot and construction derived from Boccaccio's *Filostrato* and *Teseide*, as well as some glimpses of the higher art of the *Divina Commedia*. He shows acquaintance also with one of Petrarch's sonnets, and though, when all is said, the Italian books with which he can be proved to have been intimate are but few, they sufficed. His study of them was but an episode in his literary life, but it was an episode of unique importance. Before it began he had already been making his own artistic experiments, and it is noteworthy that while he learnt so much from Boccaccio he improved on his originals as he translated them. Doubtless his busy life in the service of the crown had taught him self-confidence, and he uses his Italian models in his own way and with the most triumphant and assured success. When he had no more Italian poems to adapt he had learnt his lesson. The art of weaving a plot out of his own imagination was never his, but he could take what might be little more than an anecdote and lend it body and life and colour with a skill which has never been surpassed.

The most direct example of Chaucer's French studies is his translation of *Le Roman de la rose*, a poem written in some 4000 lines by Guillaume Lorris about 1237 and extended to over 22,000 by Jean Clopinel, better known as Jean de Meun, forty years later. We know from Chaucer himself that he translated this poem, and the extant English fragment of 7698 lines was generally assigned to him from 1532, when it was first printed, till its authorship was challenged in the early years of the Chaucer Society. The ground of this challenge was its wide divergence from Chaucer's practice in his undoubtedly genuine works as to certain niceties of rhyme, notable as to not rhyming words ending in -y with others ending -ye. It was subsequently discovered, however, that the whole fragment was divisible linguistically into three portions, of which the first and second end respectively at lines 1705 and 5810, and that in the first of these three sections the variations from Chaucer's accepted practice are insignificant. Lines 1-1705 have therefore been provisionally accepted as Chaucer's, and the other two fragments as the work of unknown translators (James I. of Scotland has been suggested as one of them), which somehow came to be pieced together. If, however, the difficulties in the way of this theory are less than those which confront any other, they are still considerable, and the question can hardly be treated as closed.

While our knowledge of Chaucer's *Romaunt of the Rose* is in this unsatisfactory state, another translation of his from the French, the *Book of the Lyon* (alluded to in the "Retraction" found, in some manuscripts, at the end of the *Canterbury Tales*), which must certainly have been taken from Guillaume

¹ The positions of the *House of Fame* and *Palamon and Arcyte* are still matters of controversy.

Machault's *Le Dit d'Ulion*, has perished altogether. The strength of French influence on Chaucer's early work may, however, be amply illustrated from the first of his poems with which we are on sure ground, the *Book of the Duchesse*, or, as it is alternatively called, the *Deth of Blaunche*. Here not only are individual passages closely imitated from Machault and Froissart, but the dream, the May morning, and the whole machinery of the poem are taken over from contemporary French conventions. But even at this stage Chaucer could prove his right to borrow by the skill with which he makes his materials serve his own purpose, and some of the lines in the *Deth of Blaunche* are among the most tender and charming he ever wrote.

Chaucer's *A.B.C.*, a poem in honour of the Blessed Virgin, of which the stanzas begin with the successive letters of the alphabet, is another early example of French influence. It is taken from the *Pèlerinage de la vie humaine*, written by Guillaume de Deguilleville about 1330. The occurrence of some magnificent lines in Chaucer's version, combined with evidence that he did not yet possess the skill to translate at all literally as soon as rhymes had to be considered, accounts for this poem having been dated sometimes earlier than the *Book of the Duchesse*, and sometimes several years later. With it is usually moved up and down, though it should surely be placed in the 'seventies, the *Compleynt to Pity*, a fine poem which yet, from its slight obscurity and absence of Chaucer's usual ease, may very well some day prove to be a translation from the French.

While Chaucer thus sought to reproduce both the matter and the style of French poetry in England, he found other materials in popular Latin books. Among his lost works are renderings of "Origenes upon the Maudeleyne," and of Pope Innocent III. on "The Wreced Engendring of Mankinde" (*De miseria conditionis humanae*). He must have begun his attempts at straightforward narrative with the *Lyf of Seynt Cecyle* (the weakest of all his works, the second Nun's Tale in the Canterbury series) from the *Legenda Aurea* of Jacobus de Voragine, and the story of the patience of Grisilde, taken from Petrarch's Latin version of a tale by Boccaccio. In both of these he condenses a little, but ventures on very few changes, though he lets his readers see his impatience with his originals. In his story of Constance (afterwards ascribed to the Man of Law), taken from the Anglo-Norman chronicle of Nicholas Trivet, written about 1334, we find him struggling to put some substance into another weak tale, but still without the courage to remedy its radical faults, though here, as with Grisilde, he does as much for his heroine as the conventional exaltation of one virtue at a time permitted. It is possible that other tales which now stand in the Canterbury series were written originally at this period. What is certain is that at some time in the 'seventies three or four Italian poems passed into Chaucer's possession, and that he set to work busily to make use of them. One of the most interesting of the poems reclaimed for him by Professor Skeat is a fragmentary "Compleynt," part of which is written in *terza rima*. While he thus experimented with the metre of the *Divina Commedia*, he made his first attempt to use the material provided by Boccaccio's *Teseide* in another fragment of great interest, that of *Queene Anelida and Fals Arcyte*. More than a third of this is taken up with another, and quite successful, metrical experiment in Anelida's "compleynt," but in the introduction of Anelida herself Chaucer made the first of his three unsuccessful efforts to construct a plot for an important poem out of his own head, and the fragment which begins so well breaks off abruptly at line 357.

For a time the *Teseide* seems to have been laid aside, and it was perhaps at this moment, in despondency at his failure, that Chaucer wrote his most important prose work, the translation of the *De Consolatione Philosophiae* of Boethius. Reminiscences of this helped to enrich many of his subsequent poems, and inspired five of his shorter pieces (*The Former Age, Fortune, Truth, Gentillesse and Lak of Stedfastnesse*), but the translation itself was only a partial success. To borrow his own phrase, his "Englysh was insufficient" to reproduce such difficult Latin. The translation is often barely intelligible without the original,

and it is only here and there that it flows with any ease or rhythm.

If Chaucer felt this himself he must have been speedily consoled by achieving in *Troilus and Criseyde* his greatest artistic triumph. Warned by his failure in *Anelida and Arcyte*, he was content this time to take his plot unaltered from the *Filostrato*, and to follow Boccaccio step by step through the poem. But he did not follow him as a mere translator. He had done his duty manfully for the saints "of other holinesse" in *Cecyle*, *Grisilde* and *Constance*, whom he was forbidden by the rules of the game to clothe with complete flesh and blood. In this great love-story there were no such restrictions, and the characters which Boccaccio's treatment left thin and conventional became in Chaucer's hands convincingly human. No other English poem is so instinct with the glory and tragedy of youth, and in the details of the story Chaucer's gifts of vivid colouring, of humour and pity, are all at their highest.

An unfortunate theory that the reference in the *Legende of Good Women* to "al the love of Palamon and Arcyte" is to a hypothetical poem in seven-line stanzas on this theme, which Chaucer is imagined, when he came to plan the *Canterbury Tales*, to have suppressed in favour of a new version in heroic couplets, has obscured the close connexion in temper and power between what we know as the "Knight's Tale" and the *Troilus*. The poem may have been more or less extensively revised before, with admirable fitness, it was assigned to the Knight, but that its main composition can be separated by several years from that of *Troilus* is aesthetically incredible. Chaucer's art here again is at its highest. He takes the plot of Boccaccio's *Teseide*, but only as much of it as he wants, and what he takes he heightens and humanizes with the same skill which he had shown in transforming the *Filostrato*. Of the individual characters Theseus himself, the arbiter of the plot, is most notably developed; Emilie and her two lovers receive just as much individuality as they will bear without disturbing the atmosphere of romance. The whole story is pulled together and made more rapid and effective. A comparison of almost any scene as told by the two poets suffices to show Chaucer's immense superiority. At some subsequent period the "Squire's Tale" of Cambuscan, the fair Canacee and the Horse of Brass, was gallantly begun in something of the same key, but Chaucer took for it more materials than he could use, and for lack of the help of a leader like Boccaccio he was obliged to leave the story, in Milton's phrase, "half-told," though the fragment written certainly takes us very much less than half-way.

Meanwhile, in connexion (as is reasonably believed) with the betrothal or marriage of Anne of Bohemia to Richard II. (*i.e.* about 1381-1382), Chaucer had brought to a successful completion the *Parlement of Foules*, a charming sketch of 699 lines, in which the other birds, on Saint Valentine's day, counsel the "Formel Egle" on her choice of a mate. His success here, as in the case of the *Deth of Blaunche the Duchesse*, was due to the absence of any need for a climax; and though the materials which he borrowed were mainly Latin (with some help from passages of the *Teseide* not fully needed for *Palamon and Arcyte*) his method of handling them would have been quite approved by his friends among the French poets. A more ambitious venture, the *Hous of Fame*, in which Chaucer imagines himself borne aloft by an eagle to Fame's temple, describes what he sees and hears there, and then breaks off in apparent inability to get home, shows a curious mixture of the poetic ideals of the *Roman de la rose* and reminiscences of the *Divina Commedia*.

As the *Hous of Fame* is most often remembered and quoted for the personal touches and humour of Chaucer's conversation with the eagle, so the most-quoted passages in the Prologue to the *Legende of Good Women* are those in which Chaucer professes his affection for the daisy, and the attack on his loyalty by Cupid and its defence by Alceste. Recent discoveries have shown, however, that (besides obligations to Machault) some of the touches about the daisy and the controversy between the partisans of the Flower and of the Leaf are snatches from poems by his friends Froissart and Deschamps, which Chaucer takes up

and returns to them with pretty compliments, and that he was indebted to Froissart for some of the framework of his poem.¹ Both of the two versions of the Prologue to the *Legende* are charming, and some of the tales, notably that of Cleopatra, rank with Chaucer's best work. When, however, he had written eight and part of the ninth he tired of his scheme, which was planned to celebrate nineteen of Cupid's faithful "saints," with Alcestis as their queen. With his usual hopefulness he had overlooked the risk of monotony, which obviously weighed heavily on him ere he broke off, and the loss of the other ten stories is less to be regretted than that of the celebration of Alceste, and a possible epilogue which might have exceeded in charm the Prologue itself.

Chaucer's failure to complete the scheme of the *Legende of Good Women* may have been partly due to the attractions of the

Canterbury Tales.

Canterbury Tales, which were probably taken up in immediate succession to it. His guardianship of two Kentish wards, his justiceship of the peace, his representing the county in the parliament of 1386, his commissionership of the river-bank between Greenwich and Woolwich, all make it easy to understand his dramatic use of the merry crowds he saw on the Canterbury road, without supposing him to have had recourse to Boccaccio's *Decamerone*, a book which there is no proof of his having seen. The pilgrims whom he imagines to have assembled at the Tabard Inn in Southwark, where Harry Bailey was host, are said to have numbered "wel nyne and twenty in a company," and the Prologue gives full-length sketches of a Knight, a Squire (his son), and their Yeoman; of a Prioress, Monk, Friar, Oxford Clerk, and Parson, with two disreputable hangers-on of the church, a Summoner and Pardoner; of a Serjeant-at-Law and a Doctor of Physic, and of a Franklin, or country gentleman, Merchant, Shipman, Miller, Cook, Manciple, Reeve, Ploughman (the Parson's brother) and the ever-famous Wife of Bath. Five London burgesses are described in a group, and a Nun and Priest² are mentioned as in attendance on the Prioress. Each of these, with Chaucer himself making the twenty-ninth, was pledged to tell two tales, but including one second attempt and a tale told by the Yeoman of a Canon, who overtakes the pilgrims on the road, we have only twenty finished stories, two unfinished and two interrupted ones. As in the case of the *Legende of Good Women*, our loss is not so much that of the additional stories as of the completed framework. The wonderful character sketches of the Prologue are carried yet farther by the Talks on the Road which link the different tales, and two of these Talks, in which the Wife of Bath and the Pardoner respectively edify the company, have the importance of separate Tales, but between the Tales that have come down to us there are seven links missing,³ and it was left to a later and weaker hand to narrate, in the "Tale of Beryn," the adventures of the pilgrims at Canterbury.

The reference to the *Lyf of Seynt Cecyle* in the Prologue to the *Legende of Good Women* gives external proof that Chaucer included earlier work in the scheme of the *Canterbury Tales*, and mention has been made of other stories which are indisputably early. In the absence of any such metrical tests as have

¹ The French influences on this Prologue, its connexion with the Flower and the Leaf controversy, and the priority of what had previously been reckoned as the second or "B" form of the Prologue over the "A," were demonstrated in papers by Prof. Kittredge on "Chaucer and some of his Friends" in *Modern Philology*, vol. i. (Chicago, 1903), and by Mr J. L. Lowes on "The Prologue to the Legend of Good Women" in *Publications of the Modern Language Association of America*, vol. xix., December 1904.

² The Talks on the Road show clearly that only one Priest in attendance on the Prioress, and two tales to each narrator, were originally contemplated, but the "Prestes thre" in line 164 of the Prologue, and the bald couplet (line 793 sq.) explaining that each pilgrim was to tell two tales *each way*, were probably both alterations made by Chaucer in moments of amazing hopefulness. The journey was reckoned a 3½ days' ride, and eight or nine tales a day would surely have been a sufficient allowance.

³ The absence of these links necessitates the division of the *Canterbury Tales* into nine groups, to which, for purposes of quotation, the letters A to I have been assigned, the line numeration of the Tales in each group being continuous.

proved useful in the case of Shakespeare, the dates at which several of the Tales were composed remain doubtful, while in the case of at least two, the Clerk's tale of Grisilde and the Monk's tragedies, there is evidence of early work being revised and supplemented. It is fortunately impossible to separate the prologue to the charmingly told story of "yonge Hugh of Lincoln" from the tale itself, and with the "quod sche" in the second line as proof that Chaucer was here writing specially for his Prioress we are forbidden to limit the new stories to any one metre or tone. There can be no doubt, however, that what may be called the Tales of the Churls (Miller, Reeve, Summoner, Friar, &c.), and the conversational outpourings of the Pardoner and Wife of Bath, form, with the immortal Prologue, the most important and distinctive additions to the older work. In these, and in the Pardoner's story of Death and the Three Revellers, and the Nun's Priest's masterly handling of the fable of the Cock and Fox, both of them free from the grossness which marks the others, Chaucer takes stories which could have been told in a short page of prose and elaborates them with all the skill in narration which he had sedulously cultivated. The conjugal reminiscences of the Wife of Bath and the Reeve's Tale with its abominable climax (lightened a little by Aleyn's farewell, lines 316-319) are among the great things in Chaucer, as surely as *Troilus*, and *Palamon and Arcyle* and the *Prologue*. They help notably to give him the width of range which may certainly be claimed for him.

In or soon after 1391 Chaucer wrote in prose for an eleven-year-old reader, whom he addresses as "Litel Lewis my son," a treatise on the use of the Astrolabe, its short prologue being the prettiest specimen of his prose. The wearisome tale of "Melibee and his wyf Prudence," which was perhaps as much admired in English as it had been in Latin and French, may have been translated at any time. The sermon on Penitence, used as the Parson's Tale, was probably the work of his old age. "Envoys" to his friends Scogan and Bukton, a translation of some balades by Sir Otes de Granson, and the *Compleynt to his Purs* complete the record of his minor poetry. We have his own statement that in his youth he had written many Balades, Roundels and Virelayes in honour of Love, and the two songs embedded respectively in the *Parlement of Foules* and the Prologue to the *Legende of Good Women* are charming and musical. His extant shorter poems, however, whether early or late, offer no excuse for claiming high rank for him as a lyricist. He had very little sheer singing power, and though there are fine lines in his short poems, witness the famous "Flee fro the prees and dwell with soothfastnesse," they lack the sustained concentration of great work. From the drama, again, Chaucer was cut off, and it is idle to argue from the innumerable dramatic touches in his poems and his gift of characterization as to what he might have done had he lived two centuries later. His own age delighted in stories, and he gave it the stories it demanded invested with a humanity, a grace and strength which place him among the world's greatest narrative poets, and which bring the England of his own day, with all the colour and warmth of life, wonderfully near to all his readers.

The part played by Chaucer in the development of the English language has often been overrated. He neither corrupted it, as used to be said, by introducing French words which it would otherwise have avoided, nor bore any such *Influence* part in fixing it as was afterwards played by the translators of the Bible. When he was growing up educated society in England was still bilingual, and the changes in vocabulary and pronunciation which took place during his life were the natural results of a society, which had been bilingual with a bias towards French, giving an exclusive preference to English. The practical identity of Chaucer's language with that of Gower shows that both merely used the best English of their day with the care and slightly conservative tendency which befitted poets. Chaucer's service to the English language lies in his decisive success having made it impossible for any later English poet to attain fame, as Gower had done, by writing alternately in Latin and French. The claim which should be made for him is

that, at least as regards poetry, he proved that English was "sufficient."

Chaucer borrowed both his stanza forms and his "decasyllabic" couplets (mostly with an extra syllable at the end of the line) from Guillaume Machault, and his music, like that of his French master and his successors, depends very largely on assigning to every syllable its full value, and more especially on the due pronunciation of the final *-e*. The slower movement of change in Scotland allowed time for Chaucer to exercise a potent influence on Scottish poetry, but in England this final *-e*, to which most of the earlier grammatical forms by Chaucer's time had been reduced, itself fell rapidly into disuse during the 15th century, and a serious barrier was thus raised to the appreciation of the artistic value of his verse. His disciples, Hoccleve and Lydgate, who at first had caught some echoes of his rhythms, gradually yielded to the change in pronunciation, so that there was no living tradition to hand down his secret, while successive copyists reduced his text to a state in which it was only by accident that lines could be scanned correctly. For fully three centuries his reputation was sustained solely by his narrative power, his warmest panegyrists betraying no consciousness that they were praising one of the greatest technical masters of poetry. Even when thus maimed, however, his works found readers and lovers in every generation, and every improvement in his text has set his fame on a surer basis.

BIBLIOGRAPHY.—The *Canterbury Tales* have always been Chaucer's most popular work, and, including fragments, upwards of sixty 15th-century manuscripts of it still survive. Two thin volumes of his minor poems were among the little quartos which Caxton printed by way of advertisement immediately on his return to England; the *Canterbury Tales* and *Boethius* followed in 1478, *Troilus* and a second edition of the *Tales* in 1483, the *Hous of Fame* in 1484. The *Canterbury Tales* were subsequently printed in 1492 (Pynson), 1498 (de Worde) and 1526 (Pynson); *Troilus* in 1517 (de Worde) and 1526 (Pynson); the *Hous of Fame* in 1526 (Pynson); the *Parlement of Foules* in 1526 (Pynson) and 1530 (de Worde), and the *Mars*, "*Venus*" and *Envoiy to Bukton* by Julyan Notary about 1500. Pynson's three issues in 1526 almost amounted to a collected edition, but the first to which the title *The Workes of Geffray Chaucer* was given was that edited by William Thynne in 1532 for Thomas Godfray. Of this there was a new edition in 1542 for John Reynes and William Bonham, and an undated reprint a few years later for Bonham, Kele, Petit and Toye, each of whom put his name on part of the edition. In 1561 a reprint, with numerous additions, edited by John Stowe, was printed by J. Kyngston for J. Wight, and this was re-edited, with fresh additions by Thomas Speght, in 1598 for G. Bishop and again in 1602 for Adam Islip. In 1687 there was an anonymous reprint, and in 1721 John Urry produced the last and worst of the folios. By this time the paraphrasers were already at work, Dryden rewriting the tales of the Knight, the Nun's Priest and the Wife of Bath, and Pope the Merchant's. In 1737 (reprinted in 1740) the Prologue and Knight's Tale were edited (anonymously) by Thomas Morell "from the most authentic manuscripts," and here, though by dint of much violence and with many mistakes, Chaucer's lines were for the first time in print given in a form in which they could be scanned. This promise of better things (Morell still thought it necessary to accompany his text with the paraphrases by Betterton and Dryden) was fulfilled by a fine edition of the *Canterbury Tales* (1775-1778), in which Thomas Tyrwhitt's scholarly instincts produced a comparatively good text from second-rate manuscripts and accompanied it with valuable illustrative notes. The next edition of any importance was that edited by Thomas Wright for the Percy Society in 1848-1851, based on the erratic but valuable British Museum manuscript Harley 7334, containing readings which must be either Chaucer's second thoughts or the emendations of a brilliantly clever scribe. In 1866 Richard Morris re-edited this text in a more scholarly manner for the Aldine edition of the British Poets, and in the following year produced for the Clarendon Press Series a school edition of the Prologue and Tales of the Knight and Nun's Priest, edited with the fulness and care previously bestowed only on Greek and Latin classics.

In 1868 the foundation of the Chaucer Society, with Dr Furnivall as its director and chief worker, and Henry Bradshaw as a leading spirit, led to the publication of a six-text edition of the *Canterbury Tales*, and the consequent discovery that a manuscript belonging to the Earl of Ellesmere, though undoubtedly "edited," contained the best available text. The Chaucer Society also printed the best manuscripts of *Troilus* and *Criseyde* and of all the minor poems, and thus cleared the way for the "Oxford" Chaucer, edited by Professor Skeat, with a wealth of annotation, for the Clarendon Press in 1894, the text of which was used for the splendid folio printed two years later by William Morris at the Kelmscott Press, with illustrations by Sir Edward Burne-Jones. A supplementary volume

of the Oxford edition, entitled *Chaucerian and other Pieces*, issued by Professor Skeat in 1897, contains the prose and verse which his early publishers and editors, from Pynson and Thynne onwards, included among his Works by way of illustration, but which had gradually come to be regarded as forming part of his text. The reasons for their rejection are fully stated by Professor Skeat in the work named and also in *The Chaucer Canon* (1900). Many of these pieces have now been traced to other authors, and their exclusion has helped to clear not only Chaucer's text but also his biography, which used (as in the "Life" published by William Godwin in two quarto volumes in 1803) to be encumbered with inferences from works now known not to be Chaucer's, notably the *Testament of Love* written by Thomas Usk. All information about Chaucer's life available in 1900 will be found summarized by Mr R. E. G. Kirk in *Life-Records of Chaucer*, part iv., published by the Chaucer Society in that year. See also *Chaucer; a Bibliographical Manual*, by Eleanor P. Hammond (1909). (A. W. Po.)

CHAUDESAIGUES, a village of central France, in the department of Cantal, at the foot of the mountains of Aubrac, 19 m. S.S.W. of St Flour by road. Pop. (1906) town, 937; commune, 1558. It is celebrated for its hot mineral springs, which vary in temperature from 135° to 177° Fahr., and at their maximum rank as the hottest in France. The water, which contains bicarbonate of soda, is employed not only medicinally (for rheumatism, &c.), but also for the washing of fleeces, the incubation of eggs, and various other economic purposes; and it furnishes a ready means of heating the houses of the town during winter. In the immediate neighbourhood is the cold chalybeate spring of Condamine. The warm springs were known to the Romans, and are mentioned by Sidonius Apollinaris.

CHAUFFEUR (from Fr. *chauffer*, to heat, a term primarily used in French of a man in charge of a forge or furnace, and so of a stoker on a locomotive or in a steamship, but in its anglicized sense more particularly confined to a professional driver of a motor vehicle. (See also BRIGANDAGE.)

CHAULIEU, GUILLAUME AMFRYE DE (1639-1720), French poet and wit, was born at Fontenay, Normandy, in 1639. His father, *maître des comptes* of Rouen, sent him to study at the Collège de Navarre. Guillaume early showed the wit that was to distinguish him, and gained the favour of the duke of Vendôme, who procured for him the abbey of Aumale and other benefices. Louis Joseph, duke of Vendôme, and his brother Philippe, grand prior of the Knights of Malta in France, at that time had a joint establishment at the Temple, where they gathered round them a very gay and reckless circle. Chaulieu became the constant companion and adviser of the two princes. He made an expedition to Poland in the suite of the marquis de Béthune, hoping to make a career for himself in the court of John Sobieski; he saw one of the Polish king's campaigns in Ukraine, but returned to Paris without securing any advancement. Saint-Simon says that the abbé helped his patron the grand prior to rob the duke of Vendôme, and that the king sent orders that the princes should take the management of their affairs from him. This account has been questioned by Sainte-Beuve, who regards Saint-Simon as a prejudiced witness. In his later years Chaulieu spent much time at the little court of the duchesse du Maine at Sceaux. There he became the trusted and devoted friend of Mdlle Delaunay, with whom he carried on an interesting correspondence. Among his poems the best known are "Fontenay" and "La Retraite." Chaulieu died on the 27th of June 1720.

His works were edited with those of his friend the marquis de la Fare in 1714, 1750 and 1774. See also C. A. Sainte-Beuve, *Causeries du lundi*, vol. i.; and *Lettres inédites* (1850), with a notice by Raymond, marquis de Berenger.

CHAUMETTE, PIERRE GASPARD (1763-1794), French revolutionist, was born at Nevers. Until the Revolution he lived a somewhat wandering life, interesting himself particularly in botany. He was a student of medicine at Paris in 1790, became one of the orators of the club of the Cordeliers, and contributed anonymously to the *Révolutions de Paris*. As member of the insurrectionary Commune of the 10th of August 1792, he was delegated to visit the prisons, with full power to arrest suspects. He was accused later of having taken part in the massacres of September, but was able to prove that at that time he had been sent by the provisional executive council to Normandy to oversee a requisition of 60,000 men. Returning

from this mission, he pronounced an eloquent discourse in favour of the republic. His simple manners, easy speech, ardent temperament and irreproachable private life gave him great influence in Paris, and he was elected president of the Commune, defending the municipality in that capacity at the bar of the Convention on the 31st of October 1792. Re-elected in the municipal elections of the 2nd of December 1792, he was soon charged with the functions of procurator of the Commune, and contributed with success to the enrolments of volunteers by his appeals to the populace. Chaumette was one of the ringleaders in the attacks of the 31st of May and of the 2nd of June 1793 on the Girondists, toward whom he showed himself relentless. He demanded the formation of a revolutionary army, and preached the extermination of all traitors. He was one of the promoters of the worship of Reason, and on the 10th of November 1793 he presented the goddess to the Convention in the guise of an actress. On the 23rd of the same month he obtained a decree closing all the churches of Paris, and placing the priests under strict surveillance; but on the 25th he retraced his steps and obtained from the Commune the free exercise of worship. He wished to save the Hébertists by a new insurrection and struggled against Robespierre; but a revolutionary decree promulgated by the Commune on his demand was overthrown by the Convention. Robespierre had him accused with the Hébertists; he was arrested, imprisoned in the Luxembourg, condemned by the Revolutionary tribunal and executed on the 13th of April 1794. Chaumette's career had its brighter side. He was an ardent social reformer; he secured the abolition of corporal punishment in the schools, the suppression of lotteries, of houses of ill-fame and of obscene literature; he instituted reforms in the hospitals, and insisted on the honours of public burial for the poor.

Chaumette left some printed speeches and fragments, and memoirs published in the *Amateur d'autographes*. His memoirs on the 10th of August were published by F. A. Aulard, preceded by a biographical study.

CHAUMONT-EN-BASSIGNY, a town of eastern France, capital of the department of Haute-Marne, a railway junction 163 m. E.S.E. of Paris on the main line of the Eastern railway to Belfort. Pop. (1906) 12,089. Chaumont is picturesquely situated on an eminence between the rivers Marne and Suize in the angle formed by their confluence. To the west a lofty viaduct over the Suize carries the railway. The church of St-Jean-Baptiste dates from the 13th century, the choir and lateral chapels belonging to the 15th and 16th. In the interior the sculptured triforium (15th century), the spiral staircase in the transept and a Holy Sepulchre are of interest. The lycée and the hospital have chapels of the 17th and 16th centuries respectively. The Tour Hautefeuille (a keep of the 11th century) is the principal relic of a château of the counts of Champagne; the rest of the site is occupied by the law courts. In the Place de l'Escargot stands a statue of the chemist Philippe Lebon (1767-1804), born in Haute-Marne. Chaumont is the seat of a prefect and of a court of assizes, and has tribunals of first instance and of commerce, a lycée, training colleges, and a branch of the Bank of France. The main industries are glove-making and leather-dressing. The town has trade in grain, iron, mined in the vicinity, and leather. In 1900 it received a charter from the counts of Champagne. It was here that in 1814 Great Britain, Austria, Russia and Prussia concluded the treaty (dated March 1, signed March 9) by which they severally bound themselves not to conclude a separate peace with Napoleon, and to continue the war until France should have been reduced within the boundaries of 1792.

CHAUNCEY, ISAAC (1772-1840), American naval commander, was born at Black Rock, Connecticut, on the 20th of February 1772. He was brought up in the merchant service, and entered the United States navy as a lieutenant in 1798. His first services were rendered against the Barbary pirates. During these operations, more especially at Tripoli, he greatly distinguished himself, and was voted by Congress a sword of honour, which, however, does not appear to have been given him. The most active period of his life is that of his command on the Lakes during

the War of 1812. He took the command at Sackett's Harbor on Lake Ontario in October 1812. There was at that time only one American vessel, the brig "Oneida" (16), and one armed prize, a schooner, on the lake. But Commodore Chauncey brought from 400 to 500 officers and men with him, and local resources for building being abundant, he had by November formed a squadron of ten vessels, with which he attacked the Canadian port, York, taking it in April 1813, capturing one vessel and causing the destruction of another then building. He returned to Sackett's Harbor. In May Sir James Lucas Yeo (1732-1818) came out from England with some 500 officers and men, to organize a squadron for service on the Lakes. By the end of the month he was ready for service with a squadron of eight ships and brigs, and some small craft. The governor, Sir G. Prevost, gave him no serious support. On the 29th of May, during Chauncey's absence at Niagara, the Americans were attacked at Sackett's Harbor and would have been defeated if Prevost had not insisted on a retreat at the very moment when the American shipbuilding yard was in danger of being burnt, with a ship of more than eight hundred tons on the stocks. The retreat of the British force gave Chauncey time to complete this vessel, the "General Pike," which was so far superior to anything under Yeo's command that she was said to be equal in effective strength to the whole of the British flotilla. The American commodore was considered by many of his subordinates to have displayed excessive caution. In August he skirmished with Sir James Yeo's small squadron of six vessels, but made little effective use of his own fourteen. Two of his schooners were upset in a squall, with the loss of all hands, and he allowed two to be cut off by Yeo. Commodore Chauncey showed a preference for relying on his long guns, and a disinclination to come to close quarters. He was described as chasing the British squadron all round the lake, but his encounters did not go beyond artillery duels at long range, and he allowed his enemy to continue in existence long after he might have been destroyed. The winter suspended operations, and both sides made exertions to increase their forces. The Americans had the advantage of commanding greater resources for shipbuilding. Sir James Yeo began by blockading Sackett's Harbor in the early part of 1814, but when the American squadron was ready he was compelled to retire by the disparity of the forces. The American commodore was now able to blockade the British flotilla at Kingston. When the cruising season of the lake was nearly over he in his turn retired to Sackett's Harbor, and did not leave it for the rest of the war. During his later years he served as commissioner of the navy, and was president of the board of naval commissioners from 1833 till his death at Washington on the 27th of February 1840.

See Roosevelt's *War of 1812* (1882); and A. T. Mahan, *Sea-Power in its Relations to the War of 1812* (1905).

CHAUNCY, CHARLES (1592-1672), president of Harvard College, was born at Yardley-Bury, Hertfordshire, England, in November 1592, and was educated at Trinity College, Cambridge, of which he became a fellow. He was in turn vicar at Ware, Hertfordshire (1627-1633), and at Marston St Lawrence, Northamptonshire (1633-1637). Refusing to observe the ecclesiastical regulations of Archbishop Laud, he was brought before the court of high commission in 1629, and again in 1634, when, for opposing the placing of a rail around the communion table, he was suspended and imprisoned. His formal recantation in February 1637 caused him lasting self-reproach and humiliation. In 1637 he emigrated to America, and from 1638 until 1641 was an associate pastor at Plymouth, where, however, his advocacy of the baptism of infants by immersion caused dissatisfaction. He was the pastor at Scituate, Massachusetts, from 1641 until 1654, and from 1654 until his death was president of Harvard College, as the successor of the first president Henry Dunster (c. 1612-1659). He died on the 19th of February 1672. By his sermons and his writings he exerted a great influence in colonial Massachusetts, and according to Mather was "a most incomparable scholar." His writings include: *The Plain Doctrine of the Justification of a Sinner in the Sight of God* (1659) and *Antisynodalia Scripta Americana* (1662). His son, Isaac

Chauncy (1632-1712), who removed to England, was a voluminous writer on theological subjects.

There are biographical sketches of President Chauncy in Cotton Mather's *Magnalia Christi Americana* (London, 1702), and in W. C. Fowler's *Memorials of the Chauncys, including President Chauncy* (Boston, 1858).

President Chauncy's great-grandson, CHARLES CHAUNCY (1705-1787), a prominent American theologian, was born in Boston, Massachusetts, on the 1st of January 1705, and graduated at Harvard in 1721. In 1727 he was chosen as the colleague of Thomas Foxcroft (1697-1769) in the pastorate of the First Church of Boston, continuing as pastor of this church until his death. At the time of the "Great Awakening" of 1740-1743 and afterwards, Chauncy was the leader of the so-called "Old Light" party in New England, which strongly condemned the Whitefieldian revival as an outbreak of emotional extravagance. His views were ably presented in his sermon *Enthusiasm* and in his *Seasonable Thoughts on the State of Religion in New England* (1743), written in answer to Jonathan Edwards's *Some Thoughts Concerning the Present Revival of Religion in New England* (1742). He also took a leading part in opposition to the projected establishment of an Anglican Episcopate in America, and before and during the American War of Independence he ardently supported the whig or patriot party. Theologically he has been classed as a precursor of the New England Unitarians. He died in Boston on the 10th of February 1787. His publications include: *Compleat View of Episcopacy, as Exhibited in the Fathers of the Christian Church, until the close of the Second Century* (1771); *Salvation of All Men, Illustrated and Vindicated as a Scripture Doctrine* (1782); *The Mystery Hid from Ages and Generations made manifest by the Gospel-Revelation* (1783); and *Five Discourses on the Fall and its Consequences* (1785).

See P. L. Ford's privately printed *Bibliotheca Chaunciana* (Brooklyn, N. Y., 1884); and Williston Walker's *Ten New England Leaders* (New York, 1901).

CHAUNY, a town of northern France in the department of Aisne, 19 m. S. by W. of St Quentin by rail. Pop. (1906) 10,127. The town is situated on the Oise (which here becomes navigable) and at the junction of the canal of St Quentin with the lateral canal of the Oise, and carries on an active trade. It contains mirror-polishing works, subsidiary to the mirror-works of St Gobain, chemical works, sugar manufactories, metal foundries and breweries. Chauny was the scene of much fighting in the Hundred Years' War.

CHAUTAUQUA, a village on the west shore of Chautauqua Lake in the town of Chautauqua, Chautauqua county, New York, U.S.A. Pop. of the town (1900) 3590; (1905) 3505; (1910) 3515; of the village (1908) about 750. The lake is a beautiful body of water over 1300 ft. above sea-level, 20 m. long, and from a few hundred yards to 3 m. in width. The town of Chautauqua is situated near the north end and is within easy reach by steamboat and electric car connexions with the main railways between the east and the west. The town is known almost solely as being the permanent home of the Chautauqua Institution, a system of popular education founded in 1874 by Lewis Miller (1829-1899) of Akron, Ohio, and Bishop John H. Vincent (b. 1832). The village, covering about three hundred acres of land, is carefully laid out to provide for the work of the Institution.

The Chautauqua Institution began as a Sunday-School Normal Institute, and for nearly a quarter of a century the administration was in the hands of Mr Miller, who was responsible for the business management, and Bishop Vincent, who was head of the instruction department. Though founded by Methodists, in its earliest years it became non-sectarian and has furnished a meeting-ground for members of all sects and denominations. At the very outset the activities of the assembly were twofold: (1) the conducting of a summer school for Sunday-school teachers, and (2) the presentation of a series of correlated lectures and entertainments. Although the movement was and still is primarily religious, it has always been assumed that the best religious education must necessarily take

advantage of the best that the educational world can afford in the literatures, arts and sciences. The scope of the plan rapidly broadened, and in 1879 a regular group of schools with graded courses of study was established. At about the same time, also, the Chautauqua Literary and Scientific Circle, providing a continuous home-reading system, was founded. The season lasts during June, July and August. In 1907 some 325 lectures, concerts, readings and entertainments were presented by a group of over 190 lecturers, readers and musicians, while at the same time 200 courses in the summer schools were offered by a faculty of instructors drawn from the leading colleges and normal schools of the country.

The Chautauqua movement has had an immense influence on education in the United States, an influence which is especially marked in three directions: (1) in the establishment of about 300 local assemblies or "Chautauquas" in the United States patterned after the mother Chautauqua; (2) in the promotion of the idea of summer education, which has been followed by the founding of summer schools or sessions at a large number of American universities, and of various special summer schools, such as the Catholic Summer School of America, with headquarters at Cliff Haven, Clinton county, New York, and the Jewish Chautauqua Society, with headquarters at Buffalo, N. Y.; and (3) in the establishment of numerous correspondence schools patterned in a general way after the system provided by the Chautauqua Literary and Scientific Circle.

See John Heyl Vincent, *The Chautauqua Movement* (Boston, 1886), and Frank C. Bray, *A Reading Journey through Chautauqua* (Chicago, 1905).

CHAUVELIN, BERNARD FRANÇOIS, MARQUIS DE (1766-1832), French diplomatist and administrator. Though master of the king's wardrobe in 1789, he joined in the Revolution. He served in the army of Flanders, and then was sent to London in February 1792, to induce England to remain neutral in the war which was about to break out between France and "the king of Bohemia and Hungary." He was well received at first, but after the 10th of August 1792 he was no longer officially recognized at court, and on the execution of Louis XVI. (21st of January 1793) he was given eight days to leave England. After an unsuccessful embassy in Tuscany, he was imprisoned as a suspect during the Terror, but freed after the 9th Thermidor. Under Napoleon he became a member of the council of state, and from 1812 to 1814 he governed Catalonia under the title of intendant-general, being charged to win over the Catalonians to King Joseph Bonaparte. He remained in private life during the Restoration and the Hundred Days. In 1816 he was elected deputy, and spoke in favour of liberty of the press and extension of the franchise. Though he was again deputy in 1827 he played no part in public affairs, and resigned in 1829.

See G. Pallain, *La Mission de Talleyrand à Londres en 1792* (Paris, 1889).

CHAUVIGNY, a town of western France, in the department of Vienne, 20 m. E. of Poitiers by rail. Pop. (1906) 2326. The town is finely situated overlooking the Vienne and a small torrent, and has two interesting Romanesque churches, both restored in modern times. There are also ruins of a château of the bishops of Poitiers, and of other strongholds. Near Chauvigny is the curious bone-cavern of Jioux, the entrance to which is fortified by large blocks of stone. The town carries on lime-burning and plaster-manufacture, and there are stone quarries in the vicinity. Trade is in wool and feathers.

CHAUVIN, ÉTIENNE (1640-1725), French Protestant divine, was born at Nîmes on the 18th of April 1640. At the revocation of the Edict of Nantes he retired to Rotterdam, where he was for some years preacher at the Walloon church; in 1695 the elector of Brandenburg appointed him pastor and professor of philosophy, and later inspector of the French college at Berlin, where he enjoyed considerable reputation as a representative of Cartesianism and as a student of physics. His principal work is a laborious *Lexicon Rationale, sive Thesaurus Philosophicus* (Rotterdam, 1692; new and enlarged edition, Léuwarden, 1713).

He also wrote *Theses de Cognitione Dei* (1662), and started the *Nouveau Journal des Savans* (1694-1698).

See E. and E. Haag, *La France Protestante*, vol. iv. (1884).

CHAUVINISM, a term for unreasonable and exaggerated patriotism, the French equivalent of "Jingoism." The word originally signified idolatry of Napoleon, being taken from a much-wounded veteran, Nicholas Chauvin, who, by his adoration of the emperor, became the type of blind enthusiasm for national military glory.

CHAUX DE FONDS, LA, a large industrial town in the Swiss canton of Neuchâtel. It is about 19 m. by rail N.W. of Neuchâtel, and stands at a height of about 3255 ft. in a valley (5 m. long) of the same name in the Jura. Pop. (1900) 35,968 (only 13,659 in 1850); (1905) 38,700, mainly French-speaking and Protestants; of the 6114 "Catholics" the majority are "Old Catholics." It is a centre of the watch-making industry, especially of gold watch cases; about 70% of those manufactured in Switzerland are turned out here. In 1900 it exported watches to the value of nearly £3,000,000 sterling. There is a school of industrial art (engraving and enamelling watch cases) and a school of watch-making (including instruction in the manufacture of chronometers and other scientific instruments of precision). It boasts of being *le plus gros village de l'Europe*, and certainly has preserved some of the features of a big village. Léopold Robert (1794-1835), the painter, was born here. (W. A. B. C.)

CHAVES, a town of northern Portugal, in the district of Villa Real, formerly included in the province of Traz os Montes; 8 m. S. of the Spanish frontier, on the right bank of the river Tamega. Pop. (1900) 6388. Chaves is the ancient *Aquae Flaviae*, famous for its hot saline springs, which are still in use. A fine Roman bridge of 18 arches spans the Tamega. In the 16th century Chaves contained 20,000 inhabitants; it was long one of the principal frontier fortresses, and in fact derives its present name from the position which makes it the "keys," or *chaves*, of the north. One of its churches contains the tomb of Alphonso I. of Portugal (1139-1185). In 1830 the town gave the title of marquis to Pinto da Fonseca, a leader of the Miguelite party.

CHAZELLES, JEAN MATHIEU DE (1657-1710), French hydrographer, was born at Lyons on the 24th of July 1657. He was nominated professor of hydrography at Marseilles in 1685, and in that capacity carried out various coast surveys. In 1693 he was engaged to publish a second volume of the *Neptune français*, which was to include the hydrography of the Mediterranean. For this purpose he visited the Levant and Egypt. When in Egypt he measured the pyramids, and, finding that the angles formed by the sides of the largest were in the direction of the four cardinal points, he concluded that this position must have been intended, and also that the poles of the earth and meridians had not deviated since the erection of those structures. He was made a member of the Academy in 1695, and died in Paris on the 16th of January 1710.

CHEADLE, a town in the Altrincham parliamentary division of Cheshire, England, 6 m. S. of Manchester, included in the urban district of Cheadle and Gatley. Pop. (1901) 7916. This is one of the numerous townships of modern growth which fringe the southern boundaries of Manchester, and practically form suburbs of that city. Stockport lies immediately to the east. The name occurs in the formerly separate villages of Cheadle Hulme, Cheadle Bulkeley and Cheadle Mosley. There are cotton printing and bleaching works in the locality. The parish church of St Giles, Cheadle, is Perpendicular, containing an altar-tomb of the 15th century for two knights.

CHEADLE, a market town in the Leek parliamentary division of Staffordshire, England, 13 m. N.E. of Stafford, and the terminus of a branch line from Cresswell on the North Staffordshire railway. Pop. (1901) 5186. The Roman Catholic church of St Giles, with a lofty spire, was designed by Pugin and erected in 1846. The interior is lavishly decorated. There are considerable collieries in the neighbourhood, and silk and tape works in the town. In the neighbouring Froghall district limestone is quarried, and there are manufactures of copper. In Cheadle two fairs of ancient origin are held annually.

CHEATING, "the fraudulently obtaining the property of another by any deceitful practice not amounting to felony, which practice is of such a nature that it directly affects, or may directly affect, the public at large" (Stephen, *Digest of Criminal Law*, chap. xl. § 367). Cheating is either a common law or statutory offence, and is punishable as a misdemeanour. An indictment for cheating at common law is of comparatively rare occurrence, and the statutory crime usually presents itself in the form of obtaining money by false pretences (*q.v.*). The word "cheat" is a variant of "escheat," *i.e.* the reversion of land to a lord of the fee through the failure of blood of the tenant. The shortened form "cheater" for "escheator" is found early in the legal sense, and *chetynge* appears in the *Promptorium Parvulorum*, c. 1440, as the equivalent of *confiscatio*. In the 16th century "cheat" occurs in vocabularies of thieves and other slang, and in such works as the *Use of Dice-Play* (1532). It is frequent in Thomas Harman's *Caveat or Warening for . . . Vagabones* (1567), in the sense of "thing," with a descriptive word attached, *e.g.* *smeling chete* = nose. In the tract *Mihil Mumchance, his Discoverie of the Art of Cheating*, doubtfully attributed to Robert Greene (1560-1592), we find that gamblers call themselves *cheaters*, "borrowing the term from the lawyers." The sense development is obscure, but it would seem to be due to the extortionate or fraudulent demands made by legal "escheators."

CHEBICHEV, PAFNUTIY LVOVICH (1821-1894), Russian mathematician, was born at Borovsk on the 26th of May 1821. He was educated at the university of Moscow, and in 1859 became professor of mathematics in the university of St Petersburg, a position from which he retired in 1880. He was chosen a correspondent of the Institute of France in 1860, and succeeded to the high honour of *associé étranger* in 1874. He was also a foreign member of the Royal Society of London. After N. I. Lobachevskiy he probably ranks as the most distinguished mathematician Russia has produced. In 1841 he published a valuable paper, "Sur la convergence de la série de Taylor," in *Crelle's Journal*. His best-known papers, however, deal with prime numbers; in one of these ("Sur les nombres premiers," 1850) he established the existence of limits within which must be comprised the sum of the logarithms of the primes inferior to a given number. Another question to which he devoted much attention was that of obtaining rectilinear motion by linkage. The parallel motion known by his name is a three-bar linkage, which gives a very close approximation to exact rectilinear motion, but in spite of all his efforts he failed to devise one that produced absolutely true rectilinear motion. At last, indeed, he came to the conclusion that to do so was impossible, and in that conviction set to work to find a rigorous proof of the impossibility. While he was engaged on this task the desired linkage, which moved the highest admiration of J. J. Sylvester, was discovered and exhibited to him by one of his pupils, named Lipkin, who, however, it was afterwards found, had been anticipated by A. Peaucellier. Chebichev further constructed an instrument for drawing large circles, and an arithmetical machine with continuous motion. His mathematical writings, which account for some forty entries in the Royal Society's catalogue of scientific papers, cover a wide range of subjects, such as the theory of probabilities, quadratic forms, theory of integrals, gearings, the construction of geographical maps, &c. He also published a *Traité de la théorie des nombres*. He died at St Petersburg on the 8th of December 1894.

CHEBOYGAN, a city and the county-seat of Cheboygan county, Michigan, U.S.A., on South Channel (between Lakes Michigan and Huron), at the mouth of Cheboygan river, in the N. part of the lower peninsula. Pop. (1890) 6235; (1900) 6489, of whom 2101 were foreign-born; (1904) 6730; (1910) 6859. It is served by the Michigan Central and the Detroit & Mackinac railways, and by steamboat lines to Chicago, Milwaukee, Detroit, Sault Ste Marie, Green Bay and other lake ports; and is connected by ferry with Mackinac and Pointe aux Pins. During a great part of the year small boats ply between Cheboygan and the head of Crooked Lake, over the "Inland Route." Cheboygan is situated in a fertile farming region; for

which it is a trade centre, and it has lumber mills, tanneries, paper mills, boiler works, and other manufacturing establishments. The water-works are owned and operated by the municipality. The city, at first called Duncan, then Inverness, and finally Cheboygan, was settled in 1846, incorporated as a village in 1871, reincorporated in 1877, and chartered as a city in 1889.

CHECHENZES, TCHETCHEN, or KHISTS (*Kisti*), the last being the name by which they are known to the Georgians, a people of the eastern Caucasus occupying the whole of west Daghestan. They call themselves Nakhtche, "people." A wild, fierce people, they fought desperately against Russian aggression in the 18th century under Daúd Beg and Oman Khan and Shamil, and in the 19th under Khazi-Mollah, and even now some are independent in the mountain districts. On the surrender of the chieftain Shamil to Russia in 1859 numbers of them migrated into Armenia. In physique the Chechenzes resemble the Circassians, and have the same haughtiness of carriage. They are of a generous temperament, very hospitable, but quick to revenge. They are fond of fine clothes, the women wearing rich robes with wide, pink silk trousers, silver bracelets and yellow sandals. Their houses, however, are mere hovels, some dug out of the ground, others formed of boughs and stones. Before their subjection to Russia they were remarkable for their independence of spirit and love of freedom. Everybody was equal, and they had no slaves except prisoners of war. Government in each commune was by popular assembly, and the administration of justice was in the hands of the wronged. Murder and robbery with violence could be expiated only by death, unless the criminal allowed his hair to grow and the injured man consented to shave it himself and take an oath of brotherhood on the Koran. Otherwise the law of vendetta was fully carried out with curious details. The wronged man, wrapped in a white woollen shroud, and carrying a coin to serve as payment to a priest for saying the prayers for the dead, started out in search of his enemy. When the offender was found he must fight to a finish. A remarkable custom among one tribe is that if a betrothed man or woman dies on the eve of her wedding, the marriage ceremony is still performed, the dead being formally united to the living before witnesses, the father, in case it is the girl who dies, never failing to pay her dowry. The religion of the Chechenzes is Mahomedanism, mixed, however, with Christian doctrines and observances. Three churches near Kistin in honour of St George and the Virgin are visited as places of pilgrimage, and rams are there offered as sacrifices. The Chechenzes number upwards of 200,000. They speak a distinct language, of which there are said to be twenty separate dialects.

See Ernest Chanter, *Recherches anthropologiques dans le Caucase* (Lyon, 1885-1887); D. G. Brinton, *Races of Man* (1890); Hutchinson, *Living Races of Mankind* (London, 1901).

CHECKERS, the name by which the game of draughts (*q.v.*) is known in America. The origin of the name is the same as that of "chess" (*q.v.*).

CHEDDAR, a small town in the Wells parliamentary division of Somersetshire, England, 22 m. S.W. of Bristol by a branch of the Great Western railway. Pop. (1901) 1975. The town, with its Perpendicular church and its picturesque market-cross, lies below the south-western face of the Mendip Hills, which rise sharply from 600 to 800 ft. To the west stretches the valley of the river Axe, broad, low and flat. A fine gorge opening from the hills immediately upon the site of the town is known as Cheddar cliffs from the sheer walls which flank it; the contrast of its rocks and rich vegetation, and the falls of a small stream traversing it, make up a beautiful scene admired by many visitors. Several stalactitical caverns are also seen, and prehistoric British and Roman relics discovered in and near them are preserved in a small museum. The two caverns most frequently visited are called respectively Cox's and Gough's; in each, but especially in the first, there is a remarkable collection of fantastic and beautiful stalactitical forms. There are other caverns of greater extent but less beauty, but their extent is not completely explored. The remains discovered in the caves give

evidence of British and Roman settlements at Cheddar (*Cedre, Chedare*), which was a convenient trade centre. The manor of Cheddar was a royal demesne in Saxon times, and the witenagemot was held there in 966 and 968. It was granted by John in 1204 to Hugh, archdeacon of Wells, who sold it to the bishop of Bath and Wells in 1229, whose successors were overlords until 1553, when the bishop granted it to the king. It is now owned by the marquis of Bath. By a charter of 1231 extensive liberties in the manor of Cheddar were granted to Bishop Joceline, who by a charter of 1235 obtained the right to hold a weekly market and fair. By a charter of Edward III. (1337) Cheddar was removed from the king's forest of Mendip. The market was discontinued about 1690. Fairs are now held on the 4th of May and the 29th of October under the original grants. The name of Cheddar is given to a well-known species of cheese (see **DAIRY**), the manufacture of which began in the 17th century in the town and neighbourhood.

CHEDUBA, or **MAN-AUNG**, an island in the Bay of Bengal, situated 10 m. from the coast of Arakan, between 18° 40' and 18° 56' N. lat., and between 93° 31' and 93° 50' E. long. It forms part of the Kyaukpyu district of Arakan. It extends about 20 m. in length from N. to S., and 17 m. from E. to W., and its area of 220 sq. m. supports a population of 26,899 (in 1901). The channel between the island and the mainland is navigable for boats, but not for large vessels. The surface of the interior is richly diversified by hill and dale, and in the southern portion some of the heights exceed a thousand feet in elevation. There are various indications of former volcanic activity, and along the coast are earthy cones covered with green-sward, from which issue springs of muddy water emitting bubbles of gas. Copper, iron and silver ore have been discovered; but the island is chiefly noted for its petroleum wells, the oil derived from which is of excellent quality, and is extensively used in the composition of paint, as it preserves wood from the ravages of insects. Timber is not abundant, but the gamboge tree and the wood-oil tree are found of a good size. Tobacco, cotton, sugar-cane, hemp and indigo are grown, and the staple article is rice, which is of superior quality, and the chief article of export. The inhabitants of the island are mainly Maghs. Cheduba fell to the Burmese in the latter part of the 18th century. From them it was captured in 1824 by the British, whose possession of it was confirmed in 1826 by the treaty concluded with the Burmese at Yandaboo.

CHEERING, the uttering or making of sounds encouraging, stimulating or exciting to action, indicating approval or acclaiming or welcoming persons, announcements of events and the like. The word "cheer" meant originally face, countenance, expression, and came through the O. Fr. into Mid. Eng. in the 13th century from the Low Lat. *cara*, head; this is generally referred to the Gr. *kápa*. *Cara* is used by the 6th-century poet Flavius Cresconius Corippus, "Postquam venere verendam Caesaris ante caram" (*In Laudem Justinii Minoris*). "Cheer" was at first qualified with epithets, both of joy and gladness and of sorrow; compare "She thanked Dyomedes for alle . . . his gode chere" (Chaucer, *Troilus*) with "If they sing . . . 'tis with so dull a cheere" (Shakespeare, *Sonnets*, xcvi.). An early transference in meaning was to hospitality or entertainment, and hence to food and drink, "good cheer." The sense of a shout of encouragement or applause is a late use. Defoe (*Captain Singleton*) speaks of it as a sailor's word, and the meaning does not appear in Johnson. Of the different words or rather sounds that are used in cheering, "hurrah," though now generally looked on as the typical British form of cheer, is found in various forms in German, Scandinavian, Russian (*urá*), French (*houra*). It is probably onomatopoeic in origin; some connect it with such words as "hurry," "whirl"; the meaning would then be "haste," to encourage speed or onset in battle. The English "hurrah" was preceded by "huzza," stated to be a sailor's word, and generally connected with "heeze," to hoist, probably being one of the cries that sailors use when hauling or hoisting. The German *hoch*, seen in full in *hoch lebe der Kaiser*, &c., the French *vive*, Italian and Spanish *viva*, *evviva*, are cries rather

of acclamation than encouragement. The Japanese shout *banzai* became familiar during the Russo-Japanese War. In reports of parliamentary and other debates the insertion of "cheers" at any point in a speech indicates that approval was shown by members of the House by emphatic utterances of "hear hear." Cheering may be tumultuous, or it may be conducted rhythmically by prearrangement, as in the case of the "Hip-hip-hip" by way of introduction to a simultaneous "hurrah."

Rhythmical cheering has been developed to its greatest extent in America in the college yells, which may be regarded as a development of the primitive war-cry; this custom has no real analogue at English schools and universities, but the New Zealand football team in 1907 familiarized English crowds at their matches with a similar sort of war-cry adopted from the Maoris. In American schools and colleges there is usually one cheer for the institution as a whole and others for the different classes. The oldest and simplest are those of the New England colleges. The original yells of Harvard and Yale are identical in form, being composed of *rah* (abbreviation of *hurrah*) nine times repeated, shouted in unison with the name of the university at the end. The Yale cheer is given faster than that of Harvard. Many institutions have several different yells, a favourite variation being the name of the college shouted nine times in a slow and prolonged manner. The best known of these variants is the Yale cheer, partly taken from the *Frogs* of Aristophanes, which runs thus:

"Brekekekéx, ko-áx, ko-áx,
Brekekekéx, ko-áx, ko-áx,
O-óp, O-óp, parabalou,
Yale, Yale, Yale,
Rah, rah, rah, rah, rah, rah, rah, rah,
Yale! Yale! Yale!"

The regular cheer of Princeton is:

"H'ray, h'ray, h'ray, tiger,
Siss, boom, ah; Princeton!"

This is expanded into the "triple cheer":

"H'ray, h'ray, h'ray,
Tiger, tiger, tiger,
Siss, siss, siss,
Boom, boom, boom,
Ah, ah, ah,
Princetón, Princetón, Princetón!"

The "railroad cheer" is like the foregoing, but begun very slowly and broadly, and gradually accelerated to the end, which is enunciated as fast as possible. Many cheers are formed like that of Toronto University:

"Varsity, varsity,
V-a-r-s-i-t-y (spelled)
VARSIT-Y (spelled *staccato*)
Vár-sí-tý,
Rah, rah, rah!"

Another variety of yell is illustrated by that of the School of Practical Science of Toronto University:

"Who are we? Can't you guess?
We are from the S.P.S.!"

The cheer of the United States Naval Academy is an imitation of a nautical syren. The Amherst cheer is:

"Amherst! Amherst! Amherst! Rah! Rah!
Amherst! Rah! Rah!
Rah! Rah! Rah! Rah! Rah! Rah! Amherst!"

Besides the cheers of individual institutions there are some common to all, generally used to compliment some successful athlete or popular professor. One of the oldest examples of these personal cheers is:

"Who was George Washington?
First in war,
First in peace,
First in the hearts of his countrymen,"

followed by a stamping on the floor in the same rhythm.

College yells are used particularly at athletic contests. In any large college there are several leaders, chosen by the students, who stand in front and call for the different songs and cheers,

directing with their arms in the fashion of an orchestral conductor. This cheering and singing form one of the distinctive features of inter-collegiate and scholastic athletic contests in America.

CHEESE (Lat. *caseus*), a solidified preparation from milk; the essential constituent of which is the proteinous or nitrogenous substance *casein*. All cheese contains in addition some proportion of fatty matter or butter, and in the more valuable varieties the butter present is often greater in amount than the casein. Cheese being thus a compound substance of no definite composition is found in commerce of many different varieties and qualities; and such qualities are generally recognized by the names of the localities in which they are manufactured. The principal distinctions arise from differences in the composition and condition of the milk operated upon, from variations in the method of preparation and curing, and from the use of the milk of other animals besides the cow, as, for example, the goat and the ewe, from the milk of both of which cheese is manufactured on a commercial scale. For details about different cheeses and cheese-making, see DAIRY. From the Urdu *chiz* ("thing") comes the slang expression "the cheese," meaning "the perfect thing," apparently from Anglo-Indian usage.

A useful summary of the history and manufacture of all sorts of cheeses, under their different names, is given in Bulletin 105 of the Bureau of Animal Industry (United States Dep. of Agriculture), *Varieties of Cheese*, by C. F. Doane and H. W. Lawson (Washington, 1908).

CHEESE CLOTH, the name given to cloth, usually made from flax or tow yarns, of an open character, resembling a fine riddle or sieve, used for wrapping cheese. A finer quality and texture is made for women's gowns. A similar cloth is used for inside linings in the upholstery trade, and for the ground of embroidery.

CHEETA (CHITA), or HUNTING-LEOPARD (*Cynaelurus jubatus*, formerly known as *Gueparda jubata*), a member of the family *Felidae*, distinguished by its claws being only partially retractile (see CARNIVORA). The cheeta attains a length of 3 to 4 ft.; it is of a pale fulvous colour, marked with numerous spots of black on the upper surface and sides, and is nearly white beneath. The fur is somewhat crisp, altogether lacking the sleekness which characterizes the fur of the typical cats, and the tail is long and somewhat bushy at the extremity. In confinement the cheeta soon becomes fond of those who are kind to it, and gives evidence of its attachment in an open, dog-like manner. The cheeta is found throughout Africa and southern Asia, and has been employed for centuries in India and Persia in hunting antelopes and other game. According to Sir W. Jones, this mode of hunting originated with Hushing, king of Persia, 865 B.C., and afterwards became so popular that certain of the Mongol emperors were in the habit of being accompanied in their sporting expeditions by a thousand hunting leopards. In prosecuting this sport at the present day the cheeta is conveyed to the field in a low car without sides, hooded and chained like hunting-birds in Europe in the days of falconry. When a herd of deer or antelopes is seen, the car, which bears a close resemblance to the ordinary vehicles used by the peasants, is usually brought within 200 yds. of the game before the latter takes alarm; the cheeta is then let loose and the hood removed from its eyes. No sooner does it see the herd, than dropping from the car on the side remote from it spray, it approaches stealthily, making use of whatever means of concealment the nature of the ground permits, until observed, when making a few gigantic bounds, it generally arrives in the midst of the herd and brings down its victim with a stroke of its paw. The sportsman then approaches, draws off a bowl of the victim's blood, and puts it before the cheeta; which is again hooded and led back to the car. Should it not succeed in reaching the herd in the first few bounds, it makes no further effort to pursue, but retires seemingly dispirited to the car. In Africa the cheeta is only valued for its skin, which is worn by chiefs and other people of rank. It should be added that in India the name cheeta (chita) is applied also to the leopard.

CHEFFONIER, properly CHIFFONIER, a piece of furniture differentiated from the sideboard by its smaller size and by the

enclosure of the whole of the front by doors. Its name (which comes from the French for a rag-gatherer) suggests that it was originally intended as a receptacle for odds and ends which had no place elsewhere, but it now usually serves the purpose of a sideboard. It is a remote and illegitimate descendant of the cabinet; it has rarely been elegant and never beautiful. It was one of the many curious developments of the mixed taste, at once cumbrous and bizarre, which prevailed in furniture during the Empire period in England. The earliest cheffoniers date from that time; they are usually of rosewood—the favourite timber of that moment; their "furniture" (the technical name for knobs, handles and escutcheons) was most commonly of brass, and there was very often a raised shelf with a pierced brass gallery at the back. The doors were well panelled and often edged with brass-beading, while the feet were pads or claws, or, in the choicer examples, sphinxes in gilded bronze. Cheffoniers are still made in England in cheap forms and in great number.

CHEH-KIANG, an eastern province of China, bounded N. by the province of Kiang-su, E. by the sea, S. by the province of Fu-kien, and W by the provinces of Kiang-si and Ngan-hui. It occupies an area of about 36,000 sq. m., and contains a population of 11,800,000. With the exception of a small portion of the great delta plain, which extends across the frontier from the province of Kiang-su, and in which are situated the famous cities of Hu Chow, Ka-hing, Hang-chow, Shao-Sing and Ning-po, the province forms a portion of the Nan-shan of south-eastern China, and is hilly throughout. The Nan-shan ranges run through the centre of the province from south-west to north-east, and divide it into a northern portion, the greater part of which is drained by the Tsien-t'ang-kiang, and a southern portion which is chiefly occupied by the Ta-chi basin. The valleys enclosed between the mountain ranges are numerous, fertile, and for the most part of exquisite beauty. The hilly portion of the province furnishes large supplies of tea, and in the plain which extends along the coast, north of Ning-po, a great quantity of silk is produced. In minerals the province is poor. Coal and iron are occasionally met with, and traces of copper ore are to be found in places, but none of these minerals exists in sufficiently large deposits to make mining remunerative. The province, however, produces cotton, rice, ground-nuts, wheat, indigo, tallow and beans in abundance. The principal cities are Hang-chow, which is famed for the beauty of its surroundings, Ning-po, which has been frequented by foreign ships ever since the Portuguese visited it in the 16th century, and Wenchow. Opposite Ning-po, at a distance of about 50 m., lies the island of Chusan, the largest of a group bearing that general name. This island is 21 m. long, and about 50 m. in circumference. It is very mountainous, and is surrounded by numerous islands and islets. On its south side stands the walled town of Ting-hai, in front of which is the principal harbour. The population is returned as 50,000.

CHEKE, SIR JOHN (1514-1557), English classical scholar, was the son of Peter Cheke, esquire-bedell of Cambridge University. He was educated at St John's College, Cambridge, where he became a fellow in 1529. While there he adopted the principles of the Reformation. His learning gained him an exhibition from the king, and in 1540, on Henry VIII's foundation of the regius professorships, he was elected to the chair of Greek. Amongst his pupils at St John's were Lord Burghley, who married Cheke's sister Mary, and Roger Ascham, who in *The Schoolmaster* gives Cheke the highest praise for scholarship and character. Together with Sir Thomas Smith, he introduced a new method of Greek pronunciation very similar to that commonly used in England in the 19th century. It was strenuously opposed in the University, where the continental method prevailed, and Bishop Gardiner, as chancellor, issued a decree against it (June 1542); but Cheke ultimately triumphed. On the 10th of July 1554, he was chosen as tutor to Prince Edward, and after his pupil's accession to the throne he continued his instructions. Cheke took a fairly active share in public life; he sat, as member for Bletchingley, for the parliaments of 1547 and 1552-1553; he was made provost of King's College, Cambridge

(April 1, 1548), was one of the commissioners for visiting that university as well as Oxford and Eton, and was appointed with seven divines to draw up a body of laws for the governance of the church. On the 11th of October 1551 he was knighted; in 1553 he was made one of the secretaries of state, and sworn of the privy council. His zeal for Protestantism induced him to follow the duke of Northumberland, and he filled the office of secretary of state for Lady Jane Grey during her nine days' reign. In consequence Mary threw him into the Tower (July 27, 1553), and confiscated his wealth. He was, however, released on the 13th of September 1554, and granted permission to travel abroad. He went first to Basel, then visited Italy, giving lectures in Greek at Padua, and finally settled at Strassburg, teaching Greek for his living. In the spring of 1556 he visited Brussels to see his wife; on his way back, between Brussels and Antwerp, he and Sir Peter Carew were treacherously seized (May 15) by order of Philip of Spain, hurried over to England, and imprisoned in the Tower. Cheke was visited by two priests and by Dr John Feckenham, dean of St Paul's, whom he had formerly tried to convert to Protestantism, and, terrified by a threat of the stake, he gave way and was received into the Church of Rome by Cardinal Pole, being cruelly forced to make two public recantations. Overcome with shame, he did not long survive, but died in London on the 13th of September 1557, carrying, as T. Fuller says (*Church History*), "God's pardon and all good men's pity along with him." About 1547 Cheke married Mary, daughter of Richard Hill, sergeant of the wine-cellar to Henry VIII., and by her he had three sons. The descendants of one of these, Henry, known only for his translation of an Italian morality play *Freewyl (Tragedio del Libero Arbitrio)* by Nigri de Bassano, settled at Pyrgo in Essex.

Thomas Wilson, in the epistle prefixed to his translation of the Olynthiacs of Demosthenes (1570), has a long and most interesting eulogy of Cheke; and Thomas Nash, in *To the Gentlemen Students*, prefixed to Robert Greene's *Menaphon* (1589), calls him "the Exchequer of eloquence, Sir Ihon Cheke, a man of men, supernaturally traded in all tongues." Many of Cheke's works are still in MS., some have been altogether lost. One of the most interesting from a historical point of view is the *Hurt of Sedition how greuous it is to a Commune welth* (1549), written on the occasion of Ket's rebellion, republished in 1569, 1576 and 1641, on the last occasion with a life of the author by Gerard Langbaine. Others are *D. Joannis Chrysostomi homiliae duae* (1543), *D. Joannis Chrysostomi de providentia Dei* (1545), *The Gospel according to St Matthew . . . translated* (c. 1550; ed. James Goodwin, 1843), *De obitu Martini Buceri* (1551), (Leo VI.'s) *de Apparatu bellico* (Basel, 1554; but dedicated to Henry VIII., 1544), *Carmen Heroicum, aut epitaphium in Antonium Dencium* (1551), *De pronuntiatione Graecae . . . linguae* (Basel, 1555). He also translated several Greek works, and lectured admirably upon Demosthenes.

His *Life* was written by John Strype (1821); additions by J. Gough Nichols in *Archaeologia* (1860), xxxviii. 98, 127.

CHELLIAN, the name given by the French anthropologist G. de Mortillet to the first epoch of the Quaternary period when the earliest human remains are discoverable. The word is derived from the French town Chelles in the department of Seine-et-Marne. The climate of the Chellian epoch was warm and humid as evidenced by the wild growth of fig-trees and laurels. The animals characteristic of the epoch are the *Elephas antiquus*, the rhinoceros, the cave-bear, the hippopotamus and the striped hyaena. Man existed and belonged to the Neanderthal type. The implements characteristic of the period are flints chipped into leaf-shaped forms and held in the hand when used. The drift-beds of St Acheul (Amiens), of Menchecourt (Abbeville), of Hoxne (Suffolk), and the detrital laterite of Madras are considered by de Mortillet to be synchronous with the Chellian beds. See Gabriel de Mortillet, *Le Préhistorique* (1900); Lord Avebury, *Prehistoric Times* (1900).

CHELMSFORD, FREDERIC THESIGER, 1ST BARON (1794-1878), lord chancellor of England, was the third son of Charles Thesiger, and was born in London on the 15th of April 1794. His father, collector of customs at St Vincent's, was the son of a Saxon gentleman who had migrated to England and become secretary to Lord Rockingham, and was the brother of Sir Frederic Thesiger, naval A.D.C. to Nelson at Copenhagen. Young Frederic Thesiger was originally destined for a naval

career, and he served as a midshipman on board the "Cambrian" frigate in 1807 at the second bombardment of Copenhagen. His only surviving brother, however, died about this time, and he became entitled to succeed to a valuable estate in the West Indies, so it was decided that he should leave the navy and study law, with a view to practising in the West Indies and eventually managing his property in person. Another change of fortune, however, awaited him, for a volcano destroyed the family estate, and he was thrown back upon his prospect of a legal practice in the West Indies. He proceeded to enter at Gray's Inn in 1813, and was called on the 18th of November 1818, another change in his prospects being brought about by the strong advice of Godfrey Sykes, a special pleader in whose chambers he had been a pupil, that he should remain to try his fortune in England. He accordingly joined the home circuit, and soon got into good practice at the Surrey sessions, while he also made a fortunate purchase in buying the right to appear in the old palace court (see LORD STEWARD). In 1824 he distinguished himself by his defence of Joseph Hunt when on his trial at Hertford with John Thurtell for the murder of Wm. Weare; and eight years later at Chelmsford assizes he won a hard-fought action in an ejectment case after three trials, to which he attributed so much of his subsequent success that when he was raised to the peerage he assumed the title Lord Chelmsford. In 1834 he was made king's counsel, and in 1835 was briefed in the Dublin election inquiry which unseated Daniel O'Connell. In 1840 he was elected M.P. for Woodstock. In 1844 he became solicitor-general, but having ceased to enjoy the favour of the duke of Marlborough, lost his seat for Woodstock and had to find another at Abingdon. In 1845 he became attorney-general, holding the post until the fall of the Peel administration on the 3rd of July 1846. Thus by three days Thesiger missed being chief justice of the common pleas, for on the 6th of July Sir Nicholas Tindal died, and the seat on the bench, which would have been Thesiger's as of right, fell to the Liberal attorney-general, Sir Thomas Wilde. Sir Frederic Thesiger remained in parliament, changing his seat, however, again in 1852, and becoming member for Stamford. During this period he enjoyed a very large practice at the bar, being employed in many *causes célèbres*. On Lord Derby coming into office for the second time in 1858, Sir Frederic Thesiger was raised straight from the bar to the lord chancellorship (as were Lord Brougham, Lord Selborne and Lord Halsbury). In the following year Lord Derby resigned and his cabinet was broken up. Again in 1866, on Lord Derby coming into office for the third time, Lord Chelmsford became lord chancellor for a short period. In 1868 Lord Derby retired, and Disraeli, who took his place as prime minister, wished for Lord Cairns as lord chancellor. Lord Chelmsford was very sore at his supersession and the manner of it, but, according to Lord Malmesbury he retired under a compact made before he took office. Ten years later Lord Chelmsford died in London on the 5th of October 1878. Lord Chelmsford had married in 1822 Anna Maria Tinling. He left four sons and three daughters, of whom the eldest, Frederick Augustus, 2nd Baron Chelmsford (1827-1905), earned distinction as a soldier, while the third, Alfred Henry Thesiger (1838-1880) was made a lord justice of appeal and a privy councillor in 1877, at the early age of thirty-nine, but died only three years later.

See *Lives of the Chancellors* (1908), by J. B. Atlay, who has had the advantage of access to an unpublished autobiography of Lord Chelmsford's.

CHELMSFORD, a market town and municipal borough, and the county town of Essex, England, in the Chelmsford parliamentary division, 30 m. E.N.E. from London by the Great Eastern railway. Pop. (1901) 12,580. It is situated in the valley of the Chelmer, at the confluence of the Cann, and has communication by the river with Maldon and the Blackwater estuary 11 m. east. Besides the parish church of St Mary, a graceful Perpendicular edifice, largely rebuilt, the town has a grammar school founded by Edward VI., an endowed charity school and a museum. It is the seat of the county assizes and quarter sessions, and has a handsome shire hall; the county gaol

is near the town. Its corn and cattle markets are among the largest in the county; for the first a fine exchange is provided. In the centre of the square in which the corn exchange is situated stands a bronze statue of Lord Chief-Justice Tindal (1776-1846), a native of the parish. There are agricultural implement and iron foundries, large electric light and engineering works, breweries, tanneries, maltings and extensive corn mills. There is a race-course 2 m. south of the town. The borough is under a mayor, 6 aldermen and 18 councillors. Area 2308 acres.

A place of settlement since Palaeolithic times, Chelmsford (*Chilmersford*, *Chelmeresford*, *Chelmsford*) owed its importance to its position on the road from London to Colchester. It consisted of two manors: that of Moulsham, which remained in the possession of Westminster Abbey from Saxon times till the reign of Henry VIII., when it was granted to Thomas Mildmay; and that of Bishop's Hall, which was held by the bishops of London from the reign of Edward the Confessor to 1545, when it passed to the crown and was granted to Thomas Mildmay in 1563. The medieval history of Chelmsford centred round the manor of Bishop's Hall. Early in the 12th century Bishop Maurice built the bridge over the Chelmer which brought the road from London directly through the town, thus making it an important stopping-place. The town was not incorporated until 1888. In 1225 Chelmsford was made the centre for the collection of fifteenths from the county of Essex, and in 1227 it became the regular seat of assizes and quarter-sessions. Edward I. confirmed Bishop Richard de Gravesend in his rights of frank pledge in Chelmsford in 1290, and in 1395 Richard II. granted the return of writs to Bishop Robert de Braybrooke. In 1377 writs were issued for the return of representatives from Chelmsford to parliament, but no return of members has been found. In 1199 the bishop obtained the grant of a weekly market at the yearly rent of one palfrey, and in 1201 that of an annual fair, now discontinued, for four days from the feast of St Philip and St James.

CHELSEA, a western metropolitan borough of London, England, bounded E. by the city of Westminster, N.W. by Kensington, S.W. by Fulham, and S. by the river Thames. Pop. (1901) 73,842. Its chief thoroughfare is Sloane Street, containing handsome houses and good shops, running south from Knightsbridge to Sloane Square. Hence King's Road leads west, a wholly commercial highway, named in honour of Charles II., and recalling the king's private road from St James's Palace to Fulham, which was maintained until the reign of George IV. The main roads south communicate with the Victoria or Chelsea, Albert and Battersea bridges over the Thames. The beautiful Chelsea embankment, planted with trees and lined with fine houses and, in part, with public gardens, stretches between Victoria and Battersea bridges. The better residential portion of Chelsea is the eastern, near Sloane Street and along the river; the western, extending north to Fulham Road, is mainly a poor quarter.

Chelsea, especially the riverside district, abounds in historical associations. At *Cealchylthe* a synod was held in 785. A similar name occurs in a Saxon charter of the 11th century and in Domesday; in the 16th century it is *Chelcith*. The later termination *ey* or *ea* was associated with the insular character of the land, and the prefix with a gravel bank (*ceosol*; cf. Chesil Bank, Dorsetshire) thrown up by the river; but the early suffix *hylthe* is common in the meaning of a haven. The manor was originally in the possession of Westminster Abbey, but its history is fragmentary until Tudor times. It then came into the hands of Henry VIII., passed from him to his wife Catharine Parr, and thereafter had a succession of owners, among whom were the Howards, to whom it was granted by Queen Elizabeth, and the Cheynes, from whom it was purchased in 1712 by Sir Hans Sloane, after which it passed to the Cadogans. The memorials which crowd the picturesque church and churchyard of St Luke near the river, commonly known as the Old Church, to a great extent epitomize the history of Chelsea. Such are those of Sir Thomas More (d. 1535); Lord Bray, lord of the manor (1539), his father and son; Lady Jane Guyldeford, duchess of Northumberland, who died "at her maner of Chelse"

in 1555; Lord and Lady Dacre (1594-1595); Sir John Lawrence (1638); Lady Jane Cheyne (1698); Francis Thomas, "director of the china porcelain manufactory, Lawrence Street, Chelsea" (1770); Sir Hans Sloane (1753); Thomas Shadwell, poet laureate (1692); Woodfall the printer of *Junius* (1844), and many others. More's tomb is dated 1532, as he set it up himself, though it is doubtful whether he lies beneath it. His house was near the present Beaufort Street. In the 18th and 19th centuries Chelsea, especially the parts about the embankment and Cheyne Walk, was the home of many eminent men, particularly of writers and artists, with whom this pleasant quarter has long been in favour. Thus in the earlier part of the period named, Atterbury and Swift lived in Church Lane, Steele and Smollett in Monmouth House. Later, the names of Turner, Rossetti, Whistler, Leigh Hunt, Carlyle (whose house in Cheyne Row is preserved as a public memorial), Count D'Orsay, and Isambard Brunel, are intimately connected with Chelsea. At Lindsey House Count Zinzendorf established a Moravian Society (c. 1750). Sir Robert Walpole's residence was extant till 1810; and till 1824 the bishops of Winchester had a palace in Cheyne Walk. Queen's House, the home of D. G. Rossetti (when it was called Tudor House), is believed to take name from Catharine of Braganza.

Chelsea was noted at different periods for two famous places of entertainment, Ranelagh (*q.v.*) in the second half of the 18th century, and Cremorne Gardens (*q.v.*) in the middle of the 19th. Don Saltero's museum, which formed the attraction of a popular coffee-house, was formed of curiosities from Sir Hans Sloane's famous collections. It was Sloane who gave to the Apothecaries' Company the ground which they had leased in 1673 for the Physick Garden, which is still extant, but ceased in 1902 to be maintained by the Company. At Chelsea Sir John Danvers (d. 1655) introduced the Italian style of gardening which was so greatly admired by Bacon and soon after became prevalent in England. Chelsea was formerly famous for a manufacture of buns; the original Chelsea bun-house, claiming royal patronage, stood until 1839, and one of its successors until 1888. The porcelain works existed for some 25 years before 1769, when they were sold and removed to Derby. Examples of the original Chelsea ware (see CERAMICS) are of great value.

Of buildings and institutions the most notable is Chelsea Royal Hospital for invalid soldiers, initiated by Charles II. (according to tradition on the suggestion of Nell Gwynne), and opened in 1694. The hospital itself accommodates upwards of 500 men, but a system of out-pensioning was found necessary from the outset, and now relieves large numbers throughout the empire. The picturesque building by Wren stands in extensive grounds, which include the former Ranelagh Gardens. A theological college (King James's) formerly occupied the site; it was founded in 1610 and was intended to be of great size, but the scheme was unsuccessful, and only a small part of the buildings was erected. In the vicinity are the Chelsea Barracks (not actually in the borough). The Royal Military Asylum for boys, commonly called the Duke of York's school, founded in 1801 by Frederick, duke of York, for the education of children connected with the army, was removed in 1909 to new quarters at Dover. Other institutions are the Whitelands training college for school-mistresses, in which Ruskin took deep interest; the St Mark's college for school-masters; the Victoria and the Cheyne hospitals for children, a cancer hospital, the South-western polytechnic, and a public library containing an excellent collection relative to local history.

The parliamentary borough of Chelsea returns one member, and includes, as a detached portion, Kensal Town, north of Kensington. The borough council consists of a mayor, 6 aldermen and 36 councillors. Area, 659.6 acres.

CHELSEA, a city of Suffolk county, Massachusetts, U.S.A.; a suburb of Boston. Pop. (1890) 27,909; (1900) 34,072, of whom 11,203 were foreign-born; (1910) 32,452. It is situated on a peninsula between the Mystic and Chelsea rivers, and Charlestown and East Boston, and is connected with East Boston and Charlestown by bridges. It is served by the Boston & Maine and (for freight) by the Boston & Albany

railways. The United States maintains here naval and marine hospitals, and the state a soldiers' home. Chelsea's interests are primarily industrial. The value of the city's factory products in 1905 was \$13,879,159, the principal items being rubber and elastic goods (\$3,635,211) and boots and shoes (\$2,044,250.) The manufacture of stoves, and of mucilage and paste are important industries. Flexible tubing for electric wires (first made at Chelsea 1889) and art tiles are important products. The first settlement was established in 1624 by Samuel Maverick (c. 1602-c. 1670), the first settler (about 1629) of Noddle's Island (or East Boston), and one of the first slave-holders in Massachusetts; a loyalist and Churchman, in 1664 he was appointed with three others by Charles II. on an important commission sent to Massachusetts and the other New England colonies (see NICOLLS, RICHARD), and spent the last years of his life in New York. Until 1739, under the name of Winnisimmet, Chelsea formed a part of Boston, but in that year it was made a township; it became a city in 1857. In May 1775 a British schooner in the Mystic defended by a force of marines was taken by colonial militia under General John Stark and Israel Putnam,—one of the first conflicts of the War of Independence. A terrible fire swept the central part of the city on the 12th of April 1908.

See Mellen Chamberlain (and others), *History of Chelsea* (2 vols., Boston, 1908), published by the Massachusetts Historical Society.

CHELTENHAM, a municipal and parliamentary borough of Gloucestershire, England, 109 m. W. by N. of London by the Great Western railway; served also by the west and north line of the Midland railway. Pop. (1901) 49,439. The town is well situated in the valley of the Chelt, a small tributary of the Severn, under the high line of the Cotswold Hills to the east, and is in high repute as a health resort. Mineral springs were accidentally discovered in 1716. The Montpellier and Pittville Springs supply handsome pump rooms standing in public gardens, and are the property of the corporation. The Montpellier waters are sulphated, and are valuable for their diuretic effect, and as a stimulant to the liver and alimentary canal. The alkaline-saline waters of Pittville are efficacious against diseases resulting from excess of uric acid. The parish church of St Mary dates from the 14th century, but is almost completely modernized. The town, moreover, is wholly modern in appearance. Assembly rooms opened in 1815 by the duke of Wellington were removed in 1901. A new town hall, including a central spa and assembly rooms, was opened in 1903. There are numerous other handsome buildings, especially in High Street, and the Promenade forms a beautiful broad thoroughfare, lined with trees. The town is famous as an educational centre. Cheltenham College (1842) provides education for boys in three departments, classical, military and commercial; and includes a preparatory school. The Ladies' College (1854), long conducted by Miss Beale (*q.v.*), is one of the most successful in England. The Normal Training College was founded in 1846 for the training of teachers, male and female, in national and parochial schools. A free grammar school was founded in 1568 by Richard Pate, recorder of Gloucester. The art gallery and museum may be mentioned also. The parliamentary borough returns one member. The municipal borough is under a mayor, 6 aldermen and 18 councillors. Area, 4726 acres. The urban district of Charlton Kings (pop. 3806) forms a south-eastern suburb of Cheltenham.

The site of a British village and burying-ground, Cheltenham (*Celtanhomme, Chiltham, Cheltenham*) was a village with a church in 803. The manor belonged to the crown; it was granted to Henry de Bohun, earl of Hereford, late in the 12th century, but in 1199 was exchanged for other lands with the king. It was granted to William de Longespée, earl of Salisbury, in 1219, but resumed on his death and granted in dower to Eleanor of Provence in 1243. In 1252 the abbey of Fécamp purchased the manor, and it afterwards belonged to the priory of Cormeille, but was confiscated in 1415 as the possession of an alien priory, and was granted in 1461 to the abbey of Lyon, by which it was held until, once more returning to the crown at the Dissolution,

it was granted to the family of Dutton. The town is first mentioned in 1223, when William de Longespée leased the benefit of the markets, fairs and hundred of Cheltenham to the men of the town for three years; the lease was renewed by Henry III. in 1226, and again in 1230 for ten years. A market town in the time of Camden, it was governed by commissioners from the 18th century in 1876, when it was incorporated; it became a parliamentary borough in 1832. Henry III. in 1230 had granted to the men of Cheltenham a market on each Thursday, and a fair on the vigil, feast and morrow of St James. Although Camden mentions a considerable trade in malt, the spinning of woollen yarn was the only industry in 1779. After the discovery of springs in 1716, and the erection of a pump-room in 1738, Cheltenham rapidly became fashionable, the visit of George III. and the royal princesses in 1788 ensuring its popularity.

See S. Moreau, *A Tour to Cheltenham Spa* (Bath, 1738).

CHELYABINSK, a town of Russia, in the Orenburg government, at the east foot of the Urals, is the head of the Siberian railway, 624 m. by rail E.N.E. of Samara and 154 m. by rail S.S.E. of Ekaterinburg. Pop. (1900) 25,505. It has tanneries and distilleries, and is the centre of the trade in corn and produce of cattle for the Ural iron-works. The town was founded in 1658.

CHELYS (Gr. χέλυς, tortoise; Lat. *testudo*), the common lyre of the ancient Greeks, which had a convex back of tortoiseshell or of wood shaped like the shell. The word *chelys* was used in allusion to the oldest lyre of the Greeks which was said to have been invented by Hermes. According to tradition he was attracted by sounds of music while walking on the banks of the Nile, and found they proceeded from the shell of a tortoise across which were stretched tendons which the wind had set in vibration (*Homeric Hymn to Hermes*, 47-51). The word has been applied arbitrarily since classic times to various stringed instruments, some bowed and some twanged, probably owing to the back being much vaulted. Kircher (*Musurgia*, i. 486) applied the name of *chelys* to a kind of viol with eight strings. Numerous representations of the *chelys* lyre or *testudo* occur on the Greek vases, in which the actual tortoiseshell is depicted; a good illustration is given in *Le Antichità di Ercolano* (vol. i. pl. 43). Propertius (iv. 6) calls the instrument the *lyra testudinea*. Scaliger (on Manilius, *Astronomicon*, Proleg. 420) was probably the first writer to draw attention to the difference between *chelys* and *cithara* (q.v.). (K. S.)

CHEMICAL ACTION, the term given to any process in which change in chemical composition occurs. Such processes may be set up by the application of some form of energy (heat, light, electricity, &c.) to a substance, or by the mixing of two or more substances together. If two or more substances be mixed one of three things may occur. First, the particles may be mechanically intermingled, the degree of association being dependent upon the fineness of the particles, &c. Secondly, the substances may intermolecularly penetrate, as in the case of gas-mixtures and solutions. Or thirdly they may react chemically. The question whether, in any given case, we have to deal with a physical mixture or a chemical compound is often decided by the occurrence of very striking phenomena. To take a simple example:—oxygen and hydrogen are two gases which may be mixed in all proportions at ordinary temperatures, and it is easy to show that the properties of the products are simply those of mixtures of the two free gases. If, however, an electric spark be passed through the mixtures, powerful chemical union ensues, with its concomitants, great evolution of heat and consequent rise of temperature, and a compound, water, is formed which presents physical and chemical properties entirely different from those of its constituents.

In general, powerful chemical forces give rise to the evolution of large quantities of heat, and the properties of the resulting substance differ vastly more from those of its components than is the case with simple mixtures. This constitutes a valuable criterion as to whether mere mixture is involved on the one hand, or strong chemical union on the other. When, however, the chemical forces are weak and the reaction, being incomplete, leads to a

state of chemical equilibrium, in which all the reacting substances are present side by side, this criterion vanishes. For example, the question whether a salt combines with water molecules when dissolved in water cannot be said even yet to be fully settled, and, although there can be no doubt that solution is, in many cases, attended by chemical processes, still we possess as yet no means of deciding, with certainty, how many molecules of water have bound themselves to a single molecule of the dissolved substance (*solute*). On the other hand, we possess exact methods of testing whether gases or solutes in dilute solution react one with another and of determining the equilibrium state which is attained. For if one solute react with another on adding the latter to its solution, then corresponding to the decrease of its concentration there must also be a decrease of vapour pressure, and of solubility in other solvents; further, in the case of a mixture of gases, the concentration of each single constituent follows from its solubility in some suitable solvent. We thus obtain the answer to the question: whether the concentration of a certain constituent has decreased during mixing, *i.e.* whether it has reacted chemically.

When a compound can be obtained in a pure state, analysis affords us an important criterion of its chemical nature, for unlike mixtures, the compositions of which are always variable within wider or narrower limits, chemical compounds present definite and characteristic mass-relations, which find full expression in the atomic theory propounded by Dalton (see *ATOM*). According to this theory a mixture is the result of the mutual interpenetration of the molecules of substances, which remain unchanged as such, whilst chemical union involves changes more deeply seated, inasmuch as new molecular species appear. These new substances, if well-defined chemical compounds, have a perfectly definite composition and contain a definite, generally small, number of elementary atoms, and therefore the law of constant proportions follows at once, and the fact that only an integral number of atoms of any element may enter into the composition of any molecule determines the law of multiple proportions.

These considerations bring us face to face with the task of more closely investigating the nature of chemical forces, in other words, of answering the question: *Nature of chemical forces.* what forces guide the atoms in the formation of a new molecular species? This problem is still far from being completely answered, so that a few general remarks must suffice here.

It is remarkable that among the most stable chemical compounds, we find combinations of atoms of one and the same element. Thus, the stability of the di-atomic molecule N_2 is so great, that no trace of dissociation has yet been proved even at the highest temperatures, and as the constituent atoms of the molecule N_2 must be regarded as absolutely identical, it is clear that "polar" forces cannot be the cause of all chemical action. On the other hand, especially powerful affinities are also at work when so-called electro-positive and electro-negative elements react. The forces which here come into play appear to be considerably greater than those just mentioned; for instance, potassium fluoride is perhaps the most stable of all known compounds.

It is also to be noticed that the combinations of the electro-negative elements (metalloids) with one another exhibit a metalloid character, and also we find, in the mutual combinations of metals, all the characteristics of the metallic state; but in the formation of a *salt* from a metal and a metalloid we have an entirely new substance, quite different from its components; and at the same time, the product is seen to be an electrolyte, *i.e.* to have the power of splitting up into a positively and a negatively charged constituent when dissolved in some solvent. These considerations lead to the conviction that forces of a "polar" origin play an important part here, and indeed we may make the general surmise that in the act of chemical combination forces of both a non-polar and polar nature play a part, and that the latter are in all probability identical with the electric forces.

It now remains to be asked—what are the laws which govern

the action of these forces? This question is of fundamental importance, since it leads directly to those laws which regulate the chemical process. Besides the already mentioned fundamental law of chemical combination, that of constant and multiple proportions, there is the law of chemical mass-action, discovered by Guldberg and Waage in 1867, which we will now develop from a kinetic standpoint.

Kinetic Basis of the Law of Chemical Mass-action.—We will assume that the molecular species $A_1, A_2, \dots, A'_1, A'_2, \dots$ are present in a homogeneous system, where they can react on each other only according to the scheme

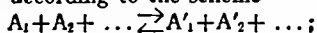

this is a special case of the general equation

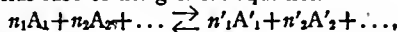

in which only one molecule of each substance takes part in the reaction. The reacting substances may be either gaseous or form a liquid mixture, or be dissolved in some selected solvent; but in each case we may state the following considerations regarding the course of the reaction. For a transformation to take place from left to right in the sense of the reaction equation, all the molecules A_1, A_2, \dots must clearly collide at one point; otherwise no reaction is possible, since we shall not consider side-reactions. Such a collision need not of course bring about that transposition of the atoms of the single molecules which constitutes the above reaction. Much rather must it be of such a kind as is favourable to that loosening of the bonds that bind the atoms in the separate molecules, which must precede this transposition. Of a large number of such collisions, therefore, only a certain smaller number will involve a transposition from left to right in the sense of the equation. But this number will be the same under the same external conditions, and the greater the more numerous the collisions; in fact a direct ratio must exist between the two. Bearing in mind now, that the number of collisions must be proportional to each of the concentrations of the bodies A_1, A_2, \dots , and therefore, on the whole, to the product of all these concentrations, we arrive at the conclusion that the velocity v of the transposition from left to right in the sense of the reaction equation is $v = k c_1 c_2 \dots$, in which c_1, c_2, \dots represent the spatial concentrations, *i.e.* the number of gram-molecules of the substances A_1, A_2, \dots present in one litre, and k is, at a given temperature, a constant which may be called the velocity-coefficient.

Exactly the same consideration applies to the molecules A'_1, A'_2, \dots . Here the velocity of the change from right to left in the sense of the reaction-equation increases with the number of collisions of all these molecules at one point, and this is proportional to the product of all the concentrations. If k' denotes the corresponding proportionality-factor, then the velocity v' of the change from right to left in the sense of the reaction-equation is $v' = k' c'_1 c'_2 \dots$. These spatial concentrations are often called the "active masses" of the reacting components. Hence the reaction-velocity in the sense of the reaction-equation from left to right, or the reverse, is proportional to the product of the "active-masses" of the left-hand or right-hand components respectively.

Neither v nor v' can be separately investigated, and the measurements of the course of a reaction always furnish only the difference of these two quantities. The reaction-velocity actually observed represents the difference of these two partial reaction-velocities, whilst the amount of change observed during any period of time is equal to the change in the one direction, minus the change in the opposite direction. It must not be assumed, however, that on the attainment of equilibrium all action has ceased, but rather that the velocity of change in one direction has become equal to that in the opposite direction, with the result that no further total change can be observed, *i.e.* the system has reached equilibrium, for which the relation $v - v' = 0$ must therefore hold, or what is the same thing

$$k c_1 c_2 \dots = k' c'_1 c'_2 \dots;$$

this is the fundamental law of chemical statics.

The conception that the equilibrium is not to be attributed to absolute indifference between the reacting bodies, but that these continue to exert their mutual actions undiminished and the opposing changes now balance, is of fundamental significance in the interpretation of changes of matter in general. This is generally expressed in the form: *the equilibrium in this and other analogous cases is not static but dynamic.* This conception was a direct result of the kinetic-molecular considerations, and was applied with special success to the development of the kinetic theory of gases. Thus with Clausius, we conceive the equilibrium of water-vapour with water, not as if neither water vaporized nor vapour condensed, but rather as though the two processes went on unhindered in the equilibrium state, *i.e.* during contact of saturated vapour with water, in a given time, as many water molecules passed through the water surface in one direction as in the opposite direction. This view, as applied to chemical changes, was first advanced by A. W. Williamson (1851), and further developed by C. M. Guldberg and P. Waage and others.

From the previous considerations it follows that the reaction-velocity at every moment, *i.e.* the velocity with which the chemical process advances towards the equilibrium state, is given by the equation

$$V = v - v' = k c_1 c_2 \dots - k' c'_1 c'_2 \dots;$$

this states the fundamental law of chemical kinetics.

The equilibrium equation is simply a special case of this more general one, and results when the total velocity is written zero, just as in analytical mechanics the equilibrium conditions follow at once by specialization of the general equations of motion.

No difficulty presents itself in the generalization of the previous equations for the reaction which proceeds after the scheme

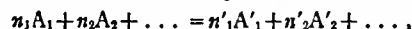

where $n_1, n_2, \dots, n'_1, n'_2, \dots$ denote the numbers of molecules of the separate substances which take part in the reaction, and are therefore whole, mostly small, numbers (generally one or two, seldom three or more). Here as before, v and v' are to be regarded as proportional to the number of collisions at one point of all molecules necessary to the respective reaction, but now n_1 molecules of A_1, n_2 molecules of $A_2, \&c.$, must collide for the reaction to advance from left to right in the sense of the equation; and similarly n'_1 molecules of A'_1, n'_2 molecules of $A'_2, \&c.$, must collide for the reaction to proceed in the opposite direction. If we consider the path of a single, arbitrarily chosen molecule over a certain time, then the number of its collisions with other similar molecules will be proportional to the concentration C of that kind of molecule to which it belongs. The number of encounters between two molecules of the kind in question, during the same time, will be in general C times as many, *i.e.* the number of encounters of two of the same molecules is proportional to the square of the concentration C ; and generally, the number of encounters of n molecules of one kind must be regarded as proportional to the n th power of C , *i.e.* C^n .

The number of collisions of n_1 molecules of A_1, n_2 molecules of A_2, \dots is accordingly proportional to $C_1^{n_1} C_2^{n_2} \dots$, and the reaction-velocity corresponding to it is therefore

$$v = k C_1^{n_1} C_2^{n_2} \dots$$

and similarly the opposed reaction-velocity is

$$v' = k' C_1^{n'_1} C_2^{n'_2} \dots;$$

the resultant reaction-velocity, being the difference of these two partial velocities, is therefore

$$V = v - v' = k C_1^{n_1} C_2^{n_2} \dots - k' C_1^{n'_1} C_2^{n'_2} \dots$$

This is the most general expression of the law of chemical mass-action, for the case of homogeneous systems.

Equating V to zero, we obtain the equation for the equilibrium state, *viz.*

$$C_1^{n_1} C_2^{n_2} \dots / C_1^{n'_1} C_2^{n'_2} \dots = k/k' = K;$$

K is called the "equilibrium-constant."

Law of chemical kinetics.

These formulæ hold for gases and for dilute solutions, but assume the system to be homogeneous, *i.e.* to be either a homogeneous gas-mixture or a homogeneous dilute solution.

Limitations and applications of the laws.

The case in which other states of matter share in the equilibrium permits of simple treatment when the substances in question may be regarded as pure, and consequently as possessing definite vapour-pressures or solubilities at a given temperature. In this case the molecular species in question, which is, at the same time, present in excess and is hence usually called a *Bodenkörper*, must possess a constant concentration in the gas-space or solution. But since the left-hand side of the last equation contains only variable quantities, it is simplest and most convenient to absorb these constant concentrations into the equilibrium-constant; whence we have the rule: leave the molecular species present as *Bodenkörper* out of account, when determining the concentration-product. Guldberg and Waage expressed this in the form "the active mass of a solid substance is constant." The same is true of liquids when these participate in the pure state in the equilibrium, and possess therefore a definite vapour-pressure or solubility. When, finally, we are not dealing with a dilute solution but with any kind of mixture whatever, it is simplest to apply the law of mass-action to the gaseous mixture in equilibrium with this. The composition of the liquid mixture is then determinable when the vapour-pressures of the separate components are known. This, however, is not often the case; but in principle this consideration is important, since it involves the possibility of extending the law of chemical mass-action from ideal gas-mixtures and dilute solutions, for which it primarily holds, to any other system whatever.

The more recent development of theoretical chemistry, as well as the detailed study of many chemical processes which have found technical application, leads more and more convincingly to the recognition that in the law of chemical mass-action we have a law of as fundamental significance as the law of constant and multiple proportions. It is therefore not without interest to briefly touch upon the development of the doctrine of chemical affinity.

Historical Development of the Law of Mass-action.—The theory developed by Torbern Olof Bergman in 1775 must be regarded as the first attempt of importance to account for the mode of action of chemical forces. The essential principle of this may be stated as follows:—The magnitude of chemical affinity may be expressed by a definite number; if the affinity of the substance A is greater for the substance B than for the substance C, then the latter (C) will be completely expelled by B from its compound with A, in the sense of the equation $A \cdot C + B = A \cdot B + C$. This theory fails, however, to take account of the influence of the relative masses of the reacting substances, and had to be abandoned as soon as such an influence was noticed. An attempt to consider this factor was made by Claude Louis Berthollet (1801), who introduced the conception of chemical equilibrium. The views of this French chemist may be summed up in the following sentence:—Different substances have different affinities for each other, which only come into play on immediate contact. The condition of equilibrium depends not only upon the chemical affinity, but also essentially upon the relative masses of the reacting substances.

Essentially, Berthollet's idea is to-day the guiding principle of the doctrine of affinity. This is especially true of our conceptions of many reactions which, in the sense of Bergman's idea, proceed to completion, *i.e.* until the reacting substances are all used up; but only for this reason, *viz.* that one or more of the products of the reaction is removed from the reaction mixture (either by crystallization, evaporation or some other process), and hence the reverse reaction becomes impossible. Following Berthollet's idea, two Norwegian investigators, C. M. Guldberg and Peter Waage, succeeded in formulating the influence of the reacting masses in a simple law—the law of chemical mass-action already defined. The results of their theoretical and experimental studies were published at Christiania in 1867 (*Études sur les affinités chimiques*); this work marks a new epoch in the

history of chemistry. Even before this, formulæ to describe the progress of certain chemical reactions, which must be regarded as applications of the law of mass-action, had been put forward by Ludwig Wilhelmy (1850), and by A. G. Vernon-Harcourt and William Esson (1856), but the service of Guldberg and Waage in having grasped the law in its full significance and logically applied it in all directions, remains of course undiminished. Their treatise remained quite unknown; and so it happened that John Hewitt Jellitt (1873), J. H. van't Hoff (1877), and others independently developed the same law. The thermodynamic basis of the law of mass-action is primarily due to Horstmann, J. Willard Gibbs and van't Hoff.

Applications.—Let us consider, as an example of the application of the law of mass-action, the case of the dissociation of water-vapour, which takes place at high temperatures in the sense of the equation $2H_2O = 2H_2 + O_2$. Representing the concentrations of the corresponding molecular species by $[H_2]$, &c., the expression $\frac{[H_2]^2 [O_2]}{[H_2O]^2}$ must be constant at any given temperature. This shows that the dissociation is set back by increasing the pressure; for if the concentrations of all three kinds of molecules be increased by strong compression, say to ten times the former amounts, then the numerator is increased one thousand, the denominator only one hundred times. Hence if the original equilibrium-constant is to hold, the dissociation must go back, and, what is more, by an exactly determinable amount. At 2000° C. water-vapour is only dissociated to the extent of a few per cent; therefore, even when only a small excess of oxygen or hydrogen be present, the numerator in the foregoing expression is much increased, and it is obvious that in order to restore the equilibrium state, the concentration of the other component, hydrogen or oxygen as the case may be, must diminish. In the case of slightly dissociated substances, therefore, even a relatively small excess of one component is sufficient to set back the dissociation substantially.

Chemical Kinetics.—It has been already mentioned that the law of chemical mass-action not only defines the conditions for chemical equilibrium, but contains at the same time the principles of chemical kinetics. The previous considerations show indeed that the actual progress of the reaction is determined by the difference of the reaction-velocities in the one and the other (opposed) direction, in the sense of the corresponding reaction-equation. Since the reaction-velocity is given by the amount of chemical change in a small interval of time, the law of chemical mass-action supplies a differential equation, which, when integrated, provides formulæ which, as numerous experiments have shown, very happily summarize the course of the reaction. For the simplest case, in which a single species of molecule undergoes almost complete decomposition, so that the reaction-velocity in the reverse direction may be neglected, we have the simple equation

$$dx/dt = k(a-x),$$

and if $x=0$ when $t=0$ we have by integration

$$k = t^{-1} \log \{a/(a-x)\}.$$

We will now apply these conclusions to the theory of the ignition of an explosive gas-mixture, and in particular to the combustion of "knallgas" (a mixture of hydrogen and oxygen) to water-vapour. At ordinary temperatures knallgas undergoes practically no change, and it might be supposed that the two gases, oxygen and hydrogen, have no affinity for each other. This conclusion, however, is shown to be incorrect by the observation that it is only necessary to add some suitable catalyst such as platinum-black in order to immediately start the reaction. We must therefore conclude that even at ordinary temperatures strong chemical affinity is exerted between oxygen and hydrogen, but that at low temperatures this encounters great frictional resistances, or in other words that the reaction-velocity is very small. It is a matter of general experience that the resistances which the chemical forces have to overcome diminish with rising temperature, *i.e.* the reaction-velocity increases with temperature. Therefore, when we warm the knallgas, the number of collisions of oxygen and hydrogen molecules favourable to the formation

Theory of explosive combustion.

of water becomes greater and greater, until at about 500° the gradual formation of water is observed, while at still higher temperatures the reaction-velocity becomes enormous. We are now in a position to understand what is the result of a strong local heating of the knallgas, as, for example, by an electric spark. The strongly heated parts of the knallgas combine to form water-vapour with great velocity and the evolution of large amounts of heat, whereby the adjacent parts are brought to a high temperature and into a state of rapid reaction, *i.e.* we observe an ignition of the whole mixture. If we suppose the knallgas to be at a very high temperature, then its combustion will be no longer complete owing to the dissociation of water-vapour, whilst at extremely high temperatures it would practically disappear. Hence it is clear that knallgas appears to be stable at low temperatures only because the reaction-velocity is very small, but that at very high temperatures it is really stable, since no chemical forces are then active, or, in other words, the chemical affinity is very small.

The determination of the question whether the failure of some reaction is due to an inappreciable reaction-velocity or to absence of chemical affinity, is of fundamental importance, and only in the first case can the reaction be hastened by catalysts.

Many chemical compounds behave like knallgas. Acetylene is stable at ordinary temperatures, inasmuch as it only decomposes slowly; but at the same time it is explosive, for the decomposition when once started is rapidly propagated, on account of the heat evolved by the splitting up of the gas into carbon and hydrogen. At very high temperatures, however, acetylene acquires real stability, since carbon and hydrogen then react to form acetylene.

Many researches have shown that the combustion of an inflammable gas-mixture which is started at a point, *e.g.* by an electric spark, may be propagated in two essentially different ways. The characteristic of the slower combustion consists in this, *viz.* that the high temperature of the previously ignited layer spreads by conduction, thereby bringing the adjacent layers to the ignition-temperature; the velocity of the propagation is therefore conditioned in the first place by the magnitude of the conductivity for heat, and more particularly, in the second place, by the velocity with which a moderately heated layer begins to react chemically, and so to rise gradually in temperature, *i.e.* essentially by the change of reaction-velocity with temperature. A second entirely independent mode of propagation of the combustion lies at the basis of the phenomenon that an explosive gas-mixture can be ignited by strong compression or—more correctly—by the rise of temperature thereby produced. The increase of the concentrations of the reacting substances consequent upon this increase of pressure raises the reaction-velocity in accordance with the law of chemical mass-action, and so enormously favours the rapid evolution of the heat of combustion.

It is therefore clear that such a powerful compression-wave can not only initiate the combustion, but also propagate it with extremely high velocity. Indeed a compression-wave of this kind passes through the gas-mixture, heated by the combustion to a very high temperature. It must, however, be propagated considerably faster than an ordinary compression-wave, for the result of ignition in the compressed (still unburnt) layer is the production of a very high pressure, which must in accordance with the principles of wave-motion increase the velocity of propagation. The absolute velocity of the explosion-wave would seem, in the light of these considerations, to be susceptible of accurate calculation. It is at least clear that it must be considerably higher than the velocity of sound in the mass of gas strongly heated by the explosion, and this is confirmed by actual measurements (see below) which show that the velocity of the explosion-wave is from one and a half times to double that of sound-waves at the combustion temperature.

We are now in a position to form the following picture of the processes which follow upon the ignition of a combustible gas-mixture contained in a long tube. First we have the condition of slow combustion; the heat is conveyed by conduction to the

adjacent layers, and there follows a velocity of propagation of a few metres per second. But since the combustion is accompanied by a high increase of pressure, the adjacent, still unburnt layers are simultaneously compressed, whereby the reaction-velocity increases, and the ignition proceeds faster. This involves still greater compression of the next layers, and so if the mixture be capable of sufficiently rapid combustion, the velocity of propagation of the ignition must continually increase. As soon as the compression in the still unburnt layers becomes so great that spontaneous ignition results, the now much more pronounced compression-waves excited with simultaneous combustion must be propagated with very great velocity, *i.e.* we have spontaneous development of an "explosion-wave." M.P.E. Berthelot, who discovered the presence of such explosion-waves, proved their velocity of propagation to be independent of the pressure, the cross-section of the tubes in which the explosive gas-mixture is contained, as well as of the material of which these are made, and concluded that this velocity is a constant, characteristic of the particular mixture. The determination of this velocity is naturally of the highest interest.

In the following table Berthelot's results are given along with the later (1891) concordant ones of H. B. Dixon, the velocities of propagation of explosions being given in metres per second.

Reacting Mixture.		Velocity of Wave in Metres per second.	
		Berthelot.	Dixon.
Hydrogen and oxygen,	H ₂ +O .	2810	2821
Hydrogen and nitrous oxide,	H ₂ +N ₂ O .	2284	2305
Methane and oxygen,	CH ₄ +4O .	2287	2322
Ethylene " "	C ₂ H ₄ +6O .	2210	2364
Acetylene " "	C ₂ H ₂ +5O .	2482	2391
Cyanogen " "	C ₂ N ₂ +4O .	2195	2321
Hydrogen and chlorine,	H ₂ +Cl ₂ .	..	1730
" " "	2H ₂ +Cl ₂ .	..	1849

The maximum pressure of the explosion-wave possesses very high values; it appears that a compression of from 1 to 30-40 atmospheres is necessary to produce spontaneous ignition of mixtures of oxygen and hydrogen. But since the heat evolved in the path of the explosion causes a rise of temperature of 2000°-3000°, *i.e.* a rise of absolute temperature about four times that directly following upon the initial compression, we are here concerned with pressures amounting to considerably more than 100 atmospheres. Both the magnitude of this pressure and the circumstance that it so suddenly arises are peculiar to the very powerful forces which distinguish the explosion-wave from the slow combustion-wave.

Nascent State.—The great reactive power of freshly formed or nascent substances (*status nascens*) may be very simply referred to the principles of mass-action. As is well known, this phenomenon is specially striking in the case of hydrogen, which may therefore be taken as a typical example. The law of mass-action affirms the action of a substance to be the greater the higher its concentration, or, for a gas, the higher its partial-pressure. Now experience teaches that those metals which liberate hydrogen from acids are able to supply the latter under extremely high pressure, and we may therefore assume that the hydrogen which results, for example, from the action of zinc upon sulphuric acid is initially under very high pressures which are then afterwards relieved. Hence the hydrogen during liberation exhibits much more active powers of reduction than the ordinary gas.

A deeper insight into the relations prevailing here is offered from the atomistic point of view. From this we are bound to conclude that the hydrogen is in the first instance evolved in the form of free atoms, and since the velocity of the reaction H+H=H₂ at ordinary temperatures, though doubtless very great, is not practically instantaneous, the freshly generated hydrogen will contain a remnant of free atoms, which are able to react both more actively and more rapidly. Similar considerations are of course applicable to other cases.

Ion-reactions.—The application of the law of chemical mass-

action is much simplified in the case in which the reaction-velocity is enormously great, when practically an instantaneous adjustment of the equilibrium results. Only in this case can the state of the system, which pertains after mixing the different components, be determined merely from knowledge of the equilibrium-constant. This case is realized in the reactions between gases at very high temperatures, which have, however, been little investigated, and especially by the reactions between electrolytes, the so-called ion-reactions. In this latter case, which has been thoroughly studied on account of its fundamental importance for inorganic qualitative and quantitative analysis, the degrees of dissociation of the various electrolytes (acids, bases and salts) are for the most part easily determined by the aid of the freezing-point apparatus, or of measurements of the electric conductivity; and from these data the equilibrium-constant K may be calculated. Moreover, it can be shown that the state of the system can be determined when the equilibrium constants of all the electrolytes which are present in the common solution are known. If this be coupled with the law that the solubility of solid substances, as with vapour-pressures, is independent of the presence of other electrolytes, it is sufficient to know the solubilities of the electrolytes in question, in order to be able to determine which substances must participate in the equilibrium in the solid state, *i.e.* we arrive at the theory of the formation and solution of precipitates.

As an illustration of the application of these principles, we shall deal with a problem of the doctrine of affinity, namely,

that of the relative strengths of acids and bases. It was quite an early and often repeated observation that the various acids and bases take part with very varying intensity or avidity in those reactions in which their acid or basic nature comes into play. No success attended the early attempts at giving numerical expression to the strengths of acids and bases, *i.e.* of finding a numerical coefficient for each acid and base, which should be the quantitative expression of the degree of its participation in those specific reactions characteristic of acids and bases respectively. Julius Thomsen and W. Ostwald attacked the problem in a far-seeing and comprehensive manner, and arrived at indisputable proof that the property of acids and bases of exerting their effects according to definite numerical coefficients finds expression not only in salt-formation but also in a large number of other, and indeed very miscellaneous, reactions.

When Ostwald compared the order of the strengths of acids deduced from their competition for the same base, as determined by Thomsen's thermo-chemical or his own volumetric method, with that order in which the acids arrange themselves according to their capacity to bring calcium oxalate into solution, or to convert acetamide into ammonium acetate, or to split up methyl acetate into methyl alcohol and acetic acid catalytically, or to invert cane-sugar, or to accelerate the mutual action of hydriodic on bromic acid, he found that in all these well-investigated and very miscellaneous cases the same succession of acids in the order of their strengths is obtained, whichever one of the above chemical processes be chosen as measure of these strengths. It is to be noticed that all these chemical changes cited took place in dilute aqueous solution, consequently the above order of acids refers only to the power to react under these circumstances. The order of acids proved to be fairly independent of temperature. While therefore the above investigations afforded a definite qualitative solution of the order of acids according to strengths, the determination of the quantitative relations offered great difficulties, and the numerical coefficients, determined from the separate reactions, often displayed great variations, though occasionally also surprising agreement. Especially great were the variations of the coefficients with the concentration, and in those cases in which the concentration of the acid changed considerably during the reaction, the calculation was naturally quite uncertain. Similar relations were found in the investigation of bases, the scope of which, however, was much more limited.

These apparently rather complicated relations were now

cleared up at one stroke, by the application of the law of chemical mass-action on the lines indicated by S. Arrhenius in 1887, when he put forward the theory of electrolytic dissociation to explain that peculiar behaviour of substances in aqueous solution first recognized by van't Hoff in 1885. The formulae which must be made use of here in the calculation of the equilibrium-relations follow naturally by simple application of the law of mass-action to the corresponding ion-concentrations.

The peculiarities which the behaviour of acids and bases presents, and, according to the theory of Arrhenius, must present—peculiarities which found expression in the very early distinction between neutral solutions on the one hand, and acid or basic ones on the other, as well as in the belief in a polar antithesis between the two last—must now, in the light of the theory of electrolytic dissociation, be conceived as follows:—

The reactions characteristic of acids in aqueous solution, which are common to and can only be brought about by acids, find their explanation in the fact that this class of bodies gives rise on dissociation to a common molecular species, namely, the positively charged hydrogen-ion (H^+). The specific chemical actions peculiar to acids are therefore to be attributed to the hydrogen-ion just as the actions common to all chlorides are to be regarded as those of the free chlorine-ions. In like manner, the reactions characteristic of bases in solution are to be attributed to the negatively charged hydroxyl-ions (OH^-), which result from the dissociation of this class of bodies.

A solution has an acid reaction when it contains an excess of hydrogen-ions, and a basic reaction when it contains an excess of hydroxyl-ions. If an acid and an alkaline solution be brought together mutual neutralization must result, since the positive H-ions and the negative OH-ions cannot exist together in view of the extremely weak conductivity of pure water and its consequent slight electrolytic dissociation, and therefore they must at once combine to form electrically neutral molecules, in the sense of the equation

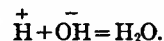

In this lies the simple explanation of the "polar" difference between acid and basic solutions. This rests essentially upon the fact that the ion peculiar to acids and the ion peculiar to bases form the two constituents of water, *i.e.* of that solvent in which we usually study the course of the reaction. The idea of the "strength" of an acid or base at once arises. If we compare equivalent solutions of various acids, the intensity of those actions characteristic of them will be the greater the more free hydrogen-ions they contain; this is an immediate consequence of the law of chemical mass-action. The degree of electrolytic dissociation determines, therefore, the strength of acids, and a similar consideration leads to the same result for bases.

Now the degree of electrolytic dissociation changes with concentration in a regular manner, which is given by the law of mass-action. For if C denote the concentration of the electrolyte and a its degree of dissociation, the above law states that

$$C^2 a^2 / C(1-a) = Ca^2 / (1-a) = K.$$

At very great dilutions the dissociation is complete, and equivalent solutions of the most various acids then contain the same number of hydrogen-ions, or, in other words, are equally strong; and the same is true of the hydroxyl-ions of bases. The dissociation also decreases with increasing concentration, but at different rates for different substances, and the relative "strengths" of acids and bases must hence change with concentration, as was indeed found experimentally. The dissociation-constant K is the measure of the variation of the degree of dissociation with concentration, and must therefore be regarded as the measure of the strengths of acids and bases. So that in this special case we are again brought to the result which was stated in general terms above, *viz.* that the dissociation-coefficient forms the measure of the reactivity of a dissolved electrolyte. Ostwald's series of acids, based upon the investigation of the most various reactions, should therefore correspond with the order of their dissociation-constants, and further with the

order of their freezing-point depressions in equivalent solutions, since the depression of the freezing-point increases with the degree of electrolytic dissociation. Experience confirms this conclusion completely. The degree of dissociation of an acid, at a given concentration, for which its molecular conductivity is Λ , is shown by the theory of electrolytic dissociation to be $\alpha = \Lambda / \Lambda_{\infty}$; Λ_{∞} , the molecular conductivity at very great dilution in accordance with the law of Kohlrausch, is $u + v$, where u and v are the ionic-mobilities (see CONDUCTION, ELECTRIC). Since u , the ionic-mobility of the hydrogen ion, is generally more than ten times as great as v , the ionic-mobility of the negative acid-radical, Λ_{∞} has approximately the same value (generally within less than 10%) for the different acids, and the molecular-conductivity of the acids in equivalent concentration is at least approximately proportional to the degree of electrolytic dissociation, *i.e.* to the strength.

In general, therefore, the order of conductivities is identical with that in which the acids exert their specific powers. This remarkable parallelism, first perceived by Arrhenius and Ostwald in 1885, was the happy development which led to the discovery of electrolytic dissociation (see CONDUCTION, ELECTRIC; and SOLUTION).

Catalysis.—We have already mentioned the fact, early known to chemists, that many reactions proceed with a marked increase of velocity in presence of many foreign substances. With Berzelius we call this phenomenon "catalysis," by which we understand that general acceleration of reactions which also progress when left to themselves, in the presence of certain bodies which do not change in amount (or only slightly) during the course of the reaction. Acids and bases appear to act catalytically upon all reactions involving consumption or liberation of water, and indeed that action is proportional to the concentration of the hydrogen or hydroxyl-ions. Further, the decomposition of hydrogen peroxide is "catalysed" by iodine ions, the condensation of two molecules of benzaldehyde to benzoin by cyanogen-ions. One of the earliest known and technically most important instances of catalysis is that of the oxidation of sulphur dioxide to sulphuric acid by oxygen in the presence of oxides of nitrogen. Other well-known and remarkable examples are the catalysis of the combustion of hydrogen and of sulphur dioxide in oxygen by finely-divided platinum. We may also mention the interesting work of Dixon and Baker, which led to the discovery that a large number of gas-reactions, *e.g.* the combustion of carbon monoxide, the dissociation of sal-ammoniac vapour, and the action of sulphuretted hydrogen upon the salts of heavy metals, cease when water-vapour is absent, or at least proceed with greatly diminished velocity.

"Negative catalysis," *i.e.* the retardation of a reaction by addition of some substance, which is occasionally observed, appears to depend upon the destruction of a "positive catalyte" by the body added.

A catalyte can have no influence, however, upon the affinity of a process, since that would be contrary to the second law of thermodynamics, according to which affinity of an isothermal process, which is measured by the maximum work, only depends upon the initial and final states. The effect of a catalyte is therefore limited to the resistances opposing the progress of a reaction, and does not influence its driving-force or affinity. Since the catalyte takes no part in the reaction its presence has no effect on the equilibrium-constant. This, in accordance with the law of mass-action, is the ratio of the separate reaction-velocities in the two contrary directions. A catalyte must therefore always accelerate the reverse-reaction. If the velocity of formation of a body be increased by addition of some substance then its velocity of decomposition must likewise increase. We have an example of this in the well-known fact that the formation, and no less the saponification, of esters, proceeds with increased velocity in the presence of acids, while the observation that in absence of water-vapour neither gaseous ammonium chloride dissociates nor dry ammonia combines with hydrogen chloride becomes clear on the same grounds.

A general theory of catalytic phenomena does not at present

exist. The formation of intermediate products by the action of the reacting substance upon the catalyte has often been thought to be the cause of these. These intervening products, whose existence in many cases has been proved, then split up into the catalyte and the reaction-product. Thus chemists have sought to ascribe the influence of oxides of nitrogen on the formation of sulphuric acid to the initial formation of nitrosyl-sulphuric acid, $\text{SO}_2(\text{OH})(\text{NO}_2)$, from the mixture of sulphur dioxide, oxides of nitrogen and air, which then reacted with water to form sulphuric and nitrous acids. When the velocity of such intermediate reactions is greater than that of the total change, such an explanation may suffice, but a more certain proof of this theory of catalysis has only been reached in a few cases, though in many others it appears very plausible. Hence it is hardly possible to interpret all catalytic processes on these lines.

In regard to catalysis in heterogeneous systems, especially the hastening of gas-reactions by platinum, it is very probable that it is closely connected with the solution or absorption of the gases on the part of the metal. From the experiments of G. Bredig it seems that colloidal solutions of a metal act like the metal itself. The action of a colloidal-platinum solution on the decomposition of hydrogen peroxide is still sensible even at a dilution of 1/70,000,000 grm.-mol. per litre; indeed the activity of this colloidal-platinum solution calls to mind in many ways that of organic ferments, hence Bredig has called it an "inorganic ferment." This analogy is especially striking in the change of their activity with time and temperature, and in the possibility, by means of bodies like sulphuretted hydrogen, hydrocyanic acid, &c., which act as strong poisons upon the latter, of "poisoning" the former also, *i.e.* of rendering it inactive. In the case of the catalytic action of water-vapour upon many processes of combustion already mentioned, a part of the effect is probably due to the circumstance, disclosed by numerous experiments, that the union of hydrogen and oxygen proceeds, between certain temperature limits at least, after the equation $\text{H}_2 + \text{O}_2 = \text{H}_2\text{O}_2$, that is, with the preliminary formation of hydrogen peroxide, which then breaks down into water and oxygen, and further, above all, to the fact that this substance results from oxygen and water at high temperatures with great velocity, though indeed only in small quantities.

The view now suggests itself, that, for example, in the combustion of carbon monoxide at moderately high temperatures, the reaction



advances with imperceptible speed, but that on the contrary the two stages

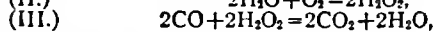
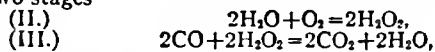

which together result in (I.), proceed rapidly even at moderate temperatures.

Temperature and Reaction-Velocity.—There are few natural constants which undergo so marked a change with temperature as those of the velocities of chemical changes. As a rule a rise of temperature of 10° causes a twofold or threefold rise of reaction-velocity.

If the reaction-coefficient k , in the sense of the equation derived above, *viz.* $k = t^{-1} \log \{a/(a-x)\}$, be determined for the inversion of cane-sugar by an acid of given concentration, the following values are obtained:—

Temperature = 25°	40°	45°	50°	55°
k = 9.7	73	139	268	491;

here a rise of temperature of only 30° suffices to raise the speed of inversion fifty times.

We possess no adequate explanation of this remarkable temperature influence; but some account of it is given by the molecular theory, according to which the energy of that motion of substances in homogeneous gaseous or liquid systems which constitutes heat increases with the temperature, and hence also the frequency of collision of the reacting substances. When we reflect that the velocity of motion of the molecules of gases, and in all probability those of liquids also, are proportional to the square root of the absolute temperature, and therefore rise by

only $\frac{1}{2}\%$ per degree at room-temperature, and that we must assume the number of collisions proportional to the velocity of the molecules, we cannot regard the actually observed increase of reaction-velocity, which often amounts to 10 or 12 % per degree, as exclusively due to the quickening of the molecular motion by heat. It is more probable that the increase of the kinetic energy of the atomic motions within the molecule itself is of significance here, as the rise of the specific heat of gases with temperature seems to show. The change of the reaction-coefficient k with temperature may be represented by the empirical equation $\log k = -AT^{-1} + B + CT$, where A, B, C are positive constants. For low temperatures the influence of the last term is as a rule negligible, whilst for high temperatures the first term on the right side plays a vanishingly small part.

Definition of Chemical Affinity.—We have still to discuss the question of what is to be regarded as the measure of chemical affinity. Since we are not in a position to measure directly the intensity of chemical forces, the idea suggests itself to determine the strength of chemical affinity from the amount of the work which the corresponding reaction is able to do. To a certain extent the evolution of heat accompanying the reaction is a measure of this work, and attempts have been made to measure chemical affinities thermo-chemically, though it may be easily shown that this definition was not well chosen. For when, as is clearly most convenient, affinity is so defined that it determines under all circumstances the direction of chemical change, the above definition fails in so far as chemical processes often take place with absorption of heat, that is, contrary to affinities so defined. But even in those cases in which the course of the reaction at first proceeds in the sense of the evolution of heat, it is often observed that the reaction advances not to completion but to a certain equilibrium, or, in other words, stops before the evolution of heat is complete.

A definition free from this objection is supplied by the second law of thermodynamics, in accordance with which all processes must take place in so far as they are able to do external work. When therefore we identify chemical affinity with the maximum work which can be gained from the process in question, we reach such a definition that the direction of the process is under all conditions determined by the affinity. Further, this definition has proved serviceable in so far as the maximum work in many cases may be experimentally measured, and moreover it stands in a simple relation to the equilibrium constant K . Thermodynamics teaches that the maximum work A may be expressed as $A = RT \log K$, when R denotes the gas-constant, T the absolute temperature. In this it is further assumed that both the molecular species produced as well as those that disappear are present in unit concentration. The simplest experimental method of directly determining chemical affinity consists in the measurement of electromotive force. The latter at once gives us the work which can be gained when the corresponding galvanic element supplies the electricity, and, since the chemical exchange of one gram-equivalent from Faraday's law requires 96,540 coulombs, we obtain from the product of this number and the electromotive force the work per gram-equivalent in watt-seconds, and this quantity when multiplied by 0.23872 is obtained in terms of the usual unit, the gram-calorie. Experience teaches that, especially when we have to deal with strong affinities, the affinity so determined is for the most part almost the same as the heat-evolution, whilst in the case in which only solid or liquid substances in the pure state take part in the reaction at low temperatures, heat-evolution and affinity appear to possess a practically identical value.

Hence it seems possible to calculate equilibria for low temperatures from heats of reaction, by the aid of the two equations

$$A = Q, \quad A = RT \log K;$$

and since the change of A with temperature, as required by the principles of thermodynamics, follows from the specific heats of the reacting substances, it seems further possible to calculate chemical equilibria from heats of reaction and specific heats. The circumstance that chemical affinity and heat-evolution so nearly coincide at low temperatures may be derived from the

hypothesis that chemical processes are the result of forces of attraction between the atoms of the different elements. If we may disregard the kinetic energy of the atoms, and this is legitimate for low temperatures, it follows that both heat-evolution and chemical affinity are merely equal to the decrease of the potential energy of the above-mentioned forces, and it is at once clear that the evolution of heat during a reaction between only pure solid or pure liquid substances possesses special importance.

More complicated is the case in which gases or dissolved substances take part. This is simplified if we first consider the mixing of two mutually chemically indifferent gases. Thermodynamics teaches that external work may be gained by the mere mixing of two such gases (see DIFFUSION), and these amounts of work, which assume very considerable proportions at high temperatures, naturally affect the value of the maximum work and so also of the affinity, in that they always come into play when gases or solutions react. While therefore we regard as chemical affinity in the strictest sense the decrease of potential energy of the forces acting between the atoms, it is clear that the quantities here involved exhibit the simplest relations under the experimental conditions just given, for when only substances in a pure state take part in a reaction, all mixing of different kinds of molecules is excluded; moreover, the circumstance that the respective substances are considered at very low temperatures reduces the quantities of energy absorbed as kinetic energy by their molecules to the smallest possible amount.

Chemical Resistance.—When we know the chemical affinity of a reaction, we are in a position to decide in which direction the process must advance, but, unless we know the reaction-velocity also, we can in many cases say nothing as to whether or not the reaction in question will progress with a practically inappreciable velocity so that apparent chemical indifference is the result. This question may be stated in the light of the law of mass-action briefly as follows:—From a knowledge of the chemical affinity we can calculate the equilibrium, *i.e.* the numerical value of the constant $K = k/k'$; but to be completely informed of the process we must know not only the ratio of the two velocity-constants k and k' , but also the separate absolute values of the same.

In many respects the following view is more comprehensive, though naturally in harmony with the one just expressed. Since the chemical equilibrium is periodically attained, it follows that, as in the case of the motion of a body or of the diffusion of a dissolved substance, it must be opposed by very great friction. In all these cases the velocity of the process at every instant is directly proportional to the driving-force and inversely proportional to the frictional resistance. We hence arrive at the result that an equation of the form

$$\text{reaction-velocity} = \text{chemical force} / \text{chemical resistance}$$

must also hold for chemical change; here we have an analogy with Ohm's law. The "chemical force" at every instant may be calculated from the maximum work (affinity); as yet little is known about "chemical resistance," but it is not improbable that it may be directly measured or theoretically deduced. The problem of the calculation of chemical reaction-velocity in absolute measure would then be solved; so far we possess indeed only a few general facts concerning the magnitude of chemical resistance. It is immeasurably small at ordinary temperatures for ion-reactions, and, on the other hand, fairly large for nearly all reactions in which carbon-bonds must be loosened (so-called "inertia of the carbon-bond") and possesses very high values for most gas-reactions also. With rising temperature it always strongly diminishes, on the other hand, at very low temperatures its values are always enormous, and at the absolute zero of temperature may be infinitely great. Therefore at that temperature all reactions cease, since the denominator in the above expression assumes enormous values.

It is a very remarkable phenomenon that the chemical resistance is often small in the case of precisely those reactions in which the affinity is also small, to this circumstance is to be traced the fact that in many chemical changes the most stable condition is not at once reached, but is preceded by the formation

of more or less unstable intermediate products. Thus the unstable ozone is very often first formed on the evolution of oxygen, whilst in the reaction between oxygen and hydrogen water is often not at once formed, but first the unstable hydrogen peroxide as an intermediate product.

Let us now consider the chemical process in the light of the equation

$$\text{reaction-velocity} = \frac{\text{chemical force}}{\text{chemical resistance.}}$$

Thermodynamics shows that at very low temperatures, *i.e.* in the immediate vicinity of the absolute zero, there is no equilibrium, but every chemical process advances to completion in the one or the other direction. The chemical forces therefore act in the one direction towards complete consumption of the reacting substance. But since the chemical resistance is now immensely great, they can produce practically no appreciable result.

At higher temperatures the reaction always proceeds, at least in homogeneous systems, to a certain equilibrium, and as the chemical resistance now has finite values this equilibrium will always finally be reached after a longer or shorter time. Finally, at very high temperatures the chemical resistance is in every case very small, and the equilibrium is almost instantaneously reached; at the same time, the affinity of the reaction, as in the case of the mutual affinity between oxygen and hydrogen, may very strongly diminish, and we have then chemical indifference again, not because, as at low temperatures, the denominator of the previous expression becomes very great, but because the numerator now assumes vanishingly small values. (W. N.)

CHEMISTRY (formerly "chymistry"; Gr. *χημεία*; for derivation see **ALCHEMY**), the natural science which has for its province the study of the composition of substances. In common with physics it includes the determination of properties or characters which serve to distinguish one substance from another, but while the physicist is concerned with properties possessed by all substances and with processes in which the molecules remain intact, the chemist is restricted to those processes in which the molecules undergo some change. For example, the physicist determines the density, elasticity, hardness, electrical and thermal conductivity, thermal expansion, &c.; the chemist, on the other hand, investigates changes in composition, such as may be effected by an electric current, by heat, or when two or more substances are mixed. A further differentiation of the provinces of chemistry and physics is shown by the classifications of matter. To the physicist matter is presented in three leading forms—solids, liquids and gases; and although further subdivisions have been rendered necessary with the growth of knowledge the same principle is retained, namely, a classification based on properties having no relation to composition. The fundamental chemical classification of matter, on the other hand, recognizes two groups of substances, namely, *elements*, which are substances not admitting of analysis into other substances, and *compounds*, which do admit of analysis into simpler substances and also of synthesis from simpler substances. Chemistry and physics, however, meet on common ground in a well-defined branch of science, named physical chemistry, which is primarily concerned with the correlation of physical properties and chemical composition, and, more generally, with the elucidation of natural phenomena on the molecular theory.

It may be convenient here to state how the whole subject of chemistry is treated in this edition of the *Encyclopaedia Britannica*. The present article includes the following sections:—

I. *History*.—This section is confined to tracing the general trend of the science from its infancy to the foundations of the modern theory. The history of the alchemical period is treated in more detail in the article **ALCHEMY**, and of the iatrochemical in the article **MEDICINE**. The evolution of the notion of elements is treated under **ELEMENT**; the molecular hypothesis of matter under **MOLECULE**; and the genesis of, and deductions from, the atomic theory of Dalton receive detailed analysis in the article **ATOM**.

II. *Principles*.—This section treats of such subjects as nomenclature, formulae, chemical equations, chemical change and similar subjects. It is intended to provide an introduction, necessarily brief, to the terminology and machinery of the chemist.

III. *Inorganic Chemistry*.—Here is treated the history of descriptive inorganic chemistry; reference should be made to the articles on the separate elements for an account of their preparation, properties, &c.

IV. *Organic Chemistry*.—This section includes a brief history of the subject, and proceeds to treat of the principles underlying the structure and interrelations of organic compounds.

V. *Analytical Chemistry*.—This section treats of the qualitative detection and separation of the metals, and the commoner methods employed in quantitative analysis. The analysis of organic compounds is also noticed.

VI. *Physical Chemistry*.—This section is restricted to an account of the relations existing between physical properties and chemical composition. Other branches of this subject are treated in the articles **CHEMICAL ACTION**; **ENERGETICS**; **SOLUTION**; **ALLOYS**; **THERMOCHEMISTRY**.

I. HISTORY

Although chemical actions must have been observed by man in the most remote times, and also utilized in such processes as the extraction of metals from their ores and in the arts of tanning and dyeing, there is no evidence to show that, beyond an unordered accumulation of facts, the early developments of these industries were attended by any real knowledge of the nature of the processes involved. All observations were the result of accident or chance, or possibly in some cases of experimental trial, but there is no record of a theory or even a general classification of the phenomena involved, although there is no doubt that the ancients had a fair knowledge of the properties and uses of the commoner substances. The origin of chemistry is intimately bound up with the arts which we have indicated; in this respect it is essentially an experimental science. A unifying principle of chemical and physical changes was provided by metaphysical conceptions of the structure of matter. We find the notion of "elements," or primary qualities, which confer upon all species of matter their distinctive qualities by appropriate combination, and also the doctrine that matter is composed of minute discrete particles, prevailing in the Greek schools. These "elements," however, had not the significance of the elements of to-day; they connoted physical appearances or qualities rather than chemical relations; and the atomic theory of the ancients is a speculation based upon metaphysical considerations, having, in its origin, nothing in common with the modern molecular theory, which was based upon experimentally observed properties of gases (see **ELEMENT**; **MOLECULE**).

*Greek
philosophy.*

Although such hypotheses could contribute nothing directly to the development of a science which laid especial claim to experimental investigations, yet indirectly they stimulated inquiry into the nature of the "essence" with which the four "elements" were associated. This *quinta essentia* had been speculated upon by the Greeks, some regarding it as immaterial or aetherial, and others as material; and a school of philosophers termed alchemists arose who attempted the isolation of this essence. The existence of a fundamental principle, unalterable and indestructible, prevailing alike through physical and chemical changes, was generally accepted. Any change which a substance may chance to undergo was simply due to the discarding or taking up of some proportion of the primary "elements" or qualities: of these coverings "water," "air," "earth" and "fire" were regarded as clinging most tenaciously to the essence, while "cold," "heat," "moistness" and "dryness" were more easily cast aside or assumed. Several origins have been suggested for the word alchemy, and there seems to have been some doubt as to the exact nature and import of the alchemical doctrines. According to M. P. E. Berthelot, "alchemy rested partly on the industrial processes of the ancient Egyptians, partly on the speculative theories of the Greek philosophers, and partly on the mystical reveries of the Gnostics and Alexandrians." The search for this essence subsequently resolved itself into the desire to effect the transmutation of metals, more especially the base metals, into silver and gold. It seems that this secondary principle became the dominant idea in alchemy, and in this sense the word is used in Byzantine literature of the 4th century; Suidas, writing in

the 11th century, defines chemistry as the "preparation of silver and gold" (see *ALCHEMY*).

From the Alexandrians the science passed to the Arabs, who made discoveries and improved various methods of separating substances, and afterwards, from the 11th century, became seated in Europe, where the alchemical doctrines were assiduously studied until the 15th and 16th centuries. It is readily understood why men imbued with the authority of tradition should prosecute the search for a substance which would confer unlimited wealth upon the fortunate discoverer. Some alchemists honestly laboured to effect the transmutation and to discover the "philosopher's stone," and in many cases believed that they had achieved success, if we may rely upon writings assigned to them. The period, however, is one of literary forgeries; most of the MSS. are of uncertain date and authorship, and moreover are often so vague and mystical that they are of doubtful scientific value, beyond reflecting the tendencies of the age. The retaining of alchemists at various courts shows the high opinion which the doctrines had gained. It is really not extraordinary that Isaac Hollandus was able to indicate the method of the preparation of the "philosopher's stone" from "adamic" or "virgin" earth, and its action when medicinally employed; that in the writings assigned to Roger Bacon, Raimon Lull, Basil Valentine and others are to be found the exact quantities of it to be used in transmutation; and that George Ripley, in the 15th century, had grounds for regarding its action as similar to that of a ferment.

In the view of some alchemists, the ultimate principles of matter were Aristotle's four elements; the proximate constituents were a "sulphur" and a "mercury," the father and mother of the metals; gold was supposed to have attained to the perfection of its nature by passing in succession through the forms of lead, brass and silver; gold and silver were held to contain very pure red sulphur and white quicksilver, whereas in the other metals these materials were coarser and of a different colour. From an analogy instituted between the healthy human being and gold, the most perfect of the metals, silver, mercury, copper, iron, lead and tin, were regarded in the light of lepers that required to be healed.

Notwithstanding the false idea which prompted the researches of the alchemists, many advances were made in descriptive chemistry, the metals and their salts receiving much *latro-chemistry.* attention, and several of our important acids being discovered. Towards the 16th century the failure of the alchemists to achieve their cherished purpose, and the general increase of medical knowledge, caused attention to be given to the utilization of chemical preparations as medicines. As early as the 15th century the alchemist Basil Valentine had suggested this application, but the great exponent of this doctrine was Paracelsus, who set up a new definition: "The true use of chemistry is not to make gold but to prepare medicines." This relation of chemistry to medicine prevailed until the 17th century, and what in the history of chemistry is termed the iatrochemical period (see *MEDICINE*) was mainly fruitful in increasing the knowledge of compounds; the contributions to chemical theory are of little value, the most important controversies ranging over the nature of the "elements," which were generally akin to those of Aristotle, modified so as to be more in accord with current observations. At the same time, however, there were many who, opposed to the Paracelsian definition of chemistry, still laboured at the problem of the alchemists, while others gave much attention to the chemical industries. Metallurgical operations, such as smelting, roasting and refining, were scientifically investigated, and in some degree explained, by Georg Agricola and Carlo Biringuccio; ceramics was studied by Bernard Palissy, who is also to be remembered as an early worker in agricultural chemistry, having made experiments on the effect of manures on soils and crops; while general technical chemistry was enriched by Johann Rudolf Glauber.¹

¹ The more notable chemists of this period were Turquet de Mayerne (1573-1665), a physician of Paris, who rejected the Galenian doctrines and accepted the exaggerations of Paracelsus; Andreas

The second half of the 17th century witnessed remarkable transitions and developments in all branches of natural science, and the facts accumulated by preceding generations during their generally unordered researches were re-*Boyle* placed by a co-ordination of experiment and deduction. From the mazy and incoherent alchemical and iatrochemical doctrines, the former based on false conceptions of matter, the latter on erroneous views of life processes and physiology, a new science arose—the study of the composition of substances. The formulation of this definition of chemistry was due to Robert Boyle. In his *Sceptical Chemist* (1662) he freely criticized the prevailing scientific views and methods, with the object of showing that true knowledge could only be gained by the logical application of the principles of experiment and deduction. Boyle's masterly exposition of this method is his most important contribution to scientific progress. At the same time he clarified the conception of elements and compounds, rejecting the older notions, the four elements of the "vulgar Peripateticks" and the three principles of the "vulgar Stagyrists," and defining an element as a substance incapable of decomposition, and a compound as composed of two or more elements. He explained chemical combination on the hypotheses that matter consisted of minute corpuscles, that by the coalescence of corpuscles of different substances distinctly new corpuscles of a compound were formed, and that each corpuscle had a certain affinity for other corpuscles.

Although Boyle practised the methods which he expounded, he was unable to gain general acceptance of his doctrine of elements; and, strangely enough, the theory which next dominated chemical thought was an alchemical *Phlogistic theory.* invention, and lacked the lucidity and perspicuity of Boyle's views. This theory, named the phlogistic theory, was primarily based upon certain experiments on combustion and calcination, and in effect reduced the number of the alchemical principles, while setting up a new one, a principle of combustibility, named phlogiston (from *φλογιστός*, burnt). Much discussion had centred about fire or the "igneous principle." On the one hand, it had been held that when a substance was burned or calcined, it combined with an "air"; on the other hand, the operation was supposed to be attended by the destruction or loss of the igneous principle. Georg Ernst Stahl, following in some measure the views held by Johann Joachim Becher, as, for instance, that all combustibles contain a "sulphur" (which notion is itself of older date than Becher's *terra pinguis*), regarded all substances as capable of resolution into two components, the inflammable principle phlogiston, and another element—"water," "acid" or "earth." The violence or completeness of combustion was proportional to the amount of phlogiston present. Combustion meant the liberation of phlogiston. Metals on calcination gave calces from which the metals could be recovered by adding phlogiston, and experiment showed that this could generally be effected by the action of coal or carbon, which was therefore regarded as practically pure phlogiston; the other constituent being regarded as an acid. At the hands of Stahl and his school, the phlogistic theory, by exhibiting a fundamental similarity between all processes of combustion and by its remarkable flexibility, came to be a general theory of chemical action. The objections of the antiphlogistonists, such as the fact that calces weigh more than the original metals instead of less as the theory suggests, were answered by postulating that phlogiston was a principle of levity, or even completely ignored as an accident, the change of *qualities* being regarded as the only matter of importance. It is remarkable that this theory should have gained the esteem of the notable chemists who flourished in the 18th century. Henry Cavendish, a careful and accurate experimenter, was a phlogistonist, as were J. Black, K. W. Scheele, A. S. Marggraf, J. Priestley and many others who might be mentioned.

Libavius (d. 1616), chiefly famous for his *Opera Omnia Medicochymica* (1595); Jean Baptiste van Helmont (1577-1644), celebrated for his researches on gases; F. de la Boë Sylvius (1614-1672), who regarded medicine as applied chemistry; and Otto Tachenius, who elucidated the nature of salts.

Descriptive chemistry was now assuming considerable proportions; the experimental inquiries suggested by Boyle were being assiduously developed; and a wealth of observations was being accumulated, for the explanation of which the resources of the dominant theory were sorely taxed. To quote Antoine Laurent Lavoisier, "...chemists have turned phlogiston into a vague principle, ... which consequently adapts itself to all the explanations for which it may be required. Sometimes this principle has weight, and sometimes it has not; sometimes it is free fire and sometimes it is fire combined with the earthy element; sometimes it passes through the pores of vessels, sometimes these are impervious to it; it explains both causticity and non-causticity, transparency and opacity, colours and their absence; it is a veritable Proteus changing in form at each instant." Lavoisier may be justly regarded as the founder of modern or quantitative chemistry. First and foremost, he demanded that the balance must be used in all investigations into chemical changes. He established as fundamental that combustion and calcination were attended by an increase of weight, and concluded, as did Jean Rey and John Mayow in the 17th century, that the increase was due to the combination of the metal with the air. The problem could obviously be completely solved only when the composition of the air, and the parts played by its components, had been determined. At all times the air had received attention, especially since van Helmont made his far-reaching investigations on gases. Mayow had suggested the existence of two components, a *spiritus nitro-aeris* which supported combustion, and a *spiritus nitri acidi* which extinguished fire; J. Priestley and K. W. Scheele, although they isolated oxygen, were fogged by the phlogistic tenets; and H. Cavendish, who had isolated the nitrogen of the atmosphere, had failed to decide conclusively what had really happened to the air which disappeared during combustion.

Lavoisier adequately recognized and acknowledged how much he owed to the researches of others; to himself is due the co-ordination of these researches, and the welding of his results into a doctrine to which the phlogistic theory ultimately succumbed. He burned phosphorus in air standing over mercury, and showed that (1) there was a limit to the amount of phosphorus which could be burned in the confined air, (2) that when no more phosphorus could be burned, one-fifth of the air had disappeared, (3) that the weight of the air lost was nearly equal to the difference in the weights of the white solid produced and the phosphorus burned, (4) that the density of the residual air was less than that of ordinary air. The same results were obtained with lead and tin; and a more elaborate repetition indubitably established their correctness. He also showed that on heating mercury calx alone an "air" was liberated which differed from other "airs," and was slightly heavier than ordinary air; moreover, the weight of the "air" set free from a given weight of the calx was equal to the weight taken up in forming the calx from mercury, and if the calx be heated with charcoal, the metal was recovered and a gas named "fixed air," the modern carbon dioxide, was formed. The former experiment had been performed by Scheele and Priestley, who had named the gas "phlogisticated air"; Lavoisier subsequently named it oxygen, regarding it as the "acid producer" (*ὀξύς*, sour). The theory advocated by Lavoisier came to displace the phlogistic conception; but at first its acceptance was slow. Chemical literature was full of the phlogistic modes of expression—oxygen was "dephlogisticated air," nitrogen "phlogisticated air," &c.—and this tended to retard its promotion. Yet really the transition from the one theory to the other was simple, it being only necessary to change the "addition or loss of phlogiston" into the "loss or addition of oxygen." By his insistence upon the use of the balance as a quantitative check upon the masses involved in all chemical reactions, Lavoisier was enabled to establish by his own investigations and the results achieved by others the principle now known as the "conservation of mass." Matter can neither be created nor destroyed; however a chemical system be changed, the weights before and after are

equal.¹ To him is also due a rigorous examination of the nature of elements and compounds; he held the same views that were laid down by Boyle, and with the same prophetic foresight predicted that some of the elements which he himself accepted might be eventually found to be compounds.

It is unnecessary in this place to recapitulate the many results which had accumulated by the end of the 18th century, or to discuss the labours and theories of individual workers since these receive attention under biographical headings; in this article only the salient features in the history of our science can be treated. The beginning of the 19th century was attended by far-reaching discoveries in the nature of the composition of compounds. Investigations proceeded in two directions:—(1) the nature of chemical affinity, (2) the laws of chemical combination. The first question has not yet been solved, although it has been speculated upon from the earliest times. The alchemists explained chemical action by means of such phrases as "like attracts like," substances being said to combine when one "loved" the other, and the reverse when it "hated" it. Boyle rejected this terminology, which was only strictly applicable to intelligent beings; and he used the word "affinity" as had been previously done by Stahl and others. The modern sense of the word, viz. the force which holds chemically dissimilar substances together (and also *similar* substances as is seen in di-, tri-, and poly-atomic molecules), was introduced by Hermann Boerhaave, and made more precise by Sir Isaac Newton. The laws of chemical combination were solved, in a measure, by John Dalton, and the solution expressed as Dalton's "atomic theory." Lavoisier appears to have assumed that the composition of every chemical compound was constant, and the same opinion was the basis of much experimental inquiry at the hands of Joseph Louis Proust during 1801 to 1809, who vigorously combated the doctrine of Claude Louis Berthollet (*Essai de statique chimique*, 1803), viz. that fixed proportions of elements and compounds combine only under exceptional conditions, the general rule being that the composition of a compound may vary continuously between certain limits.²

This controversy was unfinished when Dalton published the first part of his *New System of Chemical Philosophy* in 1808, although the *per saltum* theory was the most popular. Led thereto by speculations on gases, Dalton assumed that matter was composed of atoms, that in the elements the atoms were simple, and in compounds complex, being composed of elementary atoms. Dalton furthermore perceived that the same two elements or substances may combine in different proportions, and showed that these proportions had always a simple ratio to one another. This is the "law of multiple proportions." He laid down the following arbitrary rules for determining the number of atoms in a compound:—if only one compound of two elements exists, it is a binary compound and its atom is composed of one atom of each element; if two compounds exist one is binary (say A + B) and the other ternary (say A + 2B); if three, then one is binary and the others may be ternary (A + 2B, and 2A + B), and so on. More important is his deduction of equivalent weights, *i.e.* the relative weights of atoms. He took hydrogen, the lightest substance known, to be the standard. From analyses of water, which he regarded as composed of one atom of hydrogen and one of oxygen, he

¹ This dictum was questioned by the researches of H. Landolt, A. Heydweiller and others. In a series of 75 reactions it was found that in 61 there was apparently a diminution in weight, but in 1908, after a most careful repetition and making allowance for all experimental errors, Landolt concluded that no change occurred (see ELEMENT).

² The theory of Berthollet was essentially mechanical, and he attempted to prove that the course of a reaction depended not on affinities alone but also on the masses of the reacting components. In this respect his hypothesis has much in common with the "law of mass-action" developed at a much later date by the Swedish chemists Guldberg and Waage, and the American, Willard Gibbs (see CHEMICAL ACTION). In his classical thesis Berthollet vigorously attacked the results deduced by Bergman, who had followed in his table of elective attractions the path traversed by Stahl and S. F. Geoffroy.

Chemical
affinity.

Dalton.

deduced the relative weight of the oxygen atom to be 6.5; from marsh gas and olefiant gas he deduced carbon = 5, there being one atom of carbon and two of hydrogen in the former and one atom of hydrogen to one of carbon in the latter; nitrogen had an equivalent of 5, and so on.¹

The value of Dalton's generalizations can hardly be over-estimated, notwithstanding the fact that in several cases they needed correction. The first step in this direction was effected by the co-ordination of Gay Lussac's observations on the combining volumes of gases. He discovered that gases always combined in volumes having simple ratios, and that the volume of the product had a simple ratio to the volumes of the reacting gases. For example, one volume of oxygen combined with two of hydrogen to form two volumes of steam, three volumes of hydrogen combined with one of nitrogen to give two volumes of ammonia, one volume of hydrogen combined with one of chlorine to give two volumes of hydrochloric acid. An immediate inference was that the Daltonian "atom" must have parts which enter into combination with parts of other atoms; in other words, there must exist two orders of particles, viz. (1) particles derived by limiting *mechanical* subdivision, the modern *molecule*, and (2) particles derived from the first class by *chemical* subdivision, *i.e.* particles which are incapable of existing alone, but may exist in combination. Additional evidence as to the structure of the molecule was discussed by Avogadro in 1811, and by Ampère in 1814. From the gas-laws of Boyle and J. A. C. Charles—viz. equal changes in temperature and pressure occasion equal changes in equal volumes of all gases and vapours—Avogadro deduced the law:—Under the same conditions of temperature and pressure, equal volumes of gases contain equal numbers of molecules; and he showed that the relative weights of the molecules are determined as the ratios of the weights of equal volumes, or densities. He established the existence of molecules and atoms as we have defined above, and stated that the number of atoms in the molecule is generally 2, but may be 4, 8, &c. We cannot tell whether his choice of 2 is accident or design.

Notwithstanding Avogadro's perspicuous investigation, and a similar exposition of the atom and molecule by A. M. Ampère, **Berzelius**, the views therein expressed were ignored both by their own and the succeeding generation. In place of the relative molecular weights, attention was concentrated on relative atomic or equivalent weights. This may be due in some measure to the small number of gaseous and easily volatile substances then known, to the attention which the study of the organic compounds received, and especially to the energetic investigations of J. J. Berzelius, who, fired with enthusiasm by the original theory of Dalton and the law of multiple proportions, determined the equivalents of combining ratios of many elements in an enormous number of compounds.² He prosecuted his labours in this field for thirty years; as proof of his industry it may be mentioned that as early as 1818 he had determined the combining ratios of about two thousand simple and compound substances.

We may here notice the important chemical symbolism or notation introduced by Berzelius, which greatly contributed to the definite and convenient representation of chemical composition and the tracing of chemical reactions. The denotation of elements by symbols had been practised by the alchemists, and it is interesting to note that the symbols allotted to the well-known elements are identical with the astrological symbols of the sun and the other members of the solar system. Gold, the most perfect metal, had the symbol of the Sun, ☉; silver, the semiperfect metal, had the symbol of the Moon, ☾; copper, iron and antimony, the imperfect metals of the gold class, had the symbols of Venus ♀, Mars ♂, and the Earth ♁; tin and lead, the imperfect metals of the silver class, had the symbols of Jupiter ♃, and Saturn ♄; while mercury, the imperfect metal of both the gold and silver class, had the symbol of the planet, ☿. Torbern Olof Bergman used an elaborate system in his *Opuscula physica et chemica* (1783); the

elements received symbols composed of circles, arcs of circles, and lines, while certain class symbols, such as ☉ for metals, ✚ for acids, ⊕ for alkalis, ○ for salts, ♁ for calces, &c., were used. Compounds were represented by copulating simpler symbols, *e.g.* mercury calx was ♁ ☉.³ Bergman's symbolism was obviously cumbersome, and the system used in 1782 by Lavoisier was equally abstruse, since the forms gave no clue as to composition; for instance water, oxygen, and nitric acid were ∇, ⊕, and ⊖.

A partial clarification was suggested in 1787 by J. H. Hassenfratz and Adet, who assigned to each element a symbol, and to each compound a sign which should record the elements present and their relative quantities. Straight lines and semicircles were utilized for the non-metallic elements, carbon, nitrogen, phosphorus and sulphur (the "simple acidifiable bases" of Lavoisier), and circles enclosing the initial letters of their names for the metals. The "compound acidifiable bases," *i.e.* the hypothetical radicals of acids, were denoted by squares enclosing the initial letter of the base; an alkali was denoted by a triangle, and the particular alkali by inserting the initial letter. Compounds were denoted by joining the symbols of the components, and by varying the manner of joining compounds of the same elements were distinguished. The symbol ∇ was used to denote a liquid, and a vertical line to denote a gas. As an example of the complexity of this system we may note the five oxides of nitrogen, which were symbolized as

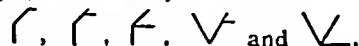

the first three representing the gaseous oxides, and the last two the liquid oxides.

A great advance was made by Dalton, who, besides introducing simpler symbols, regarded the symbol as representing not only the element or compound but also one atom of that element or compound; in other words, his symbol denoted equivalent weights.⁴ This system, which permitted the correct representation of molecular composition, was adopted by Berzelius in 1814, who, having replaced the geometric signs of Dalton by the initial letter (or letters) of the Latin names of the elements, represented a compound by placing a plus sign between the symbols of its components, and the number of atoms of each component (except in the case of only one atom) by placing Arabic numerals before the symbols; for example, copper oxide was Cu+O, sulphur trioxide S+3O. If two compounds combined, the + signs of the free compounds were discarded, and the number of atoms denoted by an Arabic index placed after the elements, and from these modified symbols the symbol of the new compound was derived in the same manner as simple compounds were built up from their elements. Thus copper sulphate was CuO+SO₃², potassium sulphate 2SO₃+PoO₂ (the symbol Po for potassium was subsequently discarded in favour of K from *kalium*). At a later date Berzelius denoted an oxide by dots, equal in number to the number of oxygen atoms present, placed over the element; this notation survived longest in mineralogy. He also introduced barred symbols, *i.e.* letters traversed by a horizontal bar, to denote the double atom (or molecule). Although the system of Berzelius has been modified and extended, its principles survive in the modern notation.

In the development of the atomic theory and the deduction of the atomic weights of elements and the formulae of compounds, Dalton's arbitrary rules failed to find complete acceptance. Berzelius objected to the hypothesis that if two elements form only one compound, then the atoms combine one and one; and although he agreed with the adoption of simple rules as a first attempt at representing a compound, he availed himself of other data in order to gain further information as to the structure of compounds. For example, at first he represented ferrous and ferric oxides by the formulae FeO₂, FeO₃, and by the analogy of zinc and other basic oxides he regarded these substances as constituted similarly to FeO₂, and the acidic oxides alumina and chromium oxide as similar to FeO₃. He found, however, that chromic acid, which he had represented as CrO₆, neutralized a base containing $\frac{1}{2}$ the

³ The following symbols were also used by Bergman:—

○, ⊕, ○, ☉, ☾, ☿, ☽, ☼, ☿, ∇, ∇, ☿, which represented zinc, manganese, cobalt, bismuth, nickel, arsenic, platinum, water, alcohol, phlogiston.

⁴ The following are the symbols employed by Dalton:—



which represent in order, hydrogen, nitrogen, carbon, oxygen, phosphorus, sulphur, magnesia, lime, soda, potash, strontia, baryta, mercury; iron, zinc, copper, lead, silver, platinum, and gold were represented by circles enclosing the initial letter of the element.

¹ Dalton's atomic theory is treated in more detail in the article ATOM.

² Berzelius, however, appreciated the necessity of differentiating the atom and the molecule, and even urged Dalton to amend his doctrine, but without success.

quantity of oxygen. He inferred that chromic acid must contain only three atoms of oxygen, as did sulphuric acid SO_3 ; consequently chromic oxide, which contains half the amount of oxygen, must be Cr_2O_3 , and hence ferric oxide must be Fe_2O_3 . The basic oxides must have the general formula MO . To these results he was aided by the law of isomorphism formulated by E. Mitscherlich in 1820; and he confirmed his conclusions by showing the agreement with the law of atomic heat formulated by Dulong and Petit in 1819.

While successfully investigating the solid elements and their compounds gravimetrically, Berzelius was guilty of several inconsistencies in his views on gases. He denied that gaseous atoms could have parts, although compound gases could. This attitude was due to his adherence to the "dualistic theory" of the structure of substances, which he deduced from electrochemical researches. From the behaviour of substances on electrolysis (*q.v.*) he assumed that all substances had two components, one bearing a negative charge, the other a positive charge. Combination was associated with the coalescence of these charges, and the nature of the resulting compound showed the nature of the residual electricity. For example, positive iron combined with negative oxygen to form positive ferrous oxide; positive sulphur combined with negative oxygen to form negative sulphuric acid; positive ferrous oxide combined with negative sulphuric acid to form neutral ferrous sulphate. Berzelius elevated this theory to an important position in the history of our science. He recognized that if an elementary atom had parts, his theory demanded that these parts should carry different electric charges when they entered into reaction, and the products of the reaction should vary according as a positive or negative atom entered into combination. For instance if the reaction $2\text{H}_2 + \text{O}_2 = \text{H}_2\text{O} + \text{H}_2\text{O}$ be true, the molecules of water should be different, for a negative oxygen atom would combine in one case, and a positive oxygen atom in the other. Hence the gaseous atoms of hydrogen and oxygen could not have parts. A second inconsistency was presented when he was compelled by the researches of Dumas to admit Avogadro's hypothesis; but here he would only accept it for the elementary gases, and denied it for other substances. It is to be noticed that J. B. Dumas did not adopt the best methods for emphasizing his discoveries. His terminology was vague and provoked caustic criticism from Berzelius; he assumed that all molecules contained two atoms, and consequently the atomic weights deduced from vapour density determinations of sulphur, mercury, arsenic, and phosphorus were quite different from those established by gravimetric and other methods.

Chemists gradually tired of the notion of atomic weights on account of the uncertainty which surrounded them; and the suggestion made by W. H. Wollaston as early as 1814 to deal only with "equivalents," *i.e.* the amount of an element which can combine with or replace unit weight of hydrogen, came into favour, being adopted by L. Gmelin in his famous text-book.

Simultaneously with this discussion of the atom and molecule, great controversy was ranging over the constitution of compounds, more particularly over the carbon or organic compounds. This subject is discussed in section IV., *Atomic and molecular weights.* *Organic Chemistry.* The gradual accumulation of data referring to organic compounds brought in its train a revival of the discussion of atoms and molecules. A. Laurent and C. F. Gerhardt attempted a solution by investigating chemical reactions. They assumed the atom to be the smallest part of matter which can exist in combination, and the molecule to be the smallest part which can enter into a chemical reaction. Gerhardt found that reactions could be best followed if one assumed the molecular weight of an element or compound to be that weight which occupied the same volume as two unit weights of hydrogen, and this assumption led him to double the equivalents accepted by Gmelin, making $\text{H}=1$, $\text{O}=16$, and $\text{C}=12$, thereby agreeing with Berzelius, and also to halve the values given by Berzelius to many metals. Laurent generally agreed, except when the theory compelled the adoption of formulae containing fractions of atoms; in such cases he regarded the

molecular weight as the weight occupying a volume equal to four unit weights of hydrogen. The bases upon which Gerhardt and Laurent founded their views were not sufficiently well grounded to lead to the acceptance of their results; Gerhardt himself returned to Gmelin's equivalents in his *Lehrbuch der Chemie* (1853) as they were in such general use.

In 1860 there prevailed such a confusion of hypotheses as to the atom and molecule that a conference was held at Karlsruhe to discuss the situation. At the conclusion of the sitting, Lothar Meyer obtained a paper written by Stanislas Cannizzaro in 1858 wherein was found the final link required for the determination of atomic weights. This link was the full extension of Avogadro's theory to all substances, Cannizzaro showing that chemical reactions in themselves would not suffice. He chose as his unit of reference the weight of an atom of hydrogen, *i.e.* the weight contained in a molecule of hydrochloric acid, thus differing from Avogadro who chose the weight of a hydrogen molecule. From a study of the free elements Cannizzaro showed that an element may have more than one molecular weight; for example, the molecular weight of sulphur varied with the temperature. And from the study of compounds he showed that each element occurred in a definite weight or in some multiple of this weight. He called this proportion the "atom," since it invariably enters compounds without division, and the weight of this atom is the atomic weight. This generalization was of great value inasmuch as it permitted the deduction of the atomic weight of a non-gasifiable element from a study of the densities of its gasifiable compounds.

From the results obtained by Laurent and Gerhardt and their predecessors it immediately followed that, while an element could have but one atomic weight, it could have several equivalent weights. From a detailed study of organic compounds Gerhardt had promulgated a "theory of types" which represented a fusion of the older radical and type theories. This theory brought together, as it were, the most varied compounds, and stimulated inquiry into many fields. According to this theory, an element in a compound had a definite saturation capacity, an idea very old in itself, being framed in the law of multiple proportions. These saturation capacities were assiduously studied by Sir Edward Frankland, who from the investigation, not of simple inorganic compounds, but of the organo-metallic derivatives, determined the kernel of the theory of valency. Frankland showed that any particular element preferentially combined with a definite number (which might vary between certain limits) of other atoms; for example, some atoms always combined with one atom of oxygen, some with two, while with others two atoms entered into combination with one of oxygen. If an element or radical combined with one atom of hydrogen, it was termed monovalent; if with two (or with one atom of oxygen, which is equivalent to two atoms of hydrogen) it was divalent, and so on. The same views were expressed by Cannizzaro, and also by A. W. von Hofmann, who materially helped the acceptance of the doctrine by the lucid exposition in his *Introduction to Modern Chemistry*, 1865.

The recognition of the quadrivalency of carbon by A. Kekulé was the forerunner of his celebrated benzene theory in particular, and of the universal application of structural formulae to the representation of the most complex organic compounds equally lucidly as the representation of the simplest salts. Alexander Butlerow named the "structure theory," and contributed much to the development of the subject. He defined structure "as the manner of the mutual linking of the atoms in the molecule," but denied that any such structure could give information as to the orientation of the atoms in space. He regarded the chemical properties of a substance as due to (1) the chemical atoms composing it, and (2) the structure, and he asserted that while different compounds might have the same components (isomerism), yet only one compound could have a particular structure. Identity in properties necessitated identity in structure.

While the principle of varying valency laid down by Frankland is still retained, Butlerow's view that structure had no spatial significance has been modified. The researches of L. Pasteur,

J. A. Le Bel, J. Wislicenus, van't Hoff and others showed that substances having the same graphic formulae vary in properties and reactions, and consequently the formulae need modification in order to exhibit these differences. Such isomerism, named stereoisomerism (*q.v.*), has been assiduously developed during recent years; it prevails among many different classes of organic compounds and many examples have been found in inorganic chemistry.

The theory of valency as a means of showing similarity of properties and relative composition became a dominant feature of chemical theory, the older hypotheses of types, radicals, &c. being more or less discarded. We have seen how its utilization in the "structure theory" permitted great clarification, and attempts were not wanting for the deduction of analogies or a periodicity between elements. Frankland had recognized the analogies existing between the chemical properties of nitrogen, phosphorus, arsenic and antimony, noting that they act as tri- or penta-valent. Carbon was joined with silicon, zirconium and titanium, while boron, being trivalent, was relegated to another group. A general classification of elements, however, was not realized by Frankland, nor even by Odling, who had also investigated the question from the valency standpoint. The solution came about by arranging the elements in the order of their atomic weights, tempering the arrangement with the results deduced from the theory of valencies and experimental observations. Many chemists contributed to the establishment of such a periodicity, the greatest advances being made by John Newlands in England, Lothar Meyer in Germany, and D. J. Mendeléeff in St Petersburg. For the development of this classification see ELEMENT.

In the above sketch we have briefly treated the history of the main tendencies of our science from the earliest times to the establishment of the modern laws and principles. We

Summary.

have seen that the science took its origin in the arts practised by the Egyptians, and, having come under the influence of philosophers, it chose for its purpose the isolation of the *quinta essentia*, and subsequently the "art of making gold and silver." This spirit gave way to the physicians, who regarded "chemistry as the art of preparing medicines," a denotation which in turn succumbed to the arguments of Boyle, who regarded it as the "science of the composition of substances," a definition which adequately fits the science to-day. We have seen how his classification of substances into elements and compounds, and the definitions which he assigned to these species, have similarly been retained; and how Lavoisier established the law of the "conservation of mass," overthrew the prevailing phlogistic theory, and became the founder of modern chemistry by the overwhelming importance which he gave to the use of the balance. The development of the atomic theory and its concomitants—the laws of chemical combination and the notion of atoms and equivalents—at the hands of Dalton and Berzelius, the extension to the modern theory of the atom and molecule, and to atomic and molecular weights by Avogadro, Ampère, Dumas, Laurent, Gerhardt, Cannizzaro and others, have been noted. The structure of the molecule, which mainly followed investigations in organic compounds, Frankland's conception of valency, and finally the periodic law, have also been shown in their chronological order. The principles outlined above constitute the foundations of our science; and although it may happen that experiments may be made with which they appear to be not in complete agreement, yet in general they constitute a body of working hypotheses of inestimable value.

Chemical Education.—It is remarkable that systematic instruction in the theory and practice of chemistry only received earnest attention in our academic institutions during the opening decades of the 19th century. Although for a long time lecturers and professors had been attached to universities, generally their duties had also included the study of physics, mineralogy and other subjects, with the result that chemistry received scanty encouragement. Of practical instruction there was none other than that to be gained in a few private laboratories and in the shops of apothecaries. The necessity for experimental demonstration and practical instruction, in addition to academic

lectures, appears to have been urged by the French chemists L. N. Vauquelin, Gay Lussac, Thénard, and more especially by A. F. Fourcroy and G. F. Rouelle, while in England Humphry Davy expounded the same idea in the experimental demonstrations which gave his lectures their brilliant charm. But the real founder of systematic instruction in our science was Justus von Liebig, who, having accepted the professorship at Giessen in 1824, made his chemical laboratory and course of instruction the model of all others. He emphasized that the practical training should include (1) the qualitative and quantitative analysis of mixtures, (2) the preparation of substances according to established methods, (3) original research—a course which has been generally adopted. The pattern set by Liebig at Giessen was adopted by F. Wöhler at Göttingen in 1836, by R. W. Bunsen at Marburg in 1840, and by O. L. Erdmann at Leipzig in 1843; and during the 'fifties and 'sixties many other laboratories were founded. A new era followed the erection of the laboratories at Bonn and Berlin according to the plans of A. W. von Hofmann in 1867, and of that at Leipzig, designed by Kolbe in 1868. We may also mention the famous laboratory at Munich designed by A. von Baeyer in 1875.

In Great Britain the first public laboratory appears to have been opened in 1817 by Thomas Thomson at Glasgow. But the first important step in providing means whereby students could systematically study chemistry was the foundation of the College of Chemistry in 1845. This institution was taken over by the Government in 1853, becoming the Royal College of Chemistry, and incorporated with the Royal School of Mines; in 1881 the names were changed to the Normal School of Science and Royal School of Mines, and again in 1890 to the Royal College of Science. In 1907 it was incorporated in the Imperial College of Science and Technology. Under A. W. von Hofmann, who designed the laboratories and accepted the professorship in 1845 at the instigation of Prince Albert, and under his successor (in 1864) Sir Edward Frankland, this institution became one of the most important centres of chemical instruction. Oxford and Cambridge sadly neglected the erection of convenient laboratories for many years, and consequently we find technical schools and other universities having a far better equipment and offering greater facilities. In the provinces Victoria University at Manchester exercised the greater impetus, numbering among its professors Sir W. H. Perkin and Sir Henry Roscoe.

In America public laboratory instruction was first instituted at Yale College during the professorship of Benjamin Silliman. To the great progress made in recent years F. W. Clarke, W. Gibbs, E. W. Morley, Ira Remsen, and T. W. Richards have especially contributed.

In France the subject was almost entirely neglected until late in the 19th century. The few laboratories existing in the opening decades were ill-fitted, and the exorbitant fees constituted a serious bar to general instruction, for these institutions received little government support. In 1869 A. Wurtz reported the existence of only *one* efficient laboratory in France, namely the École Normale Supérieure, under the direction of H. Sainte Claire Deville. During recent years chemistry has become one of the most important subjects in the curriculum of technical schools and universities, and at the present time no general educational institution is complete until it has its full equipment of laboratories and lecture theatres.

Chemical Literature.—The growth of chemical literature since the publication of Lavoisier's famous *Traité de chimie* in 1789, and of Berzelius' *Lehrbuch der Chemie* in 1808–1818, has been enormous. These two works, and especially the latter, were the models followed by Thénard, Liebig, Strecker, Wöhler and many others, including Thomas Graham, upon whose *Elements of Chemistry* was founded Otto's famous *Lehrbuch der Chemie*, to which H. Kopp contributed the general theoretical part, Kolbe the organic, and Buff and Zammerlin the physico-chemical. Organic chemistry was especially developed by the publication of Gerhardt's *Traité de chimie organique* in 1853–1856, and of Kekulé's *Lehrbuch der organischen Chemie* in 1861–1882. General theoretical and physical chemistry was treated with conspicuous acumen by Lothar Meyer in his *Moderne Theorien*, by W. Ostwald in his *Lehrbuch der allgem. Chemie* (1884–1887), and by Nernst in his *Theoretische Chemie*. In English, Roscoe and Schorlemmer's *Treatise on Chemistry* is a standard work; it records

a successful attempt to state the theories and facts of chemistry, not in condensed epitomes, but in an easily read form. The *Traité de chimie minérale*, edited by H. Moissan, and the *Handbuch der anorganischen Chemie*, edited by Abegg, are of the same type. O. Dammer's *Handbuch der anorganischen Chemie* and F. Beilstein's *Handbuch der organischen Chemie* are invaluable works of reference. Of the earlier encyclopaedias we may notice the famous *Handwörterbuch der reinen und angewandten Chemie*, edited by Liebig; Frémy's *Encyclopédie de chimie*, Wurtz's *Dictionnaire de chimie pure et appliquée*, Watts' *Dictionary of Chemistry*, and Ladenburg's *Handwörterbuch der Chemie*.

The number of periodicals devoted to chemistry has steadily increased since the early part of the 19th century. In England the most important is the *Journal of the Chemical Society of London*, first published in 1848. Since 1871 abstracts of papers appearing in the other journals have been printed. In 1904 a new departure was made in issuing *Annual Reports*, containing résumés of the most important researches of the year. The *Chemical News*, founded by Sir W. Crookes in 1860, may also be noted. In America the chief periodical is the *American Chemical Journal*, founded in 1879. Germany is provided with a great number of magazines. The *Berichte der deutschen chemischen Gesellschaft*, published by the Berlin Chemical Society, the *Chemisches Centralblatt*, which is confined to abstracts of papers appearing in other journals, the *Zeitschrift für Chemie*, and Liebig's *Annalen der Chemie* are the most important of the general magazines. Others devoted to special phases are the *Journal für praktische Chemie*, founded by Erdmann in 1834, the *Zeitschrift für anorganische Chemie* and the *Zeitschrift für physikalische Chemie*. Mention may also be made of the invaluable *Jahresberichte* and the *Jahrbuch der Chemie*. In France, the most important journals are the *Annales de chimie et de physique*, founded in 1789 with the title *Annales de chimie*, and the *Comptes rendus*, published weekly by the Académie française since 1835.

II. GENERAL PRINCIPLES

The substances with which the chemist has to deal admit of classification into elements and compounds. Of the former about eighty may be regarded as well characterized, although many more have been described.

Elements.—The following table gives the names, symbols and atomic weights of the perfectly characterized elements:—

International Atomic Weights, 1910.

Name.	Symbol.	Atomic Weights. 0=16.	Name.	Symbol.	Atomic Weights. 0=16.
Aluminium . . .	Al	27.1	Mercury . . .	Hg	200.0
Antimony . . .	Sb	120.2	Molybdenum . . .	Mo	96.0
Argon . . .	A	39.9	Neodymium . . .	Nd	144.3
Arsenic . . .	As	74.96	Neon . . .	Ne	20
Barium . . .	Ba	137.37	Nickel . . .	Ni	58.68
Beryllium or } Glucinum } Cl	Be } } 9.1		Nitrogen . . .	N	14.01
Bismuth . . .	Bi	208.0	Osmium . . .	Os	190.9
Boron . . .	B	11.0	Oxygen . . .	O	16.00
Bromine . . .	Br	79.92	Palladium . . .	Pd	106.7
Cadmium . . .	Cd	112.40	Phosphorus . . .	P	31.0
Caesium . . .	Cs	132.81	Platinum . . .	Pt	195.0
Calcium . . .	Ca	40.09	Potassium . . .	K	39.10
Carbon . . .	C	12.0	Praseodymium . . .	Pr	140.6
Cerium . . .	Ce	140.25	Radium . . .	Ra	226.4
Chlorine . . .	Cl	35.46	Rhodium . . .	Rh	102.9
Chromium . . .	Cr	52.0	Rubidium . . .	Rb	85.45
Cobalt . . .	Co	58.97	Ruthenium . . .	Ru	101.7
Columbium . . .	Cb } or Niobium } Nb } 93.5		Samarium . . .	Sa	150.4
Copper . . .	Cu	63.57	Scandium . . .	Sc	44.1
Dysprosium . . .	Dy	162.5	Selenium . . .	Se	79.2
Erbium . . .	Er	167.4	Silicon . . .	Si	28.3
Europium . . .	Eu	152.0	Silver . . .	Ag	107.88
Fluorine . . .	F	19.0	Sodium . . .	Na	23.0
Gadolinium . . .	Gd	157.3	Strontium . . .	Sr	87.62
Gallium . . .	Ga	69.9	Sulphur . . .	S	32.07
Germanium . . .	Ge	72.5	Tantalum . . .	Ta	181.0
Gold . . .	Au	197.2	Tellurium . . .	Te	127.5
Helium . . .	He	4.0	Terbium . . .	Tb	159.2
Hydrogen . . .	H	1.008	Thallium . . .	Tl	204.0
Indium . . .	In	114.8	Thorium . . .	Th	232.42
Iodine . . .	I	126.92	Thulium . . .	Tm	168.5
Iridium . . .	Ir	193.1	Tin . . .	Sn	119.0
Iron . . .	Fe	55.85	Titanium . . .	Ti	48.1
Krypton . . .	Kr	83.0	Tungsten . . .	W	184.0
Lanthanum . . .	La	139.0	Uranium . . .	U	238.5
Lead . . .	Pb	207.10	Vanadium . . .	V	51.2
Lithium . . .	Li	7.00	Xenon . . .	Xe	130.7
Lutecium . . .	Lu	174	Ytterbium (Neo- ytterbium) . . .	Yb	172
Magnesium . . .	Mg	24.32	Yttrium . . .	Y	89.0
Manganese . . .	Mn	54.93	Zinc . . .	Zn	65.37
			Zirconium . . .	Zr	90.6

The elements are usually divided into two classes, the metallic and the non-metallic elements; the following are classed as non-metals, and the remainder as metals:—

Hydrogen	Oxygen	Boron	Neon
Chlorine	Sulphur	Carbon	Krypton
Bromine	Selenium	Silicon	Xenon
Iodine	Tellurium	Phosphorus	Helium
Fluorine	Nitrogen	Argon	

Of these hydrogen, chlorine, fluorine, oxygen, nitrogen, argon, neon, krypton, xenon and helium are gases, bromine is a liquid, and the remainder are solids. All the metals are solids at ordinary temperatures with the exception of mercury, which is liquid. The metals are mostly bodies of high specific gravity; they exhibit, when polished, a peculiar brilliancy or metallic lustre, and they are good conductors of heat and electricity; the non-metals, on the other hand, are mostly bodies of low specific gravity, and bad conductors of heat and electricity, and do not exhibit metallic lustre. The non-metallic elements are also sometimes termed metalloids, but this appellation, which signifies metal-like substances (Gr. *εἶδος*, like), strictly belongs to certain elements which do not possess the properties of the true metals, although they more closely resemble them than the non-metals in many respects; thus, selenium and tellurium, which are closely allied to sulphur in their chemical properties, although bad conductors of heat and electricity, exhibit metallic lustre and have relatively high specific gravities. But when the properties of the elements are carefully contrasted together it is found that no strict line of demarcation can be drawn dividing them into two classes; and if they are arranged in a series, those which are most closely allied in properties being placed next to each other, it is observed that there is a more or less regular alteration in properties from term to term in the series.

When binary compounds, or compounds of two elements, are decomposed by an electric current, the two elements make their appearance at opposite poles. Those elements which are disengaged at the negative pole are termed electro-positive, or positive, or basylous elements, whilst those disengaged at the positive pole are termed electro-negative, or negative, or chlorous elements. But the difference between these two classes of elements is one of degree only, and they gradually merge into each other; moreover the electric relations of elements are not absolute, but vary according to the state of combination in which they exist, so that it is just as impossible to divide the elements into two classes according to this property as it is to separate them into two distinct classes of metals and non-metals. The following, however, are negative towards the remaining elements which are more or less positive:—Fluorine, chlorine, bromine, iodine, oxygen, sulphur, selenium, tellurium.

The metals may be arranged in a series according to their power of displacing one another in salt solutions, thus Cs, Rb, K, Na, Mg, Al, Mn, Zn, Cd, Tl, Fe, Co, Ni, Sn, Pb, (H), Sb, Bi, As, Cu, Hg, Ag, Pd, Pt, Au.

Elements which readily enter into reaction with each other, and which develop a large amount of heat on combination, are said to have a powerful affinity for each other. The tendency of positive elements to unite with positive elements, or of negative elements to unite with negative elements, is much less than that of positive elements to unite with negative elements, and the greater the difference in properties between two elements the more powerful is their affinity for each other. Thus, the affinity of hydrogen and oxygen for each other is extremely powerful, much heat being developed by the combination of these two elements; when binary compounds of oxygen are decomposed by the electric current, the oxygen invariably appears at the positive pole, being negative to all other elements, but the hydrogen of hydrogen compounds is always disengaged at the negative pole. Hydrogen and oxygen are, therefore, of very opposite natures, and this is well illustrated by the circumstance that oxygen combines, with very few exceptions, with all the remaining elements, whilst compounds of only a limited number with hydrogen have been obtained.

Compounds.—A chemical compound contains two or more

elements; consequently it should be possible to analyse it, *i.e.* separate it into its components, or to synthesize it, *i.e.* build it up from its components. In general, a compound has properties markedly different from those of the elements of which it is composed.

Laws of Chemical Combination.—A *molecule* may be defined as the smallest part of a substance which can exist alone; an *atom* as the smallest part of a substance which can exist in combination. The molecule of every compound must obviously contain at least two atoms, and generally the molecules of the elements are also polyatomic, the elements with monatomic molecules (at moderate temperatures) being mercury and the gases of the argon group. The laws of chemical combination are as follows:—

1. **Law of Definite Proportions.**—The same compound always contains the same elements combined together in the same mass proportion. Silver chloride, for example, in whatever manner it may be prepared, invariably consists of chlorine and silver in the proportions by weight of 35.45 parts of the former and 107.93 of the latter.

2. **Law of Multiple Proportions.**—When the same two elements combine together to form more than one compound, the different masses of one of the elements which unite with a constant mass of the other, bear a simple ratio to one another. Thus, 1 part by weight of hydrogen unites with 8 parts by weight of oxygen, forming water, and with 16 or 8×2 parts of oxygen, forming hydrogen peroxide. Again, in nitrous oxide we have a compound of 8 parts by weight of oxygen and 14 of nitrogen; in nitric oxide a compound of 16 or 8×2 parts of oxygen and 14 of nitrogen; in nitrous anhydride a compound of 24 or 8×3 parts of oxygen and 14 of nitrogen; in nitric peroxide a compound of 32 or 8×4 parts of oxygen and 14 of nitrogen; and lastly, in nitric anhydride a compound of 40 or 8×5 parts of oxygen and 14 of nitrogen.

3. **Law of Reciprocal Proportions.**—The masses of different elements which combine separately with one and the same mass of another element, are either the same as, or simple multiples of, the masses of these different elements which combine with each other. For instance, 35.45 parts of chlorine and 79.96 parts of bromine combine with 107.93 parts of silver; and when chlorine and bromine unite it is in the proportion of 35.45 parts of the former to 79.96 parts of the latter. Iodine unites with silver in the proportion of 126.97 parts to 107.93 parts of the latter, but it combines with chlorine in two proportions, *viz.* in the proportion of 126.97 parts either to 35.45 or to three times 35.45 parts of chlorine.

There is a fourth law of chemical combination which only applies to gases. This law states that:—gases combine with one another in simple proportions by volume, and the volume of the product (if gaseous) has a simple ratio to the volumes of the original mixtures; in other words, the densities of gases are simply related to their combining weights.

Nomenclature.—If a compound contains two atoms it is termed a binary compound, if three a ternary, if four a quaternary, and so on. Its systematic name is formed by replacing the last syllable of the electro-negative element by *ide* and prefixing the name of the other element. For example, compounds of oxygen are *oxides*, of chlorine, *chlorides*, and so on. If more than one compound be formed from the same two elements, the difference is shown by prefixing such words as mono-, di-, tri-, sesqui-, per-, sub-, &c., to the last part of the name, or the suffixes *-ous* and *-ic* may be appended to the name of the first element. For example take the oxides of nitrogen, N_2O , NO , N_2O_2 , NO_2 , N_2O_5 ; these are known respectively as nitrous oxide, nitric oxide, nitrogen trioxide, nitrogen peroxide and nitrogen pentoxide. The affixes *-ous* and *sub-* refer to the compounds containing more of the positive element, *-ic* and *per-* to those containing less.

An *acid* (*q.v.*) is a compound of hydrogen, which element can be replaced by metals, the hydrogen being liberated, giving substances named *salts*. An *alkali* or *base* is a substance which neutralizes an acid with the production of salts but with no

evolution of hydrogen. A base may be regarded as water in which part of the hydrogen is replaced by a metal, or by a radical which behaves as a metal. (The term *radical* is given to a group of atoms which persist in chemical changes, behaving as if the group were an element; the commonest is the ammonium group, NH_4 , which forms salts similar to the salts of sodium and potassium.) If the acid contains no oxygen it is a *hydracid*, and its systematic name is formed from the prefix *hydro-* and the name of the other element or radical, the last syllable of which has been replaced by the termination *-ic*. For example, the acid formed by hydrogen and chlorine is termed hydrochloric acid (and sometimes hydrogen chloride). If an acid contains oxygen it is termed an *oxyacid*. The nomenclature of acids follows the same general lines as that for binary compounds. If one acid be known its name is formed by the termination *-ic*, *e.g.* carbonic acid; if two, the one containing the less amount of oxygen takes the termination *-ous* and the other the termination *-ic*, *e.g.* nitrous acid, HNO_2 , nitric acid, HNO_3 . If more than two be known, the one inferior in oxygen content has the prefix *hypo-* and the termination *-ous*, and the one superior in oxygen content has the prefix *per-* and the termination *-ic*. This is illustrated in the four oxyacids of chlorine, $HClO$, $HClO_2$, $HClO_3$, $HClO_4$, which have the names hypochlorous, chlorous, chloric and perchloric acids. An acid is said to be monobasic, dibasic, tribasic, &c., according to the number of replaceable hydrogen atoms; thus HNO_3 is monobasic, sulphuric acid H_2SO_4 dibasic, phosphoric acid H_3PO_4 tribasic.

An acid terminating in *-ous* forms a salt ending in *-ite*, and an oxyacid ending in *-ic* forms a salt ending in *-ate*. Thus the chlorine oxyacids enumerated above form salts named respectively hypochlorites, chlorites, chlorates and perchlorates. Salts formed from hydracids terminate in *-ide*, following the rule for binary compounds. An *acid* salt is one in which the whole amount of hydrogen has not been replaced by metal; a *normal* salt is one in which all the hydrogen has been replaced; and a *basic* salt is one in which part of the acid of the normal salt has been replaced by oxygen.

Chemical Formulæ.—Opposite the name of each element in the second column of the above table, the symbol is given which is always employed to represent it. This symbol, however, not only represents the particular element, but a certain definite quantity of it. Thus, the letter H always stands for 1 atom or 1 part by weight of hydrogen, the letter N for 1 atom or 14 parts of nitrogen, and the symbol Cl for 1 atom or 35.5 parts of chlorine.¹ Compounds are in like manner represented by writing the symbols of their constituent elements side by side, and if more than one atom of each element be present, the number is indicated by a numeral placed on the right of the symbol of the element either below or above the line. Thus, hydrochloric acid is represented by the formula HCl, that is to say, it is a compound of an atom of hydrogen with an atom of chlorine, or of 1 part by weight of hydrogen with 35.5 parts by weight of chlorine; again, sulphuric acid is represented by the formula H_2SO_4 , which is a statement that it consists of 2 atoms of hydrogen, 1 of sulphur, and 4 of oxygen, and consequently of certain relative weights of these elements. A figure placed on the right of a symbol only affects the symbol to which it is attached, but when figures are placed in front of several symbols all are affected by it, thus $2H_2SO_4$ means H_2SO_4 taken twice.

The distribution of weight in chemical change is readily expressed in the form of equations by the aid of these symbols; the equation

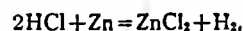

for example, is to be read as meaning that from 73 parts of hydrochloric acid and 65 parts of zinc, 136 parts of zinc chloride and 2 parts of hydrogen are produced. The + sign is invariably employed in this way either to express combination or action upon, the meaning usually attached to the use of the sign = being that from such and such bodies such and such other bodies are formed.

¹ Approximate values of the atomic weights are employed here.

Usually, when the symbols of the elements are written or printed with a figure to the right, it is understood that this indicates a molecule of the element, the symbol alone representing an atom. Thus, the symbols H_2 and P_4 indicate that the molecules of hydrogen and phosphorus respectively contain 2 and 4 atoms. Since, according to the molecular theory, in all cases of chemical change the action is between molecules, such symbols as these ought always to be employed. Thus, the formation of hydrochloric acid from hydrogen and chlorine is correctly represented by the equation

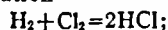

that is to say, a molecule of hydrogen and a molecule of chlorine give rise to two molecules of hydrochloric acid; whilst the following equation merely represents the relative weights of the elements which enter into reaction, and is not a complete expression of what is supposed to take place:—

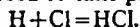

In all cases it is usual to represent substances by formulae which to the best of our knowledge express their molecular composition in the state of gas, and not merely the relative number of atoms which they contain; thus, acetic acid consists of carbon, hydrogen and oxygen in the proportion of one atom of carbon, two of hydrogen, and one of oxygen, but its molecular weight corresponds to the formula $C_2H_4O_2$, which therefore is always employed to represent acetic acid. When chemical change is expressed with the aid of molecular formulae not only is the distribution of weight represented, but by the mere inspection of the symbols it is possible to deduce from the law of gaseous combination mentioned above, the relative volumes which the agents and resultants occupy in the state of gas if measured at the same temperature and under the same pressure. Thus, the equation

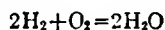

not only represents that certain definite weights of hydrogen and oxygen furnish a certain definite weight of the compound which we term water, but that if the water in the state of gas, the hydrogen and the oxygen are all measured at the same temperature and pressure, the volume occupied by the oxygen is only half that occupied by the hydrogen, whilst the resulting water-gas will only occupy the same volume as the hydrogen. In other words, 2 volumes of oxygen and 4 volumes of hydrogen furnish 4 volumes of water-gas. A simple equation like this, therefore, when properly interpreted, affords a large amount of information. One other instance may be given; the equation

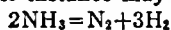

represents the decomposition of ammonia gas into nitrogen and hydrogen gases by the electric spark, and it not only conveys the information that a certain relative weight of ammonia, consisting of certain relative weights of hydrogen and nitrogen, is broken up into certain relative weights of hydrogen and nitrogen, but also that the nitrogen will be contained in half the space which contained the ammonia, and that the volume of the hydrogen will be one and a half times as great as that of the original ammonia, so that in the decomposition of ammonia the volume becomes doubled.

Formulae which merely express the relative number of atoms of the different elements present in a compound are termed *empirical formulae*, and the formulae of all compounds whose molecular weights are undetermined are necessarily empirical. The *molecular formula* of a compound, however, is always a simple multiple of the empirical formula, if not identical with it; thus, the empirical formula of acetic acid is CH_2O , and its molecular formula is $C_2H_4O_2$, or twice CH_2O . In addition to empirical and molecular formulae, chemists are in the habit of employing various kinds of rational formulae, called structural, constitutional or graphic formulae, &c., which not only express the molecular composition of the compounds to which they apply, but also embody certain assumptions as to the manner in which the constituent atoms are arranged, and convey more or less information with regard to the nature of the compound itself, viz. the class to which it belongs, the manner in which

it is formed, and the behaviour it will exhibit under various circumstances. Before explaining these formulae it will be necessary, however, to consider the differences in combining power exhibited by the various elements.

Valency.—It is found that the number of atoms of a given element, of chlorine, for example, which unite with an atom of each of the other elements is very variable. Thus, hydrogen unites with but a single atom of chlorine, zinc with two, boron with three, silicon with four, phosphorus with five and tungsten with six. Those elements which are equivalent in combining or displacing power to a single atom of hydrogen are said to be *univalent* or *monad* elements; whilst those which are equivalent to two atoms of hydrogen are termed *bivalent* or *dyad* elements; and those equivalent to three, four, five or six atoms of hydrogen triad, tetrad, pentad or hexad elements. But not only is the combining power or valency (atomicity) of the elements different, it is also observed that one element may combine with another in several proportions, or that its valency may vary; for example, phosphorus forms two chlorides represented by the formulae PCl_3 and PCl_5 , nitrogen the series of oxides represented by the formulae N_2O , NO , (N_2O_3) , N_2O_4 , N_2O_5 , molybdenum forms the chlorides $MoCl_2$, $MoCl_3$, $MoCl_4$, $MoCl_5$, $MoCl_6(?)$, and tungsten the chlorides WCl_2 , WCl_4 , WCl_5 , WCl_6 .

An explanation of these facts it is supposed that each element has a certain number of "units of affinity," which may be entirely, or only in part, engaged when it enters into combination with other elements; and in those cases in which the entire number of units of affinity are not engaged by other elements, it is supposed that those which are thus disengaged neutralize each other, as it were. For example, in phosphorus pentachloride the five units of affinity possessed by the phosphorus atom are satisfied by the five monad atoms of chlorine, but in the trichloride two are disengaged, and, it may be supposed, satisfy each other. Compounds in which all the units of affinity of the contained elements are engaged are said to be *saturated*, whilst those in which the affinities of the contained elements are not all engaged by other elements are said to be *unsaturated*. According to this view, it is necessary to assume that, in all unsaturated compounds, two, or some even number of affinities are disengaged; and also that all elements which combine with an even number of monad atoms cannot combine with an odd number, and vice versa,—in other words, that the number of units of affinity active in the case of any given element must be always either an even or an odd number, and that it cannot be at one time an even and at another an odd number. There are, however, a few remarkable exceptions to this "law." Thus, it must be supposed that in nitric oxide, NO , an odd number of affinities are disengaged, since a single atom of dyad oxygen is united with a single atom of nitrogen, which in all its compounds with other elements acts either as a triad or pentad. When nitric peroxide, N_2O_4 , is converted into gas, it decomposes, and at about $180^\circ C.$ its vapour entirely consists of molecules of the composition NO_2 ; while at temperatures between this and $0^\circ C.$ it consists of a mixture in different proportions of the two kinds of molecules, N_2O_4 and NO_2 . The oxide NO_2 must be regarded as another instance of a compound in which an odd number of affinities of one of the contained elements are disengaged, since it contains two atoms of dyad oxygen united with a single atom of triad or pentad nitrogen. Again, when tungsten hexachloride is converted into vapour it is decomposed into chlorine and a pentachloride, having a normal vapour density, but as in the majority of its compounds tungsten acts as a hexad, we apparently must regard its pentachloride as a compound in which an odd number of free affinities are disengaged. Hitherto no explanation has been given of these exceptions to what appears to be a law of almost universal application, viz. that the sum of the units of affinity of all the atoms in a compound is an even number.

The number of units of affinity active in the case of any particular element is largely dependent, however, upon the nature of the element or elements with which it is associated. Thus, an atom of iodine only combines with one of hydrogen,

but may unite with three of chlorine, which never combines with more than a single atom of hydrogen; an atom of phosphorus unites with only three atoms of hydrogen, but with five of chlorine, or with four of hydrogen and one of iodine; and the chlorides corresponding to the higher oxides of lead, nickel, manganese and arsenic, PbO_2 , Ni_2O_3 , MnO_2 and As_2O_3 , do not exist as stable compounds, but the lower chlorides, $PbCl_2$, $NiCl_2$, $MnCl_2$ and $AsCl_3$, are very stable.

The valency of an element is usually expressed by dashes or Roman numerals placed on the right of its symbol, thus: H^I , O^II , B^{III} , C^{IV} , P^V , Mo^{VI} ; but in constructing graphic formulae the symbols of the elements are written with as many lines attached to each symbol as the element which it represents has units of affinity.

The periodic law (see ELEMENT) permits a grouping of the elements according to their valency as follows:—Group O: helium, neon, argon, krypton and xenon appear to be devoid of valency. Group I.: the alkali metals Li, Na, K, Rb, Cs, and also Ag, monovalent; Cu, monovalent and divalent; Au, monovalent and trivalent. Group II.: the alkaline earth metals Ca, Sr, Ba, and also Be (Gl), Mg, Zn, Cd, divalent; Hg, monovalent and divalent. Group III.: B, trivalent; Al, trivalent, but possibly also tetra- or penta-valent; Ga, divalent and trivalent; In, mono-, di- and tri-valent; Tl, monovalent and trivalent. Group IV.: C, Si, Ge, Zr, Th, tetravalent; Ti, tetravalent and hexavalent; Sn, Pb, divalent and tetravalent; Ce, trivalent and tetravalent. Group V.: N, trivalent and pentavalent, but divalent in nitric oxide; P, As, Sb, Bi, trivalent and pentavalent, the last being possibly divalent in BiO and $BiCl_2$. Group VI.: O, usually divalent, but tetravalent and possibly hexavalent in oxonium and other salts; S, Se, Te, di-, tetra- and hexa-valent; Cr, di-, tri- and hexa-valent; Mo, W, di-, tri-, tetra-, penta- and hexa-valent. Group VII.: H (?), monovalent; the halogens F, Cl, Br, I, usually monovalent, but possibly also tri- and penta-valent; Mn, divalent and trivalent, and possibly heptavalent in permanganates. Group VIII.: Fe, Co, divalent and trivalent; Ni, divalent; Os, Ru, hexavalent and octavalent; Pd, Pt, divalent and tetravalent; Ir, tri-, tetra- and hexa-valent. (See also VALENCY.)

Constitutional Formulae.—Graphic or constitutional formulae are employed to express the manner in which the constituent atoms of compounds are associated together; for example, the trioxide of sulphur is usually regarded as a compound of an atom of hexad sulphur with three atoms of dyad oxygen, and this hypothesis is illustrated by the graphic formula

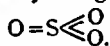

When this oxide is brought into contact with water it combines with it forming sulphuric acid, H_2SO_4 .

In this compound only two of the oxygen atoms are wholly associated with the sulphur atom, each of the remaining oxygen atoms being united by one of its affinities to the sulphur atoms, and by the remaining affinity to an atom of hydrogen; thus—

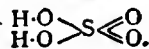

The graphic formula of a sulphate is readily deduced by remembering that the hydrogen atoms are partially or entirely replaced. Thus acid sodium sulphate, normal sodium sulphate, and zinc sulphate have the formulae

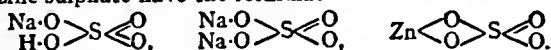

Again, the reactions of acetic acid, $C_2H_4O_2$, show that the four atoms of hydrogen which it contains have not all the same function, and also that the two atoms of oxygen have different functions; the graphic formula which we are led to assign to acetic acid, viz.

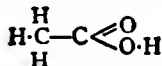

serves in a measure to express this, three of the atoms of hydrogen being represented as associated with one of the atoms of carbon,

whilst the fourth atom is associated with an atom of oxygen which is united by a single affinity to the second atom of carbon, to which, however, the second atom of oxygen is united by both of its affinities. It is not to be supposed that there are any actual bonds of union between the atoms; graphic formulae such as these merely express the hypothesis that certain of the atoms in a compound come directly within the sphere of attraction of certain other atoms, and only indirectly within the sphere of attraction of others,—an hypothesis to which chemists are led by observing that it is often possible to separate a group of elements from a compound, and to displace it by other elements or groups of elements.

Rational formulae of a much simpler description than these graphic formulae are generally employed. For instance, sulphuric acid is usually represented by the formula $SO_2(OH)_2$, which indicates that it may be regarded as a compound of the group SO_2 with twice the group OH . Each of these QH groups is equivalent in combining or displacing power to a monad element, since it consists of an atom of dyad oxygen associated with a single atom of monad hydrogen, so that in this case the SO_2 group is equivalent to an atom of a dyad element. This formula for sulphuric acid, however, merely represents such facts as that it is possible to displace an atom of hydrogen and an atom of oxygen in sulphuric acid by a single atom of chlorine, thus forming the compound SO_2HCl ; and that by the action of water on the compound SO_2Cl_2 twice the group OH , or water minus an atom of hydrogen, is introduced in place of the two monad atoms of chlorine—



Constitutional formulae like these, in fact, are nothing more than symbolic expressions of the character of the compounds which they represent, the arrangement of symbols in a certain definite manner being understood to convey certain information with regard to the compounds represented.

Groups of two or more atoms like SO_2 and OH , which are capable of playing the part of elementary atoms (that is to say, which can be transferred from compound to compound), are termed compound radicals, the elementary atoms being simple radicals. Thus, the atom of hydrogen is a monad simple radical, the atom of oxygen a dyad simple radical, whilst the group OH is a monad compound radical.

It is often convenient to regard compounds as formed upon certain types; alcohol, for example, may be said to be a compound formed upon the water type, that is to say, a compound formed from water by displacing one of the atoms of hydrogen by the group of elements C_2H_5 , thus—

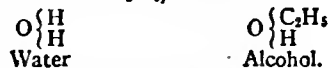

Constitutional formulae become of preponderating importance when we consider the more complicated inorganic and especially organic compounds. Their full significance is treated in the section of this article dealing with organic chemistry, and in the articles ISOMERISM and STEREO-ISOMERISM.

Chemical Action.—Chemical change or chemical action may be said to take place whenever changes occur which involve an alteration in the composition of molecules, and may be the result of the action of agents such as heat, electricity or light, or of two or more elements or compounds upon each other.

Three kinds of changes are to be distinguished, viz. changes which involve combination, changes which involve decomposition or separation, and changes which involve at the same time both decomposition and combination. Changes of the first and second kind, according to our views of the constitution of molecules, are probably of very rare occurrence; in fact, chemical action appears almost always to involve the occurrence of both these kinds of change, for, as already pointed out, we must assume that the molecules of hydrogen, oxygen and several other elements are diatomic, or that they consist of two atoms. Indeed, it appears probable that with few exceptions the elements

are all compounds of similar atoms united together by one or more units of affinity, according to their valencies. If this be the case, however, it is evident that there is no real distinction between the reactions which take place when two elements combine together and when an element in a compound is displaced by another. The combination, as it is ordinarily termed, of chlorine with hydrogen, and the displacement of iodine in potassium iodide by the action of chlorine, may be cited as examples; if these reactions are represented, as such reactions very commonly are, by equations which merely express the relative weights of the bodies which enter into reaction, and of the products, thus—

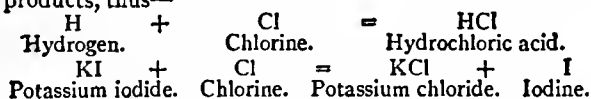

they appear to differ in character; but if they are correctly represented by molecular equations, or equations which express the relative number of molecules which enter into reaction and which result from the reaction, it will be obvious that the character of the reaction is substantially the same in both cases, and that both are instances of the occurrence of what is ordinarily termed double decomposition—

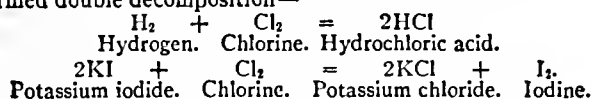

In all cases of chemical change energy in the form of heat is either developed or absorbed, and the amount of heat developed or absorbed in a given reaction is as definite as are the weights of the substance engaged in the reaction. Thus, in the production of hydrochloric acid from hydrogen and chlorine 22,000 calories are developed; in the production of hydrobromic acid from hydrogen and bromine, however, only 8440 calories are developed; and in the formation of hydriodic acid from hydrogen and iodine 6040 calories are absorbed.

This difference in behaviour of the three elements, chlorine, bromine and iodine, which in many respects exhibit considerable resemblance, may be explained in the following manner. We may suppose that in the formation of gaseous hydrochloric acid from gaseous chlorine and hydrogen, according to the equation

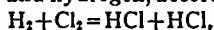

a certain amount of energy is expended in separating the atoms of hydrogen in the hydrogen molecule, and the atoms of chlorine in the chlorine molecule, from each other; but that heat is developed by the combination of the hydrogen atoms with the chlorine atoms, and that, as more energy is developed by the union of the atoms of hydrogen and chlorine than is expended in separating the hydrogen atoms from each other and the chlorine atoms from one another, the result of the action of the two elements upon each other is the development of heat,—the amount finally developed in the reaction being the difference between that absorbed in decomposing the elementary molecules and that developed by the combination of the atoms of chlorine and hydrogen. In the formation of gaseous hydrobromic acid from liquid bromine and gaseous hydrogen—

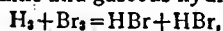

in addition to the energy expended in decomposing the hydrogen and bromine molecules, energy is also expended in converting the liquid bromine into the gaseous condition, and probably less heat is developed by the combination of bromine and hydrogen than by the combination of chlorine and hydrogen, so that the amount of heat finally developed is much less than is developed in the formation of hydrochloric acid. Lastly, in the production of gaseous hydriodic acid from hydrogen and solid iodine—

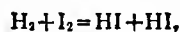

so much energy is expended in the decomposition of the hydrogen and iodine molecules and in the conversion of the iodine into the gaseous condition, that the heat which it may be supposed is developed by the combination of the hydrogen and iodine atoms is insufficient to balance the expenditure, and the final result is

therefore negative; hence it is necessary in forming hydriodic acid from its elements to apply heat continuously.

These compounds also afford examples of the fact that, generally speaking, those compounds are most readily formed, and are most stable, in the formation of which the most heat is developed. Thus, chlorine enters into reaction with hydrogen, and removes hydrogen from hydrogenized bodies, far more readily than bromine; and hydrochloric acid is a far more stable substance than hydrobromic acid, hydriodic acid being greatly inferior even to hydrobromic acid in stability. Compounds formed with the evolution of heat are termed exothermic, while those formed with an absorption are termed endothermic. Explosives are the commonest examples of endothermic compounds.

When two substances which by their action upon each other develop much heat enter into reaction, the reaction is usually complete without the employment of an excess of either; for example, when a mixture of hydrogen and oxygen, in the proportions to form water—

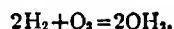

is exploded, it is entirely converted into water. This is also the case if two substances are brought together in solution, by the action of which upon each other a third body is formed which is insoluble in the solvent employed, and which also does not tend to react upon any of the substances present; for instance, when a solution of a chloride is added to a solution of a silver salt, insoluble silver chloride is precipitated, and almost the whole of the silver is removed from solution, even if the amount of the chloride employed be not in excess of that theoretically required.

But if there be no tendency to form an insoluble compound, or one which is not liable to react upon any of the other substances present, this is no longer the case. For example, when a solution of a ferric salt is added to a solution of potassium thiocyanate, a deep red coloration is produced, owing to the formation of ferric thiocyanate. Theoretically the reaction takes place in the case of ferric nitrate in the manner represented by the equation

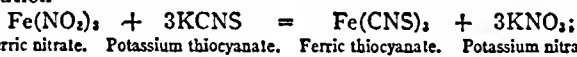

Ferric nitrate. Potassium thiocyanate. Ferric thiocyanate. Potassium nitrate.

but it is found that even when more than sixty times the amount of potassium thiocyanate required by this equation is added, a portion of the ferric nitrate still remains unconverted, doubtless owing to the occurrence of the reverse change—

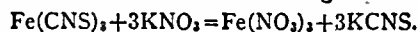

In this, as in most other cases in which substances act upon one another under such circumstances that the resulting compounds are free to react, the extent to which the different kinds of action which may occur take place is dependent upon the mass of the substances present in the mixture. As another instance of this kind, the decomposition of bismuth chloride by water may be cited. If a very large quantity of water be added, the chloride is entirely decomposed in the manner represented by the equation—

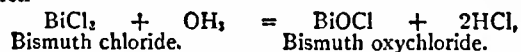

Bismuth chloride. Bismuth oxychloride.

the oxychloride being precipitated; but if smaller quantities of water be added the decomposition is incomplete, and it is found that the extent to which decomposition takes place is proportional to the quantity of water employed, the decomposition being incomplete, except in presence of large quantities of water, because of the occurrence of the reverse action—

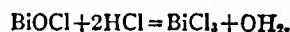

Chemical change which merely involves simple decomposition is thus seen to be influenced by the masses of the reacting substances and the presence of the products of decomposition; in other words the system of reacting substances and resultants form a mixture in which chemical action has apparently ceased, or the system is in equilibrium. Such reactions are termed reversible (see CHEMICAL ACTION).

III. INORGANIC CHEMISTRY

Inorganic chemistry is concerned with the descriptive study of the elements and their compounds, except those of carbon. Reference should be made to the separate articles on the different elements and the more important compounds for their preparation, properties and uses. In this article the development of this branch of the science is treated historically.

The earliest discoveries in inorganic chemistry are to be found in the metallurgy, medicine and chemical arts of the ancients. The Egyptians obtained silver, iron, copper, lead, zinc and tin, either pure or as alloys, by smelting the ores; mercury is mentioned by Theophrastus (c. 300 B.C.). The manufacture of glass, also practised in Egypt, demanded a knowledge of sodium or potassium carbonates; the former occurs as an efflorescence on the shores of certain lakes; the latter was obtained from wood ashes. Many substances were used as pigments: Pliny records white lead, cinnabar, verdigris and red oxide of iron; and the preparation of coloured glasses and enamels testifies to the uses to which these and other substances were put. Salts of ammonium were also known; while alum was used as a mordant in dyeing. Many substances were employed in ancient medicine: galena was the basis of a valuable Egyptian cosmetic and drug; the arsenic sulphides, realgar and orpiment, litharge, alum, saltpetre, iron rust were also used. Among the Arabian and later alchemists we find attempts made to collate compounds by specific properties, and it is to these writers that we are mainly indebted for such terms as "alkali," "sal," &c. The mineral acids, hydrochloric, nitric and sulphuric acids, and also *aqua regia* (a mixture of hydrochloric and nitric acids) were discovered, and the vitriols, alum, saltpetre, sal-ammoniac, ammonium carbonate, silver nitrate (*lunar caustic*) became better known. The compounds of mercury attracted considerable attention, mainly on account of their medicinal properties; mercuric oxide and corrosive sublimate were known to pseudo-Geber, and the nitrate and basic sulphate to "Basil Valentine." Antimony and its compounds formed the subject of an elaborate treatise ascribed to this last writer, who also contributed to our knowledge of the compounds of zinc, bismuth and arsenic. All the commonly occurring elements and compounds appear to have received notice by the alchemists; but the writings assigned to the alchemical period are generally so vague and indefinite that it is difficult to determine the true value of the results obtained.

In the succeeding iatrochemical period, the methods of the alchemists were improved and new ones devised. Glauber showed how to prepare hydrochloric acid, *spiritus salis*, by heating rock-salt with sulphuric acid, the method in common use to-day; and also nitric acid from saltpetre and arsenic trioxide. Libavius obtained sulphuric acid from many substances, e.g. alum, vitriol, sulphur and nitric acid, by distillation. The action of these acids on many metals was also studied; Glauber obtained zinc, stannic, arsenious and cuprous chlorides by dissolving the metals in hydrochloric acid, compounds hitherto obtained by heating the metals with corrosive sublimate, and consequently supposed to contain mercury. The scientific study of salts dates from this period, especial interest being taken in those compounds which possessed a medicinal or technical value. In particular, the salts of potassium, sodium and ammonium were carefully investigated, but sodium and potassium salts were rarely differentiated.¹ The metals of the alkaline-earths were somewhat neglected; we find Georg Agricola considering gypsum (calcium sulphate) as a compound of lime, while calcium nitrate and chloride became known at about the beginning of the 17th century. Antimonial, bismuth and arsenical compounds were assiduously studied, a direct consequence of their high medicinal importance; mercurial and silver compounds were investigated for the same reason. The general tendency of this period appears to have taken the form of improving and developing the methods of the alchemists;

¹ The definite distinction between potash and soda was first established by Duhamel de Monceau (1700-1781).

few new fields were opened, and apart from a more complete knowledge of the nature of salts, no valuable generalizations were attained.

The discovery of phosphorus by Brand, a Hamburg alchemist, in 1669 excited chemists to an unwonted degree; it was also independently prepared by Robert Boyle and J. Kunkel, Brand having kept his process secret. Towards the middle of the 18th century two new elements were isolated: cobalt by G. Brandt in 1742, and nickel by A. F. Cronstedt in 1750. These discoveries were followed by Daniel Rutherford's isolation of nitrogen in 1772, and by K. Scheele's isolation of chlorine and oxygen in 1774 (J. Priestley discovered oxygen independently at about the same time), and his investigation of molybdic and tungstic acids in the following year; metallic molybdenum was obtained by P. J. Hjelm in 1783, and tungsten by Don Fausto d'Elhuyar; manganese was isolated by J. G. Gahn in 1774. In 1784 Henry Cavendish thoroughly examined hydrogen, establishing its elementary nature; and he made the far-reaching discovery that water was composed of two volumes of hydrogen to one of oxygen.

The phlogistic theory, which pervaded the chemical doctrine of this period, gave rise to continued study of the products of calcination and combustion; it thus happened that the knowledge of oxides and oxidation products was considerably developed. The synthesis of nitric acid by passing electric sparks through moist air by Cavendish is a famous piece of experimental work, for in the first place it determined the composition of this important substance, and in the second place the minute residue of air which would not combine, although ignored for about a century, was subsequently examined by Lord Rayleigh and Sir William Ramsay, who showed that it consists of a mixture of elementary substances—argon, krypton, neon and xenon (see ARGON).

The 18th century witnessed striking developments in pneumatic chemistry, or the chemistry of gases, which had been begun by van Helmont, Mayow, Hales and Boyle. Gases formerly considered to be identical came to be clearly distinguished, and many new ones were discovered. Atmospheric air was carefully investigated by Cavendish, who showed that it consisted of two elementary constituents: nitrogen, which was isolated by Rutherford in 1772, and oxygen, isolated in 1774; and Black established the presence, in minute quantity, of carbon dioxide (van Helmont's *gas sylvestre*). Of the many workers in this field, Priestley occupies an important position. A masterly device, initiated by him, was to collect gases over mercury instead of water; this enabled him to obtain gases previously only known in solution, such as ammonia, hydrochloric acid, silicon fluoride and sulphur dioxide. Sulphuretted hydrogen and nitric oxide were discovered at about the same time.

Returning to the history of the discovery of the elements and their more important inorganic compounds, we come in 1789 to M. H. Klaproth's detection of a previously unknown constituent of the mineral pitchblende. He extracted a substance to which he assigned the character of an element, naming it uranium (from *Οὐρανός*, heaven); but it was afterwards shown by E. M. Péligot, who prepared the pure metal, that Klaproth's product was really an oxide. This element was investigated at a later date by Sir Henry Roscoe, and more thoroughly and successfully by C. Zimmermann and Alibegoff. Pitchblende attained considerable notoriety towards the end of the 19th century on account of two important discoveries. The first, made by Sir William Ramsay in 1896, was that the mineral evolved a peculiar gas when treated with sulphuric acid; this gas, helium (*q.v.*), proved to be identical with a constituent of the sun's atmosphere, detected as early as 1868 by Sir Norman Lockyer during a spectroscopic examination of the sun's chromosphere. The second discovery, associated with the Curies, is that of the peculiar properties exhibited by the impure substance, and due to a constituent named radium. The investigation of this substance and its properties (see RADIOACTIVITY) has proceeded so far as to render it probable that the theory of the unalterability

of elements, and also the hitherto accepted explanations of various celestial phenomena—the source of solar energy and the appearances of the tails of comets—may require recasting.

In the same year as Klaproth detected uranium, he also isolated zirconia or zirconium oxide from the mineral variously known as zircon, hyacinth, jacynth and jargoon, but he failed to obtain the metal, this being first accomplished some years later by Berzelius, who decomposed the double potassium zirconium fluoride with potassium. In the following year, 1795, Klaproth announced the discovery of a third new element, titanium, its isolation (in a very impure form), as in the case of zirconium, was reserved for Berzelius.

Passing over the discovery of carbon disulphide by W. A. Lampadius in 1796, of chromium by L. N. Vauquelin in 1797, and Klaproth's investigation of tellurium in 1798, the next important series of observations was concerned with platinum and the allied metals. Platinum had been described by Antonio de Ulloa in 1748, and subsequently discussed by H. T. Scheffer in 1752. In 1803 W. H. Wollaston discovered palladium, especially interesting for its striking property of absorbing ("occluding") as much as 376 volumes of hydrogen at ordinary temperatures, and 643 volumes at 90°. In the following year he discovered rhodium; and at about the same time Smithson Tennant added two more to the list—iridium and osmium; the former was so named from the changing tints of its oxides (*ἶρις*, rainbow), and the latter from the odour of its oxide (*ὀσμή*, smell). The most recently discovered "platinum metal," ruthenium, was recognized by C. E. Claus in 1845. The great number and striking character of the compounds of this group of metals have formed the subject of many investigations, and already there is a most voluminous literature. Berzelius was an early worker in this field, he was succeeded by Bunsen, and Deville and Debray, who worked out the separation of rhodium; and at a later date by P. T. Cleve, the first to make a really thorough study of these elements and their compounds. Of especial note are the curious compounds formed by the union of carbon monoxide with platinum chloride, discovered by Paul Schützenberger and subsequently investigated by F. B. Mylius and F. Foerster and by Pullinger; the phosphoplatinic compounds formed primarily from platinum and phosphorus pentachloride; and also the "ammino" compounds, formed by the union of ammonia with the chloride, &c., of these metals, which have been studied by many chemists, especially S. M. Jörgensen. Considerable uncertainty existed as to the atomic weights of these metals, the values obtained by Berzelius being doubtful. K. F. O. Seubert redetermined this constant for platinum, osmium and iridium, E. H. Keiser for palladium, and A. A. Joly for ruthenium.

The beginning of the 19th century witnessed the discovery of certain powerful methods for the analysis of compounds and the isolation of elements. Berzelius's investigation of the action of the electric current on salts clearly demonstrated the invaluable assistance that electrolysis could render to the isolator of elements; and the adoption of this method by Sir Humphry Davy for the analysis of the hydrates of the metals of the alkalis and alkaline earths, and the results which he thus achieved, established its potency. In 1808 Davy isolated sodium and potassium; he then turned his attention to the preparation of metallic calcium, barium, strontium and magnesium. Here he met with greater difficulty, and it is to be questioned whether he obtained any of these metals even in an approximately pure form (see ELECTROMETALLURGY). The discovery of boron by Gay Lussac and Davy in 1809 led Berzelius to investigate silica (*silex*). In the following year he announced that silica was the oxide of a hitherto unrecognized element, which he named *silicium*, considering it to be a metal. This has proved to be erroneous; it is non-metallic in character, and its name was altered to silicon, from analogy with carbon and boron. At the same time Berzelius obtained the element, in an impure condition, by fusing silica with charcoal and iron in a blast furnace; its preparation in a pure condition he first accomplished in 1823, when he invented the method of heating

double potassium fluorides with metallic potassium. The success which attended his experiments in the case of silicon led him to apply it to the isolation of other elements. In 1824 he obtained zirconium from potassium zirconium fluoride; the preparation of (impure) titanium quickly followed, and in 1828 he obtained thorium. A similar process, and equally efficacious, was introduced by F. Wöhler in 1827. It consisted in heating metallic chlorides with potassium, and was first applied to aluminium, which was isolated in 1827; in the following year, beryllium chloride was analysed by the same method, beryllium oxide (berylla or glucina) having been known since 1798, when it was detected by L. N. Vauquelin in the gem-stone beryl.

In 1812 B. Courtois isolated the element iodine from "kelp," the burnt ashes of marine plants. The chemical analogy of this substance to chlorine was quickly perceived, especially after its investigation by Davy and Gay Lussac. Cyanogen, a compound which in combination behaved very similarly to chlorine and iodine, was isolated in 1815 by Gay Lussac. This discovery of the first of the then-styled "compound radicals" exerted great influence on the prevailing views of chemical composition. Hydrochloric acid was carefully investigated at about this time by Davy, Faraday and Gay Lussac, its composition and the elementary nature of chlorine being thereby established.

In 1817 F. Stromeyer detected a new metallic element, cadmium, in certain zinc ores; it was rediscovered at subsequent dates by other observers and its chemical resemblance to zinc noticed. In the same year Berzelius discovered selenium in a deposit from sulphuric acid chambers, his masterly investigation including a study of the hydride, oxides and other compounds. Selenic acid was discovered by E. Mitscherlich, who also observed the similarity of the crystallographic characters of selenates and sulphates, which afforded valuable corroboration of his doctrine of isomorphism. More recent and elaborate investigations in this direction by A. E. H. Tutton have confirmed this view.

In 1818 L. J. Thénard discovered hydrogen dioxide, one of the most interesting inorganic compounds known, which has since been carefully investigated by H. E. Schöne, M. Traube, Wolfenstein and others. About the same time, J. A. Arfvedson, a pupil of Berzelius, detected a new element, which he named lithium, in various minerals—notably petalite. Although unable to isolate the metal, he recognized its analogy to sodium and potassium; this was confirmed by R. Bunsen and A. Matthiessen in 1855, who obtained the metal by electrolysis and thoroughly examined it and its compounds. Its crimson flame-coloration was observed by C. G. Gmelin in 1818.

The discovery of bromine in 1826 by A. J. Balard completed for many years Berzelius's group of "halogen" elements, the remaining member, fluorine, notwithstanding many attempts, remained unisolated until 1886, when Henri Moissan obtained it by the electrolysis of potassium fluoride dissolved in hydrofluoric acid. Hydrobromic and hydriodic acids were investigated by Gay Lussac and Balard, while hydrofluoric acid received considerable attention at the hands of Gay Lussac, Thénard and Berzelius. We may, in fact, consider that the descriptive study of the various halogen compounds dates from about this time. Balard discovered chlorine monoxide in 1834, investigating its properties and reactions; and his observations on hypochlorous acid and hypochlorites led him to conclude that "bleaching-powder" or "chloride of lime" was a compound or mixture in equimolecular proportions of calcium chloride and hypochlorite, with a little calcium hydrate. Gay Lussac investigated chloric acid, Stadion discovered perchloric acid, since more fully studied by G. S. Serullas and Roscoe; Davy and Stadion investigated chlorine peroxide, formed by treating potassium chlorate with sulphuric acid. Davy also described and partially investigated the gas, named by him "euchlorine," obtained by heating potassium chlorate with hydrochloric acid; this gas has been more recently examined by Pebal. The oxy-acids of iodine were investigated by Davy and H. G. Magnus; periodic acid, discovered by the latter, is characterized by the striking complexity of its salts as pointed out by Kimmins.

In 1830 N. G. Sefström definitely proved the existence of a metallic element vanadium, which had been previously detected (in 1801) in certain lead ores by A. M. del Rio; subsequent elaborate researches by Sir Henry Roscoe showed many inaccuracies in the conclusions of earlier workers (for instance, the substance considered to be the pure element was in reality an oxide) and provided science with an admirable account of this element and its compounds. B. W. Gerland contributed to our knowledge of vanadyl salts and the vanadic acids. Chemically related to vanadium are the two elements tantalum and columbium or niobium. These elements occur in the minerals columbite and tantalite, and their compounds became known in the early part of the 19th century by the labours of C. Hatchett, A. G. Ekeberg, W. H. Wollaston and Berzelius. But the knowledge was very imperfect; neither was it much clarified by H. Rose, who regarded niobium oxide as the element. The subject was revived in 1866 by C. W. Blomstrand and J. C. Marignac, to whom is due the credit of first showing the true chemical relations of these elements. Subsequent researches by Sainte Claire Deville and L. J. Troost, and by A. G. Krüss and L. E. Nilson, and subsequently (1904) by Hall, rendered notable additions to our knowledge of these elements and their compounds. Tantalum has in recent years been turned to economic service, being employed, in the same manner as tungsten, for the production of the filaments employed in incandescent electric lighting.

In 1833 Thomas Graham, following the paths already traced out by E. D. Clarke, Gay Lussac and Stromeyer, published his masterly investigation of the various phosphoric acids and their salts, obtaining results subsequently employed by J. von Liebig in establishing the doctrine of the characterization and basicity of acids. Both phosphoric and phosphorous acids became known, although imperfectly, towards the end of the 18th century; phosphorous acid was first obtained pure by Davy in 1812, while pure phosphorous oxide, the anhydride of phosphorous acid, remained unknown until T. E. Thorpe's investigation of the products of the slow combustion of phosphorus. Of other phosphorus compounds we may here notice Gengembre's discovery of phosphuretted hydrogen (phosphine) in 1783, the analogy of which to ammonia was first pointed out by Davy and supported at a later date by H. Rose; liquid phosphuretted hydrogen was first obtained by Thénard in 1838, and hypophosphorous acid was discovered by Dulcng in 1816. Of the halogen compounds of phosphorus, the trichloride was discovered by Gay Lussac and Thénard, while the pentachloride was obtained by Davy. The oxychloride, bromides, and other compounds were subsequently discovered, here we need only notice Moissan's preparation of the trifluoride and Thorpe's discovery of the pentafluoride, a compound of especial note, for it volatilizes unchanged, giving a vapour of normal density and so demonstrating the stability of a pentavalent phosphorus compound (the pentachloride and pentabromide dissociate into a molecule of the halogen element and phosphorus trichloride).

In 1840 C. F. Schönbein investigated ozone, a gas of peculiar odour (named from the Gr. *ὄζων*, to smell) observed in 1785 by Martin van Marum to be formed by the action of a silent electric discharge on the oxygen of the air; he showed it to be an allotropic modification of oxygen, a view subsequently confirmed by Marignac, Andrews and Soret. In 1845 a further contribution to the study of allotropy was made by Anton Schrötter, who investigated the transformations of yellow and red phosphorus, phenomena previously noticed by Berzelius, the inventor of the term "allotropy." The preparation of crystalline boron in 1856 by Wöhler and Sainte Claire Deville showed that this element also existed in allotropic forms, amorphous boron having been obtained simultaneously and independently in 1809 by Gay Lussac and Davy. Before leaving this phase of inorganic chemistry, we may mention other historical examples of allotropy. Of great importance is the chemical identity of the diamond, graphite and charcoal, a fact demonstrated in part by Lavoisier in 1773, Smithson Tennant in 1796, and by Sir George

Steuart-Mackenzie (1780-1848), who showed that equal weights of these three substances yielded the same weight of carbon dioxide on combustion. The allotropy of selenium was first investigated by Berzelius; and more fully in 1851 by J. W. Hittorf, who carefully investigated the effects produced by heat; crystalline selenium possesses a very striking property, viz. when exposed to the action of light its electric conductivity increases. Another element occurring in allotropic forms is sulphur, of which many forms have been described. E. Mitscherlich was an early worker in this field. A modification known as "black sulphur," soluble in water, was announced by F. L. Knapp in 1848, and a colloidal modification was described by H. Debus. The dynamical equilibrium between rhombic, liquid and monosymmetric sulphur has been worked out by H. W. Bakhuis Roozeboom. The phenomenon of allotropy is not confined to the non-metals, for evidence has been advanced to show that allotropy is far commoner than hitherto supposed. Thus the researches of Carey Lea, E. A. Schneider and others, have proved the existence of "colloidal silver"; similar forms of the metals gold, copper, and of the platinum metals have been described. The allotropy of arsenic and antimony is also worthy of notice, but in the case of the first element the variation is essentially non-metallic, closely resembling that of phosphorus. The term allotropy has also been applied to inorganic compounds, identical in composition, but assuming different crystallographic forms. Mercuric oxide, sulphide and iodide, arsenic trioxide; titanium dioxide and silicon dioxide may be cited as examples.

The joint discovery in 1850 of the powerful method of spectrum analysis (see SPECTROSCOPY) by G. R. Kirchhoff and R. W. Bunsen, and its application to the detection and the characterization of elements when in a state of incandescence, rapidly led to the discovery of many hitherto unknown elements. Within two years of the invention the authors announced the discovery of two metals, rubidium and caesium, closely allied to sodium, potassium and lithium in properties, in the mineral lepidolite and in the Dürkheim mineral water. In 1861 Sir William Crookes detected thallium (named from the Gr. *θάλλος*, a green bud, on account of a brilliant green line in its spectrum) in the selenious mud of the sulphuric acid manufacture, the chemical affinities of this element, on the one hand approximating to the metals of the alkalis, and on the other hand to lead, were mainly established by C. A. Lamy. Of other metals first detected by the spectroscope mention is to be made of indium, determined by F. Reich and H. T. Richter in 1863, and of gallium, detected in certain zinc blends by Lecoq de Boisbaudran in 1875. The spectroscope has played an all-important part in the characterization of the elements, which, in combination with oxygen, constitute the group of substances collectively named the "rare earths." The substances occur, in very minute quantity, in a large number of sparingly-distributed and comparatively rare minerals—euxenite, samarskite, cerite, yttrantalite, &c. Scandinavian specimens of these minerals were examined by J. Gadolin, M. H. Klaproth, and especially by Berzelius; these chemists are to be regarded as the pioneers in this branch of descriptive chemistry. Since their day many chemists have entered the lists, new and powerful methods of research have been devised, and several new elements definitely characterized. Our knowledge on many points, however, is very chaotic; great uncertainty and conflict of evidence circulate around many of the "new elements" which have been announced, so much so that P. T. Cleve proposed to divide the "rare earth" metals into two groups, (1) "perfectly characterized"; (2) "not yet thoroughly characterized." The literature of this subject is very large. The memorial address on J. C. G. de Marignac, a noted worker in this field, delivered by Cleve, a high authority on this subject, before the London Chemical Society (*J. C. S. Trans.*, 1895, p. 468), and various papers in the same journal by Sir William Crookes, Bohuslav Brauner and others should be consulted for details.

In the separation of the constituents of the complex mixture of oxides obtained from the "rare earth" minerals, the methods

generally forced upon chemists are those of fractional precipitation or crystallization; the striking resemblances of the compounds of these elements rarely admitting of a complete separation by simple precipitation and filtration. The extraordinary patience requisite to a successful termination of such an analysis can only be adequately realized by actual research; an idea may be obtained from Crookes's *Select Methods in Analysis*. Of recent years the introduction of various organic compounds as precipitants or reagents has reduced the labour of the process; and advantage has also been taken of the fairly complex double salts which these metals form with compounds. The purity of the compounds thus obtained is checked by spectroscopic observations. Formerly the spark- and absorption-spectra were the sole methods available; a third method was introduced by Crookes, who submitted the oxides, or preferably the basic sulphates, to the action of a negative electric discharge *in vacuo*, and investigated the phosphorescence induced spectroscopically. By such a study in the ultra-violet region of a fraction prepared from crude yttria he detected a new element victorium, and subsequently by elaborate fractionation obtained the element itself.

The first earth of this group to be isolated (although in an impure form) was yttria, obtained by Gadolin in 1794 from the mineral gadolinite, which was named after its discoverer and investigator. Klaproth and Vauquelin also investigated this earth, but without detecting that it was a complex mixture—a discovery reserved for C. G. Mosander. The next discovery, made independently and simultaneously in 1803 by Klaproth and by W. Hisinger and Berzelius, was of ceria, the oxide of cerium, in the mineral cerite found at Ridderhytta, Westmannland, Sweden. These crude earths, yttria and ceria, have supplied most if not all of the "rare earth" metals. In 1841 Mosander, having in 1839 discovered a new element lanthanum in the mineral cerite, isolated this element and also a hitherto unrecognized substance, didymia, from crude yttria, and two years later he announced the determination of two fresh constituents of the same earth, naming them erbia and terbia. Lanthanum has retained its elementary character, but recent attempts at separating it from didymia have led to the view that didymium is a mixture of two elements, praseodymium and neodymium (see DIDYMIUM). Mosander's erbia has been shown to contain various other oxides—thulia, holmia, &c.—but this has not yet been perfectly worked out. In 1878 Marignac, having subjected Mosander's erbia, obtained from gadolinite, to a careful examination, announced the presence of a new element, ytterbium; this discovery was confirmed by Nilson, who in the following year discovered another element, scandium, in Marignac's ytterbia. Scandium possesses great historical interest, for Cleve showed that it was one of the elements predicted by Mendeléeff about ten years previously from considerations based on his periodic classification of the elements (see ELEMENT). Other elements predicted and characterized by Mendeléeff which have been since realized are gallium, discovered in 1875, and germanium, discovered in 1885 by Clemens Winkler.

In 1880 Marignac examined certain earths obtained from the mineral samarskite, which had already in 1878 received attention from Delafontaine and later from Lecoq de Boisbaudran. He established the existence of two new elements, samarium and gadolinium, since investigated more especially by Cleve, to whom most of our knowledge on this subject is due. In addition to the rare elements mentioned above, there are a score or so more whose existence is doubtful. Every year is attended by fresh "discoveries" in this prolific source of elementary substances, but the paucity of materials and the predilections of the investigators militate in some measure against a just valuation being accorded to such researches. After having been somewhat neglected for the greater attractions and wider field presented by organic chemistry, the study of the elements and their inorganic compounds is now rapidly coming into favour; new investigators are continually entering the lists; the beaten paths are being retraversed and new ramifications pursued.

IV. ORGANIC CHEMISTRY

While inorganic chemistry was primarily developed through the study of minerals—a connexion still shown by the French appellation *chimie minérale*—organic chemistry owes its origin to the investigation of substances occurring in the vegetable and animal organisms. The quest of the alchemists for the philosopher's stone, and the almost general adherence of the iatrochemists to the study of the medicinal characters and preparation of metallic compounds, stultified in some measure the investigation of vegetable and animal products. It is true that by the distillation of many herbs, resins and similar substances, several organic compounds had been prepared, and in a few cases employed as medicines; but the prevailing classification of substances by physical and superficial properties led to the correlation of organic and inorganic compounds, without any attention being paid to their chemical composition. The clarification and spirit of research so clearly emphasized by Robert Boyle in the middle of the 17th century is reflected in the classification of substances expounded by Nicolas Lémery, in 1675, in his *Cours de chymie*. Taking as a basis the nature of the source of compounds, he framed three classes: "mineral," comprising the metals, minerals, earths and stones; "vegetable," comprising plants, resins, gums, juices, &c.; and "animal," comprising animals, their different parts and excreta. Notwithstanding the inconsistency of his allocation of substances to the different groups (for instance, acetic acid was placed in the vegetable class, while the acetates and the products of their dry distillation, acetone, &c., were placed in the mineral class), this classification came into favour. The phlogistonists endeavoured to introduce chemical notions to support it: Becher, in his *Physica subterranea* (1669), stated that mineral, vegetable and animal matter contained the same elements, but that more simple combinations prevailed in the mineral kingdom; while Stahl, in his *Specimen Becherianum* (1702), held the "earthy" principle to predominate in the mineral class, and the "aqueous" and "combustible" in the vegetable and animal classes. It thus happened that in the earlier treatises on phlogistic chemistry organic substances were grouped with all combustibles.

The development of organic chemistry from this time until almost the end of the 18th century was almost entirely confined to such compounds as had practical applications, especially in pharmacy and dyeing. A new and energetic spirit was introduced by Scheele; among other discoveries this gifted experimenter isolated and characterized many organic acids, and proved the general occurrence of glycerin (*Ölsüss*) in all oils and fats. Bergman worked in the same direction; while Rouelle was attracted to the study of animal chemistry. Theoretical speculations were revived by Lavoisier, who, having explained the nature of combustion and determined methods for analysing compounds, concluded that vegetable substances ordinarily contained carbon, hydrogen and oxygen, while animal substances generally contained, in addition to these elements, nitrogen, and sometimes phosphorus and sulphur. Lavoisier, to whom chemistry was primarily the chemistry of oxygen compounds, having developed the radical theory initiated by Guyton de Morveau, formulated the hypothesis that vegetable and animal substances were oxides of radicals composed of carbon and hydrogen; moreover, since simple radicals (the elements) can form more than one oxide, he attributed the same character to his hydrocarbon radicals: he considered, for instance, sugar to be a neutral oxide and oxalic acid a higher oxide of a certain radical, for, when oxidized by nitric acid, sugar yields oxalic acid. At the same time, however, he adhered to the classification of Lémery; and it was only when identical compounds were obtained from both vegetable and animal sources that this subdivision was discarded, and the classes were assimilated in the division organic chemistry.

At this time there existed a belief, held at a later date by Berzelius, Gmelin and many others, that the formation of organic compounds was conditioned by a so-called *vital force*; and the difficulty of artificially realizing this action explained the supposed impossibility of synthesizing organic compounds.

This dogma was shaken by Wöhler's synthesis of urea in 1828. But the belief died hard; the synthesis of urea remained isolated for many years, and many explanations were attempted by the vitalists (as, for instance, that urea was halfway between the inorganic and organic kingdoms, or that the carbon, from which it was obtained, retained the essentials of this hypothetical vital force), but only to succumb at a later date to the indubitable fact that the same laws of chemical combination prevail in both the animate and inanimate kingdoms, and that the artificial or laboratory synthesis of any substance, either inorganic or organic, is but a question of time, once its constitution is determined.¹

The exact delimitation of inorganic and organic chemistry engrossed many minds for many years; and on this point there existed considerable divergence of opinion for several decades. In addition to the vitalistic doctrine of the origin of organic compounds, views based on purely chemical considerations were advanced. The atomic theory, and its correlatives—the laws of constant and multiple proportions—had been shown to possess absolute validity so far as well-characterized inorganic compounds were concerned; but it was open to question whether organic compounds obeyed the same laws. Berzelius, in 1813 and 1814, by improved methods of analysis, established that the Daltonian laws of combination held in both the inorganic and organic kingdoms; and he adopted the view of Lavoisier that organic compounds were oxides of compound radicals, and therefore necessarily contained at least three elements—carbon, hydrogen and oxygen. This view was accepted in 1817 by Leopold Gmelin, who, in his *Handbuch der Chemie*, regarded inorganic compounds as being of binary composition (the simplest being oxides, both acid and basic, which by combination form salts also of binary form), and organic compounds as ternary, *i.e.* composed of three elements; furthermore, he concluded that inorganic compounds could be synthesized, whereas organic compounds could not. A consequence of this empirical division was that marsh gas, ethylene and cyanogen were regarded as inorganic, and at a later date many other hydrocarbons of undoubtedly organic nature had to be included in the same division.

The binary conception of compounds held by Berzelius received apparent support from the observations of Gay Lussac, in 1815, on the vapour densities of alcohol and ether, which pointed to the conclusion that these substances consisted of one molecule of water and one and two of ethylene respectively; and from Pierre Jean Robiquet and Jean Jacques Colin, showing, in 1816, that ethyl chloride (hydrochloric ether) could be regarded as a compound of ethylene and hydrochloric acid.² Compound radicals came to be regarded as the immediate constituents of organic compounds; and, at first, a determination of their empirical composition was supposed to be sufficient to characterize them. To this problem there was added another in about the third decade of the 19th century—namely, to determine the manner in which the atoms composing the radical were combined; this supplementary requisite was due to the discovery of the isomerism of silver fulminate and silver cyanate by Justus von Liebig in 1823, and to M. Faraday's discovery of butylene, isomeric with ethylene, in 1825.

The classical investigation of Liebig and Friedrich Wöhler on the radical of benzoic acid ("Über das Radikal der Benzoesäure," *Ann. Chem.*, 1832, 3, p. 249) is to be regarded as a most important contribution to the radical theory, for it was shown that a radical containing the elements carbon, hydrogen and oxygen, which they named benzoyl (the termination *yl* coming from the Gr. ὄλη, matter), formed the basis of benzaldehyde, benzoic acid, benzoyl chloride, benzoyl bromide and benzoyl sulphide, benzamide and benzoic ether. Berzelius immediately appreciated the importance of this discovery, notwithstanding

¹ The reader is specially referred to the articles ALIZARIN; INDIGO; PURIN and TERPENES for illustrations of the manner in which chemists have artificially prepared important animal and vegetable products.

² These observations were generalized by J. B. Dumas and Polydore Boullay (1806-1835) in their "etherin theory" (*vide infra*).

that he was compelled to reject the theory that oxygen could not play any part in a compound radical—a view which he previously considered as axiomatic; and he suggested the names "proin" or "orthrin" (from the Gr. *πρωί* and *ὀρθρός*, at dawn). However, in 1833, Berzelius reverted to his earlier opinion that oxygenated radicals were incompatible with his electrochemical theory; he regarded benzoyl as an oxide of the radical $C_{14}H_{10}$, which he named "picramyl" (from *πικρός*, bitter, and *ἀμυγδάλη*, almond), the peroxide being anhydrous benzoic acid; and he dismissed the views of Gay Lussac and Dumas that ethylene was the radical of ether, alcohol and ethyl chloride, setting up in their place the idea that ether was a suboxide of ethyl, $(C_2H_5)_2O$, which was analogous to K_2O , while alcohol was an oxide of a radical C_2H_6 ; thus annihilating any relation between these two compounds. This view was modified by Liebig, who regarded ether as ethyl oxide, and alcohol as the hydrate of ethyl oxide; here, however, he was in error, for he attributed to alcohol a molecular weight double its true value. Notwithstanding these errors, the value of the "ethyl theory" was perceived; other radicals—formyl, methyl, amyl, acetyl, &c.—were characterized; Dumas, in 1837, admitted the failure of the etherin theory, and, in company with Liebig, he defined organic chemistry as the "chemistry of compound radicals." The knowledge of compound radicals received further increment at the hands of Robert W. Bunsen, the discoverer of the cacodyl compounds.

The radical theory, essentially dualistic in nature in view of its similarity to the electrochemical theory of Berzelius, was destined to succumb to a unitary theory. Instances had already been recorded of cases where a halogen element replaced hydrogen with the production of a closely allied substance. Gay Lussac had prepared cyanogen chloride from hydrocyanic acid, Faraday, hexachlorethane from ethylene dichloride, &c. Here the electro-negative halogens exercised a function similar to electro-positive hydrogen. Dumas gave especial attention to such substitutions, named *metalepsy* (*μετάληψις*, exchange); and framed the following empirical laws to explain the reactions:—(1) a body containing hydrogen when substituted by a halogen loses one atom of hydrogen for every atom of halogen introduced, (2) the same holds if oxygen be present, except that when the oxygen is present as water the latter first loses its hydrogen without replacement, and then substitution according to (1) ensues. Dumas went no further than thus epitomizing his observations, and the next development was made in 1836 by Auguste Laurent, who, having amplified and discussed the applicability of Dumas' views, promulgated his *Nucleus Theory*, which assumed the existence of "original nuclei or radicals" (*radicaux* or *noyaux fondamentaux*) composed of carbon and hydrogen, and "derived nuclei" (*radicaux* or *noyaux dérivés*) formed from the original nuclei by the substitution of hydrogen or the addition of other elements, and having properties closely related to the primary nuclei.

Vigorous opposition was made by Liebig and Berzelius, the latter directing his attack against Dumas, whom he erroneously believed to be the author of what was, in his opinion, a pernicious theory. Dumas repudiated the accusation, affirming that he held exactly contrary views to Laurent; but only to admit their correctness in 1839, when, from his own researches and those of Laurent, Malaguti and Regnault, he formulated his *type theory*. According to this theory a "chemical type" embraced compounds containing the same number of equivalents combined in a like manner and exhibiting similar properties; thus acetic and trichloroacetic acids, aldehyde and chloral, marsh gas and chloroform are pairs of compounds referable to the same type. He also postulated, with Regnault, the existence of "molecular or mechanical types" containing substances which, although having the same number of equivalents, are essentially different in characters. His unitary conceptions may be summarized: every chemical compound forms a complete whole, and cannot therefore consist of two parts; and its chemical character depends primarily upon the arrangement and number of the atoms, and, in a lesser degree, upon their chemical nature.

More emphatic opposition to the dualistic theory of Berzelius was hardly possible; this illustrious chemist perceived that the validity of his electrochemical theory was called in question, and therefore he waged vigorous war upon Dumas and his followers. But he fought in a futile cause; to explain the facts put forward by Dumas he had to invent intricate and involved hypotheses, which, it must be said, did not meet with general acceptance; Liebig seceded from him, and invited Wöhler to endeavour to correct him. Still, till the last Berzelius remained faithful to his original theory; experiment, which he had hitherto held to be the only sure method of research, he discarded, and in its place he substituted pure speculation, which greatly injured the radical theory. At the same time, however, the conception of radicals could not be entirely displaced, for the researches of Liebig and Wöhler, and those made subsequently by Bunsen, demonstrated beyond all doubt the advantages which would accrue from their correct recognition.

A step forward—the fusion of Dumas' type theory and the radical theory—was made by Laurent and Charles Gerhardt. As early as 1842, Gerhardt in his *Précis de chimie organique* exhibited a marked leaning towards Dumas' theory, and it is without doubt that both Dumas and Laurent exercised considerable influence on his views. Unwilling to discard the strictly unitary views of these chemists, or to adopt the copulae theory of Berzelius, he revived the notion of radicals in a new form. According to Gerhardt, the process of substitution consisted of the union of two *residues* to form a unitary whole; these residues, previously termed "compound radicals," are atomic complexes which remain over from the interaction of two compounds. Thus, he interpreted the interaction of benzene and nitric acid as $C_6H_6 + HNO_3 = C_6H_5NO_2 + H_2O$, the "residues" of benzene being C_6H_5 and H, and of nitric acid HO and NO_2 . Similarly he represented the reactions investigated by Liebig and Wöhler on benzoyl compounds as double decompositions.

This rejuvenation of the notion of radicals rapidly gained favour; and the complete fusion of the radical theory with the theory of types was not long delayed. In 1849 C. A. Wurtz discovered the amines or substituted ammonias, previously predicted by Liebig; A. W. von Hofmann continued the investigation, and established their recognition as ammonia in which one or more hydrogen atoms had been replaced by hydrocarbon radicals, thus formulating the "ammonia type." In 1850 A. W. Williamson showed how alcohol and ether were to be regarded as derived from water by substituting one or both hydrogen atoms by the ethyl group; he derived acids and the acid anhydrides from the same type; and from a comparison of many inorganic and the simple organic compounds he concluded that this notion of a "water-type" clarified, in no small measure, the conception of the structure of compounds.

These conclusions were co-ordinated in Gerhardt's "new theory of types." Taking as types hydrogen, hydrochloric acid, water and ammonia, he postulated that all organic compounds were referable to these four forms: the hydrogen type included hydrocarbons, aldehydes and ketones; the hydrochloric acid type, the chlorides, bromides and iodides; the water type, the alcohols, ethers, monobasic acids, acid anhydrides, and the analogous sulphur compounds; and the ammonia type, the amines, acid-amides, and the analogous phosphorus and arsenic compounds. The recognition of the polybasicity of acids, which followed from the researches of Thomas Graham and Liebig, had caused Williamson to suggest that dibasic acids could be referred to a double water type, the acid radical replacing an atom of hydrogen in each water molecule; while his discovery of tribasic formic ether, $CH(OC_2H_5)_3$, in 1854 suggested a triple water type. These views were extended by William Odling, and adopted by Gerhardt, but with modifications of Williamson's aspects. A further generalization was effected by August Kekulé, who rejected the hydrochloric acid type as unnecessary, and introduced the methane type and condensed mixed types. Pointing out that condensed types can only be fused with a radical replacing more than one atom of hydrogen, he laid the foundation of the doctrine of valency, a doctrine of incal-

able service to the knowledge of the structure of chemical compounds.

At about the same time Hermann Kolbe attempted a rehabilitation, with certain modifications, of the dualistic conception of Berzelius. He rejected the Berzelian tenet as to the unalterability of radicals, and admitted that they exercised a considerable influence upon the compounds with which they were copulated. By his own investigations and those of Sir Edward Frankland it was proved that the radical methyl existed in acetic acid; and by the electrolysis of sodium acetate, Kolbe concluded that he had isolated this radical; in this, however, he was wrong, for he really obtained ethane, C_2H_6 , and not methyl, CH_3 . From similar investigations of valerianic acid he was led to conclude that fatty acids were oxygen compounds of the radicals hydrogen, methyl, ethyl, &c., combined with the double carbon equivalent C_2 . Thus the radical of acetic acid, acetyl,¹ was $C_2H_3 \cdot C_2$. (It will be noticed that Kolbe used the atomic weights H=1, C=6, O=8, S=16, &c.; his formulae, however, were molecular formulae, *i.e.* the molecular weights were the same as in use to-day.) This connecting link, C_2 , was regarded as essential, while the methyl, ethyl, &c. was but a sort of appendage; but Kolbe could not clearly conceive the manner of copulation.

The brilliant researches of Frankland on the organo-metallic compounds, and his consequent doctrine of saturation capacity or valency of elements and radicals, relieved Kolbe's views of all obscurity. The doctrine of copulae was discarded, and in 1859 emphasis was given to the view that all organic compounds were derivatives of inorganic by simple substitution processes. He was thus enabled to predict compounds then unknown, *e.g.* the secondary and tertiary alcohols; and with inestimable perspicacity he proved intimate relations between compounds previously held to be quite distinct. Lactic acid and alanine were shown to be oxy- and amino-propionic acids respectively; glycollic acid and glycol, oxy- and amino-acetic acids; salicylic and benzoic acids, oxy- and amino-benzoic acids.

Another consequence of the doctrine of valency was that it permitted the graphic representation of the molecule. The "structure theory" (or the mode of linking of the atoms) of carbon compounds, founded by Butlerow, Kekulé and Couper and, at a later date, marvellously enhanced by the doctrine of stereo-isomerism, due to J. H. van't Hoff and Le Bel, occupies such a position in organic chemistry that its value can never be transcended. By its aid the molecule is represented as a collection of atoms connected together by valencies in such a manner that the part played by each atom is represented; isomerism, or the existence of two or more chemically different substances having identical molecular weights, is adequately shown; and, most important of all, once the structure is determined, the synthesis of the compound is but a matter of time.

In this summary the leading factors which have contributed to a correct appreciation of organic compounds have so far been considered historically, but instead of continuing this method it has been thought advisable to present an epitome of present-day conclusions, not chronologically, but as exhibiting the principles and subject-matter of our science.

Classification of Organic Compounds.

An apt definition of organic chemistry is that it is "the study of the hydrocarbons and their derivatives." This description, although not absolutely comprehensive, serves as a convenient starting-point for a preliminary classification, since a great number of substances, including the most important, are directly referable to hydrocarbons, being formed by replacing one or more hydrogen atoms by other atoms or groups. Two distinct types of hydrocarbons exist: (1) those consisting of an open chain of carbon atoms—named the "aliphatic series" (*ἀλειφαρ*, oil or fat), and (2) those consisting of a closed chain—the "carbocyclic series." The second series can be further divided

¹ This must not be confused with the modern *acetyl*, $CH_3 \cdot CO$, which at that time was known as *acetoxyl*.

into two groups: (1) those exhibiting properties closely analogous to the aliphatic series—the polymethylenes (*q.v.*), and (2) a series exhibiting properties differing in many respects from the aliphatic and polymethylene compounds, and characterized by a peculiar stability which is to be associated with the disposition of certain carbon valencies not saturated by hydrogen—the “aromatic series.” There also exists an extensive class of compounds termed the “heterocyclic series”—these compounds are derived from ring systems containing atoms other than carbon; this class is more generally allied to the aromatic series than to the aliphatic.

We now proceed to discuss the types of aliphatic compounds; then, the characteristic groupings having been established, an epitome of their derivatives will be given. Carbocyclic rings will next be treated, benzene and its allies in some detail; and finally the heterocyclic nuclei.

Accepting the doctrine of the tetravalency of carbon (its divalency in such compounds as carbon monoxide, various isocyanides, fulminic acid, &c., and its possible trivalency in M. Gomberg's triphenyl-methyl play no part in what follows), it is readily seen that the simplest hydrocarbon has the formula CH_4 , named methane, in which the hydrogen atoms are of equal value, and which may be pictured as placed at the vertices of a tetrahedron, the carbon atom occupying the centre. This tetrahedral configuration is based on the existence of only one methylene dichloride, two being necessary if the carbon valencies were directed from the centre of a plane square to its corners, and on the existence of two optical isomers of the formula C.A.B.D.E. , C being a carbon atom and A.B.D.E. being different monovalent atoms or radicals (see STEREO-ISOMERISM). The equivalence of the four hydrogen atoms of methane rested on indirect evidence, *e.g.* the existence of only one acetic acid, methyl chloride, and other monosubstitution derivatives—until the experimental proof by L. Henry (*Zeit. f. Phys. Chem.*, 1888, 2, p. 553), who prepared the four nitromethanes, CH_3NO_2 , each atom in methane being successively replaced by the nitro-group.

Henry started with methyl iodide, the formula of which we write in the form $\text{C}_1\text{H}_3\text{H}_1\text{H}_1$. This readily gave with silver nitrite a nitromethane in which we may suppose the nitro-group to replace the *a* hydrogen atom, *i.e.* $\text{C}(\text{NO}_2)_1\text{H}_3\text{H}_1\text{H}_1$. The same methyl iodide gave with potassium cyanide, acetonitril, which was hydrolysed to acetic acid; this must be $\text{C}(\text{COOH})_1\text{H}_3\text{H}_1\text{H}_1$. Chlorination of this substance gave a monochloroacetic acid; we will assume the chlorine atom to replace the *b* hydrogen atom. This acid with silver nitrite gave nitroacetic acid, which readily gave the second nitromethane, $\text{CH}_2(\text{NO}_2)_2\text{H}_2\text{H}_1$, identical with the first nitromethane. From the nitroacetic acid obtained above, malonic acid was prepared, and from this a monochloromalonic acid was obtained; we assume the chlorine atom to replace the *c* hydrogen atom. This acid gives with silver nitrite the corresponding nitromalonic acid, which readily yielded the third nitromethane, $\text{CH}_2\text{H}_1(\text{NO}_2)_2\text{H}_1$, also identical with the first. The fourth nitromethane was obtained from the nitromalonic acid previously mentioned by a repetition of the method by which the third was prepared; this was identical with the other three.

Let us now consider hydrocarbons containing 2 atoms of carbon. Three such compounds are possible according to the number of valencies acting directly between the carbon atoms. Thus, if they are connected by one valency, and the remaining valencies saturated by hydrogen, we obtain the compound $\text{H}_3\text{C}\cdot\text{CH}_3$, ethane. This compound may be considered as derived from methane, CH_4 , by replacing a hydrogen atom by the monovalent group CH_3 , known as *methyl*; hence ethane may be named “methylmethane.” If the carbon atoms are connected by two valencies, we obtain a compound $\text{H}_2\text{C}:\text{CH}_2$, ethylene; if by three valencies, $\text{HC}:\text{CH}$, acetylene. These last two compounds are termed *unsaturated*, whereas ethane is *saturated*. It is obvious that we have derived three combinations of carbon with hydrogen, characterized by containing a single, double, and triple linkage; and from each of these, by the substitution of a methyl group for a hydrogen atom, compounds of the same nature result. Thus ethane gives $\text{H}_3\text{C}\cdot\text{CH}_2\cdot\text{CH}_3$, propane; ethylene gives $\text{H}_2\text{C}:\text{CH}\cdot\text{CH}_3$, propylene; and acetylene gives $\text{HC}:\text{C}\cdot\text{CH}_3$, allylene. By continuing the introduction of methyl groups we obtain three series of homologous hydro-

carbons given by the general formulae $\text{C}_n\text{H}_{2n+2}$, C_nH_{2n} , and $\text{C}_n\text{H}_{2n-2}$, each member differing from the preceding one of the same series by CH_2 . It will be noticed that compounds containing two double linkages will have the same general formula as the acetylene series; such compounds are known as the “diolefines.” Hydrocarbons containing any number of double or triple linkages, as well as both double and triple linkages, are possible, and a considerable number of such compounds have been prepared.

A more complete idea of the notion of a compound radical follows from a consideration of the compound propane. We derived this substance from ethane by introducing a methyl group; hence it may be termed “methylmethane.” Equally well we may derive it from methane by replacing a hydrogen atom by the monovalent group $\text{CH}_2\cdot\text{CH}_3$, named ethyl; hence propane may be considered as “ethylmethane.” Further, since methane may be regarded as formed by the conjunction of a methyl group with a hydrogen atom, it may be named “methyl hydride”; similarly ethane is “ethyl hydride,” propane, “propyl hydride,” and so on. The importance of such groups as methyl, ethyl, &c. in attempting a nomenclature of organic compounds cannot be overestimated; these compound radicals, frequently termed *alkyl radicals*, serve a similar purpose to the organic chemist as the elements to the inorganic chemist.

In methane and ethane the hydrogen atoms are of equal value, and no matter which one may be substituted by another element or group the same compound will result. In propane, on the other hand, the hydrogen atoms attached to the terminal carbon atoms differ from those joined to the medial atom; we may therefore expect to obtain different compounds according to the position of the hydrogen atom substituted. By introducing a methyl group we may obtain $\text{CH}_3\cdot\text{CH}_2\cdot\text{CH}_2\cdot\text{CH}_3$, known as “normal” or *n-butane*, substitution occurring at a terminal atom, or $\text{CH}_3\cdot\text{CH}(\text{CH}_3)\cdot\text{CH}_3$, isobutane, substitution occurring at the medial atom. From *n-butane* we may derive, by a similar substitution of methyl groups, the two hydrocarbons: (1) $\text{CH}_3\cdot\text{CH}_2\cdot\text{CH}_2\cdot\text{CH}_2\cdot\text{CH}_3$, and (2) $\text{CH}_3\cdot\text{CH}(\text{CH}_3)\cdot\text{CH}_2\cdot\text{CH}_3$; from isobutane we may also derive two compounds, one identical with (2), and a new one (3) $\text{CH}_3(\text{CH}_3)\text{C}(\text{CH}_3)\text{CH}_3$. These three hydrocarbons are *isomeric*, *i.e.* they possess the same formula, but differ in constitution. We notice that they may be differentiated as follows: (1) is built up solely of methyl and $\cdot\text{CH}_2\cdot$ (methylene) groups and the molecule consists of a single chain; such hydrocarbons are referred to as being *normal*; (2) has a branch and contains the group; CH (methine) in which the free valencies are attached to carbon atoms; such hydrocarbons are termed *secondary* or *iso-*; (3) is characterized by a carbon atom linked directly to four other carbon atoms; such hydrocarbons are known as *tertiary*.

Deferring the detailed discussion of cyclic or ringed hydrocarbons, a correlation of the various types or classes of compounds which may be derived from hydrocarbon nuclei will now be given. It will be seen that each type depends upon a specific radical or atom, and the copulation of this character with any hydrocarbon radical (open or cyclic) gives origin to a compound of the same class.

It is convenient first to consider the effect of introducing one, two, or three hydroxyl (OH) groups into the $-\text{CH}_3$, $>\text{CH}_2$, and $\geq\text{CH}$ groups, which we have seen to characterize the different types of hydrocarbons. It may be noticed here that cyclic nuclei can only contain the groups $>\text{CH}_2$ and $\geq\text{CH}$, the first characterizing the polymethylene and reduced heterocyclic compounds, the second true aromatic compounds.

Substituting one hydroxyl group into each of these residues, we obtain radicals of the type $-\text{CH}_2\cdot\text{OH}$, $>\text{CH}\cdot\text{OH}$, and $\geq\text{C}\cdot\text{OH}$; these compounds are known as *alcohols* (*q.v.*), and are termed primary, secondary, and tertiary respectively. Polymethylenes can give only secondary and tertiary alcohols, benzene only tertiary; these latter compounds are known as *phenols*. A second hydroxyl group may be introduced into the residues $-\text{CH}_2\cdot\text{OH}$ and $>\text{CH}\cdot\text{OH}$, with the production of radicals of the form $-\text{CH}(\text{OH})_2$ and $>\text{C}(\text{OH})_2$. Compounds containing these groupings are, however, rarely observed (see CHLORAL), and it is generally found that when compounds of these types are expected, the elements of water are split off, and the typical groupings are reduced to $-\text{CH}:\text{O}$ and $>\text{C}:\text{O}$. Compounds containing the group $-\text{CH}:\text{O}$ are known as *aldehydes* (*q.v.*), while the group $>\text{C}:\text{O}$ (sometimes termed the carbonyl or keto group) characterizes the *ketones* (*q.v.*). A third hydroxyl group may be

introduced into the $-\text{CH}:\text{O}$ residue with the formation of the radical $-\text{C}(\text{OH})\text{:O}$; this is known as the carboxyl group, and characterizes the organic acids.

Sulphur analogues of these oxygen compounds are known. Thus the thio-alcohols or *mercaptans* (*q.v.*) contain the group $-\text{CH}_2\text{SH}$; and the elimination of the elements of sulphuretted hydrogen between two molecules of a thio-alcohol results in the formation of a thio-ether or sulphide, R_2S . Oxidation of thio-ethers results in the formation of sulphoxides, $\text{R}_2\text{S}:\text{O}$, and sulphones, R_2SO_2 ; oxidation of mercaptans yields sulphonic acids, $\text{R}\cdot\text{SO}_3\text{H}$, and of sodium mercaptides sulphinic acids, $\text{R}\cdot\text{SO}(\text{OH})$. We may also notice that thio-ethers combine with alkyl iodides to form sulphine or sulphonium compounds, $\text{R}_3:\text{SI}$. Thio-aldehydes, thio-ketones and thio-acids also exist.

We proceed to consider various simple derivatives of the alcohols, which we may here regard as hydroxy hydrocarbons, $\text{R}\cdot\text{OH}$, where R is an alkyl radical, either aliphatic or cyclic in nature.

Of these, undoubtedly the simplest are the *ethers* (*q.v.*), formed by the elimination of the elements of water between two molecules of the same alcohol, "simple ethers," or of different alcohols, "mixed ethers." These compounds may be regarded as oxides in just the same way as the alcohols are regarded as hydroxides. In fact, the analogy between the alkyl groups and metallic elements forms a convenient basis from which to consider many derivatives. Thus from ethyl alcohol there can be prepared compounds, termed *esters* (*q.v.*), or ethereal salts, exactly comparable in structure with corresponding salts of, say, potassium; by the action of the phosphorus haloids, the hydroxyl group is replaced by a halogen atom with the formation of derivatives of the type $\text{R}\cdot\text{Cl}(\text{Br}, \text{I})$; nitric acid forms nitrates, $\text{R}\cdot\text{O}\cdot\text{NO}_2$; nitrous acid, nitrites, $\text{R}\cdot\text{O}\cdot\text{NO}$; sulphuric acid gives normal sulphates R_2SO_4 , or acid sulphates, $\text{R}\cdot\text{SO}_4\text{H}$. Organic acids also condense with alcohols to form similar compounds: the fats, waxes, and essential oils are naturally occurring substances of this class.

An important class of compounds, termed *amines* (*q.v.*), results from the condensation of alcohols with ammonia, water being eliminated between the alcoholic hydroxyl group and a hydrogen atom of the ammonia. Three types of amines are possible and have been prepared: primary, $\text{R}\cdot\text{NH}_2$; secondary, $\text{R}:\text{NH}$; and tertiary, $\text{R}_3:\text{N}$; the oxamines, $\text{R}_3\text{N}:\text{O}$, are closely related to the tertiary ammonias, which also unite with a molecule of alkyl iodide to form salts of quaternary ammonium bases, e.g. $\text{R}_4\text{N}\cdot\text{I}$. It is worthy of note that phosphorus and arsenic bases analogous to the amines are known (see PHOSPHORUS and ARSENIC). From the primary amines are derived the diazo compounds (*q.v.*) and azo compounds (*q.v.*); closely related are the hydrazines (*q.v.*). Secondary amines yield nitrosamines, $\text{R}_2\text{N}\cdot\text{NO}$, with nitrous acid. By the action of hydroxylamine or phenylhydrazine on aldehydes or ketones, condensation occurs between the carbonyl oxygen of the aldehyde or ketone and the amino group of the hydroxylamine or hydrazine. Thus with hydroxylamine aldehydes yield aldoximes, $\text{R}\cdot\text{CH}:\text{N}\cdot\text{OH}$, and ketones, ketoximes, $\text{R}_2\text{C}:\text{N}\cdot\text{OH}$ (see OXIMES), while phenyl hydrazine gives phenylhydrazones, $\text{R}_2\text{C}:\text{N}\cdot\text{NH}\cdot\text{C}_6\text{H}_5$ (see HYDRAZONES). Oxaldehydes and oxoketones (viz. compounds containing an oxy in addition to an aldehydic or ketonic group) undergo both condensation and oxidation when treated with phenylhydrazine, forming compounds known as osozones; these are of great importance in characterizing the sugars (*q.v.*).

The carboxyl group constitutes another convenient starting-point for the orientation of many types of organic compounds. This group may be considered as resulting from the fusion of a carbonyl ($:\text{CO}$) and a hydroxyl ($\text{HO}\cdot$) group, and we may expect to meet with compounds bearing structural resemblances to the derivatives of alcohols and aldehydes (or ketones).

Considering derivatives primarily concerned with transformations of the hydroxyl group, we may regard our typical acid as a fusion of a radical $\text{R}\cdot\text{CO}-$ (named acetyl, propionyl, butyl, &c., generally according to the name of the hydrocarbon containing the same number of carbon atoms) and a hydroxyl group. By replacing the hydroxyl group by a halogen, acid-haloids result; by the elimination of the elements of water between two molecules, acid-anhydrides, which may be oxidized to acid-peroxides; by replacing the hydroxyl group by the group $\cdot\text{SH}$, thio-acids; by replacing it by the amino group, acid-amides (*q.v.*); by replacing it by the group $-\text{NH}\cdot\text{NH}_2$, acid-hydrazides. The structural relations of these compounds are here shown:

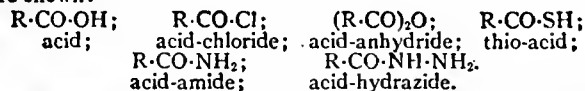

It is necessary clearly to distinguish such compounds as the amino- (or amido-) acids and acid-amides; in the first case the amino group is substituted in the hydrocarbon residue, in the second it is substituted in the carboxyl group.

By transformations of the carbonyl group, and at the same time of the hydroxyl group, many interesting types of nitrogen compounds may be correlated.

Thus from the acid-amides, which we have seen to be closely related to the acids themselves, we obtain, by replacing the carbonyl oxygen by chlorine, the acid-amido-chlorides, $\text{R}\cdot\text{CCl}_2\cdot\text{NH}_2$, from which are derived the imido-chlorides, $\text{R}\cdot\text{CCl}:\text{NH}$, by loss of one molecule of hydrochloric acid. By replacing the chlorine in the imido-chloride by an oxyalkyl group we obtain the imido-ethers, $\text{R}\cdot\text{C}(\text{OR}'):\text{NH}$; and by an amino group, the amidines, $\text{R}\cdot\text{C}(\text{NH}_2):\text{NH}$. The carbonyl oxygen may also be replaced by the oxime group, $:\text{N}\cdot\text{OH}$; thus the acids yield the hydroxamic acids, $\text{R}\cdot\text{C}(\text{OH})\cdot\text{NOH}$, and the acid-amides the amidoximes, $\text{R}\cdot\text{C}(\text{NH}_2):\text{NOH}$. Closely related to the amidoximes are the nitrolic acids, $\text{R}\cdot\text{C}(\text{NO}_2):\text{NOH}$.

Cyclic Hydrocarbons and Nuclei.

Having passed in rapid review the various types of compounds derived by substituting for hydrogen various atoms or groups of atoms in hydrocarbons (the separate articles on specific compounds should be consulted for more detailed accounts), we now proceed to consider the closed chain compounds. Here we meet with a great diversity of types: oxygen, nitrogen, sulphur and other elements may, in addition to carbon, combine together in a great number of arrangements to form cyclic nuclei, which exhibit characters closely resembling open-chain compounds in so far as they yield substitution derivatives, and behave as compound radicals. In classifying closed chain compounds, the first step consists in dividing them into: (1) *carbocyclic*, in which the ring is composed solely of carbon atoms—these are also known as *homocyclic* or *isocyclic* on account of the identity of the members of the ring—and (2) *heterocyclic*, in which different elements go to make up the ring. Two primary divisions of carbocyclic compounds may be conveniently made: (1) those in which the carbon atoms are completely saturated—these are known by the generic term *polymethylenes*, their general formula being $(\text{CH}_2)_n$; it will be noticed that they are isomeric with ethylene and its homologues; they differ, however, from this series in not containing a double linkage, but have a ringed structure; and (2) those containing fewer hydrogen atoms than suffice to saturate the carbon valencies—these are known as the *aromatic compounds* proper, or as *benzene compounds*, from the predominant part which benzene plays in their constitution.

It was long supposed that the simplest ring obtainable contained six atoms of carbon, and the discovery of trimethylene in 1882 by August Freund by the action of sodium on trimethylene bromide, $\text{Br}(\text{CH}_2)_3\text{Br}$, came somewhat as a surprise, especially in view of its behaviour with bromine and hydrogen bromide. In comparison with the isomeric propylene, $\text{CH}_3\text{HC}=\text{CH}_2$, it is remarkably inert, being only very slowly attacked by bromine, which readily combines with propylene. But on the other hand, it is readily converted by hydrobromic acid into normal propyl bromide, $\text{CH}_3\text{CH}_2\text{CH}_2\text{Br}$. The separation of carbon atoms united by single affinities in this manner at the time the observation was made was altogether without precedent. A similar behaviour has since been noticed in other trimethylene derivatives, but the fact that bromine, which usually acts so much more readily than hydrobromic acid on unsaturated compounds, should be so inert when hydrobromic acid acts readily is one still needing a satisfactory explanation. A great impetus was given to the study of polymethylene derivatives by the important and unexpected observation made by W. H. Perkin, junr., in 1883, that ethylene and trimethylene bromides are capable of acting in such a way on sodium acetoacetic ester as to form tri- and tetramethylene rings. Perkin has himself contributed largely to our knowledge of such compounds; penta- and hexa-methylene derivatives have also received considerable attention (see POLYMETHYLENES).

A. von Baeyer has sought to explain the variations in stability manifest in the various polymethylene rings by a purely mechanical hypothesis, the "strain" or *Spannungs* theory (*Ber.*, 1885, p. 2277). Assuming the four valencies of the carbon atom to be directed from the centre of a regular tetrahedron towards its four corners, the angle at which they meet is $109^\circ 28'$. Baeyer supposes that in the formation of carbon

"rings" the valencies become deflected from their positions, and that the tension thus introduced may be deduced from a comparison of this angle with the angles at which the strained valencies would meet. He regards the amount of deflection as a measure of the stability of the "ring." The readiness with which ethylene is acted on in comparison with other types of hydrocarbon, for example, is in harmony, he considers, with the circumstance that the greatest distortion must be involved in its formation, as if deflected into parallelism each valency will be drawn out of its position through $\frac{1}{2}(109^\circ 28')$. The values in other cases are calculable from the formula $\frac{1}{2}(109^\circ 28' - a)$, where a is the internal angle of the regular polygon contained by sides equal in number to the number of the carbon atoms composing the ring. These values are:—

Trimethylene.	Tetramethylene.
$\frac{1}{2}(109^\circ 28' - 60^\circ) = 24^\circ 44'$.	$\frac{1}{2}(109^\circ 28' - 90^\circ) = 9^\circ 44'$.
Pentamethylene.	Hexamethylene.
$\frac{1}{2}(109^\circ 28' - 108^\circ) = 0^\circ 44'$.	$\frac{1}{2}(109^\circ 28' - 120^\circ) = -5^\circ 16'$.

The general behaviour of the several types of hydrocarbons is certainly in accordance with this conception, and it is a remarkable fact that when benzene is reduced with hydriodic acid, it is converted into a mixture of hexamethylene and methylpentamethylene (cf. W. Markownikov, *Ann.*, 1898, 302, p. 1); and many other cases of the conversion of six-carbon rings into five-carbon rings have been recorded (see below, *Decompositions of the Benzene Ring*). Similar considerations will apply to rings containing other elements besides carbon. As an illustration it may be pointed out that in the case of the two known types of lactones—the γ -lactones, which contain four carbon atoms and one oxygen atom in the ring, are more readily formed and more stable (less readily hydrolysed) than the δ -lactones, which contain one oxygen and five carbon atoms in the ring. That the number of atoms which can be associated in a ring by single affinities is limited there can be no doubt, but there is not yet sufficient evidence to show where the limit must be placed. Baeyer has suggested that his hypothesis may also be applied to explain the instability of acetylene and its derivatives, and the still greater instability of the polyacetylene compounds.

Benzene.

The ringed structure of benzene, C_6H_6 , was first suggested in 1865 by August Kekulé, who represented the molecule by six CH groups placed at the six angles of a regular hexagon, the sides of which denoted the valencies saturated by adjacent carbon atoms, the fourth valencies of each carbon atom being represented as saturated along alternate sides. This formula, notwithstanding many attempts at both disproving and modifying it, has well stood the test of time; the subject has been the basis of constant discussion, many variations have been proposed, but the original conception of Kekulé remains quite as convenient as any of the newer forms, especially when considering the syntheses and decompositions of the benzene complex. It will be seen, however, that the absolute disposition of the fourth valency may be ignored in a great many cases, and consequently the complex may be adequately represented as a hexagon. This symbol is in general use; it is assumed that at each corner there is a CH group which, however, is not always written in; if a hydrogen atom be substituted by another group, then this group is attached to the corner previously occupied by the displaced hydrogen. The following diagrams illustrate these statements:—

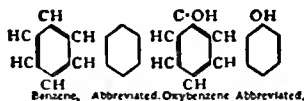

From the benzene nucleus we can derive other aromatic nuclei, graphically represented by fusing two or more hexagons along common sides. By fusing two nuclei we obtain the formula of naphthalene, $C_{10}H_8$; by fusing three, the hydrocarbons anthracene and phenanthrene, $C_{14}H_{10}$; by fusing four, chrysene, $C_{18}H_{12}$, and possibly pyrene, $C_{16}H_{10}$; by fusing five, picene, $C_{22}H_{14}$. But it must be here understood that each member of these condensed nuclei need not necessarily be identical in structure; thus the central nuclei in anthracene and phenanthrene differ very considerably from the terminal nuclei (see below, *Condensed Nuclei*). Other

hydrocarbon nuclei generally classed as aromatic in character result from the union of two or more benzene nuclei joined by one or two valencies with polymethylene or oxidized polymethylene rings; instances of such nuclei are indene, hydrindene, fluorene, and fluoranthene. From these nuclei an immense number of derivatives may be obtained, for the hydrogen atoms may be substituted by any of the radicals discussed in the preceding section on the classification of organic compounds.

We now proceed to consider the properties, syntheses, decompositions and constitution of the benzene complex. It has already been stated that benzene derivatives may be regarded as formed by the replacement of hydrogen atoms by other elements or radicals in exactly the same manner as in the aliphatic series. Important differences, however, are immediately met with when we consider the methods by which derivatives are obtained. For example: nitric acid and sulphuric acid readily react with benzene and its homologues with the production of nitro derivatives and sulphonic acids, while in the aliphatic series these acids exert no substituting action (in the case of the olefines, the latter acid forms an addition product); another distinction is that the benzene complex is more stable towards oxidizing agents. This and other facts connected with the stability of benzenoid compounds are clearly shown when we consider mixed aliphatic-aromatic hydrocarbons, *i.e.* compounds derived by substituting aliphatic radicals in the benzene nucleus; such a compound is methylbenzene or toluene, $C_6H_5 \cdot CH_3$. This compound is readily oxidized to benzoic acid, $C_6H_5 \cdot COOH$, the aromatic residue being unattacked; nitric and sulphuric acids produce nitro-toluenes, $C_6H_4 \cdot CH_3 \cdot NO_2$, and toluene sulphonic acids, $C_6H_4 \cdot CH_3 \cdot SO_3H$; chlorination may result in the formation of derivatives substituted either in the aromatic nucleus or in the side chain; the former substitution occurs most readily, chlor-toluenes, $C_6H_4 \cdot CH_3 \cdot Cl$, being formed, while the latter, which needs an elevation in temperature or other auxiliary, yields benzyl chloride, $C_6H_5 \cdot CH_2Cl$, and benzal chloride, $C_6H_5 \cdot CHCl_2$. In general, the aliphatic residues in such mixed compounds retain the characters of their class, while the aromatic residues retain the properties of benzene.

Further differences become apparent when various typical compounds are compared. The introduction of hydroxyl groups into the benzene nucleus gives rise to compounds generically named *phenols*, which, although resembling the aliphatic alcohols in their origin, differ from these substances in their increased chemical activity and acid nature. The phenols more closely resemble the tertiary alcohols, since the hydroxyl group is linked to a carbon atom which is united to other carbon atoms by its remaining three valencies; hence on oxidation they cannot yield the corresponding aldehydes, ketones or acids (see below, *Decompositions of the Benzene Ring*). The amines also exhibit striking differences: in the aliphatic series these compounds may be directly formed from the alkyl haloids and ammonia, but in the benzene series this reaction is quite impossible unless the haloid atom be weakened by the presence of other substituents, *e.g.* nitro groups. Moreover, while methylamine, dimethylamine, and trimethylamine increase in basicity corresponding to the introduction of successive methyl groups, phenylamine or aniline, diphenylamine, and triphenylamine are in decreasing order of basicity, the salts of diphenylamine being decomposed by water. Mixed aromatic-aliphatic amines, both secondary and tertiary, are also more strongly basic than the pure aromatic amines, and less basic than the true aliphatic compounds; *e.g.* aniline, $C_6H_5 \cdot NH_2$, monomethyl aniline, $C_6H_5 \cdot NH \cdot CH_3$, and dimethyl aniline, $C_6H_5 \cdot N(CH_3)_2$, are in increasing order of basicity. These observations may be summarized by saying that the benzene nucleus is more negative in character than the aliphatic residues.

Isomerism of Benzene Derivatives.—Although Kekulé founded his famous benzene formula in 1865 on the assumptions that the six hydrogen atoms in benzene are equivalent and that the molecule is symmetrical, *i.e.* that two pairs of hydrogen atoms are symmetrically situated with reference to any specified hydrogen atom, the absolute demonstration of the validity of

Distinctions between aliphatic and aromatic compounds.

these assumptions was first given by A. Ladenburg in 1874 (see *Ber.*, 1874, 7, p. 1684; 1875, 8, p. 1666; *Theorie der aromatischen Verbindungen*, 1876). These results may be graphically represented as follows: numbering the hydrogen atoms in cyclical order from 1 to 6, then the first thesis demands that whichever atom is substituted the same compound results, while the second thesis points out that the pairs 2 and 6, and 3 and 5 are symmetrical with respect to 1, or in other words, the di-substitution derivatives 1.2 and 1.6, and also 1.3 and 1.5 are identical. Therefore three di-derivatives are possible, viz. 1.2 or 1.6, named *ortho-* (*o*), 1.3 or 1.5, named *meta-* (*m*), and 1.4, named *para-* compounds (*p*). In the same way it may be shown that three tri-substitution, three tetra-substitution, one penta-substitution, and one hexa-substitution derivative are possible. Of the tri-substitution derivatives, 1.2.3.-compounds are known as "adjacent" or "vicinal" (*v*), the 1.2.4 as "asymmetrical" (*as*), the 1.3.5 as "symmetrical" (*s*); of the tetra-substitution derivatives, 1.2.3.4.-compounds are known as "adjacent," 1.2.3.5 as "asymmetrical," and 1.2.4.5 as "symmetrical."

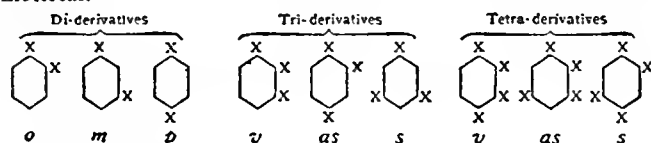

Here we have assumed the substituent groups to be alike; when they are unlike, a greater number of isomers is possible. Thus in the tri-substitution derivatives six isomers, and no more, are possible when two of the substituents are alike; for instance, six diaminobenzoic acids, $C_6H_3(NH_2)_2COOH$, are known; when all are unlike ten isomers are possible; thus, ten oxytoluic acids, $C_6H_3-CH_3-OH-COOH$, are known. In the case of tetra-substituted compounds, thirty isomers are possible when all the groups are different.

The preceding considerations render it comparatively easy to follow the reasoning on which the experimental verification of the above statements is based. The proof is divided into two parts: (1) that four hydrogen atoms are equal, and (2) that two pairs of hydrogen atoms are symmetrical with reference to a specified hydrogen atom. In the first thesis, phenol or oxybenzene, C_6H_5-OH , in which we will assume the hydroxyl group to occupy position 1, is converted into brombenzene, which is then converted into benzoic acid, C_6H_5-COOH . From this substance, an oxybenzoic acid (*meta-*), $C_6H_4-OH-COOH$, may be prepared; and the two other known oxybenzoic acids (*ortho-* and *para-*) may be converted into benzoic acid. These three acids yield on heating phenol, identical with the substance started with, and since in the three oxybenzoic acids the hydroxyl groups must occupy positions other than 1, it follows that *four* hydrogen atoms are equal in value.

R. Hübner and A. Petermann (*Ann.*, 1869, 149, p. 129) provided the proof of the equivalence of the atoms 2 and 6 with respect to 1. From *meta*-brombenzoic acid two nitrobrombenzoic acids are obtained on direct nitration; elimination of the bromine atom and the reduction of the nitro to an amino group in these two acids results in the formation of the same *ortho*-aminobenzoic acid. Hence the positions occupied by the nitro groups in the two different nitrobrombenzoic acids must be symmetrical with respect to the carboxyl group. In 1879, Hübner (*Ann.*, 195, p. 4) proved the equivalence of the second pair, viz. 3 and 5, by starting out with *ortho*-aminobenzoic acid, previously obtained by two different methods. This substance readily yields *ortho*-oxybenzoic acid or salicylic acid, which on nitration yields two mononitro-oxybenzoic acids. By eliminating the hydroxy groups in these acids the same nitrobenzoic acid is obtained, which yields on reduction an aminobenzoic acid different from the starting-out acid. Therefore there must be another pair of hydrogen atoms, other than 2 and 6, which are symmetrical with respect to 1. The symmetry of the second pair was also established in 1878 by E. Wroblewsky (*Ann.*, 192, p. 196).

Orientation of Substituent Groups.—The determination of the relative positions of the substituents in a benzene derivative constitutes an important factor in the general investigation of such compounds. Confining our attention, for the present, to di-substitution products we see that there are three distinct series of compounds to be considered. Generally if any group be replaced by another group, then the second group enters the nucleus in the position occupied by the displaced group; this

means that if we can definitely orientate three di-derivatives of benzene, then any other compound, which can be obtained from or converted into one of our typical derivatives, may be definitely orientated. Intermolecular transformations—migrations of substituent groups from one carbon atom to another—are of fairly common occurrence among oxy compounds at elevated temperatures. Thus potassium *ortho*-oxybenzoate is converted into the salt of *para*-oxybenzoic acid at 220°; the three bromphenols, and also the brombenzenesulphonic acids, yield *m*-dioxybenzene or resorcin when fused with potash. It is necessary, therefore, to avoid reactions involving such intermolecular migrations when determining the orientation of aromatic compounds.

Such a series of typical compounds are the benzene dicarboxylic acids (phthalic acids), $C_6H_4(COOH)_2$. C. Graebe (*Ann.*, 1869, 149, p. 22) orientated the *ortho*-compound or phthalic acid from its formation from naphthalene on oxidation; the *meta*-compound or isophthalic acid is orientated by its production from mesitylene, shown by A. Ladenburg (*Ann.*, 1875, 179, p. 163) to be symmetrical trimethyl benzene; terephthalic acid, the remaining isomer, must therefore be the *para*-compound.

P. Griess (*Ber.*, 1872, 5, p. 192; 1874, 7, p. 1223) orientated the three diaminobenzenes or phenylene diamines by considering their preparation by the elimination of the carboxyl group in the six diaminobenzoic acids. The diaminobenzene resulting from two of these acids is the *ortho*-compound; from three, the *meta*-; and from one the *para*-; this is explained by the following scheme:—

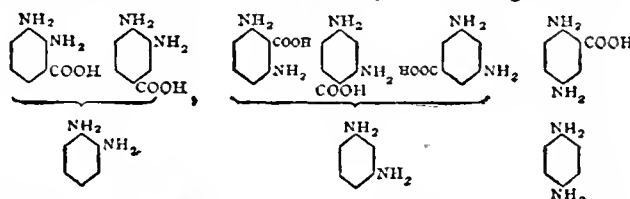

W. Körner (*Gazz. Chem. Ital.*, 4, p. 305) in 1874 orientated the three dibrombenzenes in a somewhat similar manner. Starting with the three isomeric compounds, he found that one gave two tribrombenzenes, another gave three, while the third gave only one. A scheme such as the preceding one shows that the first dibrombenzene must be the *ortho*-compound, the second the *meta*-, and the third the *para*-derivative. Further research in this direction was made by D. E. Noetling (*Ber.*, 1885, 18, p. 2657), who investigated the nitro-, amino-, and oxy-xylenes in their relations to the three xylenes or dimethyl benzenes.

The orientation of higher substitution derivatives is determined by considering the di- and tri-substitution compounds into which they can be transformed.

Substitution of the Benzene Ring.—As a general rule, homologues and mono-derivatives of benzene react more readily with substituting agents than the parent hydrocarbon, for example, phenol is converted into tribromphenol by the action of bromine water, and into the nitrophenols by dilute nitric acid; similar activity characterizes aniline. Not only does the substituent group modify the readiness with which the derivative is attacked, but also the nature of the product. Starting with a mono-derivative, we have seen that a substituent group may enter in either of three positions to form an *ortho*-, *meta*-, or *para*-compound. Experience has shown that such mono-derivatives as nitro compounds, sulphonic acids, carboxylic acids, aldehydes, and ketones yield as a general rule chiefly the *meta*-compounds, and this is independent of the nature of the second group introduced; on the other hand, benzene haloids, amino-, homologous-, and hydroxy-benzenes yield principally a mixture of the *ortho*- and *para*-compounds. These facts are embodied in the "Rule of Crum Brown and J. Gibson" (*Jour. Chem. Soc.* 61, p. 367): If the hydrogen compound of the substituent already in the benzene nucleus can be directly oxidized to the corresponding hydroxyl compound, then *meta*-derivatives predominate on further substitution, if not, then *ortho*- and *para*-derivatives. By further substitution of *ortho*- and *para*-derivatives, in general the same tri-derivative [1.2.4] is formed (*Ann.*, 1878, 192, p. 219); *meta*-compounds yield [1.3.4] and [1.2.3] tri-derivatives, except in such cases as when both substituent groups are strongly acid, e.g. *m*-dinitrobenzene, then [1.3.5]-derivatives are obtained.

Syntheses of the Benzene Ring.—The characteristic distinctions

which exist between aliphatic and benzenoid compounds make the transformations of one class into the other especially interesting.

In the first place we may notice a tendency of several aliphatic compounds, e.g. methane, tetrachloromethane, &c., to yield aromatic compounds when subjected to a high temperature, the so-called pyrogenetic reactions (from Greek *πύρ*, fire, and *γεννάω*, I produce); the predominance of benzenoid, and related compounds—naphthalene, anthracene, phenanthrene, &c.—in coal-tar is probably to be associated with similar pyrocondensations. Long-continued treatment with halogens may, in some cases, result in the formation of aromatic compounds, thus perchlorobenzene, C_6Cl_6 , frequently appears as a product of exhaustive chlorination, while hexyl iodide, $C_6H_{13}I$, yields perchlor- and perbrom-benzene quite readily.

The trimolecular polymerization of numerous acetylene compounds—substances containing two trebly linked carbon atoms, $-C-C-$, to form derivatives of benzene is of considerable interest. M. P. E. Berthelot first accomplished the synthesis of benzene in 1870 by leading acetylene, $HC \equiv CH$, through tubes heated to dull redness; at higher temperatures the action becomes reversible, the benzene yielding diphenyl, diphenylbenzene, and acetylene. The condensation of acetylene to benzene is also possible at ordinary temperatures by leading the gas over pyrophoric iron, nickel, cobalt, or spongy platinum (P. Sabatier and J. B. Senderens). The homologues of acetylene condense more readily; thus allylene, $CH_2=C=CH_2$, and crotonylene, $CH_3C \equiv C \cdot CH_3$, yield trimethyl- and hexamethyl-benzene under the influence of sulphuric acid. Toluene or mono-methylbenzene results from the pyrocondensation of a mixture of acetylene and allylene. Substituted acetylenes also exhibit this form of condensation; for instance, bromoacetylene, $BrC \equiv CH$, is readily converted into tribromobenzene, while propiolic acid, $HC \equiv C \cdot COOH$, under the influence of sunlight, gives benzene tricarboxylic acid.

A larger and more important series of condensations may be grouped together as resulting from the elimination of the elements of water between carbonyl (CO) and methylene (CH_2) groups. A historic example is that of the condensation of three molecules of acetone, $CH_3 \cdot CO \cdot CH_3$, in the presence of sulphuric acid, to *s*-trimethylbenzene or mesitylene, $C_6H_3(CH_3)_3$, first observed in 1837 by R. Kane; methylethyl ketone and methyl-*n*-propyl ketone suffer similar condensations to *s*-triethylbenzene and *s*-tri-*n*-propylbenzene respectively. Somewhat similar condensations are: of geraniol or citral, $(CH_3)_2CH \cdot CH_2 \cdot CH \cdot C(CH_3) \cdot CH \cdot CHO$, to *p*-isopropyl-methylbenzene or cymene; of the condensation product of methyl-ethylacrolein and acetone, $CH_3 \cdot CH_2 \cdot CH \cdot C(CH_3) \cdot CH \cdot CH \cdot CO \cdot CH_3$, to [1.3.4]-trimethylbenzene or pseudocumene; and of the condensation product of two molecules of isovaleryl aldehyde with one of acetone, $C_5H_7 \cdot CH_2 \cdot CH \cdot C(CH_3) \cdot CH \cdot CH \cdot CO \cdot CH_3$, to (1)-methyl-2.4-di-isopropyl benzene. An analogous synthesis is that of dihydro-*m*-xylene from methyl heptenone, $(CH_3)_2C \cdot CH \cdot (CH_2)_2 \cdot CO \cdot CH_3$. Certain α -diketones condense to form benzenoid quinones, two molecules of the diketone taking part in the reaction; thus diacetyl, $CH_3 \cdot CO \cdot CO \cdot CH_3$, yields *p*-xyloquinone, $C_6H_2(CH_3)_2O_2$ (*Ber.*, 1888, 21, p. 1411), and acetylpropionyl, $CH_3 \cdot CO \cdot CO \cdot C_2H_5$, yields duroquinone, or tetramethylquinone, $C_8(CH_3)_4O_2$. Oxymethylene compounds, characterized by the grouping $>C:CH(OH)$, also give benzene derivatives by hydrolytic condensation between three molecules; thus oxymethylene acetone, or formyl acetone, $CH_3 \cdot CO \cdot CH:CH(OH)$, formed by acting on formic ester with acetone in the presence of sodium ethylate, readily yields [1.3.5]-triacetylbenzene, $C_6H_3(CO \cdot CH_3)_3$; oxymethylene acetic ester or formyl acetic ester or β -oxyacrylic ester, $(HO)CH:CH \cdot CO_2C_2H_5$, formed by condensing acetic ester with formic ester, and also its dimolecular condensation product, coumalic acid, readily yields esters of [1.3.5]-benzene tricarboxylic acid or trimesic acid (see *Ber.*, 1887, 20, p. 2930).

In 1890, O. Doebner (*Ber.* 23, p. 2377) investigated the condensation of pyroracemic acid, $CH_3 \cdot CO \cdot COOH$, with various aliphatic aldehydes, and obtained from two molecules of the acid and one of the aldehyde in the presence of baryta water allylic isophthalic acids; with acetaldehyde [1.3.5]-methylisophthalic acid or uvitic acid, $C_6H_2 \cdot CH_3 \cdot (COOH)_2$, was obtained, with propionic aldehyde [1.3.5]-ethylisophthalic acid, and with butyric aldehyde the corresponding propylisophthalic acid. We may here mention the synthesis of oxyuvitic ester (5-methyl-4-oxy-1.3-benzene dicarboxylic ester) by the condensation of two molecules of sodium acetoacetic ester with one of chloroform (*Ann.*, 1883, 222, p. 249). Of other syntheses of true benzene derivatives, mention may be made of the formation of orcinol or [3.5]-dioxytoluene from dehydroacetic acid; and the formation of esters of oxytoluic acid (5-methyl-3-oxy-benzoic acid), $C_6H_2 \cdot CH_3 \cdot OH \cdot COOH$, when acetoneoxalic ester, $CH_3 \cdot CO \cdot CH_2 \cdot CO \cdot CO_2C_2H_5$, is boiled with baryta (*Ber.*, 1889, 22, p. 3271). Of interest also are H. B. Hill and J. Torray's observations on nitromalonic aldehyde, $NO_2 \cdot CH(CH_3) \cdot CO_2H$, formed by acting on mucobromic acid, probably $CHO \cdot CBr \cdot COOH$, with alkaline nitrites; this substance condenses with acetone to give *p*-nitrophenol, and forms [1.3.5]-trinitrobenzene when its sodium salt is decomposed with an acid.

By passing carbon monoxide over heated potassium J. von Liebig

discovered, in 1834, an interesting aromatic compound, potassium carbon monoxide or potassium hexa-oxybenzene, the nature of which was satisfactorily cleared up by R. Nietzki and T. Benckiser (*Ber.* 18, p. 499) in 1885, who showed that it yielded hexa-oxybenzene, $C_6(OH)_6$, when acted upon with dilute hydrochloric acid, further investigation of this compound brought to light a considerable number of highly interesting derivatives (see QUINONES). Another hexa-substituted benzene compound capable of direct synthesis is mellitic acid or benzene carboxylic acid, $C_6(COOH)_6$. This substance, first obtained from the mineral honeystone, aluminium mellitate, by M. H. Klaproth in 1799, is obtained when pure carbon (graphite or charcoal) is oxidized by alkaline permanganate, or when carbon forms the positive pole in an electrolytic cell (*Ber.*, 1883, 16, p. 1209). The composition of this substance was determined by A. von Baeyer in 1870, who obtained benzene on distilling the calcium salt with lime.

Hitherto we have generally restricted ourselves to syntheses which result in the production of a true benzene ring but there are many reactions by which reduced benzene rings are synthesized, and from the compounds so obtained true benzenoid compounds may be prepared. Of such syntheses we may notice the condensation of sodium malonic ester to phloroglucin tricarboxylic ester, a substance which gives phloroglucin or trioxybenzene when fused with alkalis, and behaves both as a triketohexamethylene tricarboxylic ester and as a trioxybenzene tricarboxylic ester, the condensation of succinic ester, $(CH_2 \cdot CO_2C_2H_5)_2$, under the influence of sodium to succinosuccinic ester, a diketohexamethylene dicarboxylic ester, which readily yields dioxyterephthalic acid and hydroquinone (F. Herrmann, *Ann.*, 1882, 211, p. 306; also see below, *Configuration of the Benzene Complex*); the condensation of acetone dicarboxylic ester with malonic ester to form triketohexamethylene dicarboxylic ester (E. Rimini, *Gazz. Chem.*, 1896, 26, (2), p. 374), the condensation of acetone-di-propionic acid under the influence of boiling water to a diketohexamethylene propionic acid (von Pechmann and Sidgwick, *Ber.*, 1904, 37, p. 3816). Many diketone compounds suffer condensation between two molecules to form hydrobenzene derivatives; thus α, γ -di-acetoglutaric ester, $C_7H_{12}O_2 \cdot C(CH_3) \cdot CO \cdot CH \cdot CH_2 \cdot CH(CO \cdot CH_3) \cdot CO_2C_2H_5$, yields a methyl-ketohexamethylene, while γ -acetobutyric ester, $CH_3 \cdot CO \cdot (CH_2)_2 \cdot CO_2C_2H_5$, is converted into dihydroresorcinol or *m*-diketohexamethylene by sodium ethylate; this last reaction is reversed by baryta (see *Decompositions of Benzene Ring*). For other syntheses of hexamethylene derivatives, see POLYMETHYLENES.

Decompositions of the Benzene Ring.—We have previously alluded to the relative stability of the benzene complex; consequently reactions which lead to its disruption are all the more interesting, and have engaged the attention of many chemists. If we accept Kekulé's formula for the benzene nucleus, then we may expect the double linkages to be opened up partially, either by oxidation or reduction, with the formation of di-, tetra-, or hexa-hydro derivatives, or entirely, with the production of open chain compounds. Generally rupture occurs at more than one point, and rarely are the six carbon atoms of the complex regained as an open chain. Certain compounds withstand ring decomposition much more strongly than others; for instance, benzene and its homologues, carboxylic acids, and nitro compounds are much more stable towards oxidizing agents than amino- and oxy-benzenes, aminophenols, quinones, and oxy-carboxylic acids.

Strong oxidation breaks the benzene complex into such compounds as carbon dioxide, oxalic acid, formic acid, &c.; such decompositions are of little interest. More important are Kekulé's observations that nitrous acid oxidizes pyrocatechol or [1.2]-dioxylbenzene, and protocatechuic acid or [3.4]-dioxylbenzoic acid to dioxytartaric acid, $(C(OH)_2 \cdot COOH)_2$ (*Ann.*, 1883, 221, p. 230); and O. Doebner's preparation of mesotartaric acid, the internally compensated tartaric acid, $(CH(OH) \cdot COOH)_2$, by oxidizing phenol with dilute potassium permanganate (*Ber.*, 1891, 24, p. 1753).

For many years it had been known that a mixture of potassium chlorate and hydrochloric or sulphuric acids possessed strong oxidizing powers. L. Carius showed that potassium chlorate and sulphuric acid oxidized benzene to trichlorophenomalic acid, a substance afterwards investigated by Kekulé and O. Strecker (*Ann.*, 1884, 223, p. 170), and shown to be β -trichloroacetoacrylic acid, $CCl_2 \cdot CO \cdot CH:CH \cdot COOH$, which with baryta gave chloroform and maleic acid. Potassium chlorate and hydrochloric acid oxidize phenol, salicylic acid (*o*-oxy-benzoic acid), and gallic acid ([2.3.4]-trioxybenzoic acid) to trichloropyroracemic acid (isotrichlorglyceric acid), $CCl_2 \cdot C(OH) \cdot CO_2H$, a substance also obtained from trichloroacetone nitrile, $CCl_2 \cdot CO \cdot CN$, by hydrolysis. We may also notice the conversion of picric acid. [2.4.6]-trinitrophenol) into chloropicrin, $CCl_2 \cdot NO_2$, by bleaching lime (calcium hypochlorite), and into bromopicrin, $CBr_2 \cdot NO_2$, by bromine water.

Simple oxidation.

Chlorination and oxidation.

The action of chlorine upon di- and tri-oxybenzenes has been carefully investigated by Th. Zincke; and his researches have led to the discovery of many chlorinated oxidation products which admit of decomposition into cyclic compounds containing fewer carbon atoms than characterize the benzene ring, and in turn yielding open-chain or aliphatic compounds. In general, the rupture occurs between a keto group (CO) and a keto-chloride group (CCl₂), into which two adjacent carbon atoms of the ring are converted by the oxidizing and substituting action of chlorine. Decompositions of this nature were first discovered in the naphthalene series, where it was found that derivatives of indene (and of hydrindene and indone) and also of benzene resulted; Zincke then extended his methods to the disintegration of the oxybenzenes and obtained analogous results, R-pentene and aliphatic derivatives being formed (R-symbolizing a ringed nucleus).

When treated with chlorine, pyrocatechol (1,2 or ortho-dioxybenzene) (1) yields a tetrachloro ortho-quinone, which suffers further chlorination to hexachlor-o-diketo-R-hexene (2). This substance is transformed into hexachlor-R-pentene oxycarboxylic acid (3) when digested with water; and chromic acid oxidizes this substance to hexachlor-R-pentene (4). The ring of this compound is ruptured by caustic soda with the formation of perchlorovinyl acrylic acid (5), which gives on reduction ethidine propionic acid (6), a compound containing five of the carbon atoms originally in the benzene ring (see Zincke, *Ber.*, 1894, 27, p. 3364) (the carbon atoms are omitted in some of the formulae).

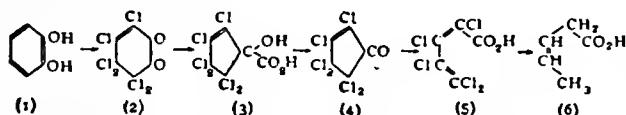

Resorcin (1,3 or meta dioxybenzene) (1) is decomposed in a somewhat similar manner. Chlorination in glacial acetic acid solution yields pentachlor-m-diketo-R-hexene (2) and, at a later stage, heptachlor-m-diketo-R-hexene (3). These compounds are both decomposed by water, the former giving dichloroaceto-trichlorocrotonic acid (4), which on boiling with water gives dichloromethylvinyl-α-diketone (5). The heptachlor compound when treated with chlorine water gives trichloroaceto-pentachlorobutyric acid (6), which is hydrolysed by alkalis to chloroform and pentachloroglutaric acid (7), and is converted by boiling water into tetrachloro-diketo-R-pentene (8). This latter compound may be chlorinated to perchloroacetoacrylic chloride (9), from which the corresponding acid (10) is obtained by treatment with water; alkalis hydrolyse the acid to chloroform and dichloromaleic acid (11).

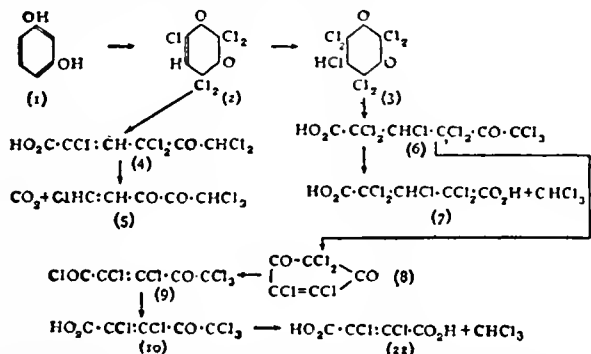

Hydroquinone (1,4 or para-dioxybenzene) (1) gives with chlorine, first, a tetrachloroquinone (2), and then hexachlor-p-diketo-R-hexene (3), which alcoholic potash converts into perchloroacrylacrylic acid (4). This substance, and also the preceding compound, is converted by aqueous caustic soda into dichloromaleic acid, trichlorethylene, and hydrochloric acid (5) (Th. Zincke and O. Fuchs, *Ann.*, 1892, 267, p. 1).

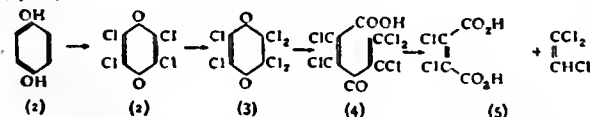

Phloroglucin (1,3,5-trioxybenzene) (1) behaves similarly to resorcin, hexachlor [1,3,5] triketo-R-hexylene (2) being first formed. This compound is converted by chlorine water into octachloroacetylacetone (3), by methyl alcohol into the ester of dichloromaleonic acid and tetrachloroacetone (4), whilst ammonia gives dichloroacetamide (5) (Th. Zincke and O. Kegel, *Ber.*, 1890, 23, p. 1706).

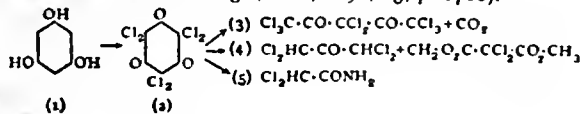

When phenol is oxidized in acid solution by chlorine, tetrachloroquinone is obtained, a compound also obtainable from hydroquinone. By conducting the chlorination in alkaline solution, A. Hantzsch (*Ber.*, 1889, 22, p. 1238) succeeded in obtaining derivatives of o-diketo-R-hexene, which yield R-pentene and aliphatic compounds on decomposition. When thus chlorinated phenol (1) yields trichloro-o-diketo-R-hexene (2), which may be hydrolysed to an acid (3), which, in turn, suffers rearrangement to trichloro-R-pentene-oxycarboxylic acid (4). Bromine water oxidizes this substance to oxalic acid and tetrabrom-dichloroacetone (5).

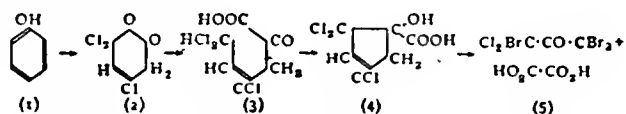

The reduction of o-oxybenzoic acids by sodium in amyl alcohol solution has been studied by A. Einhorn and J. S. Lumsden (*Ann.*, 1895, 286, p. 257). It is probable that tetrahydro acids are first formed, which suffer rearrangement to orthoketone carboxylic acids. These substances absorb water and become pimelic acids. Thus salicylic acid yields n-pimelic acid, HOOC·(CH₂)₄·COOH, while o-, m-, and p-cresotinic acids, C₆H₃(CH₃)(OH)(COOH), yield isomeric methylpimelic acids.

Resorcin on reduction gives dihydroresorcin, which G. Merling (*Ann.*, 1894, 278, p. 20) showed to be converted into n-glutaric acid, HOOC·(CH₂)₃·COOH, when oxidized with potassium permanganate; according to D. Vörländer (*Ber.*, 1895, 28, p. 2348) it is converted into γ-acetobutyric acid, CH₃CO·(CH₂)₂·COOH, when heated with baryta to 150-160°.

Configuration of the Benzene Complex.—The development of the "structure theory" in about 1860 brought in its train an appreciation of the chemical structure of the derivatives of benzene. The pioneer in this field was August Kekulé, who, in 1865 (*Ann.*, 137, p. 129; see also his *Lehrbuch der organischen Chemie*), submitted his well-known formula for benzene, so founding the "benzene theory" and opening up a problem which, notwithstanding the immense amount of labour since bestowed upon it, still remains imperfectly solved. Arguing from the existence of only one mono-substitution derivative, and of three di-derivatives (statements of which the rigorous proof was then wanting), he was led to arrange the six carbon atoms in a ring, attaching a hydrogen atom to each carbon atom; being left with the fourth carbon valencies, he mutually saturated these in pairs, thus obtaining the symbol I (see below). The value of this ringed structure was readily perceived, but objections were raised with respect to Kekulé's disposal of the fourth valencies. In 1866 Sir James Dewar proposed an unsymmetrical form (II), while in 1867, A. Claus (*Theoretische Betrachtungen und deren Anwendung zur Systematik der organischen Chemie*) proposed his diagonal formula (III), and two years later, A. Ladenburg (*Ber.*, 2, p. 140) devised his prism formula (IV), the six carbon atoms being placed at the six corners of a right equilateral triangular prism, with its plane projections (V, VI).

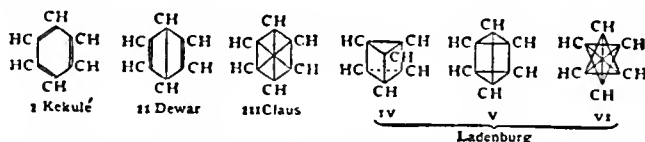

One of the earliest and strongest objections urged against Kekulé's formula was that it demanded two isomeric ortho-di-substitution derivatives, for if we number the carbon atoms in cyclical order from 1 to 6, then the derivatives 1,2 and 1,6 should be different.¹ Ladenburg submitted that if the 1-2 and 1,6 compounds were identical, then we should expect the two well-known crotonic acids, CH₃·CH·CH·COOH and CH₂·CH·CH₂·COOH, to be identical. This view was opposed by Victor Meyer and Kekulé. The former pointed out that the supposed isomerism was not due to an arrangement of atoms, but to the disposition of a valency, and therefore it was doubtful whether such a subtle condition could exert any influence on the properties of the substance. Kekulé answered Ladenburg by formulating a dynamic interpretation of valency. He assumed that if we have one atom

¹ It is now established that ortho compounds do exist in isomeric forms, instances being provided by chlor-, brom-, and amino-toluene, chlorphenol, and chloraniline; but arguments, e.g. E. Knoevenagel's theory of "moticisomerism," have been brought forward to cause these facts to support Kekulé.

connected by single bonds to (say) four other atoms, then in a certain unit of time it will collide with each of these atoms in turn. Now suppose two of the attached atoms are replaced by one atom, then this atom must have two valencies directed to the central atom; and consequently, in the same unit of time, the central atom will collide once with each of the two monovalent atoms and twice with the divalent. Applying this notion to benzene, let us consider the impacts made by the carbon atom (1) which we will assume to be doubly linked to the carbon atom (2) and singly linked to (6), *h* standing for the hydrogen atom. In the first unit of time, the impacts are 2, 6, *h*, 2; and in the second 6, 2, *h*, 6. If we represent graphically the impacts in the second unit of time, we perceive that they point to a configuration in which the double linkage is between the carbon atoms 1 and 6, and the single linkage between 1 and 2. Therefore, according to Kekulé, the double linkages are in a state of continual oscillation, and if his dynamical notion of valency, or a similar hypothesis, be correct, then the difference between the 1.2 and 1.6 di-derivatives rests on the insufficiency of his formula, which represents the configuration during one set of oscillations only. The difference is only apparent, not real. An analogous oscillation prevails in the pyrazol nucleus, for L. Knorr (*Ann.*, 1894, 279, p. 188) has shown that 3- and 5-methylpyrazols are identical.

The explanation thus attempted by Kekulé was adversely criticized, more especially by A. Ladenburg, who devoted much attention to the study of the substitution products of benzene, and to the support of his own formula. His views are presented in his pamphlet: *Theorie der aromatischen Verbindungen*, 1876. The prism formula also received support from the following data: protocatechuic acid when oxidized by nitrous acid gives carboxytartronic acid, which, on account of its ready decomposition into carbon dioxide and tartronic acid, was considered to be HO-C(COOH)₂. This implied that in the benzene complex there was at least one carbon atom linked to three others, thus rendering Kekulé's formula impossible and Ladenburg's and Claus' possible Kekulé (*Ann.*, 1883, 221, p. 230), however, reinvestigated this acid; he showed that it was dibasic and not tribasic; that it gave tartaric acid on reduction; and, finally, that it was dioxytartaric acid, HOOC-C(OH)₂-C(OH)₂-COOH. The formation of this substance readily follows from Kekulé's formula, while considerable difficulties are met with when one attempts an explanation based on Ladenburg's representation. Kekulé also urged that the formation of trichlorophenolic acid, shown by him and O. Strecker to be trichloroacetoacrylic acid, was more favourably explained by his formula than by Ladenburg's.

Other objections to Ladenburg's formula resulted from A. von Baeyer's researches (commenced in 1886) on the reduced phthalic acids. Baeyer pointed out that although benzene derivatives were obtainable from hexamethylene compounds, yet it by no means follows that only hexamethylene compounds need result when benzene compounds are reduced. He admitted the possibility of the formulae of Kekulé, Claus, Dewar and Ladenburg, although as to the last di-trimethylene derivatives should be possible reduction products, being formed by severing two of the prism edges; and he attempted to solve the problem by a systematic investigation of the reduced phthalic acids.

Ladenburg's prism admits of one mono-substitution derivative and three di-derivatives. Furthermore, it is in accordance with certain simple syntheses of benzene derivatives (e.g. from acetylene and acetone); but according to Baeyer (*Ber.*, 1886, 19, p. 1797) it fails to explain the formation of dioxyterephthalic ester from succinosuccinic ester, unless we make the assumption that the transformation of these substances is attended by a migration of the substituent groups. For succinosuccinic ester, formed by the action of sodium on two molecules of succinic ester, has either of the formulae (I) or (II); oxidation of the free acid gives dioxyterephthalic acid in which the para-positions must remain substituted as in (I) and (II). By projecting Ladenburg's prism on a plane and numbering the atoms so as to correspond with Kekulé's form, viz. that 1.2 and 1.6 should be ortho-positions, 1.3 and 1.5 meta-, and 1.4 para-, and following out the transformation on the Ladenburg formula, then an ortho-dioxyterephthalic acid (IV) should result, a fact denied by experience, and inexplicable unless we assume a wandering of atoms. Kekulé's formula (III), on the other hand, is in full agreement (Baeyer). This explanation has been challenged by Ladenburg

(*Ber.*, 1886, 19, p. 971; *Ber.*, 1887, 20, p. 62) and by A. K. Miller (*J. C. S. Trans.*, 1887, p. 208). The transformation is not one of the oxidation of a hexamethylene compound to a benzenoid compound, for only two hydrogen atoms are removed. Succinosuccinic ester behaves both as a ketone and as a phenol, thereby exhibiting desmotropy, assuming the ketone formula as indicating the constitution, then in Baeyer's equation we have a migration of a hydrogen atom, whereas to bring Ladenburg's formula into line an oxygen atom must migrate

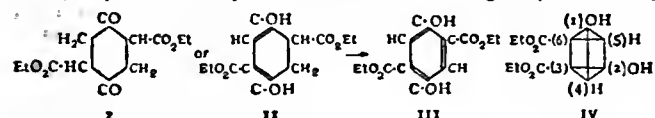

(*Ber.*, 1886, 19, p. 971; *Ber.*, 1887, 20, p. 62) and by A. K. Miller (*J. C. S. Trans.*, 1887, p. 208). The transformation is not one of the oxidation of a hexamethylene compound to a benzenoid compound, for only two hydrogen atoms are removed. Succinosuccinic ester behaves both as a ketone and as a phenol, thereby exhibiting desmotropy, assuming the ketone formula as indicating the constitution, then in Baeyer's equation we have a migration of a hydrogen atom, whereas to bring Ladenburg's formula into line an oxygen atom must migrate

The relative merits of the formulae of Kekulé, Claus and Dewar were next investigated by means of the reduction products of benzene, it being Baeyer's intention to detect whether double linkages were or were not present in the benzene complex.

To follow Baeyer's results we must explain his nomenclature of the reduced benzene derivatives. He numbers the carbon atoms placed at the corners of a hexagon from 1 to 6, and each side in the same order, so that the carbon atoms 1 and 2 are connected by the side 1, atoms 2 and 3 by the side 2, and so on. A doubly linked pair of atoms is denoted by the sign Δ with the index corresponding to the side; if there are two pairs of double links, then indices corresponding to both sides are employed. Thus Δ^1 denotes a tetrahydro derivative in which the double link occupies the side 1; $\Delta^{1,2}$, a dihydro derivative, the double links being along the sides 1 and 2. Another form of isomerism is occasioned by spatial arrangements, many of the reduced terephthalic acids existing in two stereo-isomeric forms. Baeyer explains this by analogy with fumaric and maleic acids: he assumes the reduced benzene ring to lie in a plane; when both carboxyl groups are on the same side of this plane, the acids, in general, resemble maleic acids, these forms he denotes by *Trans-cis*, or shortly *cis-*, when the carboxyl groups are on opposite sides, the acids correspond to fumaric acid, these forms are denoted by *Trans-trans*, or shortly *trans-*.

By reducing terephthalic acid with sodium amalgam, care being taken to neutralize the caustic soda simultaneously formed by passing in carbon dioxide, $\Delta^{2,5}$ dihydroterephthalic acid is obtained; this results from the splitting of a *para*-linkage. By boiling with water the $\Delta^{2,5}$ acid is converted into the $\Delta^{1,4}$ dihydroterephthalic acid. This acid is converted into the $\Delta^{1,2}$ acid by soda, and into the Δ^2 tetrahydro acid by reduction. From this acid the $\Delta^{1,2}$ dihydro and the Δ^1 tetrahydro acids may be obtained, from both of which the hexahydro acid may be prepared. From these results Baeyer concluded that Claus' formula with three *para*-linkings cannot possibly be correct, for the $\Delta^{2,5}$ dihydroterephthalic acid undoubtedly has two ethylene linkages, since it readily takes up two or four atoms of bromine, and is oxidized in warm aqueous solution by alkaline potassium permanganate. But the formation of the $\Delta^{1,4}$ acid as the first reduction product is not fully consistent with Kekulé's symbol, for we should then expect the $\Delta^{1,2}$ or the $\Delta^{1,4}$ acid to be first formed (see also POLYMETHYLENES).

The stronger argument against the ethylenoid linkages demanded by Kekulé's formula is provided by the remarkable stability towards oxidizing and reducing agents which characterizes all benzenoid compounds. From the fact that reduction products containing either one or two double linkages behave exactly as unsaturated aliphatic compounds, being readily reduced or oxidized, and combining with the halogen elements and haloid acids, it seems probable that in benzenoid compounds the fourth valencies are symmetrically distributed in such a manner as to induce a peculiar stability in the molecule. Such a configuration was proposed in 1887 by H. E. Armstrong (*J. C. S. Trans.*, 1887, p. 258), and shortly afterwards by Baeyer (*Ann.*, 1888, 245, p. 103). In this formula, the so-called "centric formula," the assumption made is that the fourth valencies are simply directed towards the centre of the ring; nothing further is said about the fourth valencies except that they exert a pressure towards the centre. Claus maintained that Baeyer's view was identical with his own, for as in Baeyer's formula, the fourth valencies have a different function from the peripheral valencies, being united at the centre in a form of potential union.

It is difficult to determine which configuration most accurately explains the observed facts; Kekulé's formula undoubtedly explains the synthetical production of benzenoid compounds most satisfactorily, and W. Marckwald (*Ann.*, 1893, 274, p. 331; 1894, 279, p. 14) has supported this formula from considerations based on the syntheses of the quinoline ring. Further researches by Baeyer, and upon various nitrogenous-ring systems by E. Bamberger (a strong supporter of the centric formula), have shown that the nature of the substituent groups influences the distribution of the fourth valencies; therefore it may be concluded that in compounds the benzene nucleus appears to be capable of existence in two tautomeric forms, in the sense that each particular derivative possesses a definite constitution. The benzene nucleus presents a remarkable case, which must be considered in the formulation of any complete theory of valency. From a study of the reduction of compounds containing two ethylenic bonds united by a single bond, termed a "conjugated system," E. Thiele suggested a doctrine of "partial valencies,"

which assumes that in addition to the ordinary valencies, each doubly linked atom has a partial valency, by which the atom first interacts. When applied to benzene, a twofold conjugated system is suggested in which the partial valencies of adjacent atoms neutralize, with the formation of a potential double link. The stability of benzene is ascribed to this conjugation.¹

Physico-chemical properties have also been drawn upon to decide whether double unions are present in the benzene complex;

but here the predilections of the observers apparently influence the nature of the conclusions to be drawn from such data. It is well known that

Physico-chemical methods. singly, doubly and trebly linked carbon atoms affect the physical properties of substances, such as the refractive index, specific volume, and the heat of combustion; and by determining these constants for many substances, fairly definite values can be assigned to these groupings. The general question of the relation of the refractive index to constitution has been especially studied by J. W. Brühl, who concluded that benzene contained 3 double linkages; whereas, in 1901, Pellini (*Gazetta*, 31, i. p. 1) calculated that 9 single linkages were present. A similar contradiction apparently exists with regard to the specific volume, for while benzene has a specific volume corresponding to Claus' formula, toluene, or methylbenzene, rather points to Kekulé's. The heat of combustion, as first determined by Julius Thomsen, agreed rather better with the presence of nine single unions. His work was repeated on a finer scale by M. P. E. Berthelot of Paris, and F. C. A. Stohmann of Leipzig; and the new data and the conclusions to be drawn from them formed the subject of much discussion, Brühl endeavouring to show how they supported Kekulé's formula, while Thomsen maintained that they demanded the benzene union to have a different heat of combustion from the acetylene union. Thomsen then investigated heats of combustion of various benzenoid hydrocarbons—benzene, naphthalene, anthracene, phenanthrene, &c.—in the crystallized state. It was found that the results were capable of expression by the empirical relation $C_aH_b = 104.3b + 49.09m + 105.47n$, where C_aH_b denotes the formula of the hydrocarbon, m the number of single carbon linkings and n the number of double linkings, m and n being calculated on the Kekulé formulae. But, at the same time, the constants in the above relation are not identical with those in the corresponding relation empirically deduced from observations on fatty hydrocarbons; and we are therefore led to conclude that a benzene union is considerably more stable than an ethylene union.

Mention may be made of the absorption spectrum of benzene. According to W. N. Hartley (*J.C.S.*, 1905, 87, p. 1822), there are six bands in the ultra-violet, while E. C. C. Baly and J. N. Collie (*J.C.S.*, 1905, 87, p. 1332; 1906, 89, p. 524) record seven. These bands are due to molecular oscillations; Hartley suggests the carbon atoms to be rotating and forming alternately single and double linkages, the formation of three double links giving three bands, and of three single links another three; Baly and Collie, on the other hand, suggest the making and breaking of links between adjacent atoms, pointing out that there are seven combinations of one, two and three pairs of carbon atoms in the benzene molecule.

Stereo-chemical Configurations.—Simultaneously with the discussions of Kekulé, Ladenburg, Claus, Bacyer and others as to the merits of various plane formulae of the benzene complex, there were published many suggestions with regard to the arrangement of the atoms in space, all of which attempted to explain the number of isomers and the equivalence of the hydrogen atoms. The development of stereo-isomerism at the hands of

¹ Victor Meyer and G. Heyl (*Ber.*, 1895, 28, p. 2776) attempted a solution from the following data. It is well known that di-ortho-substituted benzoic acids are esterified with difficulty. Two acids corresponding to the formula of Kekulé and Claus are triphenyl acrylic acid, $(C_6H_5)_2C:C(COOH)-C_6H_5$, and triphenyl acetic acid, $(C_6H_5)_2C-COOH$. Experiments showed that the second acid was much more difficult to esterify than the first, pointing to the conclusion that Claus' formula for benzene was more probable than Kekulé's.

J. Wislicenus, Le Bel and van 't Hoff has resulted in the introduction of another condition which formulae for the benzene complex must satisfy, viz. that the hydrogen atoms must all lie in one plane. The proof of this statement rests on the fact that if the hydrogen atoms were not co-planar, then substitution derivatives (the substituting groups not containing asymmetric carbon atoms) should exist in enantiomorphic forms, differing in crystal form and in their action on polarized light; such optical antipodes have, however, not yet been separated. Ladenburg's prism formula would give two enantiomorphic ortho-di-substitution derivatives; while forms in which the hydrogen atoms are placed at the corners of a regular octahedron would yield enantiomorphic tri-substitution derivatives.

The octahedral formula discussed by Julius Thomsen (*Ber.*, 1886, 19, p. 2944) consists of the six carbon atoms placed at the corners of a regular octahedron, and connected together by the full lines as shown in (I); a plane projection gives a hexagon with diagonals (II). Reduction to hexamethylene compounds necessitates the disruption of three of the edges of the octahedron, the diagonal linkings remaining intact, or, in the plane projection, three peripheral linkages, the hexamethylene ring assuming the form (III):

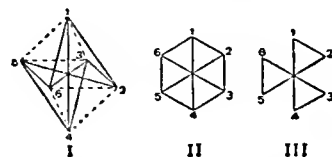

In 1888 J. E. Marsh published a paper (*Phil. Mag.* [V.], 26, p. 426) in which he discussed various stereo-chemical representations of the benzene nucleus. (The stereo-chemistry of carbon compounds has led to the spatial representation of a carbon atom as being situated at the centre of a tetrahedron, the four valencies being directed towards the apices; see above, and ISOMERISM.) A form based on Kekulé's formula consists in taking three pairs of tetrahedra, each pair having a side in common, and joining them up along the sides of a regular hexagon by means of their apices. This form, afterwards supported by Carl Graebe (*Ber.*, 1902, 35, p. 526; see also Marsh's reply, *Journ. Chem. Soc. Trans.*, 1902, p. 961) shows the proximity of the ortho-positions, but fails to explain the identity of 1.2 and 1.6 compounds. Arrangements connected with Claus' formula are obtained by placing six tetrahedra on the six triangles formed by the diagonals of a plane hexagon. The form in which the tetrahedra are all on one side, afterwards discussed by J. Loschmidt (*Monats.*, 1890, 11, p. 28), would not give stereo-isomers; and the arrangement of placing the tetrahedra on alternate sides, a form afterwards developed by W. Vaubel (*Journ. Pr. Chem.*, 1894 [2], 49, p. 308), has the advantage of bringing the meta-positions on one side, and the ortho- and para- on opposite sides, thus exhibiting the similarity actually observed between these series of compounds. Marsh also devised a form closely resembling that of Thomsen, inasmuch as the carbon atoms occupied the angles of a regular octahedron, and the diagonal linkages differed in nature from the peripheral, but differing from Thomsen's since rupture of the diagonal and not peripheral bonds accompanied the reduction to hexamethylene.

We may also notice the model devised by H. Sachse (*Ber.*, 1888, 21, 2530; *Zeit. für phys. Chem.*, 11, p. 214; 23, p. 2062). Two parallel triangular faces are removed from a cardboard model of a regular octahedron, and on the remaining six faces tetrahedra are then placed; the hydrogen atoms are at the free angles. This configuration is, according to Sachse, more stable than any other form; no oscillation is possible, the molecule being only able to move as a whole. In 1897, J. N. Collie (*Journ. Chem. Soc. Trans.*, p. 1013) considered in detail an octahedral form, and showed how by means of certain simple rotations of his system the formulae of Kekulé and Claus could be obtained as projections. An entirely new device, suggested by B. König (*Chem. Zeit.*, 1905, 29, p. 30), assumed the six carbon atoms to occupy six of the corners of a cube, each carbon atom being linked to a hydrogen atom and by single bonds to two neighbouring carbon atoms, the remaining valencies being directed to the unoccupied corners of the cube, three to each, where they are supposed to satisfy each other.

Condensed Nuclei.

Restricting ourselves to compounds resulting from the fusion of benzene rings, we have first to consider naphthalene, $C_{10}H_8$, which consists of two benzene rings having a pair of carbon atoms in common. The next members are the isomers anthracene and phenanthrene, $C_{14}H_{10}$, formed from three benzene nuclei. Here we shall only discuss the structure of these compounds in the light of the modern benzene theories; reference should be made

to the articles NAPHTHALENE, ANTHRACENE and PHENANTHRENE for syntheses, decompositions, &c.

Naphthalene.—Of the earlier suggestions for the constitution of naphthalene we notice the formulae of Wreden (1) and (2), Berthelot and Balls (3), R. A. C. E. Erlenmeyer (4) and Adolf Claus (5).

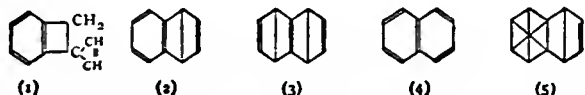

The first suggestion is quite out of the question. C. Graebe in 1866 (*Ann.* 149, p. 20) established the symmetry of the naphthalene nucleus, and showed that whichever half of the molecule be oxidized the same phthalic acid results. Therefore formula (2), being unsymmetrical, is impossible. The third formula is based on Dewar's benzene formula, which we have seen to be incorrect. Formula (4) is symmetrical and based on Kekulé's formula: it is in full accord with the syntheses and decompositions of the naphthalene nucleus and the number of isomers found. In 1882 Claus suggested a combination of his own and Dewar's benzene formulae. This is obviously unsymmetrical, consisting of an aliphatic and an aromatic nucleus; Claus explained the formation of the same phthalic acid from the oxidation of either nucleus by supposing that if the aromatic group be oxidized, the aliphatic residue assumes the character of a benzene nucleus. Bamberger opposed Claus' formula on the following grounds:—The molecule of naphthalene is symmetrical, since 2,7-dioxy-naphthalene is readily esterified by methyl iodide and sulphuric acid to a dimethyl ether; and no more than two mono-substitution derivatives are known. The molecule is aromatic but not benzenoid; however, by the reduction of one half of the molecule, the other assumes a benzenoid character.

If β -naphthylamine and β -naphthol be reduced, tetrahydro products are obtained in which the amino- or oxy-bearing half of the molecule becomes aliphatic in character. The compounds so obtained, alicyclic- β -tetrahydronaphthylamine and alicyclic- β -tetrahydronaphthol, closely resemble β -aminodiethylbenzene, $C_6H_4(C_2H_5)_2 \cdot C_2H_4NH_2$, and β -oxydiethylbenzene, $C_6H_4(C_2H_5)_2 \cdot C_2H_4OH$. If α -naphthylamine and α -naphthol be reduced, the hydrogen atoms attach themselves to the non-substituted half of the molecule, and the compounds so obtained resemble aminodiethylbenzene, $C_6H_5 \cdot NH_2(C_2H_5)_2$, and oxydiethylbenzene, $C_6H_5 \cdot OH(C_2H_5)_2$. Bamberger's observations on reduced quinoline derivatives point to the same conclusion, that condensed nuclei are not benzenoid, but possess an individual character, which breaks down, however, when the molecule is reduced.

It remains, therefore, to consider Erlenmeyer's formula and those derived from the centric hypothesis. The former, based on Kekulé's symbol for benzene, explains the decompositions and syntheses of the ring, but the character of naphthalene is not in keeping with the presence of five double linkages, although it is more readily acted upon than benzene is. On the centric hypothesis two formulae are possible: (1) due to H.E. Armstrong, and (2) due to E. Bamberger.



In the first symbol it is assumed that one of the affinities of each of the two central carbon atoms common to the two rings acts into both rings, an assumption involving a somewhat wide departure from all ordinary views as to the manner in which affinity acts. This symbol harmonizes with the fact that the two rings are in complete sympathy, the one responding to every change made in the other. Then, on account of the relatively slight—because divided—influence which would be exercised upon the two rings by the two affinities common to both, the remaining four centric affinities of each ring would presumably be less attracted into the ring than in the case of benzene; consequently they would be more active outwards, and combination would set in more readily. When, as in the formation of naphthalene tetrachloride, for example, the one ring becomes saturated, the other might be expected to assume the normal

centric form and become relatively inactive. This is absolutely the case. On the other hand, if substitution be effected in the one ring, and the affinities in that ring become attracted inwards, as apparently happens in the case of benzene, the adjoining ring should become relatively more active because the common affinities would act less into it. Hence, unless the radical introduced be one which exercises a special attractive influence, substitution should take place in preference in the previously unsubstituted ring. In practice this usually occurs; for example, on further bromination, α -bromonaphthalene yields a mixture of the (1,4) and (1,5) dibromonaphthalenes; and when nitro-naphthalene is either brominated, or nitrated or sulphonated, the action is practically confined to the second ring. The centric formula proposed by Bamberger represents naphthalene as formed by the fusion of two benzene rings, this indicates that it is a monocyclic composed of ten atoms of carbon. The formula has the advantage that it may be constructed from tetrahedral models of the carbon atom; but it involves the assumption that the molecule has within it a mechanism, equivalent in a measure to a system of railway points, which can readily close up and pass into that characteristic of benzene.

Anthracene and Phenanthrene.—These isomeric hydrocarbons, of the formula $C_{14}H_{10}$, are to be regarded as formed by the fusion of three benzenoid rings as represented by the symbols:—

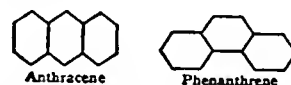

In both cases the medial ring is most readily attacked; and various formulae have been devised which are claimed by their authors to represent this and other facts. According to Armstrong, anthracene behaves unsymmetrically towards substituents, and hence one lateral ring differs from the other; he represents the molecule as consisting of one centric ring, the remaining medial and lateral ring being ethenoid. Bamberger, on the other hand, extends his views on benzene and naphthalene and assumes the molecule to be (1). For general purposes, however, the symbol (2), in which the lateral rings are benzenoid and the medial ring fatty, represents quite adequately the syntheses, decompositions, and behaviour of anthracene.



Phenanthrene is regarded by Armstrong as represented by (3), the lateral rings being benzenoid, and the medial ring fatty; Bamberger, however, regards it as (4), the molecule being

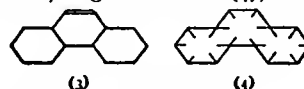

entirely aromatic. An interesting observation by Baeyer, viz. that stilbene, $C_6H_5 \cdot CH:CH \cdot C_6H_5$, is very readily oxidized, while phenanthrene is not, supports, in some measure, the views of Bamberger.

Heterocyclic Compounds.

During recent years an immense number of ringed or cyclic compounds have been discovered, which exhibit individual characters more closely resembling benzene, naphthalene, &c. than purely aliphatic substances, inasmuch as in general they contain double linkages, yet withstand oxidation, and behave as nuclei, forming derivatives in much the same way as benzene. By reduction, the double linkages become saturated, and compounds result which stand in much about the same relation to the original nucleus as hexamethylene does to benzene. In general, therefore, it may be considered that the double linkages are not of exactly the same nature as the double linkage present in ethylene and ethylenoid compounds, but that they are analogous to the potential valencies of benzene. The centric hypothesis has been applied to these rings by Bamberger and others; but as in the previous rings considered, the ordinary

representation with double and single linkages generally represents the syntheses, decompositions, &c.; exceptions, however, are known where it is necessary to assume an oscillation of the double linkage. Five- and six-membered rings are the most stable and important, the last-named group resulting from the polymerization of many substances; three- and four-membered rings are formed with difficulty, and are easily ruptured; rings containing seven or more members are generally unstable, and are relatively little known. The elements which go to form heterocyclic rings, in addition to carbon, are oxygen, sulphur, selenium and nitrogen. It is remarkable that sulphur can replace two methine or CH groups with the production of compounds greatly resembling the original one. Thus benzene, $(CH)_6$, gives thiophene, $(CH)_4S$, from which it is difficultly distinguished; pyridine, $(CH)_5N$, gives thiazole, $(CH)_3N.S$, which is a very similar substance; naphthalene gives thionaphthen, C_8H_6S , with which it shows great analogies, especially in the derivatives. Similarly a CH group may be replaced by a nitrogen atom with the production of compounds of similar stability; thus benzene gives pyridine, naphthalene gives quinoline and isoquinoline; anthracene gives acridine and α and β anthrapyridines. Similarly, two or more methine groups may be replaced by the same number of nitrogen atoms with the formation of rings of considerable stability.

Most of the simple ring systems which contain two adjacent carbon atoms may suffer fusion with any other ring (also containing two adjacent carbon atoms) with the production of nuclei of greater complexity. Such *condensed nuclei* are, in many cases, more readily obtained than the parent nucleus. The more important types are derived from aromatic nuclei, benzene, naphthalene, &c.; the ortho-di-derivatives of the first named, lending themselves particularly to the formation of condensed nuclei. Thus ortho-phenylene diamine yields the following products:—

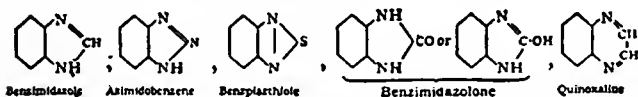

In some cases oxidation of condensed benzenoid-heterocyclic nuclei results in the rupture of the heterocyclic ring with the formation of a benzene dicarboxylic acid; but if the aromatic nucleus be weakened by the introduction of an amino group, then it is the benzenoid nucleus which is destroyed and a dicarboxylic acid of the heterocyclic ring system obtained.

Heterocyclic rings may be systematically surveyed from two aspects: (1) by arranging the rings with similar hetero-atoms according to the increasing number of carbon atoms, the so-called "homologous series"; or (2) by first dividing the ring systems according to the number of members constituting the ring, and then classifying these groups according to the nature of the hetero-atoms, the so-called "isologous series." The second method possesses greater advantages, for rings of approximate stability come in one group, and, consequently, their derivatives may be expected to exhibit considerable analogies.

As a useful preliminary it is convenient to divide heterocyclic ring systems into two leading groups: (1) systems resulting from simple internal dehydration (or similar condensations) of saturated aliphatic compounds—such compounds are: the internal anhydrides or cyclic ethers of the glycols and thioglycols (ethylene oxide, &c.); the cyclic alkyleneimides resulting from the splitting off of ammonia between the amino groups of diamino-paraffins (pyrrolidine, piperazine, &c.); the cyclic esters of oxycarboxylic acids (lactones, lactides); the internal anhydrides of aminocarboxylic acids (lactams, betaines); cyclic derivatives of dicarboxylic acids (anhydrides, imides, alkylene-esters, alkylene-amides, &c.). These compounds retain their aliphatic nature, and are best classified with open-chain compounds, into which, in general, they are readily converted. (2) Systems which are generally unsaturated compounds, often of considerable stability, and behave as nuclei; these compounds constitute a well-individualized class exhibiting closer affinities to benzenoid substances than to the open-chain series.

The transition between the two classes as differentiated above may be illustrated by the following cyclic compounds, each of which

contains a ring composed of four carbon atoms and one oxygen atom:

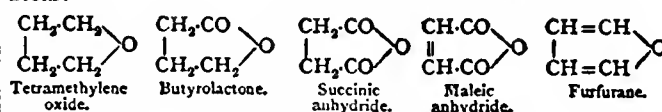

The first four substances are readily formed from, and converted into, the corresponding dihydroxy open-chain compound; these substances are truly aliphatic in character. The fifth compound, on the other hand, does not behave as an unsaturated aliphatic compound, but its deportment is that of a nucleus, many substitution derivatives being capable of synthesis. Reduction, however, converts it into an aliphatic compound. This is comparable with the reduction of the benzene nucleus into hexamethylene, a substance of an aliphatic character.

True ring systems, which possess the characters of organic nuclei, do not come into existence in three- and four-membered rings, their first appearance being in penta-atomic rings. The three primary members are furfuran, thiophene and pyrrol, each of which contains four methine or CH groups, and an oxygen, sulphur and imido (NH) member respectively; a series of compounds containing selenium is also known. The formulae of these substances are:

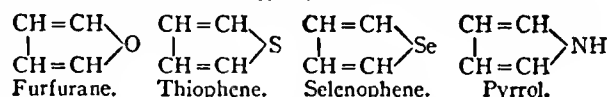

By substituting one or more CH groups in these compounds by nitrogen atoms, ring-systems, collectively known as *azoles*, result. Obviously, isomeric ring-systems are possible, since the carbon atoms in the original rings are not all of equal value. Thus furfuran yields the following rings by the introduction of one and two nitrogen atoms:

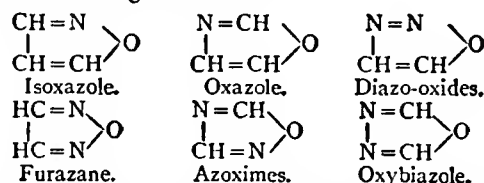

Thiophene yields a similar series: isothiazole (only known as the condensed ring, isobenzothiazole), thiazole, diazosulphides, piathioles, azosulphimes and thiobiazole (the formulae are easily derived from the preceding series by replacing oxygen by sulphur). Thiophene also gives rise to triazulphole, three nitrogen atoms being introduced. Selenophene gives the series: selenazole, diazosenide and piaselenole, corresponding to oxazole, diazo-oxides and furazane. Pyrrol yields an analogous series: pyrazole, imidazole or glyoxaline, azimide or osotriazole, triazole and tetrazole:

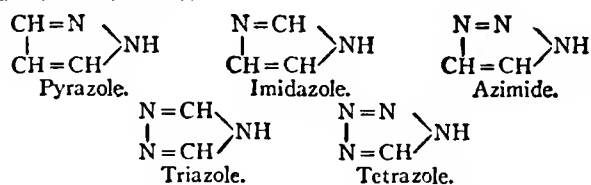

Six-membered ring systems can be referred back, in a manner similar to the above, to pyrone, penthiofene and pyridine, the substances containing a ring of five carbon atoms, and an oxygen, sulphur and nitrogen atom respectively. As before, only *true* ring nuclei, and not internal anhydrides of aliphatic compounds, will be mentioned. From the pyrone ring the following series of compounds are derived (for brevity, the hydrogen atoms are not printed):

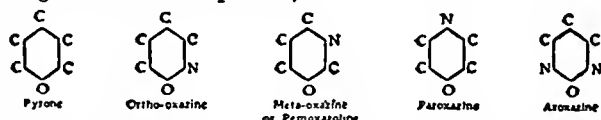

Penthiofene gives, by a similar introduction of nitrogen atoms, penthiazoline, corresponding to meta-oxazine, and para-thiazine,

corresponding to paroxazine (para-oxazine). Pyridine gives origin to: pyridazine or ortho-diazine, pyrimidine or meta-diazine, pyrazine or para-diazine, osotriazine, *unsymmetrical* triazine, *symmetrical* triazine, osotetrazone and tetrazine. The skeletons of these types are (the carbon atoms are omitted for brevity):

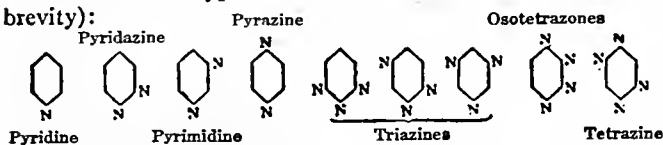

We have previously referred to the condensation of heterocyclic ring systems containing two vicinal carbon atoms with benzene, naphthalene and other nuclei. The more important nuclei of this type have received special and non-systematic names; when this is not the case, such terms as phen-, benzo-, naphtho- are prefixed to the name of the heterocyclic ring. One or two benzene nuclei may suffer condensation with the furfuran, thiophene and pyrrol rings, the common carbon atoms being vicinal to the hetero-atom. The mono-benzo-derivatives are coumarone, benzothiophene and indole; the dibenzo-derivatives are diphenylene oxide, dibenzothiophene or diphenylene sulphide, and carbazole. Typical formulae are (R denoting O, S or NH):

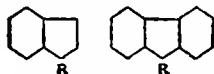

Isomers are possible, for the condensation may be effected on the two carbon atoms symmetrically placed to the hetero-atom; these isomers, however, are more of the nature of internal anhydrides. Benz-oxazoles and -thiazoles have been prepared, benz-isoxazoles are known as indoxazenes; benzo-pyrazoles occur in two structural forms, named indazoles and isindazoles. Derivatives of osotriazole also exist in two forms—azimides and pseudo-azimides.

Proceeding to the six-membered hetero-atomic rings, the benzo-, dibenzo- and naphtho-derivatives are frequently of great commercial and scientific importance. α -pyrone condenses with the benzene ring to form coumarin and isocoumarin; benzo- γ -pyrone constitutes the nucleus of several vegetable colouring matters (chrysin, fisetin, quercetin, &c., which are derivatives of flavone or phenyl benzo- γ -pyrone); dibenzo- γ -pyrone is known as xanthone; related to this substance are fluorane (and fluorescein), fluorone, fluorime, pyronine, &c. The pyridine ring condenses with the benzene ring to form quinoline and isoquinoline; acridine and phenanthridine are dibenzo-pyridines; naphthalene gives rise to α - and β -naphtho-quinolines and the anthrapyridines; anthracene gives anthra-quinoline; while two pyridine nuclei connected by an intermediate benzene nucleus give the phenanthrolines. Naphthylidines and naphtholines result from the condensation of two pyridine and two quinoline nuclei respectively; and quino-quinolines are unsymmetrical naphthylidene nuclei condensed with a benzene nucleus. Benzo-orthoxazines, -metoxazines and -paroxazines are known: dibenzoparoxazine or phenoxazine is the parent of a valuable series of dyestuffs; dibenzoparathiazine or thiodiphenylamine is important from the same aspect. Benzo-ortho-diazines exist in two structural forms, cinnolin and phthalazine; benzo-meta-diazines are known as quinazolines; benzo-para-diazines are termed quinoxalines; the dibenzo-compounds are named phenazines, this last group including many valuable dyestuffs—indulines, safranines, &c. In addition to the types of compounds enumerated above we may also notice purin, tropine and the terpenes.

V. ANALYTICAL CHEMISTRY

This branch of chemistry has for its province the determination of the constituents of a chemical compound or of a mixture of compounds. Such a determination is *qualitative*, the constituent being only detected or proved to be present, or *quantitative*, in which the amount present is ascertained. The methods of chemical analysis may be classified according to the type of

reaction: (1) *dry* or *blowpipe analysis*, which consists in an examination of the substance in the dry condition; this includes such tests as ignition in a tube, ignition on charcoal in the blowpipe flame, fusion with borax, microcosmic salt or fluxes, and flame colorations (in quantitative work the dry methods are sometimes termed "dry assaying"); (2) *wet analysis*, in which a solution of the substance is treated with reagents which produce specific reactions when certain elements or groups of elements are present. In quantitative analysis the methods can be subdivided into: (a) *gravimetric*, in which the constituent is precipitated either as a definite insoluble compound by the addition of certain reagents, or electrolytically, by the passage of an electric current; (b) *volumetric*, in which the volume of a reagent of a known strength which produces a certain definite reaction is measured; (c) *colorimetric*, in which the solution has a particular tint, which can be compared with solutions of known strengths.

Historical.—The germs of analytical chemistry are to be found in the writings of the pharmacists and chemists of the iatrochemical period. The importance of ascertaining the proximate composition of bodies was clearly realized by Otto Tachenius; but the first systematic investigator was Robert Boyle, to whom we owe the introduction of the term *analysis*. Boyle recognized many reagents which gave precipitates with certain solutions: he detected sulphuric and hydrochloric acids by the white precipitates formed with calcium chloride and silver nitrate respectively; ammonia by the white cloud formed with the vapours of nitric or hydrochloric acids; and copper by the deep blue solution formed by a solution of ammonia. Of great importance is his introduction of vegetable juices (the so-called *indicators, q.v.*) to detect acids and bases. During the phlogistic period, the detection of the constituents of compounds was considerably developed. Of the principal workers in this field we may notice Friedrich Hoffmann, Andreas Sigismund Marggraf (who detected iron by its reaction with potassium ferrocyanide, and potassium and sodium by their flame colorations), and especially Carl Scheele and Torbern Olof Bergman. Scheele enriched the knowledge of chemistry by an immense number of facts, but he did not possess the spirit of working systematically as Bergman did. Bergman laid the foundations of systematic qualitative analysis, and devised methods by which the metals may be separated into groups according to their behaviour with certain reagents. This subdivision, which is of paramount importance in the analysis of minerals, was subsequently developed by Wilhelm August Lampadius in his *Handbuch zur chemischen Analyse der Mineralien* (1801) and by John Friedrich A. Götting in his *Praktische Anleitung zur prüfenden und zurlegenden Chemie* (1802).

The introduction of the blowpipe into dry qualitative analysis by Axel Fredrik Cronstedt marks an important innovation. The rapidity of the method, and the accurate results which it gave in the hands of a practised experimenter, led to its systematization by Jöns Jakob Berzelius and Johann Friedrich Ludwig Hausmann, and in more recent times by K. F. Plattner, whose treatise *Die Probirkunst mit dem Löthrohr* is a standard work on the subject. Another type of dry reaction, namely, the *flame coloration*, had been the subject of isolated notices, as, for example, the violet flame of potassium and the orange flame of sodium observed by Marggraf and Scheele, but a systematic account was wanting until Cartmell took the subject up. His results (*Phil. Mag.* 16, p. 382) were afterwards perfected by Robert Wilhelm Bunsen and Gustav Merz. Closely related to the flame-colorations, we have to notice the great services rendered by the spectroscope to the detection of elements. Rubidium, caesium, thallium, indium and gallium were first discovered by means of this instrument; the study of the rare earths is greatly facilitated, and the composition of the heavenly bodies alone determinable by it.

Quantitative chemistry had been all but neglected before the time of Lavoisier, for although a few chemists such as Tachenius, Bergman and others had realized the advantages which would accrue from a knowledge of the composition of

bodies by weight, and had laid down the lines upon which such determinations should proceed, the experimental difficulties in making accurate observations were enormous, and little progress could be made until the procedure was more accurately determined. Martin Heinrich Klaproth showed the necessity for igniting precipitates before weighing them, if they were not decomposed by this process; and he worked largely with Louis Nicolas Vauquelin in perfecting the analysis of minerals. K. F. Wenzel and J. B. Richter contributed to the knowledge of the quantitative composition of salts. Anton Laurent Lavoisier, however, must be considered as the first great exponent of this branch of chemistry. He realized that the composition by weight of chemical compounds was of the greatest moment if chemistry were to advance. His fame rests upon his exposition of the principles necessary to chemistry as a science, but of his contributions to analytical inorganic chemistry little can be said. He applied himself more particularly to the oxygen compounds, and determined with a fair degree of accuracy the ratio of carbon to oxygen in carbon dioxide, but his values for the ratio of hydrogen to oxygen in water, and of phosphorus to oxygen in phosphoric acid, are only approximate; he introduced no new methods either for the estimation or separation of the metals. The next advance was made by Joseph Louis Proust, whose investigations led to a clear grasp of the law of constant proportions. The formulation of the atomic theory by John Dalton gave a fresh impetus to the development of quantitative analysis; and the determination of combining or equivalent weights by Berzelius led to the perfecting of the methods of gravimetric analysis. Experimental conditions were thoroughly worked out; the necessity of working with hot or cold solutions was clearly emphasized; and the employment of small quantities of substances instead of the large amounts recommended by Klaproth was shown by him to give more consistent results.

Since the time of Berzelius many experimenters have entered the lists, and introduced developments which we have not space to mention. We may, however, notice Heinrich Rose¹ and Friedrich Wöhler,² who, having worked up the results of their teacher Berzelius, and combined them with their own valuable observations, exerted great influence on the progress of analytical chemistry by publishing works which contained admirable accounts of the then known methods of analysis. To K. R. Fresenius, the founder of the *Zeitschrift für analytische Chemie* (1862), we are particularly indebted for perfecting and systematizing the various methods of analytical chemistry. By strengthening the older methods, and devising new ones, he exerted an influence which can never be overestimated. His text-books on the subject, of which the *Qualitative* appeared in 1841, and the *Quantitative* in 1846, have a world-wide reputation, and have passed through several editions.

The quantitative precipitation of metals by the electric current, although known to Michael Faraday, was not applied to analytical chemistry until O. Wolcott Gibbs worked out the electrolytic separation of copper in 1865. Since then the subject has been extensively studied, more particularly by Alexander Classen, who has summarized the methods and results in his *Quantitative Chemical Analysis by Electrolysis* (1903). The ever-increasing importance of the electric current in metallurgy and chemical manufactures is making this method of great importance, and in some cases it has partially, if not wholly, superseded the older methods.

Volumetric analysis, possessing as it does many advantages over the gravimetric methods, has of late years been extensively developed. Gay Lussac may be regarded as the founder of the method, although rough applications had been previously made by F. A. H. Descroizilles and L. N. Vauquelin. Chlorimetry (1824), alkalimetry (1828), and the volumetric determination of silver and chlorine (1832) were worked out by Gay Lussac; but although the advantages of the method were patent, it received recognition very slowly. The application of potassium permanganate to the estimation of iron by E. Margueritte in 1846,

¹ H. Rose, *Ausführliches Handbuch der analytischen Chemie* (1851).

² F. Wöhler, *Die Mineralanalyse in Beispielen* (1861).

and of iodine and sulphurous acid to the estimation of copper and many other substances by Robert Wilhelm Bunsen, marks an epoch in the early history of volumetric analysis. Since then it has been rapidly developed, particularly by Karl Friedrich Mohr and J. Volhard, and these methods rank side by side in value with the older and more tedious gravimetric methods.

The detection of carbon and hydrogen in organic compounds by the formation of carbon dioxide and water when they are burned was first correctly understood by Lavoisier, and as he had determined the carbon and hydrogen content of these two substances he was able to devise methods by which carbon and hydrogen in organic compounds could be estimated. In his earlier experiments he burned the substance in a known volume of oxygen, and by measuring the residual gas determined the carbon and hydrogen. For substances of a difficultly combustible nature he adopted the method in common use to-day, viz. to mix the substance with an oxidizing agent—mercuric oxide, lead dioxide, and afterwards copper oxide—and absorb the carbon dioxide in potash solution. This method has been improved, especially by Justus v. Liebig; and certain others based on a different procedure have been suggested. The estimation of nitrogen was first worked out in 1830 by Jean Baptiste Dumas, and different processes have been proposed by Will and F. Varrentrapp, J. Kjeldahl and others. Methods for the estimation of the halogens and sulphur were worked out by L. Carius (see below, § *Organic Analysis*).

Only a reference can be made in this summary to the many fields in which analytical chemistry has been developed. Progress in forensic chemistry was only possible after the reactions of poisons had been systematized; a subject which has been worked out by many investigators, of whom we notice K. R. Fresenius, J. and R. Otto, and J. S. Stas. Industrial chemistry makes many claims upon the chemist, for it is necessary to determine the purity of a product before it can be valued. This has led to the estimation of sugar by means of the polarimeter, and of the calorific power of fuels, and the valuation of ores and metals, of coal-tar dyes, and almost all trade products.

The passing of the Food and Drug Acts (1875–1899) in England, and the existence of similar adulteration acts in other countries, have occasioned great progress in the analysis of foods, drugs, &c. For further information on this branch of analytical chemistry, see ADULTERATION.

There exists no branch of technical chemistry, hygiene or pharmacy from which the analytical chemist can be spared, since it is only by a continual development of his art that we can hope to be certain of the purity of any preparation. In England this branch of chemistry is especially cared for by the Institute of Chemistry, which, since its foundation in 1877, has done much for the training of analytical chemists.

In the preceding sketch we have given a necessarily brief account of the historical development of analytical chemistry in its main branches. We shall now treat the different methods in more detail. It must be mentioned here that the reactions of any particular substance are given under its own heading, and in this article we shall only collate the various operations and outline the general procedure. The limits of space prevent any systematic account of the separation of the rare metals, the alkaloids, and other classes of organic compounds, but sources where these matters may be found are given in the list of references.

Qualitative Inorganic Analysis.

The dry examination of a substance comprises several operations, which may yield definite results if no disturbing element is present; but it is imperative that any interference should be confirmed by other methods.

Dry methods.

1. Heat the substance in a hard glass tube. Note whether any moisture condenses on the cooler parts of the tube, a gas is evolved, a sublimate formed, or the substance changes colour.

Moisture is evolved from substances containing water of crystallization or decomposed hydrates. If it possesses an alkaline or acid reaction, it must be tested in the first case for ammonia, and in the second case for a volatile acid, such as sulphuric, nitric, hydrochloric, &c.

Any evolved gas must be examined. Oxygen, recognized by its power of igniting a glowing splinter, results from the decomposition of oxides of the noble metals, peroxides, chlorates, nitrates and other highly oxygenized salts. Sulphur dioxide, recognized by its smell and acid reaction, results from the ignition of certain sulphites, sulphates, or a mixture of a sulphate with a sulphide. Nitrogen oxides, recognized by their odour and brown-red colour, result from the decomposition of nitrates. Carbon dioxide, recognized by turning lime-water milky, indicates decomposable carbonates or oxalates. Chlorine, bromine, and iodine, each recognizable by its colour and odour, result from decomposable haloids; iodine forms also a black sublimate. Cyanogen and hydrocyanic acid, recognizable by their odour, indicate decomposable cyanides. Sulphuretted hydrogen, recognized by its odour, results from sulphides containing water, and hydrosulphides. Ammonia, recognizable by its odour and alkaline reaction, indicates ammoniacal salts or cyanides containing water.

A sublimate may be formed of: sulphur—reddish-brown drops, cooling to a yellow to brown solid, from sulphides or mixtures; iodine—violet vapour, black sublimate, from iodides, iodic acid, or mixtures; mercury and its compounds—metallic mercury forms minute globules, mercuric sulphide is black and becomes red on rubbing, mercuric chloride fuses before subliming, mercurous chloride does not fuse, mercuric iodide gives a yellow sublimate; arsenic and its compounds—metallic arsenic gives a grey mirror, arsenious oxide forms white shining crystals, arsenic sulphides give reddish-yellow sublimate which turn yellow on cooling; antimony oxide fuses and gives a yellow acicular sublimate; lead chloride forms a white sublimate after long and intense heating.

If the substance does not melt but changes colour, we may have present: zinc oxide—from white to yellow, becoming white on cooling; stannic oxide—white to yellowish brown, dirty white on cooling; lead oxide—from white or yellowish-red to brownish-red, yellow on cooling; bismuth oxide—from white or pale yellow to orange-yellow or reddish-brown, pale yellow on cooling; manganese oxide—from white or yellowish white to dark brown, remaining dark brown on cooling (if it changes on cooling to a bright reddish-brown, it indicates cadmium oxide); copper oxide—from bright blue or green to black; ferrous oxide—from greyish-white to black; ferric oxide—from brownish-red to black, brownish-red on cooling; potassium chromate—yellow to dark orange, fusing at a red heat.

2. Heat the substance on a piece of charcoal in the reducing flame of the blowpipe.

(a) The substance may fuse and be absorbed by the charcoal; this indicates more particularly the alkaline metals.

(b) An infusible white residue may be obtained, which may denote barium, strontium, calcium, magnesium, aluminium or zinc. The first three give characteristic flame colorations (see below); the last three, when moistened with cobalt nitrate and re-ignited, give coloured masses; aluminium (or silica) gives a brilliant blue; zinc gives a green; whilst magnesium phosphates or arsenate (and to a less degree the phosphates of the alkaline earths) give a violet mass.

A metallic globule with or without an incrustation may be obtained. Gold and copper salts give a metallic bead without an incrustation. If the incrustation be white and readily volatile, arsenic is present, if more difficultly volatile and beads are present, antimony; zinc gives an incrustation yellow whilst hot, white on cooling, and volatilized with difficulty; tin gives a pale yellow incrustation, which becomes white on cooling, and does not volatilize in either the reducing or oxidizing flames; lead gives a lemon-yellow incrustation turning sulphur-yellow on cooling, together with metallic malleable beads; bismuth gives metallic globules and a dark orange-yellow incrustation, which becomes lemon-yellow on cooling; cadmium gives a reddish-brown incrustation, which is removed without leaving a gleam by heating in the reducing flame; silver gives white metallic globules and a dark-red incrustation.

3. Heat the substance with a bead of microcosmic salt or borax on a platinum wire in the oxidizing flame.

(a) The substance dissolves readily and in quantity, forming a bead which is clear when hot. If the bead is coloured we may have present: cobalt, blue to violet; copper, green, blue on cooling; in the reducing flame, red when cold; chromium, green, unaltered in the reducing flame; iron, brownish-red, light-yellow or colourless on cooling; in the reducing flame, red while hot, yellow on cooling, greenish when cold; nickel, reddish to brownish-red, yellow to reddish-yellow or colourless on cooling, unaltered in the reducing flame; bismuth, yellowish-brown, light-yellow or colourless on cooling; in the reducing flame, almost colourless, blackish-grey when cold; silver, light yellowish to opal, somewhat opaque when cold; whitish-grey in the reducing flame; manganese, amethyst red, colourless in the reducing flame. If the hot bead is colourless and remains clear on cooling, we may suspect the presence of antimony, aluminium, zinc, cadmium, lead, calcium and magnesium. When present in sufficient quantity the five last-named give enamel-white beads; lead oxide in excess gives a yellowish bead. If the hot colourless bead becomes enamel-white on cooling even when minute quantities of the substances are employed, we may infer the presence of barium or strontium.

(b) The substance dissolves slowly and in small quantity, and forms a colourless bead which remains so on cooling. Either silica or tin may be present. If silica be present, it gives the iron bead when heated with a little ferric oxide; if tin is present there is no change. Certain substances, such as the precious metals, are quite insoluble in the bead, but float about in it.

4. Hold a small portion of the substance moistened with hydrochloric acid on a clean platinum wire in the fusion zone of the Bunsen burner, and note any colour imparted to the flame.

Potassium gives a blue-violet flame which may be masked by the colorations due to sodium, calcium and other elements. By viewing the flame through an indigo prism it appears sky-blue, violet and ultimately crimson, as the thickness of the prism is increased. Other elements do not interfere with this method. Sodium gives an intense and persistent yellow flame; lithium gives a carmine coloration, and may be identified in the presence of sodium by viewing through a cobalt glass or indigo prism; from potassium it may be distinguished by its redder colour; barium gives a yellowish-green flame, which appears bluish-green when viewed through green glass; strontium gives a crimson flame which appears purple or rose when viewed through blue glass; calcium gives an orange-red colour which appears finch-green through green glass; indium gives a characteristic bluish-violet flame; copper gives an intense emerald-green coloration.

5. *Film Reactions.*—These reactions are practised in the following manner:—A thread of asbestos is moistened and then dipped in the substance to be tested; it is then placed in the luminous point of the Bunsen flame, and a small porcelain basin containing cold water placed immediately over the asbestos. The formation of a film is noted. The operation is repeated with the thread in the oxidizing flame.

Any film formed in the first case is metallic, in the second it is the oxide. The metallic film is tested with 20% nitric acid and with bleaching-powder solution. Arsenic is insoluble in the acid, but immediately dissolves in the bleaching-powder. The black films of antimony and bismuth and the grey mottled film of mercury are slowly soluble in the acid, and untouched by bleaching-powder. The black films of tin, lead and cadmium dissolve at once in the acid, the lead film being also soluble in bleaching-powder. The oxide films of antimony, arsenic, tin and bismuth are white, that of bismuth slightly yellowish; lead yields a very pale yellow film, and cadmium a brown one; mercury yields no oxide film. The oxide films (the metallic one in the case of mercury) are tested with hydriodic acid, and with ammonium sulphide, and from the changes produced the film can be determined (see F. M. Perkin, *Qualitative Chemical Analysis*, 1905).

Having completed the dry analysis we may now pass on to the *wet* and more accurate investigation. It is first necessary to get the substance into solution. Small portions should be successively tested with water, dilute hydrochloric acid, dilute nitric acid, strong hydrochloric acid, and a mixture of hydrochloric and nitric acids, first in the cold and then with warming. Certain substances are insoluble in all these reagents, and other methods, such as the fusion with sodium carbonate and potassium nitrate, and subsequent treatment with an acid, must be employed. Some of these insoluble compounds can be detected by their colour and particular reactions. For further information on this subject, we refer the readers to Fresenius's *Qualitative Analysis*.

The procedure for the detection of metals in solution consists of first separating them into groups and then examining each group separately. For this purpose the cold solution is treated with hydrochloric acid, which precipitates lead, silver and mercurous salts as chlorides. The solution is filtered and treated with an excess of sulphuretted hydrogen, either in solution or by passing in the gas; this precipitates mercury (mercuric), any lead left over from the first group, copper, bismuth, cadmium, arsenic, antimony and tin as sulphides. The solution is filtered off, boiled till free of sulphuretted hydrogen, and ammonium chloride and ammonia added. If phosphoric acid is absent, aluminium, chromium and ferric hydrates are precipitated. If, however, phosphoric acid is present in the original substance, we may here obtain a precipitate of the phosphates of the remaining metals, together with aluminium, chromium and ferric hydrates. In this case, the precipitate is dissolved in as little as possible hydrochloric acid and boiled with ammonium acetate, acetic acid and ferric chloride. The phosphates of aluminium, chromium and iron are precipitated, and the solution contains the same metals as if phosphoric acid had been absent. To the filtrate from the aluminium, iron and chromium precipitate, ammonia and ammonium sulphide are added; the precipitate may contain nickel, cobalt, zinc and manganese sulphides. Ammonium carbonate is added to the filtrate; this precipitates calcium, strontium and

barium. The solution contains magnesium, sodium and potassium, which are separately distinguished by the methods given under their own headings.

We now proceed with the examination of the various group precipitates. The white precipitate formed by cold hydrochloric acid is boiled with water, and the solution filtered while hot. Any lead chloride dissolves, and may be identified by the yellow precipitate formed with potassium chromate. To the residue add ammonia, shake, then filter. Silver chloride goes into solution, and may be precipitated by dilute nitric acid. The residue, which is black in colour, consists of mercurous-ammonium chloride, in which mercury can be confirmed by its ordinary tests.

The precipitate formed by sulphuretted hydrogen may contain the black mercuric, lead, and copper sulphides, dark-brown bismuth sulphide, yellow cadmium and arsenious sulphides, orange-red antimony sulphide, brown stannous sulphide, dull-yellow stannic sulphide, and whitish sulphur, the last resulting from the oxidation of sulphuretted hydrogen by ferric salts, chromates, &c. Warming with ammonium sulphide dissolves out the arsenic, antimony and tin salts, which are reprecipitated by the addition of hydrochloric acid to the ammonium sulphide solution. The precipitate is shaken with ammonium carbonate, which dissolves the arsenic. Filter and confirm arsenic in the solution by its particular tests. Dissolve the residue in hydrochloric acid and test separately for antimony and tin. The residue from the ammonium sulphide solution is warmed with dilute nitric acid. Any residue consists of black mercuric sulphide (and possibly white lead sulphate), in which mercury is confirmed by its usual tests. The solution is evaporated with a little sulphuric acid and well cooled. The white precipitate consists of lead sulphate. To the filtrate add ammonia in excess: a white precipitate indicates bismuth; if the solution be blue, copper is present. Filter from the bismuth hydrate, and if copper is present, add potassium cyanide till the colour is destroyed, then pass sulphuretted hydrogen, and cadmium is precipitated as the yellow sulphide. If copper is absent, then sulphuretted hydrogen can be passed directly into the solution.

The next group precipitate may contain the white gelatinous aluminium hydroxide, the greenish chromium hydroxide, reddish ferric hydroxide, and possibly zinc and manganese hydroxides. Treatment with caustic soda dissolves out aluminium hydroxide, which is reprecipitated by the addition of ammonium chloride. The remaining metals are tested for separately.

The next group may contain black nickel and cobalt sulphides, flesh-coloured manganese sulphide, and white zinc sulphide. The last two are dissolved out by cold, very dilute hydrochloric acid, and the residue is tested for nickel and cobalt. The solution is boiled till free from sulphuretted hydrogen and treated with excess of sodium hydrate. A white precipitate rapidly turning brown indicates manganese. The solution with ammonium sulphide gives a white precipitate of zinc sulphide.

The next group may contain the white calcium, barium and strontium carbonates. The flame coloration (see above) may give information as to which elements are present. The carbonates are dissolved in hydrochloric acid, and calcium sulphate solution is added to a portion of the solution. An immediate precipitate indicates barium; a precipitate on standing indicates strontium. If barium is present, the solution of the carbonates in hydrochloric acid is evaporated and digested with strong alcohol for some time; barium chloride, which is nearly insoluble in alcohol, is thus separated, the remainder being precipitated by a few drops of hydrofluosilicic acid, and may be confirmed by the ordinary tests. The solution free from barium is treated with ammonia and ammonium sulphate, which precipitates strontium, and the calcium in the solution may be identified by the white precipitate with ammonium oxalate.

Having determined the bases, it remains to determine the acid radicals. There is no general procedure for these operations, and it is customary to test for the acids separately by special tests; these are given in the articles on the various acids. A knowledge of the solubility of salts considerably reduces the number of acids likely to be present, and affords evidence of great value to the analyst (see A. M. Comey, *Dictionary of Chemical Solubilities*). In the above account we have indicated the procedure adopted in the analysis of a complex mixture of salts. It is unnecessary here to dwell on the precautions which can only be conveniently acquired by experience; a sound appreciation of analytical methods is only possible after the reactions and characters of individual substances have been studied, and we therefore refer the reader to the articles on the particular elements and compounds for more information on this subject.

Quantitative Inorganic Analysis.

Quantitative methods are divided into four groups, which we now pass on to consider in the following sequence: (a) gravimetric, (β) volumetric, (γ) electrolytic, (δ) colorimetric.

(a) *Gravimetric*.—This method is made up of four operations: (1) a weighed quantity of the substance is dissolved in a suitable solvent; (2) a particular reagent is added which precipitates the substance it is desired to estimate; (3) the precipitate is filtered, washed and dried; (4) the filter paper containing the precipitate is weighed either as a *tared* filter, or incinerated and ignited either in air or in any other gas, and then weighed.

(1) Accurate weighing is all-important; for details of the various appliances and methods see WEIGHING MACHINES. (2) No general directions can be given as to the method of precipitation. Sometimes it is necessary to allow the solution to stand for a considerable time either in the warm or cold or in the light or dark; to work with cold solutions and then boil; or to use boiling solutions of both the substance and reagent. Details will be found in the articles on particular metals. (3) The operation of filtration and washing is very important. If the substance to be weighed changes in composition on strong heating, it is necessary to employ a *tared* filter, *i.e.* a filter paper which has been previously heated to the temperature at which the substance is to be dried until its weight is constant. If the precipitate settles readily, the supernatant liquor may be decanted through the filter paper, more water added to the precipitate and again decanted. By this means most of the washing, *i.e.* freeing from the other substances in the solution, can be accomplished in the precipitating vessel. If, however, the precipitate refuses to settle, it is directly transferred to the filter paper, the last traces being removed by washing and rubbing the sides of the vessel with a piece of rubber, and the liquid is allowed to drain through. It is washed by ejecting a jet of water, ammonia or other prescribed liquid on to the side of the filter paper until the paper is nearly full. It can be shown that a more efficient washing results from alternately filling and emptying the funnel than by endeavouring to keep the funnel full. The washing is continued until the filtrate is free from salts or acids. (4) After washing, the funnel containing the filter paper is transferred to a drying oven. In the case of a *tared* filter it is weighed repeatedly until the weight suffers no change; then knowing the weight of the filter paper, the weight of the precipitate is obtained by subtraction. If the precipitate may be ignited, it is transferred to a clean, weighed and recently ignited crucible, and the filter paper is burned *separately* on the lid, the ash transferred to the crucible, and the whole ignited. After ignition, it is allowed to cool in a desiccator and then weighed. Knowing the weight of the crucible and of the ash of the filter paper, the weight of the precipitate is determined. The calculation of the percentage of the particular constituent is simple. We know the amount present in the precipitate, and since the same amount is present in the quantity of substance experimented with, we have only to work out a sum in proportion.

(β) *Volumetric*.—This method is made up of three operations:—(1) preparation of a *standard* solution; (2) preparation of a solution of the substance; (3) *titration*, or the determination of what volume of the standard solution will occasion a known and definite reaction with a known volume of the test solution.

(1) In general analytical work the standard solution contains the equivalent weight of the substance in grammes dissolved in a litre of water. Such a solution is known as *normal*. Thus a normal solution of sodium carbonate contains 53 grammes per litre, of sodium hydrate 40 grammes, of hydrochloric acid 36.5 grammes, and so on. By taking $\frac{1}{10}$ th or $\frac{1}{100}$ th of these quantities, *decinormal* or *centinormal* solutions are obtained. We see therefore that 1 cubic centimetre of a normal sodium carbonate solution will exactly neutralize 0.049 gramme of sulphuric acid, 0.0365 gramme of hydrochloric acid (*i.e.* the equivalent quantities), and similarly for decinormal and centinormal solutions. Unfortunately, the term *normal* is sometimes given to solutions which are strictly decinormal; for example, iodine, sodium thiosulphate, &c. In technical analysis, where a solution is used for one process only, it may be prepared so that 1 cc. is equal to .01 gramme of the substance to be estimated. This saves a certain amount of arithmetic, but when the solution is applied in another determination additional calculations are necessary. Standard solutions are prepared by weighing out the exact amount of the pure substance and dissolving it in water, or by forming a solution of approximate normality, determining its exact strength by gravimetric or other means, and then correcting it for any divergence. This may be exemplified in the case of alkalimetry. Pure sodium carbonate is prepared by igniting the bicarbonate, and exactly 53 grammes are dissolved in water, forming a strictly normal solution. An approximate normal sulphuric acid is prepared from 30 ccs. of the pure acid (1.84 specific gravity) diluted to 1 litre. The solutions are titrated (see below) and the acid solution diluted until equal volumes are exactly equivalent. A standard sodium hydrate solution can be prepared by dissolving 42 grammes of sodium hydrate, making up to a litre, and diluting until one cubic centimetre is exactly equivalent to one cubic centimetre of the sulphuric acid. Similarly, normal solutions of hydrochloric and nitric acids can be prepared. Where a solution is likely to change in composition on keeping, such as potassium permanganate, iodine,

sodium hydrate, &c., it is necessary to check or re-standardize it periodically.

(2) The preparation of the solution of the substance consists in dissolving an accurately determined weight, and making up the volume in a graduated cylinder or flask to a known volume.

(3) The titration is conducted by running the standard solution from a burette into a known volume of the test solution, which is usually transferred from the stock-bottle to a beaker or basin by means of a pipette. Various artifices are employed to denote the end of the reaction. These may be divided into two groups: (1) those in which a change in appearance of the reacting mixture occurs; (2) those in which it is necessary to use an indicator which, by its change in appearance, shows that an excess of one reagent is present. In the first group, we have to notice the titration of a cyanide with silver nitrate, when a milkiness shows how far the reaction has gone; the titration of iron with permanganate, when the faint pink colour shows that all the iron is oxidized. In the second group, we may notice the application of litmus, methyl orange or phenolphthalein in alkalimetry, when the acid or alkaline character of the solution commands the colour which it exhibits; starch paste, which forms a blue compound with free iodine in iodometry; potassium chromate, which forms red silver chromate after all the hydrochloric acid is precipitated in solutions of chlorides; and in the estimation of ferric compounds by potassium bichromate, the indicator, potassium ferricyanide, is placed in drops on a porcelain plate, and the end of the reaction is shown by the absence of a blue coloration when a drop of the test solution is brought into contact with it.

(γ) *Electrolytic*.—This method consists in decomposing a solution of a salt of the metal by the electric current and weighing the metal deposited at the cathode.

It is only by paying great attention to the current density that good results are obtained, since metals other than that sought for may be deposited. In acid copper solutions, mercury is deposited before the copper with which it subsequently amalgamates; silver is thrown down simultaneously; bismuth appears towards the end; and after all the copper has been precipitated, arsenic and antimony may be deposited. Lead and manganese are partially separated as peroxides, but the remaining metals are not deposited from acid solutions. It is therefore necessary that the solution should be free from metals which may vitiate the results, or special precautions taken by which the impurities are rendered harmless. In such cases the simplicity of manipulation and the high degree of accuracy of the method have made it especially valuable. The electrolysis is generally conducted with platinum electrodes, of which the cathode takes the form of a piece of foil bent into a cylindrical form, the necessary current being generated by one or more Daniell cells.

(δ) *Colorimetric*.—This method is adopted when it is necessary to determine minute traces (as in the liquid obtained in the electrolytic separation of copper) of substances which afford well-defined colour reactions.

The general procedure is to make a series of standard solutions containing definite quantities of the substance which it is desired to estimate; such a series will exhibit tints which deepen as the quantity of the substance is increased. A known weight of the test substance is dissolved and a portion of the solution is placed in a tube similar to those containing the standard solutions. The colour-producing reagent is added and the tints compared. In the case of copper, the colour reactions with potassium ferrocyanide or ammonia are usually employed; traces of ammonia are estimated with *Nessler's reagent*; sulphur in iron and steel is determined by the tint assumed by a silver-copper plate suspended in the gases liberated when the metal is dissolved in sulphuric acid (Eggertz's test) (see W. Crookes, *Select Methods in Analytical Chemistry*).

Organic Analysis.

The elements which play important parts in organic compounds are carbon, hydrogen, nitrogen, chlorine, bromine, iodine, sulphur, phosphorus and oxygen. We shall here consider the qualitative and quantitative determination of these elements.

Qualitative.—Carbon is detected by the formation of carbon dioxide, which turns lime-water milky, and hydrogen by the formation of water, which condenses on the tube, when the substance is heated with copper oxide. Nitrogen may be detected by the evolution of ammonia when the substance is heated with soda-lime. A more delicate method is that due to J. L. Lassaigne and improved by O. Jacobsen and C. Graebe. The substance is heated with metallic sodium or potassium (in excess if sulphur be present) to redness, the residue treated with water, filtered, and ferrous sulphate, ferric chloride and hydrochloric acid added. A blue coloration indicates nitrogen, and is due to the formation of potassium (or sodium) cyanide during the fusion, and subsequent interaction with the iron salts. The halogens may be sometimes detected by fusing with lime, and testing the solution for a bromide, chloride and iodide in the usual way. F. Beilstein determines their presence by heating the substance with pure copper oxide on a platinum wire in the Bunsen flame; a green coloration is observed if halogens be present. Sulphur is detected by heating the substance with

sodium, dissolving the product in water, and adding sodium nitroprusside; a bluish-violet coloration indicates sulphur (H. Vohl). Or we may use J. Horbaczewski's method, which consists in boiling the substance with strong potash, saturating the cold solution with chlorine, adding hydrochloric acid, and boiling till no more chlorine is liberated, and then testing for sulphuric acid with barium chloride. Phosphorus is obtained as a soluble phosphate (which can be examined in the usual way) by lixiviating the product obtained when the substance is ignited with potassium nitrate and carbonate.

Quantitative.—Carbon and hydrogen are generally estimated by the *combustion* process, which consists in oxidizing the substance and absorbing the products of combustion in suitable *Carbon and hydrogen* apparatus. The oxidizing agent in commonest use is copper oxide, which must be freshly ignited before use on account of its hygroscopic nature. Lead chromate is sometimes used, and many other substances, such as platinum, manganese dioxide, &c., have been suggested. The procedure for a combustion is as follows:—

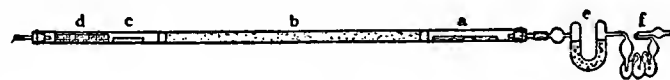

FIG. 1.

A hard glass tube slightly longer than the furnace and 12 to 15 mm. in diameter is thoroughly cleansed and packed as shown in fig. 1. The space *a* must allow for the inclusion of a copper spiral if the substance contains nitrogen, and a silver spiral if halogens be present, for otherwise nitrogen oxides and the halogens may be condensed in the absorption apparatus; *b* contains copper oxide; *c* is a space for the insertion of a porcelain or platinum boat containing a weighed quantity of the substance; *d* is a copper spiral. The end *d* is connected to an air or oxygen supply with an intermediate drying apparatus. The other end is connected with the absorption vessels, which consist of a tube (*e*) containing calcium chloride, and a set of bulbs (*f*) containing potash solution. Various forms of potash bulbs are employed; fig. 2 is Liebig's, fig. 3 Mohr's or Geissler's, fig. 4 is a more recent form, of which special variations have been

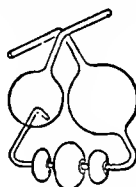

FIG. 2.

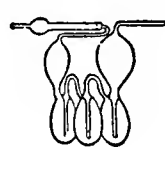

FIG. 3.

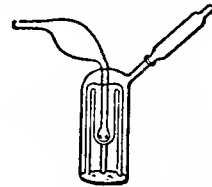

FIG. 4.

made by Anderson, Gomberg, Delisle and others. After having previously roasted the tube and copper oxide, and reduced the copper spiral *a*, the weighed calcium chloride tube and potash bulbs are put in position, the boat containing the substance is inserted (in the case of a difficultly combustible substance it is desirable to mix it with cupric oxide or lead chromate), the copper spiral (*d*) replaced, and the air and oxygen supply connected up. The apparatus is then tested for leaks. If all the connexions are sound, the copper oxide is gradually heated from the end *a*, the gas-jets under the spiral *d* are lighted, and a slow current of oxygen is passed through the tube. The success of the operation depends upon the slow burning of the substance. Towards the end the heat and the oxygen supply are increased. When there is no more absorption in the potash bulbs, the oxygen supply is cut off and air passed through. Having replaced the oxygen in the absorption vessels by air, they are disconnected and weighed, after having cooled down to the temperature of the room. The increase in weight of the calcium chloride tube gives the weight of water formed, and of the potash bulbs the carbon dioxide.

Liquids are amenable to the same treatment, but especial care must be taken so that they volatilize slowly. Difficultly volatile liquids may be weighed directly into the boat; volatile liquids are weighed in thin hermetically sealed bulbs, the necks of which are broken just before they are placed in the combustion tube.

The length of time and other disadvantages attending the combustion method have caused investigators to devise other processes. In 1855 C. Brunner described a method for oxidizing the carbon to carbon dioxide, which could be estimated by the usual methods, by heating the substance with potassium bichromate and sulphuric acid. This process has been considerably developed by J. Messinger, and we may hope that with subsequent improvements it may be adapted to all classes of organic compounds. The oxidation, which is effected by chromic acid and sulphuric acid, is conducted in a flask provided with a funnel and escape tube, and the carbon dioxide formed is swept by a current of dry air, previously freed from carbon dioxide, through a drying tube to a set of potash bulbs and a tube containing soda-lime; if halogens are present, a small wash bottle containing potassium iodide, and a U tube containing glass wool moistened with silver nitrate on one side and strong sulphuric acid on the other, must be inserted between the flask and the drying tube. The increase in weight of the potash bulbs and soda-lime tube gives

the weight of carbon dioxide evolved. C. F. Cross and E. J. Bevan collected the carbon dioxide obtained in this way over mercury. They also showed that carbon monoxide was given off towards the end of the reaction, and oxygen was not evolved unless the temperature exceeded 100°.

Methods depending upon oxidation in the presence of a contact substance have come into favour during recent years. In that of M. Dennstedt, which was first proposed in 1902, the substance is vaporized in a tube containing at one end platinum foil, platinized quartz, or platinized asbestos. The platinum is maintained at a bright red heat, either by a gas flame or by an electric furnace, and the vapour is passed over it by leading in a current of oxygen. If nitrogen be present, a boat containing dry lead peroxide and heated to 320° is inserted, the oxide decomposing any nitrogen peroxide which may be formed. The same absorbent quantitatively takes up any halogen and sulphur which may be present. The process is therefore adapted to the simultaneous estimation of carbon, hydrogen, the halogens and sulphur.

Nitrogen is estimated by (1) Dumas' method, which consists in heating the substance with copper oxide and measuring the volume of nitrogen liberated; (2) by Will and Varrentrapp's method, in which the substance is heated with soda-lime, and the ammonia evolved is absorbed in hydrochloric acid, and thence precipitated as ammonium chlorplatinate or estimated volumetrically; or (3) by Kjeldahl's method, in which the substance is dissolved in concentrated sulphuric acid, potassium permanganate added, the liquid diluted and boiled with caustic soda, and the evolved ammonia absorbed in hydrochloric acid and estimated as in Will and Varrentrapp's method.

Dumas' Method.—In this method the operation is carried out in a hard glass tube sealed at one end and packed as shown in fig. 5. The magnesite (*a*) serves for the generation of carbon dioxide which clears the tube of air before the compound (mixed with fine copper oxide (*b*)) is burned, and afterwards sweeps the liberated nitrogen into the receiving vessel (*e*), which contains a strong potash solution; *c* is coarse copper oxide; and *d* a reduced copper gauze spiral, heated in order to decompose any nitrogen oxides. Ulrich Kreusler generates the carbon dioxide in a separate apparatus, and in this case the tube is drawn out to a capillary at the end (*a*). This artifice is specially valuable when the substance decomposes or volatilizes in a warm current of carbon dioxide. Various forms of the absorbing apparatus (*e*) have been discussed by M. Ilinski (*Ber.* 17, p. 1347), who has also suggested the use of manganese carbonate instead of magnesite, since the change of colour enables one to follow the decomposi-

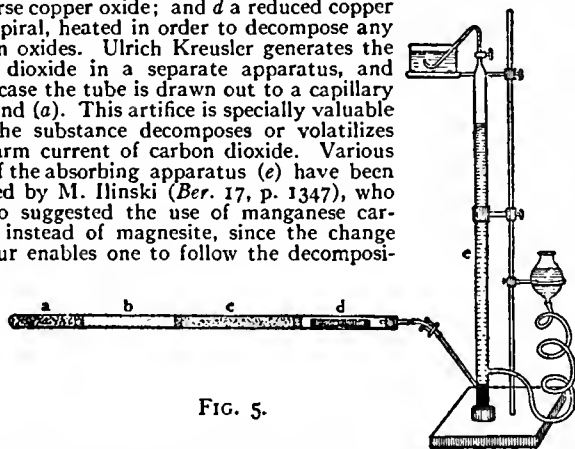

FIG. 5.

tion. Substances which burn with difficulty may be mixed with mercuric oxide in addition to copper oxide.

Will and Varrentrapp's Method.—This method, as originally proposed, is not in common use, but has been superseded by Kjeldahl's method, since the nitrogen generally comes out too low. It is susceptible of wider application by mixing reducing agents with the soda-lime; thus Goldberg (*Ber.* 16, p. 2546) uses a mixture of soda-lime, stannous chloride and sulphur for nitro- and azo-compounds, and C. Arnold (*Ber.* 18, p. 806) a mixture containing sodium hyposulphite and sodium formate for nitrates.

Kjeldahl's Method.—This method rapidly came into favour on account of its simplicity, both of operation and apparatus. Various substances other than potassium permanganate have been suggested for facilitating the operation; J. W. Gunning (*Z. anal. Chem.*, 1889, p. 189) uses potassium sulphate; Lassar-Cohn uses mercuric oxide. The applicability of the process has been examined by F. W. Dafert (*Z. anal. Chem.*, 1888, p. 224), who has divided nitrogenous bodies into two classes with respect to it. The first class includes those substances which require no preliminary treatment, and comprises the amides and ammonium compounds, pyridines, quinolines, alkaloids, albumens and related bodies; the second class requires preliminary treatment and comprises, with few exceptions, the nitro-, nitroso-, azo- and amidoazo-compounds, hydrazines, derivatives of nitric and nitrous acids, and probably cyanogen compounds. Other improvements have been suggested by Dyer (*J.C.S. Trans.* 67, p. 811). For an experimental comparison of the accuracy of the Dumas, Will-Varrentrapp and Kjeldahl processes see L. L'Hôte, *C.R.* 1889, p. 817. Debordeaux (*C.R.* 1904, p. 905) has obtained good results by distilling the substance with a mixture of potassium thiosulphate and sulphide.

The halogens may be estimated by ignition with quicklime, or by heating with nitric acid and silver nitrate in a sealed tube. In the

first method the substance, mixed with quicklime free from chlorine, is heated in a tube closed at one end in a combustion furnace. The product is dissolved in water, and the calcium haloid estimated in the usual way. The same decomposition may be effected by igniting with iron, ferric oxide and sodium carbonate (E. Kopp, *Ber.* 10, p. 290); the operation is easier if the lime be mixed with sodium carbonate, or a mixture of sodium carbonate and potassium nitrate be used. With iodine compounds, iodic acid is likely to be formed, and hence the solution must be reduced with sulphurous acid before precipitation with silver nitrate. C. Zulkowsky (*Ber.* 18, R. 648) burns the substance in oxygen, conducts the gases over platinized sand, and collects the products in suitable receivers. The oxidation with nitric acid in sealed tubes at a temperature of 150° to 200° for aliphatic compounds, and 250° to 260° for aromatic compounds, is in common use, for both the sulphur and phosphorus can be estimated, the former being oxidized to sulphuric acid and the latter to phosphoric acid. This method was due to L. Carius (*Ann.* 136, p. 129). R. Klason (*Ber.* 19, p. 1910) determines sulphur and the halogens by oxidizing the substance in a current of oxygen and nitrous fumes, conducting the vapours over platinum foil, and absorbing the vapours in suitable receivers. Sulphur and phosphorus can sometimes be estimated by Messinger's method, in which the oxidation is effected by potassium permanganate and caustic alkali, or by potassium bichromate and hydrochloric acid. A comparison of the various methods for estimating sulphur has been given by O. Hammarsten (*Zeit. physiol. Chem.* 9, p. 273), and by Höland (*Chemiker Zeitung*, 1893, p. 991). H. H. Pringsheim (*Ber.* 38, p. 1434) has devised a method in which the oxidation is effected by sodium peroxide; the halogens, phosphorus and sulphur can be determined by one operation.

VI. PHYSICAL CHEMISTRY

We have seen how chemistry may be regarded as having for its province the investigation of the composition of matter, and the changes in composition which matter or energy may effect on matter, while physics is concerned with the general properties of matter. A physicist, however, does more than merely quantitatively determine specific properties of matter; he endeavours to establish mathematical laws which co-ordinate his observations, and in many cases the equations expressing such laws contain functions or terms which pertain solely to the chemical composition of matter. One example will suffice here. The limiting law expressing the behaviour of gases under varying temperature and pressure assumes the form $pv=RT$; so stated, this law is independent of chemical composition and may be regarded as a true physical law, just as much as the law of universal gravitation is a true law of physics. But this relation is not rigorously true; in fact, it does not accurately express the behaviour of any gas. A more accurate expression (see CONDENSATION OF GASES AND MOLECULE) is $(p+a/v^2)(v-b)=RT$, in which *a* and *b* are quantities which depend on the composition of the gas, and vary from one gas to another.

It may be surmised that the quantitative measures of most physical properties will be found to be connected with the chemical nature of substances. In the investigation of these relations the physicist and chemist meet on common ground; this union has been attended by fruitful and far-reaching results, and the correlation of physical properties and chemical composition is one of the most important ramifications of physical chemistry. This branch receives treatment below. Of considerable importance, also, are the properties of solids, liquids and gases in solution. This subject has occupied a dominant position in physico-chemical research since the investigations of van't Hoff and Arrhenius. This subject is treated in the article SOLUTION; for the properties of liquid mixtures reference should also be made to the article DISTILLATION.

Another branch of physical chemistry has for its purpose the quantitative study of chemical action, a subject which has brought out in clear detail the analogies of chemical and physical equilibrium (see CHEMICAL ACTION). Another branch, related to energetics (*q.v.*), is concerned with the transformation of chemical energy into other forms of energy—heat, light, electricity. Combustion is a familiar example of the transformation of chemical energy into heat and light; the quantitative measures of heat evolution or absorption (heat of combustion or combination), and the deductions therefrom, are treated in the article THERMOCHEMISTRY. Photography (*q.v.*) is based on chemical action induced by luminous rays; apart from this practical

Halogens,
sulphur,
phosphorus.

application there are many other cases in which actinic rays occasion chemical actions; these are treated in the article PHOTOCHEMISTRY. Transformations of electrical into chemical energy are witnessed in the processes of electrolysis (*q.v.*; see also ELECTROCHEMISTRY and ELECTROMETALLURGY). The converse is present in the common electric cell.

Physical Properties and Composition.

For the complete determination of the chemical structure of any compound, three sets of data are necessary: (1) the empirical chemical composition of the molecule; (2) the constitution, *i.e.* the manner in which the atoms are linked together; and (3) the configuration of the molecule, *i.e.* the arrangement of the atoms in space. Identity in composition, but difference in constitution, is generally known as "isomerism" (*q.v.*), and compounds satisfying this relation differ in many of their physical properties. If, however, two compounds only differ with regard to the spatial arrangement of the atoms, the physical properties may be (1) for the most part identical, differences, however, being apparent with regard to the action of the molecules on polarized light, as is the case when the configuration is due to the presence of an asymmetric atom (optical isomerism); or (2) both chemical and physical properties may be different when the configuration is determined by the disposition of the atoms or groups attached to a pair of doubly-linked atoms, or to two members of a ring system (geometrical isomerism or allo-isomerism). Three sets of physical properties may therefore be looked for: (1) depending on composition, (2) depending on constitution, and (3) depending on configuration. The first set provides evidence as to the molecular weight of a substance: these are termed "colligative properties." The second and third sets elucidate the actual structure of the molecule: these are known as "constitutional properties."

In any attempts to gain an insight into the relations between the physical properties and chemical composition of substances, the fact must never be ignored that a comparison can only be made when the particular property under consideration is determined under strictly comparable conditions, in other words, when the molecular states of the substances experimented upon are identical. This is readily illustrated by considering the properties of gases—the simplest state of aggregation. According to the law of Avogadro, equal volumes of different gases under the same conditions of temperature and pressure contain equal numbers of molecules; therefore, since the density depends upon the number of molecules present in unit volume, it follows that for a comparison of the densities of gases, the determinations must be made under coincident conditions, or the observations reduced or re-computed for coincident conditions. When this is done, such densities are measures of the molecular weights of the substances in question.

Volume Relations.—When dealing with colligative properties of liquids it is equally necessary to ensure comparability of conditions. In the article CONDENSATION OF GASES (see also MOLECULE) it is shown that the characteristic equation of gases and liquids is conveniently expressed in the form $(p + a/v^2)(v - b) = RT$. This equation, which is mathematically deducible from the kinetic theory of gases, expresses the behaviour of gases, the phenomena of the critical state, and the behaviour of liquids; solids are not accounted for. If we denote the critical volume, pressure and temperature by V_k , P_k and T_k , then it may be shown, either by considering the characteristic equation as a perfect cube in v or by using the relations that $dp/dv = 0$, $d^2p/dv^2 = 0$ at the critical point, that $V_k = 3b$, $P_k = a/27b^2$, $T_k = 8a/27b$. Eliminating a and b between these relations, we derive $P_k V_k / T_k = \frac{8}{3}R$, a relation which should hold between the critical constants of any substance. Experiment, however, showed that while the quotient on the left hand of this equation was fairly constant for a great number of substances, yet its value was not $\frac{8}{3}R$ but $\frac{7}{3}R$; this means that the critical density is, as a general rule, 3/7 times the theoretical density. Deviation from this rule indicates molecular dissociation or association.

¹ For the connexion between valency and volume, see VALENCY.

By actual observations it has been shown that ether, alcohol, many esters of the normal alcohols and fatty acids, benzene, and its halogen substitution products, have critical constants agreeing with this originally empirical law, due to Sydney Young and Thomas; acetic acid behaves abnormally, pointing to associated molecules at the critical point.

The critical volume provides data which may be tested for additive relations. Theoretically the critical volume is three times the volume at absolute zero, *i.e.* the actual volume of the molecules; this is obvious by considering the result of making T zero in the characteristic equation. Experimentally (by extrapolation from the "law of the rectilinear diameter") the critical volume is four times the volume at absolute zero (see CONDENSATION OF GASES). The most direct manner in which to test any property for additive relations is to determine the property for a number of elements, and then investigate whether these values hold for the elements in combination. Want of data for the elements, however, restricts this method to narrow limits, and hence an indirect method is necessary. It is found that isomers have nearly the same critical volume, and that equal differences in molecular content occasion equal differences in critical volume. For example, the difference due to an increment of CH_2 is about 56.6, as is shown in the following table:—

Name.	Formula.	Crit. Vol.	Vol. per CH_2
Methyl formate . .	$H \cdot CO_2 \cdot CH_3$	171	56.5
Ethyl formate . .	$H \cdot CO_2 \cdot C_2H_5$	228	
Methyl acetate . .	$CH_3 \cdot CO_2 \cdot CH_3$	227	
Propyl formate . .	$H \cdot CO_2 \cdot C_3H_7$	284	55.8
Ethyl acetate . .	$CH_3 \cdot CO_2 \cdot C_2H_5$	285	
Methyl propionate .	$C_3H_7 \cdot CO_2 \cdot CH_3$	281	57.4
Propyl acetate . .	$CH_3 \cdot CO_2 \cdot C_3H_7$	343	
Ethyl propionate .	$C_2H_5 \cdot CO_2 \cdot C_2H_5$	343	
Methyl n-butyrate .	$C_4H_9 \cdot CO_2 \cdot CH_3$	339	
Methyl isobutyrate .	$C_4H_9 \cdot CO_2 \cdot CH_3$	337	

Since the critical volume of normal pentane C_5H_{12} is 307.2, we have $H_2 = C_5H_{12} - 5CH_2 = 307.2 - 5 \times 56.6 = 24.2$, and $C = CH_2 - H_2 = 32.4$. The critical volume of oxygen can be deduced from the data of the above table, and is found to be 29, whereas the experimental value is 25.

The researches of H. Kopp, begun in 1842, on the molecular volumes, *i.e.* the volume occupied by one gramme molecular weight of a substance, of liquids measured at their boiling-point under atmospheric pressure, brought to light a series of additive relations which, in the case of carbon compounds, render it possible to predict, in some measure, the composition of the substance. In practice it is generally more convenient to determine the density, the molecular volume being then obtained by dividing the molecular weight of the substance by the density. By the indirect method Kopp derived the following atomic volumes:

C.	O.	H.	Cl.	Br.	I.	S.
11	12.2	5.5	22.8	27.8	37.5	22.6.

These values hold fairly well when compared with the experimental values determined from other compounds, and also with the molecular volumes of the elements themselves. Thus the actually observed densities of liquid chlorine and bromine at the boiling-points are 1.56 and 2.96, leading to atomic volumes 22.7 and 26.9, which closely correspond to Kopp's values deduced from organic compounds.

These values, however, require modification in certain cases, for discrepancies occur which can be reconciled in some cases by assuming that the atomic value of a polyvalent element varies according to the distribution of its valencies. Thus a double bond of oxygen, as in the carbonyl group CO, requires a larger volume than a single bond, as in the hydroxyl group—OH, being about 12.2 in the first case and 7.8 in the second. Similarly, an increase of volume is associated with doubly and trebly linked carbon atoms.

Recent researches have shown that the law originally proposed by Kopp—"That the specific volume of a liquid compound (molecular volume) at its boiling-point is equal to the sum of the specific volumes of its constituents (atomic volumes), and that every element has a definite atomic value in its compounds"—is by no means exact, for isomers have different specific volumes, and the volume for an increment of CH_2 in different homologous series is by no means constant; for example, the difference among the esters of the fatty acids is about 57, whereas for the aliphatic aldehydes it is 49. We may therefore conclude that the molecular volume depends more upon the internal structure of the molecule than its empirical content. W. Ostwald (*Lehr. der allg. Chem.*), after an exhaustive review of the material at hand, concluded that simple additive relations did exist but with considerable deviations, which he ascribed to differences in structure. In this connexion we may notice W. Städel's determinations:

$CH_3 \cdot CCl_2$	108	$CHClBr \cdot CH_2$	96.5
$CH_2Cl \cdot CHCl_2$	102.8	$CH_2Br \cdot CH_2Cl$	88

These differences do not disappear at the critical point, and hence the critical volumes are not strictly additive.

Theoretical considerations as to how far Kopp was justified in choosing the boiling-points under atmospheric pressure as being comparable states for different substances now claim our attention. Van der Waal's equation $(p + a/v^2)(v - b) = RT$ contains two constants a and b determined by each particular substance. If we express the pressure, volume and temperature as fractions of the critical constants, then, calling these fractions the "reduced" pressure, volume and temperature, and denoting them by π , ϕ and θ respectively, the characteristic equation becomes $(\pi + 3/\phi^2)(3\phi - 1) = 8\theta$, which has the same form for all substances. Obviously, therefore, liquids are comparable when the pressures, volumes and temperatures are equal fractions of the critical constants. In view of the extremely slight compressibility of liquids, atmospheric pressure may be regarded as a coincident condition; also C. M. Guldberg pointed out that for the most diverse substances the absolute boiling-point is about two-thirds of the critical temperature. Hence within narrow limits Kopp's determinations were carried out under coincident conditions, and therefore any regularities presented by the critical volumes should be revealed in the specific volumes at the boiling-point.

The connexion between the density and chemical composition of solids has not been investigated with the same completeness as in the case of gases and liquids. The relation between the atomic volumes and the atomic weights of the solid elements exhibits the periodicity which generally characterizes the elements. The molecular volume is additive in certain cases, in particular of analogous compounds of simple constitution. For instance, constant differences are found between the chlorides, bromides and iodides of sodium and potassium:—

Volume relations of solids.

I.	Diff.	II.	Diff.	Diff. I. & II.
KCl = 37.4	6.9	NaCl = 27.1	6.7	10.3
KBr = 44.3	9.7	NaBr = 33.8	9.7	10.5
KI = 54.0		NaI = 43.5		10.5

According to H. Schroeder the silver salts of the fatty acids exhibit additive relations; an increase in the molecule of CH_2 causes an increase in the molecular volume of about 15.3.

Thermal Relations.

Specific Heat and Composition.—The nature and experimental determination of specific heats are discussed in the article CALORIMETRY; here will be discussed the relations existing between the heat capacities of elements and compounds.

In the article THERMODYNAMICS it is shown that the amount of heat required to raise a given weight of a gas through a certain range of temperature is different according as the gas is maintained at constant pressure, the volume increasing, or at constant volume, the pressure increasing.

Specific heat of gases.

A gas, therefore, has two specific heats, generally denoted by C_p and C_v , when the quantity of gas taken as a unit is one gramme molecular weight, the range of temperature being 1°C . It may be shown that $C_p - C_v = R$, where R is the gas-constant, *i.e.* R in the equation $PV = RT$. From the ratio C_p/C_v conclusions may be drawn as to the molecular condition of the gas. By considerations based on the kinetic theory of gases (see MOLECULE) it may be shown that when no energy is utilized in separating the atoms of a molecule, this ratio is $5/3 = 1.67$. If, however, an amount of energy a is taken up in separating atoms, the ratio is expressible as $C_p/C_v = (5 + a)/(3 + a)$, which is obviously smaller than $5/3$, and decreases with increasing values of a . These relations may be readily tested, for the ratio C_p/C_v is capable of easy experimental determination. It is found that mercury vapour, helium, argon and its associates (neon, krypton, &c.) have the value 1.67; hence we conclude that these gases exist as monatomic molecules. Oxygen, nitrogen, hydrogen and carbon monoxide have the value 1.4; these gases have diatomic molecules, a fact capable of demonstration by other means. Hence it may be inferred that this value is typical for diatomic molecules. Similarly, greater atomic complexity is reflected in a further decrease in the ratio C_p/C_v . The following table gives a comparative view of the specific heats and the ratio for molecules of variable atomic content.

The abnormal specific heats of the halogen elements may be due to a loosening of the atoms, a preliminary to the dissociation into monatomic molecules which occurs at high temperatures. In the more complex gases the specific heat varies considerably with temperature; only in the case of monatomic gases does it remain

Molecular Content.	Examples.	C_p .	C_v .	C_p/C_v .
Monatomic . . .	Hg, Zn, Cd, He, Ar, &c..	5	3	1.66
Diatomic . . .	{ $\text{H}_2, \text{O}_2, \text{N}_2$ ($0^\circ - 200^\circ$) . . .	6.83	4.83	1.41
	{ $\text{Cl}_2, \text{Br}_2, \text{I}_2$ ($0^\circ - 200^\circ$) . . .	8.6	6.6	1.30
Triatomic . . .	{ $\text{HCl}, \text{HBr}, \text{HI}, \text{NO}, \text{CO}$	9.2	6.2	1.41
	{ $\text{H}_2\text{O}, \text{H}_2\text{S}, \text{N}_2\text{O}, \text{CO}_2$. . .	9.2	7.2	1.28
Tetratomic . . .	{ As_4, P_4	13.4	11.4	1.175
	{ $\text{NH}_3, \text{C}_2\text{H}_2$	11.6	9.6	1.21
Pentatomic . . .	CHCl_3	14	12	1.17
Hexatomic . . .	$\text{C}_2\text{H}_4, \text{C}_2\text{H}_2\text{Br}$	16.4	14.4	1.14

constant. Le Chatelier (*Zeit. f. phys. Chem.* i. 456) has given the formula $C_p = 6.5 + aT$, where a is a constant depending on the complexity of the molecule, as an expression for the molecular heat at constant pressure at any temperature T (reckoned on the absolute scale). For a further discussion of the ratio of the specific heats see MOLECULE.

Specific Heats of Solids.—The development of the atomic theory and the subsequent determination of atomic weights in the opening decades of the 19th century inspired A. T. Petit and P. L. Dulong to investigate relations (if any) existing between specific heats and the atomic weight. Their observations on the solid elements led to a remarkable generalization, now known as Dulong and Petit's law. This states that "the atomic heat (the product of the atomic weight and specific heat) of all elements is a constant quantity." The value of this constant when $H = 1$ is about 6.4; Dulong and Petit, using $O = 1$, gave the value .38, the specific heat of water being unity in both cases. This law—purely empirical in origin—was strengthened by Berzelius, who redetermined many specific heats, and applied the law to determine the true atomic weight from the equivalent weight. At the same time he perceived that specific heats varied with temperature and also with allotropes, *e.g.* graphite and diamond. The results of Berzelius were greatly extended by Hermann Kopp, who recognized that carbon, boron and silicon were exceptions to the law. He regarded these anomalies as solely due to the chemical nature of the elements, and ignored or regarded as insignificant such factors as the state of aggregation and change of specific heat with temperature.

The specific heats of carbon, boron and silicon subsequently formed the subject of elaborate investigations by H. F. Weber, who showed that with rise of temperature the specific (and atomic) heat increases, finally attaining a fairly constant value; diamond, graphite and the various amorphous forms of carbon having the value about 5.6 at 1000° , and silicon 5.68 at 232° ; while he concluded that boron attained a constant value of 5.5. Nilson and Pettersson's observations on beryllium and germanium have shown that the atomic heats of these metals increase with rise of temperature, finally becoming constant with a value 5.6. W. A. Tilden (*Phil. Trans.*, 1900, p. 233) investigated nickel and cobalt over a wide range of temperature (from -182.5° to 100°); his results are:—

	Cobalt.	Nickel.
From -182.5° to -78.4° . . .	4.1687	4.1874
-78.4° to 15° . . .	5.4978	5.6784
15° to 100° . . .	6.0324	6.3143

It is evident that the atomic heats of these intimately associated elements approach nearer and nearer as we descend in temperature, approximating to the value 4. Other metals were tested in order to determine if their atomic heats approximated to this value at low temperatures, but with negative results.

It is apparent that the law of Dulong and Petit is not rigorously true, and that deviations are observed which invalidate the law as originally framed. Since the atomic heat of the same element varies with its state of aggregation, it must be concluded that some factor taking this into account must be introduced; moreover, the variation of specific heat with temperature introduces another factor.

We now proceed to discuss molecular heats of compounds, that is, the product of the molecular weight into the specific heat. The earliest generalization in this direction is associated with F. E. Neumann, who, in 1831, deduced from observations on many carbonates (calcium, magnesium, ferrous, zinc, barium and lead) that stoichiometric quantities (equimolecular weights) of compounds possess the same heat capacity. This is spoken of as "Neumann's law." Regnault confirmed Neumann's observations, and showed that the molecular heat depended on the number of atoms present, equiatomic compounds having the same molecular heat. Kopp systematized the earlier observations,

and, having made many others, he was able to show that the molecular heat was an additive property, *i.e.* each element retains the same heat capacity when in combination as in the free state. This has received confirmation by the researches of W. A. Tilden (*Phil. Trans.*, 1904, 203 A, p. 139) for those elements whose atomic heats vary considerably with temperature.

The specific heat of a compound may, in general, be calculated from the specific heats of its constituent elements. Conversely, if the specific heats of a compound and its constituent elements, except one, be known, then the unknown atomic heat is readily deducible. Similarly, by taking the difference of the molecular heats of compounds differing by one constituent, the molecular (or atomic) heat of this constituent is directly obtained. By this method it is shown that water, when present as "water of crystallization," behaves as if it were ice.

Deductions from Dulong and Petit's Law.—Denoting the atomic weight by *W* and the specific heat by *s*, Dulong and Petit's law states that $6.4 = Ws$. Thus if *s* be known, an approximate value of *W* is determinate. In the determination of the atomic weight of an element two factors must be considered: (1) its equivalent weight, *i.e.* the amount which is equivalent to one part of hydrogen; and (2) a factor which denotes the number of atoms of hydrogen which combines with or is equivalent to one atom of the particular element. This factor is termed the valency. The equivalent weight is capable of fairly ready determination, but the settlement of the second factor is somewhat more complex, and in this direction the law of atomic heats is of service. To take an example: 38 parts of indium combine with 35.4 parts of chlorine; hence, if the formula of the chloride be $InCl$, $InCl_2$, or $InCl_3$, indium has the atomic weights 38, 76 or 114. The specific heat of indium is 0.057; and the atomic heats corresponding to the atomic weights 38, 76 and 114 are 3.2, 4.3, 6.5. Dulong and Petit's law thus points to the value 114, which is also supported by the position occupied by this element in the periodic classification. C. Winkler decided the atomic weight of germanium by similar reasoning.

Boiling-Point and Composition.—From the relation between the critical constants $P_k V_k/T_k = \frac{1}{3.7}R$ or $T_k/P_k = 3.7V_k/R$, and since V_k is proportional to the volume at absolute zero, the ratio T_k/P_k should exhibit additive relations. This ratio, termed by Guye the critical coefficient, has the following approximate values:—

C.	H.	Cl.	—O—.	=O.	N.	N=.	P.	Double linkage.	Triple linkage.
1.35	0.57	2.66	0.87	1.27	1.6	1.86	3.01	0.88	1.03

Since at the boiling-point under atmospheric pressure liquids are in corresponding states, the additive nature of the critical coefficient should also be presented by boiling-points. It may be shown theoretically that the absolute boiling-point is proportional to the molecular volume, and, since this property is additive, the boiling-point should also be additive.

These relations have been more thoroughly tested in the case of organic compounds, and the results obtained agree in some measure with the deductions from molecular volumes. In general, isomers boil at about the same temperature, as is shown by the isomeric esters $C_9H_{18}O_2$:—

Methyl octoate . . .	192.9°	Amyl butyrate . . .	184.8°
Ethyl heptoate . . .	187.1°	Heptyl acetate . . .	191.3°
Propyl hexoate . . .	185.5°	Octyl formate . . .	198.1°
Butyl pentoate . . .	185.8°		

Equal increments in the molecule are associated with an equal rise in the boiling-point, but this increment varies in different homologous series. Thus in the normal fatty alcohols, acids, esters, nitriles and ketones, the increment per CH_2 is $19-21^\circ$; in the aldehydes it is $26-27^\circ$. In the aromatic compounds there is no regularity between the increments due to the introduction of methyl groups into the benzene nucleus or side chains; the normal value of $20-21^\circ$ is exhibited, however, by pyridine and its derivatives. The substitution of a hydrogen atom by the hydroxyl group generally occasions a rise in boiling-point at about 100° . The same increase accompanies the introduction of the amino group into aromatic nuclei.

While certain additive relations hold between some homologous series, yet differences occur which must be referred to the constitution of the molecule. As a general rule, compounds formed with a great evolution of heat have high boiling-points, and vice versa. The introduction of negative groups into a molecule alters the boiling-point according to the number of negative groups already present. This is shown in the case of the chloroacetic acids:

$CH_3CO_2H = 118^\circ$	Diff.
$ClCH_2 \cdot CO_2H = 185^\circ$	67°
$Cl_2CH \cdot CO_2H = 195^\circ$	10°
$Cl_2C \cdot CO_2H = 195^\circ - 200^\circ$	3°

According to van 't Hoff the substitution of chlorine atoms into a methyl group occasions the following increments:—

Cl in CH_3	66°
Cl " CH_2Cl	39°
Cl " $CHCl_2$	13°

The introduction of chlorine, however, may involve a fall in the boiling-point, as is recorded by Henry in the case of the chlorinated acetonitriles:—

$NC \cdot CH_3$	81°	$NC \cdot CH_2Cl$	123°	$NC \cdot CHCl_2$	112°	$NC \cdot CCl_3$	83°
		42°		-11°		-29°	

The replacement of one negative group by another is accompanied by a change in the boiling-point, which is independent of the compound in which the substitution is effected, and solely conditioned by the nature of the replaced and replacing groups. Thus bromine and iodine replace chlorine with increments of about 22° and 50° respectively.

A factor of considerable importance in determining boiling-points of isomers is the symmetry of the molecule. Referring to the esters $C_9H_{18}O_2$; previously mentioned, it is seen that the highest boiling-points belong to methyl octoate and octyl formate, the least symmetrical, while the minimum belongs to amyl butyrate, the most symmetrical. The isomeric pentanes also exhibit a similar relation $CH_3(CH_2)_4CH_3 = 38^\circ$, $(CH_3)_2CHCH_2CH_3 = 30^\circ$, $(CH_3)_3C = 9.5^\circ$. For a similar reason secondary alcohols boil at a lower temperature than the corresponding primary, the difference being about 19° . A. E. Earp (*Phil. Mag.*, 1893 [5], 35, p. 458) has shown that, while an increase in molecular weight is generally associated with a rise in the boiling-point, yet the symmetry of the resulting molecule may exert such a lowering effect that the final result is a diminution in the boiling-point. The series $H_2S = -61^\circ$, $CH_3SH = 21^\circ$, $(CH_3)_2S = 41^\circ$ is an example; in the first case, the molecular weight is increased and the symmetry diminished, the increase of boiling-point being 82° ; in the second case the molecular weight is again increased but the molecule assumes a more symmetrical configuration, hence the comparatively slight increase of 20° . A similar depression is presented by methyl alcohol (67°) and methyl ether (-23°).

Among the aromatic di-substitution derivatives the *ortho* compounds have the highest boiling-point, and the *meta* boil at a higher, or about the same temperature as the *para* compounds. Of the tri-derivatives the symmetrical compounds boil at the lowest temperature, the asymmetric next, and the vicinal at the highest.

An ethylenic or double carbon union in the aliphatic hydrocarbons has, apparently, the same effect on the boiling-point as two hydrogen atoms, since the compounds C_nH_{2n+2} and C_nH_{2n} boil at about the same temperature. An acetylenic or triple linkage is associated with a rise in the boiling-point; for example, propargyl compounds boil about 19.5° higher than the corresponding propyl compound.

Certain regularities attend the corresponding property of the melting-point. A rule applicable to organic compounds, due to Adolf v. Baeyer and supported by F. S. Kipping (*Jour. Chem. Soc.*, 1893, 63, p. 465) states, that the melting-point of any odd member of a homologous series is lower than the melting-point of the even member containing one carbon atom less. This is true of the fatty acid series, and the corresponding ketones and alcohols, and also of the succinic acid series. Other regularities exist, but generally with many exceptions. It is to be noted that although the correlation of melting-point with constitution has not been developed to such an extent as the chemical significance of other physical properties, the melting-point is the most valuable test of the purity of a substance, a circumstance due in considerable measure to the fact that impurities always tend to lower the melting-point.

Heat of Combustion and Constitution.—In the article THERMOCHEMISTRY a general account of heats of formation of chemical compounds is given, and it is there shown that this constant measures the stability of the compound. In organic chemistry it is more customary to deal with the "heat of combustion," *i.e.* the heat evolved when an organic compound is completely burned in oxygen; the heat of formation is deduced from the fact that it is equal to the heats of formation of the products of combustion less the observed heat of combustion. The researches of Julius Thomsen and others have shown that in many cases definite conclusions regarding constitution can be drawn from quantitative measurements of the heats of combustion; and in this article a summary of the chief results will be given.

The identity of the four valencies of the carbon atom follows from the fact that the heats of combustion of methane, ethane, propane, trimethyl methane, and tetramethyl methane, have a constant difference in the order given, *viz.* 158.6 calories; this means

that the replacement of a hydrogen atom by a methyl group is attended by a constant increase in the heat of combustion. The same difference attends the introduction of the methyl group into many classes of compounds, for example, the paraffins, olefines, acetylenes, aromatic hydrocarbons, alcohols, aldehydes, ketones and esters, while a slightly lower value (157.1) is found in the case of the halogen compounds, nitriles, amines, acids, ethers, sulphides and nitro compounds. It therefore appears that the difference between the heats of combustion of two adjacent members of a series of homologous compounds is practically a constant, and that this constant has two average values, viz. 158.6 and 157.1.

An important connexion between heats of combustion and constitution is found in the investigation of the effect of single, double and triple carbon linkages on the thermochemical constants. If twelve grammes of amorphous carbon be burnt to carbon dioxide under constant volume, the heat evolved (96.96 cal.) does not measure the entire thermal effect, but the difference between this and the heat required to break down the carbon molecule into atoms. If the number of atoms in the carbon molecule be denoted by n , and the heat required to split off each atom from the molecule by d , then the total heat required to break down a carbon molecule completely into atoms is nd . It follows that the true heat of combustion of carbon, *i.e.* the heat of combustion of one gramme-atom, is $96.96 + d$. The value of d can be evaluated by considering the combustion of amorphous carbon to carbon monoxide and carbon dioxide. In the first case the thermal effect of 58.58 calories actually observed must be increased by $2d$ to allow for the heat absorbed in splitting off two gramme-atoms of carbon; in the second case the thermal effect of 96.96 must be increased by d as above. Now in both cases one gramme-molecule of oxygen is decomposed, and the two oxygen atoms thus formed are combined with two carbon valencies. It follows that the thermal effects stated above must be equal, *i.e.* $58.58 + 2d = 96.96 + d$, and therefore $d = 38.38$. The absolute heat of combustion of a carbon atom is therefore 135.34 calories, and this is independent of the form of the carbon burned.

Consider now the combustion of a hydrocarbon of the general formula C_nH_{2m} . We assume that each carbon atom and each hydrogen atom contributes equally to the thermal effect. If α be the heat evolved by each carbon atom, and β that by each hydrogen atom, the thermal effect may be expressed as $H = n\alpha + 2m\beta - A$, where A is the heat required to break the molecule into its constituent atoms. If the hydrocarbon be saturated, *i.e.* only contain single carbon linkages, then the number of such linkages is $2n - m$, and if the thermal effect of such a linkage be X , then the term A is obviously equal to $(2n - m)X$. The value of H then becomes $H = n\alpha + 2m\beta - (2n - m)X$ or $n\xi + m\eta$, where ξ and η are constants. Let double bonds be present, in number p , and let the energy due to such a bond be Y . Then the number of single bonds is $2n - m - 2p$, and the heat of combustion becomes $H_1 = n\xi + m\eta + p(2X - Y)$. If triple bonds, q in number, occur also, and the energy of such a bond be Z , the equation for H becomes

$$H = n\xi + m\eta + p(2X - Y) + q(3X - Z).$$

This is the general equation for calculating the heat of combustion of a hydrocarbon. It contains four independent constants; two of these may be calculated from the heats of combustion of saturated hydrocarbons, and the other two from the combustion of hydrocarbons containing double and triple linkages. By experiment it is found that the thermal effect of a double bond is much less than the effect of two single bonds, while a triple bond has a much smaller effect than three single bonds. J. Thomsen deduces the actual values of X , Y , Z to be 14.71, 13.27 and zero; the last value he considers to be in agreement with the labile equilibrium of acetylenic compounds. One of the most important applications of these values is found in the case of the constitution of benzene, where Thomsen decides in favour of the Claus formula, involving nine single carbon linkages, and rejects the Kekulé formula, which has three single and three double bonds (see section IV.).

The thermal effects of the common organic substituents have also been investigated. The thermal effect of the "alcohol" group $C-OH$ may be determined by finding the heat of formation of the alcohol and subtracting the thermal effects of the remaining linkages in the molecule. The average value for primary alcohols is 44.67 cal., but many large differences from this value obtain in certain cases. The thermal effects increase as one passes from primary to tertiary alcohols, the values deduced from propyl and isopropyl alcohols and trimethyl carbinol being:—primary = 45.08, secondary = 50.39, tertiary = 60.98. The thermal effect of the aldehyde group has the average value 64.88 calories, *i.e.* considerably greater than the alcohol group. The ketone group corresponds to a thermal effect of 53.52 calories. It is remarkable that the difference in the heats of formation of ketones and the paraffin containing one carbon atom less is 67.94 calories, which is the heat of formation of carbon monoxide at constant volume. It follows therefore that two hydrocarbon radicals are bound to the carbon monoxide residue with the same strength as they combine to form a paraffin. The average value for the carboxyl group is 119.75 calories, *i.e.* it is equal to the sum of the thermal effects of the aldehyde and carbonyl groups.

The thermal effects of the halogens are: chlorine = 15.13 calories, bromine = 7.68; iodine = -4.25 calories. It is remarkable that the

position of the halogen in the molecule has no effect on the heat of formation; for example, chloropropylene and allylchloride, and also ethylene dichloride and ethylidene dichloride, have equal heats of formation. The thermal effect of the ether group has an average value of 34.31 calories. This value does not hold in the case of

methylene oxide if we assign to it the formula $H_2C-O-CH_2$, but if the formula $H_2C-O-CH_2$ (which assumes the presence of two free valencies) be accepted, the calculated and observed heats of formation are in agreement.

The combination of nitrogen with carbon may result in the formation of nitriles, cyanides, or primary, secondary or tertiary amines. Thomsen deduced that a single bond between a carbon and a nitrogen gramme-atom corresponds to a thermal effect of 2.77 calories, a double bond to 5.44, and a treble bond to 8.31. From this he infers that cyanogen is $C:N:N:C$ and not $N:C:C:N$, that hydrocyanic acid is $HC\cdot N$, and acetonitrile $CH_3\cdot C:N$. In the case of the amines he decides in favour of the formulæ

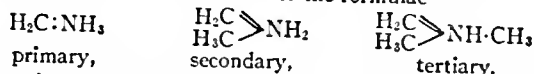

These involve pentavalent nitrogen. These formulæ, however, only apply to aliphatic amines; the results obtained in the aromatic series are in accordance with the usual formulæ.

Optical Relations.

Refraction and Composition.—Reference should be made to the article REFRACTION for the general discussion of the phenomenon known as the refraction of light. It is there shown that every substance, transparent to light, has a definite refractive index, which is the ratio of the velocity of light *in vacuo* to its velocity in the medium to which the refractive index refers. The refractive index of any substance varies with (1) the wavelength of the light; (2) with temperature; and (3) with the state of aggregation. The first cause of variation may be at present ignored; its significance will become apparent when we consider dispersion (*vide infra*). The second and third causes, however, are of greater importance, since they are associated with the molecular condition of the substance; hence, it is obvious that it is only from some function of the refractive index which is independent of temperature variations and changes of state (*i.e.* it must remain constant for the same substance at any temperature and in any form) that quantitative relations between refractivity and chemical composition can be derived.

The pioneer work in this field, now frequently denominated "spectro-chemistry," was done by Sir Isaac Newton, who, from theoretical considerations based on his corpuscular theory of light, determined the function $(n^2 - 1)$, where n is the refractive index, to be the expression for the refractive power; dividing this expression by the density (d), he obtained $(n^2 - 1)/d$, which he named the "absolute refractive power." To P. S. Laplace is due the theoretical proof that this function is independent of temperature and pressure, and apparent experimental confirmation was provided by Biot and Arago's, and by Dulong's observations on gases and vapours. The theoretical basis upon which this formula was devised (the corpuscular theory) was shattered early in the 19th century, and in its place there arose the modern wave theory which theoretically invalidates Newton's formula. The question of the dependence of refractive index on temperature was investigated in 1858 by J. H. Gladstone and the Rev. T. P. Dale; the more simple formula $(n - 1)/d$, which remained constant for gases and vapours, but exhibited slight discrepancies when liquids were examined over a wide range of temperature, being adopted. The subject was next taken up by Hans Landolt, who, from an immense number of observations, supported in a general way the formula of Gladstone and Dale. He introduced the idea of comparing the refractivity of equimolecular quantities of different substances by multiplying the function $(n - 1)/d$ by the molecular weight (M) of the substance, and investigated the relations of chemical grouping to refractivity. Although establishing certain general relations between atomic and molecular refractions, the results were somewhat vitiated by the inadequacy of the empirical function which he employed, since it was by no means a constant which depended only on the actual composition of the substance and was independent of its physical condition. A more accurate expression $(n^2 - 1)/(n^2 + 2)d$ was

suggested in 1880 independently and almost simultaneously by L. V. Lorenz of Copenhagen and H. A. Lorentz of Leiden, from considerations based on the Clausius-Mossotti theory of dielectrics.

Assuming that the molecules are spherical, R. J. E. Clausius and O. F. Mossotti found a relation between the dielectric constant and the space actually occupied by the molecules, viz. $K = (1+2a)/(1-a)$, or $a = (K-1)/(K+2)$, where K is the dielectric constant and a the fraction of the total volume actually occupied by matter. According to the electromagnetic theory of light $K = N^2$, where N is the refractive index for rays of infinite wave-length. Making this substitution, and dividing by d , the density of the substance, we obtain $a/d = (N^2-1)/(N^2+2)d$. Since a/d is the real specific volume of the molecule, it is therefore a constant; hence $(N^2-1)/(N^2+2)d$ is also a constant and is independent of all changes of temperature, pressure, and of the state of aggregation. To determine N recourse must be made to Cauchy's formula of dispersion ($g.$), $n = A + B/\lambda^2 + C/\lambda^4 + \dots$ from which, by extrapolation, λ becoming infinite, we obtain $N = A$. In the case of substances possessing anomalous dispersion, the direct measurement of the refractive index for Hertzian waves of very long wave-length may be employed.

It is found experimentally that the Lorenz and Lorentz function holds fairly well, and better than the Gladstone and Dale formula. This is shown by the following observations of Rühlmann on water, the light used being the D line of the spectrum:—

t .	$(n-1)/d$.	$(n^2-1)/(n^2+2)d$.
0	0.3338	0.2061
10	0.3338	0.2061
20	0.3336	0.2061
90	0.3321	0.2059
100	0.3323	0.2061

Eykman's observations also support the approximate constancy of the Lorenz-Lorentz formula over wide temperature differences, but in some cases the deviation exceeds the errors of observation. The values are for the $H\alpha$ line:—

Substance.	Temp.	$(n^2-1)/(n^2+2)d$.
Isosafrol, $C_{10}H_{10}O_2$	17.6°	0.2925
	141.1°	0.2962
Diphenyl ethylene, $C_{14}H_{12}$	22°	0.3339
	143.4°	0.3382
Quinoline, C_9H_7N	16.2°	0.3187
	141°	0.3225

The empirical formula $(n^2-1)/(n^2+0.4)d$ apparently gives more constant values with change of temperature than the Lorenz-Lorentz form. The superiority of the Lorenz-Lorentz formula over the Gladstone and Dale formula for changes of state is shown by the following observations of Brühl (*Zeit. f. phys. Chem.*, 1891, 71, p. 4). The values are for the D line:—

Substance.	Temp.	Gladstone and Dale.		Lorenz and Lorentz.	
		Vapour.	Liquid.	Vapour.	Liquid.
Water	10°	0.3101	0.3338	0.2068	0.2061
Carbon disulphide	10°	0.4347	0.4977	0.2898	0.2805
Chloroform	10°	0.2694	0.3000	0.1796	0.1790

Landolt and Gladstone, and at a later date J. W. Brühl, have investigated the relations existing between the refractive power and composition. To Landolt is due the proof that, in general, isomers, i.e. compounds having the same composition, have equal molecular refractions, and that equal differences in composition are associated with equal differences in refractive power. This is shown in the following table (the values are for $H\alpha$):—

Substance.	Mol. Refract.	Substance.	Mol. Refract.	Diff. for CH_2 .
Ethylene chloride	20.96	Acetic acid	12.93	} 4.49
Ethylidene chloride	21.08	Propionic acid	17.42	
Fumaric acid	70.89	Butyric acid	22.01	} 4.59
Maleic acid	70.29	Acetaldehyde	11.50	
o-Cresol	32.52	Propionaldehyde	15.93	} 4.43
m-Cresol	32.56	Butylaldehyde	20.52	
p-Cresol	32.57			} 4.59

Additive relations undoubtedly exist, but many discrepancies occur which may be assigned, as in the case of molecular volumes, to differences in constitution. Atomic refractions may be obtained

either directly, by investigating the various elements, or indirectly, by considering differences in the molecular refractions of related compounds. The first method needs no explanation. The second method proceeds on the same lines as adopted for atomic volumes. By subtracting the value for CH_2 , which may be derived from two substances belonging to the same homologous series, from the molecular refraction of methane, CH_4 , the value of hydrogen is obtained; subtracting this from CH_2 , the value of carbon is determined. Hydroxylic oxygen is obtained by subtracting the molecular refractions of acetic acid and acetaldehyde. Similarly, by this method of differences, the atomic refraction of any element may be determined. It is found, however, that the same element has not always the same atomic refraction, the difference being due to the nature of the elements which saturate its valencies. Thus oxygen varies according as whether it is linked to hydrogen (hydroxylic oxygen), to two atoms of carbon (ether oxygen), or to one carbon atom (carbonyl oxygen); similarly, carbon varies according as whether it is singly, doubly, or trebly bound to carbon atoms.

A table of the atomic refractions and dispersions of the principal elements is here given:—

Element.	$H\alpha$.	D.	$H\gamma$.	Dispersion $H\gamma-H\alpha$.
Hydrogen	1.103	1.051	1.139	0.036
Oxygen, hydroxyl	1.306	1.521	1.525	0.019
" ether	1.655	1.683	1.667	0.012
" carbonyl	2.328	2.287	2.414	0.086
Chlorine	6.014	5.998	6.190	0.176
Bromine	8.863	8.927	9.211	0.348
Iodine	13.808	14.12	14.582	0.774
Carbon (singly bound)	2.365	2.501	2.404	0.039
Double linkage of carbon	1.836	1.707	1.859	0.23
Triple	2.22		2.41	0.19
Nitrogen, singly bound and only to carbon	2.76		2.95	0.19

Dispersion and Composition.—In the preceding section we have seen that substances possess a definite molecular (or atomic) refraction for light of particular wave-length; the difference between the refractions for any two rays is known as the molecular (or atomic) dispersion. Since molecular refractions are independent of temperature and of the state of aggregation, it follows that molecular dispersions must be also independent of these conditions; and hence quantitative measurements should give an indication as to the chemical composition of substances. This subject has been principally investigated by Brühl; he found that molecular dispersions of liquids and gases were independent of temperature, and fairly independent of the state of aggregation, but that no simple connexion exists between atomic refractions and dispersions (see preceding table). He also showed how changes in constitution effected dispersions to a far greater extent than they did refractions; thus, while the atomic dispersion of carbon is 0.039, the dispersions due to a double and treble linkage is 0.23 and 0.19 respectively.

Colour and Constitution.—In this article a summary of the theories which have been promoted in order to connect the colour of organic compounds with their constitution will be given, and the reader is referred to the article COLOUR for the physical explanation of this property, and to VISION for the physiological and psychological bearings. A clear distinction must be drawn between colour and the property of dyeing; all coloured substances are not dyes,

and it is shown in the article DYEING that the property of entering into chemical or physical combination with fibres involves properties other than those essential to colour. At the same time, however, all dyestuffs are coloured substances.

A survey of coloured substances led O. N. Witt in 1876 to formulate his "chromophore-auxochrome" theory. On this theory colour is regarded as due to the presence of a "chromophore," and dyeing power to an "auxochrome"; the latter by itself cannot produce colour or dyeing power, but it is only active in the presence of a chromophore, when it intensifies the colour and confers the property of dyeing. The principal chromophores are the azo, $-N=N-$, azoxy, $=N_2O$, nitro, $-NO_2$, nitroso, $-NO$, and carbonyl, $=CO$, groups. The azo-group is particularly active, both the aliphatic and aromatic compounds being coloured. The simplest aliphatic compounds, such as diazo-methane, diazo-ethane, and azo-formic acid, are yellow; the diamide of the latter acid is orange-red. Of the aromatic compounds azo-benzene is bright orange-red, and α -azobenzene forms red needles or small steel-blue prisms. The azo-group, however, has little or no colouring effect when present in a

ring system, such as in cinnolene, phthalazine and tolazone. The nitro group has a very important action mainly on account of the readiness with which it can be introduced into the molecule, but its effect is much less than that of the azo group. The colour produced is generally yellow, which, in accordance with a general rule, is intensified with an increase in the number of groups; compare, for example, mono-, di- and tri-nitrobenzene. The nitroso group is less important. The colour produced is generally of a greenish shade; for example, nitrosobenzene is green when fused or in solution (when crystalline, it is colourless), and dinitrosoresorcin has been employed as a dyestuff under the names "solid green" and "chlorine." The carbonyl group by itself does not produce colour, but when two adjacent groups occur in the molecule, as for example in the α -diketones (such as di-acetyl and benzil), a yellow colour is produced. It also acts as a chromogenic centre when double bonds or ethylenic linkages are present, as in fluorene ketone or fluorenone.

A more complex chromophoric group is the triple ethylenic grouping $\begin{matrix} \text{C} \\ \diagup \quad \diagdown \\ \text{C} \end{matrix} > \text{C} =$, the introduction of which was rendered necessary by the discovery of certain coloured hydrocarbons. As a general rule, hydrocarbons are colourless; the exceptions include the golden yellow acenaphthylene, the red bidiphenylene-ethylene, and the derivatives of fulvene

$\begin{matrix} \text{CH} : \text{CH} \\ \text{CH} : \text{CH} \end{matrix} > \text{CH}_2$, which have been discussed by

J. Thiele (*Ber.*, 1900, 33, p. 666). This grouping is not always colour-producing, since diphenyl is colourless.

The most important auxochromes are the hydroxyl ($-\text{OH}$) and amino ($-\text{NH}_2$) groups. According to the modern theory of auxochromic action, the introduction of a group into the molecule is accompanied by some strain, and the alteration in colour produced is connected with the magnitude of the strain. The amino group is more powerful than the hydroxyl, and the substituted amino group more powerful still; the repeated substitution of hydroxyl groups sometimes causes an intensification and sometimes a diminution of colour.

We may here notice an empirical rule formulated by Nietzsche in 1879:—the simplest colouring substances are in the greenish-yellow and yellow, and with increasing molecular weight the colour passes into orange, red, violet, blue and green. This rule, however, is by no means perfect. Examination of the absorption spectra of coloured compounds shows that certain groupings displace the absorption bands in one direction, and other groupings in the other. If the bands be displaced towards the violet, involving a regression through the colours mentioned above, the group is said to be "hypsochromic"; if the reverse occurs the group is "bathochromic." It may be generally inferred that an increase in molecular weight is accompanied by a change in colour in the direction of the violet.

Auxochromic groups generally aid one another, *i.e.* the tint deepens as the number of auxochromes increases. Also the relative position of the auxochrome to the chromophore influences colour, the ortho-position being generally the most powerful. Kauffmann (*Ber.*, 1906, 39, p. 1959) attempted an evaluation of the effects of auxochromic groups by means of the magnetic optical constants. The method is based on the supposition that the magnetic rotation measures the strain produced in the molecule by an auxochrome, and he arranges the groups in the following order:—

$\cdot\text{O}\cdot\text{COCH}_3$ $\cdot\text{OCH}_3$ $\cdot\text{NHCOCH}_3$ $\cdot\text{NH}_2$ $\cdot\text{N}(\text{CH}_3)_2$ $\cdot\text{N}(\text{C}_2\text{H}_5)_2$
 -0.260 1.459 1.949 3.821 8.587 8.816

The phenomena attending the salt formation of coloured and colouring substances are important. The chromophoric groups are rarely strongly acid or basic; on the other hand, the auxochromes are strongly acid or basic and form salts very readily. Notable differences attend the neutralization of the chromophoric and auxochromic groups. With basic substances, the chromophoric combination with a colourless acid is generally attended by a deepening in colour; auxochromic combination, on the other hand, with a lessening. Examples of the first case are found among the colourless acridines and quinoxalines which give coloured salts; of the second case we may notice the colourless hydrochloride and sulphate of the deep yellow *o*-aminobenzophenone. With acid substances, the combination with "colourless" metals, *i.e.* metals producing colourless salts with acids, is attended by colour changes contrary to those given above, auxochromic combination being accompanied by a deepening, and chromophoric by a lessening of the tint.

Mention may be made of the phenomenon of halochromism, the name given to the power of colourless or faintly-coloured substances of combining with acids to form highly-coloured substances without the necessary production of a chromophoric group. The researches of Adolf von Baeyer and Villiger, Kehrmann, Kauffmann and others, show that this property is possessed by very many and varied substances. In many cases it may be connected with basic oxygen, and the salt formation is assumed to involve the passage of divalent into tetravalent oxygen. It seems that intermolecular change also occurs, but further research is necessary before a sound theory can be stated.

Quinone Theory of Colour.—A theory of colour in opposition to the Witt theory was proposed by Henry Armstrong in 1888 and 1892. This assumed that all coloured substances were derivatives of ortho- or para-quinone (see QUINONES), and although at the time of its

promotion little practical proof was given, yet the theory found wide acceptance on account of the researches of many other chemists. It follows on this theory that all coloured substances contain either of the groupings

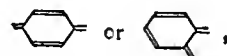

the former being a para-quinonoid, the latter an ortho-quinonoid. While very many coloured substances must obviously contain this grouping, yet in many cases it is necessary to assume a simple intermolecular change, while in others a more complex rearrangement of bonds is necessary. Quinone, which is light yellow in colour, is the simplest coloured substance on this theory. Hydrocarbons of similar structure have been prepared by Thiele, for example, the orange-yellow tetraphenyl-*para*-xylylene, which is obtained by boiling the bromide $\text{C}_6\text{H}_4[\text{CBr}(\text{C}_6\text{H}_5)_2]_2$ with benzene and molecular silver. The quinonoid structure of many coloured compounds has been proved experimentally, as, for example, by Hewitt for the benzene-azo-phenols, and Hantzsch for triaminotriphenyl methane and acridine derivatives; but, at the same time, many substances cannot be so explained. A notable example is provided by the phthaleins, which result by the condensation of phthalic anhydride with phenols. In the free state these substances are colourless, and were assumed to have the formula shown in 1. Solution in dilute alkali was supposed to be accompanied by the rupture of the lactone ring with the formation of the quinonoid salt shown in 2.

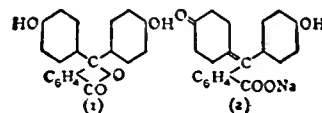

Baeyer (*Ber.*, 1905, 38, p. 569) and Silberrad (*Journ. Chem. Soc.*, 1906, 89, p. 1787) have disputed the correctness of this explanation, and the latter has prepared mellitins and pyromellitins, which are highly-coloured compounds produced from mellitic and pyromellitic acids, and which cannot be formulated as quinones. Baeyer has suggested that the nine carbon atom system of xanthone may act as a chromophore. An alternative view, due to Green, is that the oxygen atom of the xanthone ring is tetravalent, a supposition which permits the formulation of these substances as ortho-quinonoids.

The theories of colour have also been investigated by Hantzsch, who first considered the nitro-phenols. On the chromophore-auxochrome theory (the nitro group being the chromophore, and the hydroxyl the auxochrome) it is necessary in order to explain the high colour of the metallic salts and the colourless alkyland aryl derivatives to assume that the auxochromic action of the hydroxyl group is only brought strongly into evidence by salt formation. Armstrong, on the other hand, assumed an intermolecular change, thus:—

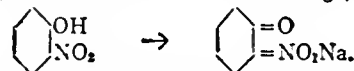

The proof of this was left for Hantzsch, who traced a connexion with the nitrolic acids of V. Meyer, which are formed when nitrous acid acts on primary aliphatic nitro compounds. Meyer formulated these compounds as nitroximes or nitro-isnitroso derivatives, *viz.* $\text{R}\cdot\text{C}(\text{NO}_2)(\text{NOH})$. Hantzsch explains the transformation of the colourless acid into red salts, which on standing yield more stable, colourless salts, by the following scheme:—

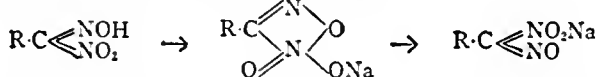

Colourless, stable. Coloured, labile. Colourless, stable.

He has also shown that the nitrophenols yield, in addition to the colourless true nitrophenol ethers, an isomeric series of coloured unstable quinonoid *aci*-ethers, which have practically the same colour and yield the same absorption spectra as the coloured metallic salts. He suggests that the term "quinone" theory be abandoned, and replaced by the *Umlagerungs* theory, since this term implies some intermolecular rearrangement, and does not connote simply benzenoid compounds as does "quinonoid." H. von Liebig (*Ann.*, 1908, 360, p. 128), from a very complete discussion of triphenyl-methane derivatives, concluded that the grouping $\begin{matrix} \text{R} & \text{R} & \text{R} \\ \diagdown & | & / \\ \text{A} & -\text{A} & -\text{A} \end{matrix}$ was the only true organic chromophore, colour production, however, requiring another condition, usually the closing of a ring.

The views as to the question of colour and constitution may be summarized as follows:—(1) The quinone theory (Armstrong, Gomberg, R. Meyer) regards all coloured substances as having a quinonoid structure. (2) The chromophore-auxochrome theory (Kauffmann) regards colour as due to the entry of an "auxochrome" into a "chromophoric" molecule. (3) If a colourless compound gives a coloured one on solution or by

salt-formation, the production of colour may be explained as a particular form of ionization (Baeyer), or by a molecular rearrangement (Hantzsch). A dynamical theory due to E. C. C. Baly regards colour as due to "isorropesis" or an oscillation between the residual affinities of adjacent atoms composing the molecule.

Fluorescence and Constitution.—The physical investigation of the phenomenon named fluorescence—the property of transforming incident light into light of different refrangibility—is treated in the article FLUORESCENCE. Researches in synthetic organic chemistry have shown that this property of fluorescence is common to an immense number of substances, and theories have been proposed whose purpose is to connect the property with constitution.

In 1897 Richard Meyer (*Zeit. physik. Chemie*, 24, p. 468) submitted the view that fluorescence was due to the presence of certain "fluorophore" groups; such groupings are the pyrone ring and its congeners, the central rings in anthracene and acridine derivatives, and the paradiazine ring in safranines. A novel theory, proposed by J. T. Hewitt in 1900 (*Zeit. f. physik. Chemie*, 34, p. 1; *B.A. Report*, 1903, p. 628, and later papers in the *Journ. Chem. Soc.*), regards the property as occasioned by internal vibrations within the molecule conditioned by a symmetrical double tautomerism, light of one wave-length being absorbed by one form, and emitted with a different wave-length by the other. This oscillation may be represented in the case of acridine and fluorescein as

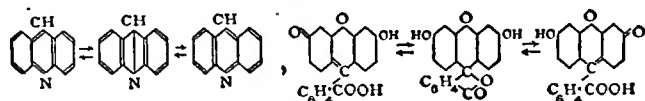

This theory brings the property of fluorescence into relation with that of colour; the forms which cause fluorescence being the coloured modifications: ortho-quinonoid in the case of acridine, para-quinonoid in the case of fluorescein. H. Kauffmann (*Ber.*, 1900, 33, p. 1731; 1904, 35, p. 294; 1905, 38, p. 789; *Ann.*, 1906, 344, p. 30) suggested that the property is due to the presence of at least two groups. The first group, named the "luminophore," is such that when excited by suitable aetherial vibrations emits radiant energy; the other, named the "fluorogen," acts with the luminophore in some way or other to cause the fluorescence. This theory explains the fluorescence of anthranilic acid (*o*-aminobenzoic acid), by regarding the aniline residue as the luminophore, and the carboxyl group as the fluorogen, since, apparently, the introduction of the latter into the non-fluorescent aniline molecule involves the production of a fluorescent substance. Although the theories of Meyer and Hewitt do not explain (in their present form) the behaviour of anthranilic acid, yet Hewitt has shown that his theory goes far to explain the fluorescence of substances in which a double symmetrical tautomerism is possible. This tautomerism may be of a twofold nature:—(1) it may involve the mere oscillation of linkages, as in acridine; or (2) it may involve the oscillation of atoms, as in fluorescein. A theory of a physical nature, based primarily upon Sir J. J. Thomson's theory of corpuscles, has been proposed by J. de Kowalski (*Compt. rend.* 1907, 144, p. 266). We may notice that ethyl oxalosuccinonitrile is the first case of a fluorescent aliphatic compound (see W. Wislicenus and P. Berg, *Ber.*, 1908, 41, p. 3757).

Capillarity and Surface Tension.—Reference should be made to the article CAPILLARY ACTION for the general discussion of this phenomenon of liquids. It is there shown that the surface tension of a liquid may be calculated from its rise in a capillary tube by the formula $\gamma = \frac{1}{2} r h s$, where γ is the surface tension per square centimetre, r the radius of the tube, h the height of the liquid column, and s the difference between the densities of the liquid and its vapour. At the critical point liquid and vapour become identical, and, consequently, as was pointed out by Frankenheim in 1841, the surface tension is zero at the critical temperature.

Mendeléeff endeavoured to obtain a connexion between surface energy and constitution; more successful were the investigations of Schiff, who found that the "molecular surface tension," which he defined as the surface tension divided by the molecular weight, is constant for isomers, and that two atoms of hydrogen were equal to one of carbon, three to one of oxygen, and seven to one of chlorine; but these ratios were by no means constant, and afforded practically no criteria as to the molecular weight of any substance.

In 1886 R. Eötvös (*Wied. Ann.* 27, p. 452), assuming that two liquids may be compared when the ratios of the volumes of the liquids to the volumes of the saturated vapours are the same, deduced that $\gamma V^{\frac{2}{3}}$ (where γ is the surface tension, and V the molecular volume of the liquid) causes all liquids to have the same temperature

coefficients. This theorem was investigated by Sir W. Ramsay and J. Shields (*Journ. Chem. Soc.* 63, p. 1089; 65, p. 167), whose results have thrown considerable light on the subject of the molecular complexity of liquids. Ramsay and Shields suggested that there exists an equation for the surface energy of liquids, analogous to the volume-energy equation of gases, $PV = RT$. The relation they suspected to be of the form $\gamma S = KT$, where K is a constant analogous to R , and S the surface containing one gramme-molecule, γ and T being the surface tension and temperature respectively. Obviously equimolecular surfaces are given by $(Mv)^{\frac{2}{3}}$, where M is the molecular weight of the substance, for equimolecular volumes are Mv , and corresponding surfaces the two-thirds power of this. Hence S may be replaced by $(Mv)^{\frac{2}{3}}$. Ramsay and Shields found from investigations of the temperature coefficient of the surface energy that T in the equation $\gamma(Mv)^{\frac{2}{3}} = KT$ must be counted downwards from the critical temperature τ less about 6° . Their surface energy equation therefore assumes the form $\gamma(Mv)^{\frac{2}{3}} = K(\tau - 6^\circ)$. Now the value of K , γ being measured in dynes and M being the molecular weight of the substance as a gas, is in general 2.121; this value is never exceeded, but in many cases it is less. This diminution implies an association of molecules, the surface containing fewer molecules than it is supposed to. Suppose the coefficient of association be n , i.e. n is the mean number of molecules which associate to form one molecule, then by the normal equation we have $\gamma(Mnv)^{\frac{2}{3}} = 2.121(\tau - 6^\circ)$; if the calculated constant be K_1 , then we have also $\gamma(Mv)^{\frac{2}{3}} = K_1(\tau - 6^\circ)$. By division we obtain $n^{\frac{2}{3}} = 2.121/K_1$, or $n = (2.121/K_1)^{\frac{3}{2}}$, the coefficient of association being thus determined.

The apparatus devised by Ramsay and Shields consisted of a capillary tube, on one end of which was blown a bulb provided with a minute hole. Attached to the bulb was a glass rod and then a tube containing iron wire. This tube was placed in an outer tube containing the liquid to be experimented with; the liquid is raised to its boiling-point, and then hermetically sealed. The whole is enclosed in a jacket connected with a boiler containing a liquid, the vapour of which serves to keep the inner tube at any desired temperature. The capillary tube can be raised or lowered at will by running a magnet outside the tube, and the heights of the columns are measured by a cathetometer or micrometer microscope.

Normal values of K were given by nitrogen peroxide, N_2O_4 , sulphur chloride, S_2Cl_2 , silicon tetrachloride, $SiCl_4$, phosphorus chloride, PCl_3 , phosphoryl chloride, $POCl_3$, nickel carbonyl, $Ni(CO)_4$, carbon disulphide, benzene, pyridine, ether, methyl propyl ketone; association characterized many hydroxylic compounds: for ethyl alcohol the factor of association was 2.74–2.43, for *n*-propyl alcohol 2.86–2.72, acetic acid 3.62–2.77, acetone 1.26, water 3.81–2.32; phenol, nitric acid, sulphuric acid, nitroethane, and propionitril, also exhibit association.

Crystalline Form and Composition.

The development of the theory of crystal structure, and the fundamental principles on which is based the classification of crystal forms, are treated in the article CRYSTALLOGRAPHY; in the same place will be found an account of the doctrine of isomorphism, polymorphism and morphotropy. Here we shall treat the latter subjects in more detail, viewed from the standpoint of the chemist. Isomorphism may be defined as the existence of two or more different substances in the same crystal form and structure, polymorphism as the existence of the same substance in two or more crystal modifications, and morphotropy (after P. von Groth) as the change in crystal form due to alterations in the molecule of closely (chemically) related substances. In order to permit a comparison of crystal forms, from which we hope to gain an insight into the prevailing molecular conditions, it is necessary that some unit of crystal dimensions must be chosen. A crystal may be regarded as built up of primitive parallelepipeda, the edges of which are in the ratio of the crystallographic axes, and the angles the axial angles of the crystals. To reduce these figures to a common standard, so that the volumes shall contain equal numbers of molecules, the notion of molecular volumes is introduced, the arbitrary values of the crystallographic axes (a, b, c) being replaced by the topic parameters¹ (χ, ψ, ω), which are such that, combined with the axial angles, they enclose volumes which contain equal numbers of molecules. The actual values of the topic parameters can then readily be expressed in terms of the elements of the crystals (the axial ratios and angles), the density, and the molecular weight (see Groth, *Physikalische Krystallographie*, or *Chemical Crystallography*).

¹ This was done simultaneously in 1894 by W. Muthmann and A. E. H. Tutton, the latter receiving the idea from F. Becke (see *Journ. Chem. Soc.*, 1896, 69, p. 507; 1905, 87, p. 1183).

Polymorphism.—On the theory that crystal form and structure are the result of the equilibrium between the atoms and molecules composing the crystals, it is probable, *a priori*, that the same substance may possess different equilibrium configurations of sufficient stability, under favourable conditions, to form different crystal structures. Broadly this phenomenon is termed polymorphism; however, it is necessary to examine closely the diverse crystal modifications in order to determine whether they are really of different symmetry, or whether twinning has occasioned the apparent difference. In the article CRYSTALLOGRAPHY the nature and behaviour of twinned crystals receives full treatment; here it is sufficient to say that when the planes and axes of twinning are planes and axes of symmetry, a twin would exhibit higher symmetry (but remain in the same crystal system) than the primary crystal; and, also, if a crystal approximates in its axial constants to a higher system, mimetic twinning would increase the approximation, and the crystal would be pseudo-symmetric.

In general, polysymmetric and polymorphous modifications suffer transformation when submitted to variations in either temperature or pressure, or both. The criterion whether a pseudo-symmetric form is a true polymorph or not consists in the determination of the scalar properties (*e.g.* density, specific heat, &c.) of the original and the resulting modification, a change being in general recorded only when polymorphism exists. Change of temperature usually suffices to determine this, though in certain cases a variation in pressure is necessary; for instance, sodium magnesium uranyl acetate, $\text{NaMg}(\text{UO}_2)_3(\text{C}_2\text{H}_3\text{O}_2)_9 \cdot 9\text{H}_2\text{O}$ shows no change in density unless the observations are conducted under a considerable pressure. Although many pseudo-symmetric twins are transformable into the simpler form, yet, in some cases, a true polymorph results, the change being indicated, as before, by alterations in scalar (as well as vector) properties.

For example, boracite forms pseudo-cubic crystals which become truly cubic at 265° , with a distinct change in density; leucite behaves similarly at about 560° . Again, the pyroxenes, R_2SiO_3 ($\text{R} = \text{Fe, Mg, Mn, \&c.}$), assume the forms (1) monoclinic, sometimes twinned so as to become pseudo-rhombic; (2) rhombic, resulting from the pseudo-rhombic structure of (1) becoming ultramicroscopic; and (3) triclinic, distinctly different from (1) and (2); (1) and (2) are polysymmetric modifications, while (3) and the pair (1) and (2) are polymorphs.

While polysymmetry is solely conditioned by the manner in which the mimetic twin is built up from the single crystals, there being no change in the scalar properties, and the vector properties being calculable from the nature of the twinning, in the case of polymorphism entirely different structures present themselves, both scalar and vector properties being altered; and, in the present state of our knowledge, it is impossible to foretell the characters of a polymorphous modification. We may conclude that in polymorphs the substance occurs in different phases (or molecular aggregations), and the equilibrium between these phases follows definite laws, being dependent upon temperature and pressure, and amenable to thermodynamic treatment (*cf.* CHEMICAL ACTION and ENERGETICS). The transformation of polymorphs presents certain analogies to the solidification of a liquid. Liquids may be cooled below their freezing-point without solidification, the *metastable* (after W. Ostwald) form so obtained being immediately solidified on the introduction of a particle of the solid modification; and supersaturated solutions behave in a similar manner. At the same time there may be conditions of temperature and pressure at which polymorphs may exist side by side.

The above may be illustrated by considering the equilibrium between rhombic and monoclinic sulphur. The former, which is deposited from solutions, is transformed into monoclinic sulphur at about 96° , but with great care it is possible to overheat it and even to fuse it (at 113.5°) without effecting the transformation. Monoclinic sulphur, obtained by crystallizing fused sulphur, melts at 119.5° , and admits of undercooling even to ordinary temperatures, but contact with a fragment of the rhombic modification spontaneously brings about the transformation. From Reicher's determinations, the exact transition point is 95.6° ; it rises with increasing pressure about 0.05° for one atmosphere; the density of the rhombic

form is greater than that of the monoclinic. The equilibria of these modifications may be readily represented on a pressure-temperature diagram. If OT, OP (fig. 6), be the axes of temperature and pressure, and A corresponds to the transition point (95.6°) of rhombic sulphur, we may follow out the line AB which shows the elevation of the transition point with increasing pressure. The overheat curve of rhombic sulphur extends along the curve AC, where C is the melting-point of monoclinic sulphur. The line BC, representing the equilibrium between monoclinic and liquid sulphur, is thermodynamically calculable; the point B is found to correspond to 131 and 400 atmospheres. From B the curve of equilibrium (BD) between rhombic and liquid sulphur proceeds; and from C (along CE) the curve of equilibrium between liquid sulphur and sulphur vapour. Of especial interest is the curve BD; along this line liquid and rhombic sulphur are in equilibrium, which means that at above 131 and 400 atmospheres the rhombic (and not the monoclinic) variety would separate from liquid sulphur.

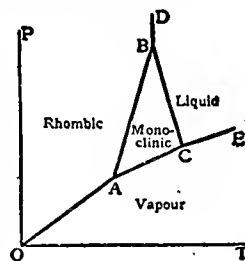

FIG. 6.

Mercuric iodide also exhibits dimorphism. When precipitated from solutions it forms red tetragonal crystals, which, on careful heating, give a yellow rhombic form, also obtained by crystallization from the fused substance, or by sublimation. The transition point is 126.3° (W. Schwarz, *Zeit. f. Kryst.* 25, p. 613), but both modifications may exist in metastable forms at higher and lower temperatures respectively; the rhombic form may be cooled down to ordinary temperature without changing, the transformation, however, being readily induced by a trace of the red modification, or by friction. The density and specific heat of the tetragonal form are greater than those of the yellow.

Hexachlorethane is trimorphous, forming rhombic, triclinic and cubic crystals; the successive changes occur at about 44° and 71° , and are attended by a decrease in density.

Tetramorphism is exhibited by ammonium nitrate. According to O. Lehmann it melts at 168° (or at a slightly lower temperature in its water of crystallization) and on cooling forms optically isotropic crystals; at 125.6° the mass becomes doubly refracting, and from a solution rhombohedral (optically uniaxial) crystals are deposited; by further cooling acicular rhombic crystals are produced at 82.8° , and at 32.4° other rhombic forms are obtained, identical with the product obtained by crystallizing at ordinary temperatures. The reverse series of transformations occurs when this final modification is heated. M. Bellati and R. Romanes (*Zeit. f. Kryst.* 14, p. 78) determined the densities and specific heats of these modifications. The first and third transformations (reckoned in order with increasing temperature of the transition point) are attended by an increase in volume, the second with a contraction; the solubility follows the same direction, increasing up to 82.8° , then diminishing up to 125.6° , and then increasing from this temperature upwards.

The physical conditions under which polymorphous modifications are prepared control the form which the substance assumes. We have already seen that temperature and pressure exercise considerable influence in this direction. In the case of separation from solutions, either by crystallization or by precipitation by double decomposition, the temperature, the concentration of the solution, and the presence of other ions may modify the form obtained. In the case of sodium dihydrogen phosphate, $\text{NaH}_2\text{PO}_4 \cdot \text{H}_2\text{O}$, a stable rhombic form is obtained from warm solutions, while a different, unstable, rhombic form is obtained from cold solutions. Calcium carbonate separates as hexagonal calcite from cold solutions (below 30°), and as rhombic aragonite from solutions at higher temperatures; lead and strontium carbonates, however, induce the separation of aragonite at lower temperatures. From supersaturated solutions the form unstable at the temperature of the experiment is, as a rule, separated, especially on the introduction of a crystal of the unstable form; and, in some cases, similar inoculation of the fused substance is attended by the same result. Different modifications may separate and exist side by side at one and the same time from a solution; *e.g.* telluric acid forms cubic and monoclinic crystals from a hot nitric acid solution, and ammonium fluosilicate gives cubic and hexagonal forms from aqueous solutions between 6° and 13° .

A comparison of the transformation of polymorphs leads to a twofold classification: (1) polymorphs directly convertible in a reversible manner—termed “enantiotropic” by O. Lehmann and (2) polymorphs in which the transformation proceeds in one direction only—termed “monotropic.” In the first class

are included sulphur and ammonium nitrate; monotropy is exhibited by aragonite and calcite.

It is doubtful indeed whether any general conclusions can yet be drawn as to the relations between crystal structure and scalar properties and the relative stability of polymorphs. As a general rule the modification stable at higher temperatures possesses a lower density; but this is by no means always the case, since the converse is true for antimonious and arsenious oxides, silver iodide and some other substances. Attempts to connect a change of symmetry with stability show equally a lack of generality. It is remarkable that a great many polymorphous substances assume more symmetrical forms at higher temperatures, and a possible explanation of the increase in density of such compounds as silver iodide, &c., may be sought for in the theory that the formation of a more symmetrical configuration would involve a drawing together of the molecules, and consequently an increase in density. The insufficiency of this argument, however, is shown by the data for arsenious and antimonious oxides, and also for the polymorphs of calcium carbonate, the more symmetrical polymorphs having a lower density.

Morphotropy.—Many instances have been recorded where substitution has effected a deformation in one particular direction, the crystals of homologous compounds often exhibiting the same angles between faces situated in certain zones. The observations of Slavik (*Zeit. f. Kryst.*, 1902, 36, p. 268) on ammonium and the quaternary ammonium iodides, of J. A. Le Bel and A. Ries (*Zeit. f. Kryst.*, 1902, 1904, et seq.) on the substituted ammonium chlorplatinate, and of G. Mez (*ibid.*, 1901, 35, p. 242) on substituted ureas, illustrate this point.

Ammonium iodide assumes cubic forms with perfect cubic cleavage; tetramethyl ammonium iodide is tetragonal with perfect cleavages parallel to {100} and {001}—a difference due to the lengthening of the a axes; tetraethyl ammonium iodide also assumes tetragonal forms, but does not exhibit the cleavage of the tetramethyl compound; while tetrapropyl ammonium iodide crystallizes in rhombic form. The equivalent volumes and topic parameters are tabulated:

	NH ₄ I.	NMe ₄ I.	NEt ₄ I.	NPr ₄ I.
V	57.51	108.70	162.91	235.95
χ	3.860	5.319	6.648	6.093
ψ	3.860	5.319	6.648	7.851
ω	3.860	3.842	3.686	4.933

From these figures it is obvious that the first three compounds form a morphotropic series; the equivalent volumes exhibit a regular progression; the values of χ and ψ , corresponding to the a axes, are regularly increased, while the value of ω , corresponding to the c axis, remains practically unchanged. This points to the conclusion that substitution has been effected in one of the cube faces. We may therefore regard the nitrogen atoms as occupying the centres of a cubic space lattice composed of iodine atoms, between which the hydrogen atoms are distributed on the tetrahedron face normals. Coplanar substitution in four hydrogen atoms would involve the pushing apart of the iodine atoms in four horizontal directions. The magnitude of this separation would obviously depend on the magnitude of the substituent group, which may be so large (in this case propyl is sufficient) as to cause unequal horizontal deformation and at the same time a change in the vertical direction.

The measure of the loss of symmetry associated with the introduction of alkyl groups depends upon the relative magnitudes of the substituent group and the rest of the molecule; and the larger the molecule, the less would be the morphotropic effect of any particular substituent. The mere retention of the same crystal form by homologous substances is not a sufficient reason for denying a morphotropic effect to the substituent group; for, in the case of certain substances crystallizing in the cubic system, although the crystal form remains unaltered, yet the structures vary. When both the crystal form and structure are retained, the substances are said to be isomorphous.

Other substituent groups exercise morphotropic effects similar to those exhibited by the alkyl radicles; investigations have been made on halogen-, hydroxy-, and nitro-derivatives of benzene and substituted benzenes. To Jaeger is due the determination of the topic parameters of certain haloid-derivatives, and, while showing that the morphotropic effects closely resemble those occasioned by methyl, he established the important fact

that, in general, the crystal form depended upon the orientation of the substituents in the benzene complex.

Benzoic acid is pseudo-tetragonal, the principal axis being remarkably long; there is no cleavage at right angles to this axis. Direct nitration gives (principally) *m*-nitrobenzoic acid, also pseudo-tetragonal with a much shorter principal axis. From this two chloronitrobenzoic acids [COOH·NO₂·Cl = 1.3.6 and 1.3.4] may be obtained. These are also pseudotetragonal; the (1.3.6) acid has nearly the same values of χ and ψ as benzoic acid, but ω is increased; compared with *m*-nitrobenzoic acid, χ and ψ have been diminished, whereas ω is much increased; the (1.3.4) acid is more closely related to *m*-nitrobenzoic acid, χ and ψ being increased, ω diminished. The results obtained for the (1.2) and (1.4) chlorbenzoic acids also illustrate the dependence of crystal form and structure on the orientation of the molecule.

The hydroxyl group also resembles the methyl group in its morphotropic effects, producing, in many cases, no change in symmetry but a dimensional increase in one direction. This holds for benzene and phenol, and is supported by the observations of Gossner on [1.3.5] trinitrobenzene and picric acid (1.3.5-trinitro, 2 oxybenzene); these last two substances assume rhombic forms, and picric acid differs from trinitrobenzene in having ω considerably greater, with χ and ψ slightly less. A similar change, in one direction only, characterizes benzoic acid and salicylic acid.

The nitro group behaves very similarly to the hydroxyl group. The effect of varying the position of the nitro group in the molecule is well marked, and conclusions may be drawn as to the orientation of the groups from a knowledge of the crystal form; a change in the symmetry of the chemical molecule being often attended by a loss in the symmetry of the crystal.

It may be generally concluded that the substitution of alkyl, nitro, hydroxyl, and haloid groups for hydrogen in a molecule occasions a deformation of crystal structure in one definite direction, hence permitting inferences as to the configuration of the atoms composing the crystal; while the nature and degree of the alteration depends (1) upon the crystal structure of the unsubstituted compound; (2) on the nature of the substituting radicle; (3) on the complexity of the substituted molecule; and (4) on the orientation of the substitution derivative.

Isomorphism.—It has been shown that certain elements and groups exercise morphotropic effects when substituted in a compound; it may happen that the effects due to two or more groups are nearly equivalent, and consequently the resulting crystal forms are nearly identical. This phenomenon was first noticed in 1822 by E. Mitscherlich, in the case of the acid phosphate and acid arsenate of potassium, KH₂P(As)O₄, who adopted the term isomorphism, and regarded phosphorus and arsenic as isomorphously related elements. Other isomorphously related elements and groups were soon perceived, and it has been shown that elements so related are also related chemically.

Tutton's investigations of the morphotropic effects of the metals potassium, rubidium and caesium, in combination with the acid radicals of sulphuric and selenic acids, showed that the replacement of potassium by rubidium, and this metal in turn by caesium, was accompanied by progressive changes in both physical and crystallographical properties, such that the rubidium salt was always intermediate between the salts of potassium and caesium (see table; the space unit is taken as a pseudo-hexagonal prism). This fact finds a parallel in the atomic weights of these metals.

	V	χ	ψ	ω
K ₂ SO ₄	64.92	4.464	4.491	4.997
Rb ₂ SO ₄	73.36	4.634	4.664	5.237
Cs ₂ SO ₄	83.64	4.846	4.885	5.519
K ₂ SeO ₄	71.71	4.636	4.662	5.118
Rb ₂ SeO ₄	79.95	4.785	4.826	5.346
Cs ₂ SeO ₄	91.16	4.987	5.035	5.697

By taking appropriate differences the following facts will be observed: (1) the replacement of potassium by rubidium occasions an increase in the equivalent volumes by about eight units, and of rubidium by caesium by about eleven units; (2) replacement in the same order is attended by a general increase in the three topic parameters, a greater increase being met with in the replacement of rubidium by caesium; (3) the parameters χ and ψ are about equally increased, while the increase in ω is always the greatest. Now consider the effect of replacing sulphur by selenium. It will be seen that (1) the increase in equivalent volume is about 6.6; (2) all the topic parameters are increased; (3) the greatest increase is effected in the parameters χ and ψ , which are equally lengthened.

These observations admit of ready explanation in the following

manner. The ordinary structural formula of potassium sulphate is $\begin{matrix} \text{O} \\ \text{K}-\text{O}-\text{S}-\text{O}-\text{K} \\ \text{O} \end{matrix}$. If the crystal structure be regarded as composed of three interpenetrating point systems, one consisting of sulphur atoms, the second of four times as many oxygen atoms, and the third of twice as many potassium atoms, the systems being so arranged that the sulphur system is always centrally situated with respect to the other two, and the potassium system so that it would affect the vertical axis, then it is obvious that the replacement of potassium by an element of greater atomic weight would specially increase the length of ω (corresponding to the vertical axis), and cause a smaller increase in the horizontal parameters (χ and ψ); moreover, the increments would advance with the atomic weight of the replacing metal. If, on the other hand, the sulphur system be replaced by a corresponding selenium system, an element of higher atomic weight, it would be expected that a slight increase would be observed in the vertical parameter, and a greater increase recorded equally in the horizontal parameters.

Muthmann (*Zeit. f. Kryst.*, 1894), in his researches on the tetragonal potassium and ammonium dihydrogen phosphates and arsenates, found that the replacement of potassium by ammonium was attended by an increase of about six units in the molecular volume, and of phosphorus by arsenic by about 4.6 units. In the topic parameters the following changes were recorded: replacement of potassium by ammonium was attended by a considerable increase in ω , χ and ψ being equally, but only slightly, increased; replacement of phosphorus by arsenic was attended by a considerable increase, equally in χ and ψ , while ω suffered a smaller, but not inconsiderable, increase. It is thus seen that the ordinary plane representation of the structure of compounds possesses a higher significance than could have been suggested prior to crystallographical researches.

Identity, or approximate identity, of crystal form is not in itself sufficient to establish true isomorphism. If a substance deposits itself on the faces of a crystal of another substance of similar crystal form, the substances are probably isomorphous. Such parallel overgrowths, termed episomorphs, are very common among the potassium and sodium felspars; and K. von Hauer has investigated a number of cases in which salts exhibiting episomorphism have different colours, thereby clearly demonstrating this property of isomorphism. For example, episomorphs of white potash alum and violet chrome alum, of white magnesium sulphate and green nickel sulphate, and of many other pairs of salts, have been obtained. More useful is the property of isomorphous substances of forming mixed crystals, which are strictly isomorphous with their constituents, for all variations in composition. In such crystals each component

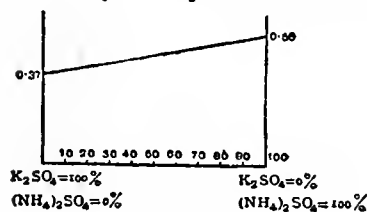

FIG. 7.

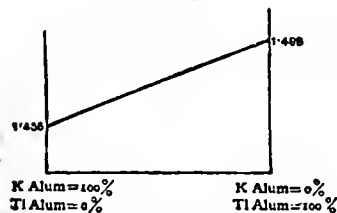

FIG. 8.

In these two instances the component crystals are miscible in all proportions; but this is by no means always the case. It may happen that the crystals do not form double salts, and are only miscible in certain proportions. Two cases then arise: (1) the properties may be expressed as linear functions of the composition, the terminal values being identical with those obtained for the individual components, and there being a break in the curve corresponding to the absence of mixed crystals; or (2) similar to (1) except that different values must be assigned to the terminal values in order to preserve collinearity. Fig. 9 illustrates the first case: the ordinates represent specific volumes, and the abscissae denote the composition of isomorphous mixtures of ammonium and potassium dihydrogen phosphates, which mutually take one another up to the extent of 20% to form homogeneous crystals. The second case is illustrated in fig. 10. Magnesium sulphate (orthorhombic) takes up ferrous

sulphate (monoclinic) to the extent of 19%, forming isomorphous orthorhombic crystals; ferrous sulphate, on the other hand, takes up magnesium sulphate to the extent of 54% to form monoclinic crystals. By plotting the specific volumes of these mixed crystals as ordinates, it is found that they fall on two lines, the upper corresponding to the orthorhombic crystals, the lower to the monoclinic. From this we may conclude that these salts are isodimorphous: the upper line represents isomorphous crystals of stable orthorhombic magnesium sulphate and unstable orthorhombic ferrous sulphate, the lower line isomorphous crystals of stable monoclinic ferrous sulphate and unstable monoclinic magnesium sulphate.

An important distinction separates true mixed crystals and crystallized double salts, for in the latter the properties are not linear functions of the properties of the components; generally there is a contraction in volume, while the refractive indices and other physical properties do not, in general, obey the additive law.

Isomorphism is most clearly discerned between elements of analogous chemical properties; and from the wide generality of such observations attempts have been made to form a classification of elements based on isomorphous replacements. The following table shows where isomorphism may be generally expected. The elements are arranged in eleven series, and the series are subdivided (as indicated by semicolons) into groups; these groups exhibit partial isomorphism with the other groups of the same series (see W. Nernst, *Theoretical Chemistry*).

- Series 1. Cl, Br, I, F; Mn (in permanganates).
2. S, Se; Te (in tellurides); Cr, Mn, Te (in the acids H_2RO_4); As, Sb (in the glances MR_3).
3. As, Sb, Bi; Te (as an element); P, Vd (in salts); N, P (in organic bases).
4. K, Na, Cs, Rb, Li; Tl, Ag.
5. Ca, Ba, Sr, Pb; Fe, Zn, Mn, Mg; Ni, Co, Cu; Ce, La, Di, Er, Y, Ca; Cu, Hg, Pb; Cd, Be, In, Zn; Tl, Pb.
6. Al, Fe, Cr, Mn; Ce, U (in sesquioxides).
7. Cu, Ag (when monovalent); Au.
8. Pt, Ir, Pd, Rh, Ru, Os; Au, Fe, Ni; Sn, Te.
9. C, Si, Ti, Zr, Th, Sn; Fe, Ti.
10. Ta, Cb (Nb).
11. Mo, W, Cr.

For a detailed comparison of the isomorphous relations of the elements the reader is referred to P. von Groth, *Chemical Crystallography*. Reference may also be made to Ida Freund, *The Study of Chemical Composition*; and to the *Annual Reports of the Chemical Society* for 1908, p. 258.

BIBLIOGRAPHY.—History: F. Hofer, *Histoire de la chimie* (2nd ed., 1866–1869); Hermann Kopp, *Geschichte der Chemie* (1869), *Entwicklung der Chemie in d. neueren Zeit* (1871–1874); E. von Meyer, *Geschichte der Chemie* (3rd ed., 1905, Eng. trans.); A. Ladenburg, *Entwicklungsgeschichte der Chemie* (4th ed., 1907); A. Stange, *Die Zeitalter der Chemie* (1908). Reference may also be made to M. M. Pattison Muir, *History of Chemical Theories and Laws* (1907); Ida Freund, *Study of Chemical Composition* (1904); T. E. Thorpe, *Essays in Historical Chemistry* (2nd ed., 1902). See also the article **ALCHEMY**.

Principles and Physical.—W. Ostwald, *Principles of Inorganic Chemistry* (3rd Eng. ed., 1908), *Outlines of General Chemistry*, *Lehrbuch der allgemeinen Chemie*; W. Nernst, *Theoretische Chemie* (4th ed., 1907, Eng. trans.); J. H. van't Hoff, *Lectures on Theoretical and Physical Chemistry*; J. Walker, *Introduction to Physical Chemistry* (4th ed., 1907); H. C. Jones, *Outlines of Physical Chemistry* (1903); D. Mendeléeff, *Principles of Chemistry* (3rd ed., 1905).

Inorganic.—Roscoe and Schorlemmer, *Inorganic Chemistry* (3rd ed., Non-metals, 1905; Metals, 1907); R. Abegg, *Handbuch der anorganischen Chemie*; Gmelin-Kraut, *Handbuch der anorganischen Chemie*; O. Dammer, *Handbuch der anorganischen Chemie*; H. Moissan, *Chimie minérale*.

Organic.—F. Beilstein, *Handbuch der organischen Chemie*; M. M. Richter, *Lexikon der Kohlenstoffverbindungen* (these are primarily works of reference); V. Meyer and P. H. Jacobson, *Lehrbuch der organischen Chemie*; Richter-Anschütz, *Organische Chemie* (11th ed.,

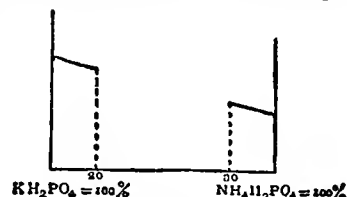

FIG. 9.

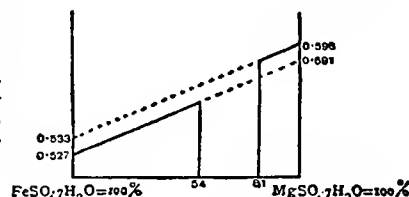

FIG. 10.

vol. i., 1909, Eng. trans.); G. K. Schmidt, *Kurzes Lehrbuch der organischen Chemie*; A. Bernthsen, *Organische Chemie* (Eng. trans.). Practical methods are treated in Lassar-Cohn, *Arbeitsmethoden für organisch-chemische Laboratorien* (4th ed., 1906-1907). Select chapters are treated in A. Lachmann, *Spirit of Organic Chemistry*; J. B. Cohen, *Organic Chemistry* (1908); A. W. Stewart, *Recent Advances in Organic Chemistry* (1908); and in a series of pamphlets issued since 1896 with the title *Sammlung chemischer und chemisch-technischer Vorträge*.

Analytical.—For Blowpipe Analysis: C. F. Plattner, *Probirkunst mit dem Löthrohr*. For General Analysis: C. R. Fresenius, *Qualitative and Quantitative Analysis*, Eng. trans. by C. E. Groves (*Qualitative*, 1887) and A. I. Cohn (*Quantitative*, 1903); F. P. Treadwell, *Kurzes Lehrbuch der analytischen Chemie* (1905); F. Julian, *Textbook of Quantitative Chemical Analysis* (1904); A. Classen, *Ausgewählte Methoden der analytischen Chemie* (1901-1903); W. Crookes, *Select Methods in Chemical Analysis* (1894). Volumetric Analysis: F. Sutton, *Systematic Handbook of Volumetric Analysis* (1904); F. Mohr, *Lehrbuch der chemisch-analytischen Titrimethode* (1896). Organic Analysis: Hans Meyer, *Analyse und Konstitutionsermittlung organischer Verbindungen* (1909); Wilhelm Vaubel, *Die physikalischen und chemischen Methoden der quantitativen Bestimmung organischer Verbindungen*. For the historical development of the proximate analysis of organic compounds see M. E. H. Dennstedt, *Die Entwicklung der organischen Elementaranalyse* (1899).

Encyclopaedias.—The early dictionaries of Muspratt and Watts are out of date; there is a later edition of the latter by H. F. Morley and M. M. P. Muir. A. Ladenburg, *Handwörterbuch der Chemie*, A. Wurtz, *Dictionnaire de chimie*, and F. Selmi, *Enciclopedia di chimica*, are more valuable; the latter two are kept up to date by annual supplements. (C. E.)*

CHEMNITZ (or **KEMNITZ**), **MARTIN** (1522-1586), German Lutheran theologian, third son of Paul Kemnitz, a cloth-worker of noble extraction, was born at Treuenbrietzen, Brandenburg, on the 9th of November 1522. Left an orphan at the age of eleven, he worked for a time at his father's trade. A relative at Magdeburg put him to school there (1539-1542). Having made a little money by teaching, he went (1543) to the university of Frankfort-on-Oder; thence (1545) to that of Wittenberg. Here he heard Luther preach, but was more attracted by Melancthon, who interested him in mathematics and astrology. Melancthon gave him (1547) an introduction to his son-in-law, Georg Sabinus, at Königsberg, where he was tutor to some Polish youths, and rector (1548) of the Kneiphof school. He practised astrology; this recommended him to Duke Albert of Prussia, who made him his librarian (1550). He then turned to Biblical, patristic and kindred studies. His powers were first brought out in controversy with Osiander on justification by faith. Osiander, maintaining the infusion of Christ's righteousness into the believer, impugned the Lutheran doctrine of imputation; Chemnitz defended it with striking ability. As Duke Albert sided with Osiander, Chemnitz resigned the librarianship. Returning (1553) to Wittenberg, he lectured on Melancthon's *Loci Communes*, his lectures forming the basis of his own *Loci Theologici* (published posthumously, 1591), which constitute probably the best exposition of Lutheran theology as formulated and modified by Melancthon. His lectures were thronged, and a university career of great influence lay before him, when he accepted a call to become coadjutor at Brunswick to the superintendent, Joachim Mörlin, who had known him at Königsberg. He removed to Brunswick on the 15th of December 1554, and there spent the remainder of his life, refusing subsequent offers of important offices from various Protestant princes of Germany. Zealous in the duties of his pastoral charge, he took a leading part in theological controversy. His personal influence, at a critical period, did much to secure strictness of doctrine and compactness of organization in the Lutheran Church. Against Crypto-Calvinists he upheld the Lutheran view of the eucharist in his *Repetitio sanae doctrinae de Vera Praesentia* (1560; in German, 1561). To check the reaction towards the old religion he wrote several works of great power, especially his *Theologiae Jesuitarum praecipua capita* (1562), an incisive attack on the principles of the society, and the *Examen concilii Tridentini* (four parts, 1565-66-72-73), his greatest work. His *Corpus doctrinae Prutenicum* (1567), drawn up in conjunction with Mörlin, at once acquired great authority. In the year of its publication he became superintendent of Brunswick, and in effect the director of his church throughout Lower Saxony. His tact was equal to his learning. In conjunc-

tion with Andrea and Selnecker he induced the Lutherans of Saxony and Swabia to adopt the *Formula Concordiae* and so become one body. Against lax views of Socinian tendency he directed his able treatise *De duabus naturis in Christo* (1576). Resigning office in infirm health (1584) he survived till the 8th of April 1586.

Lives of Chemnitz are numerous, e.g. by J. Gasmerus (1588), T. Pressel (1862), C. G. H. Lentz (1866), H. Hachfeld (1867), H. Schmid in J. J. Herzog's *Realencyklopädie* (1878), J. Kunze in A. Hauck's *Realencyklop. für prot. Theol. und Kirche* (1897); that by Hausle, in I. Goschler's *Dict. encyclopédique de la théol. cath.* (1858), gives a Roman Catholic view. (A. Go.)*

CHEMNITZ, a town of Germany, in the kingdom of Saxony, the capital of a governmental district, 50 m. W.S.W. of Dresden and 51 S.E. of Leipzig by rail. Pop. (1885) 110,817; (1895) 161,017; (1905) 244,405. It lies 950 ft. above the sea, in a fertile plain at the foot of the Erzgebirge, watered by the river Chemnitz, an affluent of the Mulde. It is the chief manufacturing town in the kingdom, ranks next to Dresden and Leipzig in point of population, and is one of the principal commercial and industrial centres of Germany. It is well provided with railway communication, being directly connected with Berlin and with the populous and thriving towns of the Erzgebirge and Voigtland. Chemnitz is in general well built, the enormous development of its industry and commerce having of late years led to the laying out of many fine streets and to the embellishing of the town with handsome buildings. The centre is occupied by the market square, with the handsome medieval Rathaus, now superseded for municipal business by a modern building in the Post-strasse. In this square are monuments to the emperor William I., Bismarck and Moltke. The old inner town is surrounded by pleasant promenades, occupying the site of the old fortifications, and it is beyond these that industrial Chemnitz lies, girdling the old town on all sides with a thick belt of streets and factories, and ramifying far into the country. Chemnitz has eleven Protestant churches, among them the ancient Gothic church of St James, with a fine porch, and the modern churches of St Peter, St Nicholas and St Mark. There are also a synagogue and chapels of various sects. The industry of Chemnitz has gained for the town the name of "Saxon Manchester." First in importance are its locomotive and engineering works, which give employment to some 20,000 hands in 90 factories. Next come its cotton-spinning, hosiery, textile and glove manufactures, in which a large trade is done with Great Britain and the United States. It is also the seat of considerable dyeworks, bleachworks, chemical and woollen factories, and produces leather and straps, cement, small vehicles, wire-woven goods, carpets, beer and bricks. The town is well provided with technical schools for training in the various industries, including commercial, public, economic and agricultural schools, and has a chamber of commerce. There are also industrial and historical museums, and collections of painting and natural history. The local communications are maintained by an excellent electric tramway system. To the north-west of the town is the Gothic church of a former Benedictine monastery, dating from 1514-1525, with a tower of 1897. Chemnitz is a favourite tourist centre for excursions into the Erzgebirge, the chain of mountains separating Saxony from Bohemia.

Chemnitz (*Kaminizi*) was originally a settlement of the Sorbian Wends and became a market town in 1143. Its municipal constitution dates from the 14th century, and it soon became the most important industrial centre in the mark of Meissen. A monopoly of bleaching was granted to the town, and thus a considerable trade in woollen and linen yarns was attracted to Chemnitz; paper was made here, and in the 16th century the manufacture of cloth was very flourishing. In 1539 the Reformation was introduced, and in 1546 the Benedictine monastery, founded about 1136 by the emperor Lothair II. about 2 m. north of the town, was dissolved. During the Thirty Years' War Chemnitz was plundered by all parties and its trade was completely ruined, but at the beginning of the 18th century it had begun to recover. Further progress in this direction was made

during the 19th century, especially after 1834 when Saxony joined the German Zollverein.

See Zöllner, *Geschichte der Fabrik- und Handelsstadt Chemnitz* (1891); and Straumer, *Die Fabrik- und Handelsstadt Chemnitz* (1892).

CHEMOTAXIS (from the stem of "chemistry" and Gr. *τάξις*, arrangement), a biological term for the attraction exercised on living or growing organisms or their members by chemical substances, e.g. the attraction of the male cells of ferns or mosses by an organic acid or sugar-solution.

CHENAB (the Greek *Acesines*), one of the "Five rivers" of the Punjab, India. It rises in the snowy Himalayan ranges of Kashmir, enters British territory in the Sialkot district, and flows through the plains of the Punjab, forming the boundary between the Rechna and the Jech Doabs. Finally it joins the Jhelum at Trimmu.

The **CHENAB COLONY**, resulting from the great success of the Chenab Canal in irrigating the desert of the Bar, was formed out of the three adjacent districts of Gujranwala, Jhang, and Montgomery in 1892, and contained in 1901 a population of 791,861. It lies in the Rechna Doab between the Chenab and Ravi rivers in the north-east of the Jhang district, and is designed to include an irrigated area of 2½ million acres. The Chenab canal (opened 1887) is the largest and most profitable perennial canal in India. The principal town is Lyallpur, called after Sir J. Broadwood Lyall, lieutenant-governor of the Punjab 1887-1892, which gives its name to a district created in 1904.

CHÊNEDOLLÉ, CHARLES JULIEN LIOULT DE (1769-1833), French poet, was born at Vire (Calvados) on the 4th of November 1769. He early showed a vocation for poetry, but the outbreak of the Revolution temporarily diverted his energy. Emigrating in 1791, he fought two campaigns in the army of Condé, and eventually found his way to Hamburg, where he met Antoine de Rivarol, of whose brilliant conversation he has left an account. He also visited Mme de Staël in her retreat at Coppet. On his return to Paris in 1799 he met Chateaubriand and his sister Lucile (Mme de Caud), to whom he became deeply attached. After her death in 1804, Chênédollé returned to Normandy, where he married and became eventually inspector of the academy of Caen (1812-1832). With the exception of occasional visits to Paris, he spent the rest of his life in his native province. He died at the château de Coisel on the 2nd of December 1833. He published his *Géné de l'Homme* in 1807, and in 1820 his *Études poétiques*, which had the misfortune to appear shortly after the *Méditations* of Lamartine, so that the author did not receive the credit of their real originality. Chênédollé had many sympathies with the romanticists, and was a contributor to their organ, the *Muse française*. His other works include the *Esprit de Rivarol* (1808) in conjunction with F. J. M. Fayolle.

The works of Chênédollé were edited in 1864 by Sainte-Beuve, who drew portraits of him in his *Chateaubriand et son groupe* and in an article contributed to the *Revue des deux mondes* (June 1849). See also E. Helland, *Étude biographique et littéraire sur Chênédollé* (1857); Cazin, *Notice sur Chênédollé* (1869).

CHENERY, THOMAS (1826-1884), English scholar and editor of *The Times*, was born in 1826 at Barbados. He was educated at Eton and Caius College, Cambridge. Having been called to the bar, he went out to Constantinople as *The Times* correspondent just before the Crimean War, and it was under the influence there of Algernon Smythe (afterwards Lord Strangford) that he first turned to those philological studies in which he became eminent. After the war he returned to London and wrote regularly for *The Times* for many years, eventually succeeding Delane as editor in 1877. He was then an experienced publicist, particularly well versed in Oriental affairs, an indefatigable worker, with a rapid and comprehensive judgment, though he lacked Delane's intuition for public opinion. It was as an Orientalist, however, that he had meantime earned the highest reputation, his knowledge of Arabic and Hebrew being almost unrivalled and his gift for languages exceptional. In 1868 he was appointed Lord Almoner's professor of Arabic at Oxford, and retained his position until he became editor of *The Times*. He was one of the company of revisers of the Old Testament. He was secretary for

some time to the Royal Asiatic Society, and published learned editions of the Arabic classic *The Assemblies of Al-Hariri* and of the *Machberoth Ithiel*. He died in London on the 11th of February 1884.

CHENG, TSCHENG or TSCHIANG (Ger. *Scheng*), an ancient Chinese wind instrument, a primitive organ, containing the principle of the free reed which found application in the accordion, concertina and harmonium. The cheng resembles a tea-pot filled with bamboo pipes of graduated lengths. It consists of a gourd or turned wooden receptacle acting as wind reservoir, in the side of which is inserted an insufflation tube curved like a swan's neck or the spout of a tea-pot. The cup-shaped reservoir is closed by means of a plate of horn pierced with seventeen round holes arranged round the edge in an unfinished circle, into which fit the bamboo pipes. The pipes are cylindrical as far as they are visible above the plate, but the lower end inserted in the wind reservoir is cut to the shape of a beak, somewhat like the mouth-piece of the clarinet, to receive the reed. The construction of the free reed is very simple: it consists of a thin plate of metal—gold according to the Jesuit missionary Joseph Amiot,¹ but brass in the specimens brought to Europe—of the thickness of ordinary paper. In this plate is cut a rectangular flap or tongue which remains fixed at one end, while at the other the tongue is filed so that, instead of closing the aperture, it passes freely through, vibrating as the air is forced through the pipe (see **FREE-REED VIBRATOR**). The metal plate is fastened with wax longitudinally across the diameter of the beak end of the pipe, a little layer of wax being applied also to the free end of the vibrating tongue for the purpose of tuning by adding weight and impetus. About half an inch above the horn plate a small round hole or stop is bored through the pipe, which speaks only when this hole is covered by the finger. A longitudinal aperture about an inch long cut in the upper end of the bamboo pipe serves to determine the length of the vibrating column of air proper to respond to the vibrations of the free reed. The length of the bamboo above this opening is purely ornamental, as are also four or five of the seventeen pipes which have no reeds and do not speak, being merely inserted for the purposes of symmetry in design. The notes of the cheng, like those of the concertina, speak either by inspiration or expiration of air, the former being the more usual method. Mahillon states that performers on the cheng in China are rare, as the method of playing by inspiration induces inflammation of the throat.² Amiot, who gives a description of the instrument with illustrations showing the construction, states that in the great Chinese encyclopaedia *Eulh-ya*, articles *Yu* and *Ho*, the *Yu* of ancient China was the large cheng with nineteen free reeds (twenty-four pipes), and the *Ho* the small cheng with thirteen reeds or seventeen pipes described in this article. The compass of the latter is given by him as the middle octave with chromatic intervals, the thirteenth note giving the octave of the first. Mahillon gives the compass of a modern cheng as follows:



E. F. F. Chladni,³ who examined a cheng sent from China to Herr Müller, organist of the church of St Nicholas, Leipzig, at the beginning of the 19th century, gives an excellent description of the instrument, reproducing in illustration a plate from Giulio Ferrario's work on costume.⁴ Müller's cheng had the same compass as Mahillon's. Chladni's article was motivated by the publication of an account of the exhibition of G. J. Grenié's *Orgue expressif*, invented about 1810, in the Conservatoire of

¹ *Mémoire sur la musique des Chinois* (Paris, 1779), pp. 78 and 82, pl. vi., or *Mémoire sur les Chinois*, tome vi. pl. vi.

² *Catalogue descriptif*, vol. ii. (Ghent, 1896), p. 91; also vol. i. (1880), pp. 29, 44, 154.

³ "Weitere Nachrichten von dem . . . chinesischen Blasinstrumente Tscheng oder Tschiang," in *Allgemeine musikalische Zeitung* (Leipzig, 1821), Bd. xxiii. No. 22, pp. 369, 374 et seq., and illustration appendix ii.

⁴ *Il Costume anticho e moderno* (Milan, 1816), pl. 66, vol. i.

Paris.¹ Grenié's invention, perfected by Alexandre and Debain about 1840, produced the harmonium. Kratzenstein (see under HARMONIUM) of St Petersburg was the first to apply the free reed to the organ in the second half of the 18th century. Inventions of similar instruments, which after a short life were relegated to oblivion, followed at the beginning of the 19th century. An interesting reproduction of a Persian cheng dating from the 10th or 11th century is to be seen on a Persian vase described and illustrated together with a shawm in the *Gazette archéologique* (tome xi., 1886). (K. S.)

CHÊN-HAI [CHINHAI], a district town of China, in the province of Cheh-kiang, at the mouth of the Yung-kiang, 12 m. N.E. of Ningpo, in 29° 58' N., 121° 45' E. It lies at the foot of a hill on a tongue of land, and is partly protected from the sea on the N. by a dike about 3 m. long, composed entirely of large blocks of hewn granite. The walls are 20 ft. high and 3 m. in circumference. The defences were formerly of considerable strength, and included a well-built but now dismantled citadel on a precipitous cliff, 250 ft. high, at the extremity of the tongue of land on which the town is built. In the neighbourhood an engagement took place between the English and Chinese in 1841.

CHÉNIER, ANDRÉ DE (1762-1794), French poet, was born at Constantinople on the 30th of October 1762. His father, Louis Chénier, a native of Languedoc, after twenty years of successful commerce in the Levant as a cloth-merchant, was appointed to a position equivalent to that of French consul at Constantinople. His mother, Elisabeth Santi-Lomaca, whose sister was grandmother of A. Thiers, was a Greek. When the poet was three years old his father returned to France, and subsequently from 1768 to 1775 served as consul-general of France in Morocco. The family, of which André was the third son, and Marie-Joseph (see below) the fourth, remained in France; and after a few years, during which André ran wild with "la tante de Carcasonne," he distinguished himself as a verse-translator from the classics at the Collège de Navarre (the school in former days of Gerson and Bossuet) in Paris. In 1783 he obtained a cadetship in a French regiment at Strassburg. But the glamour of the military life was as soon exhausted by Chénier as it was by Coleridge. He returned to Paris before the end of the year, was well received by his family, and mixed in the cultivated circle which frequented the salon of his mother, among them Lebrun-Pindaré, Lavoisier, Lesueur, Dorat, Parny, and a little later the painter David. He was already a poet by predilection, an idyllist and steeped in the classical archaism of the time, when, in 1784, his taste for the antique was confirmed by a visit to Rome made in the company of two schoolfellows, the brothers Trudaine. From Naples, after visiting Pompeii, he returned to Paris, his mind fermenting with poetical images and projects, few of which he was destined to realize. For nearly three years, however, he was enabled to study and to experiment in verse without any active pressure or interruption from his family—three precious years in which the first phase of his art as a writer of idylls and bucolics, imitated to a large extent from Theocritus, Bion and the Greek anthologists, was elaborated. Among the poems written or at least sketched during this period were *L'Oaristys*, *L'Aveugle*, *La Jeune Malade*, *Bacchus*, *Euphrosine* and *La Jeune Tarentine*, the last a synthesis of his purest manner, mosaic though it is of reminiscences of at least a dozen classical poets. As in glyptic so in poetic art, the Hellenism of the time was decadent and Alexandrine rather than Attic of the best period. But Chénier is always far more than an imitator. *La Jeune Tarentine* is a work of personal emotion and inspiration. The colouring is that of classic mythology, but the spiritual element is as individual as that of any classical poem by Milton, Gray, Keats or Tennyson. Apart from his idylls and his elegies, Chénier also experimented from early youth in didactic and philosophic verse, and when he commenced his *Hermès* in 1783 his ambition was to condense the *Encyclopédie* of Diderot into a poem somewhat after the manner of Lucretius. This poem was to treat of man's position in the Universe, first in an isolated state, and then in society. It remains fragmentary, and though

some of the fragments are fine, its attempt at scientific exposition approximates too closely to the manner of Erasmus Darwin to suit a modern ear. Another fragment called *L'Invention* sums Chénier's *Ars Poetica* in the verse "Sur des penses nouveaux, faisons des vers antiques." *Suzanne* represents the torso of a Biblical poem on a very large scale, in six cantos.

In the meantime, André had published nothing, and some of these last pieces were in fact not yet written, when in November 1787 an opportunity of a fresh career presented itself. The new ambassador at the court of St James's, M. de la Luzerne, was connected in some way with the Chénier family, and he offered to take André with him as his secretary. The offer was too good to be refused, but the poet hated himself on the banks of the *fière Tamise*, and wrote in bitter ridicule of

" Ces Anglais.
Nation toute à vendre à qui peut la payer.
De contrée en contrée allant au monde entier,
Offrir sa joie ignoble et son faste grossier."

He seems to have been interested in the poetic diction of Milton and Thomson, and a few of his verses are remotely inspired by Shakespeare and Gray. To say, however, that he studied English literature would be an exaggeration. The events of 1789 and the startling success of his younger brother, Marie-Joseph, as political playwright and pamphleteer, concentrated all his thoughts upon France. In April 1790 he could stand London no longer, and once more joined his parents at Paris in the rue de Cléry.

The France that he plunged into with such impetuosity was upon the verge of anarchy. A strong constitutionalist, Chénier took the view that the Revolution was already complete and that all that remained to be done was the inauguration of the reign of law. Moderate as were his views and disinterested as were his motives, his tactics were passionately and dangerously aggressive. From an idyllist and elegist we find him suddenly transformed into an unsparing master of poetical satire. His prose *Avis au peuple français* (August 24, 1790) was followed by the rhetorical *Jeu de paume*, a somewhat declamatory moral ode addressed "à Louis David, peintre." In the meantime he orated at the Feuillants Club, and contributed frequently to the *Journal de Paris* from November 1791 to July 1792, when he wrote his scorching *Iambes* to Collot d'Herbois, *Sur les Suisses révoltés du régiment de Châteaueux*. The 10th of August uprooted his party, his paper and his friends, and the management of relatives who kept him out of the way in Normandy alone saved him from the massacre of September. In the month following these events his democratic brother, Marie-Joseph, had entered the Convention. André's sombre rage against the course of events found vent in the line on the Maenads who mutilated the king's Swiss Guard, and in the *Ode à Charlotte Corday* congratulating France that "Un scélérat de moins rampe dans cette fange." At the express request of Malesherbes he furnished some arguments to the materials collected for the defence of the king. After the execution he sought a secluded retreat on the Plateau de Satory at Versailles and took exercise after nightfall. There he wrote the poems inspired by Fanny (Mme Laurent Lecoulteux), including the exquisite *Ode à Versailles*, one of his freshest, noblest and most varied poems.

His solitary life at Versailles lasted nearly a year. On the 7th of March 1794 he was taken at the house of Mme Piscatory at Passy. Two obscure agents of the committee of public safety were in search of a marquise who had flown, but an unknown stranger was found in the house and arrested on suspicion. This was André, who had come on a visit of sympathy. He was taken to the Luxembourg and afterwards to Saint-Lazare. During the 140 days of his imprisonment there he wrote the marvellous *Iambes* (in alternate lines of 12 and 8 syllables), which hiss and stab like poisoned bullets, and which were transmitted to his family by a venal gaoler. There he wrote the best known of all his verses, the pathetic *Jeune captive*, a poem at once of enchantment and of despair. Suffocating in an atmosphere of cruelty and baseness, Chénier's agony found expression almost to the last in these murderous *Iambes* which he launched against the

¹ See *Allg. mus. Zt.* (Leipzig, 1821), Bd. xxiii. Nos. 9 and 10, pp. 133 and 149 et seq.

Convention. Ten days before the end, the painter J. B. Suvée executed the well known portrait. He might have been overlooked but for the well-meant, indignant officiousness of his father. Marie-Joseph had done his best to prevent this, but he could do nothing more. Robespierre, who was himself on the brink of the volcano, remembered the venomous sallies in the *Journal de Paris*. At sundown on the 25th of July 1794, the very day of his condemnation on a bogus charge of conspiracy, André Chénier was guillotined. The record of his last moments by La Touche is rather melodramatic and is certainly not above suspicion.

Incomplete as was his career—he was not quite thirty-two—his life was cut short in a crescendo of all its nobler elements. Exquisite as was already his susceptibility to beauty and his mastership of the rarest poetic material, we cannot doubt that Chénier was preparing for still higher flights of lyric passion and poetic intensity. Nothing that he had yet done could be said to compare in promise of assured greatness with the *Iambes*, the *Odes* and the *Jeune Captive*. At the moment he left practically nothing to tell the world of his transcendent genius, and his reputation has had to be retrieved from oblivion page by page, and almost poem by poem. During his lifetime only his *Jeu de paume* (1791) and *Hymne sur les Suisses* (1792) had been given to the world. The *Jeune Captive* appeared in the *Décade philosophique*, Jan. 9, 1795; *La Jeune Tarentine* in the *Mercur* of March 22, 1801. Chateaubriand quoted three or four passages in his *Génie du christianisme*. Fayette and Lefevre-Deumier also gave a few fragments; but it was not until 1819 that a first imperfect attempt was made by H. de la Touche to collect the poems in a substantive volume. Since the appearance of the *editio princeps* of Chénier's poems in La Touche's volume, many additional poems and fragments have been discovered, and an edition of the complete works of the poet, collated with the MSS. bequeathed to the Bibliothèque Nationale by Mme Elisa de Chénier in 1892, has been edited by Paul Dimoff and published by Delagrave. During the same period the critical estimates of the poet have fluctuated in a truly extraordinary manner. Sainte-Beuve in his *Tableau* of 1828 sang the praises of Chénier as an heroic forerunner of the Romantic movement and a precursor of Victor Hugo. Chénier, he said, had "inspired and determined" Romanticism. This suggestion of modernity in Chénier was echoed by a chorus of critics who worked the idea to death; in the meantime, the standard edition of Chénier's works was being prepared by M. Becq de Fouquières and was issued in 1862, but rearranged and greatly improved by the editor in 1872. The same patient investigator gave his *New Documents on André Chénier to the world in 1875*.

In the second volume of *La Vie littéraire* Anatole France contests the theory of Sainte-Beuve. Far from being an initiator, he maintains that Chénier's poetry is the last expression of an expiring form of art. His matter and his form belong of right to the classic spirit of the 18th century. He is a contemporary, not of Hugo and Leconte de Lisle, but of Suard and Morellet. M. Faguet sums up on the side of M. France in his volume on the 18th century (1890). Chénier's real disciples, according to the latest view, are Leconte de Lisle and M. de Heredia, *mosaïstes* who have at heart the cult of antique and pagan beauty, of "pure art" and of "objective poetry." Heredia himself reverted to the judgment of Sainte-Beuve to the effect that Chénier was the first to make modern verses, and he adds, "I do not know in the French language a more exquisite fragment than the three hundred verses of the *Bucoliques*." Chénier's influence has been specially remarkable in Russia, where Pushkin imitated him, Kogloff translated *La Jeune Captive*, *La jeune Tarentine* and other famous pieces, while the critic Vessclovsky pronounces "Il a rétabli le lyrisme pur dans la poésie française." The general French verdict on his work is in the main well summed by Morillot, when he says that, judged by the usual tests of the Romantic movement of the 'twenties (love for strange literatures of the North, medievalism, novelties and experiments), Chénier would inevitably have been excluded from the *cénacle* of 1827. On the other hand, he exhibits a decided tendency to

the world-ennui and melancholy which was one of the earlier symptoms of the movement, and he has experimented in French verse in a manner which would have led to his excommunication by the typical performers of the 18th century. What is universally admitted is that Chénier was a very great artist, who like Ronsard opened up sources of poetry in France which had long seemed dried up. In England it is easier to feel his attraction than that of some far greater reputations in French poetry, for, rhetorical though he nearly always is, he yet reveals something of that quality which to the Northern mind has always been of the very essence of poetry, that quality which made Sainte-Beuve say of him that he was the first great poet "personnel et rêveur" in France since La Fontaine. His diction is still very artificial, the poetic diction of Delille transformed in the direction of Hugo, but not very much. On the other hand, his descriptive power in treating of nature shows far more art than the Trianon school ever attained. His love of the woodland and his political fervour often remind us of Shelley, and his delicate perception of Hellenic beauty, and the perfume of Greek legend, give us almost a foretaste of Keats. For these reasons, among others, Chénier, whose art is destined to so many vicissitudes of criticism in his own country, seems assured among English readers of a place among the *Die Majores* of French poetry.

The Chénier literature of late years has become enormous. His fate has been commemorated in numerous plays, pictures and poems, notably in the fine epilogue of Sully Prudhomme, the *Stello* of A. de Vigny, the delicate statue by Puech in the Luxembourg, and the well-known portrait in the centre of the "Last Days of the Terror." The best editions are still those of Becq de Fouquières (Paris, 1862, 1872 and 1881), though these are now supplemented by those of L. Moland (2 vols., 1889) and R. Guillard (2 vols., 1899). (T. SE.)

CHÉNIER, MARIE-JOSEPH BLAISE DE (1764-1811), French poet, dramatist and politician, younger brother of André de Chénier, was born at Constantinople on the 11th of February 1764.¹ He was brought up at Carcassonne, and educated in Paris at the Collège de Navarre. Entering the army at seventeen, he left it two years afterwards; and at nineteen he produced *Azémire*, a two-act drama (acted in 1786), and *Edgar, ou le page supposé*, a comedy (acted in 1785), which were failures. His *Charles IX* was kept back for nearly two years by the censor. Chénier attacked the censorship in three pamphlets, and the commotion aroused by the controversy raised keen interest in the piece. When it was at last produced on the 4th of November 1789, it achieved an immense success, due in part to its political suggestion, and in part to Talma's magnificent impersonation of Charles IX. Camille Desmoulins said that the piece had done more for the Revolution than the days of October, and a contemporary memoir-writer, the marquis de Ferrière, says that the audience came away "ivre de vengeance et tourmenté d'une soif de sang." The performance was the occasion of a split among the actors of the Comédie Française, and the new theatre in the Palais Royal, established by the dissidents, was inaugurated with *Henri VIII* (1791), generally recognized as Chénier's masterpiece; *Jean Calas, ou l'école des juges* followed in the same year. In 1792 he produced his *Caius Gracchus*, which was even more revolutionary in tone than its predecessors. It was nevertheless proscribed in the next year at the instance of the Montagnard deputy Albitte, for an anti-anarchical hemistich (*Des lois et non du sang!*); *Fénelon* (1793) was suspended after a few representations; and in 1794 his *Timoléon*, set to Étienne Méhul's music, was also proscribed. This piece was played after the fall of the Terror, but the fratricide of Timoléon became the text for insinuations to the effect that by his silence Joseph de Chénier had connived at the judicial murder of André, whom Joseph's enemies alluded to as *Abel*. There is absolutely nothing to support the calumny, which has often been repeated since. In fact, after some fruitless attempts to save his brother, variously related by his biographers, Joseph became aware that André's only chance of safety lay in being forgotten by the authorities, and that ill-advised intervention would only hasten the end. Joseph Chénier had been a member of the Convention and of

¹ This is the date given by G. de Chénier in his *La Vérité sur la famille de Chénier* (1844).

the Council of Five Hundred, and had voted for the death of Louis XVI.; he had a seat in the tribunate; he belonged to the committees of public instruction, of general security, and of public safety. He was, nevertheless, suspected of moderate sentiments, and before the end of the Terror had become a marked man. His purely political career ended in 1802, when he was eliminated with others from the tribunate for his opposition to Napoleon. In 1801 he was one of the educational jury for the Seine; from 1803 to 1806 he was inspector-general of public instruction. He had allowed himself to be reconciled with Napoleon's government, and *Cyrus*, represented in 1804, was written in his honour, but he was temporarily disgraced in 1806 for his *Épître à Voltaire*. In 1806 and 1807 he delivered a course of lectures at the Athénée on the language and literature of France from the earliest years; and in 1808 at the emperor's request, he prepared his *Tableau historique de l'état et du progrès de la littérature française depuis 1789 jusqu'à 1808*, a book containing some good criticism, though marred by the violent prejudices of its author. He died on the 10th of January 1811. The list of his works includes hymns and national songs—among others, the famous *Chant du départ*; odes, *Sur la mort de Mirabeau*, *Sur l'oligarchie de Robespierre*, &c; tragedies which never reached the stage, *Brutus et Cassius*, *Philippe deux, Tibère*; translations from Sophocles and Lessing, from Gray and Horace, from Tacitus and Aristotle; with elegies, dithyrambs and Ossianic rhapsodies. As a satirist he possessed great merit, though he sins from an excess of severity, and is sometimes malignant and unjust. He is the chief tragic poet of the revolutionary period, and as Camille Desmoulins expressed it, he decorated Melpomene with the tricolour cockade.

See the *Œuvres complètes de Joseph Chénier* (8 vols., Paris, 1823–1826), containing notices of the poet by Arnault and Daunou; Charles Labitte, *Études littéraires* (1846); Henri Welschinger, *Le Théâtre révolutionnaire, 1789–1799* (1881); and A. Lieby, *Étude sur le théâtre de Marie-Joseph Chénier* (1902).

CHENILLE (from the Fr. *chenille*, a hairy caterpillar), a twisted velvet cord, woven so that the short outer threads stand out at right angles to the central cord, thus giving a resemblance to a caterpillar. Chenille is used as a trimming for dress and furniture.

CHENONCEAUX, a village of central France, in the department of Indre-et-Loire, on the right bank of the Cher, 20 m. E. by S. of Tours on the Orléans railway. Pop. (1906) 216. Chenonceaux owes its interest to its château (see ARCHITECTURE: *Renaissance Architecture in France*), a building in the Renaissance style on the river Cher, to the left bank of which it is united by a two-storeyed gallery built upon five arches, and to the right by a drawbridge flanked by an isolated tower, part of an earlier building of the 15th century. Founded in 1515 by Thomas Bohier (d. 1523), financial minister in Normandy, the château was confiscated by Francis I. in 1535. Henry II. presented it to his mistress Diane de Poitiers, who on his death was forced to exchange it for Chaumont-sur-Loire by Catherine de' Medici. The latter built the gallery which leads to the left bank of the Cher. Chenonceaux passed successively into the hands of Louise de Vaudémont, wife of Henry III., the house of Vendôme, and the family of Bourbon-Condé. In the 18th century it came into the possession of the farmer-general Claude Dupin (1684–1769), who entertained the most distinguished people in France within its walls. In 1864 it was sold to the chemist Théophile Pérouze, whose wife executed extensive restorations. It subsequently became the property of the Crédit Foncier, and again passed into private occupancy.

CHENOPODIUM, or GOOSE-FOOT, a genus of erect or prostrate herbs (natural order Chenopodiaceae), usually growing on the seashore or on waste or cultivated ground. The green angular stem is often striped with white or red, and, like the leaves, often more or less covered with mealy hairs. The leaves are entire, lobed or toothed, often more or less deltoid or triangular in shape. The minute flowers are bisexual, and borne in dense axillary or terminal clusters or spikes. The fruit is a membranous one-seeded utricle often enclosed by the persistent calyx. Ten species occur in Britain, one of which, *C. Bonus-Henricus*, Good

King Henry, is cultivated as a pot-herb, in lieu of asparagus under the name mercury, and all-good.

CHEOPS, in Herodotus, the name of the king who built the Great Pyramid in Egypt. Following on a period of good rule and prosperity under Rhampsinitus, Cheops closed the temples, abolished the sacrifices and made all the Egyptians labour for his monument, working in relays of 100,000 men every three months (see PYRAMID). Proceeding from bad to worse, he sacrificed the honour of his daughter in order to obtain the money to complete his pyramid; and the princess built herself besides a small pyramid of the stones given to her by her lovers. Cheops reigned 50 years and was succeeded by his brother, Chephren, who reigned 56 years and built the second pyramid. During these two reigns the Egyptians suffered every kind of misery and the temples remained closed. Herodotus continues that in his own day the Egyptians were unwilling to name these oppressors and preferred to call the pyramids after a shepherd named Philiton, who pastured his flocks in their neighbourhood. At length Mycerinus, son of Cheops and successor of Chephren, reopened the temples and, although he built the Third Pyramid, allowed the oppressed people to return to their proper occupations.

Cheops, Chephren and Mycerinus are historical personages of the fourth Egyptian dynasty, in correct order, and they built the three pyramids attributed to them here. But they are wholly misplaced by Herodotus. Rhampsinitus, the predecessor of Cheops, appears to represent Rameses III. of the twentieth dynasty, and Mycerinus in Herodotus is but a few generations before Psammetichus, the founder of the twenty-sixth dynasty. Manetho correctly places the great Pyramid kings in Dynasty IV. In Egyptian the name of Cheops (Chemmisor Chembisin Diodorus Siculus, Suphis in Manetho) is spelt Hwfw (Khufu), but the pronunciation, in late times perhaps Khôouf, is uncertain. The Greeks and Romans generally accepted the view that Herodotus supplies of his character, and moralized on the uselessness of his stupendous work; but there is nothing else to prove that the Egyptians themselves execrated his memory. Modern writers rather dwell on the perfect organization demanded by his scheme, the training of a nation to combined labour, the level attained here by art and in the fitting of masonry, and finally the fact that the Great Pyramid was the oldest of the seven wonders of the ancient world and now alone of them survives. It seems that representations of deities, and indeed any representations at all, were rare upon the polished walls of the great monuments of the fourth dynasty, and Petrie thinks that he can trace a violent religious revolution with confiscation of endowments at this time in the temple remains at Abydos; but none the less the wants of the deities were then attended to by priests selected from the royal family and the highest in the land. Khufu's work in the temple of Bubastis is proved by a surviving fragment, and he is figured slaying his enemy at Sinai before the god Thoth. In late times the priests of Denderah claimed Khufu as a benefactor; he was reputed to have built temples to the gods near the Great Pyramids and Sphinx (where also a pyramid of his daughter Hentsen is spoken of), and there are incidental notices of him in the medical and religious literature. The funerary cult of Khufu and Khafre was practised under the twenty-sixth dynasty, when so much that had fallen into disuse and been forgotten was revived. Khufu is a leading figure in an ancient Egyptian story (Papyrus Westcar), but it is unfortunately incomplete. He was the founder of the fourth dynasty, and was probably born in Middle Egypt near Beni Hasan, in a town afterwards known as "Khufu's Nurse," but was connected with the Memphite third dynasty. Two tablets at the mines of Wadi Maghara in the peninsula of Sinai, a granite block from Bubastis, and a beautiful ivory statuette found by Petrie in the temple at Abydos, are almost all that can be definitely assigned to Khufu outside the pyramid at Giza and its ruined accompaniments. His date, according to Petrie, is 3969–3908 B.C., but in the shorter chronology of Meyer, Breasted and others he reigned (23 years) about a thousand years later, c. 2900 B.C.

See Herodotus ii. 124; Diodorus Siculus i. 64; Sethe in Pauly-Wissowa's *Realencyclopädie*, s.v.; W. M. F. Petrie, *History of Egypt*, vol. i., and *Abydos*, part ii. p. 48; J. H. Breasted, *History*.
(F. L. L. G.)

CHEPSTOW, a market town and river-port in the southern parliamentary division of Monmouthshire, England, on the Wye, 2 m. above its junction with the Severn, and on the Great Western railway. Pop. of urban district (1901) 3067. It occupies the slope of a hill on the western (left) bank of the river, and is environed by beautiful scenery. The church of St Mary, originally the conventual chapel of a Benedictine priory of Norman foundation, has remains of that period in the west front and the nave, but a rebuilding of the chancel and transepts was effected in the beginning of the 19th century. The church contains many interesting monuments. The castle, still a magnificent pile, was founded in the 11th century by William Fitz-Osbern, earl of Hereford, but was almost wholly rebuilt in the 13th. There are, however, parts of the original building in the keep. The castle occupies a splendid site on the summit of a cliff above the Wye, and covers about 3 acres. The river is crossed by a fine iron bridge of five arches, erected in 1816, and by a tubular railway bridge designed by Sir Isambard Brunel. There is a free passage on the Wye for large vessels as far as the bridge. From the narrowness and depth of the channel the tide rises suddenly and to a great height, forming a dangerous bore. The exports are timber, bark, iron, coal, cider and millstones. Some shipbuilding is carried on.

As the key to the passage of the Wye, Chepstow (*Estrighorel*, *Striguil*) was the site successively of British, Roman and Saxon fortifications. Domesday Book records that the Norman castle was built by William Fitz-Osbern to defend the Roman road into South Wales. On the confiscation of his son's estates, the castle was granted to the earls of Pembroke, and after its reversion to the crown in 1306, Edward II. in 1310 granted it to his half-brother Thomas de Brotherton. On the latter's death it passed, through his daughter Margaret, Lady Segrave, to the dukes of Norfolk, from whom, after again reverting to the crown, it passed to the earls of Worcester. It was confiscated by parliament and settled on Oliver Cromwell, but was restored to the earls in 1660. The borough must have grown up between 1310, when the castle and vill were granted to Thomas de Brotherton, and 1432, when John duke of Norfolk died seized of the castle, manor and borough of Striguil. In 1524 Charles, first earl of Worcester and then lord of the Marches, granted a new charter of incorporation to the bailiffs and burgesses of the town, which had fallen into decay. This was sustained until the reign of Charles II., when, some dispute arising between the earl of Bridgwater and the burgesses, no bailiff was appointed and the charter lapsed. Chepstow was afterwards governed by a board of twelve members. A port since early times, when the lord took dues of ships going up to the forest of Dean, Chepstow had no ancient market and no manufactures but that of glass, which was carried on for a short time within the ruins of the castle.

CHEQUE, or **CHECK**, in commercial law, a bill of exchange drawn on a banker and signed by the drawer, requiring the banker to pay on demand a certain sum in money to or to the order of a specified person or to bearer. In this, its most modern sense, the cheque is the outcome of the growth of the banking system of the 19th century. For details see **BANKS AND BANKING: Law**, and **BILL OF EXCHANGE**. The word check,¹ of which "cheque" is a variant now general in English usage, signified merely the counterfoil or indent of an exchequer bill, or any draft form of payment, on which was registered the particulars of the principal part, as a check to alteration or forgery. The

¹ The original meaning of "check" is a move in the game of chess which directly attacks the king; the word comes through the Old Fr. *eschec*, *eschac*, from the Med. Lat. form *scaccus* of the Persian *shāh*, king, i.e. the king in the game of chess; cf. the origin of "mate" from the Arabic *shah-mat*, the king is dead. The word was early used in a transferred sense of a stoppage or rebuff, and so is applied to anything which stops or hinders a matter in progress, or which controls or restrains anything, hence a token, ticket or counterfoil which serves as a means of identification, &c.

check or counterfoil parts remained in the hands of the banker, the portion given to the customer being termed a "drawn note" or "draft." From the beginning of the 19th century the word "cheque" gradually became synonymous with "draft" as meaning a written order on a banker by a person having money in the banker's hands, to pay some amount to bearer or to a person named. Ultimately, it entirely superseded the word "draft," and has now a statutory definition (Bills of Exchange Act 1882, s. 73)—"a bill of exchange drawn on a banker payable on demand." The word "draft" has come to have a wider meaning, that of a bill drawn by one person on another for a sum of money, or an order (whether on a banker or other) to pay money. The employment of cheques as a method of payment offering greater convenience than coin is almost universal in Great Britain and the United States. Of the transactions through the banks of the United Kingdom between 86 and 90% are conducted by means of cheques, and an even higher proportion in the United States. On the continent of Europe the use of cheques, formerly rare, is becoming more general, particularly in France, and to some extent in Germany.

CHER, a department of central France, embracing the eastern part of the ancient province of Berry, and parts of Bourbonnais, Nivernais and Orléanais, bounded N. by the department of Loiret, W. by Loir-et-Cher and Indre, S. by Allier and Creuse, and E. by Nièvre. Pop. (1906) 343,484. Area 2819 sq. m. The territory of the department is elevated in the south, where one point reaches 1654 ft., and in the east. The centre is occupied by a wide calcareous table-land, to the north of which stretches the plain of Sologne. The principal rivers, besides the Cher and its tributaries, are the Grande Sauldre and the Petite Sauldre on the north, but the Loire and Allier, though not falling within the department, drain the eastern districts, and are available for navigation. The Cher itself becomes navigable when it receives the Arnon and Yèvre, and the communications of the department are greatly facilitated by the Canal du Berry, which traverses it from east to west, the lateral canal of the Loire, which follows the left bank of that river, and the canal of the Sauldre. The climate is temperate, and the rainfall moderate. Except in the Sologne, the soil is generally fertile, but varies considerably in different localities. The most productive region is that on the east, which belongs to the valley of the Loire; the central districts are tolerably fertile but marshy, being often flooded by the Cher; while in the south and south-west there is a considerable extent of dry and fertile land. Wheat and oats are largely cultivated, while hemp, vegetables and various fruits are also produced. The vine flourishes chiefly in the east of the arrondissement of Sancerre. The department contains a comparatively large extent of pasturage, which has given rise to a considerable trade in horses, cattle, sheep and wool for the northern markets. Nearly one-fifth of the whole area consists of forest. Mines of iron are worked, and various sorts of stone are quarried. Brick, porcelain and glassworks employ large numbers of the inhabitants. There are also flour-mills, distilleries, oil-works, saw-mills and tanneries. Bourges and Vierzon are metallurgical and engineering centres. Coal and wine are leading imports, while cereals, timber, wool, fruit and industrial products are exported. The department is served by the Orléans railway, and possesses in all more than 300 m. of navigable waterways. It is divided into three arrondissements (29 cantons, 292 communes) cognominal with the towns of Bourges, Saint-Amand-Mont-Rond, and Sancerre, of which the first is the capital, the seat of an archbishop and of a court of appeal and headquarters of the VIII. army-corps. The department belongs to the *académie* (educational division) of Paris. Bourges, Saint-Amand-Mont-Rond, Vierzon and Sancerre (*q.v.*) are the principal towns. Méhun-sur-Yèvre (pop. 5227), a town with an active manufacture of porcelain, has a Romanesque church and a château of the 14th century. Among the other interesting churches of the department, that at St Satur has a fine choir of the 14th and 15th centuries; those of Dun-sur-Auron, Plaimpied, Aix d'Angillon and Jeanvrin are Romanesque in style, while Aubigny-Ville has a church of the 12th, 13th and

15th centuries and a château of later date. Drevant, built on the site of a Roman town, preserves ruins of a large theatre and other remains. Among the megalithic monuments of Cher, the most notable is that at Villeneuve-sur-Cher, known as the Pierre-de-la-Roche.

CHERAT, a hill cantonment and sanatorium in the Peshawar district of the North-West Frontier Province, India, 34 m. S.E. of Peshawar. It is situated at an elevation of 4500 ft., on the west of the Khattak range, which divides the Peshawar from the Kohat district. It was first used in 1861, and since then has been employed during the hot weather as a health station for the British troops quartered in the hot and malarious vale of Peshawar.

CHERBOURG, a naval station, fortified town and seaport of north-western France, capital of an arrondissement in the department of Manche, on the English Channel, 232 m. W.N.W. of Paris on the Ouest-État railway. Pop. (1906) town, 35,710; commune, 43,827. Cherbourg is situated at the mouth of the Divette, on a small bay at the apex of the indentation formed by the northern shore of the peninsula of Cotentin. Apart from a fine hospital and the church of La Trinité dating from the 15th century, the town has no buildings of special interest. A rich collection of paintings is housed in the hôtel de ville. A statue of the painter J. F. Millet, born near Cherbourg, stands in the public garden, and there is an equestrian statue of Napoleon I. in the square named after him. Cherbourg is a fortified place of the first class, headquarters of one of the five naval arrondissements of France, and the seat of a sub-prefect. It has tribunals of first instance and of commerce, a chamber of commerce, a lycée and a naval school. The chief industries of the town proper are fishing, saw-milling, tanning, leather-dressing, ship-building, iron and copper-founding, rope-making and the manufacture of agricultural implements. There are stone quarries in the environs, and the town has trade in farm produce.

Cherbourg derives its chief importance from its naval and commercial harbours, which are distant from each other about half a mile. The former consists of three main basins cut out of the rock, and has an area of 55 acres. The minimum depth of water is 30 ft. Connected with the harbour are dry docks, the yards where the largest ships in the French navy are constructed, magazines, rope walks, and the various workshops requisite for a naval arsenal of the first class. The works and town are carefully guarded on every side by redoubts and fortifications, and are commanded by batteries on the surrounding hills. There is a large naval hospital close to the harbour. The commercial harbour at the mouth of the Divette communicates with the sea by a channel 650 yds. long. It consists of two parts, an outer and tidal harbour 17½ acres in extent, and an inner basin 15 acres in extent, with a depth on sill at ordinary spring tide of 25 ft. Outside these harbours is the triangular bay, which forms the roadstead of Cherbourg. The bay is admirably sheltered by the land on every side but the north. On that side it is sheltered by a huge breakwater, over 2 m. in length, with a width of 650 ft. at its base and 30 ft. at its summit, which is protected by forts, and leaves passages for vessels to the east and west. These passages are guarded by forts placed on islands intervening between the breakwater and the mainland, and themselves united to the land by breakwaters. The surface within these barriers amounts to about 3700 acres. Cherbourg is a port of call for the American, North German Lloyd and other important lines of transatlantic steamers. The chief exports are stone for road-making, butter, eggs and vegetables; the chief imports are coal, timber, superphosphates and wine from Algeria. Great Britain is the principal customer.

Cherbourg is supposed by some investigators to occupy the site of the Roman station of *Coriallum*, but nothing definite is known about its origin. The name was long regarded as a corruption of *Caesaris Burgus* (Caesar's Borough). William the Conqueror, under whom it appears as *Carusbur*, provided it with a hospital and a church; and Henry II. of England on several occasions chose it as his residence. In 1295 it was

pillaged by an English fleet from Yarmouth; and in the 14th century it frequently suffered during the wars against the English. Captured by the English in 1418 after a four months' siege, it was recovered by Charles VII. of France in 1450. An attempt was made under Louis XIV. to construct a military port; but the fortifications were dismantled in 1688, and further damage was inflicted by the English in 1758. In 1686 Vauban planned harbour-works which were begun under Louis XVI. and continued by Napoleon I. It was left, however, to Louis Philippe, and particularly to Napoleon III., to complete them, and their successful realization was celebrated in 1858, in the presence of the queen of England, against whose dominions they had at one time been mainly directed. At the close of 1857, £8,000,000, of which the breakwater cost over £2,500,000, had been expended on the works; in 1889 a further sum of £680,000 was voted by the Chamber of Deputies for the improvement of the port.

CHERBULIEZ, CHARLES VICTOR (1829-1899), French novelist and miscellaneous writer, was born on the 19th of July 1829, at Geneva, where his father, André Cherbuliez (1795-1874), was a classical professor at the university. He was descended from a family of Protestant refugees, and many years later Victor Cherbuliez resumed his French nationality, taking advantage of an act passed in the early days of the Revolution. Geneva was the scene of his early education; thence he proceeded to Paris, and afterwards to the universities of Bonn and Berlin. He returned to his native town and engaged in the profession of teaching. After his resumption of French citizenship he was elected a member of the Academy (1881), and having received the Legion of Honour in 1870, he was promoted to be officer of the order in 1892. He died on the 1st of July 1899. Cherbuliez was a voluminous and successful writer of fiction. His first book, originally published in 1860, reappeared in 1864 under the title of *Un Cheval de Phidias*: it is a romantic study of art in the golden age of Athens. He went on to produce a series of novels, of which the following are the best known:—*Le Comte Kostia* (1863), *Le Prince Vitale* (1864), *Le Roman d'une honnête femme* (1866), *L'Aventure de Ladislas Bolski* (1869), *Miss Rovet* (1875), *Samuel Brohl et Cie* (1877), *L'Idée de Jean Têlerol* (1878), *Noirs et rouges* (1881), *La Vocation du Comte Ghislain* (1888), *Une Gageure* (1890), *Le Secret du précepteur* (1893), *Jacquine Vanesse* (1898), &c. Most of these novels first appeared in the *Revue des deux mondes*, to which Cherbuliez also contributed a number of political and learned articles, usually printed with the pseudonym G. Valbert. Many of these have been published in collected form under the titles *L'Allemagne politique* (1870), *L'Espagne politique* (1874), *Profilis étrangers* (1889), *L'Art et la nature* (1892), &c. The volume *Études de littérature et d'art* (1873) includes articles for the most part reprinted from *Le Temps*. The earlier novels of Cherbuliez have been said with truth to show marked traces of the influence of George Sand; and in spite of modification, his method was that of an older school. He did not possess the sombre power or the intensely analytical skill of some of his later contemporaries, but his books are distinguished by a freshness and honesty, fortified by cosmopolitan knowledge and lightened by unobtrusive humour, which fully account for their wide popularity in many countries besides his own. His genius was the reverse of dramatic, and attempts to present two of his stories on the stage have not succeeded. His essays have all the merits due to liberal observation and thoroughness of treatment; their style, like that of the novels, is admirably lucid and correct. (C.)

CHERCHEL, a seaport of Algeria, in the arrondissement and department of Algiers, 55 m. W. of the capital. It is the centre of an agricultural and vine-growing district, but is commercially of no great importance, the port, which consists of part only of the inner port of Roman days, being small and the entry difficult. The town is chiefly noteworthy for the extensive ruins of former cities on the same site. Of existing buildings the most remarkable is the great Mosque of the Hundred Columns, now used as a military hospital. The mosque contains 89 columns of diorite, surmounted by a variety of capitals brought from other buildings,

The population of the town in 1906 was 4733; of the commune of which Cherchel is the centre 11,088.

Cherchel was a city of the Carthaginians, who named it Jol. Juba II. (25 B.C.) made it the capital of the Mauretanian kingdom under the name of Caesarea. Juba's tomb, the so-called Tombeau de la Chrétienne (see ALGERIA), is $7\frac{1}{2}$ m. E. of the town. Destroyed by the Vandals, Caesarea regained some of its importance under the Byzantines. Taken by the Arabs it was renamed by them Cherchel. Khair-ed-Din Barbarossa captured the city in 1520 and annexed it to his Algerian pashalik. In the early years of the 18th century it was a commercial city of some importance, but was laid in ruins by a terrible earthquake in 1738. In 1840 the town was occupied by the French. The ruins suffered greatly from vandalism during the early period of French rule, many portable objects being removed to museums in Paris or Algiers, and most of the monuments destroyed for the sake of their stone. Thus the dressed stones of the ancient theatre served to build barracks; the material of the hippodrome went to build the church; while the portico of the hippodrome, supported by granite and marble columns, and approached by a fine flight of steps, was destroyed by Cardinal Lavigerie in a search for the tomb of St Marciana. The fort built by Arouj Barbarossa, elder brother of Khair-ed-Din, was completely destroyed by the French. There are many fragments of a white marble temple. The ancient cisterns still supply the town with water. The museum contains some of the finest statues discovered in Africa. They include colossal figures of Aesculapius and Bacchus, and the lower half of a seated Egyptian divinity in black basalt, bearing the cartouche of Tethmosis (Thothmes) I. This statue was found at Cherchel, and is held by some archaeologists to indicate an Egyptian settlement here about 1500 B.C.

See AFRICA, ROMAN, and the description of the museum by P. Gauckler in the *Musées et collections archéologiques de l'Algérie*.

CHERCHEN, a town of East Turkestan, situated at the northern foot of the Altyn-tagh, a range of the Kuen-lun, in $85^{\circ} 35'$ E., and on the Cherchen-darya, at an altitude of 4100 ft. It straggles mostly along the irrigation channels that go off from the left side of the river, and in 1900 had a population of about 2000. The Cherchen-darya, which rises in the Arka-tagh, a more southerly range of the Kuen-lun, in 87° E. and $36^{\circ} 20'$ N., flows north until it strikes the desert below Cherchen, after which it turns north-east and meanders through a wide bed (300-400 ft.), beset with dense reeds and flanked by older channels. It is probable that anciently it entered the disused channel of the Eitek-tarim, but at present it joins the existing Tarim in the lake of Kara-buran, a sort of lacustrine "ante-room" to the Kara-koshun (N. M. Przhevsky's Lop-nor). At its entrance into the former lake the Cherchen-darya forms a broad delta. The river is frozen in its lower course for two to three months in the winter. From the foot of the mountains to the oasis of Cherchen it has a fall of nearly 4000 ft., whereas in the 300 m. or so from Cherchen to the Kara-buran the fall is 1400 ft. The total length is 500-600 m., and the drainage basin measures 6000-7000 sq. m.

See Sven Hedin, *Scientific Results of a Journey in Central Asia, 1899-1902*, vols. i. and ii. (1905-1906); also TAKLA-MAKAN.

CHEREMISSES, or **TCHEREMISSES**, a Finnish people living in isolated groups in the governments of Kazan, Viatka, Novgorod, Perm, Kostroma and Ufa, eastern Russia. Their name for themselves is Mori or Mari (people), possibly identifiable with the ancient Merians of Suzdalia. Their language belongs to the Finno-Ugrian family. They number some 240,000. There are two distinct physical types: one of middle height, black-haired, brown skin and flat-faced; the other short, fair-haired, white skinned, with narrow eyes and straight short noses. Those who live on the right bank of the Volga are sometimes known as Hill Cheremis, and are taller and stronger than those who inhabit the swamps of the left bank. They are farmers and herd horses and cattle. Their religion is a hotchpotch of Shamanism, Mahommedanism and Christianity. They are usually monogamous. The chief ceremony of marriage is a forcible abduction

of the bride. The women, naturally ugly, are often disfigured by sore eyes caused by the smoky atmosphere of the huts. They wear a head-dress, trimmed with glass jewels, forming a hood behind stiffened with metal. On their breasts they carry a breastplate formed of coins, small bells and copper disks.

See Smirinov, *Mordres et Tchermisises* (Paris, 1895); J. Abercromby, *Pre- and Proto-historic Finns* (London, 1898).

CHERIBON, a residency of the island of Java, Dutch East Indies, bounded S. and W. by the Preanger regencies, N.W. by Krawang, N. by the Java Sea, and E. by the residencies of Tegal and Banyumas. Pop. (1897) 1,577,521, including 867 Europeans, 21,108 Chinese, and 2016 Arabs and other Asiatic foreigners. The natives consist of Middle Javanese in the north and Sundanese in the south. Cheribon has been for many centuries the centre of Islamism in western Java, and is also the seat of a fanatical Mahommedan sect controlled from Mecca. The native population is on the whole orderly and prosperous. The northern half of the residency is flat and marshy in places, especially in the north-western corner, while the southern half is mountainous. In the middle stands the huge volcano Cherimai, clad with virgin forest and coffee plantations, and surrounded at its foot by rice fields. South-south-west of Cherimai on the Preanger border is the Sawal volcano, at whose foot is the beautiful Penjalu lake. Sulphur and salt springs occur on the slopes of Cherimai, and near Palimanan there is a cavernous hole called Guwagalang (or Payagalang), which exhales carbonic acid gas, and is considered holy by the natives and guarded by priests. There is a similar hole in the Preanger. The principal products of cultivation are sugar, coffee, rice and also tea and pulse (*rachang*), the plantations being for the most part owned by Europeans. The chief towns are Cheribon, a seaport and capital of the residency, the seaport of Indramaya, Palimanan, Majalengka, Kuningan and Chiamis. Cheribon has a good open roadstead. The town is very old and irregularly built, and the climate is unhealthy; nevertheless it has a lively export trade in sugar and coffee and is a regular port of call. In 1908 the two descendants of the old sultans of Cheribon still resided there in their respective *Kratons* or palaces, and each received an annual income of over £1500 for the loss of his privileges. A country residence belonging to one of the sultans is situated close to Cheribon and is much visited on account of its fantastic architecture. Indramaya was a considerable trading place in the days of the early Portuguese and Dutch traders. Kuningan is famous for a breed of small but strong horses.

CHERKASY (Polish, *Czerkasy*), a town of Russia, in the government of Kiev, 96 m. S.E. of Kiev, on the right bank of the Dnieper. Pop. (1883) 15,740; (1897) 26,619. The inhabitants (Little Russians) are mostly employed in agriculture and gardening; but sugar and tobacco are manufactured and spirits distilled. Cherkasy was an important town of the Ukraine in the 15th century, and remained so, under Polish rule, until the revolt of the Cossack *hetman* Chmielnicki (1648). It was annexed by Russia in 1795.

CHERNIGOV, a government of Little Russia, on the left bank of the Dnieper, bounded by the governments of Mogilev and Smolensk on the N., Orel and Kursk on the E., Poltava on the S., and Kiev and Minsk on the W. Area, 20,233 sq. m. Its surface is an undulating plain, 650 to 750 ft. high in the north and 370 to 600 ft. in the south, deeply grooved by ravines and the valleys of the rivers. In the north, beyond the Desna river, about one-third of the area is under forest (rapidly disappearing), and marshes occur along the courses of the rivers; while to the south of the Desna the soil is dry and sometimes sandy, and gradually it assumes the characters of a steppe-land as one proceeds southward. The government is drained by the Dnieper, which forms its western boundary for 180 m., and by its tributary the Desna. The latter, which flows through Chernigov for nearly 350 m., is navigable, and timber is brought down its tributaries. The climate is much colder in the wooded tracts of the north than in the south; the average yearly temperature at the city of Chernigov is 44.4° F. (January, 23° ; July 68.5°).

The population reached 1,996,250 in 1883, 2,316,818 in 1897,

and 2,746,300 (estimate) in 1906. It is chiefly Little Russian (85.6%); but Great Russians (6.1%), mostly Raskolniks, *i.e.* nonconformists, and White Russians (5.6%) inhabit the northern districts. There are, besides, some Germans, as well as Greeks, at Nyezhin. Agriculture is the principal occupation; in the north, however, many of the inhabitants are engaged in the timber trade, and in the production of tar, pitch, wooden wares, leather goods and so forth. Cattle-breeding is carried on in the central districts. Beet is extensively cultivated. The cultivation of tobacco is increasing. Hemp is widely grown in the north, and the milder climate of the south encourages gardening. Bee-keeping is extensively carried on by the Raskolniks. Limestone, grindstones, china-clay and building-stone are quarried. Manufactures have begun to develop rapidly of late, the most important being sugar-works, distilleries, cloth-mills and glass-works. The government is divided into fifteen districts, their chief towns being Chernigov (*q.v.*), Borzna (pop. 12,458 in 1897), Glukhov (14,856), Gorodnya (4197), Konotop (23,083), Kozlets (5160), Krolevets (10,375), Mglin (7631), Novgorod-Syevsk (9185), Novozybkov (15,480), Nyezhin (32,481), Oster (5384), Sosnitsa (2507), Starodub (12,451) and Surazh (4004).

CHERNIGOV, a town of Russia, capital of the above government, on the right bank of the Desna, nearly half a mile from the river, 141 m. by rail N.E. of Kiev on a branch line. Pop. (1897) 27,006. It is an archiepiscopal see and possesses a cathedral of the 11th century. In 907 the city is mentioned in the treaty of Oleg as next in importance to Kiev, and in the 11th century it became the capital of the principality of Syevsk and an important commercial city. The Mongol invasion put an end to its prosperity in 1239. Lithuania annexed it in the 14th century, but it was soon seized by Poland, which held it until the 17th century. In 1686 it was definitely annexed to Russia.

CHEROKEE (native *Tsalagi*, "cave people"), a tribe of North American Indians of Iroquoian stock. Next to the Navaho they are the largest tribe in the United States and live mostly in Oklahoma (formerly Indian territory). Before their removal they possessed a large tract of country now distributed among the states of Alabama, Georgia, Mississippi, Tennessee and the west of Florida. Their chief divisions were then settled around the head-waters of the Savannah and Tennessee rivers, and were distinguished as the Elati Tsalagi or Lower Cherokees, *i.e.* those in the plains, and Atali Tsalagi or Upper Cherokees, *i.e.* those on the mountains. They were further divided into seven exogamous clans. Fernando de Soto travelled through their country in 1540, and during the next three centuries they were important factors in the history of the south. They attached themselves to the English in the disputes and contests which arose between the European colonizers, formally recognized the English king in 1730, and in 1755 ceded a part of their territory and permitted the erection of English forts. Unfortunately this amity was interrupted not long after; but peace was again restored in 1761. When the revolutionary war broke out they sided with the royalist party. This led to their subjugation by the new republic, and they had to surrender that part of their lands which lay to the south of the Savannah and east of the Chattahoochee. Peace was made in 1781, and in 1785 they recognized the supremacy of the United States and were confirmed in their possessions. In 1820 they adopted a civilized form of government, and in 1827, as a "Nation," a formal constitution. The gradual advance of white immigration soon led to disputes with the settlers, who desired their removal, and exodus after exodus took place; a small part of the tribe agreed (1835) to remove to another district, but the main body remained. An appeal was made by them to the United States government; but President Andrew Jackson refused to interfere. A force of 2000 men, under the command of General Winfield Scott, was sent in 1838, and the Cherokees were compelled to emigrate to their present position. After the settlement various disagreements between the eastern and western Cherokees continued for some time, but in 1839 a union was effected. In the Civil War they all at first sided with the

South; but before long a strong party joined the North, and this led to a disastrous internecine struggle. On the close of the contest they were confirmed in the possession of their territory, but were forced to give a portion of their lands to their emancipated slaves. Their later history is mainly a story of hopeless struggle to maintain their tribal independence against the white man. In 1892 they sold their western territory known as the "Cherokee outlet." Until 1906, when tribal government virtually ceased, the "nation" had an elected chief, a senate and house of representatives. Many of them have become Christians, schools have been established and there is a tribal press. Those in Oklahoma still number some 26,000, though most are of mixed blood. A group, known as the Eastern Band, some 1400 strong, are on a reservation in North Carolina. Their language consists of two dialects—a third, that of the "Lower" branch, having been lost. The syllabic alphabet invented in 1821 by George Guess (Sequoyah) is the character employed.

See also *Handbook of American Indians* (Washington, 1907); T. V. Parker, *Cherokee Indians* (N. Y., 1909); and **INDIANS, NORTH AMERICAN**.

CHEROOT, or **SHEROOT** (from the Tamil word "shurutu," a roll), a cigar made from tobacco grown in southern India and the Philippine Islands. It was once esteemed very highly for its delicate flavour. A cheroot differs from other cigars in having both ends cut square, instead of one being pointed, and one end considerably larger than the other.

CHERRAPUNJI, a village in the Khasi hills district of Assam. It is notable as having the heaviest known rainfall in the world. In 1861 it registered a total of 905 in., and its annual average is 458 in. This excessive rainfall is caused by the fact that Cherrapunji stands on the edge of the plateau overlooking the plains of Bengal, where it catches the full force of the monsoon as it rises from the sea. There is a good coal-seam in the vicinity.

CHERRY. As a cultivated fruit-tree the cherry is generally supposed to be of Asiatic origin, whence, according to Pliny it was brought to Italy by Lucullus after his defeat of Mithradates, king of Pontus, 68 B.C. As with most plants which have been long and extensively cultivated, it is a matter of difficulty, if not an impossibility, to identify the parent stock of the numerous cultivated varieties of cherry; but they are generally referred to two species: *Prunus Cerasus*, the wild or dwarf cherry, the origin of the morello, duke and Kentish cherries, and *P. Avium*, the gean, the origin of the geans, hearts and bigarreaus. Both species grow wild through Europe and western Asia to the Himalayas, but the dwarf cherry has the more restricted range of the two in Britain, as it does not occur in Scotland and is rare in Ireland. The cherries form a section *Cerasus* of the genus *Prunus*; and they have sometimes been separated as a distinct genus from the plums proper; both have a stone-fruit or drupe, but the drupe of the cherry differs from that of the plum in not having a waxy bloom; further, the leaves of the plum are rolled (*convolute*) in the bud, while those of the cherry are folded (*conduplicate*).

The cherries are trees of moderate size and shrubs, having smooth, serrate leaves and white flowers. They are natives of the temperate regions of both hemispheres; and the cultivated varieties ripen their fruit in Norway as far as 63° N. The geans are generally distinguished from the common cherry by the greater size of the trees, and the deeper colour and comparative insipidity of the flesh in the ripe fruit, which adheres firmly to the "nut" or stone; but among the very numerous cultivated varieties specific distinctions shade away so that the fruit cannot be ranged under these two heads. The leading varieties are recognized as bigarreaus, dukes, morellos and geans. Several varieties are cultivated as ornamental trees and on account of their flowers.

The cherry is a well-flavoured sub-acid fruit, and is much esteemed for dessert. Some of the varieties are particularly selected for pies, tarts, &c., and others for the preparation of preserves, and for making cherry brandy. The fruit is also very extensively employed in the preparation of the liqueurs known as kirschwasser, ratafia and maraschino. Kirschwasser is made

chiefly on the upper Rhine from the wild black gean, and in the manufacture the entire fruit-flesh and kernels are pulped up and allowed to ferment. By distillation of the fermented pulp the liqueur is obtained in a pure, colourless condition. Ratafia is similarly manufactured, also by preference from a gean. Maraschino, a highly valued liqueur, the best of which is produced at Zara in Dalmatia, differs from these in being distilled from a cherry called marasca, the pulp of which is mixed with honey, honey or sugar being added to the distillate for sweetening. It is also said that the flavour is heightened by the use of the leaves of the perfumed cherry, *Prunus Mahaleb*, a native of central and southern Europe.

The wood of the cherry tree is valued by cabinetmakers, and that of the gean tree is largely used in the manufacture of tobacco pipes. The American wild cherry, *Prunus serotina*, is much sought after, its wood being compact, fine-grained, not liable to warp, and susceptible of receiving a brilliant polish. The kernels of the perfumed cherry, *P. Mahaleb*, are used in confectionery and for scent. A gum exudes from the stem of cherry trees similar in its properties to gum arabic.

The cherry is increased by budding on the wild gean, obtained by sowing the stones of the small black or red wild cherries. To secure very dwarf trees the *Prunus Mahaleb* has been used for the May duke, Kentish, morello and analogous sorts, but it is not adapted for strong-growing varieties like the bigarreus. The stocks are budded, or, more rarely, grafted, at the usual seasons. The cherry prefers a free, loamy soil, with a well-drained subsoil. Stiff soils and dry gravelly subsoils are both unsuitable, though the trees require a large amount of moisture, particularly the large-leaved sorts, such as the bigarreus. For standard trees, the bigarreus section should be planted 30 ft. apart, or more, in rich soil, and the May duke, morello and similar varieties 20 or 25 ft. apart; while, as trained trees against walls and espaliers, from 20 to 24 ft. should be allowed for the former, and from 15 to 20 ft. for the latter. In forming the stems of a standard tree the temporary side-shoots should not be allowed to attain too great a length, and should not be more than two years old when they are cut close to the stem. The first three shoots retained to form the head should be shortened to about 15 in., and two shoots from each encouraged, one at the end, and the other 3 or 4 in. lower down. When these have become established, very little pruning will be required, and that chiefly to keep the principal branches as nearly equal in strength as possible for the first few years. Espalier trees should have the branches about a foot apart, starting from the stem with an upward curve, and then being trained horizontally. In summer pruning the shoots on the upper branches must be shortened at least a week before those on the lower ones. After a year or two clusters of fruit buds will be developed on spurs along the branches, and those spurs will continue productive for an indefinite period. For wall trees any form of training may be adopted; but as the fruit is always finest on young spurs, fan-training is probably the most advantageous. A succession of young shoots should be laid in every year. The morello, which is of twiggy growth and bears on the young wood, must be trained in the fan form, and care should be taken to avoid the very common error of crowding its branches.

Forcing.—The cherry will not endure a high temperature nor close atmosphere. A heat of 45° at night will be sufficient at starting, this being gradually increased during the first few weeks to 55°, but lowered again when the blossom buds are about to open. After stoning the temperature may be again gradually raised to 60°, and may go up to 70° by day, or 75° by sun heat, and 60° at night. The best forcing cherries are the May duke and the royal duke, the duke cherries being of more compact growth than the bigarreus tribe and generally setting better; nevertheless a few of the larger kinds, such as bigarreus Napoléon, black tartarian and St Margaret's, should be forced for variety. The trees may be either planted out in tolerably rich soil, or grown in large pots of good turfy friable calcareous loam mixed with rotten dung. If the plants are small, they may be put into 12-in. pots in the first instance, and after a year shifted into

15-in. pots early in autumn, and plunged in some loose or even very slightly fermenting material. The soil of the pots should be protected from snow-showers and cold rains. Occasionally trees have been taken up in autumn with balls, potted and forced in the following spring; but those which have been established a year in the pots are to be preferred. Such only as are well furnished with blossom-buds should be selected. The trees should be removed to the forcing house in the beginning of December, if fruit be required very early in the season. During the first and second weeks it may be kept nearly close; but, as vegetation advances, air becomes absolutely necessary during the day, and even at night when the weather will permit. If forcing is commenced about the middle or third week of December, the fruit ought to be ripe by about the end of March. After the fruit is gathered, the trees should be duly supplied with water at the root, and the foliage kept well syringed till the wood is mature. (See also FRUIT AND FLOWER FARMING.)

CHERRYVALE, a city of Montgomery county, Kansas, U.S.A., about 140 m. S.S.E. of Kansas City. Pop. (1890) 2104; (1900) 3472, including 180 negroes; (1905, state census) 5089; (1910) 4304. It is served by the Atchison, Topeka & Santa Fé, and the main line and a branch (of which it is a terminus) of the St Louis & San Francisco railways. It is in a farming district and in the Kansas natural-gas and oil-field, and has large zinc smelters, an oil refinery, and various manufactures, including vitrified brick, flour, glass, cement and ploughs. Cherryvale was laid out in 1871 by the Kansas City, Lawrence & South Kansas Railway Company (later absorbed by the Atchison, Topeka & Santa Fé). The main part of the town was destroyed by fire in 1873, but was soon rebuilt, and in 1880 Cherryvale became a city of the third and afterwards of the second class. Natural gas, which is used as a factory fuel and for street and domestic lighting, was found here in 1889, and oil several years later.

CHERRY VALLEY, a village of Otsego county, New York, U.S.A., in a township of the same name, 68 m. N.W. of Albany. Pop. (1890) 685; (1900) 772; (1905) 746; (1910) 792; of the township (1910) 1706. It is served by the Delaware & Hudson railway. Cherry Valley is in the centre of a rich farming and dairying region, has a chair factory, and is a summer resort with sulphur and lithia springs. It was the scene of a terrible massacre during the War of Independence. The village was attacked on the 11th of November 1778 by Walter Butler (d. 1781) and Joseph Brant with a force of 800 Indians and Tories, who killed about 50 men, women and children, sacked and burned most of the houses, and carried off more than 70 prisoners, who were subjected to the greatest cruelties and privations, many of them dying or being tomahawked before the Canadian settlements were reached. Cherry Valley was incorporated in 1812.

CHERSIPHON, a Cretan architect, the traditional builder (with his son Metagenes) of the great Ionic temple of Artemis at Ephesus set up by the Greeks in the 6th century. Some remains of this temple were found by J. T. Wood and brought to the British Museum. In connexion with the pillars, which are adorned with archaic reliefs, a fragmentary inscription has been found, recording that they were presented by King Croesus, as indeed Herodotus informs us. This temple was burned on the day on which Alexander the Great was born.

CHERSO, an island in the Adriatic Sea, off the east coast of Istria, from which it is separated by the channel of Farasina. Pop. (1900) 8274. It is situated in the Gulf of Quarnero, and is connected with the island of Lussin, lying on the S.W. by a turn bridge over the small channel of Ossero, and with the island of Veglia, lying on the E. by the Canale di Mezzo. These three are the principal islands of the Quarnero group, and form together the administrative district of Lussin in the Austrian crownland of Istria. Cherso is an elongated island about 40 m. long, 1¼ to 7 m. wide, and has an area of 150 sq. m. It is traversed by a range of mountains, which attain in the peak of Syss an altitude of 2090 ft. and form natural terraces, planted with vines and olive trees, specially in the middle and southern parts of the island. The northern part is covered with bushes of laurel

and mastic, but there are scarcely any large trees. There is a scarcity of springs, and the houses are generally furnished with cisterns for rain water. In the centre of the island is an interesting lake called the Vrana or Crow's Lake, situated at an altitude of 40 ft. above the level of the sea, $3\frac{3}{4}$ m. long, 1 m. wide and 184 ft. deep. This lake is in all probability fed by subterranean sources. The chief town of the island is Cherso, situated on the west coast. It possesses a good harbour and is provided with a shipwright's wharf.

CHERSONESE, CHERSONESUS, or CHERRONESUS (Gr. *χέρσος*, dry, and *νῆσος*, island), a word equivalent to "peninsula." In ancient geography the Chersonesus Thracica, Chersonesus Taurica or Scythica, and Chersonesus Cimbrica correspond to the peninsulas of the Dardanelles, the Crimea and Jutland; and the Golden Chersonese is usually identified with the peninsula of Malacca. The Tauric Chersonese was further distinguished as the Great, in contrast to the Heracleotic or Little Chersonese at its S.W. corner, where Sevastopol now stands.

The *Tauric Chersonese*¹ (from 2nd century A.D. called Cherson) was a Dorian colony of Heraclea in Bithynia, founded in the 5th century B.C. in the Crimea about 2 m. S. of the modern Sevastopol. After defending itself against the kingdom of Bosphorus (*q.v.*), and the native Scythians and Tauri, and even extending its power over the west coast of the peninsula, it was compelled to call in the aid of Mithradates VI. and his general Diophantus, *c.* 110 B.C., and submitted to the Pontic dynasty. On regaining a nominal independence, it came more or less under the Roman suzerainty. In the latter part of the 1st century A.D., and again in the succeeding century, it received a Roman garrison and suffered much interference in its internal affairs. In the time of Constantine, in return for assistance against the Bosphorans and the native tribes, it regained its autonomy and received special privileges. It must, however, have been subject to the Byzantine authorities, as inscriptions testify to restorations of its walls by Byzantine officials. Under Theophilus the central government sent out a governor to take the place of the elected magistrate. Even so it seems to have preserved a measure of self-government and may be said to have been the last of the Greek city states. Its ruin was brought about by the commercial rivalry of the Genoese, who forbade the Greeks to trade there and diverted its commerce to Caffa and Sudak. Previous to this it had been the main emporium of Byzantine commerce upon the N. coast of the Euxine. Through it went the communications of the empire with the Petchenegs and other native tribes, and more especially with the Russians. The commerce of Cherson is guaranteed in the early treaties between the Greeks and Russians, and it was in Cherson, according to Ps. Nestor's chronicle, that Vladimir was baptized in 988 after he had captured the city. The constitution of the city was at first democratic under Damiorgi, a senate and a general assembly. Latterly it appears to have become aristocratic, and most of the power was concentrated in the hands of the first archon or Proteuon, who in time was superseded by the strategus sent out from Byzantium. Its most interesting political document is the form of oath sworn to by all the citizens in the 3rd century B.C.

The remains of the city occupy a space about two-thirds of a mile long by half a mile broad. They are enclosed by a Byzantine wall. Foundations and considerable remains of a Greek wall going back to the 4th century B.C. have been found beneath this in the eastern or original part of the site. Many Byzantine churches, both cruciform and basilican, have been excavated. The latter survived here into the 13th century when they had long been extinct in other Greek-speaking lands. The churches were adorned with frescoes, wall and floor mosaics, some well preserved, and marble carvings similar to work found at Ravenna. The fact that the site has not been inhabited since the 14th century makes it important for our knowledge of Byzantine life. The city was used by the Romans as a place of banishment: St Clement of Rome was exiled hither and first preached the

¹ In Pliny "Heraclea Chersonesus," probably owing to a confusion with the name of the mother city.

Gospel; another exile was Justinian II., who is said to have destroyed the city in revenge. We have a considerable series of coins from the 3rd century B.C. to about A.D. 200, and also some of Byzantine date.

See B. Koehne, *Beiträge zur Geschichte von Cherronesus in Taurien* (St Petersburg, 1848); art. "Chersonesos" (20) by C. G. Brandis in Pauly-Wissowa, *Realencyclopädie*, vol. iii. 221; A. A. Bobrinskoi, *Chersonesus Taurica* (St Petersburg, 1905) (Russian); V. V. Latyshev, *Inscr. Orae Septentr. Ponti Euxini*, vols. i. and iv. Reports of excavations appear in the *Compte rendu* of the Imperial Archaeological Commission of St Petersburg from 1888 and in its *Bulletin*. See E. H. Minns, *Scythians and Greeks* (Cambridge, 1907). (E. H. M.)

CHERTSEY, a market town in the Chertsey parliamentary division of Surrey, England, 22 m. W.S.W. from London by the London & South-Western railway. Pop. of urban district (1901) 12,762. It is pleasantly situated on the right bank of the Thames, which is crossed by a bridge of seven arches, built of Purbeck stone in 1785. The parish church, rebuilt in 1808, contains a tablet to Charles James Fox, who resided at St Anne's Hill in the vicinity, and another to Lawrence Tomson, a translator of the New Testament in the 17th century. Hardly any remains are left of a great Benedictine abbey, whose buildings at one time included an area of 4 acres. They fell into almost complete decay in the 17th century, and a "fair house" was erected out of the ruins by Sir Nicholas Carew of Beddington. The ground-plan can be traced; the fish-ponds are complete; and carved stones, coffins and encaustic tiles of a peculiar manufacture are frequently exhumed. Among the abbots the most famous was John de Rutherwyk, who was appointed in 1307, and continued, till his death in 1346, to carry on a great system of alteration and extension, which almost made the abbey a new building. The house in which the poet Cowley spent the last years of his life remains, and the chamber in which he died is preserved unaltered. The town is the centre of a large residential district. Its principal trade is in produce for the London markets.

The first religious settlement in Surrey, a Benedictine abbey, was founded in 666 at Chertsey (*Cerolesei, Certesey*), the manor of which belonged to the abbot until 1539, since when it has been a possession of the crown. In the reign of Edward the Confessor Chertsey was a large village and was made the head of Godley hundred. The increase of copyhold under Abbot John de Rutherwyk led to discontent, the tenants in 1381 rising and burning the rolls. Chertsey owed its importance primarily to the abbey, but partly to its geographical position. Ferries over the Redewynd were subjects of royal grant in 1340 and 1399; the abbot built a new bridge over the Bourne in 1333, and wholly maintained the bridge over the Thames when it replaced the 14th century ferry. In 1410 the king gave permission to build a bridge over the Redewynd. As the centre of an agricultural district the markets of Chertsey were important and are still held. Three days' fairs were granted to the abbots in 1129 for the feast of St Peter ad Vincula by Henry III. for Holy Rood day; in 1282 for Ascension day; and a market on Mondays was obtained in 1282. In 1590 there were many poor, for whose relief Elizabeth gave a fair for a day in Lent and a market on Thursdays. These fairs still survive.

See Lucy Wheeler, *Chertsey Abbey* (London, 1905); *Victoria County History, Surrey*.

CHERUBIM, the Hebrew plural of "cherub" (*kērub*), imaginary winged animal figures of a sacred character, referred to in the description of Solomon's temple (1 Kings vi. 23-35, vii. 29, viii. 6, 7), and also in that of the ark of the tabernacle (Ex. xxv. 18-22, xxvi. 1, 31, xxxvii. 7-9). The cherub-images, where such occur, represent to the imagination the supernatural bearers of Yahweh's throne or chariot, or the guardians of His abode; the cherub-carvings at least symbolize His presence, and communicate some degree of His sanctity. In Gen. iii. 24 the cherubim are the guards of Paradise; Ezek. xxviii. 14, 16 cannot be mentioned here, the text being corrupt. We also find (1 Sam. iv. 4; 2 Sam. vi. 2) as a divine title "that sitteth upon the cherubim"; here it is doubted whether the cherubim are the material ones in the temple, or those which faith assumes and

the artist tries to represent—the supernatural steeds upon which Yahweh issues forth to interfere in human affairs. In a poetic theophany (Ps. xviii. 10) we find “upon a cherub” parallel to “upon the wings of the wind” (cp. Isa. xix. 1; Ps. civ. 3). One naturally infers from this that the “cherub” was sometimes viewed as a bird. For the clouds, mythologically, are birds. “The Algonkins say that birds always make the winds, that they create the waterspouts, and that the clouds are the spreading and agitation of their wings.” “The Sioux say that the thunder is the sound of the cloud-bird flapping his wings.” If so, Ps. xviii. 10 is a solitary trace of the archaic view of the cherub. The bird, however, was probably a mythic, extra-natural bird. At any rate the cherub was suggested by and represents the storm-cloud, just as the sword in Gen. iii. 24 corresponds to the lightning. In Ezek. i. the four visionary creatures are expressly connected with a storm-wind, and a bright cloud (ver. 4). Elsewhere (xli. 18) the cherub has two faces (a man’s and a bird’s), but in i. 10 and x. 14 each cherub has four faces, a view tastefully simplified in the Johannine Apocalypse (Rev. iv. 7).

It is best, however, to separate Ezekiel from other writers, since he belongs to what may be called a great mythological revival. Probably his cherubim are a modification of older ones, which may well have been of a more sober type. His own accounts, as we have seen, vary. Probably the cherub has passed through several phases. There was a mythic bird-cherub, and then perhaps a winged animal-form, analogous to the winged figures of bulls and lions with human faces which guarded Babylonian and Assyrian temples and palaces. Another analogy is furnished by the winged genii represented as fertilizing the sacred tree—the date-palm (Tylor); here the body is human, though the face is sometimes that of an eagle. It is perhaps even more noteworthy that figures thought to be cherubs have been found at Zenjirli, within the ancient North Syrian kingdom of Ya’di (see Jeremias, *Das Alte Testament im Lichte des Alten Orients*, pp. 350 f.); we may combine this with the fact that one of the great gods of this kingdom was called Rakab’el or Reküb’el (also perhaps Rakab or Reküb). A Sabaeen (S. Arabian) name Karab’el also exists. The kerübim might perhaps be symbolic representatives of the god Rakab’el or Reküb’el, probably equivalent to Hadad, whose sacred animal was the bull. That the figures symbolic of Rakab or Hadad were compounded or amalgamated by the Israelites with those symbolic of Nergal (the lion-god) and Ninib (the eagle-god), is not surprising.

See further “Cherubim,” in *Ency. Bib. and Hast. D.B.*; Cheyne, *Genesis*; Tylor, *Proc. Soc. Bibl. Arch.* xii. 383 ff.; Zimmern, *Die Keilinschriften und das Alte Testament*, pp. 529 f., 631 f.; Dibelius, *Die Lade Jahves* (1906), pp. 72-86. (T. K. C.)

CHERUBINI, MARIA LUIGI CARLO ZENOBIO SALVATORE (1760-1842), Italian musical composer, was born at Florence on the 14th of September 1760, and died on the 15th of March 1842 in Paris. His father was accompanist (*Maestro al Cembalo*) at the Pergola theatre. Cherubini himself, in the preface of his autograph catalogue of his own works, states, “I began to learn music at six and composition at nine, the former from my father, the latter from Bartolomeo and Alessandro Felici, and, after their death, from Bizzarri and J Castrucci.” By the time he was sixteen he had composed a great deal of church music, and in 1777 he went to Bologna, where for four years he studied under Sarti. This deservedly famous master well earned the gratitude which afterwards impelled Cherubini to place one of his double choruses by the side of his own *Et Vitam Venturi* as the crown of his *Treatise on Counterpoint and Fugue*, though the juxtaposition is disastrous for Sarti. But besides grounding Cherubini in the church music for which he had early shown so special a bent, Sarti also trained him in dramatic composition; sometimes, like the great masters of painting, entrusting his pupil with minor parts of his own works. From 1780 onwards for the next fourteen years dramatic music occupied Cherubini almost entirely. His first complete opera, *Quinto Fabio*, was produced in 1780, and was followed in 1782 by *Armida*, *Adriano in Siria*, and other works. Between 1782 and 1784 the successful production of five operas in four different towns must have secured

Cherubini a dignified position amongst his Italian contemporaries; and in 1784 he was invited to London to produce two works for the Italian opera there, one of which, *La Finta Principessa*, was favourably received, while the other, *Giulio Sabino*, was, according to a contemporary witness, “murdered” by the critics.

In 1786 he left London for Paris, which became his home after a visit to Turin in 1787-1788 on the occasion of the production there of his *Ifigenia in Aulide*. With Cherubini, as with some other composers first trained in a school where the singer reigned supreme, the influence of the French dramatic sensibility proved decisive, and his first French opera, *Démophon* (1788), though not a popular success, already marks a departure from the Italian style, which Cherubini still cultivated in the pieces he introduced into the works of Anfossi, Paisiello and Cimarosa, produced by him as director of the Italian opera in Paris (established in 1789). As in Paris Gluck realized his highest ambitions, and even Rossini awoke to a final effort of something like dramatic life in *Guillaume Tell*, so in Paris Cherubini became a great composer. If his melodic invention had been as warm as Gluck’s, his immensely superior technique in every branch of the art would have made him one of the greatest composers that ever lived. But his personal character shows in quaint exaggeration the same asceticism that in less sour and more negative form deprives even his finest music of the glow of that lofty inspiration that fears nothing.

With *Lodoiska* (1791) the series of Cherubini’s masterpieces begins, and by the production of *Médée* (1797) his reputation was firmly established. The success of this sombre classical tragedy, which shows Cherubini’s genius in its full power, is an honour to the Paris public. If Cherubini had known how to combine his high ideals with an urbane tolerance of the opinions of persons of inferior taste, the severity of his music would not have prevented his attaining the height of prosperity. But Napoleon Bonaparte irritated him by an enthusiasm for the kind of Italian music against which his whole career, from the time he became Sarti’s pupil, was a protest. When Cherubini said to Napoleon, “Citoyen Général, I perceive that you love only that music which does not prevent you thinking of your politics,” he may perhaps have been as firmly convinced of his own conciliatory manner as he was when many years afterwards he “spared the feelings” of a musical candidate by “delicately” telling him that he had “a beautiful voice and great musical intelligence, but was too ugly for a public singer.” Napoleon seems to have disliked opposition in music as in other matters, and the academic offices held by Cherubini under him were for many years far below his deserts. But though Napoleon saw no reason to conceal his dislike of Cherubini, his appointment of Lesueur in 1804 as his chapelmaster must not be taken as an evidence of his hostility. Lesueur was not a great genius, but, although recommended for the post by the retiring chapelmaster, Paesiello (one of Napoleon’s Italian favourites), he was a very meritorious and earnest Frenchman whom the appointment saved from starvation. Cherubini’s creative genius was never more brilliant than at this period, as the wonderful two-act ballet, *Anacreon*, shows; but his temper and spirits were not improved by a series of disappointments which culminated in the collapse of his prospects of congenial success at Vienna, where he went in 1805 in compliance with an invitation to compose an opera for the Imperial theatre. Here he produced, under the title of *Der Wasserträger*, the great work which, on its first production on the 7th of January 1801 (26 Nivôse, An 8) as *Les Deux Journées*, had thrilled Paris with the accents of a humanity restored to health and peace. It was by this time an established favourite in Austria. On the 25th of February Cherubini produced *Faniska*, but the war between Austria and France had broken out immediately after his arrival, and public interest in artistic matters was checked by the bombardment and capitulation of Vienna. Though the meeting between Cherubini and the victorious Napoleon was not very friendly, he was called upon to direct the music at Napoleon’s soirées at Schönbrunn. But this had not been his object in coming to Vienna, and he soon returned to a retired and gloomy life in Paris.

His stay at Vienna is memorable for his intercourse with Beethoven, who had a profound admiration for him which he could neither realize nor reciprocate. It is too much to expect that the mighty genius of Beethoven, which broke through all rules in vindication of the principles underlying them, would be comprehensible to a mind like Cherubini's, in which, while the creative faculties were finely developed, the critical faculty was atrophied and its place supplied by a mere disciplinary code inadequate even as a basis for the analysis of his own works. On the other hand, it would be impossible to exaggerate the influence *Les Deux Journées* had on the lighter parts of Beethoven's *Fidelio*. Cherubini's librettist was also the author of the libretto from which *Fidelio* was adapted, and Cherubini's score was a constant object of Beethoven's study, not only before the production of the first version of *Fidelio* as *Leonore*, but also throughout Beethoven's life. Cherubini's record of his impressions of Beethoven as a man is contained in the single phrase, "Il était toujours brusque," which at least shows a fine freedom from self-consciousness on the part of the man whose only remark on being told of the death of Brod, the famous oboist, was, "Ah, he hadn't much tone" ("Ah, petit son"). Of the overture to *Leonore* Cherubini only remarked that he could not tell what key it was in, and of Beethoven's later style he observed, "It makes me sneeze." Beethoven's brusqueness, notorious as it was, did not prevent him from assuring Cherubini that he considered him the greatest composer of the age and that he loved him and honoured him. In 1806 Haydn had just sent out his pathetic "visiting card" announcing that he was past work; Weber was still sowing wild oats, and Schubert was only nine years old. We need not, then, be surprised at Beethoven's judgment. And though we must regret that Cherubini's disposition prevented him from understanding Beethoven, it would be by no means true to say that he was uninfluenced at least by the sheer grandeur of the scale which Beethoven had by that time established as the permanent standard for musical art. Grandeur of proportion was, in fact, eminently characteristic of both composers, and the colossal structure of such a movement as the duet *Perfidés ennemis* in *Médée* is almost inconceivable without the example of Beethoven's C minor trio, *op. 1, No. 3*, published two years before it; while the cavatina *Eterno iddio* in *Faniska* is not only worthy of Beethoven but surprisingly like him in style.

After Cherubini's disappointing visit to Vienna he divided his time between teaching at the conservatoire and cutting up playing-cards into figures and landscapes, which he framed and placed round the walls of his study. Not until 1809 was he aroused from this morbid indolence. He was staying in retirement at the country seat of the prince de Chimay, and his friends begged him to write some music for the consecration of a church there. After persistent refusals he suddenly surprised them with a mass in F for three-part chorus and orchestra. With this work the period of his great church music may be said to begin; although it was by no means the end of his career as an opera writer, which, in fact, lasted as late as his seventy-third year. This third period is also marked by some not unimportant instrumental compositions. An early event in the annals of the Philharmonic Society was his invitation to London in 1815 to produce a symphony, an overture and a vocal piece. The symphony (in D) was afterwards arranged with a new slow movement as the string quartet in C (1829), a fact which, taken in connexion with the large scale of the work, illustrates Cherubini's deficient sense of style in chamber music. Nevertheless all the six string quartets written between 1814 and 1837 are interesting works performed with success at the present day, though the last three, discovered in 1889, are less satisfactory than the earlier ones. The requiem in C minor (1817) caused Beethoven to declare that if he himself ever wrote a requiem Cherubini's would be his model.

At the eleventh hour Cherubini received recognition from Napoleon, who, during the Hundred Days, made him chevalier of the Legion of Honour. Then, with the restoration of the Bourbons, the very fact that Cherubini had not been *persona grata*

with Napoleon brought him honour and emoluments. He was appointed, jointly with Lesueur, as composer and conductor to the Chapel Royal, and in 1822 he obtained the permanent directorship of the conservatoire. This brought him into contact, for the most part unfriendly, with all the most talented musicians of the younger generation. It is improbable that Berlioz would have been an easy subject for the wisest and kindest of spiritual guides; but no influence, repellent or attractive, could have been more disastrous for that passionate, quick-witted and yet eminently puzzle-headed mixture of Philistine and genius, than the crabbed old martinet whose regulations forbade the students access to Gluck's scores in the library, and whose only theory of art (as distinguished from his practice) is accurately formulated in the following passage from Berlioz's *Grande Traité de l'instrumentation et d'orchestration*: "It was no use for the modern composer to say, 'But do just listen! See how smoothly this is introduced, how well motived, how deftly connected with the context, and how splendid it sounds!' He was answered, 'That is not the point. This modulation is forbidden; therefore it must not be made.'" The lack of really educative teaching, and the actual injustice for which Cherubini's disciplinary methods were answerable, did much to weaken Berlioz's at best ill-balanced artistic sense, and it is highly probable that, but for the kindness and comparative wisdom of his composition master, Lesueur, he would have broken down from sheer lack of any influence which could command the respect of an excitable youth starving in the pursuit of a fine art against the violent opposition of his family. Only when Mendelssohn, at the age of seventeen, visited Paris in 1825, did Cherubini startle every one by praising a young composer to his face.

In 1833 Cherubini produced his last work for the stage, *Ali Baba*, adapted (with new and noisy features which excited Mendelssohn's astonished disgust) from a manuscript opera, *Koukourgi*, written forty years earlier. It is thus, perhaps, not a fair illustration of the vigour of his old age; but the requiem in D minor (for male voices), written in 1836, is one of his greatest works, and, though not actually his last composition, is a worthy close to the long career of an artist of high ideals who, while neither by birth nor temperament a Frenchman, must yet be counted with a still greater foreigner, Gluck, as the glory of French classical music. In this he has no parallel except his friend and contemporary, Méhul, to whom he dedicated *Médée*, and who dedicated to him the beautiful Ossianic one-act opera *Uthal*. The direct results of his teaching at the conservatoire were the steady, though not as yet unhealthy, decline of French opera into a lighter style, under the amiable and modest Boieldieu and the irresponsible and witty Auber; for, as we have seen, Cherubini was quite incapable of making his ideals intelligible by any means more personal than his music; and the crude grammatical rules which he mistook for the eternal principles of his own and of all music had not the smallest use as a safeguard against vulgarity and pretentiousness.

Lest the passage above quoted from Berlioz should be suspected of bias or irrelevance, we cite a few phrases from Cherubini's *Treatise on Counterpoint and Fugue*, of which, though the letterpress is by his favourite pupil, Halévy, the musical examples and doctrine are beyond suspicion his own. Concerning the 16th-century idiom, incorrectly but generally known as the "changing note" (an idiom which to any musical scholar is as natural as "attraction of the relative" is to a Greek scholar), Cherubini remarks, "No tradition gives us any reason why the classics thus faultily deviated from the rule." Again, he discusses the use of "suspensions" in a series of chords which without them would contain consecutive fifths, and after making all the observations necessary for the rational conclusion that the question whether the fifths are successfully disguised or not depends upon the beauty and force of the suspensions, he merely remarks that "The opinion of the classics appears to me erroneous, notwithstanding that custom has sanctioned it, for, on the principle that the discord is a mere suspension of the chord, it should not affect the nature of the chord. But since

the classics have pronounced judgment we must of course submit." In the whole treatise not one example is given from Palestrina or any other master who handled as a living language what are now the forms of contrapuntal discipline. As a dead language Cherubini brought counterpoint up to date by abandoning the church modes; but in true severity of principle, as in educational stimulus, his treatise shows a deplorable falling off from the standard set a hundred years before in Fux's *Gradus ad Parnassum* with its delightful dialogues between master and pupil and its continual appeal to artistic experience. Whatever may have been Cherubini's success in imparting facility and certainty to his light-hearted pupils who established 19th-century French opera as a refuge from the terrors of serious art, there can be no doubt that his career as a teacher did more harm than good. In it the punishment drill of an incompetent schoolmaster was invested with the authority of a great composer, and by it the false antithesis between the "classical" and the "romantic" was erected into a barrier which many critics still find an insuperable obstacle to the understanding of the classical spirit. And yet as a composer Cherubini was no pseudo-classic but a really great artist, whose purity of style, except at rare moments, just failed to express the ideals he never lost sight of, because in his love of those ideals there was too much fear.

His principal works are summarized by Fétis as thirty-two operas, twenty-nine church compositions, four cantatas and several instrumental pieces, besides the treatise on counterpoint and fugue.

Good modern full scores of the two *Requiem*s and of *Les Deux Journées* (the latter unfortunately without the dialogue, which, however, is accessible in its fairly good German translation in the *Reclam Bibliothek*), and also of ten opera overtures, are current in the Peters edition. Vocal scores of some of the other operas are not difficult to get. The great *Credo* is in the Peters edition, but is becoming scarce. The string quartets are in Payne's *Miniature Scores*. It is very desirable that the operas, from *Démophon* onwards, should be republished in full score.

See also E. Bellasis, *Cherubini* (1874); and an article with personal reminiscences by the composer Ferdinand Hiller, in *Macmillan's Magazine* (1875). A complete catalogue of his compositions (1773-1841) was edited by Bottée du Toulmon. (D. F. T.)

CHÉRUEL, PIERRE ADOLPHE (1809-1891), French historian, was born at Rouen on the 17th of January 1809. He was educated at the *École Normale Supérieure*, and became a fellow (*agrégé*) in 1830. His early studies were devoted to his native town. His *Histoire de Rouen sous la domination anglaise au XV^e siècle* (1840) and *Histoire de Rouen pendant l'époque communale, 1150-1382* (Rouen, 1843-1844), are meritorious productions for a time when the archives were neither inventoried nor classified, and contain useful documents previously unpublished. His theses for the degree of doctor, *De l'administration de Louis XIV d'après les Mémoires inédits d'Olivier d'Ormesson* and *De Maria Stuart et Henrico III.* (1849), led him to the study of general history. The former was expanded afterwards under the title *Histoire de l'administration monarchique en France depuis l'avènement de Philippe-Auguste jusqu'à la mort de Louis XIV* (1855), and in 1855 he also published his *Dictionnaire historique des institutions, mœurs et coutumes de la France*, of which many editions have appeared. These works may still be consulted for the 17th century, the period upon which Chéruel concentrated all his scientific activity. He edited successively the *Journal d'Olivier Lefèvre d'Ormesson* (1860-1862), interesting for the history of the parlement of Paris during the minority of Louis XIV.; *Lettres du cardinal Mazarin pendant son ministère* (6 vols., 1870-1891), continued by the vicomte G. d'Avenel; and *Mémoires du duc de Saint-Simon*, published for the first time according to the original MSS. (2 editions, 1856-1858 and 1878-1881). To Saint-Simon also he devoted two critical studies, which are acute but not definitive: *Saint-Simon considéré comme historien de Louis XIV* (1865) and *Notice sur la vie et sur les mémoires du duc de Saint-Simon* (1876). The latter may be considered as an introduction to the famous *Mémoires*. Among his later writings may be mentioned the *Histoire de la France pendant la minorité de Louis XIV* (4 vols., 1880) and *Histoire de la France sous le ministère de Mazarin* (3 vols., 1882-1883). These two works are valuable for abundance of facts, precision of details, and clear and intelligent

arrangement, but are characterized by a slightly frigid style. In their compilation Chéruel used a fair number of unpublished documents. To the student of the second half of the 17th century in France the works of Chéruel are a mine of information. He died in Paris on the 1st of May 1891.

CHERUSCI, an ancient German tribe occupying the basin of the Weser to the north of the Chatti. Together with the other tribes of western Germany they submitted to the Romans in 11-9 B.C., but in A.D. 9 Arminius, one of their princes, rose in revolt, and defeated and slew the Roman general Quintilius Varus with his whole army. Germanicus Caesar made several unsuccessful attempts to bring them into subjection again. By the end of the 1st century the prestige of the Cherusci had declined through unsuccessful warfare with the Chatti. Their territory was eventually occupied by the Saxons.

Tacitus, *Annals*, i. 2, 11, 12, 13; *Germania*, 36; Strabo, p. 291 f.; E. Devrient, in *Neue Jahrb. f. d. klass. Alter.* (1900), p. 517.

CHESELDEN, WILLIAM (1688-1752), English surgeon, was born at Somerby, Leicestershire, on the 19th of October 1688. He studied anatomy in London under William Cowper (1666-1709), and in 1713 published his *Anatomy of the Human Body*, which achieved great popularity and went through thirteen editions. In 1718 he was appointed an assistant surgeon at St Thomas's hospital (London), becoming full surgeon in the following year, and he was also chosen one of the surgeons to St George's hospital on its foundation in 1733. He retired from St Thomas's in 1738, and died at Bath on the 10th of April 1752. Cheselden is famous for his "lateral operation for the stone," which he first performed in 1727. He also effected a great advance in ophthalmic surgery by his operation of iridectomy, described in 1728, for the treatment of certain forms of blindness by the production of an "artificial pupil." He attended Sir Isaac Newton in his last illness, and was an intimate friend of Alexander Pope and of Sir Hans Sloane.

CHESHAM, a market town in the Aylesbury parliamentary division of Buckinghamshire, England, 26 m. W.N.W. of London by the Metropolitan railway. Pop. of urban district (1901) 7245. It is pleasantly situated in the narrow valley of the river Chess, closely flanked by low wooded hills. The church of St Mary is cruciform and mainly Perpendicular. Some ancient frescoes and numerous monuments are preserved. All sorts of small dairy utensils, chairs, malt-shovels, &c., are made of beech, the growth of which forms a feature of the surrounding country. Shoemaking is also carried on. In Waterside hamlet, adjoining the town, are flour-mills, duck farms, and some of the extensive watercress beds for which the Chess is noted, as it is also for its trout-fishing.

CHESHIRE, a north-western county of England, bounded N. by Lancashire, N.E. by Yorkshire and Derbyshire, S.E. by Staffordshire, S. by Shropshire, W. by Denbighshire and Flint, and N.W. by the Irish Sea. Its area is 1027.8 sq. m. The coast-line is formed by the estuaries of the Dee and the Mersey, which are separated by the low rectangular peninsula of Wirral. The estuary of the Dee is dry at low tide on the Cheshire shore, but that of the Mersey bears upon its banks the ports of Liverpool (in Lancashire) and Birkenhead (on the Wirral shore). The Dee forms a great part of the county boundary with Denbighshire and Flint, and the Mersey the boundary along the whole of the northern side. The principal river within the county is the Weaver, which crosses it with a north-westerly course, and, being joined by the Dane at Northwich, discharges into the estuary of the Mersey south of Runcorn. The surface of Cheshire is mostly low and gently undulating or flat; but the broken line of the Peckforton hills, seldom exceeding 600 ft. in height, runs north and south flanking the valley of the Weaver to the west. A low narrow gap in these hills is traversed by the small river Gowy, which rises to the east but has the greater part of its course to the west of them. Commanding this gap on the west, the Norman castle of Beeston stands on an isolated eminence. The northern part of the hills coincides approximately with the district still called Delamere Forest, formerly a chase of the earls of Chester, and finally disforested in 1812.

In certain sequestered parts the forest has not wholly lost its ancient character. On the east Cheshire includes the western face of the broad belt of high land which embraces the Peak district of Derbyshire; these hills rise sharply to the east of Congleton, Macclesfield and Hyde, reaching a height of about 1800 ft. within Cheshire. Distributed over the county, but principally in the eastern half, are many small lakes or meres, such as Combermere, Tatton, Rostherne, Tabley, Doddington, Marbury and Mere, and it was a common practice among the gentry of the county to build their mansions on the banks of these waters. The meres form one of the most picturesque features of the county.

Geology.—With the exception of a small area of Carboniferous rocks on the eastern border, and a small patch of Lower Lias near Audlem, the whole country is occupied by Triassic strata. The great central plain is covered by red and mottled Keuper Marls. From these marls salt is obtained; there are many beds of rock-salt, mostly thin; two are much thicker than the others, being from 75 ft. to over 100 ft. thick. Thin beds and veins of gypsum are common in the marls. The striking features of the Peckforton Hills are due to the repeated faulting of the Lower Keuper Sandstone, which lies upon beds of Bunter Sandstone. Besides forming this well-marked ridge, the Lower Keuper Sandstones or "Waterstones" form several ridges north-west of Macclesfield and appear along most of the northern borders of the county and in the neighbourhood of New Brighton and Birkenhead. The Lower Keuper Sandstone is quarried near the last-named place, also at Storeton, Delamere and Manley. This is a good building stone and an important water-bearing stratum; it is often ripple-marked, and bears the footprints of the *Cheirotherium*. At Alderley Edge ores of copper, lead and cobalt are found. West of the Peckforton ridge, Bunter Sandstones and pebble beds extend to the border. They also form low foothills between Cheadle and Macclesfield. They fringe the northern boundary and appear on the south-eastern boundary as a narrow strip of hilly ground near Woore. The oldest rock exposed in the county is the small faulted anticline of Carboniferous limestone at Astbury, followed in regular succession eastward by the shale, and thin limestones and sandstones of the Pendleside series. These rocks extend from Congleton Edge to near Macclesfield, where the outcrop bends sharply eastward and runs up the Goyt valley. Some hard quartzites in the Pendleside series, known locally as "Crowstones," have contributed to the formation of the high Bosley Min and neighbouring hills. East of Bosley Min, on either side of the Goyt valley, are the Millstone Grits and Shales, forming the elevated moorland tracts. Cloud Hill, a striking feature near Congleton, is capped by the "Third Grit," one of the Millstone Grit series. From Macclesfield northward through Stockport is a narrow tongue of Lower and Middle Coal-Measures—an extension of the Lancashire coalfield. Coal is mined at Neston in the Wirral peninsula from beneath the Trias; it is a connecting link between the Lancashire and Flintshire coalfields. Glacial drift is thickly spread over all the lower ground; laminated red clays, stiff clay with northern erratics and lenticular sand masses with occasional gravels, are the common types. At Crewe the drift is over 400 ft. thick. Patches of Drift sand, with marine shells, occur on the high ground east of Macclesfield at an elevation of 1250 ft.

Agriculture and Industries.—The climate is temperate and rather damp; the soil is varied and irregular, but a large proportion is a thin-skinned clay. More than four-fifths of the total area is under cultivation. The crop of wheat is comparatively insignificant; but a large quantity of oats is grown, and a great proportion of the cultivated land is in permanent pasture. The vicinity of such populous centres as Liverpool and Manchester, as well as the several large towns within the county, makes cattle and dairy-farming profitable. Cheese of excellent quality is produced, the name of the county being given to a particular brand (see DAIRY). Potatoes are by far the most important green crop. Fruit-growing is carried on in some parts, especially the cultivation of stone fruit and, among these, damsons; while the strawberry beds near Farndon and Holt are celebrated. In the first half of the 19th century the condition of agriculture in Cheshire was notoriously backward; and in 1865–1866 the county suffered with especial severity from a visitation of cattle plague. The total loss of stock amounted to more than 66,000 head, and it was necessary to obtain from the Treasury a loan of £270,000 on the security of the county rate, for purposes of relief and compensation. The cheese-making industry naturally received a severe blow, yet to agriculture at large an ultimate good resulted as the possibility and even the necessity of new methods were borne in upon the farmers.

The industries of the county are various and important. The manufacture of cotton goods extends from its seat in Lancashire into Cheshire, at the town of Stockport and elsewhere in the north-east. Macclesfield and Congleton are centres of silk manufacture. At Crewe are situated the great workshops of the London & North-Western railway company, the institution of which actually brought the town into being. Another instance of the modern creation of a town by an individual industrial corporation is seen in Port Sunlight on the Mersey, where the soap-works of Messrs Lever are situated. On the Mersey there are shipbuilding yards, and machinery and iron works. Other important manufactures are those of tools, chemicals, clothing and hats, and there are printing, bleaching and dye works, and metal foundries. Much sandstone is quarried, but the mineral wealth of the county lies in coal and salt. The second is a specially important product. Some rock-salt is obtained at Northwich and Winsford, but most of the salt is extracted from brine both here and at Lawton, Wheelock and Middlewich. At Northwich and other places in the locality curious accidents frequently occur owing to the sinking of the soil after the brine is pumped out; walls crack and collapse, and houses are seen leaning far out of the perpendicular. A little copper and lead are found.

Communications.—The county is well served with railways. The main line of the London & North-Western railway, passing north from Crewe to Warrington in Lancashire, serves no large town, but from Crewe branches diverge fanwise to Manchester, Chester, North Wales and Shrewsbury. The Great Western railway, with a line coming northward from Wrexham, obtains access through Cheshire to Liverpool and Manchester. These two companies jointly work the Birkenhead railway from Chester to Birkenhead. The heart of the county is traversed by the Cheshire Lines, serving the salt district, and reaching Chester from Manchester by way of Delamere Forest. In the east the Midland and Great Central systems enter the county, and the North Staffordshire line serves Macclesfield. The Manchester, South Junction & Altrincham and the Wirral railways are small systems serving the localities indicated by their names. The river Weaver is locked as far up as Winsford, and the transport of salt is thus expedited. The profits of the navigation, which was originally undertaken in 1720 by a few Cheshire squires, belong to the county, and are paid annually to the relief of the county rates. In the salt district through which the Weaver passes subsidence of the land has resulted in the formation of lakes of considerable extent, which act as reservoirs to supply the navigation. There are further means of inland navigation by the Grand Trunk, Shropshire Union and other canals, and many small steamers are in use. The Manchester Ship Canal passes through a section of north Cheshire, being entered from the estuary of the Mersey by locks near Eastham, and following its southern shore up to Runcorn, after which it takes a more direct course than the river.

Population and Administration.—The ancient county, which is a county palatine, has an area of 657,783 acres, with a population in 1891 of 730,058 and in 1901 of 815,099. Cheshire has been described as a suburb of Liverpool, Manchester and the Potteries of Staffordshire, and many of those whose business lies in these centres have colonized such districts as Bowdon, Alderley, Sale and Marple near Manchester, the Wirral, and Alsager on the Staffordshire border, until these localities have come to resemble the richer suburban districts of London. On the short seacoast of the Wirral are found the popular resorts of New Brighton and Hoylake. This movement and importance of its industries have given the county a vast increase of population in modern times. In 1871 the population was 561,201; from 1801 until that year it had increased 191%. The area of the administrative county is 654,825 acres. The county contains 7 hundreds. The municipal boroughs are Birkenhead (pop. 110,915), Chester (38,309), Congleton (10,707), Crewe (42,074), Dukinfield (18,929), Hyde (32,766), Macclesfield (34,624), Stalybridge (27,673), Stockport (92,832). Chester, the county town, is a city, county of a city, and county borough, and Birkenhead and Stockport are county

boroughs. The other urban districts with their populations are as follows—

Alderley Edge (a)	2,856	Hoylake and West Kirby (b)	10,911
Alsager	2,597	Knutsford (a)	5,172
Altrincham	16,831	Lower Bebington (b)	8,398
Ashton-upon-Mersey (a)	5,563	Lymm (a)	4,707
Bollington (a)	5,245	Marple (a)	5,595
Bowdon (a)	2,788	Middlewich	4,669
Bredbury and Romiley (a)	7,087	Mottram-in-Longdendale (a)	3,128
Bromborough (b)	1,891	Nantwich	7,722
Buglawton (Congleton)	1,452	Neston and Parkgate (b)	4,154
Cheadle and Gatley (a)	7,916	Northwich	17,611
Compstall (a)	875	Runcorn	16,491
Ellesmere Port and Whitby (b)	4,082	Sale (a)	12,088
Hale (a)	4,562	Sandbach	5,558
Handforth (a)	911	Tarporley	2,644
Hazel Grove and Bramhall (a)	7,934	Wallasey (b)	53,579
Higher Bebington (b)	1,540	Wilmslow (a)	7,361
Hollingworth (a)	2,447	Winsford	10,382
Hoole (Chester)	5,341	Yeardsley-cum-Whaley (a)	1,487

Of the townships in this table, those marked (a) are within a radius of about 15 m. from Manchester (Knutsford being taken as the limit), while those marked (b) are in the Wirral. The localities of densest population are thus clearly illustrated.

The county is in the North Wales and Chester circuit, and assizes are held at Chester. It has one court of quarter sessions, and is divided into fourteen petty sessional divisions. The boroughs already named, excepting Dukinfield, have separate commissions of the peace, and Birkenhead and Chester have separate courts of quarter sessions. There are 464 civil parishes. Cheshire is almost wholly in the diocese of Chester, but small parts are in those of Manchester, St Asaph or Lichfield. There are 268 ecclesiastical parishes or districts wholly or in part within the county. There are eight parliamentary divisions, namely, Macclesfield, Crewe, Eddisbury, Wirral, Knutsford, Altrincham, Hyde and Northwich, each returning one member; the county also includes the parliamentary borough of Birkenhead returning one member, and parts of the borough of Stockport, which returns two members, and of Ashton-under-Lyne, Chester, Stalybridge, and Warrington, which return one member each.

History.—The earliest recorded historical fact relating to the district which is now Cheshire is the capture of Chester and destruction of the native Britons by the Northumbrian king Æthelfrith about 614. After a period of incessant strife between the Britons and their Saxon invaders the district was subjugated by Egbert in 830 and incorporated in the kingdom of Mercia. During the 9th century Æthelwulf held his parliament at Chester, and received the homage of his tributary kings from Berwick to Kent, and in the 10th century Æthelflæd rebuilt the city, and erected fortresses at Eddisbury and Runcorn. Edward the Elder garrisoned Thelwall and strengthened the passages of the Mersey and the Irwell. On the splitting up of Mercia in the 10th century the dependent districts along the Dee were made a shire for the fortress of Chester. The shire is first mentioned in the *Abingdon Chronicle*, which relates that in 980 Cheshire was plundered by a fleet of Northmen. At the time of the Domesday Survey the county was divided into twelve hundreds, exclusive of the six hundreds between the Ribble and the Mersey, now included in Lancashire, but then a part of Cheshire. These divisions have suffered great modification, both in extent and in name, and of the seven modern hundreds Bucklow alone retains its Domesday appellation. The hundreds of Atiscross and Exestan have been transferred to the counties of Flint and Denbigh, with the exception of a few townships now in the hundred of Broxton. The prolonged resistance of Cheshire to the Conqueror was punished by ruthless harrying and sweeping confiscations of property, and no Englishman retained estates of importance after the Conquest. In order that the shire might be relieved of all obligations beyond the ever-pressing necessity of defending its borders against the inroads of hostile neighbours, it was constituted a county palatine which the earl of Chester "held as freely by his sword as the king held England by his crown." The county had its independent parliament

consisting of the barons and clergy, and courts, and all lands except those of the bishop were held of the earl. The court of exchequer was presided over by a chamberlain, a vice-chamberlain, and a baron of the exchequer. It was principally a court of revenue, but probably a court of justice also, before that of the justiciary was established, and had besides the functions of a chancery court, with an exclusive jurisdiction in equity. Other officers of the palatinate were the constable, high-steward and the serjeants of the peace and of the forests. The abbots of St Werburgh and Combermere and all the eight barons held courts, in any of which cases of capital felony might be tried.

During the 12th and 13th centuries the county was impoverished by the constant inroads of the Welsh. In 1264 the castle and city of Chester were granted to Simon de Montfort, and in 1267 the treaty of Shrewsbury procured a short interval of peace. Richard II., in return for the loyal support furnished him by the county, made it a principality, but the act was revoked in the next reign. In 1403 Cheshire was the headquarters of Hotspur, who roused the people by telling them that Richard II. was still living. At the beginning of the Wars of the Roses Margaret collected a body of supporters from among the Cheshire gentry, and Lancastrian risings occurred as late as 1464. At the time of the Civil War feeling was so equally divided that an attempt was made to form an association for preserving internal peace. In 1643, however, Chester was made the headquarters of the royalist forces, while Nantwich was garrisoned for the parliament, and the county became the scene of constant skirmishes until the surrender of Chester in 1646 put an end to the struggle.

From the number of great families with which it has been associated Chester has been named "the mother and nurse of English gentility." Of the eight baronies of the earldom none survives, but the title of that of Kinderton was bestowed in 1762 on George Venables-Vernon, son of Anne, sister of Peter Venables, last baron of Kinderton, from whom the present Lord Vernon of Kinderton is descended. Other great Domesday proprietors were William FitzNigel, baron of Halton, ancestor of the Lacys; Hugh de Mara, baron of Montalt, ancestor of the Ardens; Ranulph, ancestor of the Mainwarings; and Hamo de Massey. The Davenports, Leighs and Warburtons trace their descent back to the 12th century, and the Grosvenors are descended from a nephew of Hugh Lupus.

In the reign of Henry VIII. the distinctive privileges of Cheshire as a county palatine were considerably abridged. The right of sanctuary attached to the city of Chester was abolished; justices of the peace were appointed as in other parts of the kingdom, and in 1542 it was enacted that in future two knights for the shire and two burgesses for the city of Chester should be returned to parliament. After the Reform Act of 1832 the county returned four members from two divisions, and Macclesfield and Stockport returned two members each. Birkenhead secured representation in 1859. From 1868 until the Redistribution Act of 1885 the county returned six members from three divisions.

From earliest times the staple products of Cheshire have been salt and cheese. The salt-pits of Nantwich, Middlewich and Northwich were in active operation at the time of Edward the Confessor, and at that date the mills and fisheries on the Dee also furnished a valuable source of revenue. Twelfth century writers refer to the excellence of Cheshire cheese, and at the time of the Civil War three hundred tons at £33 per ton were ordered in one year for the troops in Scotland. The trades of tanners, skiners and glove-makers existed at the time of the Conquest, and the export trade in wool in the 13th and 14th centuries was considerable. The first bed of rock-salt was discovered in 1670. Weaving and wool-combing were introduced in 1674.

Antiquities.—The main interest in the architecture of the

county lies in the direction of domestic buildings rather than ecclesiastical. Old half-timbered houses are common in almost every part of the county; many of these add to the picturesqueness of the streets in the older towns, as in the case of the famous Rows in Chester, while in the country many ancient manor-houses remain as farm-houses. Among the finest examples are Bramhall Hall, between Stockport and Macclesfield, and Moreton Old Hall, near Congleton (see HOUSE, Plate IV., fig. 13). The first, occupying three sides of a quadrangle (formerly completed by a fourth side), dates from the 13th and 14th centuries, and contains a splendid panelled hall and other rooms. Of Moreton Hall, which is moated, only three sides similarly remain; its date is of the 16th century. Other buildings of the Elizabethan period are not infrequent, such as Brereton and Dorfold Halls, while more modern mansions, set in fine estates, are numerous. Crewe Hall is a modern building on an ancient site, and Vale Royal near Winsford incorporates fragments of a Cistercian monastery founded in 1277. A noteworthy instance of the half-timbered style applied to an ecclesiastical building is found in the church of Lower Peover near Knutsford, of which only the tower is of stone. The church dates from the 13th century, and was carefully restored in 1852. Cheshire has no monastic remains of importance, save those attached to the cathedral of Chester, nor are its village churches as a rule of special interest. There is, however, a fine late Perpendicular church (with earlier portions) at Astbury near Congleton, and of this style and the Decorated the churches of Bunbury and Malpas may be noticed as good illustrations. In Chester, besides the cathedral, there is the massive Norman church of St John; and St Michael's church and the Rivers chapel at Macclesfield are noteworthy. No more remarkable religious monuments remain in the county than the two sculptured Saxon crosses in the market-place at Sandbach. Ruins of two Norman castles exist in Beeston and Halton.

AUTHORITIES.—Sir John Doddrige, *History of the Ancient and Modern State of the Principality of Wales, Duchy of Cornwall, and Earldom of Chester* (London, 1630; 2nd ed., 1714); D. King, *The Vale-Royall of England, or the County Palatine of Cheshire Illustrated*, 4 parts (London, 1656); D. and S. Lysons, *Magna Britannia*, vol. ii. pt. ii. (London, 1810); J. H. Hanshall, *History of the County Palatine of Chester* (Chester, 1817-1823); J. O. Halliwell, *Palatine Anthology* (London, 1850); G. Ormerod, *History of the County Palatine and City of Chester* (London, 1819; new ed., London, 1875-1882); J. P. Earwaker, *East Cheshire* (2 vols., London, 1877); R. Wilbraham, *Glossary* (London, 1820; 2nd ed., London, 1826); and *Glossary founded on Wilbraham* by E. Leigh (London, 1877); J. Croston, *Historic Sites of Cheshire* (Manchester, 1883); and *County Families of Cheshire* (Manchester, 1887); W. E. A. Axon, *Cheshire Gleanings* (Manchester, 1884); Holland, *Glossary of Words used in the County of Cheshire* (London, 1884-1886); N. G. Phillips, *Views of Old Halls in Cheshire* (London, 1893); *Victoria County History, Cheshire*. See also various volumes of the Chetham Society and of the Record Society of Manchester, as well as the *Proceedings of the Cheshire Antiquarian Society, and Cheshire Notes and Queries*.

CHESHUNT, an urban district in the Hertford parliamentary division of Hertfordshire, England, on the Lea, 14 m. N. of London by the Great Eastern railway. Pop. (1891) 9620; (1901) 12,292. The church of St. Mary is Perpendicular and has been enlarged in modern times. A college was founded, for the education of young men to the ministry of the Connexion, by Selina countess of Huntingdon in 1768 at Trevecca-isaf near Talgarth, Brecknockshire. In 1792 it was moved to Cheshunt, and became known as Cheshunt College. In 1904, as it was felt that the college was unable properly to carry on its work under existing conditions, it was proposed to amalgamate it with Hackney College, but the Board of Education refused to sanction any arrangement which would set aside the requirements of the deed of foundation, namely that the officers and students of Cheshunt College should subscribe the fifteen articles appended to the deed, and should take certain other obligations. In 1905 it was decided by the board to reorganize the college and remove it to Cambridge.

Nursery and market gardening, largely under glass, brick-making and saw-mills are the chief industries of Cheshunt. Roman coins and other remains have been found at this place, and an urn appears built into the wall of an inn. A Romano-

British village or small town is indicated. There was a Benedictine nunnery here in the 13th century. Of several interesting mansions in the vicinity one, the Great House, belonged to Cardinal Wolsey, and a former Pengelly House was the residence of Richard Cromwell the Protector after his resignation. Theobalds Park was built in the 18th century, but the original mansion was acquired by William Cecil, Lord Burghley, in 1561; being taken in 1607 by James I. from Robert Cecil, first earl of Salisbury, in exchange for Hatfield House. James died here in 1625, and Charles I. set out from here for Nottingham in 1642 at the outset of the Civil War. One of the entrances to Theobalds Park is the old Temple Bar, removed from Fleet Street, London, in 1878.

CHESIL BANK (A.S. *ceosol*, pebble bank), a remarkable beach of shingle on the coast of Dorsetshire, England. It is separated from the mainland for 8 m. by an inlet called the Fleet, famous for its swannery, and continues in all for 18 m. south-eastward from Abbotsbury, terminating at the so-called Isle of Portland. The height of the bank at the Portland end is 35 ft. above spring-tide level, and its breadth 200 yds. The greater height at this end accords with the general movement of shingle along this coast from west to east; and for the same reason the pebbles of the bank decrease in size from 1 to 3 in. in diameter at Portland to the size of peas at the western end, where the breadth is only 170 yds.

CHESNELONG, PIERRE CHARLES (1820-1894), French politician, was born at Orthez in the department of the Basses-Pyrénées, on the 14th of April 1820. In 1848 he proclaimed himself a Republican; but after the establishment of the Second Empire he changed his views, and in 1865 was returned to the chamber as the official candidate for his native place. He at once became conspicuous, both for his eloquence and for his uncompromising clericalism, especially in urging the necessity for maintaining the temporal power of the papacy. In 1869 he was again returned, and, devoting himself with exceptional ability to financial questions, was in 1870 appointed to report the budget. During and after the war, for which he voted, he retired for a while into private life; but in 1872 he was again elected deputy, this time as a Legitimist, and took his seat among the extreme Right. He was the soul of the reactionary opposition that led to the fall of Thiers; and in 1873 it was he who, with Lucien Brun, carried to the comte de Chambord the proposals of the chambers. Through some misunderstanding, he reported on his return that the count had accepted all the terms offered, including the retention of the tricolour flag, and the count published a formal denial. Chesnelong now devoted himself to the establishment of Catholic universities and to the formation of Catholic working-men's clubs. In 1876 he was again returned for Orthez, but was unseated, and then beaten by the republican candidate. On the 24th of November, however, he was elected to a seat in the senate, where he continued his vigorous polemic against the progressive attempts of the republican government to secularize the educational system of France until his death in 1894.

CHESNEY, CHARLES CORNWALLIS (1826-1876), British soldier and military writer, the third son of Charles Cornwallis Chesney, captain on the retired list of the Bengal Artillery, and nephew of General F. R. Chesney, was born in Co. Down, Ireland, on the 29th of September 1826. Educated at Blundell's school, Tiverton, and afterwards at the Royal Military Academy, Woolwich, he obtained his first commission as second lieutenant of engineers in 1845, passing out of the academy at the head of his term. His early service was spent in the ordinary course of regimental duty at home and abroad, and he was stationed in New Zealand during the Crimean War. Among the various reforms in the British military system which followed from that war was the impetus given to military education; and in 1858 Captain Chesney was appointed professor of military history at Sandhurst. In 1864 he succeeded Colonel (afterwards Sir Edward) Hamley in the corresponding chair at the Staff College. The writings of these two brilliant officers had a great influence not only at home, but on the continent and in America. Chesney's

first published work (1863) was an account of the Civil War in Virginia, which went through several editions. But the work which attained the greatest reputation was his *Waterloo Lectures* (1868), prepared from the notes of lectures orally delivered at the Staff College. Up to that time the English literature on the Waterloo campaign, although voluminous, was made up of personal reminiscences or of formal records, useful materials for history rather than history itself; and the French accounts had mainly taken the form of fiction. In Chesney's lucid and vigorous account of the momentous struggle, while it illustrates both the strategy and tactics which culminated in the final catastrophe, the mistakes committed by Napoleon are laid bare, and for the first time an English writer is found to point out that the dispositions of Wellington were far from faultless. And in the *Waterloo Lectures* the Prussians are for the first time credited by an English pen with their proper share in the victory. The work attracted much attention abroad as well as at home, and French and German translations were published.

Chesney was for many years a constant contributor to the newspaper press and to periodic literature, devoting himself for the most part to the critical treatment of military operations, and professional subjects generally. Some of his essays on military biography, contributed mainly to the *Edinburgh Review*, were afterwards published separately (1874). In 1868 he was appointed a member of the royal commission on military education, under the presidency first of Earl De Grey and afterwards of Lord Dufferin, to whose recommendations were due the improved organization of the military colleges, and the development of military education in the principal military stations of the British army. In 1871, on the conclusion of the Franco-German War, he was sent on a special mission to France and Germany, and furnished to the government a series of valuable reports on the different siege operations which had been carried out during the war, especially the two sieges of Paris. These reports were published in a large volume, which was issued confidentially. Never seeking regimental or staff preferment, Colonel Chesney never obtained any, but he held at the time of his death a unique position in the army, altogether apart from and above his actual place in it. He was consulted by officers of all grades on professional matters, and few have done more to raise the intellectual standard of the British officer. Constantly engaged in literary pursuits, he was nevertheless laborious and exemplary in the discharge of his public duties, while managing also to devote a large part of his time to charitable and religious offices. He was abstemious to a fault; and, overwork of mind and body telling at last on a frail constitution, he died after a short illness on the 19th of March 1876. He had become lieutenant-colonel in 1873, and at the time of his death he was commanding Royal Engineer of the London district. He was buried at Sandhurst.

CHESNEY, FRANCIS RAWDON (1789-1872), British general and explorer, was the son of Captain Alexander Chesney, an Irishman of Scottish descent who, having emigrated to South Carolina in 1772, did brilliant service under Lord Rawdon (afterwards marquess of Hastings) in the War of Independence, and subsequently received an appointment as coast officer at Annalong, Co. Down, Ireland. There F. R. Chesney was born on the 16th of March 1789. Lord Rawdon gave the boy a cadetship at Woolwich, and he was gazetted to the Royal Artillery in 1805. But though he rose to be lieutenant-general and colonel-commandant of the 14th brigade Royal Artillery (1864), and general in 1868, Chesney's memory lives not for his military record, but for his connexion with the Suez Canal, and with the exploration of the Euphrates valley, which started with his being sent out to Constantinople in the course of his military duties in 1829, and his making a tour of inspection in Egypt and Syria. His report in 1830 on the feasibility of making the Suez Canal was the original basis of Lesseps' great undertaking (in 1869 Lesseps greeted him in Paris as the "father" of the canal); and in 1831 he introduced to the home government the idea of opening a new overland route to India, by a daring and adventurous journey (for the Arabs were hostile and he was ignorant

of the language) along the Euphrates valley from Anah to the Persian Gulf. Returning home, Colonel Chesney (as he then was) busied himself to get support for the latter project, to which the East India Company's board was favourable; and in 1835 he was sent out in command of a small expedition, for which parliament voted £20,000, in order to test the navigability of the Euphrates. After encountering immense difficulties, from the opposition of the Egyptian pasha, and from the need of transporting two steamers (one of which was lost) in sections from the Mediterranean over the hilly country to the river, they successfully arrived by water at Bushire in the summer of 1836, and proved Chesney's view to be a practicable one. In the middle of 1837 he returned to England, and was given the Royal Geographical Society's gold medal, having meanwhile been to India to consult the authorities there; but the preparation of his two volumes on the expedition (published in 1850) was interrupted by his being ordered out in 1843 to command the artillery at Hong Kong. In 1847 his period of service was completed, and he went home to Ireland, to a life of retirement; but both in 1856 and again in 1862 he went out to the East to take a part in further surveys and negotiations for the Euphrates valley railway scheme, which, however, the government would not take up, in spite of a favourable report from the House of Commons committee in 1871. In 1868 he published a further volume of narrative on his Euphrates expedition. He died on the 30th of January 1872.

His *Life*, edited by Stanley Lane Poole, appeared in 1885.

CHESNEY, SIR GEORGE TOMKYNS (1830-1895), English general, brother of Colonel C. C. Chesney, was born at Tiverton, Devonshire, on the 30th of April 1830. Educated at Blundell's school, Tiverton, and at Addiscombe, he entered the Bengal Engineers as second lieutenant in 1848. He was employed for some years in the public works department and, on the outbreak of the Indian Mutiny in 1857, joined the Ambala column, was field engineer at the battle of Badli-ke-serai, brigade-major of engineers throughout the siege of Delhi, and was severely wounded in the assault (medal and clasp and a brevet majority). In 1860 he was appointed head of a new department in connexion with the public works accounts. His work on *Indian Polity* (1868), dealing with the administration of the several departments of the Indian government, attracted wide attention and remains a permanent text-book. The originator of the Royal Indian Civil Engineering College at Cooper's Hill, Staines, he was also its first president (1871-1880). In 1871 he contributed to *Blackwood's Magazine*, "The Battle of Dorking," a vivid account of a supposed invasion of England by the Germans after their victory over France. This was republished in many editions and translations, and produced a profound impression. He was promoted lieutenant-colonel, 1869; colonel, 1877; major-general, 1886; lieutenant-general, 1887; colonel-commandant of Royal Engineers, 1890; and general, 1892. From 1881 to 1886 he was secretary to the military department of the government of India, and was made a C.S.I. and a C.I.E. From 1886 to 1892, as military member of the governor-general's council, he carried out many much-needed military reforms. He was made a C.B. at the jubilee of 1887, and a K.C.B. on leaving India in 1892. In that year he was returned to parliament, in the Conservative interest, as member for Oxford, and was chairman of the committee of service members of the House of Commons until his death on the 31st of March 1895. He wrote some novels, *The Dilemma*, *The Private Secretary*, *The Lesters*, &c., and was a frequent contributor to periodical literature.

CHESS, once known as "checker," a game played with certain "pieces" on a special "board" described below. It takes its name from the Persian word *shah*, a king, the name of one of the pieces or men used in the game. Chess is the most cosmopolitan of all games, invented in the East (see *History*, below), introduced into the West and now domiciled in every part of the world. As a mere pastime chess is easily learnt, and a very moderate amount of study enables a man to become a fair player, but the higher ranges of chess-skill are only attained by persistent labour. The real proficient or "master" not merely must know

the subtle variations in which the game abounds, but must be able to apply his knowledge in the face of the enemy and to call to his aid, as occasion demands, all that he has of foresight, brilliancy and resource, both in attack and in defence. Two chess players fighting over the board may fitly be compared to two famous generals encountering each other on the battlefield, the strategy and the tactics being not dissimilar in spirit.

The Board, Pieces and Moves.—The chessboard is divided (see accompanying diagrams) into sixty-four chequered squares. In diagram 1, the pieces, or chess-men, are arranged for the beginning of a game, while diagram 2 shows the denomination of the squares according to the English and German systems of notation. Under diagram 1 are the names of the various "pieces"—each side, White or Black, having a King, a Queen, two Rooks (or Castles), two Knights, and two Bishops. The eight men in front are called Pawns. At the beginning of the game the queen always stands upon a square of her own colour. The board is so set that each player has a white square at the right hand end of the row nearest to him. The rook, knight and bishop on the right of the king are known as King's rook, King's knight, and King's bishop; the other three as Queen's rook, Queen's knight, and Queen's bishop.

Briefly described, the powers of the various pieces and of the pawns are as follows.

The king may move in any direction, only one square at a time, except in castling. Two kings can never be on adjacent squares.

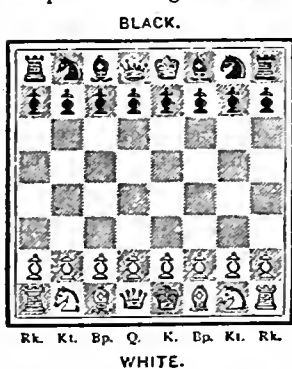

DIAGRAM 1.—Showing the arrangement of the pieces at the commencement of a game.

The bishops move diagonally in any direction whether backward or forward. They have an unlimited range, with the same exceptions.

The knights' moves are of an absolutely different kind. They move from one corner of any rectangle of three squares by two to the opposite corner; thus, in diagram 3, the white knight can move to the square occupied by the black one, and vice versa, or a knight could move from C to D, or D to C. The move may be made in any direction. It is no obstacle to the knight's move if squares A and B are occupied. It will be perceived that the knight always moves to a square of a different colour.

The king, queen, rooks and bishops may capture any foeman which stands anywhere within their respective ranges; and the knights can capture the adverse men which stand upon the squares to which they can leap. The piece which takes occupies the square of the piece which is taken, the latter being removed from the board. The king cannot capture any man which is protected by another man.

The moves and capturing powers of the pawns are as follows:— Each pawn for his first move may advance either one or two squares straight forward, but afterwards one square only, and this whether upon starting he exercised his privilege of moving two squares or not. A pawn can never move backwards. He can capture only diagonally—one square to his right or left front. A pawn moves like a rook, captures like a bishop, but only one square at a time. When a pawn arrives at an eighth square, viz. at the extreme limit of the board, he may, at the option of his owner, be exchanged for any other piece, so that a player may, e.g., have two or more queens on the board at once.

"Check and Checkmate." The king can never be captured, but when any piece or pawn attacks him, he is said to be "in check," and the fact of his being so attacked should be announced by the

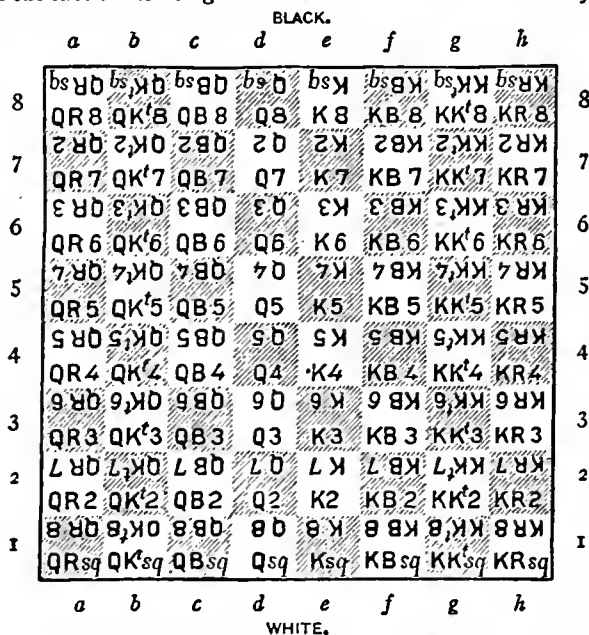

DIAGRAM 2.—Showing English and German Methods of Notation.

adverse player saying "check," whereupon the king must move from the square he occupies, or be screened from check by the interposition of one of his own men, or the attacking piece must be captured. If, however, when the king is in check, none of these things can be done, it is "checkmate" (Persian, *shah mat*, the king is dead), known generally as "mate," whereupon the game terminates, the player whose king has been thus checkmated being the loser. When the adversary has only his king left, it is very easy to checkmate him with only a queen and king, or only a rook and king. The problem is less easy with king and two bishops, and still less easy with king, knight and bishop, in which case the opposing king has to be driven into a corner square whose colour corresponds with the bishop's, mate being given with the bishop. A king and two knights cannot mate. To mate with king and rook the opposing king must be driven on to one of the four side files and kept there with the rook on the next file, till it is held by the other king, when the rook mates.

The pawn gives check in the same way as he captures, viz. diagonally. One king cannot give check to another, nor may a king be moved into check.

"Check by discovery" is given when a player, by moving one of his pieces, checks with another of them. "Double check" means attacking the king at once with two pieces—one of the pieces in this case giving check by discovery.

"Perpetual check" occurs when one player, seeing that he cannot win the game, finds the men so placed that he can give check *ad infinitum*, while his adversary cannot possibly avoid it. The game is then drawn. A game is also drawn "if, before touching a man, the player whose turn it is to play, claims that the game be treated as drawn, and proves that the existing position existed, in the game and at the commencement of his turn of play, twice at least before the present turn."

"Stalemate." When a king is not in check, but his owner has no move left save such as would place the king in check, it is "stalemate," and the game is drawn.

"Castling." This is a special move permitted to the king once only in the game. It is performed in combination with either rook, the king being moved two squares laterally, while the rook towards which he is moved (which must not have previously

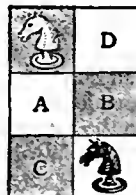

Knight's move.

moved from its square) is placed next him on the other side; the king must be touched first. The king cannot castle after having been once moved, nor when any piece stands between him and the rook, nor if he is in check, nor when he has to cross a square commanded by an adverse piece or pawn, nor into check. It will be perceived that after castling with the king's rook the latter will occupy the KB square, while the king stands on the KKt square, and if with the queen's rook, the latter will occupy the queen's square while the king stands on the QB square.

"Taking *en passant*." This is a privilege possessed by any of the pawns under the following circumstances:—If a pawn, say of the white colour, stands upon a fifth square, say upon K5 counting from the white side, and a black pawn moves from Q2 or KB2 to Q4 or KB4 counting from the black side, the white pawn can take the black pawn *en passant*. For the purposes of such capture the latter is dealt with as though he had only moved to Q3 or KB3, and the white pawn taking him diagonally then occupies the square the captured pawn would have reached had he moved but one square. The capture can be made only on the move immediately succeeding that of the pawn to be captured.

"Drawn Game." This arises from a stalemate (noticed above), or from either player not having sufficient force where-with to effect checkmate, as when there are only two kings left on the board, or king and bishop against king, or king with one knight, or two knights against king, or from perpetual check. One of the players can call upon the other to give check-mate in fifty moves, the result of failure being that the game is drawn. But, if a pawn is moved, or a piece is captured, the counting must begin again.

A "minor piece" means either a knight or a bishop. "Winning the exchange" signifies capturing a rook in exchange for a minor piece. A "passed pawn" is one that has no adverse pawn either in front or on either of the adjoining files. A "file" is simply a line of squares extending vertically from one end of the board to the other. An "open file" is one on which no piece or pawn of either colour is standing. A pawn or piece is *en prise* when one of the enemy's men can capture it. "Gambit" is a word derived from the Ital. *gambetto*, a tripping up of the heels; it is a term used to signify an opening in which a pawn or piece is sacrificed at the opening of a game to obtain an attack. An "opening," or *début*, is a certain set method of commencing the game. When a player can only make one legal move, that move is called a "forced move."

Value of the Pieces.—The relative worth of the chess-men cannot be definitely stated on account of the increase or decrease of their powers according to the position of the game and the pieces, but taking the pawn as the unit the following will be an estimate near enough for practical purposes:—pawn 1, bishop 3·25, knight 3·25, rook 5, queen 9·50. Three minor pieces may more often than not be advantageously exchanged for the queen. The knight is generally stronger than the bishop in the end game, but two bishops are usually stronger than two knights, more especially in open positions.

Laws.—The laws of chess differ, although not very materially, in different countries. Various steps have been taken, but as yet without success, to secure the adoption of a universal code. In competitions among English players the particular laws to be observed are specially agreed upon,—the regulations most generally adopted being those laid down at length in Staunton's *Chess Praxis*, or the modification of the *Praxis* laws issued in the name of the British Chess Association in 1862.

First Move and Odds.—To decide who moves first, one player conceals a white pawn in one hand and a black pawn in the other, his adversary not seeing in which hand the different pawns are put. The other holds out his hands with the pawns concealed, and his adversary touches one. If that contains the white pawn, he takes the white men and moves first. If he draws the black pawn his adversary has the first move, since white, by convention, always plays first. Subsequently the first move is taken alternately. If one player, by way of odds, "gives" his adversary a pawn or piece, that piece is removed before play begins. If

the odds are "pawn and move," or "pawn and two," a black pawn, namely, the king's bishop's pawn, is removed and white plays one move, or any two moves in succession. "Pawn and two" is generally considered to be slightly less in point of odds than to give a knight or a bishop; to give a knight and a bishop is to give rather more than a rook; a rook and bishop less than a queen; two rooks rather more than a queen. The odds of "the marked pawn" can only be given to a much weaker player. A pawn, generally KB's pawn, is marked with a cap of paper. If the pawn is captured its owner loses the game; he can also lose by being checkmated in the usual way, but he cannot give mate to his adversary with any man except the marked pawn, which may not be moved to an eighth square and exchanged for a piece.

Rules.—If a player touch one of his men he must move it, unless he says *j'adoube* (I adjust), or words of a similar meaning, to the effect that he was only setting it straight on its square. If he cannot legally move a touched piece, he must move his king, if he can, but may not castle; if not, there is no penalty. He must say *j'adoube* before touching his piece. If a player touch an opponent's piece, he must take it, if he can. if not, move his king. If he can do neither, no penalty. A move is completed and cannot be taken back, as soon as a player, having moved a piece, has taken his hand off it. If a player is called upon to mate under the fifty-move rule, "fifty moves" means fifty moves and the forty-nine replies to them. A pawn that reaches an eighth square *must* be exchanged for some other piece, the move not being complete until this is done; a second king cannot be selected.

Modes of Notation.—The English and German methods of describing the moves made in a game are different. According to the English method each player counts from his own side of the board, and the moves are denoted by the names of the files and the numbers of the squares. Thus when a player for his first move advances the king's pawn two squares, it is described as follows:—"r. P-K4." The following moves, with the aid of diagram 2, will enable the reader to understand the principles of the British notation. The symbol X is used to express "takes"; a dash - to express "to."

- | White. | Black. |
|---|---|
| 1. P-K4 | 1. P-K4 |
| 2. KKt-KB3
<i>(i.e. King's Knight to the third square of the King's Bishop's file)</i> | 2. QKt-QB3
<i>(i.e. Queen's Knight to the third square of the Queen's Bishop's file)</i> |
| 3. KB-QB4
<i>(King's Bishop to the fourth square of the Queen's Bishop's file)</i> | 3. KB-QB4 |
| 4. P-QB3 | 4. KKt-KB3 |
| 5. P-Q4 | 5. P takes P (or PXP)
<i>(King's pawn takes White's Queen's pawn)</i> |
| 6. P takes P (or PXP)
<i>(Queen's Bishop's pawn takes pawn: no other pawn has a pawn en prise)</i> | 6. KB-QKt5 (ch., <i>i.e. check</i>) |

It is now usual to express the notation as concisely as possible; thus, the third moves of White and Black would be given as 3. B-B4, because it is clear that only the fourth square of the queen's bishop's file is intended.

The French names for the pieces are, King, *Roi*; Queen, *Dame*; Rook, *Tour*; Knight, *Cavalier*; Pawn, *Pion*; for Bishop the French substitute *Fou*, a jester. Chess is *Les Échecs*.

The German notation employs the alphabetical characters *a, b, c, d, e, f, g* and *h*, proceeding from left to right, and the numerals 1, 2, 3, 4, 5, 6, 7 and 8, running upwards, these being always calculated from the white side of the board (see diagram 2). Thus the White Queen's Rook's square is *a1*, the White Queen's square is *d1*; the Black Queen's square, *d8*; the White King's square, *e1*; the Black King's square, *e8*, and so with the other pieces and squares. The German names of the pieces are as follows:—King, *König*; Queen, *Dame*; Rook, *Turm*; Bishop, *Läufer*; Knight, *Springer*; Pawn, *Bauer*; Chess, *Schach*.

The initials only of the pieces are given, the pawns (*Bauern*) being understood. The Germans use the following signs in their notation, viz.:—for "check" (†); "checkmate" (‡); "takes" (:); "castles on king's side" (o-o); "castles on queen's side" (o-o-o); for "best move" a note of admiration (!); for "weak move" a note of interrogation (?). The opening moves just given in the English will now be given in the German notation:—

White.	Black.
1. e2-e4	1. e7-e5
2. S g1-f3	2. S b8-c6
3. L f1-c4	3. L f8-c5
4. c2-c3	4. S g8-f6!
5. d2-d4	5. e5-d4:
6. c3-d4:	6. L c5-b4†

In both notations the moves are often given in a tabular form, thus:—

1. $\frac{P-K4}{P-K4}$ 1. $\frac{e2-e4}{e7-e5}$, the moves above the line being White's and below the line Black's.

Illustrative Games.—The text-books should be consulted by students who wish to improve their game. The following are some of the leading openings:—

White.	Black.
1. P-K4	1. P-K4
2. KKt-B3	2. OKt-B3
3. B-B4	3. B-B4
4. P-B3	4. Kt-KB3
5. P-Q4	5. PXP
6. PXP	6. B-Kt5 (ch)
7. B-Q2	7. BXB (ch)
8. OKtXB	8. P-Q4
9. PXP	9. KKtXP
10. Q-Kt3	10. QKt-K2
11. Castles (K's side)	11. Castles

Even game.

White.	Black.
1. P-K4	1. P-K4
2. KKt-B3	2. OKt-B3
3. B-Kt5	3. P-QR3
4. B-R4	4. Kt-B3
5. P-Q4	5. PXP
6. P-K5	6. Kt-K5
7. Castles	7. B-K2
8. R-K sq	8. Kt-B4
9. BXB	9. OPXB
10. KtXP	10. Castles
11. Kt-QB3	11. P-KB3

Even game.

White.	Black.
1. P-K4	1. P-K4
2. KKt-B3	2. OKt-B3
3. P-Q4	3. PXP
4. B-QB4	4. B-B4
5. P-B3	5. Kt-B3
6. PXP	

SCOTTI GAMBIT.

The position here arrived at is the same as in the Giuoco Piano opening above.

EVANS GAMBIT.

White.	Black.
1. P-K4	1. P-K4
2. KKt-B3	2. OKt-B3
3. B-B4	3. B-B4
4. P-OKt4	4. BXBtP
5. P-B3	5. B-B4
6. P-Q4	6. PXP
7. Castles	7. P-Q3
8. PXP	8. B-Kt3

White has for its ninth move three approved continuations, viz. B-Kt2, P-Q5, and Kt-B3. To take one of them:—

9. P-Q5	9. Kt-R4
10. B-Kt2	10. Kt-K2
11. B-Q3	11. Castles
12. Kt-B3	12. Kt-Kt3
13. Kt-K2	13. P-QB4
14. Q-Q2	14. P-B3
15. K-R sq	15. B-B2
16. QR-B sq	16. R-Kt sq

This game may be considered about even.

KING'S KNIGHT'S GAMBIT (PROPER).

White.	Black.
1. P-K4	1. P-K4
2. P-KB4	2. PXP
3. KKt-B3	3. P-KKt4
4. B-B4	4. B-Kt2
5. Castles	5. P-Q3
6. P-Q4	6. P-KR3
7. P-B3	7. Kt-K2

Black has the advantage.

ALLGAIER-KIESERITZKI GAMBIT.

White.	Black.
1. P-K4	1. P-K4
2. P-KB4	2. PXP
3. Kt-KB3	3. P-KKt4
4. P-KR4	4. P-Kt5
5. Kt-K5	5. KKt-B3
6. B-B4	6. P-Q4
7. PXP	7. B-Kt2
8. P-Q4	8. Castles
9. BXP	9. KtXP
10. BXBt	10. QXB
11. Castles	11. P-QB4

Black has the better game.

KING'S BISHOP'S GAMBIT.

White.	Black.
1. P-K4	1. P-K4
2. P-KB4	2. PXP
3. B-B4	3. P-Q4
4. BXP	4. Q-R5 (ch)
5. K-B sq	5. P-KKt4
6. KKt-B3	6. Q-R4
7. P-Q4	7. B-Kt2
8. P-KR4	8. P-KR3
9. Kt-B3	9. Kt-K2
10. K-Kt sq	10. P-Kt5
11. Kt-K5	11. BXBt
12. PXB	12. QXKP
13. Q-B sq	13. P-B6
14. P-P	14. Q-Kt6 (ch)
15. Q-Kt 2	

Drawn game.

SALVIO GAMBIT.

White.	Black.
1. P-K4	1. P-K4
2. P-KB4	2. PXP
3. KKt-B3	3. P-KKt4
4. B-B4	4. P-Kt5
5. Kt-K5	5. Q-R5 (ch)
6. K-B sq	6. Kt-KR3
7. P-Q4	7. P-B6
8. Kt-QB3	8. P-Q3
9. Kt-Q3	9. PXP (ch)
10. KXP	10. B-Kt2
11. Kt-KB4	11. Kt-B3
12. B-K3	12. Castles
13. OKt-Q5	13. Q-Q sq
14. P-B3	

White has a slight advantage.

MUZIO GAMBIT.

1. $\frac{P-K4}{P-K4}$	2. $\frac{P-KB4}{PXP}$	3. $\frac{KKt-B3}{P-KKt4}$	4. $\frac{B-B4}{P-Kt5}$
5. Castles	5. PXBt		
6. QXP	6. Q-B3		
7. P-K5	7. QXP		
8. P-Q3	8. B-R3		
9. B-Q2	9. Kt-K2		
10. Kt-B3	10. OKt-B3		
11. QR-K sq	11. Q-KB4		
12. R-K4	12. Castles		
13. OBXP	13. B-Kt2		
14. Q-K2	14. P-Q4		
15. BXP	15. Q-Kt4		
16. P-KR4	16. Q-Kt3		
17. KtXP	17. KtXBt		
18. BXBt	18. B-B4		
19. QR-KB4	19. B-K3		
20. BXB	20. PXB		
21. R-K4	21. RXR (ch)		
22. KXR	22. R-B sq (ch)		
23. K-Kt sq	23. Kt-Q5		

And Black has the better game.

QUEEN'S GAMBIT.

- | | |
|--|--|
| <p>White.</p> <ol style="list-style-type: none"> 1. P-Q4 2. P-QB4 3. P-K3 4. BXP 5. PXP 6. Kt-KB3 7. Castles 8. P-KR3 9. Kt-QB3 | <p>Black.</p> <ol style="list-style-type: none"> 1. P-Q4 2. PXP 3. P-K4 4. PXP 5. B-Q3 6. Kt-KB3 7. Castles 8. P-KR3 9. P-QB3 |
|--|--|

The game is about equal, though White has a somewhat freer position.

The following is a selection of noteworthy games played by great masters:—

KING'S BISHOP'S GAMBIT.

- | | |
|--|--|
| <p>White.</p> <p>Anderssen.</p> <ol style="list-style-type: none"> 1. P-K4 2. P-KB4 3. B-B4 4. K-B sq 5. BxKtP 6. Kt-KB3 7. P-Q3 8. Kt-R4 9. Kt-B5 10. P-KKt4 11. R-Kt sq 12. P-KR4 13. P-R5 14. Q-B3 15. BXP 16. Kt-B3 17. Kt-Q5 18. B-Q6 19. K-K2 20. P-K5 | <p>Black.</p> <p>Kieseritzki.</p> <ol style="list-style-type: none"> 1. P-K4 2. PXP 3. Q-R5 (ch) 4. P-QKt4 5. Kt-KB3 6. Q-R3 7. Kt-R4 8. Q-Kt4 9. P-QB3 10. Kt-B3 11. PxB 12. Q-Kt3 13. Q-Kt4 14. Kt-Kt sq 15. Q-B3 16. B-B4 17. QxKtP 18. QXR (ch) 19. BXR 20. Kt-QR3 |
|--|--|

White mates in three moves.

PHILIDOR'S DEFENCE.

- | | |
|---|--|
| <p>White.</p> <p>Barnes.</p> <ol style="list-style-type: none"> 1. P-K4 2. Kt-KB3 3. P-Q4 4. PxKP 5. Kt-Kt5 6. P-K6 7. Kt-B7 8. B-K3 9. B-KKt5 10. KtXR 11. B-B4 12. Kt-B7 13. R-B sq 14. P-KB3 15. Kt-QR3 16. BxB 17. QxKt 18. Castles 19. B-Kt3 20. K-Kt sq 21. Kt-K5 22. Kt-Q3 23. KtXB | <p>Black.</p> <p>Morphy.</p> <ol style="list-style-type: none"> 1. P-K4 2. P-Q3 3. P-KB4 4. BPXP 5. P-Q4 6. B-QB4 7. Q-B3 8. P-Q5 9. Q-B4 10. QxB 11. Kt-QB3 12. QXP 13. Kt-B3 14. Kt-QKt5 15. BXP 16. Kt-Q6 (ch) 17. PxQ 18. BxKt 19. P-Q7 (ch) 20. B-B4 21. K-B sq 22. R-K sq 23. QXR |
|---|--|

And White resigns.

BISHOP'S GAMBIT.

- | | | | |
|--|--|--|---|
| <p>White.</p> <p>Charousek.</p> <ol style="list-style-type: none"> 1. P-K4 2. P-KB4 3. B-B4 4. P-Q4 5. P-K5 6. B-Kt3 7. Q-Q3 8. Kt-KR3 9. Q-QB3 10. Castles 11. B-R4 (ch) 12. BXP (ch) | <p>Black.</p> <p>Tchigorin.</p> <ol style="list-style-type: none"> 1. P-K4 2. PXP 3. Kt-QB3 4. Kt-B3 5. P-Q4 6. B-Kt5 7. Kt-KR4 8. Kt-Kt5 9. Kt-R3 10. B-K7 11. P-B3 12. PxB | <p>White.</p> <p>Charousek.</p> <ol style="list-style-type: none"> 13. QXP (ch) 14. KtXP 15. BxKt 16. Kt-B3 17. P-K6 18. B-B7 19. BxQ (ch) 20. Q-Kt7 (ch) 21. R-B7 (ch) 22. QXR (ch) 23. R-K sq 24. P-QKt3 | <p>Black.</p> <p>Tchigorin.</p> <ol style="list-style-type: none"> 1. K-K2 2. KtXKt 3. P-R3 4. B-B5 5. R-B sq 6. PXP 7. RxB 8. R-Q2 9. KXR 10. B-K2 11. R-K sq 12. Resigns. |
|--|--|--|---|

This pretty game was played in the tie match for first prize at the Budapest tournament, 1896.

QUEEN'S GAMBIT DECLINED.

- | | | | |
|--|--|---|---|
| <p>White.</p> <p>W. Steinitz.</p> <ol style="list-style-type: none"> 1. P-Q4 2. P-QB4 3. Kt-QB3 4. B-B4 5. P-K3 6. R-B sq 7. QXP 8. PXP 9. Kt-B3 10. B-Q3 11. PXP 12. Castles 13. Kt-QKt5 14. P-B 15. B-K5 16. K-R sq 17. B-Kt3 18. Q-B2 19. QR-Q sq 20. Q-Kt3 | <p>Black.</p> <p>Dr E. Lasker.</p> <ol style="list-style-type: none"> 1. P-Q4 2. P-K3 3. Kt-KB3 4. B-K2 5. Castles 6. P-B4 7. BXP 8. PXP 9. Kt-B3 10. P-Q5 11. KtXP 12. B-KKt5 13. BxKt 14. Kt-K3 15. Kt-R4 16. Q-Kt4 17. QR-Q sq 18. Q-R3 19. R-B sq 20. P-R3 | <p>White.</p> <p>W. Steinitz.</p> <ol style="list-style-type: none"> 21. Kt-B3 22. QXP 23. PxKt 24. QXP 25. Q-B4 26. P-KR4 27. B-K4 28. P-B4 29. B-Kt2 30. Q-Q3 31. Kt-K4 32. R-B3 33. KXR 34. K-R2 35. K-Kt2 36. K-R2 37. R-QKt sq 38. R-Kt5 39. P-R3 | <p>Black.</p> <p>Dr E. Lasker.</p> <ol style="list-style-type: none"> 1. Kt-Q5 2. KtXB (ch) 3. R-Kt sq 4. R-Kt3 5. RXP 6. B-R2 7. Q-Q3 8. Q-Q2 9. Q-Kt5 10. Kt-B4 11. B-K6 12. RxB 13. KtXP (ch) 14. KtXR (ch) 15. Q-R5 (ch) 16. Kt-B4 17. P-R4 18. R-R sq 19. RXP |
|--|--|---|---|

This game was played in the St Petersburg tournament, 1895; a fine specimen of Lasker's style. The final attack, beginning with 21. with Kt-Q5, furnishes a gem of an ending.

RICE GAMBIT.

- | | | | |
|--|--|---|--|
| <p>White.</p> <p>Professor Rice.</p> <ol style="list-style-type: none"> 1. P-K4 2. P-KB4 3. Kt-KB3 4. P-KR4 5. Kt-K5 6. B-B4 7. PXP 8. Castles 9. R-K sq 10. P-B3 11. P-Q4 12. Kt-Q2 13. Kt-B3 14. Q-R4 (ch) | <p>Black.</p> <p>Major Hanham.</p> <ol style="list-style-type: none"> 1. P-K4 2. PXP 3. P-KKt4 4. P-Kt5 5. Kt-KB3 6. P-Q4 7. B-Q3 8. BxKt 9. Q-K2 10. P-Kt6 11. Kt-Kt5 12. QXP 13. Q-R3 14. P-B3 | <p>White.</p> <p>Professor Rice.</p> <ol style="list-style-type: none"> 15. Q-R3 16. RxB (ch) 17. K-B sq 18. Kt-Kt sq 19. PxKt 20. P-Kt5 21. K-K sq 22. K-Q2 23. K-Q3 24. PxB (ch) 25. Q-K7 (ch) 26. Q-Q8 (ch) 27. BxQ and mates | <p>Black.</p> <p>Major Hanham.</p> <ol style="list-style-type: none"> 1. Kt-B7 2. B-K3 3. Q-R8 (ch) 4. Kt-R6 5. P-B6 6. Q-Kt7 (ch) 7. P-B7 (ch) 8. P-B8=Kt (ch) 9. K-Q2 10. K-B2 11. K-Kt3 12. RxQ |
|--|--|---|--|

The Rice Gambit (so called after its inventor, Prof. Isaac L. Rice of New York), whether right or not, is only possible if Black plays 7. B-Q3. Paulsen's 7. B-Kt2 is better, and avoids unnecessary complications. 8. P-Q4 is the usual move. Leaving the knight *en prise*, followed by 9. R-K sq, constitutes the Rice Gambit. The interesting points in the game are that White subjects himself to a most violent attack with impunity, for in the end Black could not save the game by 22. P-B8 claiming a second queen with a discovered check, nor by claiming a knight with double check, as it is equally harmless to White.

GIUOCO PIANO.

- | | | | |
|---|--|--|---|
| <p>White.</p> <p>Steinitz.</p> <ol style="list-style-type: none"> 1. P-K4 2. Kt-KB3 3. B-B4 4. P-B3 5. P-Q4 6. PXP 7. Kt-B3 8. PXP 9. Castles 10. B-KKt5 11. BxKt 12. KtXB 13. BxB | <p>Black.</p> <p>Bardeleben.</p> <ol style="list-style-type: none"> 1. P-K4 2. Kt-QB3 3. B-B4 4. Kt-B3 5. PXP 6. B-Kt5 (ch) 7. P-Q4 8. KtXP 9. B-K3 10. B-K2 11. QBxB 12. QxKt 13. KtXB | <p>White.</p> <p>Steinitz.</p> <ol style="list-style-type: none"> 14. R-K sq 15. Q-K2 16. QR-B sq 17. P-Q5 18. Kt-Q4 19. Kt-K6 20. Q-Kt4 21. Kt-Kt5 (ch) 22. RxKt (ch) 23. R-B7 (ch) 24. R-Kt7 (ch) 25. RXP (ch) | <p>Black.</p> <p>Bardeleben.</p> <ol style="list-style-type: none"> 1. P-KB3 2. Q-Q2 3. P-B3 4. PXP 5. K-B2 6. KR-QB sq 7. P-KKt3 8. K-K sq 9. K-B sq 10. K-Kt sq 11. K-R sq 12. Resigns. |
|---|--|--|---|

As a matter of fact, Bardeleben left the board here, and lost the game by letting his clock run out the time-limit; but Steinitz, who remained at the board, demonstrated afterwards the following variation leading to a forced win:—

- | | | | |
|---|---|---|---|
| <p>White.</p> <p>Steinitz.</p> <ol style="list-style-type: none"> 25. 26. R-Kt7 (ch) 27. Q-R4 (ch) 28. Q-R7 (ch) 29. Q-R8 (ch) 30. Q-Kt7 (ch) | <p>Black.</p> <p>Bardeleben.</p> <ol style="list-style-type: none"> 1. K-Kt sq 2. K-R sq 3. KXR 4. K-B sq 5. K-K2 6. K-K sq | <p>White.</p> <p>Steinitz.</p> <ol style="list-style-type: none"> 31. Q-Kt8 (ch) 32. Q-B7 (ch) 33. Q-B8 (ch) 34. Kt-B7 (ch) 35. Q-Q6 mate. | <p>Black.</p> <p>Bardeleben.</p> <ol style="list-style-type: none"> 1. K-K2 2. K-Q sq 3. Q-K sq 4. Q-Q2 |
|---|---|---|---|

This game was awarded the prize for "brilliance" at the Hastings tournament, 1895.

RUY LOPEZ.

White. Halprin.	Black. Pillsbury.	White. Halprin.	Black. Pillsbury.
1. P-K4	P-K4	14. P-Kt6	BPXP
2. Kt-KB3	Kt-QB3	15. Kt-Q5	PxKt
3. B-Kt5	Kt-B3	16. KR-K sq (ch)	K-B sq
4. Castles	KtXP	17. R-R3	Kt-K4
5. P-Q4	Kt-Q3	18. RxKt	PxR
6. PxP	KtXB	19. R-B3 (ch)	K-Kt sq
7. P-OR4	P-Q3	20. B-R6	Q-K2
8. P-K6	PxP	21. BXP	KxB
9. PxKt	Kt-K2	22. R-Kt3 (ch)	K-B sq
10. Kt-B3	Kt-Kt3	23. R-B3 (ch)	K-Kt2
11. Kt-Kt5	B-K2	24. R-Kt3 (ch)	K-B sq
12. Q-R5	BxKt	25. R-B3 (ch)	K-Kt sq
13. BxB	Q-Q2		Draw.

This brilliant game, played at the Munich tournament, 1900, would be unique had the combinations occurred spontaneously in the game. As a matter of fact, however, the whole variation had been elaborated by Maroczy and Halprin previously, on the chance of Pillsbury adopting the defence in the text. The real merit belongs to Pillsbury, who had to find the correct defence to an attack which Halprin had committed to memory and simply had to be careful to make the moves in regular order.

SICILIAN DEFENCE.

White. Pillsbury.	Black. Mieses.	White. Pillsbury.	Black. Mieses.
1. P-K4	P-QB4	16. PxP	Kt-Q5
2. Kt-KB3	P-K3	17. BxR	KxB
3. P-Q4	PxP	18. R-R2	B-K3
4. KtXP	Kt-KB3	19. R-Q2	R-Ks
5. Kt-QB3	Kt-B3	20. Castles	B-Kt6
6. KKt-Kt5	B-Kt5	21. Q-Kt sq	B-Q4
7. P-OR3	BxKt (ch)	22. B-Q sq	BXP
8. KtXB	P-Q4	23. KxB	Q-Kt4 (ch)
9. PxP	PxP	24. K-R sq	QxR
10. B-KKt5	Castles	25. B-Kt4	Q-B5
11. B-K2	P-Q5	26. R-Kt sq	P-B4
12. Kt-K4	Q-R4 (ch)	27. B-R5	Kt-B6
13. P-Kt4	O-K4	28. BxKt	QxB (ch)
14. KtXKt (ch)	PxKt	29. R-Kt2	R-K7
15. B-R6	P-Q6	30. Q-QB sq	QxQP

Drawn eventually.

This brilliant game occurred at the Paris tournament, 1900.

EVANS GAMBIT.

White. Anderssen.	Black. Dufresne.	White. Anderssen.	Black. Dufresne.
1. P-K4	P-K4	13. O-R4	B-Kt3
2. Kt-KB3	Kt-QB3	14. QKt-Q2	B-Kt2
3. B-B4	B-B4	15. Kt-K4	O-B4
4. P-OKt4	BXP	16. BXP	Q-R4
5. P-B3	B-R4	17. Kt-B6 (ch)	PxKt
6. P-Q4	PxP	18. PxP	R-Kt sq
7. Castles	P-Q6	19. QR-Q sq	QxKt
8. Q-Kt3	Q-B3	20. RxKt (ch)	KtXR
9. P-K5	Q-Kt3	21. QXP (ch)	KxQ
10. R-K sq	KKt-K2	22. B-B5 (ch)	K-K sq
11. B-R3	P-Kt4	23. B-Q7 (ch)	K moves
12. QXP	R-QKt sq	24. BxKt mate.	

This game is most remarkable and brilliant. The *coup de repos* of 19. QR-Q sq is the key-move to the brilliant final combination, the depth and subtlety of which have never been equalled, except perhaps in the following game between Zukertort and Blackburne:—

ENGLISH OPENING.

White. Zukertort.	Black. Blackburne.	White. Zukertort.	Black. Blackburne.
1. P-QB4	P-K3	18. P-K4	QR=QB sq
2. P-K3	Kt-KB3	19. P-K5	Kt-K sq
3. Kt-KB3	P-OKt3	20. P-B4	P-Kt3
4. B-K2	B-Kt2	21. R-K3	P-B4
5. Castles	P-Q4	22. PxP e. p.	KtXP
6. P-Q4	B-Q3	23. P-B5	Kt-K5
7. Kt-B3	Castles	24. BxKt	PxB
8. P-OKt3	QKt-Q2	25. PxKtP	R-B7
9. B-Kt2	Q-K2	26. PxP (ch)	K-R sq
10. Kt-OKt5	Kt-K5	27. P-Q5 dis. (ch)	P-K4
11. KtXB	PxKt	28. O-Kt4	QR-B4
12. Kt-Q2	QKt-B3	29. R-B8 (ch)	KxP
13. P-B3	KtXKt	30. QXP (ch)	K-Kt2
14. QxKt	PxP	31. BxP (ch)	KxR
15. BXP	P-Q4	32. B-Kt7 (ch)	K-Kt sq
16. B-Q3	KR-B sq	33. QxQ	Resigns.
17. QR-K sq	R-B2		

This game, played in the London tournament, 1883, is one of the most remarkable productions of modern times, neither surpassed nor indeed equalled hitherto.

End Games.—A game of chess consists of three branches—the opening, the middle and the end game. The *openings* have been analysed and are to be acquired by the study of the books on the subject. The *middle game* can only be acquired practically. The combinations being inexhaustible in their variety, individual ingenuity has its full scope. Those endowed with a fertile imagination will evolve plans and combinations leading to favourable issues. The less endowed player, however, is not left quite defenceless; he has necessarily to adopt a different system, namely, to try to find a weak point in the arrangement of his opponent's forces and concentrate his attack on that weak spot. As a matter of fact, in a contest between players of equal strength, finding the weak point in the opponent's armour is the only possible plan, and this may be said to be the fundamental principle of the modern school. In the good old days the battles were mostly fought in the neighbourhood of the king, each side striving for a checkmate. Nowadays the battle may be fought anywhere. It is quite immaterial where the advantage is gained be it ever so slight. Correct continuation will necessarily increase it, and the opponent may be compelled to surrender in the end game without being checkmated, or a position may be reached when the enemies, in consequence of the continual fight, are so reduced that the kings themselves have to take the field—the end game. The *end game*, therefore, requires a special study. It has its special laws and the value of the pieces undergoes a considerable change. The kings leave their passive rôle and become attacking forces. The pawns increase in value, whilst that of the pieces may diminish in certain cases. Two knights, for instance, without pawns, become valueless, as no checkmate can be effected with them. In the majority of cases the players must be guided by general principles, as the standard examples do not meet all cases.

The handbooks as a rule give a sprinkling of elementary endings, such as to checkmate with queen, rook, bishop and knight, two bishops, and pawn endings pure and simple, as well as pawns in connexion with pieces in various forms. Towards the end of the 19th century a valuable work on end games was published in England by the late B. Horwitz; thus for the first time a theoretical classification of the art was given. This was followed by a more comprehensive work by Professor J. Berger of Graz, which was translated a few years later by the late Mr Freeborough.

A few specimens of the less accessible positions are given below:—

Position from a Game played by the late J. G. Campbell in 1863.

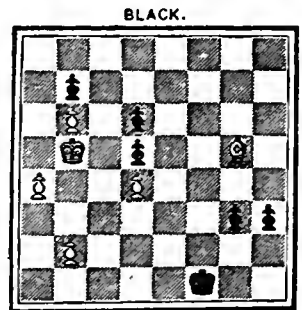

Obviously White has to lose the game, not being able to prevent the pawns from queening. By a remarkably ingenious device White averts the loss of the game by stalemating himself as follows:—

1. B-Q2, P-Kt7; 2. B-R5, P-Kt8=Q; 3. P-Kt4 stalemate.

Position by Sarrall, 1808.

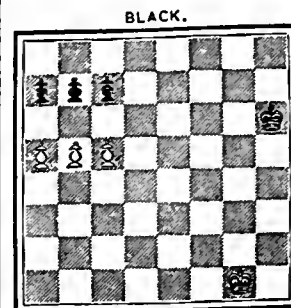

White wins as follows:—
1. P-Kt6, RPxP; 2. P-B6, P(Kt2)xP; 3. P-R6 and wins by queening the pawn. If 1... BPxP then 2. P-R6, KtPxP; 3. P-B6 and queens the pawn.

Problems.—A chess problem¹ has been described as “merely a position supposed to have occurred in a game of chess, being none other than the critical point where your antagonist announces checkmate in a given number of moves, no matter what defence you play,” but the above description conveys no idea of the

Position by B. Horwitz.
BLACK.

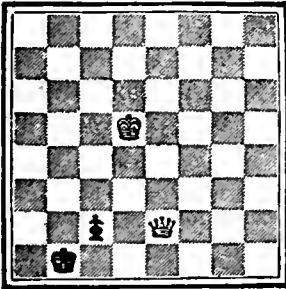

WHITE.

As a rule the game should be drawn. Supposing by a series of checks White were to compel Black to abandon the pawn, he would move K-R8; Q×P and Black is stale-mate. Therefore the ingenious way to win is:—

1. K-B4, P-B8=Q ch; K-Kt3 and wins. Or 1. . . . K-R8 (threatening P-B8=Kt); then 2. Q-Q2 preliminary to K-Kt3 now wins.

Position by B. Horwitz.
BLACK.

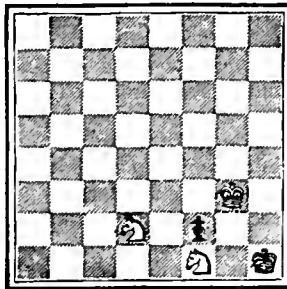

WHITE.

Without Black's pawn White could only draw. The pawn being on the board, White wins as follows:—

1. Kt-B4, K-Kt sq; 2. Kt (B4)-K3, K-R sq; 3. K-Kt4, K-Kt sq; 4. K-R3, K-R sq; 5. Kt-B4, K-Kt sq; 6. Kt (B4)-Q2, K-R sq; 7. Kt-Kt3 ch, K-Kt sq; 8. Kt-B3 mate.

Position by B. Horwitz.
BLACK.

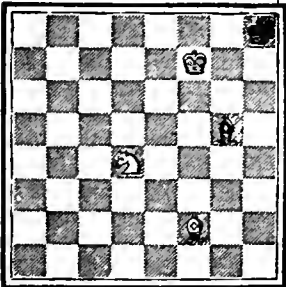

WHITE.

White wins with two pieces against one—a rare occurrence.

1. Kt-K6, B-R3; 2. B-Q4 ch, K-R2; 3. B-B3, B moves anywhere not *en prise*; 4. B-Kt7 and Kt mates.

Position by O. Schubert.
BLACK.

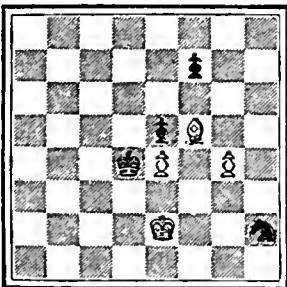

WHITE.

White wins as follows:—

1. P-Kt5, Kt-Kt5; 2. K-B3, Kt-K6; 3. B-K6, Kt-B8; 4. B×P, Kt-Q7 ch; 5. K-Kt4, Kt×P; 6. P-Kt6, Kt-B3, ch; 7. K-Kt5, P-K5; 8. K×Kt, P-K6; 9. B-B4, K×B; 10. P-Kt7, P-K7; 11. P-Kt8=Q ch, and wins by the simple process of a series of checks so timed that the king may approach systematically. The fine points in this instructive ending are the two bishop's moves, 3. B-K6, and 9. B-B4, the latter move enabling White to queen the pawn with a check.

degree to which problem-composing has become a specialized study. Owing its inception, doubtless, to the practice of recording critical phases from actual play, the art of problem composition has so grown in favour as to earn the title of the “poetry” of the game.

¹ The earliest known problem is ascribed to an Arabian caliph of the 9th century. The first known collection is in a manuscript (in the British Museum) of King Alphonso of Castile, dated 1250; it contains 103 problems. The collection of Nicolas of Lombardy, dated 1300, comprises 192 problems.

A good chess problem exemplifies chess strategy idealized and concentrated. In examples of actual play there will necessarily remain on the board pieces immaterial to the issue (checkmate), whereas in problems the composer employs only *indispensable* force so as to focus attention on the idea, avoiding all material

Position by F. Amelung.
BLACK.

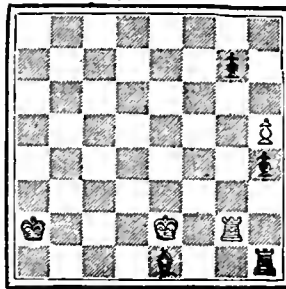

WHITE.

White with the inferior position saves the game as follows:—

1. P-R6, P×P; 2. K-B3 dis. ch, K moves; 3. R-R2, or Kt2 ch, K×R; 4. K-Kt2 and draw, as Black has to give up the rook, and the RP cannot be queened, the Black bishop having no power on the White diagonal. Extremely subtle.

Position by B. Horwitz.
BLACK.

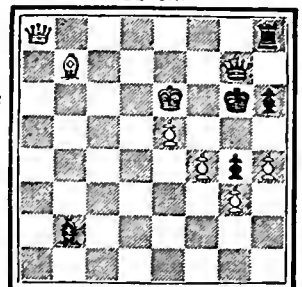

WHITE.

The main idea being to checkmate with the bishop, this is accomplished thus:—1. B-K4 ch, K-R4; 2. Q×R, Q×Q; 3. K-B7, Q-B sq ch; 4. K×Q, B×P; 5. K-B7, B×P; 6. B-Kt6 mate.

Position by A. Troitzky.
BLACK.

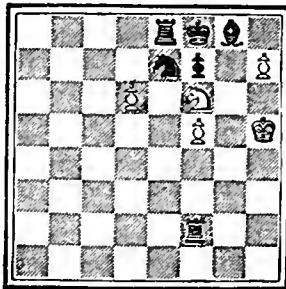

WHITE.

White wins as follows:—

1. P-R8=Q, R-Kt7 ch; 2. K-Kt5, R×Q; 3. Kt-Q7 ch, K-Kt2; 4. P-B6 ch, K-R2; 5. QP×Kt, R-R sq; 6. Kt-B7 ch, R×Kt; 7. P×R=Kt mate.

Position by Hoffer.
BLACK.

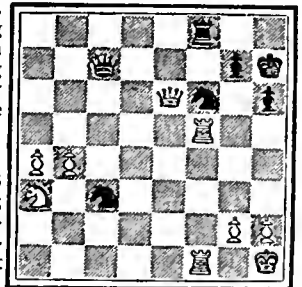

WHITE.

A position from actual play. White plays 1. R-B5 threatening to win a piece. Black replies with the powerful Kt-Kt5, threatening two mates, and finally White (Mr Hoffer) finds an ingenious sacrifice of the Queen—the saving clause.

The following are the moves:—

1. R-B5, Kt-Kt5; 2. Q-Kt8 ch, K-Kt3; 3. Q-K6 ch, K-R2; 4. Q-Kt8 ch, and drawn by perpetual check, as Black cannot capture the Queen with K or R without losing the game.

which would tend to “obscure the issue.” Hence the first object in a problem is to extract the maximum of *finesse* with a sparing use of the pieces, but “economy of force” must be combined with “purity of the mate.” A very common mistake, until comparatively recent years, was that of appraising the “economy” of a position according to the slenderness of the force used, but economy is not a question of absolute values. The true criterion is the ratio of the force employed to the skill demanded. The earliest composers strove to give their productions every appearance of real play, and indeed their compositions

partook of the nature of ingenious end-games, in which it was usual to give Black a predominance of force, and to leave the White king in apparent jeopardy. From this predicament he was extricated by a series of checking moves, usually involving a number of brilliant sacrifices. The number of moves was rarely less than five. In the course of time the solutions were reduced to shorter limits and the beauty of quiet (non-checking) moves began to make itself felt. The early transition school, as it has been called, was the first to recognize the importance of economy, *i.e.* the representation of the main strategic point without any extraneous force. The mode of illustrating single-theme problems, often of depth and beauty, was being constantly improved, and the problems of C. Bayer, R. Willmers, S. Loyd, J. G. Campbell, F. Healey, "J. B." of Bridport, and W. Grimshaw are, of their kind, unsurpassed. In the year 1845 the "Indian" problem attracted much notice, and in 1861 appeared Healey's famous "Bristol" problem. To this period must be ascribed the discovery of most of those clever ideas which have been turned to such good account by the later school. In an article written in 1899 F. M. Teed mentions the fact that his *incomplete* collection of "Indians" totalled over three hundred.

In 1870 or thereabouts, the later transition period, a more general tendency was manifest to illustrate two or more finished ideas in a single problem with strict regard to purity and economy, the theory of the art received greater attention than before and the essays of C. Schwede, Kohtz and Kockelkorn, Lehner and Gelbfuss, helped to codify hitherto unwritten rules of taste. The last quarter of the 19th century, and its last decade especially, saw a marked advance in technique, until it became a common thing to find as much deep and quiet play embodied in a single first-class problem as in three or four of the old-time problems, and hence arose the practice of blending several distinct ideas in one elaborate whole.

In the composition of "two-movers" it is customary to allow greater elasticity and a less rigorous application of the principles of purity and economy. By this means a greater superficial complexity is attained; but the Teutonic and Bohemian schools, and even English and American two-move specialists, recognize that complexity, if it involves the sacrifice of first principles, is liable to abuse. The blind master, A. F. Mackenzie of Jamaica, however, with a few others (notably T. Taverner, W. Gleave, H. and E. Bettman and P. F. Blake) have won some of their greatest successes with problems which, under stricter ruling, would not be allowed.

Bohemian (Czech) composers have long stood unrivalled as exponents of that blending of ideas which is the distinguishing trait of the later problem. Such is their skill in construction that it is rare to find in a problem of the Bohemian school fewer than three or four lines of play which, in economy and purity, are unimpeachable. Amongst the earliest composers of this class Anton König, the founder of the school, Makovsky, Drtina, Palet and Pilnacek deserve to be honourably mentioned, but it was not until the starting of a chess column in the weekly journal *Svetozor* that the merits of the new school were fully asserted. It was in 1871 that Jan Dobrusky contributed his first composition to that paper: he was followed by G. Chocholous, C. Kondelik, Pospisil, Dr Mazel, Kviciala, Kesl, Tuzar, Musil and J. Kotrc; and later still, Havel, Traxler and Z. Mach were no unworthy followers of Dobrusky.

The faculty for blending variations is not without "the defects of its qualities," and consequently among the less able composers a certain tendency to repeat combinations of similar companion ideas is discernible at times, while the danger that facile construction might usurp the place of originality and strategy was already apparent to Chocholous when, in an article on the classification of chess problems (*Deutsche Schachzeitung*, 1890), he warned the younger practitioners of the Bohemian school against what has been dubbed by H. Von Gottschall *Varianteu-leierei*, or "the grinding out of variations." When this one reservation is made few will be inclined to dispute the pre-eminence of the Bohemian school. To some tastes, however, a greater appeal is made by the deeper play of the older German school,

the quaint fancy of the American composer Samuel Loyd, or the severity and freedom from "duals" which mark the English composers.

The idea of holding a problem competition open to the world was first mooted in connexion with the chess congress of 1851, but it was in 1854 that a tourney (confined to British composers) was first held. Since then a number of important problem tournaments have been held.

History of Chess.

The origin of chess is lost in obscurity. Its invention has been variously ascribed to the Greeks, Romans, Babylonians, Scythians, Egyptians, Jews, Persians, Chinese, Hindus, Arabians, Araucanians, Castilians, Irish and Welsh. Some have endeavoured to fix upon particular individuals as the originators of the game; amongst others upon Japheth, Shem, King Solomon, the wife of Ravan, king of Ceylon, the philosopher Xerxes, the Greek chieftain Palamedes, Hermes, Aristotle, the brothers Lydo and Tyrrhene, Semiramis, Zenobia, Attalus (d. c. 200 B.C.), the mandarin Han-sing, the Brahman Sissa and Shatrenscha, stated to be a celebrated Persian astronomer. Many of these ascriptions are fabulous, others rest upon little authority, and some of them proceed from easily traceable errors, as where the Roman games of *Ludus Latruncularum* and *Ludus Calculorum*, the Welsh recreation of *Tawlbrdd* (throw-board) and the ancient Irish pastime of *Filthcall* are assumed to be identical with chess; so far as the Romans and Welsh are concerned, the contrary can be proved, while from what little is known of the Irish game it appears not to have been a sedentary game at all. The claims of the Chinese were advocated in a letter addressed by Mr Eyles Irwin in 1793 to the earl Charlemont. This paper was published in the *Transactions of the Royal Irish Academy*, and its purport was that chess, called in the Chinese tongue *chong-ki* (the "royal game") was invented in the reign of Kao-Tsu, otherwise Lin-Pang, then king, but afterwards emperor of Kiang-Nang, by a mandarin named Han-sing, who was in command of an army invading the Shen-Si country, and who wanted to amuse his soldiers when in winter quarters. This invasion of the Shen-Si country by Han-Sing took place about 174 B.C. Capt. Hiram Cox states that the game is called by the Chinese *choke-choo-hong ki*, "the play of the science of war." (See also a paper published by the Hon. Daines Barrington in the 9th vol. of the *Archaeologia*.) Mr N. Bland, M.R.A.S., in his *Persian Chess* (London, 1850), endeavours to prove that the Persians were the inventors of chess, and maintains that the game, born in Persia, found a home in India, whence after a series of ages it was brought back to its birthplace. The view, however, which has obtained the most credence, is that which attributes the origin of chess to the Hindus. Dr Thomas Hyde of Oxford, writing in 1694 (*De Ludis Orientalibus*), seems to have been the first to propound this theory, but he appears to have been ignorant of the game itself, and the Sanskrit records were not accessible in his time. About 1783-1789 Sir William Jones, in an essay published in the 2nd vol. of *Asiatic Researches*, argued that Hindustan was the cradle of chess, the game having been known there from time immemorial by the name of *chatur-anga*, that is, the four *angas*, or members of an army, which are said in the *Amarakosha* to be elephants, horses, chariots and foot soldiers. As applicable to real armies, the term *chaturanga* is frequently used by the epic poets of India. Sir William Jones's essay is substantially a translation of the *Bhawishya Purana*, in which is given a description of a four-handed game of chess played with dice. A pundit named Rhadhakant informed him that this was mentioned in the oldest law books, and also that it was invented by the wife of Ravan, king of Lanka (Ceylon), in the second age of the world in order to amuse that monarch while Rama was besieging his metropolis. This account claims for chess an existence of 4000 or 5000 years. Sir William, however, grounds his opinions as to the Hindu origin of chess upon the testimony of the Persians and not upon the above manuscript, while he considers the game described therein to be more modern than the Persian game. Though sure that the latter came from India and was invented there, he admits that he could not find any account

of it in the classical writings of the Brahmans. He lays it down that chess, under the Sanskrit name *chaturanga*, was exported from India into Persia in the 6th century of our era; that by a natural corruption the old Persians changed the name into *chatrang*, but when their country was soon afterwards taken possession of by the Arabs, who had neither the initial nor final letter of the word in their alphabet, they altered it further into *shatranj*, which name found its way presently into modern Persian and ultimately into the dialects of India.

Capt. Hiram Cox, in a letter upon Burmese chess, written in 1799 and published in the 7th vol. of *Asiatic Researches*, refers to the above essay, and considers the four-handed game described in the Sanskrit manuscript to be the most ancient form of chess, the Burmese and Persian games being second and third in order of precedence. Later, in the 11th and 24th vols. of the *Archæologia*, Mr Francis Douce and Sir Frederick Madden expressed themselves in favour of the views held by Hyde and his followers.

In Professor Duncan Forbes's *History of Chess* (1860) Capt. Cox's views, as founded upon Sir William Jones's Sanskrit manuscript, are upheld and are developed into an elaborate theory. Professor Forbes holds that the four-handed game of *chaturanga* described in the *Bhawishya Purana* was the primeval form of chess; that it was invented by a people whose language was Sanskrit (the Hindus); and that it was known and practised in India from a time lost in the depths of a remote antiquity, but for a period the duration of which may have been from 3000 to 4000 years before the 6th century of the Christian era. He endeavours to show, but adduces no proof, how the four armies commanded by four kings in Sir William Jones's manuscript became converted into two opposing armies, and how two of the kings were reduced to a subordinate position, and became "monitors" or "counsellors," one standing by the side of the White and the other of the Black king, these counsellors being the *farzins* from which we derive our "queens." Among other points he argues, apparently with justice, that *chaturanga* was evidently the root of *shatranj*, the latter word being a mere exotic in the language of the inhabitants of Persia.

Van der Linde, in his exhaustive work, *Geschichte und Litteratur des Schachspiels* (Berlin, 1874), has much to say of the origin-theories, nearly all of which he treats as so many myths. He agrees with those who consider that the Persians received the game from the Hindus; but the elaborate *chaturanga* theories of Forbes receive but scant mercy. Van der Linde argues that *chaturanga* is always used by the old Indian poets of an army and never of a game, that all Sanskrit scholars are agreed that chess is not mentioned in really ancient Hindu records; that the *Puranas* generally, though formerly considered to be extremely old, are held in the light of modern research to reach no farther back than the 10th century—while the copies of the *Bhawishya Purana* in the British Museum and the Berlin Library do not contain the extract relied upon by Forbes, though it is to be found in the *Raghnandana*, which was translated by Weber in 1872, and is stated by Bühler to date from the 16th century. The outcome of van der Linde's studies appears to be that chess certainly existed in Hindustan in the 8th century, and that probably that country is the land of its birth. He inclines to the idea that the game originated among the Buddhists, whose religion was prevalent in India from the 3rd to the 9th century. According to their ideas, war and the slaying of one's fellow-men, for any purposes whatever, is criminal, and the punishment of the warrior in the next world will be much worse than that of the simple murderer; hence chess was invented as a substitute for war. In opposition to Forbes, therefore, and in agreement with Sir William Jones, van der Linde takes the view that the four-handed game of the original manuscript is a comparatively modern adaptation of the Hindu chess, and he altogether denies that there is any proof that any form of the game has the antiquity attributed to it. Internal evidence certainly seems to contradict the theory that Sir William Jones's manuscript is very ancient testimony; for it mentions two great sages, Vyasa and Gotama, the former as teaching *chaturanga* to Prince Yudhishtira, and the other as giving an opinion upon certain principles of the game; but this could not well be, seeing that it was played with dice, and that all

games of hazard were positively forbidden by Manu. It would appear also that Indian manuscripts are not absolutely trustworthy as evidence of the antiquity of their contents; for the climate has the effect of destroying such writings in a period of 300 or 400 years. They must, therefore, be recopied from time to time and in this way later interpolations may easily creep in.

Von der Lasa, who had, in an article prefixed to the *Handbuch* in 1864, accepted Forbes's views, withdrew his support in a review of the work just noticed, published in the September and November numbers of the *Deutsche Schachzeitung*, 1874, and expressed his adherence to the opinions of van der Linde.

Altogether, therefore, we find the best authorities agreeing that chess existed in India before it is known to have been played anywhere else. In this supposition they are strengthened by the names of the game and of some of the pieces. *Shatranj*, as Forbes has pointed out, is a foreign word among the Persians and Arabians, whereas its natural derivation from the term *chaturanga* is obvious. Again *al-fil*, the Arabic name of the bishop, means the elephant, otherwise *alephhind*, the Indian ox. Our earliest authority on chess is Masudi, an Arabic author who wrote about A.D. 950. According to him, *shatranj* had existed long before his time; and though he may speak not only for his own generation but for a couple of centuries before, that will give to chess an existence of over a thousand years.

Early and Medieval Times.—The dimness which shrouds the origin of chess naturally obscures also its early history. We have seen that chess crossed over from India into Persia, and became known in the latter country by the name of *shatranj*. Some have understood that word to mean "the play of the king"; but undoubtedly Sir William Jones's derivation carries with it the most plausibility. How and when the game was introduced into Persia we have no means of knowing. The Persian poet Firdusi, in his historical poem, the *Shahnama*, gives an account of the introduction of *shatranj* into Persia in the reign of Chosroes I. Anushirwan, to whom came ambassadors from the sovereign of Hind (India), with a chess-board and men asking him to solve the secrets of the game, if he could, or pay tribute. Chosroes I. was the contemporary of Justinian, and reigned in the 6th century A.D. Professor Forbes seems to think that this poem may be looked upon as an authentic history. This appears, however, to be somewhat dangerous, especially as Firdusi lived some 450 years after the supposed event took place; but since other Persian and Arabian writers state that *shatranj* came into Persia from India, there appears to be a consensus of opinion that may be considered to settle the question. Thus we have the game passing from the Hindus to the Persians and thence to the Arabians, after the capture of Persia by the Caliphs in the 7th century, and from them, directly or indirectly, to various parts of Europe, at a time which cannot be definitely fixed, but either in or before the 11th century. That the source of the European game is Arabic is clear enough, not merely from the words "check" and "mate," which are evidently from *Shah mat* ("the king is dead"), but also from the names of some of the pieces. There are various chess legends having reference to the 7th and 8th centuries, but these may be neglected as historically useless; and equally useless appear the many oriental and occidental romances which revolve around those two great central figures, Harun al-Rashid and Charlemagne. There is no proof that either of them knew anything of chess or, so far as the latter is concerned, that it had been introduced into Europe in his time. True, there is an account given in Gustavus Selenus, taken from various old chronicles, as to the son of Prince Okar or Otkar of Bavaria having been killed by a blow on the temple, struck by a son of Pippin after a game of chess; and there is another well-known tradition as to the magnificent chess-board and set of men said to have been sent over as a present by the empress Irene to Charlemagne. But both tales are not less mythical than the romance which relates how the great Frankish monarch lost his kingdom over a game of chess to Guérin de Montglave; for van der Linde shows that there was no Bavarian prince of the name of Okar or Otkar at the period alluded to, and as ruthlessly shatters the

tradition about Irene's chessmen. With respect to Harun al-Rashid, among the various stories told which connect him with chess, there is one that at first sight may seem entitled to some degree of credit. In the annals of the Moslems by Abulfeda (Abu'l Fida), there is given a copy of a letter stated to be "From Nicephorus, emperor of the Romans, to Harun, sovereign of the Arabs," which (using Professor Forbes's translation) after the usual compliments runs thus:—"The empress (Irene) into whose place I have succeeded, looked upon you as a *Rukh* and herself as a mere Pawn; therefore she submitted to pay you a tribute more than the double of which she ought to have exacted from you. All this has been owing to female weakness and timidity. Now, however, I insist that you, immediately on reading this letter, repay to me all the sums of money you ever received from her. If you hesitate, the sword shall settle our accounts." Harun's reply, written on the back of the Byzantine emperor's letter, was terse and to the point. "In the name of God the merciful and gracious. From Harun, the commander of the faithful, to the Roman dog Nicephorus. I have read thine epistle, thou son of an infidel mother; my answer to it thou shalt see, not hear." Harun was as good as his word, for he marched immediately as far as Heraclea, devastating the Roman territories with fire and sword, and soon compelled Nicephorus to sue for peace. Now the points which give authority to this narrative and the alleged correspondence are that the relations which they assume between Irene and Nicephorus on the one hand and the warlike caliph on the other are confirmed by the history of those times, while, also, the straightforward brevity of Harun's reply commends itself as what one might expect from his soldier-like character. Still, the fact must be remembered that Abulfeda lived about five centuries after the time to which he refers. Perhaps we may assume that it is not improbable that the correspondence is genuine; but that the words *ruk* and *pawn* may have been substituted for other terms of comparison originally used.

As to how chess was introduced into western and central Europe nothing is really known. The Spaniards very likely received it from their Moslem conquerors, the Italians not improbably from the Byzantines, and in either case it would pass northwards to France, going on thence to Scandinavia and England. Some say that chess was introduced into Europe at the time of the Crusades, the theory being that the Christian warriors learned to play it at Constantinople. This is negated by a curious epistle of St Peter Damian, cardinal bishop of Ostia, to Pope Alexander II., written about A.D. 1061, which, assuming its authenticity, shows that chess was known in Italy before the date of the first crusade. The cardinal, as it seems, had imposed a penance upon a bishop whom he had found diverting himself at chess; and in his letter to the pope he repeats the language he had held to the erring prelate, viz. "Was it right, I say, and consistent with thy duty, to sport away thy evenings amidst the vanity of chess, and defile the hand which offers up the body of the Lord, and the tongue that mediates between God and man, with the pollution of a sacrilegious game?" Following up the same idea that statutes of the church of Elna, in the 3rd vol. of the *Councils of Spain*, say, "Clerks playing at dice or chess shall be *ipso facto* excommunicated." Eudes de Sully, bishop of Paris under Philip Augustus, is stated in the *Ordonn. des Rois de France* to have forbidden clerks to play the game, and according to the *Hist. Eccles.* of Fleury, St Louis, king of France, imposed a fine on all who should play it. Ecclesiastical authorities, however, seemed to have differed among themselves upon the question whether chess was or was not a lawful game according to the canons, and Peirino (*De Proelat.* chap. 1) holds that it was permissible for ecclesiastics to play thereat. Among those who have taken an unfavourable view of the game may be mentioned John Huss, who, when in prison, deplored his having played at chess, whereby he had lost time and run the risk of being subject to violent passions. Among authentic records of the game may be quoted the *Alexiad* of the princess Anna Comnena, in which she relates how her father, the emperor Alexius, used to divert his mind

from the cares of state by playing at chess with his relatives. This emperor died in 1118.

Concerning chess in England there is the usual confusion between legend and truth. Snorre Sturleson relates that as Canute was playing at chess with Earl Ulf, a quarrel arose, which resulted in the upsetting of the board by the latter, with the further consequence of his being murdered in church a few days afterwards by Canute's orders. Carlyle, in *The Early Kings of Norway*, repeats this tale, but van der Linde treats it as a myth. The *Ramsey Chronicle* relates how bishop Utheric, coming to Canute at night upon urgent business, found the monarch and his courtiers amusing themselves at dice and chess. There is nothing intrinsically improbable in this last narrative; but Canute died about 1035, and the date, therefore, is suspiciously early. Moreover, allowance must be made for the ease with which chroniclers described other games as chess. William the Conqueror, Henry I., John and Edward I. are variously stated to have played at chess. It is generally supposed that the English court of exchequer took its name from the cloth, figured with squares like a chess-board, which covered the table in it (see EXCHEQUER). An old writer says that at the coronation of Richard I. in 1189, six earls and barons carried a chess-board with the royal insignia to represent the exchequer court. According to Edmonson's *Heraldry*, twenty-six English families bore chess rooks in their coats of arms.

As regards the individual pieces, the king seems to have had the same move as at present; but it is said he could formerly be captured. His "castling" privilege is a European invention; but he formerly leaped two and even three squares, and also to his Kt 2nd. Castling dates no farther back than the first half of the 16th century. The queen has suffered curious changes in name, sex and power. In *shatranj* the piece was called *farz* or *firz* (also *farzan*, *farzin* and *farzi*), signifying a "counsellor," "minister" or "general." This was latinized into *farzia* or *fercia*. The French slightly altered the latter form into *fierce*, *fierge*, and as some say, *vierge*, which, if true, might explain its becoming a female. Another and much more probable account has it that whereas formerly a pawn on reaching an eighth square became a *farzin*, and not any other piece, which promotion was of the same kind as at draughts (in French, *dames*), so she became a *dame* or queen as in the latter game, and thence *dama*, *domna*, &c. There are old Latin manuscripts in which the terms *ferzia* and *regina* are used indifferently. The queen formerly moved only one square diagonally and was consequently the weakest piece on the board. The immense power she now possesses seems to have been conferred upon her so late as about the middle of the 15th century. It will be noticed that under the old system the queens could never meet each other, for they operated on diagonals of different colours. The bishop's scope of action was also very limited formerly; he could only move two squares diagonally, and had no power over the intermediate square, which he could leap over whether it was occupied or not. This limitation of their powers prevailed in Europe until the 15th century. This piece, according to Forbes, was called among the Persians *pil*, an elephant, but the Arabs, not having the letter *p* in their alphabet, wrote it *fil*, or with their definite article *al-fil*, whence *alphilus*, *alfinus*, *alifere*, the latter being the word used by the Italians; while the French perhaps get their *fol* and *fou* from the same source. The pawns formerly could move only one square at starting; their powers in this respect were increased about the early part of the 16th century. It was customary for them on arriving at an eighth square to be exchanged only for a *farzin* (queen), and not any other piece; the rooks (so called from the Indian *ruk* and Persian *rokh*, meaning "a soldier") and the knights appear to have always had the same powers as at present. As to the chessboards, they were formerly uncoloured, and it is not until the 13th century that we hear of checkered boards being used in Europe.

Development in Play.—The change of *shatranj* into modern chess took place most probably first in France, and thence made its way into Spain early in the 15th century, where the new game was called *Axedrez de la dama*, being also adopted by the Italians

under the name of *scaeci alla rabiosa*. The time of the first important writer on modern chess, the Spaniard Ruy Lopez de Segura (1561), is also the period when the latest improvement, castling, was introduced, for his book (*Libro de la invencion liberal y arte del juego del Axedrez*), though treating of it as already in use, also gives the old mode of play, which allowed the king a leap of two or three squares. Shortly afterwards the old *shatranj* disappears altogether. Lopez was the first who merits the name of chess analyst. At this time flourished the flower of the Spanish and Italian schools of chess—the former represented by Lopez, Ceron, Santa Maria, Busnardo and Avalos; the latter by Giovanni Leonardo da Cutri (il Puttino) and Paolo Boi (il Syracusano). In the years 1562-1575 both Italian masters visited Spain and defeated their Spanish antagonists. During the whole 17th century we find but one worthy to be mentioned, Giacchino Greco (il Calabrese). The middle of the 18th century inaugurates a new era in chess. The leading man of this time was François André Danican Philidor. He was born in 1726 and was trained by M. de Kermur, Sire de Légal, the star of the *Café de la Régence* in Paris, which has been the centre of French chess ever since the commencement of the 18th century. In 1747 Philidor visited England, and defeated the Arabian player, Phillip Stamma, by 8 games to 1 and 1 draw. In 1749 he published his *Analyse des échecs*, a book which went through more editions and was more translated than any other work upon the game. During more than half a century Philidor travelled much, but never went to Italy, the only country where he could have found opponents of first-rate skill. Italy was represented in Philidor's time by Ercole del Rio, Lollì and Ponziani. Their style was less sound than that of Philidor, but certainly a much finer, and in principle a better one. As an analyst the Frenchman was in many points refuted by Ercole del Rio ("the anonymous Modenese"). Blindfold chess-play, already exhibited in the 17th century by Arabian and Persian experts, was taken up afresh by Philidor, who played on many occasions three games simultaneously without sight of board or men. These exhibitions were given in London, at the Chess Club in St James's Street, and Philidor died in that city in 1795. As eminent players of this period must be mentioned Count Ph. J. van Zuylen van Nyevelt (1743-1826), and the German player, J. Allgaier (1763-1823), after whom a well-known brilliant variation of the King's Gambit is named. Philidor was succeeded by Alexandre Louis Honoré Lebreton Deschappelles (1780-1847), who was also a famous whist player. The only player who is known to have fought Deschappelles not unsuccessfully on even terms is John Cochrane. He also lost a match (1821) to W. Lewis, to whom he conceded the odds of "paw and move," the Englishman winning one and drawing the two others. Deschappelles' greatest pupil, and the strongest player France ever possessed, was Louis Charles Mahé de la Bourdonnais, who was born in 1797 and died in 1840. His most memorable achievement was his contest with the English champion, Alexander Macdonnell, the French player winning in the proportion of three to two.

The English school of chess began about the beginning of the 19th century, and Sarratt was its first leader. He flourished from 1808 to 1821, and was followed by his great pupil, W. Lewis, who will be principally remembered for his writings. His literary career belongs to the period from 1818 to 1848 and he died in 1869. A. Macdonnell (1798-1835) has been already mentioned. To the same period belong also Captain Evans, the inventor of the celebrated "Evans Gambit" (1828), who died at a very advanced age in 1873; Perigal, who participated in the correspondence matches against Edinburgh and Paris; George Walker, for thirty years chess editor of *Bell's Life in London*; and John Cochrane, who met every strong player from Deschappelles downwards. In the same period Germany possessed but one good player, J. Mendheim of Berlin. The fifth decade of the 19th century is marked by the fact that the leadership passed from the French school to the English. After the death of la Bourdonnais, Fournié de Saint-Amant became the leading player in France; he visited England in the early part of 1843,

and successfully met the best English players, including Howard Staunton (*q.v.*); but the latter soon took his revenge, for in November and December 1843 a great match between Staunton and Saint-Amant took place in Paris, the English champion winning by 11 games to 6 with 4 draws. During the succeeding eight years Staunton maintained his reputation by defeating Popert, Horwitz and Harrwitz. Staunton was defeated by Anderssen at the London tournament in 1851, and this concluded his match-playing career. Among the contemporaries of Staunton may be mentioned Henry Thomas Buckle, author of the *History of Civilization*, who defeated Kieseritzki, Anderssen and Löwenthal.

In the ten years 1830-1840 a new school arose in Berlin, the seven leaders of which have been called "The Pleiades." These were Bledow (1795-1846), Bilguer (1815-1840), Hanstein (1810-1850), Mayet (1810-1868), Schorn (1802-1850), B. Horwitz (b. 1809) and von Heydebrandt und der Lasa, once German ambassador at Copenhagen. As belonging to the same period must be mentioned the three Hungarian players, Grimm, Szen and J. Löwenthal.

Among the great masters since the middle of the 19th century Paul Morphy (1837-1884), an American, has seldom been surpassed as a chess player. His career was short but brilliant. Born in New Orleans in 1837, he was taught chess by his father when only ten years of age, and in two years' time became a strong player. When not quite thirteen he played three games with Löwenthal, and won two of them, the other being drawn. He was twenty years of age when he competed in the New York congress of 1857, where he won the first prize. In 1858 he visited England, and there defeated Boden, Medley, Mongrédien, Owen, Bird and others. He also beat Löwenthal by 9 games to 3 and 2 drawn. In the same year he played a match at Paris with Harrwitz, winning by 5 to 2 and 1 drawn; and later on he obtained a victory over Anderssen. On two or three occasions he played blindfold against eight strong players simultaneously, each time with great success. He returned to America in 1859 and continued to play, but with decreasing interest in the game, until 1866. He died in 1884.

Wilhelm Steinitz (b. 1836) took the sixth prize at the London congress of 1862. He defeated Blackburne in a match by 7 to 1 and 2 drawn. In 1866 he beat Anderssen in a match by 8 games to 6. In 1868 he carried off the first prize in the British Chess Association handicap, and in 1872 in the London grand tourney, also defeating Zukertort in a match by 7 games to 1 and 4 drawn. In 1873 he carried off the first prize at the Vienna congress; and in 1876 he defeated Blackburne, winning 7 games right off. In 1872-1874, in conjunction with W. N. Potter, he conducted and won a telegraphic correspondence match for London against Vienna. In Philidor's age it was considered almost incredible that he should be able to play three simultaneous games without seeing board or men, but Paulsen, Blackburne and Zukertort often played 10 or 12 such games, while as many as 14 and 15 have been so played.

In 1876 England was in the van of the world's chess army. English-born players then were Boden, Burn, Macdonnell, Bird, Blackburne and Potter; whilst among naturalized English players were Löwenthal, Steinitz, Zukertort, who died in 1888, and Horwitz. This illustrious contingent was reinforced in 1878 by Mason, an Irish-American, who came over for the Paris tournament; by Gunsberg, a Hungarian; and later by Teichmann, who also made England his home. English chess flourished under the leadership of these masters, the chief prizes in tournaments being consistently carried off by the English representatives.

To gauge the progress made by the game since about 1875 it will suffice to give the following statistics. In London Simpson's Divan was formerly the chief resort of chess players; the St George's Chess Club was the principal chess club in the West End, and the City of London Chess Club in the east. About a hundred or more clubs are now scattered all over the city. Formerly only the British Chess Association existed; after its dissolution the now defunct Counties' Chess Association took

its place, and this was superseded by the re-establishment by Mr Hoffer of the British Chess Association, which again fell into abeyance after having organized three international tournaments—London, 1886; Bradford, 1888; and Manchester, 1890—and four national tournaments. There were various reasons why the British Chess Association ceased to exercise its functions, one being that minor associations did not feel inclined to merge their identity in a central association. The London League was established, besides the Northern Chess Union, the Southern Counties' Chess Union, the Midland Counties' Union, the Kent County Association; and there are associations in Surrey, Sussex, Essex, Hampshire, Wiltshire, Gloucestershire, Somersetshire, Cambridgeshire, Herefordshire, Leicestershire, Northamptonshire, Staffordshire, Worcestershire and Lancashire. All these associations are supported by the affiliated chess clubs of the respective counties. Scotland (which has its own association), Wales and Ireland have also numerous clubs.

Still, England did not produce one new eminent player between 1875 and 1905. First-class chess remained in the hands of the veterans Burn, Blackburne, Mason and Bird. The old amateurs passed away, their place being taken by a new generation of powerful amateurs, so well equipped that Great Britain could hold its own in an amateur contest against the combined forces of Germany, Austria, Holland and Russia. The terms *master* and *amateur* are not used in any invidious sense, but simply as designating, in the former case, first-class players, and in the latter, those just on the borderland of highest excellence. The professional element as it existed in the heyday of Simpson's Divan almost disappeared, the reason being the increased number of chess clubs, where enthusiasts and students might indulge in their favourite pastime to their heart's content, tournaments with attractive prizes being arranged during the season. The former occupation of the masters vanished in consequence; the few who remained depended upon the passing visitors from the provinces who were eager to test their strength by the standard of the master. Blackburne visited the provinces annually, keeping the interest in first-class chess alive by his simultaneous play and his extraordinary skill as a blindfold player—unsurpassed until the advent of Harry Nelson Pillsbury (1872–1906), the leading American master since Morphy.

Germany has produced great chess players in Tarrasch, E. Lasker, Lipke, Fritz, Bardeleben, Walbrodt and Mieses, besides a goodly number of amateurs. Austria produced Max Weiss, Schlechter, Marco and Hruba, to say nothing of such fine players as the Fleissigs, Dr Mertner, Dr Kaufmann, Fahndrich, Jacques Schwarz and others. Hungary was worthily represented by Maroczy, Makovetz and Brody, Maroczy being the best after Charousek's death. Russia, having lost Jaenisch, Petroff and Schumoff, discovered Tchigorin, Janowsky, Schiffers, Alapin, Winawer and Taubenhau. France showed a decline for many years, having only the veteran M. Arnous de Rivière and the naturalized M. Rosenthal left, followed by Goetz and two good amateurs, MM. Didier and Billicard. Italy had only Signor Salvioli, although Signor Reggio came to the fore. Holland had a fair number of players equal to the English amateurs, but no master since the promising young van Lennep died.

The first modern International Chess Tournament held in London in 1851 was the forerunner of various similar contests of which the following is a complete table:—

Tournaments.

1851. London. 1 Anderssen, 2 Wyvill, 3 Williams.
 1857. Manchester. 1 Löwenthal, 2 Anderssen.
 1857. New York. 1 Morphy, 2 L. Paulsen.
 1858. Birmingham. 1 Löwenthal, 2 Falkbeer.
 1860. Cambridge. 1 Kolisch, 2 Stanley.
 1861. Bristol. 1 L. Paulsen, 2 Boden.
 1862. London. 1 Anderssen, 2 L. Paulsen, 3 Owen.
 1865. Dublin. 1 Steinitz, 2 MacDonnell.
 1866. Redcar. De Vere.
 1866. English Championship Cup. De Vere.
 1866. British Chess Association. 1 Steinitz, 2 Green.
 1867. Paris. 1 Kolisch, 2 Winawer, 3 Steinitz.
 1867. Dundee. 1 Neumann, 2 Steinitz, 3 De Vere and MacDonnell.

1868. English Championship Cup. 1 Blackburne, 2 De Vere.
 1868. British Chess Association Handicap. 1 Steinitz, 2 Wisker, 3 Blackburne.
 1870. Baden-Baden. 1 Anderssen, 2 Steinitz, 3 Blackburne and Neumann.
 1870. English Championship Cup. 1 Wisker, 2 Burn.
 1870–1871. City of London Handicap. 1 Potter, 2 De Vere.
 1871–1872. City of London Handicap. 1 Steinitz, 2 Keats.
 1872. London. 1 Steinitz, 2 Blackburne, 3 Zukertort.
 1872. English Championship Cup. 1 Wisker (becoming permanent holder of the cup), 2 De Vere.
 1873. Vienna. 1 Steinitz, 2 Blackburne, 3 Anderssen.
 1876. London. 1 Blackburne, 2 Zukertort, 3 Potter.
 1878. Paris. 1 Zukertort, 2 Winawer (after a tie with Zukertort), 3 Blackburne.
 1880. Wiesbaden. 1, 2, and 3, a tie between Blackburne, Englisch and A. Schwarz.
 1881. Berlin. 1 Blackburne, 2 Zukertort, 3 Tchigorin and Winawer. Tchigorin made his first public appearance in this contest.
 1882. Vienna. 1 Steinitz and Winawer, 3 Mason.
 1883. London. 1 Zukertort, 2 Steinitz, 3 Blackburne.
 1883. Nuremberg. 1 Winawer, 2 Blackburne, 3 Mason. This tournament is a milestone in modern chess history. The prizes being comparatively small, it was thought that it necessarily must be a failure, the munificently endowed London tournament having just been completed. But, strange to say, whilst in London fourteen players competed, there were nineteen entries in Nuremberg. Winawer, not placed in the former, won the first prize in the latter.
 1885. Hamburg. 1 Gunsberg; the next prizes were divided by Blackburne, Mason, Englisch, Tarrasch and Weiss.
 1885. Hereford. 1 Blackburne, 2 and 3 Bird and Schallopp.
 1886. London. 1 Blackburne, 2 Burn, 3 Gunsberg and Taubenhau.
 1886. Nottingham. 1 Burn, 2 Schallopp, 3 Gunsberg and Zukertort.
 1887. Frankfurt. 1 Mackenzie, 2 Blackburne and Weiss.
 1888. Bradford. 1 Gunsberg, 2 Mackenzie, 3 Mason and Bardeleben.
 1889. New York. 1 Tchigorin and Weiss, 3 Gunsberg.
 1889. Breslau. 1 Tarrasch, 2 Burn, 3 Weiss.
 1890. Amsterdam. 1 Burn, 2 Lasker, 3 Mason. There were only nine competitors, Lasker unexpectedly losing to van Vliet by a trap.
 1890. Manchester. 1 Tarrasch, 2 Blackburne, 3 Bird and Mackenzie.
 1892. Dresden. 1 Tarrasch, 2 Makovetz and Porges. Blackburne received a special prize.
 1894. Leipzig. 1 Tarrasch, 2 Lipke and Teichmann.
 1895. Hastings. 1 Pillsbury, 2 Tchigorin, 3 Lasker. This tournament is historical for the first appearance of Pillsbury, the American champion, and Maroczy, the Hungarian champion.
 1896. Nuremberg. 1 Lasker, 2 Maroczy, 3 Pillsbury and Tarrasch.
 1896. Budapest. 1 Tchigorin, 2 Charousek, 3 Pillsbury.
 1897. Berlin. 1 Charousek, 2 Walbrodt, 3 Blackburne. Englisch had to abandon the tournament and return to Vienna ill. He never recovered and died a few weeks later.
 1898. Vienna. 1 Tarrasch, 2 Pillsbury, 3 Janowsky. Tarrasch achieved a remarkable victory in this important tournament. Pillsbury's chances were better than his, but he managed to run him neck and neck and beat him in the tie match which followed.
 1898. Cologne. 1 Burn, 2 Charousek, Cohn and Tchigorin.
 1899. London. 1 Lasker, 2 Janowsky, Maroczy and Pillsbury. Janowsky sacrificed the second prize by trying to win a game against Steinitz when with an easy draw in hand he could have secured the second place for himself alone.
 1900. Munich. Tie between Maroczy, Pillsbury and Schlechter for three chief prizes.
 1900. Paris. 1 Lasker, 2 Pillsbury, 3 Maroczy and Marshall.
 1901. Monte Carlo. 1 Janowsky, 2 Schlechter, 3 Scheve and Tchigorin. A novel rule was introduced at this tournament, viz. the first drawn game to count $\frac{1}{2}$ to each player, to be replayed, and in case of a draw again to count $\frac{1}{2}$ each, and in case of win $\frac{1}{2}$ to the winner. Theoretically this seems logical, but in practice it did not work well.
 1902. Monte Carlo. 1 Pillsbury and Maroczy, 3 Janowsky.
 1902. Hanover. 1 Janowsky, 2 Pillsbury, 3 Atkins.
 1903. Monte Carlo. 1 Tarrasch, 2 Maroczy, 3 Pillsbury.
 1904. Monte Carlo. 1 Maroczy, 2 Schlechter, 3 Marshall.
 1904. Cambridge Springs. 1 Marshall, 2 Lasker and Janowsky.
 1905. Ostend. 1 Maroczy, 2 Tarrasch and Janowsky.
 1905. Scheveningen. 1 Marshall, 2 Leussen, 3 Spielmann.
 1906. Stockholm. 1 Schlechter and Bernstein, 3 Mieses.
 1906. Ostend. 1 Schlechter, 2 Maroczy, 3 Rubenstein.
 1906. Nuremberg. 1 Marshall, 2 Duras, 3 Schlechter and Fleischmann.
 1907. Vienna. 1 Mieses, 2 Duras, 3 Maroczy and Vidmarc.
 1907. Ostend. 1 Bernstein and Rubenstein, 3 Mieses.
 1907. Ostend. 1 Tarrasch, 2 Schlechter, 3 Janowsky and Marshall.
 1907. Carlsbad. 1 Rubenstein, 2 Maroczy, 3 Niemzowitch and Leonhardt.

In the absence of any recognized authority to confer the title

of chess champion of the world, it has usually been appropriated by the most successful competitor in tournaments. On this ground Tarrasch claimed the title in 1907, although Lasker, who had twice beaten Steinitz, the previous champion, in championship matches, in addition to such masters as Bird, Blackburne, Mieses and Marshall, was well qualified to assume it. Accordingly in arranging the programme for the tournament at Ostend in 1907 it was agreed that the winner of this contest should receive the title of tournament champion, and should play a match with Lasker for the championship of the world. Tarrasch having proved successful at Ostend, the match between him and Lasker was played at Munich in September 1908, and resulted in the victory of Lasker by 8 games to 3 and 5 draws.

Chess has developed various schools of play from time to time. The theory of the game, however, did not advance in proportion to the enormous strides in its popularity. Formerly the theory of play had been enriched by such enthusiasts as Dr Max Lange, Louis Paulsen, Professor Anderssen, Neumann, Dr Suhle, Falkbeer, Kieseritzki, Howard Staunton, Dr Zukertort, W. N. Potter and Steinitz, foremost amongst them being Louis Paulsen. The openings were thoroughly overhauled, new variations discovered and tested in practical play over the board. These are now things of the past. The masters who find flaws in old variations and discover new ones bring them to light only in matches or tournaments, as new discoveries have now a market value and may gain prizes in matches or tournaments. The old "romantic" school consequently became extinct, and the eliminating process resulted in the retention of a small repertoire only, sufficient for practical purposes in important contests. Gambits and kindred openings containing elements of chance were avoided, and the whole stock which a first-class player requires is a thorough knowledge of the "Ruy Lopez," the "Queen's Pawn Openings," and the "French" and "Sicilian Defences"—openings which contain the least element of chance. The repertoire being restricted it necessarily follows that the scope for grand combinations is also diminished and only strategy or position play remains. The "romantic" school invariably aimed at an attack on the king's position at any cost; nowadays the struggle is to obtain a minute advantage, and the whole plan consists in finding or creating a weak spot in the opponent's arrangement of forces; such is the theory of the modern school, conceived and advocated by Steinitz. But it is a curious fact that Steinitz founded the modern school rather late in life. He felt his powers of combination waning, and being the world's champion and eager to retain that title, he started the new theory. This novel departure revolutionized chess entirely. The attacking and combination style was sacrificed to a sound, sober and dry method; but Steinitz, strange to say, was not even the best exponent of his own theory, this position falling to younger players, Siegbert Tarrasch, Schlechter, Amos Burn and Emanuel Lasker. Pillsbury and Janowsky adhered to both styles, the former in a high degree, and so did Zukertort and Charousek; Tchigorin being a free-lance with a style of his own. The old charm of the game disappeared—in match and tournament play at least—and beauty was sacrificed to exact calculation and to scoring points. This is to be regretted, for the most beautiful games still occur when a player resorts to the gambits. One of the finest games in the Hastings tournament was played by Tchigorin against Pillsbury, and this was a "King's Gambit Declined." Charousek won a "Bishop's Gambit" against Dr Lasker in the Nuremberg tournament; and some brilliant games occur in the "Queen's Gambit Declined," if either White or Black sacrifices the KP. Another reason why gambits should be adopted by players in tournaments is that competitors would necessarily be readily prepared for the regulation openings, so that the gambits might take them by surprise. After all, the new school is a natural consequence of the progress of the game. Paulsen, Anderssen and Tchigorin devoted a lifetime to the Evans Gambit, volumes of analyses were written on it, and then Lasker revives an obsolete defence, and the Evans Gambit disappears! Zukertort achieved a great success with "1. Kt to KB3" in the London tournament, 1883,

and this, or the kindred "1. P to Q4" opening, has since become the trusty weapon in serious encounters. Lasker wrote *Common Sense in Chess*, and gave the best defences of the Ruy Lopez (a certain form of it); but the "common sense" was demolished in the Paris and Nuremberg tournaments, and old forms of that remarkable opening have to be refurbished. These instances will suffice to show the reason for the cautious style of modern times. The Moltkes have replaced the Napoleons.

The old versatility of style could be revived if club tournaments were organized differently. The players might be compelled to adopt one single opening only in a two-round contest, each player thus having attack and defence in turn. The next season another opening would form the programme, and so on. Even in international tournaments this condition might be imposed; the theory would be enriched; full scope would be given to power of combination and ingenuity; whilst the game would be more interesting.

There are still amateurs who devote their energies to the theory of the game; but so long as innovations or new discoveries are not tested by masters in serious games, they are of no value. Steinitz used to keep a number of new discoveries ready to be produced in masters' contests, the result being that his novelties were regularly demolished when it came to a practical test. The mistake was that he did not try his novelties over the board with an opponent of equal strength, instead of trusting to his own judgment alone.

The British Chess Federation was instituted in 1904, its first congress being held at Hastings in that year, when a British championship, a ladies' championship and a first-class amateur tournament were played. These competitions have been continued annually at the congresses of the federation, with the following results:—

British Championship.

- 1904. Hastings. 1 H. E. Atkins and W. E. Napier, 3 J. H. Blackburne.
- 1905. Southport. 1 H. E. Atkins, 2 G. E. H. Bellingham and J. H. Blackburne.
- 1906. Shrewsbury. 1 H. E. Atkins, 2 R. P. Michell, 3 G. E. Wainwright.
- 1907. Crystal Palace. 1 H. E. Atkins, 2 J. H. Blackburne, R. P. Michell, E. G. Sergeant and G. E. Wainwright.

Ladies' Championship.

- 1904. Hastings. 1 Miss Finn, 2 Mrs Anderson and Mrs Herring.
- 1905. Southport. 1 Miss Finn, 2 Mrs Anderson and Mrs Houlding.
- 1906. Shrewsbury. 1 Mrs Herring, 2 Mrs Anderson, 3 Miss Ellis and Mrs Houlding.
- 1907. Crystal Palace. 1 Mrs Herring and Mrs Houlding, 3 Mrs Anderson.

First Class Amateur Tournament.

- 1904. Hastings {
 - Section A. 1 W. H. Gunston, 2 H. F. Cheshire and F. Brown.
 - Section B. 1 G. E. Wainwright and C. H. Sherrard, 3 W. P. McBean.
- 1905. Southport {
 - Section A. 1 Dr Holmes, 2 J. Mortimer, 3 H. G. Cole and J. E. Purry.
 - Section B. 1 F. E. Hamond, 2 F. Brown, T. J. Kelly and C. H. Wallwork.
- 1906. Shrewsbury. 1 G. Shories, J. F. Alcock, P. W. Fairweather and E. D. Palmer.

In 1896 and following years matches between representative players of Great Britain and the United States respectively were played by cable, with the following results:—

1896. America	won by	4½	games to	3½
1897. Great Britain	"	5½	"	4½
1898. Great Britain	"	5½	"	4½
1899. America	"	6	"	4
1900. America	"	6	"	4
1901. Drawn				
1902. America	"	5½	"	4½
1903. America	"	5½	"	4½
1907. Great Britain	"	5½	"	4½
1908. America	"	6½	"	3½
1909. Great Britain	"	6	"	4

Since 1899 cable matches have also been played annually between representatives of English and American universities; of the first six three were won by England, the remaining three

being drawn. In England chess matches have been played annually since 1873 between the universities of Oxford and Cambridge, seven players on each side. Up to 1907 Oxford won eleven matches, Cambridge twenty-one, and three were drawn.

LITERATURE OF THE GAME.—The first known writer on chess was Jacobus de Cessolis (Jacopo Dacciesole), whose main object, however, though he gives the moves, &c., was to teach morals rather than chess. He was a Dominican friar, and his treatise, *Solutium Ludi Scacchorum, scilicet, Libellus de Moribus Hominum et Officiis Nobilium*, was written before the year 1200. It was afterwards translated into French, and in the year 1474 Caxton, under the title of *The Game and Playe of Chesse*, printed an English translation of the French version.

In 1490 we have the *Göttinger Handschrift*, a work containing nine different openings and fifty problems. The author of this manuscript is not known. Then comes Vicent, a Spanish writer, whose book bears date 1495. Only the title-page has been preserved, the rest of the work having been lost in the first Carlist war. Of Lucena, another Spanish author who wrote in or about 1497, we are better informed. His treatise, *Repeticion des Amores y Arte de Axedres*, comprises various practical chess matters, including 150 positions, illustrated by 160 well-executed woodcuts. Various of these positions are identical with those in the *Göttinger Handschrift*. In the 16th century works upon the game were written by Damiano, Ruy Lopez and Horatio Gianutio della Mantia; in the 17th century by Salvio, Polerio, Gustavus Selenus, Carrera, Greco, Fr. Antonio and the authors of the *Traité de Lausanne*; in the 18th century by Bertin, Sramma, Ercole del Rio, Lolli, Cozio, Philidor, Ponziani, Stein, van Nyevelt, Allgaier and Peter Pratt; in the 19th century by J. F. W. Koch and C. F. Koch, Sarratt, John Cochrane, Wm. Lewis, Silberschmidt, Ghulam Kassim and James Cochrane, George Walker, A. MacDonnell, Jaenisch, Petroff, von Bilguer, von der Lasa, Staunton, Kling and Horwitz, Bledow, Dubois, Kieseritzki, Max Lange, Löwenthal, Dufresne, Neumann, Suhle, Zukertort, Preti and others.

English chess owes much to W. Lewis and George Walker. But to Howard Staunton must be ascribed the most important share in creating the later popularity which the game achieved in England. Staunton's first work, *The Chess Player's Handbook*, was published in 1847, and again (revised) in 1848. For want of further adequate revision many of its variations are now out of date; but taking the handbook as it was when issued, very high praise must be bestowed upon the author. His other works are: *The Chess Player's Text-Book* and *The Chess Player's Companion* (1849) (the latter being a collection of his own games), the *Chess Praxis* (1860), republished in 1903, his posthumous work, *Chess Theory and Practice*, edited by R. B. Wormald (1876), and various smaller treatises. The laws of the game as laid down in the *Praxis* formed the basis of the rules adopted by the British Chess Association in 1862. Besides editing *The Chess Player's Chronicle* and *The Chess World*, he was the chess editor of *The Illustrated London News* from 1844 till his death in 1874.

Among continental chess authorities von Heydebrandt und der Lasa (more usually known by his second title) stood pre-eminent. The German *Handbuch* was completed in 1843 by von Bilguer, who died before the first edition was completed. The second, third, fourth and fifth editions (the last published in 1874) were edited and revised by von der Lasa.

Among the more important modern works the following may be mentioned: Vasquez, *El Ajedrez de memoria; la Odissea de Pablo Morphy* (Havana, 1893); Bauer, *Schachlexikon* (Leipzig, 1893); Jean Dufresne, *Kleines Lehrbuch des Schachspiels* (6th ed., Leipzig, 1893); E. Freeborough and Rev. C. E. Ranken, *Chess Openings, Ancient and Modern*; Arnelung, *Baltische Schachblätter, &c.* (Berlin, 1893); Bachman, *Geistreiche Schachpartien* (containing a number of brilliant games) (Ansbach, 1893-1899); E. H. Bird, *Chess History and Reminiscences* (London, 1893); *The Steinitz-Lasker Match* (1894); *Chess Novelties* (1895); Max Lange, *Paul Morphy* (1894); C. Bardeleben and J. Mieses, *Lehrbuch des Schachspiels* (very useful); Jas. Mason, *The Principles of Chess in Theory and Practice* (1894); *The Art of Chess* (1895); *Social Chess* (Horace Cox, London); Dr Tarrasch, *Dreihundert Schachpartien* (Leipzig, 1895); Dr Eugen V. Schmidt, *Systematische Anordnung von Schacheröffnungen* (Veit & Co., Leipzig, 1895); Numa Preti, *A B C des échecs* (Paris, 1895); C. Salvio, *Teoria generale del giuoco degli Scacchi* (Livorno, 1895); W. Steinitz, *Modern Chess Instructor* (New York, 1895); L. Hoffer, *Chess* (Routledge); E. Freeborough, *Select Chess End-Games* (London, 1895); Euclid, *The Chess Ending King and Queen against King and Rook* (London, 1895); Tassilo von Heydebrandt und der Lasa, *Leifaden des Schachspiels und Zur Geschichte und Literatur des Schachspiels* (Leipzig, 1897); Dr. Lasker, *Common Sense in Chess* (London, 1896); Oscar Cordel, *Neuester Leifaden des Schachspiels* (Berlin, 1896); and a vast number of other publications.

Further, *The London Tournament Book* (1883); *Twelve Tournament Books of the German Chess Association* (Veit & Co., Leipzig); *The Hastings Tournament Book* (London, 1896); *The Vienna*

Tournament Book, by Halprin and Marco (1900); *The Nuremberg Tournament Book*, by Dr Tarrasch; *The Book of the London Congress*, by L. Hoffer (Longman, 1899); *The Paris Tournament Book* (Paris, 1900), by Rosenthal, &c.

The following are some of the best works in English on chess problems:—"J. B." of Bridport, *Chess Strategy* (1865); F. Healey, *A Collection of 200 Chess Problems* (1866); *English Chess Problems*, edited by James and W. T. Pierce (1876); H. J. C. Andrews, E. N. Frankenstein, B. G. Laws, and C. Planck, *The Chess Problem Text-Book* (1887); A. F. Mackenzie, *Chess: its Poetry and its Prose* (Jamaica, 1887); J. A. Miles, *Chess Stars* (self-mates), (1888); James Rayner, *Chess Problems* (1890); B. G. Laws, *The Two-Move Chess Problem* (1890); *The Chess Bouquet*, compiled by F. R. Gittins (1897); Mr and Mrs T. B. Rowland, *The Problem Art* (2nd ed., 1898); E. B. Cook, T. Henry and C. A. Gilberg, *American Chess-Nuts* (1868), Samuel Loyd, *Chess Strategy* (1878); W. H. Lyons, *Chess-Nut Burrs and how to open them* (1886); C. A. Gilberg, *Crumbs from the Chess Board* (1890); *Canadian Chess Problems*, edited by C. F. Stubbs (1890); W. Pulitzer, *Chess Harmonies* (1894); G. E. Carpenter (N. Preti of Paris), *200 Chess Problems* (1900).

CHEST (Gr. κίστη, Lat. *cista*, O. Eng. *cist*, *cest*, &c.), a large box of wood or metal with a hinged lid. The term is also used of a variety of kinds of receptacle; and in anatomy is transferred to the portion of the body covered by the ribs and breastbone (see RESPIRATORY SYSTEM). In the more ordinary meaning chests are, next to the chair and the bed, the most ancient articles of domestic furniture. The chest was the common receptacle for clothes and valuables, and was the direct ancestor of the "chest of drawers," which was formed by enlarging the chest and cutting up the front. It was also frequently used as a seat. Indeed, in its origin it took in great measure the place of the chair, which, although familiar enough to the ancients, had become a luxury in the days when the chest was already an almost universal possession. The chief use of chests was as wardrobes, but they were also often employed for the storing of valuables. In the early middle ages the rich possessed them in profusion, used them as portmanteaux, and carried them about from castle to castle. These portable receptacles were often covered with leather and emblazoned with heraldic designs. As houses gradually became less sparsely furnished, chests and beds and other movables were allowed to remain stationary, and the chest lost its covered top, and took the shape in which we best know it—that of an oblong box standing upon raised feet. As a rule it was made of oak, but it was sometimes of chestnut or other hard wood.

There are, properly speaking, three types of chest—the domestic, the ecclesiastical and the strong box or coffer. Old domestic chests still exist in great number and some variety, but the proportion of those earlier than the latter part of the Tudor period is very small; most of them are Jacobean in date. Very frequently they were made to contain the store of house-linen which a bride took to her husband upon her marriage. In the 17th century Boule and his imitators glorified the marriage-coffer until it became a gorgeous casket, almost indeed a sarcophagus, inlaid with ivory and ebony and precious woods, and enriched with ormolu, supported upon a stand of equal magnificence. The Italian marriage-chests (*cassone*) were also of a richness which was never attempted in England. The main characteristics of English domestic chests (which not infrequently are carved with names and dates) are panelled fronts and ends, the feet being formed from prolongations of the "stiles" or side posts. There were, however, exceptions, and a certain number of 17th-century chests have separate feet, either circular or shaped after the indications of a somewhat later style. There is usually a strong architectural feeling about the chest, the front being divided into panels, which are plain in the more ordinary examples, and richly carved in the choicer ones. The plinth and frieze are often of well-defined *guilloche* work, or are carved with arabesques or conventionalized flowers. Architectural detail, especially the detail of wainscoting, has indeed been followed with considerable fidelity, many of the earlier chests being carved in the linenfold pattern, while the Jacobean examples are often mere reproductions of the pilastered and recessed oaken mantelpieces of the period. Occasionally a chest is seen which is inlaid with coloured woods, or with

geometrical parquetry. Perhaps the most elaborate type of English parquetry chest is that named after the vanished Palace of Nonesuch. Such pieces are, however, rarely met with. The entire front of this type is covered with a representation of the palace in coloured woods. Another class of chest is incised, sometimes rather roughly, but often with considerable geometrical skill. The more ordinary variety has been of great value to the forger of antique furniture, who has used its carved panels for conversion into cupboards and other pieces, the history of which is not easily unravelled by the amateur who collects old oak without knowing much about it. Towards the end of the 17th century chests were often made of walnut, or even of exotic woods such as cedar and cypress, and were sometimes clamped with large and ornamental brass bands and hinges. The chests of the 18th century were much larger than those of the preceding period, and as often as not were furnished with two drawers at the bottom—an arrangement but rarely seen in those of the 17th century—while they were often fitted with a small internal box fixed across one end for ready access to small articles. The chest was not infrequently unpanelled and unornamented, and in the latter period of its history this became the ruling type. It will not have been forgotten that it was in an old oak chest that the real or mythical heroine of the pathetic ballad of "The Mistletoe Bough" concealed herself, to her undoing.

Ecclesiastical chests appear to have been used almost entirely as receptacles for vestments and church plate, and those which survive are still often employed for the preservation of parish documents. A considerable variety of these interesting and often exceedingly elaborate chests are still left in English churches. They are usually of considerable size, and of a length disproportionate to their depth. This no doubt was to facilitate the storage of vestments. Most of them are of great antiquity. Many go back to the 14th century, and here and there they are even earlier, as in the case of the coffer in Stoke d'Abernon church, Surrey, which is unquestionably 13th-century work. One of the most remarkable of these early examples is in Newport church, Essex. It is one of the extremely rare painted coffers of the 13th century, the front carved with an upper row of shields, from which the heraldic painting has disappeared, and a lower row of roundels. Between is a belt of open tracery, probably of pewter, and the inside of the lid is decorated with oil paintings representing the Crucifixion, the Virgin Mary, St Peter, St John and St Paul. The well-known "jewel chest" in St Mary's, Oxford, is one of the earliest examples of 14th century work. Many of these ecclesiastical chests are carved with architectural motives—tracery windows most frequently, but occasionally with the linenfold pattern. There is a whole class of chests known as "tilting coffers," carved with representations of tournaments or feats of arms, and sometimes with a grotesque admixture of chivalric figures and mythical monsters. Only five or six examples of this type are known still to exist in England, and two of them are now in the Victoria and Albert Museum. It is not certain that even these few are of English origin—indeed, very many of the chests and coffers of the 16th and 17th centuries are of foreign make. They were imported into England chiefly from Flanders, and were subsequently carved by native artisans, as was the case with other common pieces of furniture of those periods. The *huche* or "hutch" was a rough type of household chest.

The word "coffer" is properly applied to a chest which was intended for the safe keeping of valuables. As a rule the coffer is much more massive in construction than the domestic chest; it is clamped by iron bands, sometimes contains secret receptacles opening with a concealed spring, and is often furnished with an elaborate and complex lock, which occupies the whole of the underside of the lid. Pieces of this type are sometimes described as Spanish chests, from the belief that they were taken from ships belonging to the Armada. It is impossible to say that this may not sometimes have been the case, but these strong boxes are frequently of English origin, although the mechanism of the locks may have been due to the subtle skill of foreign locksmiths. A typical example of the treasure chest is that which belonged

to Sir Thomas Bodley, and is preserved in the Bodleian library at Oxford. The locks of this description of chest are of steel, and are sometimes richly damascened. It was for being implicated in the breaking open and robbing of just such a chest as this, to which the Collège de Navarre had confided coin to the value of 500 écus, that François Villon was hanged on the gibbet of Montfaucon.

CHESTER, EARLS OF. The important palatine earldom of Chester was first held by a certain Fleming named Gherbod (fl. 1070), and then by Hugh of Avranches (d. 1101), a son of Richard, viscount of Avranches. Hugh, who was probably one of William the Conqueror's companions, was made earl of Chester in 1071; he had special privileges in his earldom, and he held land in twenty counties. He was called *Le Gros* on account of his great bulk and *Lupus* on account of his ferocity. However, he regarded St Anselm as his friend, and he showed the customary liberality to religious houses. His life was mainly spent in fighting the Welsh and in Normandy, and he died on the 27th of July 1101. Hugh's only son Richard, who was childless, was drowned in the White Ship in November 1120. Among subsequent holders were Ralph, or Randolph, de Gernon (d. 1153), who took a prominent part in the civil wars of the reign of Stephen, fighting first on one side and then on the other; and his son Hugh de Kevelioc (1147–1181), who shared in the rising against Henry II. in 1173. But perhaps the most celebrated of the early earls was Ralph, Ranulf, or Randolph, de Blundevill (c. 1172–1232), who succeeded his father Hugh de Kevelioc as earl in 1181, and was created earl of Lincoln in 1217. Ranulf married Constance, widow of Henry II.'s son, Geoffrey of Brittany, and is sometimes called duke of Brittany and earl of Richmond. He fought in Wales, was on the side of John during his struggle with the barons over Magna Carta, and was one of this king's executors; he also fought for the young king Henry III. against the French invaders and their allies. In 1218 he went on crusade to the Holy Land and took part in the capture of Damiatta; then returning to England he died at Wallingford in October 1232. After speaking of Ranulf's unique position in the kingdom, which "fitted him for the part of a leader of opposition to royal or ministerial tyranny," Stubbs sums up his character in these words: "On more than one occasion he refused his consent to taxation which he deemed unjust; his jealousy of Hubert (de Burgh), although it led him to join the foreign party in 1223, did not prevent him from more than once interposing to prevent his overthrow. He was, moreover, almost the last relic of the great feudal aristocracy of the Conquest." Although twice married he left no children, and his immense possessions passed to his four sisters. The earl's memory remained green for a long time, and in the *Vision of Piers Plowman* his name is linked with that of Robin Hood. In November 1232 the earldom of Chester was granted to his nephew John the Scot, earl of Huntingdon (c. 1207–1237), and in 1246, nine years after John had died childless, it was annexed to the English crown "lest so fair a dominion should be divided among women."

In 1254 Prince Edward, afterwards King Edward I., was created earl of Chester, and since this date the earldom has always been held by the heirs apparent to the English crown with the single exception of Simon de Montfort, earl of Leicester. Since 1399 the earls of Chester have been also princes of Wales, although the act of Richard II. (1398), which created Chester into a principality to be held by the king's eldest son, was revoked by Henry IV.

CHESTER, an episcopal city and county of a city, municipal, county and parliamentary borough, and the county town of Cheshire, England, 179 m. N.W. of London. Pop. (1901) 38,309. It lies in a low plain on the Dee, principally on the north (right) bank, 6 m. above the embouchure of the river into its wide, shallow estuary. It is an important railway centre, the principal lines serving it being the London & North-Western, Great Western, Cheshire Lines and Great Central. The city is divided into four principal blocks by the four principal streets—Northgate Street, Eastgate Street, Bridge Street and Watergate Street, which radiate at right angles from the Cross, and terminate in

the four gates. These four streets exhibit in what are called "the Rows" a characteristic feature of the city. Their origin is a mystery, and has given rise to much controversy. In Eastgate Street, Bridge Street and Watergate Street, the Rows exist on each side of the street throughout the greater part of its length, and may be described as continuous galleries open to the street, over and under which the houses lining the streets project, and which are formed as it were out of the front first-floor of the houses, approached by flights of steps from the roadway. The Rows are flagged or boarded under foot and ceiled above, thus forming a covered way, standing in the same relation to the shops, which are at their back, as the foot pavement does in other towns. In Northgate Street, on the other hand, the Row on the west side is formed as it were out of the ground floor of the houses, having cellars beneath, while on the east side the Row is formed at the same elevation as in the other three principal streets. In these streets are several examples of old timbered houses and some good modern imitations of them,—all combining to give a picturesque and individual character to the city. Among the most interesting of the ancient houses are Derby House, bearing the date 1501, Bishop Lloyd's house, and God's Providence House in Watergate Street, and the Bear and Billet in Lower Bridge Street; the three last date from the 17th century. There is also a chamber with stone groined roof of the 14th century in the basement of a house in Eastgate Street, and another of a similar character in Watergate Street. A mortuary chapel of the early part of the 13th century exists in the basement of a house in Bridge Street.

Chester is the only city in England that still possesses its walls perfect in their entire circuit of 2 m. The gateways have all been rebuilt at various dates; the north and east gates on the site of the Roman gates. The Grosvenor bridge, a single span of stone 200 ft. in length, said to be the largest save one in Europe, carries the road to Wrexham and Shrewsbury over the Dee on the south-west; while the old bridge of seven arches is interesting on account of its antiquity and picturesqueness. The castle, with the exception of "Caesar's Tower," and a round tower with adjacent buildings, in the upper ward, was taken down towards the end of the 18th century, and replaced by a gateway, barracks, county hall, gaol and assize courts.

The cathedral church of Christ and the Virgin Mary, which stands towards the north of the city within the walls, rose on the site of a church of extreme antiquity. It appears that the dedication of this church was altered, perhaps in the reign of Athelstan, from St. Peter and St. Paul to St. Werburgh and St. Oswald, St. Werburgh being a niece of St. Etheldreda of Ely. In 1093 Hugh Lupus, earl of Chester, richly endowed the foundation as a Benedictine monastery. The bishops of Mercia had apparently a seat at Chester, but the city had ceased to be episcopal, until in 1075 Peter, bishop of Lichfield, removed his seat thence to Chester, having for his cathedral the collegiate church of St. John. The seat of the see, however, was quickly removed again to Coventry (1102), but Cheshire continued subject to Lichfield until in 1541 Chester was erected into a bishopric by Henry VIII., the church of the dissolved abbey of St. Werburgh becoming the cathedral. The diocese covers nearly the whole of Cheshire, with very small portions of Lancashire and Staffordshire. The cathedral does not rank among the most splendid English churches, but possesses certain details of the highest interest, and gains in beauty from the tones of its red sandstone walls and the picturesque close in which it stands. It is cruciform with a central tower 127 ft. high. The south transept is larger than the north. The nave is short (145 ft.), being of six bays; the southern arcade is Decorated, while the northern, which differs in detail, is of uncertain date. The basement of the north-western tower—all that remains of it, now used as a baptistery—is Norman, and formed part of Hugh Lupus' church; and the fabric of the north wall is also of this period. The north transept also retains Norman work, and its size shows the original plan, as the existence of the conventual buildings to the north probably rendered its extension undesirable. The south transept has aisles, with Decorated and Perpendicular windows. The fine

organ stands on a screen across the north transept; but some of its pipes are upon the choir screen, both screens being the work of Sir Gilbert Scott. The style of the choir is transitional from Early English to Decorated, and its length is 125 ft. It is a fine example, and its beauty is enhanced by the magnificent series of ancient carved wooden stalls unsurpassed in England. The Lady Chapel, east of the choir, is of rich Early English workmanship. Of the conventual buildings the cloisters are Perpendicular. The chapter-house, entered by a beautiful vestibule from the east cloister, and lined with cases containing the chapter library, is Early English (c. 1240). The refectory, adjoining the north cloister, is of the same period, with Perpendicular insertions; it has been curtailed in size, but retains its beautiful Early English lector's pulpit. An early Norman chamber, with massive pillars and vaulting, adjoins the west cloister, and may be the substructure of the abbot's house. The abbey gateway is of the 14th century.

Within the walls there are several churches of ancient foundation; thus St. Peter's is said to occupy the site of a church erected by Æthelflæd, queen of Mercia, and St. Mary's dates from the 12th century. None, however, is of any special interest; but the church of St. John, outside the walls, which as already stated became the cathedral in 1075, is a massive early Norman structure, with later additions, and, especially as regards the exterior, considerably restored in modern times. Its fine tower fell in 1881. It was a collegiate church until 1547, and there are some remains of the adjoining buildings. Among numerous modern churches there may be mentioned St. Mary's without the walls, built in 1887 by the duke of Westminster, of red sandstone, with a fine spire and peal of bells.

Among the chief secular buildings, the town hall replaced in 1869 the old exchange, which had been burnt down in 1862. The Grosvenor Museum and School of Art, the foundation of which was suggested by Charles Kingsley the novelist, when canon of Chester cathedral, contains many local antiquities, along with a fine collection of the fauna of Cheshire and the neighbourhood. The King's school was founded by Henry VIII. (1541), who provided that twenty-four poor scholars should be taught free of cost. It was reorganized as a public school in 1873, and possesses twelve king's scholarships tenable in the school, and close scholarships tenable at the universities. Among other schools may be mentioned the blue-coat school (1700), the Queen's school for girls (1878), the girls' school attached to the Roman Catholic convent, and the diocesan training college for schoolmasters. For recreation provision is made by the New Grosvenor Park, presented to the city in 1867 by the marquis of Westminster; Handbridge Park, opened in 1892; and the Roodee, a level tract by the river at the base of the city wall, appropriated as a race-course. An annual race-meeting is held in May and attended by thousands. The chief event is the race for the Chester Cup, which dates from 1540, when a silver bell was given as the prize by the Saddlers' Company. Pleasure vessels ply on the Dee in summer, and an annual regatta is held, at which all the principal northern rowing-clubs are generally represented. The town gains in prosperity from its large number of visitors. The principal industries are carried on without the walls, where there are lead, shot and paint works, leather and tobacco factories, and iron foundries. The trade guilds number twenty-four. There is a considerable amount of shipping on the Dee, the navigation having been much improved in modern times. The parliamentary borough returns one member. The municipal council consists of a mayor, 10 aldermen and 30 councillors. Area, 2862 acres.

History.—Setting aside the numerous legends with regard to the existence of a British city on the site now occupied by Chester, the earliest authentic information relating to its history is furnished by the works of Ptolemy and Antoninus. As the Roman station of Deva it was probably founded about A.D. 48 by Ostorius Scapula, and from its advantageous position, both as the key to communication with Ireland and as a bulwark against the hostile tribes of the north, it became a military and commercial centre of considerable importance. In A.D. 78-79

it was the winter-quarters of Agricola, and later became illustrious as the permanent headquarters of Legio XX. Valeria Victrix. Many inscriptions and remains of the Roman military occupation have been found, and the north and east walls stand in great part on Roman foundations. The Saxon form of the name was Leganceaster. About 614 the city was captured and destroyed by Æthelfrith, and henceforth lay in ruins until Æthelwulf in 907 rebuilt the walls, restored the monastery of St Werburgh, and made the city "nigh two such as it was before." In the reign of Æthelstan a mint was set up at Chester, and in 973 it was the scene of Edgar's triumph when, it is said, he was rowed on the Dee by six subject kings. Chester opposed a determined resistance to the Conqueror, and did not finally surrender until 1070. On the erection of Cheshire to a county palatine after the Conquest, Chester became the seat of government of the palatine earls. The Domesday account of the city includes a description of the Saxon laws under which it had been governed in the time of Edward the Confessor. All the land, except the bishop's borough, was held of the earl, and assessed at fifty hides. There were seven mint-masters and twelve magistrates, and the city paid a fee-farm rent of £45. It had been much devastated since the time of Edward the Confessor, and the number of houses reduced by 205.

The earliest extant charter, granted by Henry II. in 1160, empowered the burgesses to trade with Durham as freely as they had done in the reign of Henry I. From this date a large collection of charters enumerates privileges granted by successive earls and later sovereigns. One from Ralph or Ranulf de Blundevill, granted between 1190 and 1211, confirms to the citizens a gild merchant and all liberties and free customs, and three from John protect their privilege of trading with Ireland. Edward I. empowered the citizens to elect coroners and to hold courts of justice, and granted them the fee-farm of the city at a yearly rent of £100. In the 14th century Chester began to lose its standing as a port through the gradual silting up of the estuary of the Dee, and the city was further impoverished by the inroads of the Welsh and by the necessity of rebuilding the Dee bridge, which had been swept away by an unusually high tide. In consideration of these misfortunes Richard II. remitted part of the fee-farm. Continued misfortunes led to a further reduction of the farm to £50 for a term of fifty years by Henry VI., who also made a grant for the completion of a new Dee bridge. Henry VII. reduced the fee-farm to £20, and in 1506 granted to the citizens what is known as "the Great Charter." This charter constituted the city a county by itself, and incorporated the governing body under the style of a mayor, twenty-four aldermen and forty common councilmen; it also instituted two sheriffs, two coroners and a recorder, and the mayor, the ex-mayors and the recorder were appointed justices of the peace. This charter was confirmed by James I. and Charles II. A charter of George III. in 1804 instituted the office of deputy-mayor. The charter of Hugh Lupus to the abbey of St Werburgh includes a grant of the tolls of the fair at the feast of St Werburgh for three days, and a subsequent charter from Ranulf de Blundevill (12th century) licensed the abbot and monks to hold their fairs and markets before the abbey gates. A charter of John the Scot, earl of Chester, mentions fairs at the feasts of the Nativity of St John Baptist and St Michael. For many centuries the rights claimed by the abbot in connexion with the fairs gave rise to constant friction with the civic authorities, which lasted until, in the reign of Henry VIII., it was decreed that the right of holding fairs was vested exclusively in the citizens. Charles II. in 1685 granted a cattle-fair to be held on the first Thursday in February.

In 1553 Chester first returned two members to parliament, having hitherto been represented solely in the parliament of the palatinate. By the Redistribution Act of 1885 the representation was reduced to one member. The trades of tanners, skinnners and glove-makers existed at the time of the Conquest, and the importation of marten skins is mentioned in Domesday. In the 14th century the woollen trade was considerable, and in 1674 weavers and wool-combers were introduced into Chester from

Norwich. The restoration of the channel of the Dee opened up a flourishing trade in Irish linen, which in 1786 was at its height, but from that date gradually diminished.

See *Victoria County History, Cheshire*; R. H. Morris, *Chester in the Plantagenet and Tudor Reigns* (Chester, 1894); Joseph Hemingway, *History of the City of Chester* (2 vols., Chester, 1831).

CHESTER, a city of Delaware county, Pennsylvania, U.S.A., on the Delaware river, about 13 m. S.W. of Philadelphia. Pop. (1890) 20,226; (1900) 33,988, of whom 5074 were foreign-born and 4403 were negroes; (U. S. census, 1910) 38,537. It is served by the Baltimore & Ohio and the Philadelphia & Reading railways, by the Philadelphia, Baltimore & Washington division of the Pennsylvania system, and by steamboat lines. Chester has several interesting buildings dating from early in the 18th century—among them the city hall (1724), one of the oldest public buildings in the United States, and the house (1683) occupied for a time by William Penn. It is the seat of the Pennsylvania Military College (1862); and on the border of Chester, in the borough of Upland (pop. in 1900, 2131), is the Crozer Theological Seminary (Baptist), which was incorporated in 1867, opened in 1868, and named after John P. Crozer (1793-1866), by whose family it was founded. Chester has a large shipbuilding industry, and manufactories of cotton and worsted goods, iron and steel, the steel-casting industry being especially important, and large quantities of wrought iron and steel pipes being manufactured. Dye-stuffs and leather also are manufactured. The value of the city's factory products in 1905 was \$16,644,842. Chester is the oldest town in Pennsylvania. It was settled by the Swedes about 1645, was called Upland and was the seat of the Swedish courts until 1682, when William Penn, soon after his landing at a spot in the town now marked by a memorial stone, gave it its present name. The first provincial assembly was convened here in December of the same year. After the battle of Brandywine in the War of Independence, Washington retreated to Chester, and in the "Washington House," still standing, wrote his account of the battle. Soon afterwards Chester was occupied by the British. In 1701 it was incorporated as a borough; in 1795 and again in 1850 it received a new borough charter; and in 1866 it was chartered as a city. For a long time it was chiefly a small fishing settlement, its population as late as 1820 being only 657; but after the introduction of large manufacturing interests in 1850, when its population was only 1667, its growth was rapid.

See H. G. Ashmead, *Historical Sketch of Chester* (Chester, 1883).

CHESTERFIELD, PHILIP DORMER STANHOPE, 4TH EARL OF (1694-1773), son of Philip Stanhope, third earl (1673-1726), and Elizabeth Savile, daughter of George Savile, marquess of Halifax, was born in London on the 22nd of September 1694; Philip, the first earl (1584-1656), son of Sir John Stanhope of Shelford, was a royalist who in 1616 was created Baron Stanhope of Shelford, and in 1628 earl of Chesterfield; and his grandson the 2nd earl (1633-1714) was grandfather of the 4th earl. Deprived at an early age of his mother, the care of the boy devolved upon his grandmother, the marchioness of Halifax, a lady of culture and connexion, whose house was frequented by the most distinguished Whigs of the epoch. He soon began to prove himself possessed of that systematic spirit of conduct and effort which appeared so much in his life and character. His education, begun under a private tutor, was continued (1712) at Trinity Hall, Cambridge; here he remained little more than a year and seems to have read hard, and to have acquired a considerable knowledge of ancient and modern languages. The great orators of all times were a special object of study with him, and he describes his boyish pedantry pleasantly enough, but by no means without a touch of self-satisfaction in the memory. His university training was supplemented (1714) by a continental tour, untrammelled by a governor; at the Hague his ambition for the applause awarded to adventure made a gamester of him, and at Paris he began, from the same motive, that worship of the conventional Venus, the serious inculcation of which has earned for him the largest and most unenviable part of his reputation.

The death of Anne and the accession of George I. opened up a career for him and brought him back to England. His relative James Stanhope (afterwards first Earl Stanhope), the king's favourite minister, procured for him the place of gentleman of the bedchamber to the prince of Wales. In 1715 he entered the House of Commons as Lord Stanhope of Shelford and member for St Germans, and when the impeachment of James, duke of Ormonde, came before the House, he used the occasion (5th of August 1715) to put to proof his old rhetorical studies. His maiden speech was youthfully fluent and dogmatic; but on its conclusion the orator was reminded with many compliments, by an honourable member, that he wanted six weeks of his majority, and consequently that he was amenable to a fine of £500 for speaking in the House. Lord Stanhope quitted the Commons with a low bow and started for the continent. From Paris he rendered the government important service by gathering and transmitting information respecting the Jacobite plot; and in 1716 he returned to England, resumed his seat, and took frequent part in the debates. In that year came the quarrel between the king and the heir apparent. Stanhope, whose politic instinct obliged him to worship the rising rather than the setting sun, remained faithful to the prince, though he was too cautious to break entirely with the king's party. He was on friendly terms with the prince's mistress, Henrietta Howard, afterwards countess of Suffolk. He maintained a correspondence with this lady which won for him the hatred of the princess of Wales (afterwards Queen Caroline). In 1723 a vote for the government got him the place of captain of the Gentlemen Pensioners. In January 1725, on the revival of the Bath, the red riband was offered to him, but was declined.

In 1726 his father died, and Lord Stanhope became earl of Chesterfield. He took his seat in the Upper House, and his oratory, never effective in the Commons by reason of its want of force and excess of finish, at once became a power. In 1728 Chesterfield was sent to the Hague as ambassador. In this place his tact and temper, his dexterity and discrimination, enabled him to do good service, and he was rewarded with Walpole's friendship, a Garter and the place of lord high steward. In 1732 there was born to him, by a certain Mlle du Bouchet, the son, Philip Stanhope, for whose advice and instruction were afterwards written the famous *Letters*. He negotiated the second treaty of Vienna in 1731, and in the next year, being somewhat broken in health and fortune, he resigned his embassy and returned to England.

A few months' rest enabled him to resume his seat in the Lords, of which he was one of the acknowledged leaders. He supported the ministry, but his allegiance was not the blind fealty Walpole exacted of his followers. The Excise Bill, the great premier's favourite measure, was vehemently opposed by him in the Lords, and by his three brothers in the Commons. Walpole bent before the storm and abandoned the measure; but Chesterfield was summarily dismissed from his stewardship. For the next two years he led the opposition in the Upper House, leaving no stone unturned to effect Walpole's downfall. In 1741 he signed the protest for Walpole's dismissal and went abroad on account of his health. He visited Voltaire at Brussels and spent some time in Paris, where he associated with the younger Crebillon, Fontenelle and Montesquieu. In 1742 Walpole fell, and Carteret was his real, though not his nominal successor. Although Walpole's administration had been overthrown largely by Chesterfield's efforts the new ministry did not count Chesterfield either in its ranks or among its supporters. He remained in opposition, distinguishing himself by the courtly bitterness of his attacks on George II., who learned to hate him violently. In 1743 a new journal, *Old England; or, the Constitutional Journal* appeared. For this paper Chesterfield wrote under the name of "Jeffrey Broadbottom." A number of pamphlets, in some of which Chesterfield had the help of Edmund Waller, followed. His energetic campaign against George II. and his government won the gratitude of the dowager duchess of Marlborough, who left him £20,000 as a mark of her appreciation. In 1744 the king was compelled to abandon Carteret, and the coalition or "Broad

Bottom" party, led by Chesterfield and Pitt, came into office. In the troublous state of European politics the earl's conduct and experience were more useful abroad than at home, and he was sent to the Hague as ambassador a second time. The object of his mission was to persuade the Dutch to join in the War of the Austrian Succession and to arrange the details of their assistance. The success of his mission was complete; and on his return a few weeks afterwards he received the lord-lieutenancy of Ireland—a place he had long coveted.

Short as it was, Chesterfield's Irish administration was of great service to his country, and is unquestionably that part of his political life which does him most honour. To have conceived and carried out a policy which, with certain reservations, Burke himself might have originated and owned, is indeed no small title to regard. The earl showed himself finely capable in practice as in theory, vigorous and tolerant, a man to be feared and a leader to be followed; he took the government entirely into his own hands, repressed the jobbery traditional to the office, established schools and manufactures, and at once conciliated and kept in check the Orange and Roman Catholic factions. In 1746, however, he had to exchange the lord-lieutenancy for the place of secretary of state. With a curious respect for those theories his familiarity with the secret social history of France had caused him to entertain, he hoped and attempted to retain a hold over the king through the influence of Lady Yarmouth, though the futility of such means had already been demonstrated to him by his relations with Queen Caroline's "*ma bonne Howard*." The influence of Newcastle and Sandwich, however, was too strong for him; he was thwarted and over-reached; and in 1748 he resigned the seals, and returned to cards and his books with the admirable composure which was one of his most striking characteristics. He declined any knowledge of the *Apology for a late Resignation, in a Letter from an English Gentleman to his Friend at The Hague*, which ran through four editions in 1748, but there is little doubt that he was, at least in part, the author.

The dukedom offered him by George II., whose ill-will his fine tact had overcome, was refused. He continued for some years to attend the Upper House, and to take part in its proceedings. In 1751, seconded by Lord Macclesfield, president of the Royal Society, and Bradley, the eminent mathematician, he distinguished himself greatly in the debates on the calendar, and succeeded in making the new style a fact. Deafness, however, was gradually affecting him, and he withdrew little by little from society and the practice of politics. In 1755 occurred the famous dispute with Johnson over the dedication to the *English Dictionary*. In 1747 Johnson sent Chesterfield, who was then secretary of state, a prospectus of his *Dictionary*, which was acknowledged by a subscription of £10. Chesterfield apparently took no further interest in the enterprise, and the book was about to appear, when he wrote two papers in the *World* in praise of it. It was said that Johnson was kept waiting in the anteroom when he called while Cibber was admitted. In any case the doctor had expected more help from a professed patron of literature, and wrote the earl the famous letter in defence of men of letters. Chesterfield's "respectable Hottentot," now identified with George, Lord Lyttelton, was long supposed, though on slender grounds, to be a portrait of Johnson. During the twenty years of life that followed this episode, Chesterfield wrote and read a great deal, but went little into society.

In 1768 died Philip Stanhope, the child of so many hopes. The constant care bestowed by his father on his education resulted in an honourable but not particularly distinguished career for young Stanhope. His death was an overwhelming grief to Chesterfield, and the discovery that he had long been married to a lady of humble origin must have been galling in the extreme to his father after his careful instruction in worldly wisdom. Chesterfield, who had no children by his wife, Melusina von Schulemberg, illegitimate daughter of George I., whom he married in 1733, adopted his godson, a distant cousin, named Philip Stanhope (1755-1815), as heir to the title and estates. His famous jest (which even Johnson allowed to have merit)—

"Tyrawley and I have been dead these two years, but we don't choose to have it known"—is the best description possible of his humour and condition during the latter part of this period of decline. To the deafness was added blindness, but his memory and his fine manners only left him with life; his last words ("Give Dayrolles a chair") prove that he had neither forgotten his friend nor the way to receive him. He died on the 24th of March 1773.

Chesterfield was selfish, calculating and contemptuous; he was not naturally generous, and he practised dissimulation till it became part of his nature. In spite of his brilliant talents and of the admirable training he received, his life, on the whole, cannot be pronounced a success. His anxiety and the pains he took to become an orator have been already noticed, and Horace Walpole, who had heard all the great orators, preferred a speech of Chesterfield's to any other; yet the earl's eloquence is not to be compared with that of Pitt. Samuel Johnson, who was not perhaps the best judge in the world, pronounced his manners to have been "exquisitely elegant"; yet as a courtier he was utterly worsted by Robert Walpole, whose manners were anything but refined, and even by Newcastle. He desired to be known as a protector of letters and literary men; and his want of heart or head over the *Dictionary* dedication, though explained and excused by Croker, none the less inspired the famous change in a famous line—"Toil, envy, want, the patron, and the jail." His published writings have had with posterity a very indifferent success; his literary reputation rests on a volume of letters never designed to appear in print. The son for whom he worked so hard and thought so deeply failed especially where his father had most desired he should succeed.

As a politician and statesman, Chesterfield's fame rests on his short but brilliant administration of Ireland. As an author he was a clever essayist and epigrammatist. But he stands or falls by the *Letters to his Son*, first published by Stanhope's widow in 1774, and the *Letters to his Godson* (1890). The *Letters* are brilliantly written—full of elegant wisdom, of keen wit, of admirable portrait-painting, of exquisite observation and deduction. Against the charge of an undue insistence on the external graces of manner Chesterfield has been adequately defended by Lord Stanhope (*History*, iii. 34). Against the often iterated accusation of immorality, it should be remembered that the *Letters* reflected the morality of the age, and that their author only systematized and reduced to writing the principles of conduct by which, deliberately or unconsciously, the best and the worst of his contemporaries were governed.

The earldom of Chesterfield passed at his death to his godson, already mentioned, as 5th earl, and so to the latter's son and grandson. On the death of the latter unmarried in 1871, it passed in succession to two collateral heirs, the 8th and 9th earls, and so in 1887 to the latter's son as 10th earl.

See Chesterfield's *Miscellaneous Works* (London, 1777, 2 vols. 4to); *Letters to his Son, &c.*, edited by Lord Mahon (London, 1845-1853, 5 vols.); and *Letters to his Godson* (1890) (edited by the earl of Carnarvon). There are also editions of the first series of letters by J. Bradshaw (3 vols., 1892) and Mr C. Strachey (2 vols., 1901). In 1893 a biography, including numerous letters first published from the Newcastle Papers, was issued by Mr W. Ernst; and in 1907 appeared an elaborate *Life* by W. H. Craig. (A. D.)

CHESTERFIELD, a market town and municipal borough in the Chesterfield parliamentary division of Derbyshire, England, 24 m. N. by E. of Derby, on the Midland and the Great Central railways. Pop. (1891) 22,009; (1901) 27,185. It lies at the junction of two streams, the Rother and Hipper, in a populous industrial district. It is irregularly built, with narrow streets, but has a spacious market-place. The church of St Mary and All Saints is a large and beautiful cruciform building principally of the Decorated period. Its central tower carries a remarkable twisted spire of wood covered with lead, 230 ft. high; the distortion has evidently taken place through the use of unseasoned timber and consequent warping of the woodwork. The church, which contains numerous interesting monuments, possesses also the unusual feature of an apsidal Decorated chapel. There is an example of flamboyant tracery in one of the windows. Among

public buildings, the Stephenson memorial hall (1879), containing a free library, art and science class-rooms, a theatre and the rooms of the Chesterfield Institute, commemorates George Stephenson, the engineer, who resided at Tapton House, close to Chesterfield, in his later life; he died here in 1848, and was buried in Trinity church. Chesterfield grammar school was founded in 1574. The industries of the town include manufactures of cotton, silk, earthenware, machinery and tobacco, with brass and iron founding; while slate and stone are quarried, and there are coal, iron and lead mines in the neighbourhood. The town is governed by a mayor, 6 aldermen and 18 councillors. Area, 1216 acres. In the immediate neighbourhood of Chesterfield on the west is the urban district of Brampton and Walton (pop. 2698), to the south-east is Hasland (7427), and to the north-east Brimington (4569).

In spite of the Roman origin suggested by its name, so few remains have been found here that it is doubtful whether Chesterfield was a Roman station. Chesterfield (*Cestrefeld*) owes its present name to the Saxons. It is mentioned in Domesday only as a bailiwick of Newbold belonging to the king, and granted to William Peverell. In 1204 John gave the manor to William Bruere and granted to the town all the privileges of a free borough which were enjoyed by Nottingham and Derby; but before this it seems to have had prescriptive borough rights. Later charters were granted by various sovereigns, and it was incorporated by Elizabeth in 1598 under the style of a mayor, 6 brethren and 12 capital burgesses. This charter was confirmed by Charles II. (1662), and the town was so governed till the Municipal Act 1835 appointed a mayor, 3 aldermen and 12 councillors. In 1204 John granted two weekly markets, on Tuesday and Saturday, and an annual fair of eight days at the feast of the Exaltation of the Holy Cross (Sept. 14). This fair, which is still held, and another on Palm Tuesday, are mentioned in the *Quo Warranto* roll of 1330. The Tuesday market has long been discontinued. That Chesterfield was early a thriving centre is shown by the charter of John Lord Wake, lord of the manor, granting a gild merchant to the town. In 1266 the town was the scene of a battle between the royal forces and the barons, when Robert de Ferrers, earl of Derby, was taken prisoner. In 1586 there was a terrible visitation of the plague; and the parliamentary forces were overthrown here in the Civil War. With the development of cotton and silk industries the town has increased enormously, and is now second in importance only to Derby among the towns of the county. There is no record that it ever returned representatives to parliament.

See Stephen Glover, *History and Gazetteer of the County of Derby* (Derby, 1831-1833); J. Pym Yeatman, *Records of the Borough of Chesterfield* (Chesterfield and Sheffield, 1884); Thomas Ford, *History of Chesterfield* (London, 1839).

CHESTER-LE-STREET, a town in the Chester-le-Street parliamentary division of Durham, England, near the river Wear, 6 m. N. of the city of Durham on the North-Eastern railway. Pop. (1901) 11,753. The parish church of St Mary and St Cuthbert is an interesting building, formerly collegiate, with a tower 156 ft. high, and a remarkable series of monumental tombs of the Lumley family, collected here from Durham cathedral and various ruined monasteries, and in some cases remade. About 1 m. along the river is Lumley Castle, the seat of the earl of Scarborough, and about 2 m. north lies Lambton Castle, the residence of the earl of Durham, built in 1797 on the site of the old House of Harraton. Collieries and iron-works employ the industrial population. Chester-le-Street is a place of considerable antiquity. It lies on a branch of the Roman north road, on which it was a station, but the name is not known. Under the name of *Cunecastre* it was made the seat of a bishop in 882, and continued to be the head of the diocese till the Danish invasion of 995. During that time the church was the repository of the shrine of St Cuthbert, which was then removed to Durham.

CHESTERTON, GILBERT KEITH (1874-), English journalist and author, who came of a family of estate-agents, was born in London on the 29th of May 1874. He was educated

at St Paul's school, which he left in 1891 with the idea of studying art. But his natural bent was literary, and he devoted himself mainly to cultivating that means of expression, both in prose and verse; he did occasional reviewing, and had some experience in a publisher's office. In 1900, having already produced a volume of clever poems, *The Wild Knight*, he definitely took to journalism as a career, and became a regular contributor of signed articles to the Liberal journals, the *Speaker* and *Daily News*. He established himself from the first as a writer with a distinct personality, combative to a swashbuckling degree, unconventional and dogmatic; and the republication of much of his work in a series of volumes (e.g. *Twelve Types*, *Heretics*, *Orthodoxy*), characterized by much acuteness of criticism, a pungent style, and the capacity of laying down the law with unflinching impetuosity and humour, enhanced his reputation. His powers as a writer are best shown in his studies of Browning (in the "English Men of Letters" series) and of Dickens; but these were only rather more ambitious essays among a medley of characteristic utterances, ranging from fiction (including *The Napoleon of Notting-hill*) to fugitive verse, and from artistic criticism to discussions of ethics and religion. The interest excited by his work and views was indicated and analysed in an anonymous volume (*G. K. Chesterton: a Criticism*) published in 1908.

CHESTERTON, an urban district in the Chesterton parliamentary division of Cambridgeshire, England, $1\frac{1}{2}$ m. N. from Cambridge station, on the north bank of the Cam. Pop. (1901) 9591. The church of St Andrew is Decorated and Perpendicular, retaining ancient woodwork and remains of fresco painting. Along the river are several boat-houses erected by the Cambridge University Boat Club. Boat-building and tile manufacture are local industries.

CHESTNUT (*nux Castanea*), the common name given to two sorts of trees and their fruit, (1) the so-called "horse-chestnut," and (2) the sweet or "Spanish" chestnut.

(1) The common horse-chestnut, *Aesculus Hippocastanum* (Ger. *Roskastanie*; Fr. *marronnier d'Inde*), has been stated to be a native of Tibet, and to have been brought thence to England in 1550; it is now, however, thought to be indigenous in the mountains of northern Greece, where it occurs wild at 3000 to 4000 ft. above sea-level. Matthioli, who attributes the origin of the name of the tree to the use of the nuts by the inhabitants of Constantinople for the relief of short-windedness and cough in horses, remarks that no ancient writer appears to have made mention of the horse-chestnut. Clusius (*Rariorum plantarum hist.* i. p. 8, 1601) describes it as a vegetable curiosity, of which in 1588 he had left in Vienna a living specimen, but of which he had not yet seen either the flowers or recent fruit. The dry fruit, he says, had frequently been brought from Constantinople into Europe.

The tree grows rapidly; it flourishes best in a sandy, somewhat moist loam, and attains a height of 50 to 60 or more ft., assuming a pyramidal outline. Its boughs are strong and spreading. The buds, conspicuous for their size, are protected by a coat of a glutinous substance, which is impervious to water; in spring this melts, and the bud-scales are then cast off. The leaves are composed of seven radiating leaflets (long-wedge-shaped); when young they are downy and drooping. From the early date of its leafing year by year, a horse-chestnut in the Tuileries is known as the "Marronnier du 20 mars." The flowers of the horse-chestnut, which are white dashed with red and yellow, appear in May, and sometimes, but quite exceptionally, again in autumn; they form a handsome erect panicle, but comparatively few of them afford mature fruit. The fruit is ripe in or shortly before the first week in October, when it falls to the ground, and the three-valved thorny capsule divides, disclosing the brown and at first beautifully glossy seeds, the so-called nuts, having a resemblance to sweet chestnuts, and commonly three or else two in number. For propagation of the tree, the seeds may be sown either when fresh, or, if preserved in sand or earth, in spring. Drying by exposure to the air for a month has been found to prevent their germination. Rooks are wont to remove the nuts

from the tree just before they fall, and to disperse them in various directions. The tree is rarely planted in mixed plantations where profit is an object; it interferes with its neighbours and occupies too much room. It is generally introduced near mansion-houses for ornament and shade, and the celebrated avenues at Richmond and Bushey Park in England are objects of great beauty at the time of flowering.

The bark of the horse-chestnut contains a greenish oil, resin, a yellow body, a tannin, $C_{26}H_{24}O_{12}$, existing likewise in the seeds and various parts of the tree, and decomposable into *phloroglucin* and *aesciglycolic acid*, $C_7H_6O_3$, also *aesculetin hydrate*, and the crystalline fluorescent compound *aesculin*, of the formula $C_{21}H_{24}O_{13}$ (Rochleder and Schwarz), with which occurs a similar substance *fraxin*, the *paicin* of Sir G. G. Stokes (*Q. J. Chem. Soc.* xi. 17, 1859; xii. 126, 1860), who suggests that its presence may perhaps account for the discrepancies in the analyses of aesculin given by different authors. From the seeds have been obtained starch (about 14%), gum, mucilage, a non-drying oil, phosphoric acid, salts of calcium, *saponin*, by boiling which with dilute hydrochloric or sulphuric acid *aesculic acid* is obtained, *quercitrin*, present also in the fully developed leaves, *aescigenin*, $C_{12}H_{20}O_2$, and *aesculetin*, $C_9H_6O_4$, which is procurable also, but in small quantity only, from the bark. Friedrich Rochleder has described as constituent principles of the cotyledons *aphrodaescin*, $C_{52}H_{82}O_{23}$, a bitter glucoside, *argyraescin*, $C_{27}H_{42}O_{12}$, *aescinic acid*, $C_{24}H_{40}O_{12}$, and *queraescitrin*, $C_{41}H_{46}O_{25}$, found also in the leaves. To prepare pure starch from the seeds, Flandin (*Compt. rend.* xxvii. 391, 1848; xxviii. 138, 1849) recommends kneading them, when peeled and bruised, in an aqueous solution of $\frac{1}{100}$ to $\frac{1}{50}$ of their weight of sodium carbonate. E. Staffel (*Ann. d. Chem. u. Pharm.* lxxvi., 1850, p. 379) after drying found, in spring and autumn respectively, 10.9 and 3.38% of ash in the wood, 8.68 and 6.57 in the bark, and 7.68 and 7.52 in the leaves of the horse-chestnut. The ash of the unripe fruit contains 58.77, that of the ripe kernel 61.74, and that of the green shell 75.91% of potash (E. Wolff).

The wood of the horse-chestnut is soft, and serves only for the making of water-pipes, for turner's work and common carpentry, as a source of charcoal for gunpowder, and as fuel. Newly cut it weighs 60 lb, and dry 35 lb per cub. ft. approximately. The bark has been employed for dyeing yellow and for tanning, and was formerly in popular repute as a febrifuge and tonic. The powder of the dried nuts was at one time prescribed as a sternutatory (to encourage sneezing) in the Edinburgh *Pharmacopoeia*. It is stated to form with alum-water a size or cement highly offensive to vermin, and with two parts of wheat flour the material for a strong bookbinder's paste. Infusion of horse-chestnuts is found to expel worms from soil, and soon to kill them if they are left in it. The nuts furthermore have been applied to the manufacture of an oil for burning, cosmetic preparations and starch, and in Switzerland, France and Ireland, when rasped on ground, to the bleaching of flax, hemp, silk and wool. In Geneva horse-chestnuts are largely consumed by grazing stock, a single sheep receiving 2 lb. crushed morning and evening. Given to cows in moderate quantity, they have been found to enhance both the yield and flavour of milk. Deer readily eat them, and, after a preliminary steeping in lime-water, pigs also. For poultry they should be used boiled, and mixed with other nourishment. The fallen leaves are relished by sheep and deer, and afford a good litter for flocks and herds.

One variety of the horse-chestnut has variegated leaves, and another double flowers. Darwin observed that *Ae. Pavia*, the red buckeye of North America, shows a special tendency, under unfavourable conditions, to be double-blossomed. The seeds of this species are used to stupefy fish. The scarlet-flowered horse-chestnut, *Ae. rubicunda*, is a handsome tree, less in height and having a rounder head than the common form; it is a native of North America. Another species, possessing flowers with the lower petals white with a red tinge, and the upper yellow and red with a white border, and fruit unarmed, is *Ae. indica*, a native of the western Himalayas. Among the North American species are the foetid or Ohio buckeye, *Ae. glabra*, and *Ae. flava*, the sweet

huckeye. *Ae. californica*, when full-grown and in flower, is a beautiful tree, but its leaves often fall before midsummer.

(2) The Spanish or sweet chestnut, *Castanea sativa* (natural order, Fagaceae), is a stately and magnificent tree, native of the countries bordering on the Mediterranean, but also ripening its fruit in sheltered situations as far north as Scotland. It lives very long, and attains a large size, spreading its branches widely. It has large glossy lanceolate leaves with a toothed margin. The flowers, which appear in early summer, are in pendulous, slender yellowish catkins, which bear a number of staminate flowers with a few pistillate flowers at the base. The staminate contain 8 to 20 stamens which produce an enormous amount of dusty yellow pollen, some of which gets carried by wind to the protruding stigmas of the pistillate flowers. The latter are borne three together, invested by a cupule of four green bracts, which, as the fruit matures, grow to form the tough green prickly envelope surrounding the group of generally three nuts. The largest known chestnut tree is the famous *Castagno di cento cavalli*, or the chestnut of a hundred horses, on the slopes of Mount Etna, a tree which, when measured about 1780 by Count Borch, was found to have a circumference of 190 ft. The timber bears a striking resemblance to that of the oak, which has been mistaken for chestnut; but it may be distinguished by the numerous fine medullary rays. Unlike oak, the wood is more valuable while young than old. When not more than fifty years old it forms durable posts for fences and gates; but at that age it often begins to deteriorate, having ring-shakes and central hollows. In a young state, when the stems are not above 2 in. in diameter at the ground, the chestnut is found to make durable hoops for casks and props for vines; and of a larger size it makes good hop-poles.

Chestnuts (the fruit of the tree) are extensively imported into Great Britain, and are eaten roasted or boiled, and mashed or otherwise as a vegetable. In a raw state they have a sweet taste, but are difficult of digestion. The trees are very abundant in the south of Europe, and chestnuts bulk largely in the food resources of the poor in Spain, Italy, Switzerland and Germany. In Italy the kernels are ground into meal, and used for thickening soups, and even for bread-making. In North America the fruits of an allied species, *C. americana*, are eaten both raw and cooked.

CHETTLE, HENRY (1564?-1607?), English dramatist and miscellaneous writer, was the son of Robert Chettle, a London dyer. He was apprenticed in 1577 to a stationer, and in 1591 became a partner with William Hoskins and John Danter. In 1592 he published Robert Greene's *Groatsworth of Wit*. In the preface to his *Kind Herts Dreame* (end of 1592) he found it necessary to disavow any share in that pamphlet, and incidentally he apologized to three persons (one of them commonly identified with Shakespeare) who had been abused in it. *Piers Plaimnes Seaven Yeres Prentiship*, the story of a fictitious apprenticeship in Crete and Thrace, appeared in 1595. As early as 1598 Francis Meres includes him in his *Palladis Tamia* as one of the "best for comedy," and between that year and 1603 he wrote or collaborated in some forty-nine pieces. He seems to have been generally in debt, judging from numerous entries in Henslowe's diary of advances for various purposes, on one occasion (17th of January 1599) to pay his expenses in the Marshalsea prison, on another (7th of March 1603) to get his play out of pawn. Of the thirteen plays usually attributed to Chettle's sole authorship only one was printed. This was *The Tragedy of Hoffmann: or a Revenge for a Father* (played 1602; printed 1631), a share in which Mr Fleay assigns to Thomas Heywood. It has been suggested that this piece was put forward as a rival to Shakespeare's *Hamlet*. Among the plays in which Chettle had a share is catalogued *The Danish Tragedy*, which was probably either identical with *Hoffmann* or another version of the same story. *The Pleasant Comedie of Patient Grissill* (1599), in which he collaborated with Thomas Dekker and William Haughton, was reprinted by the Shakespeare Society in 1841. It contains the lyric "Art thou poor, yet hast thou golden slumbers," which is probably Dekker's. In November 1599 Chettle receives ten shillings for mending the first part of "Robin Hood," i.e. *The Downfall of Robert, Earl of Huntingdon*, by Anthony Munday;

and in the second part, which followed soon after and was printed in 1601, *The Death of Robert, Earle of Huntingdon*, he collaborated with Munday. Both plays are printed in Dodsley's *Select Collection of Old English Plays* (ed. W. C. Hazlitt, vol. viii.). In 1603 Chettle published *England's Mourning Garment*, in which are included some verses alluding to the chief poets of the time. His death took place before the appearance of Dekker's *Knight's Conjuror* in 1607, for he is there mentioned as a recent arrival in limbo.

Hoffmann was edited by H. B(arrett) L(ennard) (1852) and by Richard Ackermann (Bamberg, 1894).

CHEVALIER, ALBERT (1861-), English comedian, began a connexion with the stage while still a child. In 1877 he was engaged as an actor under the Bancrofts in London, and for some years played "legitimate" parts at the Court theatre and elsewhere. In 1891, however, he began a successful music-hall career as a singer of coster songs of his own invention, a new type in which he had an immediate success, both in England and America. He subsequently organized an entertainment of his own, with sketches and songs, with which he went on tour, establishing a wide popularity as an original artist in his special line.

CHEVALIER, MICHEL (1806-1879), French economist, was born at Limoges on the 13th of January 1806. In his early manhood, while employed as an engineer, he became a convert to the theories of Saint Simon; these he ardently advocated in the *Globe*, the organ of the Saint Simonians, which he edited until his arrest in 1832 on a charge of outraging public morality by its publication. He was sentenced to a year's imprisonment, but was released in six months through the intervention of Thiers, who sent him on a special mission to the United States to study the question of land and water transport. In 1836 he published, in two volumes, the letters he wrote from America to the *Journal des débats*. These attracted so much attention that he was sent in the same year on an economic mission to England, which resulted in his publication (in 1838) of *Des intérêts matériels de la France*. The success of this made his position secure, and in 1840 he was appointed professor of political economy in the Collège de France. He sat for a short time (1845-1846) as a member of the Chamber of Deputies, but lost his seat owing to his enthusiastic adoption of the principles of free trade. Under Napoleon III. he was restored to the position of which the revolution of 1848 had temporarily deprived him. In 1850 he became a member of the Institute, and in the following year published an important work in favour of free trade, under the title of *Examen du système commercial connu sous le nom de système protecteur*. His chief public triumph was the important part he played in bringing about the conclusion of the commercial treaty between France and Great Britain in 1860. Previously to this he had served, in 1855, upon the commission for organizing the Exhibition of 1855, and his services there led to his forming one of the French jury of awards in the London Exhibition of 1862. He was created a member of the Senate in 1860, and continued for some years to take an active part in its discussions. He retired from public life in 1870, but was unceasingly industrious with his pen. He became grand officer of the Legion of Honour in 1861, and during the later years of his life received from many quarters public recognition of his eminence as a political economist. He died at his château near Montpellier (Hérault) on the 28th of November 1879. Many of his works have been translated into English and other languages. Besides those already mentioned the more important are: *Cours d'économie politique* (1842-1850); *Essais de politique industrielle* (1843); *De la baisse probable d'or* (1859, translated into English by Cobden, *On the Probable Fall of the Value of Gold*, Manchester, 1859); *L'Expédition du Mexique* (1862); *Introduction aux rapports du jury international* (1868).

CHEVALIER, ULYSSE (1841-), French bibliographer, was born at Rambouillet on the 24th of February 1841. He published a great number of documents relating to the history of Dauphiné, e.g. the cartularies of the church and the town of Die (1868), of the abbey of St André le-Bas at Vienne (1869), of the abbey of Notre Dame at Bonnevaux in the diocese of Vienne (1889), of the abbey of St Chaffre at Le Monestier (1884), the

inventories and several collections of archives of the dauphins of Viennais, and a *Bibliothèque liturgique* in six volumes (1893-1897), the third and fourth volumes of which constitute the *Repertorium hymnologicum*, containing more than 20,000 articles. But his principal work is the *Répertoire des sources historiques du moyen âge*. The first part, *Bio-bibliographie* (1877-1886; 2nd ed., 1905), contains the names of all the historical personages alive between the years 1 and 1500 who are mentioned in printed books, together with the precise indication of all the places where they are mentioned. The second part, *Topo-bibliographie* (1894-1903), contains not only the names of places mentioned in books on the history of the middle ages, but, in a general way, everything not included in the *Bio-bibliographie*. The *Répertoire* as a whole contains an enormous mass of useful information, and is one of the most important bibliographical monuments ever devoted to the study of medieval history. Though a Catholic priest and professor of history at the Catholic university of Lyons, the Abbé (afterwards Canon) Chevalier knew how to maintain an independent critical attitude even in religious questions. In the controversy on the authenticity of the Holy Shroud (*sudario*) at Turin, he worked in the true scientific spirit by tracing back the history of that piece of stuff, which was undoubtedly used as a shroud, but which was not produced before the 14th century and is probably no older (See *Le Saint Suaire de Lirey-Chambéry-Turin et les défenseurs de son authenticité*). Similarly, in *Notre Dame de Lorette; étude critique sur l'authenticité de la Santa Casa* (1906), he dissipated by the aid of authentic documents the legend which had embellished and falsified the primitive history of that sanctuary.

CHEVAUX-DE-FRISE (French for "Friesland horses"; the Dutch *Yriessse ruyters*, "Frisian horsemen," and German *Spanische Reiter*, "Spanish horsemen"), a military obstacle, originating apparently in the Dutch War of Independence, and used to close the breach of a fortress, streets, &c. It was formerly often used in field operations as a defence against cavalry; hence the name, as the Dutch were weak in the mounted arm and had therefore to check the enemy's cavalry by an artificial obstacle. Chevaux-de-frise consist of beams in which are fixed a number of spears, sword-blades, &c., with the points projecting outwards on all sides.

CHEVERUS, JEAN LOUIS ANNE MAGDELEINE LEFEBVRE DE (1768-1836), French ecclesiastic, was born on the 28th of January 1768, in Mayenne, France, where his father was general civil judge and lieutenant of police. He studied at the college of Mayenne, received the tonsure when twelve, became prior of Torbechet while still little more than a child, thence derived sufficient income for his education, entered the College of Louis le Grand in 1781, and after completing his theological studies at the Seminary of St Magloire, was ordained deacon in October 1790, and priest by special dispensation on the 18th of December. He was immediately made canon of the cathedral of Le Mans and began to act as vicar to his uncle in Mayenne, who died in 1792. Owing to the progress of the Revolution he emigrated in 1792 to England, and thence in 1796 to America, settling in Boston, Mass. His interest had been aroused by François Antoine Matignon, a former professor at Orleans, now in charge under Bishop John Carroll of all the Catholic churches and missions in New England. Cheverus, although at first appointed to an Indian mission in Maine, remained in Boston for nearly a year, and returned thither after several months in the Penobscot and Passamaquoddy missions and visits to scattered Catholic families along the way. During the epidemic of yellow fever in 1798 he won great praise and respect for his courage and charity; and his preaching was listened to by many Protestants—indeed the subscriptions for the Church of the Holy Cross which he founded in 1803 were largely from non-Catholics. In 1808 the papal brief was issued making Boston a bishopric, suffragan to Baltimore, and Cheverus its bishop. He was consecrated on All Saints' day in 1810, at St Peter's, Baltimore, by Archbishop Carroll. On the death of the latter his assistant bishop, Neale, urged the appointment of Cheverus as assistant to himself; Cheverus refused and warmly asserted his desire to remain in Boston; but, much broken by the

death of Matignon in 1818 and with impaired health, he soon found it necessary to leave the seat of his bishopric. In 1823, Louis XVIII. having insisted on his return to France, Cheverus became bishop of Montauban, where his tolerance captivated the Protestant clergy and laymen of the city. He was made archbishop of Bordeaux in 1826; and on the 1st of February 1836, in accordance with the wish of Louis Philippe, he was made a cardinal. He died in Bordeaux on the 19th of July 1836. To Cheverus, more than to any other, is due the position that Boston now holds in the Roman Catholic Church of America, as well as the general growth of that church in New England. His character was essentially lovable: the Jews of Bordeaux and Protestants everywhere delighted to honour him.

See the rather extravagant biography by J. Huen-Dubourg, *Vie du cardinal de Cheverus* (Bordeaux, 1838; English version by E. Stewart, Boston, 1839).

CHEVET, the term employed in French architecture to distinguish the apsidal end of a church, in which the apses or chapels radiate round the choir aisle. The two earliest examples (11th and 12th century) are found in the churches of St Hilaire, Poitiers, and Notre Dame-du-Port, Clermont, where there are four apses. A more usual number is five, and the central apse, being of larger dimensions, becomes the Lady chapel. This was the case in Westminster Abbey, where Henry III. introduced the chevet into England; Henry VII.'s chapel is built on the site of the original Lady chapel, which must have been of exceptional size, as it extended the whole length of the present structure. In Solignac, Fontevault and Paray-le-Monial there are only three, in these cases sufficiently distant one from the other to allow of a window between. The usual number in all the great cathedrals of the 13th century, as in Bourges, Chartres, Reims, Troyes, Tours, Bayeux, Antwerp and Bruges, is five. In Beauvais, Amiens and Cologne there are seven apsidal chapels, and in Clairvaux nine radiating but rectangular chapels. In the 14th and 15th centuries the central apse was increased in size and dedicated to the Virgin Mary, as in St Ouen at Rouen.

CHEVIOT HILLS, a range forming about 35 m. of the border between England and Scotland. The boundary generally follows the line of greatest elevation, but as the slope is more gradual southward and northward the larger part of the range is in Northumberland, England, and the lesser in Roxburghshire, Scotland. The axis runs from N.E. to S.W., with a northward tendency at the eastern end, where the ridge culminates in the Cheviot, 2676 ft. Its chief elevations from this point south-westward fall abruptly to 2034 ft. in Windygate Hill, and then more gradually to about 1600 ft. above the pass, followed by a high road from Redesdale. Beyond this are Carter Fell (1815) and Peel Fell (1964), after which two lines of lesser elevation branch westward and southward to enclose Liddesdale. The hills are finely grouped, of conical and high-arched forms, and generally grass-covered. Their flanks are scored with deep narrow glens in every direction, carrying the headwaters of the Till, Coquet and North Tyne on the south, and tributaries of the Tweed on the north. The range is famous for a valuable breed of sheep, which find abundant pasture on its smooth declivities. In earlier days it was the scene of many episodes of border warfare, and its name is inseparably associated with the ballad of *Chevy Chase*. The main route into Scotland from England lies along the low coastal belt east of the Till; the Till itself provided another, and Redesdale a third. There are numerous ruins of castles and "peel towers" or forts on the English side in this district.

Geology.—The rocks entering into the geological structure of the Cheviots belong to the Silurian, Old Red Sandstone and Carboniferous systems. The oldest strata, which are of Upper Silurian age, form inliers that have been exposed by the denudation of the younger palaeozoic rocks. One of these which occurs high up on the slopes of the Cheviots is drained by the Kale Water and the river Coquet and is covered towards the north by the Old Red Sandstone volcanic series and on the south by Carboniferous strata. Another area is traversed by the Jed Water and the Edgerston Burn and is surrounded by rocks of Old Red Sandstone age. The strata consist of greywackes, flags and shales with seams and zones of graptolite shale which yield fossils sparingly.

On the upturned and denuded edges of the Silurian strata a great pile of contemporaneous volcanic rocks of Lower Old Red Sandstone age rests unconformably, which consists chiefly of lavas with thin partings of tuff. A striking feature is the absence of coarse sediments, thus indicating prolonged volcanic activity. They cover an area of about 230 sq. m. in the eastern part of the Cheviots and rise to a height of 2676 ft. above the sea. The lavas comprise dark pitchstone, resembling that at Kirk Yetholm, and porphyritic and amygdaloidal andesites and basalts. This volcanic platform is pierced by a mass of granite about 20 sq. m. in extent, which forms the highest peak in the Cheviot range. It has been described by Dr Teall as an augite-biotite-granite having strong affinities with the augite-bearing granites of Laveline and Oberbrück in the Vosges. Both the granite and the surrounding lavas are traversed by dykes and sills of intermediate and acid types represented by mica-porphyrates and quartz-felsites.

On their north-west margin the Lower Old Red volcanic rocks are covered unconformably by the upper division of that system composed of red sandstones and conglomerates, which, when followed westwards, rest directly on the Silurian platform. Towards the south and east the volcanic pile is overlaid by Carboniferous strata, thus indicating a prolonged interval of denudation.

On the northern slopes of the western part of the Cheviots the representatives of the Cementstone group of the Carboniferous system come to the surface, where they consist of shales, clays, mudstones, sandstones with cementstones and occasional bands of marine limestone. These are followed in normal order by the Fell Sandstone group, comprising a succession of sandstones with intercalations of red and green clays and impure cementstone bands. They form the higher part of the Larriston Fells and are traceable eastwards to Peel Fell, where there is evidence of successive land surfaces in the form of dirt beds. They are succeeded by the Lewisburn coal-bearing group, which represents the Scremerston coals.

CHEVREUL, MICHEL EUGÈNE (1786-1889), French chemist, was born, on the 31st of August 1786, at Angers, where his father was a physician. At about the age of seventeen he went to Paris and entered L. N. Vauquelin's chemical laboratory, afterwards becoming his assistant at the natural history museum in the Jardin des Plantes. In 1813 he was appointed professor of chemistry at the Lycée Charlemagne, and subsequently undertook the directorship of the Gobelins tapestry works, where he carried out his researches on colour contrasts (*De la loi du contraste simultané des couleurs*, 1839). In 1826 he became a member of the Academy of Sciences, and in the same year was elected a foreign member of the Royal Society of London, whose Copley medal he was awarded in 1857. He succeeded his master, Vauquelin, as professor of organic chemistry at the natural history museum in 1830, and thirty-three years later assumed its directorship also; this he relinquished in 1879, though he still retained his professorship. In 1886 the completion of his hundredth year was celebrated with public rejoicings; and after his death, which occurred in Paris on the 9th of April 1889, he was honoured with a public funeral. In 1901 a statue was erected to his memory in the museum with which he was connected for so many years. His scientific work covered a wide range, but his name is best known for the classical researches he carried out on animal fats, published in 1823 (*Recherches sur les corps gras d'origine animale*). These enabled him to elucidate the true nature of soap; he was also able to discover the composition of stearin and olein, and to isolate stearic and oleic acids, the names of which were invented by him. This work led to important improvements in the processes of candle-manufacture. Chevreul was a determined enemy of charlatanism in every form, and a complete sceptic as to the "scientific" psychical research or spiritualism which had begun in his time (see his *De la baguette divinatoire, et des tables tournantes*, 1864).

CHEVRON (Fr. from *chèvre*, a goat), in architecture, the beams or rafters in the roofs of a building, meeting in an angle with a fancied resemblance to the horns of a butting goat; in heraldry a bent bar on a shield, used also as a distinguishing badge of rank on the sleeves of non-commissioned officers in most armies and navies and by police and other organized bodies wearing uniform, and as a mark of good conduct in the army and navy. Chevron is also an architectural term for an inflected ornament, called also "zig-zag," found largely in romanesque architecture in France, England and Sicily. It is one of the most common decorations found in the vousoirs of the Norman arch, and was employed also on shafts, as in the cloisters of Monreale near

Palermo, those of St Paul outside Rome, and many churches in Germany. Its earliest appearance was in the tomb of Agamemnon at Mycenae, where the shafts flanking the entrance doorway have nine decorative chevron bands; in this case there is no doubt it was derived from the metal casing of the early wood columns.

CHEVROTAIN, a name taken from the French to designate the various representatives of the mammalian ungulate family *Tragulidae*. These tiny animals, commonly known as mouse-deer, are in no wise nearly related to the true deer, but constitute by themselves a special section of artiodactyle ungulates known as *Tragulina*, for the characteristics of which see *ARTIODACTYLA*. The typical genus *Tragulus*, which is Asiatic, contains the smallest representatives of the family, the animals having more of the general aspects and habits of some rodents, such as the agoutis, than of other ruminants. The longest-known species are *T. javanicus*, *T. napu*, *T. kanchil*, *T. stanleyanus* and *T. memmina*; but a number of other forms, best regarded for the most part as races, have been named. Of those mentioned, the first four are from the Malay Peninsula or the islands of the Indo-Malay Archipelago, the last from Ceylon and India. *Kanchil* and *napu*



African Water Chevrotain (*Dorcatheerium aquaticum*).

(or *napoh*) are the Malay names of the species with those specific titles. The second genus, *Dorcatheerium* (or *Hyomoschus*), is African, and distinguished chiefly by the feet being stouter and shorter, the outer toes better developed, and the two middle metacarpals not welded together. Its dental formula (as that of *Tragulus*) is $i. \frac{3}{3}, c. \frac{1}{1}, p. \frac{3}{3}, m. \frac{3}{3} = 34$. Vertebrae: C. 7, D. 13, L. 6, S. 5, Ca. 12-13. The only existing species, *D. aquaticum* (fig.), in type is rather larger than any of the Asiatic chevrotains, which it otherwise much resembles, but is said to frequent the banks of streams, and have much the habits of pigs. It is of a rich brown colour, with back and sides spotted and striped with white; and it is evidently the survivor of an ancient form, as remains of a species only differing in size (*D. crassum*) have been found in the Miocene deposits of France. For long this species was supposed to be restricted to West Africa, but it has recently been obtained in East Central Africa, where it is represented by a local race. (R. L.*)

CHEYENNE (Sioux for "of alien speech"), a tribe of North American Indians of Algonquian stock. They formerly lived on the Cheyenne river, North Dakota. Driven west by the Dakotas, they were found by early explorers at the eastern base of the Black Hills, South Dakota. Part of them later moved south and allied themselves with the Arapaho. Their whole history has been one of war with their red and white neighbours. They are a powerful athletic race, mentally superior to the average American Indian. They are divided into eleven subdivisions and

formerly had a council of chiefs. They number some 3000, and are divided into northern and southern Cheyennes; the former being on a reservation in Montana, the latter in Oklahoma. In 1878-79 a band of the former revolted, and some seventy-five of them were killed.

See *Handbook of American Indians* (Washington, 1907); also **INDIANS, NORTH AMERICAN**.

CHEYENNE, the chief city and capital of Wyoming, U.S.A., and county-seat of Laramie county, on Crow Creek, about 106 m. N. of Denver. Pop. (1890) 11,690; (1900) 14,087, of whom 1691 were foreign-born; (1905) 13,656; (1910) 11,320. It is served by the Union Pacific, the Chicago, Burlington & Quincy, and the Colorado & Southern railways. It is situated near the southern boundary of the state, on the high plains near the E. foot of the Laramie range, at an altitude of 6050 ft.; the surrounding country is given up to mining (lignite and iron), grazing and dry-farming. Among the principal buildings are the capitol, modelled after the National Capitol at Washington; the United States government building, the Soldiers' and Sailors' Home, the Union Pacific dépôt, the high school, the Carnegie library, St Mary's cathedral (Roman Catholic), the Convent of the Holy Child Jesus, the Masonic Temple and the Elks' clubhouse. The city has two parks, and is connected by a boulevard with Fort D. A. Russell, an important United States military post, 4 m. north of the city, established in 1867 and named in honour of Major-General David Allen Russell (1820-1864) of the Union army, who was killed at Opequan, Virginia. The industrial prosperity of Cheyenne is largely due to the extensive railway shops of the Union Pacific situated here; but the city is also an important cattle market and has stock-yards. In 1905 the value of the city's factory products (\$924,697) was almost one-fourth the total value of the factory products of the state. Cheyenne, settled in 1867, when the Union Pacific reached here, was named from the Cheyenne Indians. It was chosen as the site for the capital of the territory in 1869, and was incorporated in the same year.

CHEYNE, THOMAS KELLY (1841-), English divine and Biblical critic, was born in London, and educated at Merchant Taylors' School and Oxford. Subsequently he studied German theological methods at Göttingen. He was ordained in 1864, and held a fellowship at Balliol College, Oxford, 1868-1882. During the earlier part of this period he stood alone in the university as a teacher of the main conclusions of modern Old Testament criticism. In 1881 he was presented to the rectory of Tendring, in Essex, and in 1884 he was made a member of the Old Testament revision company. He resigned the living of Tendring in 1885 on his appointment to the Oriel professorship, which carried with it a canonry at Rochester. In 1889 he delivered the Bampton lectures at Oxford. In 1908 he resigned his professorship. He consistently urged in his writings the necessity of a broad and comprehensive study of the Scriptures in the light of literary, historical and scientific considerations. His publications include commentaries on the Prophets and Hagiographa, and lectures and addresses on theological subjects. He was a joint editor of the *Encyclopaedia Biblica* (London, 1899-1903), a work embodying the more advanced conclusions of English biblical criticism. In the introduction to his *Origin of the Psalter* (London, 1891) he gave an account of his development as a critical scholar.

CHÉZY, ANTOINE LÉONARD DE (1773-1832), French orientalist, was born at Neuilly on the 15th of January 1773. His father, Antoine de Chézy (1718-1798), was an engineer who finally became director of the *École des Ponts et Chaussées*. The son was intended for his father's profession; but in 1799 he obtained a post in the oriental department of the national library. About 1803 he began the study of Sanskrit, though he possessed neither grammar nor dictionary, and by great labour he obtained sufficient knowledge of the language to be able to compose in it verses said to possess great elegance. He was the first professor of Sanskrit appointed in the Collège de France (1815), a chevalier of the Legion of Honour, and a member of the Académie des Inscriptions. He died in 1832. Among his works were *Medjoun*

et Leila (1807), from the Persian; *Yadjanadatta Badha* (1814) and *La Reconnaissance de Sacountala* (1830), from the Sanskrit; *L'Anthologie érotique d'Amrou* (1831), published under the pseudonym d'Apudy.

See the *Mémoires* of the Académie des Inscriptions (new series, vol. xii.), where there is a notice of Chézy by Silvestre de Sacy.

CHHATARPUR, a native state in the Bundelkhand agency of Central India. Area, 1118 sq. m.; pop. (1901) 156,139; estimated revenue, £16,000. The chief, whose hereditary title is raja, is a Rajput of the Ponwar clan, whose ancestor dispossessed the descendant of Chhatar Sal, the founder of Bundelkhand independence, towards the end of the 18th century. The state was guaranteed to Kunwar Suni Singh Ponwar in 1806. In 1854 it would have lapsed to the British government for want of direct heirs, but was conferred on Jagat Raj as a special act of grace. The town of CHHATARPUR, which is named after Chhatar Sal, and contains his cenotaph, is 70 m. by road S.W. of Banda. Pop. (1901) 10,029. There are manufactures of paper and coarse cutlery, and a high school. The state also contains the British cantonment of Nowgong.

CHHATTISGARH, a division of the Central Provinces of India, comprising a British division (21,240 sq. m.) and two small feudatory states, Raigarh (1486 sq. m.) and Sarangarh (540 sq. m.). In 1905 the five Oriya states of Bamra, Rairakhol, Sonpur, Patna and Kalahandi were transferred from the Central Provinces to Bengal. Chhattisgarh, or "the thirty-six forts," is a low-lying plain, enclosed on every side by hills and forests, while a rocky barrier shuts it off from the Nagpur plain on the west. Two great rivers, the Nerbudda and Sone, take their rise at the side of the Amarkantak hill in the north-west corner of the division, the Nerbudda flowing nearly due west to the Bombay coast, the Sone ultimately falling into the Ganges in Lower Bengal. Protected on both sides by ranges of hills, the district was, until late years, the least known portion of the most obscure division of India, but recently it has been opened up by the Bengal-Nagpur railway, and has developed into a great grain-producing country. Its population is almost pure Hindu, except in the two great tracts of hill and forest, where the aboriginal tribes retired before the Aryan invasion. It remained comparatively unaffected either by the Oriya immigration on the east, or by the later influx of Mahrattas on the west. For though the Mahrattas conquered and governed the country for a period, they did not take possession of the land. In 1901 the population of the two remaining feudatory states was 125,281, Raigarh having 86,543 and Sarangarh 38,738. Much of the soil is still covered with forest, but it includes fertile rice land.

The British division of Chhattisgarh comprises the three districts of Drug (created in 1906), Raipur and Bilaspur. In 1905 the district of Sambalpur, together with the five feudatory states, was transferred to Bengal. In 1901 the population of the reduced area was 2,642,983.

CHHINDWARA, a town and district of British India, in the Nerbudda division of the Central Provinces. The site of the town is 2200 ft. above sea-level, and is surrounded by ranges of low hills. The European station extends for nearly 2 m. and is well wooded. It is considered very healthy, and forms a resort for European visitors from Nagpur and Kampti during the hot weather.

The area of the DISTRICT OF CHHINDWARA is 4631 sq. m. It has two natural subdivisions—the hill country above the slopes of the Satpura mountains, called the Balaghat, and a tract of low land to the south called the Zerghat. The high tableland of the Balaghat lies for the most part upon the great basaltic formation which stretches across the Satpuras as far east as Jubbulpore. The country consists of a regular succession of hills and fertile valleys, formed by the small ranges which cross its surface east and west. The average height of the uplands is 2500 ft., but there are many points of greater elevation. The appearance of the Zerghat below the hills is generally open and undulating. The country is intersected by several streams, of which the Kanhan is the most considerable. Near the hills and along the streams are strips and patches of jungle; the villages are usually surrounded

with picturesque groves of tamarind, mango and other shade-giving trees. In the hill-country the climate is temperate and healthy. In the cold season ice is frequently seen in the small tanks at an elevation of about 2000 ft. Until May the hot wind is little felt, while during the rains the weather is cool and agreeable. The average annual rainfall amounts to 36 in. Pop. (1901) 407,927. There are manufactures of cotton cloth and brass-ware. Coal in this neighbourhood began to be worked after the opening of a branch of the Bengal-Nagpur railway to Chhindwara and the coalfields to the north in 1905.

Chhindwara formed part of the dominions of the ancient Gond dynasty of Chhindwara and Nagpur, whose seat was at Deogarh until, in the 18th century, it was removed by Chand Sultan, son of Bakht Buland (founder of the short-lived greatness of the dynasty, and of the city of Nagpur) to Nagpur (see GONDWARA and NAGPUR).

CHIABRERA, GABRIELLO (1552-1637), Italian poet, sometimes called the Italian Pindar, was of patrician descent, and was born at Savona, a little town in the domain of the Genoese republic, twenty-eight years after the birth of Ronsard, with whom he has far more in common than with the great Greek whose echo he sought to make himself. As he has told in the pleasant fragment of autobiography prefixed to his works, in which, like Caesar, he speaks of himself in the third person, he was a posthumous child; he went to Rome at the age of nine years, under the care of his uncle Giovanni. There he read with a private tutor, suffered severely from two fevers in succession, and was sent at last, for the sake of society, to the Jesuits' College, where he remained till his twentieth year, studying philosophy, as he says, "più per trattenimento che per apprendere,"—rather for occupation than for learning's sake. Losing his uncle about this time, Chiabrera returned to Savona, "again to see his own and be seen by them." In a little while, however, he returned to Rome, and entered the household of a cardinal, where he remained for several years, frequenting the society of Paulus Manutius and of Sperone Speroni, the dramatist and critic of Tasso, and attending the lectures and hearing the conversation of Mureto. His revenge of an insult offered him obliged him to betake himself once more to Savona, where, to amuse himself, he read poetry, and particularly Greek. The poets of his choice were Pindar and Anacreon, and these he studied till it grew to be his ambition to reproduce in his own tongue their rhythms and structures, and so to enrich his country with a new form of verse—in his own words, "like his countryman, Columbus, to find a new world or drown." His reputation was made at once; but he seldom quitted Savona, though often invited to do so, saving for journeys of pleasure, in which he greatly delighted, and for occasional visits to the courts of princes whither he was often summoned, for his verse's sake, and in his capacity as a dramatist. At the ripe age of fifty he took to himself a wife, one Lelia Pavese, by whom he had no children. After a simple and blameless life, during which he produced a vast quantity of verse—epic, tragic, pastoral, lyrical and satirical—he died in 1637, at the patriarchal age of eighty-five. An epitaph was written for him in elegant Latin by Urban VIII.; but on his tombstone are graven two quaint Italian hexameters of his own, in which the gazer is warned from the poet's own example not to prefer Parnassus to Calvary.

A maker of odes in all their elaborate pomp of strophe and antistrophe, a master of new and complex rhythms, a coiner of ambitious words and composite epithets, an employer of audacious transpositions and inversions, and the inventor of a new system of poetic diction,—it is not surprising that Chiabrera should have been compared with Ronsard. Both were destined to suffer eclipse as great and sudden as had been their glory. Ronsard was succeeded by Malherbe and by French literature, properly so-called; Chiabrera was the last of the great Italians, and after him literature languished till the second renaissance under Manzoni. Chiabrera, however, was a man of merit, apart from that of the mere innovator. Setting aside his epics and dramas (one of the latter received the honours of translation at the hands of Nicolas Chrétien, a sort of scenic du Bartas), much

of his work remains yet readable and pleasant. His grand Pindarics are dull, it is true, but some of his *Canzonette*, like the anacreontics of Ronsard, are exceedingly elegant and graceful. His autobiographical sketch is also extremely interesting. The simple old poet, with his adoration of Greek (when a thing pleased him greatly he was wont to talk of it as "Greek Verse"), his delight in journeys and sight-seeing, his dislike for literary talk save with intimates and equals, his vanities and vengeance, his pride in the memory of favours bestowed on him by popes and princes, his "*infinita meraviglia*" over Virgil's versification and metaphor, his fondness for masculine rhymes and blank verse, his quiet Christianity, is a figure deserving perhaps of more study than is likely to be bestowed on that "new world" of art which it was his glory to fancy his own, by discovery and by conquest.

The best editions of Chiabrera are those of Rome (1718, 3 vols. 8vo); of Venice (1731, 4 vols. 8vo); of Leghorn (1781, 5 vols. 12mo); and of Milan (1807, 3 vols. 8vo). These only contain his lyric work; all the rest he wrote has been long forgotten.

CHIANA (anc. *Clanis*), a river of Tuscany, which rises in the Apennines S. of Arezzo, runs through the valley of Chiusi, and after receiving the Paglia just below Orvieto, falls into the Tiber after a course of 60 m. In Roman times its waters ran entirely into the Tiber. It often caused considerable floods in the valley of Clusium (Chiusi) which were noticeable even in Rome itself, and in A.D. 15 it was proposed to divert part of its waters into the Arno, a project which was abandoned owing to the opposition of the Florentines (*Tac. Ann.* i. 76, 79). In the middle ages the whole of its valley from Arezzo to Chiusi was an uninhabitable swamp; but at the end of the 18th century the engineer Count Fossombroni took the matter in hand, and moved the watershed some 25 m. farther south, so that its waters now flow partly into the Arno and partly into the Tiber.

CHIAPAS, a Pacific coast state of southern Mexico on the Guatemalan frontier, bounded by the states of Tabasco on the N. and Vera Cruz and Oaxaca on the W. Pop. (1895) 318,730; (1900) 360,799, a large proportion of which are Indians; area, 27,222 sq. m. largely forested. The Sierra Madre crosses the southern part of the state parallel with the coast, separating the low, humid, forested districts on the frontier of Tabasco from the hot, drier, coastal plain on the Pacific. The mountain region includes a plateau of great fertility and temperate climate, which is one of the best parts of Mexico and contains the larger part of the population of the state. But isolation and lack of transportation facilities have retarded its development. The extension of the Pan-American railway across the state, from San Geronimo, on the Tehuantepec National line, to the Guatemalan frontier, is calculated to improve the industrial and social conditions of the people. The principal industries are agriculture, which is very backward, stock-raising, timber-cutting, fruit-farming and salt-making. Coffee-planting is a new industry on the Pacific slope of the Sierra Madre at elevations of 2000 to 4000 ft., and has met with considerable success. Rubber plantations have also been laid out, principally by American companies, the *Castilloa elastica* doing well. The exports include cattle, hides, coffee, rubber, fruit and salt. The mineral resources include gold, silver, copper and petroleum, but no mines were in operation in 1906. The capital, Tuxtla Gutierrez (pop. 9395 in 1900), is on the plateau, 3½ m. from the Rio Sabinas, and 138 m. N.E. of the Pacific port of Tonalá. The former capital, San Cristobal (pop. about 5000 in 1895), about 40 m. E. of Tuxtla, is an interesting old town and the seat of the bishopric of Chiapas, founded in 1525 and made famous through its associations with Las Casas. Tapachula (pop. in 1895, 6775), the capital of the department of Soconusco, 18 m. from the Guatemalan frontier, is a rising commercial town of the new coffee district. It is 24 m. inland from the small port of San Benito, is 559 ft. above sea-level, and has a healthy climate. Other prominent towns with their populations in 1895, are Comitán, or Comitlan (9316), on the Rio Grijalva about 40 m. S.E. of San Cristobal, and chiefly distinguished for its fine church and convent dedicated to San Domingo; Pichucalco

(8549), Tenejapa (7936), San Antonio (6715), Cintalape (6455), La Concordia (6291), San Carlos (5977), and Ocoingo (5667).

CHIAROSCURO (from the Ital. *chiaro*, light or brightness, and *oscuro*, darkness or shade), the disposition of light and shade in a painting; the term is applied to an early method of printing wood-engravings from several blocks, and also to a picture in black and white, or brown and white only.

CHIAVARI, a town of Liguria, Italy, in the province of Genoa, 24 m. S.E. by rail from the town of Genoa. Pop. (1901) 10,397 (town), 12,689 (commune). It is situated near the mouth of the Entella, in the centre of a fertile plain surrounded by mountains except on the S.W., where it comes down to the sea. Its buildings are mostly modern, but it has a ruined castle of 1147. It has an active trade in agricultural products, and manufactures lace, light wicker-seated bentwood chairs, silk, &c.

CHIAVENNA (anc. *Clavenna*), a town of Lombardy, Italy, in the province of Sondrio, 17 m. by rail N. of Colico which lies at the N. end of the lake of Como. Pop. (1901) town 3140, commune 4732. It is well situated on the right bank of the Mera, at the mouth of the Val Bregaglia, through which the road to the Maloja Pass and the Engadine runs to the east. This line was partly followed by a Roman road, which at Casaccia, just below the last ascent to the Maloja Pass, diverged to the N. by the Septimer Pass, joining the Julier route to Coire (anc. *Curia*) at Stalla. The Splügen route, which was also used by the Romans, runs N. from Chiavenna to Coire: the modern road was constructed by the Austrians in 1819-1821. Chiavenna is crowned by a ruined castle, once an important strategic point, and the seat of the counts who ruled the valley from the time of the Goths till 1194, when the district was handed over to the bishops of Coire. In the 14th century the Visconti, having become masters of the Valtellina, bought the "county" (*contado* or *contea*) of Chiavenna from the bishop of Coire; but it was taken by the canton of the Grisons in 1525, and the castle dismantled. In 1797 Chiavenna became part of the Cisalpine republic, and thenceforward followed the fortunes of Lombardy. The church of S. Lorenzo is baroque in style, but its baptistery contains a font of 1206 with reliefs. Chiavenna has cotton factories and breweries, and is a depot for the wine of the district.

CHIBOUQUE, or **CHIBOUK** (the Fr. form of the Turk. *chibük*, literally a stick), a long pipe, often ornamented with precious stones, smoked by the Turks.

CHIC (a French word, either a shortened form of *chicane*, or derived from the Ger. *Schick*, tact or skill), a term properly used, in French artistic slang, of a work of art possessing brilliant but superficial technical ability, or of one executed without reference to a model or study of nature. The use of the word in French dates from the reign of Louis XIV. and then denoted a lawyer who was master of "chicane." "Chic," in general use, now connotes "smartness," in dress, speech, &c.

CHICACOLE, a town of British India in the Ganjam district of Madras, situated on the right bank of the river Languliya, here crossed by a bridge, 4 m. from the sea. Pop. (1901) 18,196. Under Mahomedan rule it was the capital of one of the Northern Circars, and afterwards of a British district. Several old mosques remain. The town was famous for its muslins, but the industry is now decayed. The roadstead and lighthouse of Calingapatam are about 16 m. to the north, and the East Coast railway has a station 9 m. inland.

CHICAGO, a city, a port of entry and the county-seat of Cook county, Illinois, U.S.A., the second city of the United States in population, commerce and manufactures; pop. (1900) 1,698,575; and (1910) 2,185,283. It is situated at the south-west corner of Lake Michigan (lat. 41° 50', long. 87° 38' W.), about 913 m. distant by railway from New York, 912 m. from New Orleans, 2265 m. from Los Angeles, and 2330 m. from Seattle. The climate is very changeable and is much affected by the lake; changes of more than thirty degrees in temperature within 24 hours are not at all rare, and changes of twenty are common. The city is the greatest railway centre of the United States, and was for several decades practically the only commercial outlet of the great agricultural region of the northern Missis-

issippi Valley. Trunk lines reach E. to Montreal, Boston, New York, Philadelphia, Baltimore (the nearest point on the Atlantic coast, 854 m.); S. to Charleston, Savannah, Florida, Mobile, New Orleans, Port Arthur and Galveston; W. to the Pacific at Los Angeles, San Francisco, Seattle and Vancouver, and to most of these by a variety of routes. In 1905 about 14% of the world's railway mileage centred in Chicago.

With its suburbs Chicago stretches along the shore of Lake Michigan about 40 m. (the city proper 26.5), and the city in 1910 had a total area of 191.4 sq. m.¹ It spreads loosely and irregularly backward from the lake over a shallow alluvial basin, which is rimmed to the W. by a low moraine water-parting² that separates the drainage of the lake from that of the Mississippi Valley. The city site has been built up out of the "Lake Chicago" of glacial times, which exceeded in size Lake Michigan. Three lakes—Calumet, 3122 acres; Hyde; and part of Wolf—with a water-surface of some 4100 acres, lie within the municipal limits. The original elevation of what is now the business heart of the city was only about 7 ft. above the lake, but the level was greatly raised—in some places more than 10 ft.—over a large area, between 1855 and 1860. The West Side, especially in the north-west near Humboldt Park, is much higher (extreme 75 ft.). A narrow inlet from the lake, the Chicago river, runs W. from its shore about a mile, dividing then into a north and a south branch, which run respectively to the N.W. and the S.W., thus cutting the city into three divisions known as the North, the West and the South "Sides," which are united by three car-tunnels beneath the river as well as by the bridges across it.³ The river no longer empties into Lake Michigan since the completion of the drainage canal. Its commercial importance is very great: indeed it is probably the most important non-tidal stream of its length in the world, or if it be regarded as a harbour, one of the greatest; the tonnage of its yearly commerce far exceeds that of the Suez Canal and almost equals the tonnage of the foreign trade (the domestic excluded) of the Thames or the Mersey. The increase in size of the newer freighters that ply on the Great Lakes⁴ has proved one serious difficulty, and the bridges and the river tunnels, which hinder the deeper cutting of the channel, are others. The improvement of the outer harbour by the national government was begun in 1833. Great breakwaters protect the river mouth from the silting shore currents of the lake and afford secure shelter in an outer roadstead from its storms, and there is a smaller inner-basin (about 450 acres, 16 ft. depth) as well. But the river itself which has about 15 m. of navigable channel, in part lined with docks, is the most important part of the harbour. Its channel has been repeatedly deepened, and in recent years—especially since 1896, after its control as a navigable stream passed (1890) to the federal government—widened and straightened by the removal of jutting building constructions along its shores. Grain elevators of enormous size, coal yards, lumber yards and grimy warehouses or factories crowd close upon it. The shipping facilities on the river are not so good in some ways, however, as on the Calumet in southeastern (or South) Chicago, whither there has been a strong movement of manufactures and heavy commerce.

The plan of the city is in general "regular," i.e. rigidly rectangular, and the streets are in general wide. The evenness of the plain has saved Chicago from most of the vast expense incurred by some American cities (notably Boston and San Francisco) in the extension or levelling of their sites and the removal of obstructions unfavourable to their development. The business district is concentrated in a small area of the South Side, just below the main river and between the south branch and the lake. A number of the railway terminals, almost all the great wholesale and retail houses, the leading hotels and

¹ In 1889 the total area (land and water) was increased from 43.8 to 169.9 sq. m.; in 1890 the land area was 163.49 sq. m.

² About 15 ft. in elevation; hence the possibility of the drainage canal.

³ Among the last are many swing and "jack-knife" bridges, bascules, and a lift-bridge that can be lifted bodily 155 ft. above the channel. Steam, compressed air and electricity are used as power.

⁴ By 1900 almost all were being built of a length exceeding 400 ft.

public buildings are crowded within an area of about 1.5 sq. m. The congestion of the streets—considerably lessened since the freight-subways have reduced the amount of heavy trucking—is proportionately great, and their din and crush is characteristic of the city. The residential districts, on the other hand, are unevenly and loosely spread; many areas well within the city are only sparsely settled. A belt of "bad lands"—occupied by factories, shanties, &c.—partially surrounds the best business district. The smoke resulting from the use of soft coal has given a drab and dingy colour-tone to the buildings. The low and even relief of the site and the long vistas of the streets do not lend themselves to the picturesque; yet this quality may be claimed for the high and broken skyline, varied colour, massiveness, bustle and impressive commercialism of the business district. Chicago is generally credited with being the original home of the steel-frame "sky-scraper,"¹ though there are now higher buildings elsewhere in America. The unstable soil of sand, clay and boulders that underlies the city is unfavourable to tall constructions, and necessitates extraordinary attention to foundations. The bed-rock lies, on an average, 50 ft. below the level of the lake (in places more than a hundred). To the rock the foundations are often sunk in caissons, the buildings resting on monster columns of concrete and steel.² In other cases great "pads" of the same materials, resting or "floating" upon the clay, sustain and distribute the weight of the building. The small extent of the business quarter adds to the effect of its tall structures. The Auditorium (1889; cost, \$3,500,000), a huge building containing a hotel and a theatre (5000 seats), is one of the most massive commercial structures of the country. The Masonic Temple (cost, \$3,000,000) is the tallest in the city (302 ft.). In 1909 there were some 475 structures ten or more storeys high. Not a few are noteworthy, whether for size—as the Monadnock office building of 16 storeys, with some 6000 occupants, and the new Northwestern Railway station; or for the luxury of their interior fittings—as the La Salle, Blackstone and Sherman hotels; or for boldness and originality in the treatment of the steel-frame type, or for association with the city's life—as the Fine Arts building, given over to varied purposes of public amusement and artistic or intellectual improvement, or the Railway Exchange (cased in tiles), the University Club, the Chamber of Commerce and the Board of Trade; and many others are handsome and dignified examples of architecture. The Marquette building, consistently and handsomely decorated with works of art, is one of the finest office-buildings in the country. There are a number of enormous retail stores. The largest, and one of the finest in the world, is that of Marshall Field. The wholesale establishment of the same firm is the work of H. H. Richardson, considered one of his best, and one of the most admirable examples among American commercial buildings. The city hall and county court house (cost, \$4,500,000) is an enormous double building in a free French Renaissance style, with columned facades. The new Federal building (finished in 1905; cost, \$4,750,000) is a massive edifice (a low rectangle surmounted by a higher inner cross and crowned with a dome). The public library (1893-1897, \$2,125,000), constructed of dark granite and limestone, with rich interior decorations of varied frescoes, mosaics, ornamental bronze and iron-work, and mottoes, is one of the handsomest libraries of the country. The Chicago Art Institute (1892-1893, Italian Renaissance), the Chicago Orchestra building (1904), and the Commercial National Bank, are also noteworthy. The finest residence streets are the Lake Shore Drive of the North Side and the "boulevards"—broad parkways that connect the parks of the city—of which Michigan Avenue, Drexel and Grand are the finest. The city's

¹ The highest value ever paid in Chicago for land actually sold, up to 1901, was \$250 per sq. ft. (1892); a few rental contracts have been based upon an assumed higher value. A municipal ordinance placing the extreme construction at 150 ft. was repealed in 1902.

² This is true of all the new large buildings. The "old" post office, completed in 1880 at a cost of \$5,375,000, was practically a crumbling ruin within fifteen years; its foundations were inadequate. Years were spent in sinking the foundation of the new Federal building that replaced the old.

environs are not of particular beauty, but there are bluffs on the lake to the north, and woods to the south-west, and a fair variety of pretty hill and plain; and though the Calumet and Chicago rivers have been given over to commerce, the valley of the Desplaines will be preserved in the park system. On the South Side are the Union Stockyards, established in 1865, by far the largest in the world. They cover about 500 acres, have about 45 m. of feeding and watering troughs, and can accommodate at one time more than 400,000 hogs, cattle, sheep and horses.

Public Works and Communications.—Local transit is provided for by the suburban service of the steam railways, elevated electric roads, and a system of electric surface cars. Two great public works demand notice: the water system and the drainage canal. Water is pumped from Lake Michigan through several tunnels connecting with "cribs" located from 2 to 5 m. from shore. The "cribs" are heavy structures of timber and iron loaded with stone and enclosing the in-take cylinders, which join with the tunnels well below the bottom of the lake. The first tunnel was completed in 1867. The capacity of the tunnels was estimated in 1900 by two very competent authorities at 528 and 615 million gallons daily, respectively. The average daily supply in 1909 was 475,000,000 gallons; there were then 16.6 m. of tunnels below the lake. The wastes of the city—street washings, building sewage, the offal of slaughter-houses, and wastes of distilleries and rendering houses—were originally turned into the lake, but before 1870 it was discovered that the range of impurity extended already a mile into the lake, half-way to the water "crib," and it became evident that the lake could not be indefinitely contaminated. The Illinois and Michigan Canal, for which the right of way was granted in 1821 and which was built in 1836-1841 and 1845-1848, and opened in 1848 (cost, \$6,557,681), was once thought to have solved the difficulty; it is connected with the main (southern) branch of the Chicago river, 5 m. from its mouth, with the Illinois river at La Salle, the head of steamer navigation on the Illinois river, and is the natural successor in the evolution of transportation of the old Chicago portage, $\frac{1}{2}$ m. in length, between the Chicago river and the headwaters of the Kankakee; it was so deepened as to draw water out from the lake, whose waters thus flowed toward the Gulf of Mexico. It is about 96 m. long, 40-42 ft. wide, and 4-7 ft. deep, but proved inadequate for the disposal of sewage. A solution of the problem was imperative by 1876, but almost all the wastes of the city continued nevertheless to be poured into the lake. In 1890 a sanitary district, including part of the city and certain suburban areas to be affected, was organized, and preparations made for building a greater canal that should do effectively the work it was once thought the old canal could do. The new drainage canal, one of the greatest sanitary works of the world, constructed between 1892 and 1900 under the control of the trustees of the Sanitary District of Chicago (cost up to 1901, \$35,448,291), joins the south branch of the Chicago with the Desplaines river, and so with the Illinois and Mississippi, and is 28.5 m. long,³ of which 15 m. were cut through rock; it is 22 ft. deep and has a minimum width of 164 ft. The canal, or sewer, is flushed with water from Lake Michigan, and its waters are pure within a flow of 150 m.⁴ Its capacity, which was not at first fully utilized, is 600,000 cub. ft. per minute, sufficient entirely to renew the water of the Chicago river daily. A system of intercepting sewers to withdraw drainage into the lake was begun in 1898; and the construction of a canal to drain the Calumet region was begun in 1910. The Illinois and Michigan canal is used by small craft, and the new drainage canal also may be used for shipping in view of the Federal government's improvements of the rivers connecting it with the Mississippi for the construction of a ship-canal for large vessels. The canal also made possible the development (begun in 1903) of enormous

³ Total excavation, 42,397,904 cub. yds.; of solid rock, 12,265,000.

⁴ It has been conclusively proved that the Illinois is purer than the Mississippi at their junction. The undiluted sewage of the old canal drove the fish from the river, but they have come back since the opening of the new canal.

hydraulic power for the use of the city. The Illinois and Michigan Canal has been supplemented by the Illinois and Mississippi Canal, commonly known as "the Hennepin," from its starting at the great bend of the Illinois river $1\frac{3}{4}$ m. above Hennepin, not far below La Salle; the first appropriation for it was made in 1890, and work was begun in 1892 and completed in October 1907. Its course from Hennepin is by the Bureau Creek valley to the mouth of Queen river on the Rock river, thence by the Rock river and a canal around its rapids at Milan to its mouth at Rock Island on the Mississippi river. This barge canal is 80 ft. wide at water-line, 52 ft. wide at the bottom, and 7 ft. deep. Its main feeder is the Rock river, dammed by a dam nearly 1500 ft. long between Sterling and Rock Falls, Illinois, where the opening of the canal was celebrated on the 24th of October 1907.

Beginning with 1892 steam railways began the elevation (or depression) of their main tracks, of which there were in 1904 some 838 m. within the city. Another great improvement was begun in 1901 by a private telephone company. This is an elaborate system of freight subways, more than 65 m. of which, underlying the entire business district, had been constructed before 1909. It is the only subway system in the world that seeks to clear the streets by the lessening of trucking, in place of devoting itself to the transportation of passengers. Direct connexion is made with the freight stations of all railways and the basements of important business buildings, and coal, building materials, ashes and garbage, railway luggage, heavy mail and other kinds of heavy freight are expeditiously removed and delivered. Telegraph and telephone wires are carried through the tunnel, and can be readily repaired. The subway was opened for partial operation in 1905.¹

Parks.—The park system may be said to have been begun in 1869, and in 1870 aggregated 1887 acres. Chicago then acquired the name of "The Garden City," which still clings to her. But many other cities have later passed her (until in 1904, though the second largest of the country, she ranked only thirty-second in her holdings of park area per capita among American cities of 100,000 population). In 1908 the acreage of the municipal parks was 3179 acres, and there were 61.4 m. of boulevards. After 1900 another period of ambitious development began. The improvement of old and the creation of new "internal" parks, *i.e.* within the cordon of those older parks and boulevards that once girdled the city but have been surrounded in its later growth; the creation of a huge metropolitan ring—similar to that of Boston but vaster (35,000 acres)—of lake bluffs, hills, meadows, forests and river valley; and a great increase of "neighbourhood parks" in the poor districts, are included in the new undertakings. The neighbourhood park, usually located near a school, is almost all-inclusive in its provision for all comers, from babyhood to maturity, and is open all day. There are sand gardens and wading ponds and swings and day nurseries, gymnasiums, athletic fields, swimming pools and baths, reading-rooms—generally with branches of the city library—lunch counters, civic club rooms, frequent music, assembly halls for theatricals, lectures, concerts, or meetings, penny savings banks, and in the winter skating ponds. These social centres have practically all been created since about 1895. There are also municipal baths on the lake front and elsewhere. The older parks include several of great size and beauty. Lincoln Park (area 552 acres), on the lake shore of the North Side, has been much enlarged by an addition reclaimed from the lake. It has fine monuments, conservatories, the only zoological garden in the city, and the collections of the Academy of Sciences. A breakwater carriage drive connects with a boulevard to Fort Sheridan (27 m.) up the lake. Jackson Park (542 acres), on the lake shore of the South Side, was the main site of the World's

¹ The cut was almost entirely through firm clay. It was estimated (1905) that the total freight handled weekly in the business district was nearly 500,000 tons, and the subway was designed to handle this amount when completed. The tunnels are 12.75×14 and 7.5×6 ft., all concrete. The cars are drawn by trolley wire locomotives on a track of 2 ft. gauge.

Columbian Exposition of 1893, and contains the Field Columbian Museum, occupying the art building of the exposition. It is joined with Washington Park (371 acres) by the Midway Plaisance, a wide boulevard, intended to be converted into a magnificent sunken water-course connecting the lagoons of the two parks with Lake Michigan. Along the Midway are the grey-stone buildings of the University of Chicago, and of its (Blaine) School of Education. On the West Side are three fine parks—Douglas, Garfield (with a fine conservatory), and Humboldt, which has a remarkable rose garden (respectively 182, 187 and 206 acres), and in the extreme South Side several others, including Calumet (66 acres), by the lake side, and Marquette (322 acres). Jackson Boulevard, Western Avenue Boulevard and Marshall Boulevard join the South and the West Park systems. Neither New York nor Boston has preserved as has Chicago the beauty of its water front. The shore of the North Side is quite free, and beginning a short distance above the river is skirted for almost 30 m. by the Lake Shore Drive, Lincoln Park and the Sheridan Drive. The shore of the South Side is occupied by railway tracks, but they have been sunk and the shore otherwise improved. In addition to Calumet and Jackson parks there was another just below the river, Lake Park, which has since been included in Grant Park, mostly reclaimed from the water. Here are the public library and the building of the Art Institute (opened in 1893); the park had also been proposed as the site of a new building for the Field Museum of Natural History. The park and boulevards along the lake in 1905 stretched 10.78 m., within the city limits, or almost half the total frontage.² The inner "boulevards" are broad parked ways, 150 to 300 ft. wide, joining the parks; Chicago was the first American city to adopt this system.

Art.—Among the monuments erected in public places are a Columbian by D. C. French and a bronze replica of French's equestrian statue of Washington in Paris; statues of John A. Logan and Abraham Lincoln by St Gaudens; monuments commemorating the Haymarket riot and the Fort Dearborn massacres; statues of General Grant, Stephen A. Douglas, La Salle, Schiller, Humboldt, Beethoven and Linnaeus. There is also a memorial to G. B. Armstrong (1822–1871), a citizen of Chicago, who founded the railway mail service of the United States. A city art commission approves all works of art before they become the property of the city, and at the request of the mayor acts in various ways for the city's aesthetic betterment. The Architectural Club labours for the same end. A Municipal Art League (organized in 1899) has done good work in arousing civic pride; it has undertaken, among other things, campaigns against bill-board advertisements,³ and against the smoke nuisance.

The Art Institute of Chicago contains valuable collections of paintings, reproductions of bronzes and sculpture, architectural casts, and other objects of art. Connected with it is the largest and most comprehensive art school of the county—including newspaper illustration and a normal school for the training of teachers of drawing in the public schools. The institute was incorporated in 1879, though its beginnings go back to 1866, while the school dates from 1878. The courses in architecture are given with the co-operation of the Armour Institute of Technology. There are also a number of notable private art collections in the city. In 1894 the Chicago Public School Art Society was founded to secure the placing of good works of art in the public schools. Picture collections are also exchanged among the neighbourhood-park homes.

Music in Chicago owes much to the German element of the population. Especially noteworthy among musical organizations

² The Illinois Central enters the business centre by tracks laid along the lake shore. Certain rights as to reclaiming land were granted it in 1852, but the railway extended its claims indefinitely to whatever land it might reclaim. In 1883 began a great legal struggle to determine the respective rights of the United States, the state of Illinois, Chicago, and the Illinois Central in the reclaimed lands and the submerged lands adjacent. The outcome was favourable to the city.

³ There were 50 m. of them in 1904.

are the Apollo Musical Club (1872) and The Theodore Thomas orchestra, which has disputed with the Boston Orchestra the claim to artistic primacy in the United States. Its leader from its organization in 1891 until his death in 1905 was Theodore Thomas, who had long been identified with summer orchestral concerts in the city. In 1904 a fund was gathered by public subscription to erect a handsome building and endow the orchestra.

The Field Museum of Natural History, established (1894) largely by Marshall Field, is mainly devoted to anthropology and natural history. The nucleus of its great collection was formed by various exhibits of the Columbian Exposition which were presented to it. Its collections of American ethnology, of exceptional richness and value, are constantly augmented by research expeditions. In addition to an original endowment of \$1,000,000, Mr Field bequeathed to the museum \$8,000,000, to be utilized in part for the new building which is being erected in Jackson Park.

Libraries.—At the head of the libraries of the city stands the public library¹ (established 1872; opened 1874), supported by taxation, which on the 1st of June 1910 had 402,848 volumes, and in the year 1910 circulated 1,805,012 volumes. In 1839 John Crerar (1827-1889), a wealthy manufacturer of railroad supplies, left to the city for the endowment of a non-circulating library funds which in 1907 were estimated to amount to \$3,400,000. The library was incorporated in 1894 and was opened in 1897; in February 1908 it had 216,000 volumes and 60,000 pamphlets. It occupies a floor in the Marshall Field Building on Wabash Avenue. Another reference library was established (opened in 1887) with a bequest (1868) of Walter L. Newberry. It has a rich endowment, and in February 1908 had 191,644 volumes and 43,644 pamphlets. By a plan of co-operation each of these three libraries devotes itself primarily to special fields: the John Crerar is best for the natural, physical and social sciences; the Newberry is particularly strong in history, music, medicine, rare books and fine editions; the public library covers the whole range of general literature. The library of the University of Chicago contained in 1908 some 450,000 titles. Among other collections are those of the Chicago Historical Society (1856; about 150,000 titles in 1908), the Athenaeum (1871); the Law Institute and Library (1857), which in 1908 had about 46,500 volumes; the Art Institute, the Field Museum of Natural History, the Academy of Sciences (1857) and the libraries of various schools.

Universities and Colleges.—There are three universities situated wholly or in part in the city. The leading institution is the University of Chicago (see CHICAGO, UNIVERSITY OF). The professional department of North-Western University is in Chicago, while its academic department is in the suburb of Evanston. North-Western University was organized in 1851 and is under Methodist Episcopal control. Its students in 1908 (exclusive of pupils in "co-operating" theological schools) numbered 3850; the best equipped departments are those of dentistry, medicine and pharmacy. There are two Roman Catholic colleges in Chicago: Loyola University (chartered in 1870), with a department of law, called Lincoln College (1908), and a medical department; and St. Stanislaus College (1870). The College of Physicians and Surgeons is the medical department of the University of Illinois, at Champaign-Urbana. Theological schools independent of the universities include the McCormick Theological Seminary (Presbyterian); the Chicago Theological Seminary (Congregational, opened 1853, and including German, Danish-Norwegian and Swedish Institutes); the Western Episcopal Theological Seminary; a German Lutheran theological seminary, and an Evangelical Lutheran theological seminary. There are a number of independent medical schools and schools of dentistry and veterinary surgery. The Lewis Institute (bequest 1877, opened 1896), designed to give a practical education to boys and girls at a nominal cost, and the Armour Institute of

Technology, one of the best technical schools of the country, provide technical education and are well endowed. The Armour Institute was founded in 1892 by Philip D. Armour, and was opened in 1893. It comprises the College of Engineering, including, besides the usual departments, a department of chemical engineering and a department of fire protection engineering, a department of "commercial tests," and the Armour Scientific Academy (preparatory). In 1907 the Institute had 1869 students. The Chicago Academy of Science (1857) has a handsome building and museum collections in Lincoln Park.

The leading daily newspapers are the *Record-Herald*, *Evening Post*, *News* (evening) and *Journal* (evening), all Independent; the *Inter-Ocean* and *Tribune*, Republican; and the *Evening American* and *Examiner*, both Democratic. There are several journals in German, Bohemian, Polish, Swedish, Norwegian and Danish. Many trade papers are published in the city, which is also a centre for much of the religious publishing of the Middle West. Chicago's position in the labour world has made it the home of several socialist and anarchistic periodicals.

Industry and Commerce.—Chicago's situation at the head of the most south-western of the Great Lakes has given it great importance in trade and industry. The development of its extraordinary railway facilities was a recognition of its supreme advantages as the easiest outlet for the products of the Middle West, on whose wealth its prosperity is founded. The growth of its trade has been marvellous. The last years of the 19th century showed, however, an inevitable loss to Chicago in the growth of Duluth, Kansas City and other rivals in strategic situations. In particular, the struggle of the North and South railway lines in the Mississippi Valley to divert to ports on the Gulf of Mexico grain and other freight caused great losses to Chicago. An enormous increase in the cereal trade of Philadelphia, Baltimore, Newport News and Norfolk was partly due to the traffic eastward over lines S. of Chicago. The traffic of the routes through Duluth and Canada does not, indeed, represent in the main actual losses, for the traffic is largely a new growth; but there has been nevertheless a considerable drain to these routes from American territory once tributary to Chicago. Altogether the competition of the Gulf roads and the lines running S.W. from Duluth had largely excluded Chicago by 1899 (according to her Board of Trade) from the grain trade W. of the Missouri river, and in conjunction with southerly E. and W. routes had made serious inroads upon trade E. of that river. Its facilities for receiving and distributing remain nevertheless unequalled, and it still practically monopolizes the traffic between the northern Atlantic seaboard and the West. New York alone, among American cities, has a greater trade. Chicago is the greatest railway centre, the greatest grain market, the greatest live-stock market and meat-packing centre, and the greatest lumbe market of the world. The clearings of her associated banks amounted to \$13,781,843,612 in the year 1909. The wholesale trade was estimated in 1875 at \$293,900,000 and in 1905 at \$1,781,000,000. The average annual grain receipts (including flour in wheat equivalent) in the five years 1900-1904 amounted to 265,500,000 bu. (12,902,310 in 1854; 72,369,194 in 1875), and the shipments to 209,862,966 bu. The first shipment of wheat was of 78 bu. in 1838. The grain elevators are among the sights of Chicago. They are enormous storehouses into which the grain is elevated from ships and cars, sorted into grades and reloaded for shipment; all the work is done by machinery. Their capacity in 1904 was 65,140,000 bu.² In the same quinquennial period, 1900-1904, the average yearly receipts of lumber aggregated 1,807,066,000 ft.,³ and of shingles, 410,711 thousand; of cattle, 3,078,734; of hogs, 8,334,904; of sheep, 3,338,291; of butter, 239,696,921 lb; the exports of hides, 167,442,077 lb; of dressed beef, 1,126,995,490 lb; of

² In 1900-1904 the average freight rate per bushel of wheat to New York was \$0.04998 by the all-water; \$0.10554 by the all-rail route. In 1859 it cost \$0.1575 to send a bushel of corn to Buffalo by water; in 1890, \$0.019.

³ It has been above 1,000,000,000 ft. since 1870, and has in some years risen to 2,000,000,000.

¹ Thomas Hughes was a leader in gathering English gifts for such a library immediately after the "great fire." A nucleus of 10,500 volumes—7000 from England and 3500 from other countries, especially Germany—was thus secured.

lard, 410,688,319 lb; of pork, 191,371 bbl.; of other hog products, 690,503,394 lb. The combined tonnage in and out averaged 14,135,406 tons.¹ There is a large direct trade with Europe, mainly in goods that come in bond by rail from Atlantic ports. In 1907 the value of Chicago's imports was \$27,058,662, and of its exports, \$5,643,302.

The value of manufactures (from establishments under the "factory system") in 1900 was \$797,879,141, 71.2% of all those of Illinois, and in 1905 was \$955,036,277, 67.7% of all those of the state; in both these years Chicago was second only to New York City. Wholesale slaughtering and meat-packing (not including many by-products), valued at \$256,527,949 (32.2% of the city's total) in 1900 and at \$269,581,486 (28.2% of the total) in 1905, are the most important of the city's industries; in 1905 the product value in Chicago was 29.5% of that for the slaughtering and meat-packing of the entire United States. Other important manufactures are foundry and machine shop products, \$44,561,071 in 1900, and \$51,774,695 in 1905; and other iron and steel products, \$35,058,700 in 1900 and \$27,074,307 in 1905; clothing (\$58,093,572 in 1900, and \$64,913,481 in 1905); cars and other railway construction, \$28,369,956 in 1900 and \$36,080,210 in 1905; malt liquors (\$14,956,865 in 1900, and \$16,983,421 in 1905), and furniture (\$12,344,510 in 1900 and \$17,488,257 in 1905). The Illinois Steel Company has the largest rolling mills in the world. The McCormick Harvesting Machine Company is the largest concern in the world manufacturing agricultural implements. Pullman in southern Chicago, in the sparsely settled outskirts of the city, is a model little "labour town," planned and constructed with regard for both appearances and conveniences by the Pullman Palace Car Company, which has its works here. The town consists mainly of workmen's cottages. Most of the population are dependent upon the car works. The Pullman Company owns and operates dining and sleeping cars on practically all the railways of the country. In addition to its own cars it builds ordinary passenger and freight cars on contract.

Meat-packing is the greatest local industry and is that for which Chicago is best known. In the enormous stock-yards from two-thirds to four-fifths of the cattle and hogs received are killed, and sent out in various forms of prepared meats and by-products (lard, fertilizers, glue, butterine, soap, candles, &c.).² This industry is remarkable for the extraordinary division of labour in its processes. In the preparation of a bullock more than thirty specialties are involved, and some twenty different rates of pay. This system enabled the packing companies, until checked by the development of labour unions, to save money not only by paying low wages for crude labour and high for skilled, but to develop wonderful expertness in every line, and so "speed up" the workmen to a remarkable pace.³ No more interesting field can be found for the study of the qualities of foreign races. The introduction of the refrigerator railway car in the 'seventies of the 19th century, making possible the distant marketing of dressed meats, enormously increased the business. The workmen of the yards were organized in a national union of meat packers in 1897, and all the different classes of workmen have their separate organizations, formed mainly between 1900 and 1902. The number of women employed more than doubled in the decade 1891-1900, constituting probably about 9% of the total in the latter year.

Administration.—Chicago is governed under a general city-charter law of Illinois of 1870, accepted by the city in 1875. In November 1904 the people of Illinois adopted a constitutional amendment authorizing the legislature of the state to provide a

¹ This is for the entire Chicago customs district, including Waukegan and Michigan City.

² The number of hogs packed yearly averaged 7,255,245 in 1900-1904; the cattle packed, 1,955,765; the sheep shipped (partly live), 616,476 (one-fifth those received).

³ e.g. in the most skilled labour, the speed was increased 87.5% from 1884-1894. In 1905 a gang of 230 men would dispose of 105 animals hourly; equivalent to 131 minutes for one man in taking the animal from pen to refrigerator; the average wage was \$0.21 per hour (highest 0.50) and the average cost per bullock, \$0.46.

complete new system of local government for Chicago, but the old system continued and is here described, the new charter, from which so much had been hoped, being rejected by the voters of the city by an overwhelming majority in September 1907. A common council chosen by wards and renewed in half each year controls the budget, police, liquor licences, city contracts and the granting of franchises; it also confirms appointments made by the mayor and by a vote of two-thirds may pass legislation over his veto. The mayor, chosen for four years, is the executive head of the city, and has large power of appointment and removal, limited by a civil service law, under which he must submit reasons for removals, while two-thirds of the council may prevent them. On the other hand the mayor can veto separate items in the council's budget. The administrative departments are generally headed by single commissioners; but those of elections, education and the public library are exceptions. The council was once all important, but as early as the charter of 1851 it began to lose power to the mayor, whose directive and executive powers have steadily increased, beginning first in the financial department. Administration was once performed entirely by boards as in other American cities: every specific problem or demand for municipal activity was met by an appeal to the state legislature for special legislation and the creation of a board. The substitution of single commissioners began in 1876. The state constitution of 1870 forbade special legislation, prescribed a general city charter law and forbade special amendatory acts for Chicago. This stopped grave abuses, but because a large part of the state has not been interested in Chicago's special needs and demands for betterment it also saddled upon the city an organization which in 1901 remained practically the same as in 1870, when Chicago was an overgrown town of 300,000 inhabitants. Chicago was the only large city of the state, and a charter generalized from village experience was unsuitable for it. The parts of Cook county outside the city have also been very jealous of forwarding its reorganization, important features of which must be either the complete absorption of the county or at least the reconstitution of the county government,⁴ which the constitution left unchanged, and which, with the city's growth, has caused clash of interests and authority. Nor is this dual government—though the city has above nine-tenths of the population and pays nine-tenths of the taxes of the county—the only anomaly. Illinois has had since 1848 a modified New England "township" local-government system, and various townships have been absorbed by Chicago, yet they all retained till after 1900 their political structure and some of their functions. There are three park commissions, two appointed by the governor and one by circuit court judges, created for different parts of the old city, differently constituted and all independent of the city; their jurisdiction was not enlarged as the city grew, so large portions remained free of charges for parks and boulevards. A special park commission now supplements them and lessens this anomaly though increasing administrative diversity. A sanitary and drainage district, not larger than the city area but quite different from it, was created in 1886 (present form 1890) to carry through the drainage canal. The school board has been nominally separate from and almost independent of the city government in power since 1857. The courts of law are courts of the state of Illinois, but a certain number of justices of the peace are designated by the mayor to act as police magistrates. The initiative and referendum in local matters has been made possible under a state law, and has been several times exercised in important questions. Financial arrangements have been loose and inefficient. Independent taxing power has been lavishly granted. State, county, city, three park boards, the school board, the public library board, the drainage board, and as late as 1903 ten townships,⁵ exercised this sovereign right within the municipal area. Tax assessment

⁴ Cook county is Republican in politics generally, the rural districts being so strongly so as often to overbalance the normal Democratic plurality in Chicago. Thus another ground of jealousy is found in the distribution of county offices.

⁵ An amendment of 1904 provided that the legislature should enact the consolidation of the townships with the city in matters of taxation, but no further steps had been taken to the end of 1907.

valuations have been excessively irregular (e.g. the "equalized" value for 1875 was \$55,000,000 greater than that for 1892), and apparently very low. The average assessment valuation for the years from 1904 to 1908 was \$438,729,897 (403.28 millions in 1904, and 477.19 millions in 1908), and in 1907 the highest taxing rate was 8%. The bonded debt in 1908 was \$25,157,400, about half of it old (\$11,362,726 in 1870; 4.5 millions contracted to aid the World's Fair of 1893). In the early years following 1900 the city paid more than half of its income on police; this expenditure, per capita of population, was not high (in 1901 Boston \$5.03, New York \$3.21, Chicago \$2.19), and the results were not exactly efficient. The difficulty is that the city is poor and can pay only for strict necessities. Its poverty is due mainly to state laws. The taxation limit on property is 1% on the cash value, thus compelling special dependence upon all sorts of indirect taxes; the debt limit is 5% on the assessed valuation. Since 1900 relief has been given by state law in some matters, such as for the park system. The water system has been operated by the city since 1851, and has been financially very successful from the beginning: rates are far lower than in the other great cities of the country, and a handsome net revenue accrues to the treasury.¹ A municipal electric-lighting plant (1887), which was paid for gradually out of the general tax levy and was not built by the sale of bonds, gave excellent results in the city service. The city, like the state, has power to regulate the price of gas sold by private companies. The elevation of the railway tracks within the city was begun in 1892; at the close of 1908 the railway companies had accepted ordinances of the City Council for the elevation of 192.77 m. of main tracks and 947.91 m. of all tracks, and the construction of 724 subways, at an estimated cost of \$65,000,000; at that time the railway companies had completed the elevation of 133.83 m. of main tracks and 776 m. of all tracks, and had constructed 567 subways, at a total expense of \$52,500,000. The system of intercepting sewers begun in 1898 to complete the service of the drainage canal has been constructed with the profits of the water system.

In addition to the movement for a new charter to remove the anomalies and ease the difficulties already referred to, two great problems have been in the forefront in recent years: the lessening of municipal corruption and the control of local transit agencies.

The traction question may be said to have begun in 1865, in which year, and again in 1883, public opinion was bitterly aroused against an attempt of the traction companies to secure a ninety-nine year extension of franchises. Following 1883 all lines were consolidated and enormously over-capitalized (in 1905 about \$150,000,000 of stocks and bonds on a 6% basis, two-thirds of which rested only on the franchise). In 1895-1897 bold attempts to secure a 50-year extension of franchises were defeated by Governor John P. Altgeld (1847-1902), by the formation of a Municipal Voters' League, and by a representative committee of 100 sent from Chicago to attend the legislature at Springfield. The transit service of the city had for years been antiquated and inadequate. At the mayor's elections in 1897, 1899, 1901 and 1903 the victory lay with the opponents of the companies, and in 1905 the successful party stood for immediate municipal acquisition of all roads. Meanwhile, under the state referendum act, the city in 1902 voted overwhelmingly for municipal ownership and operation (142,826 to 27,990); the legislature in 1903 by the Mueller law gave the city the requisite powers; the people accepted the law, again declared for municipal ownership, and for temporary compulsion of adequate service, and against granting any franchise to any company, by four additional votes similarly conclusive. At last, after tedious negotiations, a definite agreement was reached in 1906 assuring an early acquisition of all roads by the city. The issue of bonds for municipal railways was, however, declared unconstitutional that year; and at the municipal elections of 1907 there was a complete reversal of policy; a large majority voted this time against municipal ownership in favour of leaving the working of the street railways in private hands, and strengthening the powers of municipal control.

¹ The net revenue per million gallons in 1890-1899 was \$35.04.

The active campaign for the improvement of municipal service and politics may be said to have begun in 1896. A civil service system was inaugurated in 1895. The salaries of the councilmen were raised with good effect. Numerous reform associations were started to rouse public opinion, such as the Citizens' Association of Chicago, organized in 1874, the Civic Federation (1894), the Municipal Voters' League (1896), the Legislative Voters' League (1901), the Municipal Lecture Association (1902), the Referendum League of Illinois (1901), the Civil Service Reform Association of Chicago, the Civil Service Reform Association of Illinois (1902), the Merchants' Club, the City Club (1903), the Law and Order League (1904), Society of Social Hygiene (1906), and many of the women's clubs took an active part. They stood for the real enforcement of the laws, sanitation, pure food, public health, the improvement of the schools and the widening of their social influence, and (here especially the women's clubs) aesthetic, social and moral progress. The Merchants' Club reformed the city's book-keeping, and secured the establishment (1899) of the first state pawnbrokers' society. The Civic Federation demonstrated (1896) that it could clean the central streets for slightly over half what the city was paying (the city has since saved the difference); it originated the movement for vacation schools and other educational advances, and started the Committee of One Hundred (1897), from which sprang various other reform clubs. The Municipal Voters' League investigated and published the records of candidates for the city council, and recommended their election or defeat as the case may be. Moreover, a "Municipal Museum" was organized in 1905, mainly supported by private aid, but in part by the board of education, in order to collect and make educational use of materials illustrating municipal administration and conditions, physical and social.

Education and Charity.—The school board is appointed by the mayor. Since 1904 a merit system has been applied in the advancement of teachers; civil service rules cover the rest of the employees. Kindergartens were maintained without legal sanction in connexion with the public schools for several years, and for more than twenty-five years as private schools, before their legal establishment as a part of the system in 1899. Free evening schools, very practical in their courses, are utilized mainly by foreigners. Vacation schools were begun in 1896. So far as possible the school buildings are kept open for school, lectures and entertainments, serving thus as wholesome social centres; and a more adequate use is made of the large investment (in 1908 about \$44,500,000) which they represent. In all the public schools manual training, household arts and economy, and commercial studies are a regular part of the curriculum. A department of scientific pedagogy and child study (1900) seeks to secure a development of the school system in harmony with the results of scientific study of children (the combination of hand and brain training, the use of audito-visual methods, an elastic curriculum during the adolescent period, &c.). The expenditure for all purposes by the city in 1903 for every dollar expended for schools was only \$1.713; a ratio paralleled in only a few cities of the country.

Hospitals, infirmaries, dispensaries, asylums, shelters and homes for the defective, destitute, orphaned, aged, erring, friendless and incurably diseased; various relief societies, and associations that sift the good from the bad among the mendicant, the economically inefficient, and the viciously pauper, represent the charity work of the city. Among public institutions are the Cook County hospital (situated in the "Medical District" of the West Side, where various hospitals and schools are gathered near together), asylum and poor house. Since 1883 a Lincoln Park Sanitarium has been maintained for infants and small children during warm weather. Two legal-aid societies, the Chicago Bureau of Justice (1888) and the Protective Agency for Women and Children, collect small wage claims and otherwise aid the poor or helpless. The most important charitable societies of the city are the United Charities of Chicago (1909), the United Hebrew Charities (1857), and the Associated Jewish Charities (1900). The first is the union of the Relief and Aid Society (1857) and the Bureau of Charities (1894),

and tries to prevent overlapping of efforts and to weed out fraud. Following the gradual development of New York state laws on behalf of children was enacted the Illinois Juvenile Court Law, which came into force on the 1st of July 1899 and was largely the result of Chicago's interest in juvenile reform. Much philanthropic work centres in the West Side with its heterogeneous population. A famous institution is Hull House, a social settlement of women, which aims to be a social, charitable, and educational neighbourhood centre. It was established in 1889 by Miss Jane Addams, who became the head-worker, and Miss Ellen Gates Starr. It includes an art building, a free kindergarten, a fine gymnasium, a crèche, and a diet kitchen; and supports classes, lectures and concerts. It has had a very great influence throughout the United States. The Armour mission (1886) for the poor is organized with similar breadth of scope.

Population.—Of the total population in 1900 not less than 34.6% were foreign-born; the number of persons either born abroad, or born in the United States of foreign parentage (*i.e.* father or both parents foreign), was 77.4% of the population, and in the total number of males of voting age the foreign-born predominated (53.4%). Of the latter category 68.2% were already citizens by naturalization. 3.9% of the inhabitants of ten years of age or upward were illiterate (unable to write), while the percentage of foreign-born whites was 8.2% (93.9% of illiterate males of voting age). Germans, Irish, Poles, Swedes and Bohemians made up respectively 29.1, 12.6, 8.6, 8.3 and 6.2% of the foreign-born population. It was estimated in 1903 by a very competent authority that above 500,000 persons spoke German, 125,000 Polish, 100,000 Swedish, 90,000 Bohemian, 50,000 Norwegian, 50,000 Yiddish, 35,000 Dutch, 25,000 Italian, 20,000 Danish, 17,000 French and 12,000 Irish (Celtic), and that each of fourteen foreign languages was spoken by more than 10,000 people: "Newspapers appear regularly in 10 languages, and church-services may be heard in about 20 languages. Chicago is the second largest Bohemian city of the world, the third Swedish, the fourth Norwegian, the fifth Polish, the fifth German (New York being the fourth). In all there are some 40 languages spoken by . . . over one million" persons.¹ The death-rate of Chicago is the lowest of the great cities of the country. Births are but slightly in excess of deaths, so that the growth of the city is almost wholly from immigration. The death-rate is the lowest of the great cities of the country (16.2 in 1900; New York, 20.4; Boston, 20.1, &c.).

The growth of Chicago has been remarkable even for American cities. Any resident of four-score years living in 1900 had seen it grow from a settlement of fourteen houses, a frontier military post among the Indians, to a great metropolis, fifth in size among the cities of the world. In 1828 what is now the business centre was fenced in as a pasture; in 1831 the Chicago mail was deposited in a dry-goods box; the tax-levy of 1834 was \$48.90, and a well that constituted the city water-works was sunk at a cost of \$95.50; in 1843 hogs were barred from the town streets. Such facts impress upon one, as nothing else can, the marvellously rapid growth of the city. In 1830 with a population of less than 100, in 1840 with 4479, the increase by percentages in succeeding decades was as follows: 507.3, 264.6, 173.6, 68.3, 118.6 and 54.4; an increase equivalent to 8.6% annually, compounded. Such a continuous "boom" no other American city has ever known.

History.—The river Chicago (an Indian name of uncertain meaning, but possibly from Ojibwa *she-kag-ong*, "wild onion place") was visited by Joliet and Marquette in 1673, and later by La Salle and others. It became a portage route of some importance, used by the French in passing to the lower Illinois country. In 1804 the United States established here Fort Dearborn. In 1812, during the Indian War of Tecumseh, the garrison and settlers, who had abandoned the fort and were retreating toward safety, were attacked and overpowered by the savages at a point now well within the city. The fort was re-established and fitfully occupied until its final abandonment

¹ Prof. C. D. Buck in *Decennial Publications of the University of Chicago* (1903 vol. 6).

in 1837. When Cook county was organized in 1831, Chicago, then a tiny village, became the seat of justice. It became a town in 1833 and a city in 1837. By that time Chicago was confident of its future. The federal government had begun the improvement of the harbour, and the state had started the Illinois and Michigan canal. There was a federal land-office also, and the land speculator and town promoter had opened a chapter of history more picturesque, albeit sordid, than in any of the old French days. The giant growth of the lake trade had drawn attention before railway connexion was secure with the East in 1852, making progress even more rapid thereafter. During the Civil War a large prison-camp for Confederate prisoners, Camp Douglas, was maintained at Chicago. In 1870 the city had 306,605 inhabitants and was already a commercial centre of immense importance.

In 1871 it suffered a terrible calamity. On the 8th of October a fire broke out near the lumber district on the West Side. Two-thirds of the city's buildings were wood, and the summer had been excessively dry, while to make conditions worse a high and veering wind fanned the flames. The conflagration leaped the river to the South and finally to the North Side, burned over an area of 3½ sq. m., destroyed 17,450 buildings and property valued at \$196,000,000² and rendered almost 100,000 people homeless; 250 lost their lives. The flames actually travelled 2½ m. in an air-line within 6½ hours. Thousands of persons, fleeing before the flames and fire-brands, sought refuge on the shore and even in the waters of the lake. Robbery, pillage, extortion, orgies and crime added to the general horror. In the South Side the fire was checked on the 9th by the use of gunpowder; in the North (where the water-works were early destroyed) it had extended almost to the prairie when rainfall finally ended its ravages, after about twenty-seven hours of destruction. With the exception of the San Francisco fire of 1906 this was the greatest fire of modern times. A vast system of relief was organized and received generous aid from all parts of the world. The money contributions from the United States and abroad were \$4,996,782; of this foreign countries contributed nearly \$1,000,000 (England half of this). These funds, which were over and above gifts of food, clothing and supplies, were made to last till the close of 1876. Out of them temporary homes were provided for nearly 40,000 people; barracks and better houses were erected, workmen were supplied with tools, and women with sewing-machines; the sick were cared for and the dead buried; and the poorer classes of Chicago were probably never so comfortable as during the first two or three years after the fire. The rebuilding of the city was accomplished with wonderful rapidity. Work was begun before the cinders were cold. The business district was largely rebuilt within a year, and within three there were hardly scars of the calamity. Wood was barred from a large area (and subsequently from the entire city), and a new Chicago of brick and stone, larger, finer and wealthier, had taken the place of the old. Business and population showed no set-back in their progress. The solidity and permanence of this prosperity were confirmed during the financial panic of 1873, when Chicago banks alone, among those of the large cities of the country, continued steadily to pay out current funds.

In its later history certain special factors stand out, apart from continued commercial progress.

Chicago has been a storm centre of labour troubles, some of them of a specially spectacular character. There were great strikes in the packing industry in 1886, 1894 and 1904. But more noteworthy are the railway strike of 1894 and the unsuccessful teamsters' strike of 1905. The former began in the works of the Pullman Car Company, and its leader was Eugene Victor Debs (b. 1855). When the contentions of the Pullman employees were taken up by the American Railway Union the strike immediately extended to tremendous proportions. Union men

² There was an insurance of \$88,634,122 on the losses, of which about a half was recovered. F. L. Olmsted estimated that one-third of the roof surface and one-half the cubic contents of the city's buildings were destroyed.

throughout the country refused to handle Pullman cars, and since Pullman cars are almost invariably attached to mail trains the transportation of the United States mail was thus obstructed. Chicago, as the greatest railway centre of the country and the home of the strike, was naturally the seat of the most serious complications. There was much rioting and destruction of property, and the railway service was completely disorganized. President Cleveland, on the ground of preventing obstruction of the mail service, and of protecting other federal interests, ordered a small number of federal troops to Chicago. Those interests were, he contended, menaced by "domestic violence" evidently beyond the control of the state power. Governor Altgeld denied the inability of the state to deal with the difficulty, and entered a strong protest against Federal interference; but he himself did nothing to put down the disorder. Federal troops entered the state, and almost immediately the strike collapsed. The high officials of the Railway Union, for ignoring a court injunction restraining them from interfering with the movement of the mails, were imprisoned for long terms for contempt of court.

Out of a strike in the McCormick works in 1886 there sprang another famous incident in Chicago's history. The "international" anarchists of Chicago had been organized in "groups" about two years earlier, and were very active. They were advocating a "general strike" for an eight-hour day, and the tense excitement among the labourers of the city, owing to the McCormick strike, induced unusually ultra utterances. There was a riot at the McCormick works on the 3rd of May, in which several men were killed by the police. An anarchist meeting was called for the next day at the Haymarket, a square in Randolph Street, and when the authorities judged that the speeches were too revolutionary to be allowed to continue, the police undertook to disperse the meeting. A bomb was thrown, and many policemen were injured, seven fatally. No person could be proved to have thrown the bomb, or to have been directly implicated in its throwing; but on the ground that they were morally conspirators and accomplices in the killing, because they had repeatedly and publicly advocated such acts against the servants of government, seven anarchists were condemned to death. An application to the United States Supreme Court for a writ of error was unanimously refused.¹

The four-hundredth anniversary of the discovery of America was commemorated by a World's Columbian Exposition held at Chicago. The site was in Jackson Park and the adjoining Midway, and included 686 acres, of which 188 were covered by buildings. On the 21st of October 1892—corresponding to the 12th of October 1492, o.s.—the grounds were formally dedicated, and on the following 1st of May opened to the public, continuing open for six months. The number of paid admissions was 21,500,000; of total admissions 27,539,521. The buildings, planned by a commission of architects—among whom John W. Root and Daniel H. Burnham of Chicago were responsible for the general scheme—formed a collection of remarkable beauty, to which the grounds, planned by F. L. Olmsted, intersected by lagoons and bordered by the lake, lent an appropriate setting. The entire cost of the fair is variously estimated at from 33 to 43 million dollars, according to the inclusiveness of the estimate; the local cost may be put at \$28,151,169. Of this Chicago gave about 10½ millions, in addition to a preparatory house-cleaning that cost 3½ millions; and finally a very small dividend was paid to stockholders. The whole undertaking, carried through with remarkable enterprise, was an artistic and educational triumph of the first order.

Owing to its position Chicago has long been a favourite con-

¹ Four were hanged, 1 committed suicide, 2 had their death sentence commuted to life-imprisonment, the eighth was sentenced to imprisonment for 15 years. 981 men were panelled in selecting the jury. Governor J. P. Altgeld in 1893 pardoned the three in prison on the ground that the jury was "packed" and consequently incompetent, that no evidence connected the prisoners with the crime, and that the presiding judge was prejudiced. See an article by Judge J. E. Gary, who presided at the trial, in the *Century Magazine* (April 1893).

vention city. Lincoln (1860), Grant (1868), Garfield (1880), Cleveland (1884 and 1892), Harrison (1888), Roosevelt (1904), and Taft (1908) were all nominated here for president; and in addition not a few candidates who were unsuccessful. A national peace jubilee was held here in 1898.

AUTHORITIES.—See the annual reports of city officials, board of trade, park commissions, sanitary board, &c.; A. T. Andreas, *History of Chicago* (Chicago, 3 vols., 1884-1886); R. Blanchard, *Discovery and Conquest of the North-West with the History of Chicago* (Chicago, 2 vols., 1898-1903); J. Kirkland, *Story of Chicago* (Chicago, 1892); issues of the *Fergus Historical Series* (1876, ff.); T. J. Riley, *A Study of the Higher Life of Chicago* (Chicago University, doctoral dissertation, 1905); S. E. Sparling, *Municipal History and Present Organization of the City of Chicago* (University of Wisconsin, doctoral dissertation, Madison, 1898). Periodical literature contains a vast amount of information on Chicago's progress and conditions that is elsewhere unobtainable; exact references may be obtained in *Poole's Index to Periodical Literature*.

CHICAGO, UNIVERSITY OF, one of the great educational institutions of the United States, established under Baptist auspices in the city of Chicago, and opened in 1892.² Though the president and two-thirds of the trustees are always Baptists, the university is non-sectarian except as regards its divinity school. An immense ambition and the extraordinary organizing ability shown by its first president, William R. Harper, determined and characterized the remarkable growth of the university's first decade of activity. The grounds include about 140 acres. Of these about 60 acres—given in part by Marshall Field and laid out by Frederick Law Olmsted—border the Midway Plaisance, connecting Washington and Jackson parks. On these grounds the main part of the university stands. The buildings are mostly of grey limestone, in Gothic style, and grouped in quadrangles. The Mitchell tower is a shortened reproduction of Magdalen tower, Oxford, and the University Commons, Hutchinson Hall, is a duplicate of Christ Church hall, Oxford. Dormitories accommodate about a fifth of the students. The quadrangles include clubs, dining halls, dormitories, gymnasiums, assembly halls, recitation halls, laboratories and libraries. In the first college year, 1892-1893, there were 698 students; in that of 1907-1908 there were 5038,³ of whom 2186 were women. There are faculties of arts, literature, science, divinity,⁴ medicine (organized in 1901), law (1902), education, and commerce and administration. The astronomical department, the Yerkes Observatory, is located on William's Bay, Lake Geneva, Wisconsin, about 65 m. from Chicago. It has the largest refracting telescope in the world (clear aperture 40 in., focal length about 61 ft.). The Chicago Institute, founded and endowed by Mrs Anita McCormick Blaine as an independent normal school, became a part of the university in 1901. The school of education, as a whole, brings under university influence hundreds of children from kindergarten age upwards to young manhood and womanhood, apart from the university classes proper. Chicago was the second university of the country to give its pedagogical department such scope in the union of theory and practice. The nucleus of the library (450,000 volumes in 1908) was purchased in Berlin soon after the university's organization, in one great collection of 175,000 volumes. Scholarly research has been fostered in every possible way, and the university press has been active in the publication of various departmental series and the following periodicals:—*Biblical World*, *American Journal of Theology*, *American Journal of Semitic Languages and Literatures*, *American Journal of Sociology*, *Journal of Political Economy*, *Modern Philology*, *Classical Philology*, *Classical Journal*, *Journal of Geology*, *Astrophysical Journal*, *Botanical Gazette*, *Elementary School Teacher* and *School Review*. The courses in the College of Commerce and

² A small Baptist college of the same name—established in 1855 on land given by S. A. Douglas—went out of existence in 1886.

³ If, however, the total is reckoned on the basis of nine months of residence the figure for 1907-1908 would be 3202.

⁴ The Divinity School has a graduate department and three under graduate departments, doing work in English, in Danish and Norwegian, and in Swedish. Allied with the Divinity School of the University is the "Disciples' Divinity House" (1894), a theological school of the Disciples of Christ.

Administration link the university closely with practical life. In extension work the university has been active from the beginning, instruction being given not only by lectures but by correspondence (a novel and unique feature among American universities); in the decade 1892-1902, 1715 persons were prepared by the latter method for matriculation in the university (11.6% of the total number of matriculants in the decade). Extension lectures were given in twenty-two states. At Chicago the work of the university is continuous throughout the year: the "summer quarter" is not as in other American schools a supplement to the teaching year, but an integral part; and it attracts the teachers of the middle western states and of the south. In the work of the first two years, known together as the Junior College, men and women are in the main given separate instruction; but in the Senior College years unrestricted co-education prevails. Students are mainly controlled by self-government in small groups ("the house system"). Relations with "affiliated" (private) colleges and academies and "co-operating" (public) high-schools also present interesting features.

The value of the property of the university in 1908 was about \$25,578,000. Up to the 30th of June 1908 it had received from gifts actually paid \$29,651,849, of which \$22,712,631 were given by John D. Rockefeller.¹ The value of buildings in 1908 was \$4,508,202, of grounds \$4,406,191, and of productive funds \$14,186,235. Upon the death of President Harper, Harry Pratt Judson (b. 1849), then head professor of political science and dean of the faculties of arts, became acting president, and on the 20th of January 1907 he was elected president.

See the *Decennial Publications* of the University (since 1903), especially vol. i. for details of history and administration.

CHICANE, the pettifogging subterfuge and delay of sharp law-practitioners, also any deliberate attempt to gain unfair advantage by petty tricks. A more common English form of the word is "chicanery." "Chicane" is technically used also as a term in the game of bridge for the points a player may score if he holds no trumps. The word is French, derived either from *chaugān*, Persian for the stick used in the game of "polo," still played on foot and called *chicane* in Languedoc (the military use of *chicaner*, to take advantage of slight variations in ground, suits this derivation), or from *chic*, meaning little or petty, from the Spanish *chico*, small, which appears in the phrase "*chic à chic*," little by little.

CHICHELEY, HENRY (1364-1443), English archbishop, founder of All Souls College, Oxford, was born at Higham Ferrers, Northamptonshire, in 1363 or 1364. Chicheley told the pope in 1443, in asking leave to retire from the archbishopric, that he was in his eightieth year. He was the third and youngest son of Thomas Chicheley, who appears in 1368 in still extant town records of Higham Ferrers as a suitor in the mayor's court, and in 1381-1382, and again in 1384-1385, was mayor: in fact, for a dozen years he and Henry Barton, school master of Higham Ferrers grammar school, and one Richard Brabazon, filled the mayoralty in turns. His occupation does not appear; but his eldest son, William, is on the earliest extant list (1373) of the Grocers' Company, London. On the 9th of June 1405 Chicheley was admitted, in succession to his father, to a burgage in Higham Ferrers. His mother, Agnes Pincheon, is said to have been of gentle birth. There is therefore no foundation in fact for the silly story (copied into the *Dict. Nat. Biog.* from a local historian,

¹The words "founded by John D. Rockefeller" follow the title of the university on all its letterheads and official documents. Mr Rockefeller would not allow his name to be a part of the title, nor has he permitted the designation of any building by his name. President Harper was selected by him to organize the university, and it was his will that the president and two-thirds of the trustees should be "always" Baptists. President Harper more than once stated most categorically that contrary to prevalent beliefs no donor of funds to the university "has ever (1902) by a single word or act indicated his dissatisfaction with the instruction given to students in the university, or with the public expression of opinion made by any officer of the university"; and certainly so far as the public press reveals, no other university of the country has had so many professors who have in various lines, including economics, expressed radical views in public.

J. Cole, Wellingborough, 1838) that Henry Chicheley was picked up by William of Wykeham when he was a poor ploughboy "eating his scanty meal off his mother's lap," whatever that means. The story was unknown to Arthur Duck, fellow of All Souls, who wrote Chicheley's life in 1617. It is only the usual attempt, as in the cases of Whittington, Wolsey and Gresham, to exaggerate the rise of a successful man. The first recorded appearance of Henry Chicheley himself is at New College, Oxford, as Checheley, eighth among the undergraduate fellows, in July 1387, in the earliest extant hall-book, which contains weekly lists of those dining in Hall. It is clear from Chicheley's position in the list, with eleven fellows and eight scholars, or probationer-fellows, below him, that this entry does not mark his first appearance in the college, which had been going on since 1375 at least, and was chartered in 1379. He must have come from Winchester College in one of the earliest batches of scholars from that college, the sole feeder of New College, not from St John Baptist College, Winchester, as guessed by Dr William Hunt in the *Dict. Nat. Biog.* (and repeated in Mr Grant Robertson's *History of All Souls College*) to cover the mistaken supposition that St Mary's College was not founded till 1393. St Mary's College was in fact formally founded in 1382, and the school had been going on since 1373 (A. F. Leach, *History of Winchester College*), while no such college as St John's College at Winchester ever existed.

Chicheley appears in the Hall-books of New College up to the year 1392/93, when he was a B.A. and was absent for ten weeks from about the 6th of December to the 6th of March, presumably for the purpose of his ordination as a sub-deacon, which was performed by the bishop of Derry, acting as suffragan to the bishop of London. He was then already benefited, receiving a royal ratification of his estate as parson of Llanvarell in the diocese of St Asaph on the 20th of March 1391/92 (*Cal. Pat. Rolls*). In the Hall-book, marked 1393/94, but really for 1394/95, Chicheley's name does not appear. He had then left Oxford and gone up to London to practise as an advocate in the principal ecclesiastical court, the court of arches. His rise was rapid. Already on the 8th of February 1395/96 he was on a commission with several knights and clerks to hear an appeal in a case of *John Mollon, Esquire v. John Shawe, citizen of London*, from Sir John Cheyne, kt., sitting for the constable of England in a court of chivalry. Like other ecclesiastical lawyers and civil servants of the day, he was paid with ecclesiastical preferments. On the 13th of April 1396 he obtained ratification of the parsonage of St Stephen's, Walbrook, presented on the 30th of March by the abbot of Colchester, no doubt through his brother Robert, who restored the church and increased its endowment. In 1397 he was made archdeacon of Dorset by Richard Mitford, bishop of Salisbury, but litigation was still going on about it in the papal court till the 27th of June 1399, when the pope extinguished the suit, imposing perpetual silence on Nicholas Bubwith, master of the rolls, his opponent. In the first year of Henry IV. Chicheley was parson of Sherston, Wiltshire, and prebendary of Nantgwyly in the college of Abergwily, North Wales; on the 23rd of February 1401/2, now called doctor of laws, he was pardoned for bringing in, and allowed to use, a bull of the pope "providing" him to the chancellorship of Salisbury cathedral, and canonries in the nuns' churches of Shaftesbury and Wilton in that diocese; and on the 9th of January 1402/3 he was archdeacon of Salisbury. This year his brother Robert was senior sheriff of London. On the 7th of May 1404, Pope Boniface IX. provided him to a prebend at Lincoln, notwithstanding he already held prebends at Salisbury, Lichfield, St Martin's-le-Grand and Abergwily, and the living of Brington. On the 9th of January 1405 he found time to attend a court at Higham Ferrers and be admitted to a burgage there. In July 1405 Chicheley began a diplomatic career by a mission to the new Roman pope Innocent VII., who was professing his desire to end the schism in the papacy by resignation; if his French rival at Avignon would do likewise. Next year, on the 5th of October 1406, he was sent with Sir John Cheyne to Paris to arrange a lasting peace and the marriage of Prince Henry with the French princess Marie, which was frustrated by her becoming a nun at Poissy next year.

In 1406 renewed efforts were made to stop the schism, and Chicheley was one of the envoys sent to the new pope Gregory XII. Here he utilized his opportunities. On the 31st of August 1407 Guy Mone (he is always so spelt and not Mohun, and was probably from one of the Hampshire Meons; there was a John Mone of Havant admitted a Winchester scholar in 1397), bishop of St David's, died, and on the 12th of October 1407 Chicheley was by the pope provided to the bishopric of St David's. Another bull the same day gave him the right to hold all his benefices with the bishopric.

At Siena in July 1408 he and Sir John Cheyne, as English envoys, were received by Gregory XII. with special honour, and Bishop Repingdon of Lincoln, ex-Wycliffite, was one of the new batch of cardinals created on the 18th of September 1408, most of Gregory's cardinals having deserted him. These, together with Benedict's revolting cardinals, summoned a general council at Pisa. In November 1408 Chicheley was back at Westminster, when Henry IV. received the cardinal archbishop of Bordeaux and determined to support the cardinals at Pisa against both popes. In January 1409 Chicheley was named with Bishop Hallum of Salisbury and the prior of Canterbury to represent the Southern Convocation at the council, which opened on the 25th of March 1409, arriving on the 24th of April. Obedience was withdrawn from both the existing popes, and on the 26th of June a new pope elected instead of them. Chicheley and the other envoys were received on their return as saviours of the world; though the result was summed up by a contemporary as trischism instead of schism, and the Church as giving three husbands instead of two. Chicheley now became the subject of a leading case, the court of king's bench deciding, after arguments reheard in three successive terms, that he could not hold his previous benefices with the bishopric, and that, spite of the maxim *Papa potest omnia*, a papal bull could not supersede the law of the land (*Year-book* ii. H. iv. 37, 59, 79). Accordingly he had to resign livings and canonries wholesale (April 28, 1410). As, however, he had obtained a bull (August 20, 1409) enabling him to appoint his successors to the vacated preferments, including his nephew William, though still an undergraduate and not in orders, to the chancellorship of Salisbury, and a prebend at Lichfield, he did not go empty away. In May 1410 he went again on an embassy to France; on the 11th of September 1411 he headed a mission to discuss Henry V.'s marriage with a daughter of the duke of Burgundy; and he was again there in November. In the interval Chicheley found time to visit his diocese for the first time and be enthroned at St David's on the 11th of May 1411. He was with the English force under the earl of Arundel which accompanied the duke of Burgundy to Paris in October 1411 and there defeated the Armagnacs, an exploit which revealed to England the weakness of the French. On the 30th of November 1411 Chicheley, with two other bishops and three earls and the prince of Wales, knelt to the king to receive public thanks for their administration. That he was in high favour with Henry V. is shown by his being sent with the earl of Warwick to France in July 1413 to conclude peace. Immediately after the death of archbishop Arundel he was nominated by the king to the archbishopric, elected on the 4th of March, translated by papal bull on the 23rd of April, and received the pall without going to Rome for it on the 24th of July.

These dates are important as they help to save Chicheley from the charge, versified by Shakespeare (*Henry V.* act i. sc. 2) from Hall's *Chronicle*, of having tempted Henry V. into the conquest of France for the sake of diverting parliament from the disendowment of the Church. There is no contemporary authority for the charge, which seems to appear first in Redman's rhetorical history of Henry V., written in 1540 with an eye to the political situation at that time. As a matter of fact, the parliament at Leicester, in which the speeches were supposed to have been made, began on the 30th of April 1414 before Chicheley was archbishop. The rolls of parliament show that he was not present in the parliament at all. Moreover parliament was so far from pressing disendowment that on the petition of

the Commons it passed a savage act against the heresies "commonly called Lollardry" which "aimed at the destruction of the king and all temporal estates," making Lollards felons and ordering every justice of the peace to hunt down their schools, conventicles, congregations and confederacies.

In his capacity of archbishop, Chicheley remained what he had always been chiefly, the lawyer and diplomatist. He was present at the siege of Rouen, and the king committed to him personally the negotiations for the surrender of the city in January 1419 and for the marriage of Katherine. He crowned Katherine at Westminster (20th February 1421), and on the 6th of December baptized her child Henry VI. He was of course a persecutor of heretics. No one could have attained or kept the position of archbishop at the time without being so. So he presided at the trial of John Claydon, Skinner and citizen of London, who after five years' imprisonment at various times had made public abjuration before the late archbishop, Arundel, but now was found in possession of a book in English called *The Lanterne of Light*, which contained the heinous heresy that the principal cause of the persecution of Christians was the illegal retention by priests of the goods of this world, and that archbishops and bishops were the special seats of antichrist. As a relapsed heretic, he was "left to the secular arm" by Chicheley. On the 1st of July 1416 Chicheley directed a half-yearly inquisition by archdeacons to hunt out heretics. On the 12th of February 1420 proceedings were begun before him against William Taylor, priest, who had been for fourteen years excommunicated for heresy, and was now degraded and burnt for saying that prayers ought not to be addressed to saints, but only to God. A striking contrast was exhibited in October 1424, when a Stamford friar, John Russell, who had preached that any religious *potest concumbere cum muliere* and not mortally sin, was sentenced only to retract his doctrine. Further persecutions of a whole batch of Lollards took place in 1428. The records of convocation in Chicheley's time are a curious mixture of persecutions for heresy, which largely consisted in attacks on clerical endowments, with negotiations with the ministers of the crown for the object of cutting down to the lowest level the clerical contributions to the public revenues in respect of their endowments. Chicheley was tenacious of the privileges of his see, and this involved him in a constant struggle with Henry Beaufort, bishop of Winchester. In 1418, while Henry V. was alive, he successfully protested against Beaufort's being made a cardinal and legate *a latere* to supersede the legatine jurisdiction of Canterbury. But during the regency, after Henry VI.'s accession, Beaufort was successful, and in 1426 became cardinal and legate. This brought Chicheley into collision with Martin V. The struggle between them has been represented as one of a patriotic archbishop resisting the encroachments of the papacy on the Church of England. In point of fact it was almost wholly personal, and was rather an incident in the rivalry between the duke of Gloucester and his half-brother, Cardinal Beaufort, than one involving any principle. Chicheley, by appointing a jubilee to be held at Canterbury in 1420, "after the manner of the Jubilee ordained by the Popes," threatened to divert the profits from pilgrims from Rome to Canterbury. A ferocious letter from the pope to the papal nuncios, on the 19th of March 1423, denounced the proceeding as calculated "to ensnare simple souls and extort from them a profane reward, thereby setting up themselves against the apostolic see and the Roman pontiff, to whom alone so great a faculty has been granted by God" (*Cal. Pap. Reg.* vii. 12). Chicheley also incurred the papal wrath by opposing the system of papal provision which diverted patronage from English to Italian hands, but the immediate occasion was to prevent the introduction of the bulls making Beaufort a cardinal. Chicheley had been careful enough to obtain "Papal provisions" for himself, his pluralities, his bishopric and archbishopric.

But, after all, it is not as archbishop or statesman, persecutor, papalist or antipapalist that Chicheley is remembered, but for his educational foundations. He endowed a hutch, *i.e.* chest or loan-fund for poor scholars at New College, and another for the

university of Oxford at large. He founded no less than three colleges, two at Oxford, one at Higham Ferrers, while there is reason to believe that he suggested and inspired the foundation of Eton and of King's College. His first college at Oxford, in perishing, gave birth to St John's College, which now holds its site. This was St Bernard's College, founded by Chicheley under licence in mortmain in 1437 for Cistercian monks, on the model of Gloucester Hall and Durham College for the southern and northern Benedictines. Nothing more than a site and building was required by way of endowment, as the young monks, who were sent there to study under a provisor, were supported by the houses of the order to which they belonged. The site was five acres, and the building is described in the letters patent "as a fitting and noble college mansion in honour of the most glorious Virgin Mary and St Bernard in Northgates Street outside the Northgate of Oxford." It was suppressed with the Cistercian abbeys in 1539, and granted on the 11th of December 1546 to Christ Church, Oxford, who sold it to Sir Thomas Pope in 1553 for St John's College.

The college at Higham Ferrers was a much earlier design. On the 2nd of May 1422 Henry V., in right of the duchy of Lancaster, "bearing that Chicheley inflamed by the pious fervour of devotion intended to enlarge divine service and other works of piety at Higham Ferrers, in consideration of his fruitful services, often crossing the seas, yielding to no toils, dangers or expenses . . . especially in the conclusion of the present final peace with our dearest father the king of France," granted for 300 marks (£200) licence to found, on three acres at Higham Ferrers, a perpetual college of eight chaplains and four clerks, of whom one was to teach grammar and the other song . . . and six choristers to pray for himself and wife and for Henry IV. and his wife Mary . . . and to acquire the alien priory of Merseye in Essex late belonging to St Ouen's, Rouen," as endowment. A papal bull having also been obtained, on the 28th of August 1425, the archbishop, in the course of a visitation of Lincoln diocese, executed his letters patent founding the college, dedicating it to the Virgin, St Thomas à Becket and St Edward the Confessor, and handed over the buildings to its members, the vicar of Higham Ferrers being made the first master or warden. He further endowed it in 1434 with lands in Bedfordshire and Huntingdonshire, and his brothers, William and Robert, gave some houses in London in 1427 and 1438. The foundation was closely modelled on Winchester College, with its warden and fellows, its grammar and song schoolmasters, but a step in advance was made by the masters being made fellows and so members of the governing body. Attached was also a bede or almshouse for twelve poor men. Both school and almshouse had existed before, and this was merely an additional endowment. The whole endowment was in 1535 worth some £200 a year, about a fifth of that of Winchester College. Unfortunately, All Souls being a later foundation, the college at Higham Ferrers was not affiliated to it, and so fell with other colleges not part of the universities. On the 18th of July 1542 it was surrendered to Henry VIII., and its possessions granted to Robert Dacres on condition of maintaining the grammar school and paying the master £10 a year, the same salary as the headmasters of Winchester and Eton, and maintaining the almshouse. Both still exist, but the school has been deprived of its house, and the Fitzwilliam family, who now own the lands, still continue to pay only £10 a year.

All Souls College was considerably later. The patent for it, dated 20th of May 1438, is for a warden and 20 scholars, to be called "the Warden and College of the souls of all the faithful departed," to study and pray "for the soul of King Henry VI. and the souls of Henry V., Thomas, duke of Clarence, and all the dukes, earls, barons, knights, squires and other nobles and subjects of our father who during the time and in the service of our father and ourselves ended their lives in the wars of the kingdom of France, and for the souls of all the faithful departed." For this, the king granted Berford's Hall, formerly Charleston's Inn, which Chicheley's trustees had granted to him so as to obtain a royal grant and indefeasible title. Richard Andrews,

the king's secretary, like Chicheley himself a scholar of Winchester and fellow of New College, was named as first warden. A papal bull for the college was obtained on the 21st of June 1439; and further patents for endowments from the 11th of May 1441 to the 28th of January 1443, when a general confirmation charter was obtained, for which £1000 (£30,000 at least of our money) was paid. It is commonly represented that the endowment was wholly derived from alien priories bought by Chicheley from the crown. In truth, not so large a proportion of the endowment of All Souls was derived from this source as was that of New College. The only alien priories granted were Abberbury in Oxfordshire, Wedon Pinkney in Northamptonshire, Romney in Kent, and St Clare and Llangenith in Wales, all very small affairs, single manors and rectories, and these did not form a quarter of the whole endowment. The rest, particularly the manor of Edgware, which made the fortune of the college, was bought from private owners. Early in 1443 the college was opened by Chicheley with four bishops in state. The statutes, not drawn up until the 2nd of April 1443, raised the number of the college to forty. Like the college buildings, they are almost an exact copy of those of New College, *mutatis mutandis*. The college is sometimes described as being different from other colleges in being merely a large chantry to pray for the souls of the dead warriors. But it was no more a chantry than the other colleges, all of which, like the monasteries and collegiate churches, were to pray for their founders' and other specified souls. Indeed, All Souls was more of a lay foundation than its model. For while at New College only twenty out of seventy fellows were to study law instead of arts, philosophy and theology, at All Souls College—sixteen were to be "jurists" and only twenty-four "artists"; and while at New College there were ten chaplains and three clerks necessarily, at All Souls the number was not defined but left optional; so that there are now only one chaplain and four bible clerks.

Ten days after he sealed the statutes, on the 12th of April 1443, Chicheley died and was buried in Canterbury cathedral on the north side of the choir, under a fine effigy of himself erected in his lifetime. There is what looks like an excellent contemporary portrait in one of the windows of All Souls College, which is figured in the *Victoria County History* for Hampshire, ii. 262.

(A. F. L.)

CHICHEN-ITZA, or CHICHEN, an ancient ruined city of Yucatan, Mexico, situated 22 m. W. of Valladolid. The name is derived from that of the Itza, a tribe of the great Mayan stock, which formerly inhabited the city, and *chichen*, having reference probably to two wells or pools which doubtless originally supplied the inhabitants with water and are still in existence. The history of the city is unknown, though it is regarded as probable that it preserved its independence long after the Spaniards had taken possession of the rest of the district. The area covered by the ruins is approximately 1 sq. m., and other remains are found in the neighbouring forest. (See CENTRAL AMERICA; *Archæology*.)

CHICHESTER OF BELFAST, ARTHUR CHICHESTER, BARON (1563-1625), lord-deputy of Ireland, second son of Sir John Chichester of Raleigh, Devonshire, by Gertrude, daughter of Sir William Courtenay of Powderham, was born at Raleigh in May 1563, and was educated at Exeter College, Oxford. He commanded a ship against the Spanish Armada in 1588, and is said to have served under Drake in his expedition of 1595. Having seen further service abroad, he was sent to Ireland at the end of 1598, and was appointed by the earl of Essex to the governorship of Carrickfergus. When Essex returned to England, Chichester rendered valuable service under Mountjoy in the war against the rebellious earl of Tyrone, and in 1601 Mountjoy recommended him to Cecil in terms of the highest praise as the fittest person to be entrusted with the government of Ulster. On the 15th of October 1604 Chichester was appointed lord-deputy of Ireland. He announced his policy in a proclamation wherein he abolished the semi-feudal rights of the native Irish chieftains, substituting for them fixed dues, while their tenants were to become dependent "wholly and immediately upon his

majesty." Tyrone and other Irish clan chieftains resented this summary interference with their ancient social organization, and their resistance was strengthened by the ill-advised measures against the Roman Catholics which Chichester was compelled to take by the orders of the English ministers. He himself was moderate and enlightened in his views on this matter, and it was through his influence that the harshness of the anti-Catholic policy was relaxed in 1607. Meantime his difficulties with the Irish tribal leaders remained unsolved. But in 1607, by "the flight of the Earls" (see O'NEILL), he was relieved of the presence of the two formidable Ulster chieftains, the earls of Tyrone and Tyrconnell. Chichester's policy for dealing with the situation thus created was to divide the lands of the fugitive earls among Irishmen of standing and character; but the plantation of Ulster as actually carried out was much less favourable and just to the native population than the lord-deputy desired. In 1613 Chichester was raised to the peerage as Baron Chichester of Belfast, and in the following year he went to England to give an account of the state of Ireland. On his return to Ireland he again attempted to moderate the persecuting policy against the Irish Catholics which he was instructed to enforce; and although he was to some extent successful, it was probably owing to his opposition to this policy that he was recalled in November 1614. The king, however, told him "You may rest assured that you do leave that place with our very good grace and acceptance of your services"; and he was given the post of lord-treasurer of Ireland. After living in retirement for some years, Chichester was employed abroad in 1622; in the following year he became a member of the privy council. He died on the 19th of February 1625 and was buried at Carrickfergus.

Lord Chichester married Lettice, daughter of Sir John Perrot and widow of Walter Vaughan of Golden Grove. He had no children, and his title became extinct at his death. The heir to his estates was his brother Sir Edward Chichester (d. 1648), governor of Carrickfergus, who in 1625 was created Baron Chichester of Belfast and Viscount Chichester of Carrickfergus. This nobleman's eldest son Arthur (1606-1675), who distinguished himself as Colonel Chichester in the suppression of the rebellion of 1641, was created earl of Donegall in 1647, and was succeeded in his titles by his nephew, whose great-grandson, Arthur, 5th earl of Donegall, was created Baron Fisherwick in the peerage of Great Britain (the other family titles being in the peerage of Ireland) in 1790, and earl of Belfast and marquess of Donegall in the peerage of Ireland in 1791. The present marquess of Donegall is his descendant.

See S. R. Gardiner in *Dict. Nat. Biog. and History of England, 1603-1642* (London, 1883); Fynes Moryson, *History of Ireland, 1599-1603* (Dublin, 1735). (R. J. M.)

CHICHESTER, a city and municipal borough in the Chichester parliamentary division of Sussex, England, 69 m. S.S.W. from London by the London, Brighton & South Coast railway. Pop. (1901) 12,224. It lies in a plain at the foot of a spur of the South Downs, a mile from the head of Chichester Harbour, an inlet of the English Channel. The cathedral church of the Holy Trinity was founded towards the close of the 11th century, after the see had been removed to Chichester from Selsey in 1075. The first church was consecrated in 1108, but fires in 1114 and 1187 caused building to continue steadily until the close of the 13th century. Bishop Ralph Luffa (1091-1123) was the first great builder, and was followed by Seffrid II. (1180-1204). Norman work appears in the nave (arcade and triforium), choir (arcade) and elsewhere; but there is much very beautiful Early English work, the choir above the arcade and the eastern part being especially fine. The nave is remarkable in having double aisles on each side, the outer pair being of the 13th century. The church is also unique among English cathedrals in the possession of a detached campanile, a massive and beautiful Perpendicular structure with the top storey octagonal. The principal modern restorations are the upper part of the north-west tower, which copies the Early English work of that on the south-west; and the fine central tower and spire, which had been erected at different periods in the 14th century, but col-

lapsed, doing little damage to the fabric, in 1861. Under the direction of Sir Gilbert Scott and others they were reconstructed with scrupulous care in preserving the original plan. The Lady chapel at the east end is in the main early Decorated, but greatly restored; the library is a fine late Norman vaulted room; the cloisters are Perpendicular and well restored; and the bishop's palace retains an Early English chapel. The cathedral is 393 ft. long within, 131 ft. across the transepts, and 90 ft. across the nave with its double aisles. The height of the spire is 277 ft.

At the junction of the four main streets of the town stands the market cross, an exquisite octagonal structure in ornate Perpendicular style, built by Bishop Story, c. 1500, perhaps the finest of its kind in the United Kingdom. The hospital of St Mary was founded in the 12th century, but the existing buildings are in a style transitional from Early English to Decorated. Its use as an almshouse is maintained. Other ancient buildings are the churches of St Olave, in the construction of which Roman materials were used; and of St Andrew, where is the tomb of the poet William Collins, whose memorial with others by the sculptor Flaxman is in the cathedral; the Guildhall, formerly a Grey Friars' chapel, of the 13th century; the Canon Gate leading into the cathedral close; and the Vicars College. The city retains a great part of its ancient walls, which have a circuit of about a mile and a half, and, at least in part, follow the line of Roman fortifications. The principal modern buildings, besides churches and chapels, are the council house, corn exchange, market house, and museum of the Chichester Literary Society. The grammar school was founded in 1497 by Bishop Story. There is a large cattle market, and the town has a considerable agricultural trade, with breweries and tanneries. A canal connects with Chichester Harbour. The diocese includes the whole county of Sussex except a few parishes, with very small portions of Kent and Surrey. The municipal borough is under a mayor, six aldermen and eighteen councillors. Area, 1538 acres.

The Romano-British town on this site was perhaps *Regnum* or *Regni*. Many inscriptions, pottery, coins, &c., have been found, and part of the medieval walls contain a Roman cave. An interesting inscription from this site is preserved at Goodwood. Situated on one Roman road in direct connexion with London and another leading from east to west, Chichester (*Cissaceaster*, *Cicestre*) remained of considerable importance under the South Saxon kings. In 967 King Edgar established a mint here. Though Domesday Book speaks of one hundred and forty-two burgages in Chichester and a charter of Henry I. mentions the borough, the earliest extant charter is that granted by Stephen, confirming to the burgesses their customs and rights of the borough and gild merchant as they had them in the time of his grandfather. This was confirmed by Henry II. Under Henry III. the fee farm rent was £38: 10s., but this was reduced by a charter of 10 Edward II. to £36, the customs of wool, hides and skins being reserved to the king. Edward III. directed that the Sussex county court should be held at Chichester, and this was confirmed in the following year. Confirmations of the previous charters were also granted by Edward III., Richard II., Henry VI., Edward IV., and Henry VII., who gave the mayor and citizens cognizance of all kinds of pleas of assize touching lands and hereditaments of freehold tenure. A court leet, court of record and bailiffs' court of liberties still exist. The charters were also confirmed by Henry VIII., Edward VI., Philip and Mary, and Elizabeth. In 1604 the city was incorporated under a mayor and aldermen. Since 1295, when it first returned a member, Chichester has been regularly represented in parliament. Throughout the middle ages Chichester was a place of great commercial importance, Edward III. establishing a wool staple here in 1348. Fairs were granted by Henry I. and Henry VII. Fuller mentions the Wednesday market as being famous for corn, while Camden speaks of that on Saturday as the greatest for fish in the county. The markets and a fair on the 20th of October are still held.

See *Victoria County History, Sussex*; Alexander Hay, *History of Chichester* (Chichester, 1804).

CHICKAMAUGA CREEK, a small tributary of the Tennessee river, which it joins near Chattanooga, Tennessee, U.S.A. It gives its name to the great battle of Chickamauga in the American Civil War, fought on the 19-20th of September 1863, between the Federal army of the Cumberland under Major-General W. S. Rosecrans and the Confederate army under General Braxton Bragg. For the general operations of Rosecrans' army in 1863 see AMERICAN CIVIL WAR. A successful war of manœuvre had brought the army of the Cumberland from Murfreesboro to Decherd, Tenn., and Bragg's army lay on the Tennessee at and above Chattanooga. Rosecrans was expected by the enemy to manœuvre so as to gain touch with the Union forces in the upper Tennessee valley, but he formed an entirely different plan of operations. One part of the army demonstrated in front of Chattanooga, and the main body secretly crossed the river about Stevenson and Bridgeport (September 4th). The country was mountainous, the roads few and poor, and the Federals had to take full supplies of food, forage and ammunition with them, but Rosecrans was an able commander, his troops were in good hands, and he accepted the risks involved. These were intensified by the want of good maps, and, in the event, at one moment the army was placed in a position of great danger. A corps under A. McD. McCook moved south-eastward across the ridges to Alpine, another under Thomas marched via Trenton on McLemore's

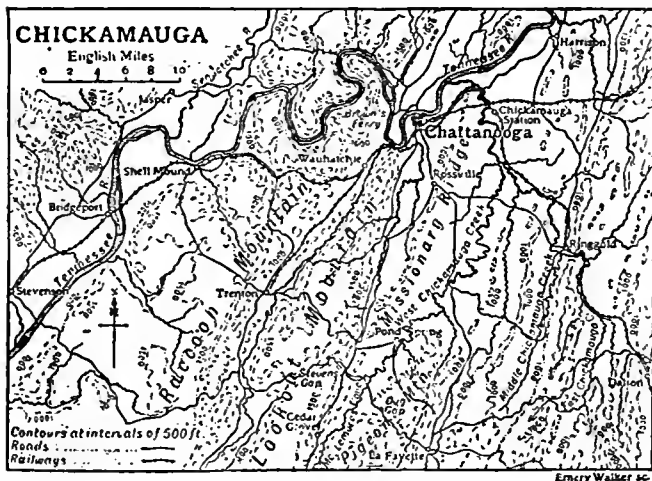

Cove. The presence of Federal masses in Lookout Valley caused Bragg to abandon Chattanooga at once, and the object of the manœuvre was thus accomplished; but owing to the want of good maps the Union army was at the same time exposed to great danger. The head of Thomas's column was engaged at Dug Gap, on the 17th, against the flank guard of Bragg's army, and at the time McCook was far away to the south, and Crittenden's corps, which had occupied Chattanooga on the 9th, was also at a distance. Thomas was isolated, but Rosecrans, like every other commander under whom he served, placed unbounded confidence in his tenacity, and if Bragg was wrong in neglecting to attack him on the 14th, subsequent events went far to disarm criticism. By the 18th of September Rosecrans had at last collected his army on Chickamauga Creek covering Chattanooga. But Bragg had now received heavy reinforcements, and lay, concentrated for battle, on the other side of the Creek.

The terrain of the battle of Chickamauga (19th-20th of September) had little influence on its course. Both armies lay in the plain, the two lines roughly parallel. Bragg's intention was to force his attack home on Rosecrans' left wing, thus cutting him off from Chattanooga and throwing him back into the mountain country whence he had come. On the 19th a serious action took place between the Confederate right and Rosecrans' left under Thomas. On the 20th the real battle began. The Confederates, in accordance with Bragg's plans, pressed hard upon Thomas, to whom Rosecrans sent reinforcements. One of the divisions detached from the centre for this purpose was by inadvertence taken out of the first line, and before the gap

could be filled the Confederate central attack, led by Longstreet and Hood, the fighting generals of Lee's army, and carried out by veteran troops from the Virginian battlefields, cut the Federal army in two. McCook's army corps, isolated on the Federal right, was speedily routed, and the centre shared its fate. Rosecrans himself was swept off the field in the rout of half of his army. But Thomas was unshaken. He re-formed the left wing in a semicircle, and aided by a few fresh brigades from Rossville, resisted for six hours the efforts of the whole Confederate army. Rosecrans in the meantime was rallying the fugitives far to the rear near Chattanooga itself. The fury of Bragg's assault spent itself uselessly on the heroic divisions under Thomas, who remained on the field till night and then withdrew in good order to Rossville. Here he remained on the 21st, imposing respect upon the victors. On the 22nd Rosecrans had re-established order, and Thomas fell back quietly to Chattanooga, whither Bragg slowly pursued. For the subsequent events of the campaign see CHATTANOOGA. The losses in the battle bear witness to a severity in the fighting unusual even in the American Civil War. Of 70,000 Confederates engaged at least 18,000 were killed and wounded, and the Federals lost 16,000 out of about 57,000. The battlefield has been converted into a national park, and was used during the Spanish American War (1898) as a place of mobilization for the U.S. volunteers.

CHICKASAWS, a tribe of North American Indians of Muskogean stock, now settled in the western part of Oklahoma. Their former range was northern Mississippi and portions of Tennessee. According to their own tradition and the evidence of philology, they are closely connected with the Creeks and Choctaws; and they believe that they emigrated with these tribes from the west, crossed the Mississippi, and settled in the district that now forms the north-east part of the state of that name. Here they were visited by De Soto in 1540. From the first they were hostile to the French colonists. With the English, on the other hand, their relations were more satisfactory. In 1786 they made a treaty with the United States; and in 1793 they assisted the whites in their operations against the Creeks. In the early years of the 19th century part of their territory was ceded for certain annuities, and a portion of the tribe migrated to Arkansas; and in 1832-1834, the remainder, amounting to about 3600, surrendered to the United States the 6,442,400 acres of which they were still possessed, and entered into a treaty with the Choctaws for incorporation with that tribe. In 1855, however, they effected a separation of this union, with which they had soon grown dissatisfied, and by payment to the Choctaws of \$150,000 obtained a complete right to their present territory. In the Civil War they joined the Confederates and suffered in consequence; but their rights were restored by the treaty of 1865. In 1866 they surrendered 7,000,000 acres; and in 1873 they adopted their former slaves. They had an independent government consisting of a governor, a senate, and a house of representatives; but tribal government virtually ceased in 1906. The Chickasaws of pure or mixed blood numbered 4826 in 1900, and with the fully admitted "citizens," *i.e.* the freed slaves and adopted whites, the whole nation amounted to some 10,000.

See *Handbook of American Indians* (Washington, 1907).

CHICKASHA, a city and the county-seat of Grady county, Oklahoma, U. S. A., near the Washita river, about 45 m. S. S. W. of Oklahoma city. Pop. (1900) 3209; (1907) 7862, including 1043 negroes; (1910) 10,320. Chickasha is served by the St Louis & San Francisco, the Chicago, Rock Island & Pacific and the Oklahoma Central railways. It is the trade centre of a very fertile section of the Washita Valley, whose principal products are Indian corn, cotton, fruits and vegetables and live-stock. The city has various manufactures, including flour, cotton-seed oil, lumber, furniture and farm implements. Chickasha was founded in 1892 and was chartered as a city in 1899.

CHICKEN-POX (Syn. *varicella*, a Low Latin diminutive of *variola*), a specific contagious disease characterized by an eruption of vesicles in the skin. The disease usually occurs in epidemics, and is one of childhood, the patients being generally

between two and six years old. The incubation period is from ten to fifteen days; there are practically no prodromal symptoms, the only indication being a slight amount of fever for some twenty-four hours, after which the eruption makes its appearance. A number of raised red papules appear on the trunk, either on the back or chest; in from twelve to twenty-four hours these develop into tense vesicles filled with a clear fluid, which in another thirty-six hours or so becomes opalescent. During the fourth day these vesicles dry and shrivel up, and the scabs fall off, leaving as a rule no scar. Fresh spots appear during the first three days, so that at the end of that time they can be seen in all stages of growth and decay. The eruption is most marked on the chest, but it also occurs on the face and limbs, and on the mucous membrane of the mouth and palate. The temperature begins to fall after the appearance of the rash, but a certain slight amount may persist after the disappearance of all symptoms. It rarely rises above 102 F. The disease runs a very favourable course in the majority of cases, and after effects are rare. One attack does not confer immunity, and in numerous cases one individual has had three attacks. The diet should be light, and the patient should be prevented from scratching the spots, which would lead to ulceration and scarring. After the first few days there is no necessity to confine the patient to bed. In the large majority of cases, it is easy to distinguish the disease from smallpox, but in certain patients it is very difficult. The chief points in the differential diagnosis are as follows. (1) In chicken-pox the rash is distributed chiefly on the trunk, and less on the limbs. (2) Some of the vesicles are oval, whereas in smallpox they are always hemispherical. They are also more superficial, and have not at the outset the hard shotty feeling of the more virulent disease. (3) The vesicles attain their full growth within twelve to twenty-four hours. (4) The pustules are usually monocular. (5) There is no prodromal period.

CHICLANA, or **CHICLANA DE LA FRONTERA**, a town of southern Spain, in the province of Cadiz, 12 m. by rail S.E. of Cadiz. Pop. (1900) 10,868. Chiclana occupies a fertile valley, watered by the river Lirio, and sheltered, on the north and south, by low hills covered with vines and plantations. It faces the gulf of Cadiz, 3 m. W., and, from its mild climate and pleasant surroundings, is the favourite summer residence of the richer Cadiz merchants; its hot mineral springs also attract many visitors. In the neighbourhood are the Roman ruins of Chiclana la Vieja, the town of Medina Sidonia (*q.v.*), and, about 5 m. S., the battlefield of Barrosa, where the British under Sir Thomas Graham (Lord Lynedoch) defeated the French under Marshal Victor, on the 5th of March 1811.

CHICOPEE, a city of Hampden county, Massachusetts, U.S.A., situated on the E. side of the Connecticut river, at the mouth of the Chicopee river, immediately N. of Springfield. Pop. (1890) 14,050; (1900) 19,167, of whom 8,139 were foreign-born; (1910, census) 25,401. Chicopee is served by the Boston & Maine railway. The city, which has an area of about 25 sq. m., contains five villages, Chicopee Center, Chicopee Falls, Willimansett, Fairview and Aldenville. Chicopee Falls lies on both sides of the Chicopee river, which falls some 70 ft. in less than 3 m. and furnishes valuable power for manufactories. The most important products are cotton goods (two large factories having, together, about 200,000 spindles), fire-arms (especially the Stevens rifles), tools, rubber and elastic goods, sporting goods, swords, automobiles and agricultural implements. Here, too, is a bronze statuary foundry, in which some of the finest monuments, bronze doors, &c., in the country have been cast, including the doors of the Capitol at Washington. The bronze casting industry here was founded by Nathan Peabody Ames (1803-1847), who was first a sword-maker and in 1836 began the manufacture of cannon and church bells. The total value of the city's factory product in 1905 was \$7,715,653, an increase of 43.2% in five years. There is a public library. The municipality owns and operates the water-works system and the electric lighting plant. Chicopee was settled about 1638, was set off from Springfield as an independent township in 1848, and was chartered as a city in 1890. Chicopee Falls was the

home of Edward Bellamy. The name of the city is an Indian word meaning "cedar-tree" or "birch-bark place."

CHICORY. The chicory or succory plant, *Cichorium Intybus* (natural order, Compositae), in its wild state is a native of Great Britain, occurring most frequently in dry chalky soils, and by road-sides. It has a long fleshy tap-root, a rigid branching hairy stem rising to a height of 2 or 3 ft.—the leaves around the base being lobed and toothed, not unlike those of the dandelion. The flower heads are of a bright blue colour, few in number, and measure nearly an inch and a half across. Chicory is cultivated much more extensively on the continent of Europe—in Holland, Belgium, France and Germany—than in Great Britain; and as a cultivated plant it has three distinct applications. Its roots roasted and ground are used as a substitute for, adulterant of, or addition to coffee; both roots and leaves are employed as salads; and the plant is grown as a fodder or herbage crop which is greedily consumed by cattle. In Great Britain it is chiefly in its first capacity, in connexion with coffee, that chicory is employed. A large proportion of the chicory root used for this purpose is obtained from Belgium and other neighbouring continental countries; but a considerable quantity is cultivated in England, chiefly in Yorkshire. For the preparation of chicory the older stout white roots are selected, and after washing they are sliced up into small pieces and kiln-dried. In this condition the material is sold to the chicory roaster, by whom it is roasted till it assumes a deep brown colour; afterwards when ground it is in external characteristics very like coffee, but is destitute of its pleasing aromatic odour. Neither does the roasted chicory possess any trace of the alkaloid caffeine which gives their peculiar virtues to coffee and tea. The fact, however, that for over a hundred years it has been successfully used as a substitute for or recognized addition to coffee, while in the meantime innumerable other substances have been tried for the same purpose and abandoned, indicates that it is agreeable and harmless. It gives the coffee additional colour, bitterness and body. It is at least in very extensive and general use; and in Belgium especially its infusion is largely drunk as an independent beverage.

The blanched leaves are much esteemed by the French as a winter salad known by the name of *Barbe de capucin*. When intended for winter use, chicory is sown in May or June, commonly in drills, and the plants are thinned out to 4 in. apart. If at first the leaves grow very strong, they are cut off, perhaps in the middle of August, about an inch from the ground, so as to promote the production of new leaves, and check the formation of flower-stems. About the beginning of October the plants are raised from the border, and all the large leaves cut off; the roots are also shortened, and they are then planted pretty closely together in boxes filled with rich light mould, and watered when needful. When frost comes on, the boxes are protected by any kind of litter and haulm. As the salad is wanted, they are removed into some place having a moderately increased temperature, and where there is no light. Each box affords two crops of blanched leaves, and these are reckoned fit for cutting when about 6 in. long. Another mode of obtaining the young leaves of this plant in winter is to sow seeds in a bed of light rich mould, or in boxes in a heat of from 55° to 60°, giving a gentle watering as required. The leaves will be fit to be cut in a fortnight after sowing, and the plants will afford a second crop.

In Belgium a variety of chicory called *Willoef* is much preferred as a salad to the French *Barbe de capucin*. The seeds are sown and the plants thinned out like those of the ordinary sort. They are eventually planted in light soil, in succession, from the end of October to February, at the bottom of trenches a foot or more in depth, and covered over with from 2 to 3 ft. of hot stable manure. In a month or six weeks, according to the heat applied, the heads are fit for use and should be cut before they reach the manure. The plants might easily be forced in frames on a mild hot-bed, or in a mushroom-house, in the same way as sea-kale. In Belgium the fresh roots are boiled and eaten with butter, and throughout the Continent the roots are stored for use as salads during winter.

See also **ENDIVE** (*Cichorium endivia*).

CHIDAMBARAM, or **CHEDUMBRUM**, a town of British India, in the South Arcot district of Madras, 7 m. from the coast and 151 m. S. of Madras by rail. Pop. (1901) 19,909. The pagodas at Chidambaram are the oldest in the south of India, and portions of them are gems of art. Here is supposed to have been the northern frontier of the ancient Chola kingdom, the successive capitals of which were Uriyur on the Cauvery, Combaconum and Tanjore. The principal temple is sacred to Siva, and is said to have been rebuilt or enlarged by a leper emperor, who came south on a pilgrimage and was cured by bathing in the temple tank; upwards of 60,000 pilgrims visit the temple every December. It contains a "hall of a thousand pillars," one of numerous such halls in India, the exact number of pillars in this case being 984; each is a block of solid granite, and the roof of the principal temple is of copper-gilt. Three hundred of the highest-caste Brahmins live with their families within the temple enclosure.

CHIEF (from Fr. *chef*, head, Lat. *caput*), the head or upper part of anything, and so, in heraldry, the upper part of the escutcheon, occupying one-third of the whole. When applied to a leading personage, a head man or one having the highest authority, the term chief or chieftain (Med. Lat. *capitanus*, O. Fr. *chevetaine*) is principally confined to the leader of a clan or tribe. The phrase "in chief" (Med. Lat. *in capite*) is used in feudal law of the tenant who holds his fief direct from the lord paramount (see **FEUDALISM**).

CHIEMSEE, also called **BAYRISCHES MEER**, the largest lake in Bavaria, lying on a high plateau 1600 ft. above the sea, between the rivers Inn (to which it drains through the Alz) and Salzach. With a length of 6 and a breadth of 9 m., it has an area of about 33 sq. m., and contains three islands, Herrenwörth, Frauenwörth and Krautinsel. The first, which has a circumference of 6½ m. and is beautifully wooded, is remarkable for the romantic castle which Louis II. of Bavaria erected here. It was the seat of a bishop from 1215 to 1805, and until 1803 contained a Benedictine monastery. The shores of the lake are flat on the north and south sides, but its other banks are flanked by undulating hills, which command beautiful and extensive views. The waters are clear and it is well stocked with trout and carp; but the fishing rights are strictly preserved. Steamers ply on the lake, and the railway from Rosenheim to Salzburg skirts the southern shores.

CHIENG MAI, the capital of the Lao state of the same name and of the provincial division of Siam called Bayap, situated in 99° 0' E., 18° 46' N. The town, enclosed by massive but decaying walls, lies on the right bank of the river Me Ping, one of the branches of the Me Nam, in a plain 800 ft. above sea-level, surrounded by high, wooded mountains. It has streets intersecting at right angles, and an enceinte within which is the palace of the Chao, or hereditary chief. The east and west banks of the river are connected by a fine teak bridge. The American Presbyterian Mission, established here in 1867, has a large number of converts and has done much good educational work. Chieng Mai, which the Burmese have corrupted into Zimmé, by which name it is known to many Europeans, has long been an important trade centre, resorted to by Chinese merchants from the north and east, and by Burmese, Shans and Siamese from the west and south. It is, moreover, the centre of the teak trade of Siam, in which many Burmese and several Chinese and European firms are engaged. The total value of the import and export trade of the Bayap division amounts to about £2,500,000 a year. The Siamese high commissioner of Bayap division has his headquarters in Chieng Mai, and though the hereditary chief continues as the nominal ruler, as is also the case in the other Lao states of Nan, Prè, Lampun, Napawn Lampang and Tern, which make up the division, the government is entirely in the hands of that official and his staff. The government forest department, founded in 1896, has done good work in the division, and the conservator of forests has his headquarters in Chieng Mai. The headquarters of an army division are also situated here. A British consul resides at Chieng Mai, where, in addition to the ordinary law courts, there is an international court having jurisdiction in all cases in which British subjects are parties.

The population, about 20,000, consists mainly of Laos, with many Shans, a few Burmese, Chinese and Siamese and some fifty Europeans. Hill tribes (Ka) inhabit the neighbouring mountains in large numbers.

Chieng Mai was formerly the capital of a united Lao kingdom, which, at one time independent, afterwards subject to Burma and then to Siam, and later broken up into a number of states, has finally become a provincial division of Siam. In 1902 a rising of discontented Shans took place in Bayap which at one time seemed serious, several towns being attacked and Chieng Mai itself threatened. The disturbance was quelled and the malcontents eventually hunted out, but not without losses which included the commissioner of Prè and a European officer of gendarmerie.

CHIERI, a town and episcopal see of Piedmont, Italy, in the province of Turin, 13 m. S.E. by rail and 8 m. by road from the town of Turin. Pop. (1901) 11,929 (town), 13,803 (commune). Its Gothic cathedral, founded in 1037 and reconstructed in 1405, is the largest in Piedmont, and has a 13th century octagonal baptistery. Chieri was subject to the bishop of Turin in the 9th and 10th centuries, it became independent in the 11th century. In 1347 it submitted voluntarily to Count Amedeus VI. of Savoy to save itself from the marquis of Monferrato, and finally came under the dominion of Savoy in the 16th century. In 1785 it was made into a principality of the duke of Aosta. It was an early centre of trade and manufacture; and in the middle of the 15th century produced about 100,000 pieces of cotton goods per annum.

See L. Cibrario, *Delle storie di Chieri* (Turin, 1855).

CHIETI, a city of the Abruzzi, Italy, the capital of the province of Chieti, and the seat of an archbishop, 140 m. E.N.E. of Rome by rail, and 9 m. W. of Castellammare Adriatico. Pop. (1901) 26,368. It is situated at a height of 1083 ft. above sea-level, 3 m. from the railway station, from which it is reached by an electric tramway. It commands a splendid view of the Apennines on every side except the east, where the Adriatic is seen. It is an active modern town, upon the site of the ancient *Teate Marrucinorum* (q.v.), with woollen and cotton manufactories and other smaller industries. The origin of the see of Chieti dates from the 4th century, S. Justinus being the first bishop. The cathedral has been spoilt by restoration, and the decoration of the exterior is incomplete; the Gothic campanile of 1335 is, however, fine. The cathedral possesses two illuminated missals. Close by is the town hall, which contains a small picture gallery, in which, in 1905, was held an important exhibition of ancient Abruzzese art. The de Laurentiis family possesses a private collection of some importance. To the north of Chieti is the octagonal church of S. Maria del Tricaglio, erected in 1317, which is said (without reason) to stand upon the site of a temple of Diana. The order of the Theatines, founded in 1524, takes its name from the city. Under the Lombards Chieti formed part of the duchy of Benevento; it was destroyed by Pippin in 801, but was soon rebuilt and became the seat of a count. The Normans made it the capital of the Abruzzi.

CHI-FU, **CHEFOO**, or **YEN-T'AI** (as it is called by the natives), a seaport of northern China, on the southern coast of the Gulf of Chih-li, in the province of Shan-tung, near the mouth of the Yi-ho, about 30 m. E. of the city of Têng-chow-fu. It was formerly quite a small place, and had only the rank of an un-walled village; but it was chosen as the port of Têng-chow, opened to foreign trade in 1858 by the treaty of Tientsin, and it is now the residence of a Tao-t'ai, or intendant of circuit, the centre of a gradually increasing commerce, and the seat of a British consulate, a Chinese custom-house, and a considerable foreign settlement. The native town is yearly extending, and though most of the inhabitants are small shop-keepers and coolies of the lowest class, the houses are for the most part well and solidly built of stone. The foreign settlement occupies a position between the native town and the sea, which neither affords a convenient access for shipping nor allows space for any great extension of area. Its growth, however, has hitherto been steady and rapid. Various streets have been laid out, a large

hotel erected for the reception of the visitors who resort to the place as a sanatorium in summer, and the religious wants of the community are supplied by a Roman Catholic and a Protestant church. Though the harbour is deep and extensive, and possessed of excellent anchorage, large vessels have to be moored at a considerable distance from the shore. Chi-fu has continued to show fair progress as a place of trade, but the total volume is inconsiderable, having regard to the area it supplies. In 1880 the total exports and imports were valued at £2,724,000, in 1899 they amounted to £4,228,000, and in 1904 to £4,909,908. In 1895 there entered the port 905 vessels representing a tonnage of 835,248 tons, while in 1905 the number of vessels had risen to 1842, representing a tonnage of 1,492,514 tons. The imports are mainly woollen and cotton goods, iron and opium, and the exports include bean cake, bean oil, peas, raw silk, straw-braid, walnuts, a coarse kind of vermicelli, vegetables and dried fruits. Communication with the interior is only by roads, which are extremely defective, and nearly all the traffic is by pack animals. From its healthy situation and the convenience of its anchorage, Chi-fu has become a favourite rendezvous for the fleets of the European powers in Chinese waters, and consequently it has at times been an important coaling station. It lies in close proximity to Korea, Port Arthur and Wei-hai-Wei, and it shared to some extent in the excitement to which the military and naval operations in these quarters gave rise. The Chi-fu convention was signed here in 1876 by Sir Thomas Wade and Li-Hung-Chang.

CHIGI-ALBANI, the name of a Roman princely family of Siense extraction descended from the counts of Ardenghesca. The earliest authentic mention of them is in the 13th century, and they first became famous in the person of Agostino Chigi (d. 1520), an immensely rich banker who built the palace and gardens afterwards known as the Farnesina, decorated by Raphael, and was noted for the splendour of his entertainments; Pope Julius II. made him practically his finance minister and gave him the privilege of quartering his own (Della Rovere) arms with those of the Chigi. Fabio Chigi, on being made pope (Alexander VII.) in 1655, conferred the Roman patriciate on his family, and created his nephew Agostino prince of Farnese and duke of Ariccia, and the emperor Leopold I. created the latter *Reichsfürst* (prince of the Holy Roman Empire) in 1659. In 1712 the family received the dignity of hereditary marshals of the Church and guardians of the conclave, which gave them a very great importance on the death of every pope. On the marriage in 1735 of another Agostino Chigi (1710-1769) with Giulia Albani, heiress of the Albani, a Venetian patrician family, said to be of Albanian origin, her name was added to that of Chigi. The family owns large estates at Siena.

See A. von Reumont, *Geschichte der Stadt Rom*, vol. iii. (Berlin, 1868); *Almanach de Gotha*.

CHIGWELL, a parish and residential district in the Epping parliamentary division of Essex, England; with stations (Chigwell Lane and Chigwell) on two branches of the Great Eastern railway, 12 m. N.E. from London. Pop. (1901) 2508. The old village church of St Mary, principally Perpendicular, has a Norman south door. The village lies in a branch of the Roding valley, fragments of Hainault Forest lying to the south and east, bordering the village of Chigwell Row. The village of Chigwell appears in the Domesday survey. The pleasant scenery of the neighbourhood, which attracts large numbers both of visitors and of residents from London, is described in Dickens's novel, *Barnaby Rudge*, and the King's Head Inn, Dickens's "Maypole," still stands. The old grammar school, founded by Samuel Harsnett, archbishop of York (d. 1631), whose fine memorial brass is in St Mary's church; has become one of the minor modern institutions of the English public school type. William Penn attended school at Chigwell from his home at Wanstead.

CHIH-LI ("Direct Rule"), the metropolitan province of China, in which is situated Peking, the capital of the empire. It contains eleven prefectural cities, and occupies an area of 58,950 sq. m. The population is 29,400,000, the vast majority

of whom are resident in the plain country. This province forms part of the great delta plain of China proper, 20,000 sq. m. of which are within the provincial boundaries; the remainder of the territory consists of the mountain ranges which define its northern and western frontier. The plain of Chih-li is formed principally by detritus deposited by the Pei-ho and its tributary the Hun-ho ("muddy river"), otherwise known as the Yungting-ko, and other streams having their sources in mountains of Shan-si and other ranges. It is bounded E. by the Gulf of Chih-li and Shan-tung, and S. by Shan-tung and Ho-nan. The proportion of Mahomedans among the population is very large. In Peking there are said to be as many as 20,000 Mahomedan families, and in Pao-ting Fu, the capital of the province, there are about 1000 followers of the prophet. The extremes of heat and cold in Chih-li are very marked. During the months of December, January and February the rivers are frozen up, and even the Gulf of Chih-li is fringed with a broad border of ice. There are four rivers of some importance in the province: the Pei-ho, with the Hun-ho, which rises in the mountains in Mongolia and, flowing to the west of Peking, forms a junction with the Pei-ho at Tientsin; the Shang-si-ho, which rises in the mountains on the north of the province of Shan-si, and takes a south-easterly course as far as the neighbourhood of Ki Chow, from which point it trends north-east and eventually joins the Hun-ho some 15 m. above Tientsin; the Pu-to-ho, which rises in Shan-si, and after running a parallel course to Shang-si-ho on the south, empties itself in the same way into the Hun-ho; and the Lan-ho, which rises in Mongolia, enters the province on the north-east after passing to the west of Jehol, passes the city of Yung-p'ing Fu in its course (which is south-easterly) through Chih-li, and from thence winds its way to the north-eastern boundary of the Gulf of Chih-li. The province contains three lakes of considerable size. The largest is the Ta-lu-tsze Hu, which lies in 37° 40' N. and 115° 20' E.; the second in importance is one which is situated to the east of Pao-ting Fu; and the third is the Tu-lu-tsze Hu, which lies east by north of Shun-te Fu. Four high roads radiate from Peking, one leading to Urga by way of Süan-hwa Fu, which passes through the Great Wall at Chang-kiu K'ow; another, which enters Mongolia through the Ku-pei K'ow to the north-east, and after continuing that course as far as Fung-ning turns in a north-westerly direction to Dolonnor; a third striking due east by way of T'ung-chow and Yung-p'ing Fu to Shan-hai Kwan, the point where the Great Wall terminates on the coast; and a fourth which trends in a south-westerly direction to Pao-ting Fu and on to T'ai-yuen Fu in Shan-si. The mountain ranges to the north of the province abound with coal, notably at Chai-tang, T'ai-gan-shan, Miao-gan-ling, and Fu-tao in the Si-shan or Western Hills. "At Chai-tang," wrote Baron von Richthofen, "I was surprised to walk over a regular succession of coal-bearing strata, the thickness of which, estimating it step by step as I proceeded gradually from the lowest to the highest strata, exceeds 7000 ft." The coal here is anthracite, as is also that at T'ai-gan-shan, where are found beds of greater value than any in the neighbourhood of Peking. In Süan-hwa Fu coal is also found, but not in such quantities as in the places above named. Iron and silver also exist in small quantities in different parts of the province, and hot and warm springs are very common at the foot of the hills along the northern and western edges of the province. The principal agricultural products are wheat, kao-liang, oats, millet, maize, pulse and potatoes. Fruits and vegetables are also grown in large quantities. Of the former the chief kinds are pears, apples, plums, apricots, peaches, persimmons and melons. Tientsin is the Treaty Port of the province.

CHIHUAHUA, a northern frontier state of Mexico, bounded N. and N.E. by the United States (New Mexico and Texas), E. by Coahuila, S. by Durango, and W. by Sinaloa and Sonora. Pop. (1895) 260,008; (1900) 327,784. Area, 87,802 sq. m. The surface of the state is in great part an elevated plateau, sloping gently toward the Rio Grande. The western side, however, is much broken by the Sierra Madre and its spurs, which form elevated valleys of great fertility. An arid sandy plain

extending from the Rio Grande inland for 300 to 350 m. is quite destitute of vegetation where irrigation is not used. There is little rainfall in this region and the climate is hot and dry. The more elevated plateaus and valleys have the heavier rainfall, but the average for the state is barely 39 in.; an impermeable clay substratum prevents its absorption by the soil, and the bare surface carries it off in torrents. The great Bolsón de Mapimí depression, in the S.E. part of the state, was once considered to be an unreclaimable desert, but experiments with irrigation have shown its soil to be highly fertile, and the conversion of the narrow valleys of the sierras on the west into irrigation reservoirs promises to reclaim a considerable part of its area. The only river of consequence is the Conchos, which flows north and north-east into the Rio Grande across the whole length of the state. In the north there are several small streams flowing northward into lakes. Agriculture has made little progress in Chihuahua, and the scarcity of water will always be a serious obstacle to its development outside the districts where irrigation is practicable. The climate and soil are favourable to the production of wheat, Indian corn, beans, indigo, cotton and grapes, from which wine and brandy are made. The principal grape-producing district is in the vicinity of Ciudad Juárez. Stock-raising is an important industry in the mountainous districts of the west, where there is excellent pasturage for the greater part of the year. The principal industry of the state, however, is mining—its mineral resources including gold, silver, copper, mercury, lead and coal. The silver mines of Chihuahua are among the richest in Mexico, and include the famous mining districts of Batopilas, Chihuahuailla, Cosihuiriachic, Jesús María, Parral, and Santa Eulalia or Chihuahua el Viejo. There are more than one hundred of these mines, and the total annual yield at the end of the 19th century was estimated at \$4,500,000. The state is traversed from north to south by the Mexican Central railway, and there are short branches to some of the mining districts.

Chihuahua originally formed part of the province of Nueva Viscaya, with Durango as the capital. In 1777 the northern provinces, known as the Provincias Internas, were separated from the viceroyalty, and in 1786 the provinces were reorganized as intendencias, but Chihuahua was not separated from Durango until 1823. An effort was made to overthrow Spanish authority in 1810, but its leader Hidalgo and two of his lieutenants were captured and executed, after which the province remained passive until the end of the struggle. The people of the state have been active partizans in most of the revolutionary outbreaks in Mexico, and in the war of 1862–66 Chihuahua was loyal to Juárez. The principal towns are the capital Chihuahua, El Parral, 120 m. S.S.E. of the state capital, in a rich mining district (pop. 14,748 in 1900), Ciudad Juárez and Jimenez, 120 m. S.E. of Chihuahua (pop. 5881 in 1900).

CHIHUAHUA, a city of Mexico, capital of the above state, on the Chihuahua river, about 1000 m. N.W. of Mexico City and 225 m. S. by E. of El Paso. Pop. (1895) 18,279; (1900) 30,405. The city stands in a beautiful valley opening northward and hemmed in on all other sides by spurs of the Sierra Madre. It is 4635 ft. above sea-level, and its climate is mild and healthy. The city is laid out regularly, with broad streets, and a handsome plaza with a monument to Hidalgo and his companions of the revolution of 1810, who were executed here. The most noteworthy of its public buildings is the fine old parish church of San Francisco, begun in 1717 and completed in 1789, one of the best specimens of 18th-century architecture in Mexico. It was built, it is said, with the proceeds of a small tax on the output of the Santa Eulalia mine. Other prominent buildings are the government palace, the Porfirio Diaz hospital, the old Jesuit College (now occupied by a modern institution of the same character), the mint, and an aqueduct built in the 18th century. Chihuahua is a station on the Mexican Central railway, and has tramways and telephones. Mining is the principal occupation of the surrounding district, the famous Santa Eulalia or Chihuahua el Viejo mines being about 12 m. from the city. Next in importance is agriculture, especially fruit-growing. Manufacturing

is making good progress, especially the weaving of cotton fabrics by modern methods. The manufacture of cotton and woollen goods are old industries in Chihuahua, but the introduction of American skill and capital toward the end of the 19th century placed them on an entirely new footing. The manufacture of gunpowder for mining operations is another old industry.

Chihuahua was founded between 1703 and 1705 as a mining town, and was made a villa in 1715 with the title San Felipe el Real de Chihuahua. Because of the rich mines in its vicinity it soon became one of the most prosperous towns in northern Mexico, although the state was constantly raided by hostile Indians. In 1763 it had a population of nearly 5000. The war of independence was followed by a period of decline, owing to political disorder and revolution, which lasted until the presidency of General Porfirio Diaz. In the war between Mexico and the United States, Chihuahua was captured on the 1st of March 1847, by Colonel A. W. Doniphan, and again on the 7th of March by General Price. In 1864 President Juárez made the city his provisional capital for a short time.

CHILAS, a hill village in the North-West Frontier Province of India. It is dominated by a fort on the left bank of the Indus, about 50 m. below Bunji, 4100 ft. above sea-level. It was occupied by a British force early in 1893, when a determined attack was made on the place by the Kohistanis from the Indus valley districts to the south-west, aided by contingents from Darel and Tangir west of Gilgit and north of the Indus. Its importance consists in its position with reference to the Kashmir-Gilgit route via Astor, which it flanks. It is now connected with Bunji by a metalled road. Chilas is also important from its command of a much shorter and more direct route to Gilgit from the Punjab frontier than that of Kashmir and the Burzil pass. By the Kashmir route Gilgit is 400 m. from the rail-head at Rawalpindi. The Kagan route would bring it 100 m. nearer, but the unsettled condition of the country through which the road passes has been a bar to its general use.

CHILBLAINS (or **KIBE**; *Erythema pernio*), a mild form of frostbite, affecting the fingers or toes and other parts, and causing a painful inflammatory swelling, with redness and itching of the affected part. The chief points to be noticed in its aetiology are (1) that the lesions occur in the extremities of the circulation, and (2) that they are usually started by rapid changes from heat to cold or vice versa. The treatment is both general and local. In the general treatment, if a history of blanching fingers (fingers or hands going "dead") can be obtained, the chilblains may be regarded as mild cases of Raynaud's disease, and these improve markedly under a course of nitrites. Cardiac tonics are often helpful, especially in those cases where there is some attendant lesion of the heart. But the majority of cases improve wonderfully on a good course of a calcium salt, e.g. calcium lactate or chloride; fifteen grains three times a day will answer in most cases. The patient should wash in soft tepid water, and avoid extremes of heat and cold. In the local treatment, two drugs are of great value in the early congestive stage—ichthyol and formalin. Ichthyol, 10 to 20% in lanoline spread on linen and worn at night, often dispels an attack at the beginning. Formalin is equally efficacious, but requires more skill in its use. It can be used as an ointment, 10 to 50% for delicate skins, stronger for coarser skins. It should be replaced occasionally by lanoline. If the stage of ulceration has been reached, a paste made from the following prescription, spread thickly on linen and frequently changed, soon cures:—Hydrarg. ammoniat. gr. v., ichthyol Mx, pulvisis zinci oxidi ʒiv, vaseline ʒss.

CHILD, SIR FRANCIS (1642–1713), English banker, was a Wiltshire man, who, having been apprenticed to a goldsmith, became himself a London goldsmith in 1664. In 1671 he married Elizabeth (d. 1720), daughter of another goldsmith named William Wheeler (d. 1663), and with his wife's stepfather, Robert Blanchard (d. 1681), took over about the same time the business of goldsmiths hitherto carried on by the Wheelers. This was the beginning of Child's Bank. Child soon gave up the business of a goldsmith and confined himself to that of a banker. He inherited some wealth and was very successful in

business; he was jeweller to the king, and lent considerable sums of money to the government. Being a freeman of the city of London, Child was elected a member of the court of common council in 1681; in 1689 he became an alderman, and in the same year a knight. He served as sheriff of London in 1691 and as lord mayor in 1699. His parliamentary career began about this time. In 1698 he was chosen member of parliament for Devizes and in 1702 for the city of London, and was again returned for Devizes in 1705 and 1710. He died on the 4th of October 1713, and was buried in Fulham churchyard. Sir Francis, who was a benefactor to Christ's hospital, bought Osterley Park, near Isleworth, now the residence of his descendant the earl of Jersey.

Child had twelve sons. One, Sir Robert, an alderman, died in 1721. Another, Sir Francis (c. 1684-1740), was lord mayor of London in 1732, and a director of the East India Company. He was chosen member of parliament for the city of London in 1722, and was member for Middlesex from 1727 until his death. After the death of the younger Sir Francis at Fulham on the 20th of April 1740 the banking business passed to his brother Samuel, and the bank is still owned by his descendants, the principal proprietor being the earl of Jersey. Child's Bank was at first conducted at the Marygold, next Temple Bar in Fleet Street, London; and the present bank occupies the site formerly covered by the Marygold and the adjacent Devil tavern.

CHILD, FRANCIS JAMES (1825-1896), American scholar and educationist, was born in Boston on the 1st of February 1825. He graduated at Harvard in 1846, taking the highest rank in his class in all subjects; was tutor in mathematics in 1846-1848; and in 1848 was transferred to a tutorship in history, political economy and English. After two years of study in Europe, in 1851 he succeeded Edward T. Channing as Boylston professor of rhetoric, oratory and elocution. Child studied the English drama (having edited *Four Old Plays* in 1848) and Germanic philology, the latter at Berlin and Göttingen during a leave of absence, 1849-1853; and he took general editorial supervision of a large collection of the British poets, published in Boston in 1853 and following years. He edited Spenser (5 vols., Boston, 1855), and at one time planned an edition of Chaucer, but contented himself with a treatise, in the *Memoirs of the American Academy of Arts and Sciences* for 1863, entitled "Observations on the Language of Chaucer's Canterbury Tales," which did much to establish Chaucerian grammar, pronunciation and scansion as now generally understood. His largest undertaking, however, grew out of an original collection, in his British Poets series, of *English and Scottish Ballads*, selected and edited by himself, in eight small volumes (Boston, 1857-1858). Thenceforward the leisure of his life—much increased by his transfer, in 1876, to the new professorship of English—was devoted to the comparative study of British vernacular ballads. He accumulated, in the university library, one of the largest folklore collections in existence, studied manuscript rather than printed sources, and carried his investigations into the ballads of all other tongues, meanwhile giving a sedulous but conservative hearing to popular versions still surviving. At last his final collection was published as *The English and Scottish Popular Ballads*, at first in ten parts (1882-1898), and then in five quarto volumes, which remain the authoritative treasury of their subject. Professor Child worked—and overworked—to the last, dying in Boston on the 11th of September 1896, having completed his task save for a general introduction and bibliography. A sympathetic biographical sketch was prefixed to the work by his pupil and successor George L. Kittredge.

CHILD, SIR JOHN (d. 1690), governor of Bombay, and in fact if not in name the first governor-general of the British settlements in India, was born in London. He was sent as a little boy to his uncle, the chief of the factory at Rajapur; and in 1682 was appointed chief of the East India Company's affairs at Surat and Bombay, while at the same time his brother, Sir Josiah Child (q.v.), was governor of the company at home. The two brothers showed themselves strong men and guided the affairs of the company through the period of struggle between the

Moguls and Mahrattas. They have been credited by history with the change from unarmed to armed trade on the part of the company; but as a matter of fact both of them were loth to quarrel with the Mogul. War broke out with Aurangzeb in 1689, but in the following year Child had to sue for peace, one of the conditions being that he should be expelled from India. He escaped this expulsion by his death in 1690.

CHILD, SIR JOSIAH (1630-1699), English merchant, economist and governor of the East India Company, was born in London in 1630, the second son of Richard Child, a London merchant of old family. After serving his apprenticeship in the business, to which he succeeded, he started on his own account at Portsmouth, as victualler to the navy under the Commonwealth, when about twenty-five. He amassed a comfortable fortune, and became a considerable stock-holder in the East India Company, his interest in India being accentuated by the fact that his brother John (q.v.) was making his career there. He was returned to parliament in 1659 for Petersfield; and in later years sat for Dartmouth (1673-1678) and for Ludlow (1685-1687). He was made a baronet in 1678. His advocacy, both by speech and by pen, under the pseudonym of Philopatris, of the East India Company's claims to political power, as well as to the right of restricting competition with its trade, brought him to the notice of the shareholders, and he became a director in 1677, and, subsequently, deputy-governor and governor. In this latter capacity he was for a considerable time virtually the sole ruler of the company, and directed its policy as if it were his own private business. He and his brother have been credited with the change from unarmed to armed traffic; but the actual renunciation of the Roe doctrine of unarmed traffic by the company was resolved upon in January 1686, under Governor Sir Joseph Ash, when Child was temporarily out of office. He died on the 22nd of June 1699. Child made several important contributions to the literature of economics; especially *Brief Observations concerning Trade and the Interest of Money* (1668), and *A New Discourse of Trade* (1668 and 1690). He was a moderate in those days of the "mercantile system," and has sometimes been regarded as a sort of pioneer in the development of the free-trade doctrines of the 18th century. He made various proposals for improving British trade by following Dutch example, and advocated a low rate of interest as the "*causa causans* of all the other causes of the riches of the Dutch people." This low rate of interest he thought should be created and maintained by public authority. Child, whilst adhering to the doctrine of the balance of trade, observed that a people cannot always sell to foreigners without ever buying from them, and denied that the export of the precious metals was necessarily detrimental. He had the mercantilist partiality for a numerous population, and became prominent with a new scheme for the relief and employment of the poor; it is noteworthy also that he advocated the reservation by the mother country of the sole right of trade with her colonies. Sir Josiah Child's eldest son, Richard, was created Viscount Castlemain in 1718 and earl of Tylney in 1731.

See also Macaulay, *History of England*, vol. iv.; R. Grant, *Sketch of the History of the East India Company* (1813); D. Macpherson, *Annals of Commerce* (1805); B. Willson, *Ledger and Sword* (1903).
(T. A. I.)

CHILD, LYDIA MARIA (1802-1880), American author, was born at Medford, Massachusetts, on the 11th of February 1802. She was educated at an academy in her native town and by her brother Convers Francis (1795-1863), a Unitarian minister and from 1842 to 1863 Parkman professor in the Harvard Divinity School. Her first stories, *Hobomok* (1824) and *The Rebels* (1825), were popular successes. She was a schoolmistress until 1828, when she married David Lee Child (1794-1874), a brilliant but erratic Boston lawyer and journalist. From 1826 to 1834 she edited *The Juvenile Miscellany*, the first children's monthly periodical in the United States. About 1831 both she and her husband began to identify themselves with the anti-slavery cause, and in 1833 she published *An Appeal for that Class of Americans called Africans*, a stirring portrayal of the evils of slavery, and an argument for immediate abolition, which had

a powerful influence in winning recruits to the anti-slavery cause. Henceforth her time was largely devoted to the anti-slavery cause. From 1840 to 1844, assisted by her husband, she edited the *Anti-Slavery Standard* in New York City. After the Civil War she wrote much in behalf of the freedmen and of Indian rights. She died at Wayland, Massachusetts, on the 20th of October 1880. In addition to the books above mentioned, she wrote many pamphlets and short stories and *The (American) Frugal Housewife* (1829), one of the earliest American books on domestic economy, *The Mother's Book* (1831), a pioneer cook-book republished in England and Germany, *The Girls' Own Book* (1831), *History of Women* (2 vols., 1832), *Good Wives* (1833), *The Anti-Slavery Catechism* (1836), *Philothea* (1836), a romance of the age of Pericles, perhaps her best book, *Letters from New York* (2 vols., 1843-1845), *Fact and Fiction* (1847), *The Power of Kindness* (1851), *Isaac T. Hopper: a True Life* (1853), *The Progress of Religious Ideas through Successive Ages* (3 vols., 1855), *Autumnal Leaves* (1857), *Looking Toward Sunset* (1864), *The Freedman's Book* (1865), *A Romance of the Republic* (1867), and *Aspirations of the World* (1878).

See *The Letters of Lydia Maria Child, with a Biographical Introduction by J. G. Whittier* (Boston, 1883); and a chapter in T. W. Higginson's *Contemporaries* (Boston, 1899).

CHILD, the common term for the offspring of human beings, generally below the age of puberty; the term is the correlative of "parent," and applies to either sex, though some early dialectical uses point to a certain restriction to a girl. The word is derived from the A.S. *cild*, an old Teutonic word found in English only, in other Teutonic languages *kind* and its variants being used, usually derived from the Indo-European root *ken*, seen in Gr. *genos*, Lat. *genus*, and Eng. "kin"; *cild* has been held to be a modification of the same root, but the true root is *kilth*, seen in Goth. *killthei*, womb, an origin which appears in the expressions "child-birth," "to be with child," and the like; the plural in A.S. was *cild*, and later *cildru*, which in northern M.E. became *childre* or *childer*, a form dialectically extant, and in southern English *childeren* or *children* (with the plural termination -en, as in "brethren"). There are several particular uses of "child" in the English version of the Bible, as of a young man in the "Song of the three holy children," of descendants or members of a race, as in "children of Abraham," and also to express origin, giving a description of character, as "children of darkness." During the 13th and 14th centuries "child" was used, in a sense almost amounting to a title of dignity, of a young man of noble birth, probably preparing for knighthood. In the *York Mysteries* of about 1440 (quoted in the *New English Dictionary*) occurs "be he churl or child," obviously referring to gentle birth, cf. William Bellenden's translation (1553) of Livy (ii. 124) "than was in Rome an nobill childe . . . namit Caius Mucius." The spelling "childe" is frequent in modern usage to indicate its archaic meaning. Familiar instances are in the line of an old ballad quoted in *King Lear*, "childe Roland to the dark tower came," and in Byron's *Childe Harold*. With this use may be compared the Spanish and Portuguese *Infante* and *Infanta*, and the early French use of *Valet* (*q.v.*).

Child-study.—The physical, psychological and educational development of children, from birth till adulthood, has provided material in recent years for what has come to be regarded as almost a distinct part of comparative anthropological or sociological science, and the literature of adolescence (*q.v.*) and of "child-study" in its various aspects has attained considerable proportions. In England the British Child Study Association was founded in 1894, its official organ being the *Paidologist*, while similar work is done by the Childhood Society, and, to a certain extent, by the Parents' National Educational Union (which issues the *Parents'*

Review). In America, where specially valuable work has been done, several universities have encouraged the study (notably Chicago, while under the auspices of Professor John Dewey); and Professor G. Stanley Hall's initiative has led to elaborate inquiries, the principal periodical for the movement being the *Pedagogical Seminary*. The impetus to this study of the child's mind and capacities was given by the classic work of educationists like J. A. Comenius, J. H. Pestalozzi, and F. W. A. Froebel, but more recent writers have carried it much further, notably W. T. Preyer (*The Mind of the Child*, 1881), whose psychological studies stamp him as one of the chief pioneers in new methods of investigation. Other authorities of first-rate importance (their chief works only being given here) are J. Sully (*Studies of Childhood*, 1896), Earl Barnes (*Studies in Education*, 1896, 1902), J. M. Baldwin (*Mental Development in the Child and the Race*, 1895), Sigismund (*Kind und Welt*, 1897), A. F. Chamberlain (*The Child*, 1900), G. Stanley Hall (*Adolescence*, 1904; he had from 1882 been the leader in America of such investigations), H. Holman and R. Langdon Down (*Practical Child Study*, 1899), E. A. Kirkpatrick (*Fundamentals of Child-study*, 1903), and Prof. Tracy of Toronto (*Psychology of Childhood*, 5th ed., 1901); while among a number of contributions worth particular attention may be mentioned W. B. Drummond's excellent summary, *Introduction to Child Study* (1907), which deals succinctly with methods and results; Irving King's *Psychology of Child Development* (1906, useful for its bibliography); Prof. David R. Major's *First Steps in Mental Growth* (1906); and Miss M. Shinn's *Notes on the Development of a Child* (1893) and Mrs Louise E. Hogan's *Study of a Child* (1898), which are noteworthy among individual and methodical accounts of what children will do. In such books as those cited a great deal of important material has been collected and analysed, and a number of conclusions suggested which bear both on psychology and the science of education; but it must be borne in mind, as regards a great deal of the voluminous literature of the subject, that it is often more pertinent to general psychology and hygiene than to any special conclusions as to the essential nature of a child—whatever "a child" generically may be as the special object of a special science. The child, after all, is in a transition stage to an adult, and there is often a tendency in modern "child students" to interpret the phenomena exhibited by a particular child with a *parti pris*, or to exaggerate child-study—which is really interesting as providing the knowledge of growth towards full human equipment—as though it involved the discovery of some distinct form of animal, of separate value on its own account.

Growth.—Into the psychical characteristics and development of the child and all the interesting educational problems involved it is impossible to enter here, and reference must be made to the works cited above. But a knowledge of the more important features of normal physical development has a constant importance. Some of these, as matters of comparative physiology or pathology, are dealt with in other articles in this work. One of these chief matters of interest is weight and height, and this is naturally affected by race, nutrition and environment. But while the standard in different countries somewhat differs, the British average for healthy children may here be followed. At birth the average weight of a baby is a little over 7 lb and the length about 20 in. The following are the averages for weight and height, taking the age in years of the child at the last birthday:—

Height, in inches.

Age.	1	2	3	4	5	6	7	8	9	10	11	12	13	14	15
Girls . .	28.7	32.5	35	38	40.5	42.8	44.5	46.6	48.7	51	53.1	55.6	57.7	59.8	60.9
Boys . .	29	32.5	35	38	41	44	46	47	49	51.8	53.5	55	57	59.3	62

Weight, in pounds.

Age.	1	2	3	4	5	6	7	8	9	10	11	12	13	14	15
Girls . .	19.8	25.5	30	34	39.2	41.7	47.5	52.1	55.5	62	68	76.4	87.2	96.7	102.7
Boys . .	20.5	26.5	31.2	35	41.2	44.4	49.7	54.9	60.4	67.5	72	76.7	82.6	92	106

See also CHILDREN, LAW RELATING TO; CHILDREN'S COURTS; CHILDREN'S GAMES; INFANT; & C.

CHILDEBERT, the name of three Frankish kings.

CHILDEBERT I. (d. 558) was one of the four sons of Clovis. In the partition of his father's realm in 511 he received as his share the town of Paris, and the country to the north as far as the river Somme, and to the west as far as the English Channel, with the Armorican peninsula. In 524, after the murder of Chlodomer's children, Childebert annexed the cities of Chartres and Orleans. He took part in the various expeditions against the kingdom of Burgundy, and in 534 received as his share of the spoils of that kingdom the towns of Mâcon, Geneva and Lyons. When Vitiges, the king of the Ostrogoths, ceded Provence to the Franks in 535, the possession of Arles and Marseilles was guaranteed to Childebert by his brothers. Childebert also made a series of expeditions against the Visigoths of Spain; in 542 he took possession of Pampeluna with the help of his brother Clotaire I., and besieged Saragossa, but was forced to retreat. From this expedition he brought back to Paris a precious relic, the tunic of St Vincent, in honour of which he built at the gates of Paris the famous monastery of St Vincent, known later as St Germain-des-Prés. He died without issue in 558, and was buried in the abbey he had founded, where his tomb has been discovered.

See "Nouveaux documents sur le tombeau de Childebert à Saint-Germain-des-Prés," in the *Bulletin de la Société des Antiquaires* (1887).

CHILDEBERT II. (570-595), king of Austrasia, was a son of Sigebert. When his father was assassinated in 575, Childebert was taken from Paris by Gundobald, one of his faithful *leudes*, to Metz, where he was recognized as sovereign. He was then only five years old, and during his long minority the power was disputed between his mother Brunhilda and the nobles. Chilperic, king at Paris, and King Gontran of Burgundy, sought alliance with Childebert, who was adopted by both in turn. But after the assassination of Chilperic in 584, and the dangers occasioned to the Frankish monarchy by the expedition of Gundobald in 585, Childebert threw himself unreservedly into the arms of Gontran. By the pact of Andelot in 587 Childebert was recognized as Gontran's heir, and with his uncle's help he quelled the revolts of the nobles and succeeded in seizing the castle of Woëvre. Many attempts were made on his life by Fredegond, who was anxious to secure Gontran's inheritance for her son Clotaire II. On the death of Gontran in 592 Childebert annexed the kingdom of Burgundy, and even contemplated seizing Clotaire's estates and becoming sole king of the Franks. He died, however, in 595. Childebert II. had had relations with the Byzantine empire, and fought in 585 in the name of the emperor Maurice against the Lombards in Italy.

CHILDEBERT III. was one of the last and feeblest of the Merovingians. A son of King Theuderich III., he succeeded his brother Clovis III. in 695, and reigned until 711.

See B. Krusch, "Zur Chronologie der merowingischen Könige," in *Forschungen zur deutschen Geschichte*, xxii. 451-490. (C. P. F.)

CHILDERIC, the name of three Frankish kings.

CHILDERIC I. (c. 437-481), king of the Salian Franks, succeeded his father Merwich (Merwing) as king about 457. With his tribe he was established around the town of Tournai, on lands which he had received as a *foederalus* of the Romans, and for some time he kept the peace with his allies. About 463, in conjunction with the Roman general Egidius, he fought against the Visigoths, who hoped to extend their dominion along the banks of the Loire; after the death of Egidius he assisted Count Paul in attempting to check an invasion of the Saxons. Paul having perished in the struggle, Childeric delivered Angers from some Saxons, followed them to the islands at the mouth of the Loire, and massacred them there. He also stopped a band of the Alamanni who wished to invade Italy. These are all the facts known about him. The stories of his expulsion by the Franks; of his stay of eight years in Thuringia with King Basin and his wife Basine; of his return when a faithful servant advised him that he could safely do so by sending to him half of a piece of gold which he had broken

with him; and of the arrival at Tournai of Queen Basine, whom he married, are entirely legendary. After the fall of the Western Empire in 476 there is no doubt that Childeric regarded himself as freed from his engagements towards Rome. He died in 481 and was buried at Tournai, leaving a son Clovis (*q.v.*), afterwards king of the Franks. His tomb was discovered in 1653, when numerous precious objects, arms, jewels, coins and a ring with a figure of the king, were found.

CHILDERIC II. (c. 653-673), king of Austrasia, was a son of the Frankish king Clovis II., and in 660, although a child, was proclaimed king of Austrasia, while his brother, Clotaire III., ruled over the rest of the dominions of Clovis. After the death of Clotaire in 670 he became ruler of the three Frankish kingdoms, Austrasia, Neustria and Burgundy, but soon quarrelled with some supporters in Neustria, and was assassinated whilst hunting. He was buried at St Germain near Paris.

CHILDERIC III. (d. c. 751), king of the Franks, was the last king of the Merovingian dynasty. The throne had been vacant for seven years when the mayors of the palace, Carloman and Pippin the Short, decided in 743 to recognize Childeric as king. We cannot say whose son he was, or what bonds bound him to the Merovingian family. He took no part in public business, which was directed, as before, by the mayors of the palace. When in 747 Carloman retired into a monastery, Pippin resolved to take the royal crown for himself; taking the decisive step in 751 after having received the celebrated answer of Pope Zacharias that it were better to name king him who possessed the power than him who possessed it not. Childeric was dethroned and placed in the monastery of St Omer; his son, Theuderich, was imprisoned at Saint-Wandrille.

See W. Junghans *Die Geschichte der fränkischen Könige Childeric und Clodovech* (Göttingen, 1857); J. J. Chiflet, *Anastasis Childerici I. Francorum regis* (Antwerp, 1655); J. B. D. Cochet, *Le Tombeau de Childeric I, roi des Francs* (Paris, 1859); and E. Lavisse, *Histoire de France*, tome ii. (Paris, 1903).

CHILDERS, HUGH CULLING EARDLEY (1827-1896), British statesman, was born in London on the 25th of June 1827. On leaving Cambridge he went out to Australia (1850), and became a member of the government of Victoria, but in 1857 returned to England as agent-general of the colony. Entering parliament in 1860 as Liberal member for Pontefract (a seat that he continued to hold till 1885), he became civil lord of the admiralty in 1864, and in 1865 financial secretary to the treasury. Childers occupied a succession of prominent posts in the various Gladstone ministries. He was first lord of the admiralty from 1868 to 1871, and as such inaugurated a policy of retrenchment. Ill-health compelled his resignation of office in 1871, but next year he returned to the ministry as chancellor of the duchy of Lancaster. From 1880 to 1882 he was secretary for war, a post he accepted somewhat unwillingly; and in that position he had to bear the responsibility for the reforms which were introduced into the war office under the parsimonious conditions which were then part of the Liberal creed. During his term of office the Egyptian War occurred, in which Childers acted with creditable energy; and also the Boer War, in which he and his colleagues showed to less advantage. From 1882 to 1885 he was chancellor of the exchequer, and the beer and spirit duty in his budget of the latter year was the occasion of the government's fall. Defeated at the general election at Pontefract, he was returned as a Home Ruler (one of the few Liberals who adopted this policy before Mr Gladstone's conversion) in 1886 for South Edinburgh, and was home secretary in the ministry of 1886. When the first Home Rule bill was introduced he demurred privately to its financial clauses, and their withdrawal was largely due to his threat of resignation. He retired from parliament in 1892, and died on the 29th of January 1896, his last piece of work being the drafting of a report for the royal commission on Irish financial relations, of which he was chairman. Childers was a capable and industrious administrator of the old Liberal school, and he did his best, in the political conditions then prevailing, to improve the naval and military administration while he was at the admiralty and war office. His own bent was towards finance, but no

striking reform is associated with his name. His most ambitious effort was his attempt to effect a conversion of consols in 1884, but the scheme proved a failure, though it paved the way for the subsequent conversion in 1888.

The *Life* (1901) of Mr Childers, by his son, throws some interesting side-lights on the inner history of more than one Gladstonian cabinet.

CHILDERS, ROBERT CAESAR (1838-1876), English Oriental scholar, son of the Rev. Charles Childers, English chaplain at Nice, was born in 1838. In 1860 he received an appointment in the civil service of Ceylon, which he retained until 1864, when he was compelled to return to England owing to ill-health. He had studied Pāli during his residence in Ceylon, under Yātrā-mullé Unnānsé, a learned Buddhist for whom he cherished a life-long respect, and he had gained an insight into the Sinhalese character and ways of thought. In 1860 he published the first Pāli text ever printed in England, and began to prepare a Pāli dictionary, the first volume of which was published in 1872, and the second and concluding volume in 1875. In the following year it was awarded the Volney prize by the Institute of France, as being the most important philological work of the year. He was a frequent contributor to the *Journal of the Royal Asiatic Society*, in which he published the *Mahā-parinibbāna Sutta*, the Pāli text giving the account of the last days of Buddha's life. In 1872 he was appointed sub-librarian at the India Office, and in the following year he became the first professor of Pāli and Buddhist literature at University College, London. He died in London on the 25th of July 1876.

CHILDREN, LAW RELATING TO. English law has always in theory given to children the same remedies as to adults for ill-usage, whether by their parents or by others, and has never recognized the *patria potestas* as known to the earlier Roman law; and while powers of discipline and chastisement have been regarded as necessarily incident to paternal authority, the father is civilly liable to his children for wrongs done to them. The only points in which infancy created a defect in civil status were that infants were subject to the restraints on complete freedom of action involved in their being in the legal custody of the father, and that it was and is lawful for parents, guardians, employers and teachers to inflict corporal punishment proportioned in amount and severity to the nature of the fault committed and the age and mental capacity of the child punished. But the court of chancery, in delegated exercise of the authority of the sovereign as *parens patriæ*, always asserted the right to take from parents, and if necessary itself to assume the wardship of children where parental rights were abused or serious cruelty was inflicted, the power being vested in the High Court of Justice. Abuse of the power of correction was regarded as giving a cause of action or prosecution for assault; and if attended by fatal results rendered the parent liable to indictment for murder or manslaughter.

The conception of what constitutes cruelty to children undoubtedly changed considerably with the relaxation of the accepted standard of severity in domestic or scholastic discipline and with the growth of new ideas as to the duties of parents to children, which in their latest developments tend enormously to enlarge the parental duties without any corresponding increase of filial obligations.

Starting from the earlier conception, which limited ill-treatment legally punishable to actual threats or blows, the common law came to recognize criminal liability in cases where persons, bound under duty or contract to supply necessaries to a child, unable by reason of its tender years to provide for itself, wilfully neglected to supply them, and thereby caused the death of the child or injury to its health, although no actual assault had been committed. Questions have from time to time arisen as to what could be regarded as necessary within this rule; and quite apart from legislation, popular opinion has influenced courts of justice in requiring more from parents and employers than used to be required. But parliament has also intervened to punish abandonment or exposure of infants of under two years, whereby their lives are endangered, or their health has been or is likely

to be permanently injured (Offences against the Person Act of 1861, s. 27), and the neglect or ill-treatment of apprentices or servants (same act, s. 26, and Conspiracy and Protection of Property Act 1875, s. 6). By the Poor Law Amendment Act 1868, parents were rendered *summarily* punishable who wilfully neglected to provide adequate food, clothing, medical aid or lodging for their children under fourteen years of age in their custody, whereby the health of the child was or was likely to be seriously injured. This enactment (now superseded by later legislation) made no express exception in favour of parents who had not sufficient means to do their duty without resort to the poor law, and was construed as imposing criminal liability on parents whose peculiar religious tenets caused them advisedly to refrain from calling in a doctor to a sick child.

The chief progress in the direction of adequate protection for children prior to 1889 lay less in positive legal enactment on the subject than in the institution of an effective system of police, whereby it became possible to discover and repress cruelty punishable under the ordinary law. It is quite inaccurate to say that children had very few rights in England, or that animals were better protected. But before the constitution of the present police force, and in the absence of any proper system of public prosecution, it is undeniable that numberless cases of neglect and ill-treatment went unpunished and were treated as nobody's business, because there was no person ready to undertake in the public interest the protection of the children of cruel or negligent parents. In 1889 a statute was passed with the special object of preventing cruelty to children. This act was superseded in 1894 by a more stringent act, which was repealed by the Prevention of Cruelty to Children Act 1904, in its turn superseded for the most part by the Children Act 1908, which introduced many new provisions in the law relating to children and specifically deals with the offence of "cruelty" to them. This offence can only be committed by a person over sixteen in respect of a child under sixteen of whom he has "custody," "charge" or "care." The act presumes that a child is in the custody of its parents, step-parents, or a person cohabiting with its parent, or of its guardians or persons liable by law to maintain it; that it is in the charge of a person to whom the parent has committed such charge (e.g. a schoolmaster), and that it is in the care of a person who has actual possession or control of it. Cruelty is defined as consisting in assault, ill-treatment (falling short of actual assault), neglect, abandonment or exposure of the child in a manner likely to cause *unnecessary* suffering or injury to health, including injury to or loss of sight, hearing or limb, or any organ of the body or any mental derangement; and the act or omission must be wilful, *i.e.* deliberate and intentional, and not merely accidental or inadvertent. The offence may be punished either summarily or on indictment, and the offender may be sent to penal servitude if it is shown that he was directly or indirectly interested in any sum of money payable on the death of the child, e.g. by having taken out a policy permitted under the Friendly Societies Acts. A parent or other person legally liable to maintain a child or young person will be deemed to have "neglected" him by failure to provide adequate food, clothing, medical aid, or lodging, or if in the event of inability to provide such food, &c., by failure to take steps to procure the same under acts relating to the relief of the poor.

These statutes overlap the common law and the statutes already mentioned. Their real efficacy lies in the main in the provisions which facilitate the taking of evidence of young children, in permitting poor law authorities to prosecute at the expense of the rates, and in permitting a constable on arresting the offender to take the child away from the accused, and the court of trial on conviction to transfer the custody of the child from the offender to some fit and willing person, including any society or body corporate established for the reception of poor children or for the prevention of cruelty to children. The provisions of the acts as to procedure and custody extend not only to the offence of cruelty but also to all offences involving bodily injury to a child under sixteen, such as abandonment, assault, kidnapping and illegally engaging a child in a dangerous public

performance. The act of 1908 also makes an endeavour to check the heavy mortality of infants through "overlying,"¹ enacting that where it is proved that the death of an infant under three years of age was caused by suffocation whilst the infant was in bed with some other person over the age of sixteen, and that that person was at the time of going to bed under the influence of drink, that other person shall be deemed to have neglected the child in manner likely to cause injury to its health, as mentioned above. The acts have been utilized with great zeal and on the whole with much discretion by various philanthropic societies, whose members make it their business to discover the ill-treated and neglected children of all classes in society, and particularly by the Society for the Prevention of Cruelty to Children, which is incorporated under royal charter of the 28th of May 1895, for the purposes *inter alia* of preventing the public and private wrongs of children, and the corruption of their morals and of taking action to enforce the laws for their protection.

The act of 1908 enacted more stringent provisions against baby-farming (*q.v.*). The Infant Life Protection Act of 1897 did not apply where only one child was taken, but now by the act of 1908, where a person undertakes for reward the nursing and maintenance of one or more infants under the age of seven years apart from their parents or having no parents, he must give notice in writing to the local authority within forty-eight hours from the reception of the child. If an infant is already in the care of a person without reward and he undertakes to continue the nursing for reward, such undertaking is a reception of the child. The notice to the local authority must state the name, sex, date and place of birth of the infant, the name and address of the person receiving the infant and of the person from whom the infant was received. Notice must also be given of any change of address of the person having the care of the infant, or of the death of the infant, or of its removal to the care of some other person, whose name and address must also be given. It is the duty of local authorities to provide for the carrying-out in their districts of that portion of the act which refers to nursing and maintenance of infants, to appoint infants' protection visitors, to fix the number of infants which any person may retain for nursing, to remove infants improperly kept, &c. Relatives or legal guardians of an infant who undertake its nursing and maintenance, hospitals; convalescent homes, or institutions, established for the protection and care of infants, and conducted in good faith for religious and charitable purposes, as well as boarding schools at which efficient elementary education is given, are exempt from the provisions of the act.

The acts of 1904 and 1908 deal with many other offences in relation to children and young persons. The act of 1904 introduced restrictions on the employment of children which lie on the border land between cruelty and the regulation of child labour. It prohibits custodians of children from taking them, or letting them be, in the street or in public-houses to sing, play, perform or sell between 9 P.M. and 6 A.M. These provisions apply to boys under fourteen and girls under sixteen. There are further prohibitions (1) on allowing children under eleven to sing, play, perform or be exhibited for profit, or offer anything for sale in public-houses or places of public amusement at any hour without a licence from a justice, which is granted only as to children over ten and under stringent conditions; (2) on allowing children under sixteen to be trained as

acrobats, contortionists, or circus performers, or for any dangerous performance; and the Children's Dangerous Performances Act 1879, as amended in 1897, makes it an offence to employ a male young person under sixteen and a female under eighteen in a dangerous public performance.

The act of 1908 renders liable to a fine not exceeding £25, or alternatively, or in addition thereto, imprisonment with or without hard labour for any term not exceeding three months, any custodian, &c., of any child or young person who allows him to be in any street, premises or place for the purpose of begging or receiving alms, or of inducing the giving of alms, whether or not there is a pretence of singing, playing, performing or offering anything for sale. An important departure in the act of 1908 was the attempt to prevent the exposure of children to the risk of burning. Any custodian, &c., of a child under seven who allows that child to be in a room containing an open grate not sufficiently protected to guard against the risk of burning or scalding is liable on summary conviction to a fine not exceeding £10. Provision is made against allowing children between the ages of four and sixteen to be in brothels; it is also made a misdemeanour if any custodian, &c., of a girl under sixteen causes or encourages her seduction or prostitution, and any person having the custody of a young girl may be bound over to exercise proper care if it is shown to the satisfaction of a court of summary jurisdiction, on the complaint of any person, that she is exposed to such risk.

The act of 1908, following legislation in many parts of the United States and in some of the British colonies, places a penalty on selling tobacco to any person apparently under the age of sixteen, whether for his own use or not. It empowers constables and park keepers to seize tobacco in the possession of any person apparently under sixteen found smoking in any street or public place, as well as to search them; it also empowers a court of summary jurisdiction to prevent automatic machines for the sale of tobacco being used by young persons. The act also contains useful provisions empowering the clearing of a court whilst a child or young person is giving evidence in certain cases (*e.g.* of decency or morality), and the forbidding children (other than infants in arms) being present in court during the trial of other persons; it places a penalty on pawnbrokers taking an article in pawn from children under fourteen; and on vagrants for preventing children above the age of five receiving education. It puts a penalty on giving intoxicating liquor to any child under the age of five, except upon the orders of a duly qualified medical practitioner, or in case of sickness, or other urgent cause; also upon any holder of the licence of any licensed premises who allows a child to be at any time in the bar of the licensed premises, or upon any person who causes or attempts to cause a child to be in the bar of licensed premises other than railway refreshment rooms or premises used for any purpose to which the holding of a licence is merely auxiliary, or where the child is there simply for the purpose of passing through to some other part of the premises. It makes provision for the safety of children at entertainments, and consolidates the law relating to reformatory and industrial schools, and to juvenile offenders (see JUVENILE OFFENDERS).

In the act of 1908, "child" is defined as a person under the age of fourteen years, and "young person" as a person who is fourteen years and upwards and under the age of sixteen years. The act applies to Scotland and Ireland. In the application of the act to Ireland exception is made relative to the exclusion of children from bars of licensed premises, in the case of a child being on licensed premises where a substantial part of the business carried on is a drapery, grocery, hardware or other business wholly unconnected with the sale of intoxicating liquor, and the child is there for the purpose of purchasing goods other than intoxicating liquor.

British Possessions.—Legislation much on the lines of the acts of 1889–1908 has been passed in many British possessions, *e.g.* Tasmania (1895, 1906), Queensland (1896, 1905), Jamaica (1896), South Australia (1899, 1904), New South Wales (1892 and 1900), New Zealand (1906), Mauritius (1906), Victoria

¹ There has been some doubt as to whether it is more correct to say a person "overlays" or "overlies" a child, and the question came up in committee on the bill. According to Sir J. A. H. Murray (see Letter in *The Times*, 12th of May 1908) "to lie," an intransitive verb, becomes transitive when combined with a preposition, *e.g.* a nurse lies over a child or overlies a child; "to lay" is the causal derivative of "to lie," and is followed by two objects, *e.g.* to lay the table with a cloth, or to lay a cloth on the table; similarly, to overlay a surface with varnish, or to overlay a child with a blanket, or with the nurse's or mother's body. The instrument can be left unexpressed, and a person can be said to overlay a child, *i.e.* with her own body, a pillow, &c. Thus, while "overlie" covers the case where the woman herself lies over the child, "overlay" is the more general word.

(1905, 1906). In South Australia a State Children's Department has been created to care for and manage the property and persons of destitute and neglected children, and the officials of the council may act in cases of cruelty to children; the legislation of Victoria and Queensland is based on that of South Australia.

See also CHILDREN'S COURTS, EDUCATION AND LABOUR LEGISLATION. (W. F. C.; T. A. I.)

CHILDRENITE, a rare mineral species; a hydrous basic aluminium iron phosphate, orthorhombic in crystallization. The ferrous oxide is in part replaced by manganous oxide and lime, and in the closely allied and isomorphous species eosphorite manganese predominates over iron. The general formula for the two species is $Al(Fe, Mn)(OH)_2PO_4 \cdot H_2O$. Childrenite is found only as small brilliant crystals of a yellowish-brown colour, somewhat resembling chalybite in general appearance. They are usually pyramidal in habit, often having the form of double six-sided pyramids with the triangular faces deeply striated parallel to their shorter edges. Hardness 4.5-5; specific gravity 3.18-3.24. The mineral, named after the zoologist and mineralogist J. G. Children (1777-1852), secretary of the Royal Society, was detected in 1823 on specimens obtained some years previously during the cutting of a canal near Tavistock in Devonshire. It has also been found in a few copper mines in Cornwall and Devonshire.

Eosphorite occurs as crystals of prismatic habit with angles very nearly the same as those of childrenite. Unlike childrenite, it has a distinct cleavage in one direction, and often occurs in compact masses as well as in crystals. The colour is sometimes yellowish-white, but usually rose-pink, and on this account the mineral was named from *ἠωσφόρος*, dawn-bearer. Hardness 5; specific gravity 3.11-3.145. It was discovered in 1878 in a pegmatite-vein at Branchville, Connecticut, where it is associated with other rare manganese phosphates. (L. J. S.)

CHILDREN'S COURTS, or **JUVENILE COURTS**, a special system of tribunals for dealing with juvenile offenders, first suggested in the United States. The germ of such institutions was planted in Massachusetts in 1869, when a plan was introduced at Boston of hearing charges against children separately, and apart from the ordinary business of the lesser tribunals. No great progress was made in the development of the idea in Massachusetts, as the legal authorities were not fully convinced of the utility or need for a separate court so long as the children were kept strictly apart from adults, and this could be assured by a separate session. But the system of "probation," by which children were handed over to the kindly care and guardianship of an appointed officer, and thus escaped legal repression, was created about the same time in Boston and produced excellent results. The probation officer is present at the judge's side when he decides a case, and is given charge of the offender, whom he takes by the hand, either at his parent's residence or at school, and continually supervises, having power if necessary to bring him again before the judge. The example of Massachusetts in due course influenced other countries, and especially the British colony of South Australia, where a State Children's Department was created at Adelaide in 1895, and three years later a juvenile court was opened there for the trial of persons under eighteen and was conducted with great success, though the system of probation officers was not introduced. A juvenile court was also established at Toronto (Canada) on the South Australian model.

The movement when once fully appreciated went ahead very rapidly. In the United States Illinois was the first state to call a distinct children's court into existence, and Judge Richard Tuthill was the pioneer at Chicago, where the court was established in 1899. Many states followed suit, including New York, Pennsylvania, Rhode Island, Wisconsin, Kansas, Colorado, Indiana and others, till the number rose to nineteen in 1906. In New York, where juvenile probation is supervised by the Society for the Protection of Children, there is a separate children's court with rooms attached, where the children for detention wait till they are brought in for trial. Brooklyn has also a children's court. In Pennsylvania, where the juvenile

court was at first opposed as unconstitutional, the difficulty was met by first bringing the child before the magistrate in the police court, a course which (though followed by his transferring the case to the special court) perpetuated the very evils the children's court was intended to avoid; the work of probation was, however, most effectively carried out, chiefly by female officers. The Chicago Juvenile Court sits twice weekly under an especially appointed judge, and policemen act as probation officers to some extent. The court of Indianapolis, however, gained the reputation of being the most complete and perfect in the United States. It works with a large and highly efficient band of volunteer probation officers under a chief. The juvenile court of Denver, Colorado, attained remarkable results under Judge B. Lindsey, whose magnetic personality, wonderful comprehension of boy nature, and extraordinary influence over them achieved great results. The court meets once a fortnight, when fresh cases are tried and boys already on probation report themselves, often to the number of two hundred at a time. The latter appear before the judge in batches, each hands in his school report in a sealed letter, and according to its purport receives praise or blame, or he may be committed to the Detention House. An efficient court was also constituted at Baltimore, Maryland, with a judge especially chosen to preside, probation being for fixed periods, varying from three months to three years, and children being brought back to the court for parole or discharge, or, if necessary, committal to the house of one of the philanthropic societies. In Washington, D.C., the system of having no distinct court or judge, but holding a separate session, was followed, and it was found that numbers of children came to the court for help and guidance, looking upon the judge for the time being as their friend and counsellor. Probation in this instance offered peculiar difficulties on account of the colour question, two-thirds of the children having negro blood and a white boy being always preferred for a vacant situation. Throughout, the action of juvenile courts in the United States has been to bring each individual into "human touch" with kindly helpful workers striving to lead the young idea aright and train it to follow the straight path. It was the result always of the effort of private persons and not due to government initiative, indeed the advocates and champions of the system only established it by overcoming strong opposition from the authorities.

Progress in the same direction has been made in England. The home office had recommended London police magistrates to keep children's cases separate from those of adults; the same practice or something analogous obtained in many county boroughs, such as Bath, Birmingham, Bristol, Bolton, Bradford, Hull, Manchester, Walsall, Halifax and others, and the Children Act 1908 definitely established children's courts. This act enacted that courts of summary jurisdiction when hearing charges, &c., against children or young persons should, unless the child or young person is charged jointly with an adult, sit in a different building or room from that in which the ordinary sittings of the court are held, or on different days or at different times. Furthermore, provision must be made for preventing persons apparently under the age of sixteen years whilst being conveyed to or from court, or whilst waiting before or after their attendance in court, from associating with adults, unless such adults are charged jointly with them. The act prohibits any persons other than members and officers of the court, the parties to the case, their solicitors, counsel and other persons directly concerned in the case, from being present in a juvenile court, except by leave of the court. Bona-fide press representatives are also excepted. The main object of the whole system is to keep the child, the embryonic offender who has probably erred from ignorance or the pressure of circumstances or misfortune, altogether free from the taint or contagion that attaches to criminal proceedings. The moral atmosphere of a legal tribunal is injurious to the youthful mind, and children who appear before a bench, whether as accused or as witness, gain a contemptuous familiarity with legal processes.

The most beneficial action of the children's court comes from its association with the system of personal guardianship and

close supervision exercised by the probation officers, official and voluntary. Where the intervention of the newly constituted tribunal can not only save the child from evil association when first arrested, but can rescue him without condemnation and committal to prison, its functions may be relied upon to diminish crime by cutting it off at the source. Much depends upon the quality and temperament of the presiding authority. Where a judge with special aptitude can be appointed, firm, sympathetic, tactful and able to gain the confidence of those brought before him, he may do great good, by dealing with each individual and not merely with his offence, realizing that the court does not exist to condemn but to strengthen and give a fresh chance. Where the children's court is only a branch of the existing jurisdiction worked by the regular magistrate or judge fulfilling his ordinary functions and not specially chosen, the beneficial results are not so noticeable. (A. G.)

CHILDREN'S GAMES. The study of traditional games has in recent years become an important branch of folklore research in England, and has contributed not a little towards elucidating many unrecorded facts in early history. These games may be broadly divided into two kinds—dramatic games, and games of skill and chance. These differ materially in their object. Games of skill and chance are played for the purpose of winning property from a less fortunate player. The dramatic games consist of non-singing and singing games; they are divided between boys' games and girls' games. Boys' games are mostly of a contest character, girls' of a more domestic type. The boys' dramatic games have preserved some interesting beliefs and customs, but the tendency in these games, such as "prisoner's base," has been to drop the words and tune and to preserve only that part (action) which tends best for exercise and use in school playgrounds. The girls' singing-games have not developed on these lines, and have therefore not lost so much of their early characteristics. The singing games consist of words, tune and action. The words, in verse, express ideas contained in customs not now in vogue, and they may be traced back to events taking place between men and women and between people of different villages. The tunes are simple, and the same tune is frequently used for different games. The actions are illustrative of the ideas to be expressed. The players represent various objects—animals, villages and people. The singing game is therefore not a game in the usual sense of the word. There is no element of "gambling" or playing "to win" in it—no one is richer or poorer for it; it also requires a number of children to play together. It is really a "play," and has survived because it has handed down some instances of custom and belief which were deeply rooted and which made a strong appeal to the imagination of our ancestors. The singing games represent in dramatic form the survival of those ceremonial dances common to people in early stages of development. These dances celebrated events which served to bind the people together and to give them a common interest in matters affecting their welfare. They were dramatic in character, singing and action forming a part of them, and their performers were connected by ties of place or kindred. They are probably survivals of what we might call folk drama. In these times it was held imperative to perform religious ceremonies periodically; at sowing and harvesting to ensure good crops; in the care of cattle and on occasions of marriage, birth and death. These were matters affecting the welfare of the whole community. Events were celebrated with dance, song and feasting, and no event was too trivial to be unconnected with some belief which rendered ceremony necessary.

At first these ceremonial dances had deep religious feeling for their basis, but in process of time they became purely secular and were performed at certain seasons only because it was the custom to do so. They then became recognized as beautiful or pleasing things in the life of the people, and so continued, altering somewhat in ideas but retaining their old dramatic forms. They were danced by old and young at festivals and holidays, these being held about the same time of year as that at which the previous religious ceremonies had been held.

Singing games are danced principally in one of two methods, "line" and "circle." These represent two of the early forms of dramatic action. The "line" form (two lines of players standing opposite each other having a space of ground between them, advancing and retiring in turn) represents two different and opposing parties engaged in a struggle or contest. This method is used in all cases where contest is involved. The "circle" form, on the other hand, where all players join hands, represents those occasions when all the people of one place were engaged in celebrating events in which all were interested. Thus games celebrating sowing and harvest, and those associated with love and marriage, are played in this form. Both these methods allow of development. The circle varies from examples where all perform the same actions and say the same words to that where two or more players have principal parts, the others only singing or acting in dumb show, to examples where the singing has disappeared. The form or method of play and the actions constitute the oldest remaining parts of the game (the words being subject to alterations and loss through ignorance of their meaning), and it is to this form or method, the actions and the accompaniment of song, that they owe their survival, appealing as they do to the strong dramatic instinct of children and of uncultured folk.

It will be convenient to give a few instances of the best-known singing games. In "line" form, a fighting game is "We are the Rovers." The words tell us of two opposing parties fighting for their land; both sides alternately deride one another and end by fighting until one side is victorious. Two other "line" games, "Nuts in May" and "Here come three dukes a-riding," are also games of contest, but not for territory. These show an early custom of obtaining wives. They represent marriage by capture, and are played in "line" form because of the element of contest contained in the custom. Another form, the "arch," is also used to indicate contest.

Circle games, on the contrary, show such customs as harvest and marriage, with love and courting, and a ceremony and sanction by assembled friends. "Oats and beans and barley" and "Sally Water" are typical of this form. The large majority of circle games deal with love or marriage and domestic life. The customs surviving in these games deal with tribal life and take us back to "foundation sacrifice," "well worship," "sacredness of fire," besides marriage and funeral customs.

Details may be found in the periodical publications of the Folklore Society, and particularly in the following works:—A. B. Gomme's *Traditional Games of Great Britain* (2 vols., Nutt, 1894-1898); Gomme's *Children's Singing Games* (Nutt, 1904); Eckenstein's *Comparative Studies in Nursery Rhymes* (Duckworth, 1906); MacLagan, *Games of Argyllshire*, Folk-lore Society (1900); Newell's *Games of American Children* (Harper Bros., New York, 1884). In Mrs Gomme's *Traditional Games*, several versions of each game, together with a short account of the suggested origin and of the custom or belief indicated, are given for each game. In vol. ii. (pp. 458-531) a memoir of the history of games is given, and the customs and beliefs which originated them, reviewing the whole subject from the anthropological point of view, and showing the place which games occupy among the evidences of early man. In Miss Eckenstein's comparative study of nursery rhymes suggested origins are given for many of these, and an attempt made to localize certain of the customs and events. In several of the publications of the Folklore Society local collections of games are given, all of which may be studied with advantage. Stubbs and other early writers give many instances of boys' games in their days, many of which still exist. Tylor and other writers on anthropology, in dealing with savage custom, confirm the views here expressed. For nursery rhymes see Halliwell, *Nursery Rhymes* (1845), and Chambers's *Popular Rhymes* (first printed 1841, reprinted in 1870). The recently collected *Morris Dances* by Mr Cecil Sharp should also be consulted. One of the morris dances, bean-setting, evidently dealing with planting or harvest, is danced in circle form, while others indicating fighting or rivalry are danced in line form, each line dancing in circle before crossing over to the opposite side, and thus conforming to the laws already shown to exist in the more ordinary game. (A. B. G.)*

CHILDS, GEORGE WILLIAM (1829-1894), American publisher, was born in Baltimore, Maryland, on the 12th of May 1829. He was educated in the public schools, and after a brief term of service in the navy, he became in 1843 a clerk in a book-shop at Philadelphia. There, in 1847, he established an independent

book-shop, and two years later organized the publishing house of Childs & Peterson. In 1864, with Anthony J. Drexel, he purchased the *Public Ledger*, at that time a little known newspaper; he completely changed its policy and methods, and made it one of the most influential journals in the country. He died at Philadelphia on the 3rd of February 1894. Childs was widely known for his public spirit and philanthropy. In addition to numerous private benefactions in educational and charitable fields, he erected memorial windows to William Cowper and George Herbert in Westminster Abbey (1877), and to Milton in St Margaret's, Westminster (1888), a monument to Leigh Hunt at Kensal Green, a Shakespeare memorial fountain at Stratford-on-Avon (1887), and monuments to Edgar Allan Poe and to Richard A. Proctor. He gave Woodland Cemetery to the Typographical Society of Philadelphia for a printers' burial-ground, and with Anthony J. Drexel founded in 1892 a home for Union printers at Colorado Springs, Colorado.

His *Recollections* were published at Philadelphia in 1890.

CHILE, or **CHILI** (derived, it is said, from the Quichua *chiri*, cold, or *ichili*, snow), a republic of South America, occupying the narrow western slope of the continent between Peru and its southern extremity. (For map see ARGENTINA.) It extends from the northern boundary of the province of Tacna, about 17° 25' S., to Cape Horn at the extreme southern point of the Fuegian archipelago in 55° 58' 40" S., with an extreme meridian length of 2661 m., and with a coast line considerably exceeding that figure owing to a westward curve of about 3½° and an eastward trend south of 50° S. of nearly 8°. Its mainland width ranges from about 46 to 228 m., and its area, including the islands of the southern coast, is officially computed to be 307,774 sq. m., though the Gotha computation (1904) places it at 293,062 sq. m. Chile is thus a ribbon-like strip of territory between the Andes and the Pacific, comparatively regular north of the 42nd parallel, but with an extremely ragged outline south of that line. It is bounded N. by Peru, E. by Bolivia and Argentina, S. and W. by the Pacific. Its eastern boundary lines are described under ARGENTINA and BOLIVIA. The war of 1879-81 with Peru and Bolivia gave to Chile 73,993 sq. m. of territory, or one-fourth her total area. By subsequent agreements the Bolivian department of the Litoral, or Atacama, and the Peruvian department of Tarapacá, were formally ceded to Chile, and the northern frontier was removed to the river Camarones, which enters the Pacific at 19° 12' S. Under the treaty of Ancon (20th October 1883) Chile was to retain possession of the provinces of Tacna and Arica belonging to the Peruvian department of Moquegua for a period of ten years, and then submit "to popular vote whether those territories are to belong to Chile or Peru." At the expiration of the period (1893) Chile evaded compliance with the agreement, and under various pretexts retained forcible possession of the territory. This arbitrary retention of Tacna and Arica, which became the province of Tacna under Chilean administration, removed the frontier still farther north, to the river Sama, which separates that province from the remaining part of the Peruvian department of Moquegua. Starting from the mouth of that river, in 17° 57' S., the disputed boundary follows its course in an irregular N.E. direction to its source in the Alto do Toledo range, thence S. and E. along the water parting to the Bolivian boundary line in the Cordillera Silillica.

Physiography.—For purposes of general topographical description Chile may be divided into three regions: the desert region of the north, the central agricultural region between the provinces of Coquimbo and Llanquihue, and the heavily-forested rainy region south of lat. 41° S. The desert region is an elevated arid plateau descending gradually from the Andes towards the coast, where it breaks down abruptly from elevations of 800 to 1500 ft. From the sea this plateau escarpment has the appearance of a range of flat topped hills closely following the coast line. The surface is made up of extensive plains covered with sand and deposits of alkaline salts, broken by ranges of barren hills having the appearance of spurs from the Andes, and by irregular lateral ranges in the vicinity of the main cordillera enclosing elevated saline plateaus. This region is rainless, barren and inhospitable, absolutely destitute of vegetation except in some small river valleys where irrigation is possible, and on the slopes of some of the snow-covered peaks where the water from the melting snows nourishes a scanty and coarse vege-

tion before it disappears in the thirsty sands. It is very rich in mineral and saline deposits, however. The eastern parts of this region lie within the higher ranges of the Andes and include a large district awarded to Chile in 1899 (see ARGENTINA and ATACAMA). This arid, bleak area is apparently a continuation southward of the great Bolivian *altiplanicie*, and is known as the Puna de Atacama. Its average elevation is estimated at 11,000 to 12,000 ft. A line of volcanoes crosses it from north to south, and extensive lava beds cover a considerable part of its surface. Large shallow saline lakes are also characteristic features of this region. From 28° S. the spurs from the cordillera toward the coast are more sharply defined and enclose deeper valleys, where the cultivation of the soil becomes possible, at first through irrigation and then with the aid of light periodical rains. The slopes of the Andes are precipitous, the general surface is rough, and in the north the higher ground and coast are still barren. Beginning with the province of Aconcagua the coast elevations crystallize into a range of mountains, the Cordillera Maritima, which follows the shore line south to the province of Llanquihue, and is continued still farther south by the mountain range of Chiloé and the islands of the western coast, which are the peaks of a submerged mountain chain. Lying between this coast range and the Andes is a broad valley, or plain, extending from the Aconcagua river south to the Gulf of Ancud, a distance slightly over 620 m. with an average width of about 60 m. It is sometimes called the "Vale of Chile," and is the richest and most thickly-populated part of the republic. It is a highly fertile region, is well watered by numerous streams from the Andes, has a moderate rainfall, and forms an agricultural and grazing region of great productiveness. It slopes toward the south, and its lower levels are filled with lakes and with depressions where lakes formerly existed. It is an alluvial plain for the greater part, but contains some sandy tracts, as in Ñuble and Arauco; in the north very little natural forest is found except in the valleys and on the slopes of the enclosing mountain ranges, but in the south, where the rainfall is heavier, the plain is well covered with forest. South of 41° S. the country is mountainous, heavily-forested and inhospitable. There are only a few scattered settlements within its borders, and a few nomadic tribes of savages eke out a miserable existence on the coast. The deeply-indented coast line is filled with islands which preserve the general outline of the continent southward to the Fuegian archipelago, the outside groups forming a continuation of the Cordillera Maritima. The heavy and continuous rainfall throughout this region, especially in the latitude of Chiloé, gives rise to a large number of rivers and lakes. Farther south this excessive precipitation is in the form of snow in the Cordilleras, forming glaciers at a comparatively low level which in places discharge into the inlets and bays of the sea. The extreme southern part of this region extends eastward to the Atlantic entrance to the Straits of Magellan, and includes the greater part of the large island of Tierra del Fuego with all the islands lying south and west of it. There are some comparatively level stretches of country immediately north of the Straits, partly forested and partly grassy plains, where sheep farming has been established with some degree of success, but the greater part of this extreme southern territory is mountainous, cold, wet and inhospitable. The perpetual snow-line here descends to 3500 to 4000 ft. above sea-level, and the forest growth does not rise above an altitude of 1000 to 1500 ft.

It has been officially estimated that the arable lands of Chile comprise about twenty-five millions of acres (slightly over 39,000 sq. m.), or very nearly one-eighth of its total area. *Mountains.* The desert regions of the north include comparatively large areas of plains and gently sloping surfaces, traversed by ranges of barren hills. The remainder of the republic, probably more than three-fifths of its surface, is extremely mountainous. The western slopes of the Andes, with its spurs and lateral ranges, cover a broad zone on the eastern side of the republic, and the Cordillera Maritima covers another broad zone on its western side from about lat. 33° to the southern extremity of Chiloé, or below lat. 43°. This maritime range is traversed by several river valleys, some of which, like the Bio-Bio, are broad and have so gentle a slope as to be navigable. The Andes, however, present an unbroken barrier on the east, except at a few points in the south where the general elevation is not over 5000 to 6000 ft., and where some of the Chilean rivers, as the Palena and Las Heras, have their sources on its eastern side. From the 52nd to about the 31st parallel this great mountain system, known locally as the Cordillera de los Andes, apparently consists of a single chain, though in reality it includes short lateral ranges at several points; continuing northward several parallel ranges appear on the Argentine side and one on the Chilean side which are ultimately merged in the great Bolivian plateau. The Chilean lateral range, which extends from the 29th to the 19th parallels, traverses an elevated desert region and possesses several noteworthy peaks, among which are Cerro Bolson, 16,017 ft., and Cerro Dona Ines, 16,706 ft. It is broken to some extent in crossing the province of Antofagasta, the southern division being known as the Sierra de Huatacondo. At the southern frontier of Bolivia the main chain, which has served as the boundary line between Argentina and Chile, divides into two great ranges, the principal one continuing almost due north along the eastern side of the great Bolivian *altiplanicie*, and the other forming its western rim, where

it is known as the Cordillera Silillica, and then following the trend of the coast north-westward into Peru becomes the Cordillera Occidental. The western slopes of the Andes are precipitous, with short spurs enclosing deep valleys. The whole system is volcanic, and a considerable number of volcanoes are still intermittently active, noticeably in central and southern Chile. The culminating point of the Chilean Andes is Aconcagua, which rises to a height of 23,097 ft.

In southern Chile the coast is highly mountainous, but the relation of these elevations to the Andes has not been clearly determined. The highest of these apparently detached groups are Mt. Macá (lat. 45° S.), 9711 ft., and Mt. Arenales (about 47° S. lat.), 11,286 ft. Cathedral Peak on Wellington Island rises to a height of 3838 ft. and the highest point on Taytao peninsula to 3937 ft. The coast range of central Chile has no noteworthy elevations, the culminating point in the province of Santiago being 7316 ft. Between central Chile and the northern desert region there is a highly mountainous district where distinct ranges or elongated spurs cross the republic from the Andes to the coast, forming transverse valleys of great beauty and fertility. The most famous of these is the "Vale of Quillota" between Valparaíso and Santiago. The Chilean Andes between Tacna and Valdivia are crossed by 24 passes, the majority of them at elevations exceeding 10,000 ft. The best-known of these is the Uspallata pass between Santiago and the Argentine city of Mendoza, 12,870 ft. above sea-level. The passes of central and southern Chile are used only in the summer season, but those of northern Chile are open throughout the whole year.

The volcanic origin of the Andes and their comparatively recent elevation still subject Chile, in common with other parts of the western coast region, to frequent volcanic and seismic disturbances. In some instances since European occupation, violent earthquake shocks have resulted in considerable elevations of certain parts of the coast. After the great earthquake of 1835 Captain Robert FitzRoy (1805-1865) of H.M.S. "Beagle" found putrid mussel-shells still adhering to the rocks 10 ft. above high water on the island of Santa Maria, 30 m. from Concepción, and Charles Darwin declares, in describing that disaster, that "there can be no doubt that the land round the bay of Concepción was upraised two or three feet." These upheavals, however, are not always permanent, the upraised land sometimes settling back to its former position. This happened on the island of Santa Maria after 1835. The existence of sea-shells at elevations of 350 to 1300 ft. in other parts of the republic shows that these forces, supplemented by a gradual uplifting of the coast, have been in operation through long periods of time and that the greater part of central and southern Chile has been raised from the sea in this way. These earthquake shocks have two distinct characteristics, a slight vibration, sometimes almost imperceptible, called a *temblor*, generally occurring at frequent intervals, and a violent horizontal or rotary vibration, or motion, also repeated at frequent intervals, called a *terremoto*, which is caused by a fracture or displacement of the earth's strata at some particular point, and often results in considerable damage. When the earthquake occurs on the coast, or beneath the sea in its vicinity, tidal waves are sometimes formed, which cause even greater damage than the earthquake itself. Arica has been three times destroyed by tidal waves, and other small towns of the north Chilean coast have suffered similar disasters. Coquimbo was swept by a tidal wave in 1849, and Concepción and Talcahuano were similarly destroyed in 1835. The great earthquake which partially destroyed Valparaíso in 1906, however, was not followed by a tidal wave. These violent shocks are usually limited to comparatively small districts, though the vibrations may be felt at long distances from the centre of disturbance. In this respect Chile may be divided into at least four great earthquake areas, two in the desert region, the third enclosing Valparaíso, and the fourth extending from Concepción to Chiloé. A study of Chilean earthquake phenomena, however, would probably lead to a division of southern Chile into two or more distinct earthquake areas.

The coast of Chile is fringed with an extraordinary number of islands extending from Chiloé S. to Cape Horn, the grouping of which shows that they are in part the summits of a submerged mountain chain, a continuation southward of the Cordillera Maritima. Three groups of these islands, called the Chiloé, Guaytecas and Chonos archipelagos, lie N. of the Taytao peninsula (lat. 45° 50' to 46° 55' S.), and with the mainland to the E. form the province of Chiloé. The largest of these is the island of Chiloé, which is inhabited. Some of the smaller islands of these groups are also inhabited, though the excessive rainfall of these latitudes and the violent westerly storms render them highly unfavourable for human occupation. Some of the smallest islands are barren rocks, but the majority of them are covered with forests. These archipelagos are separated from the mainland in the north by the gulfs of Chacao (or Ancud) and Corcovado, 30 to 35 m. wide, which appear to be a submerged part of the great central valley of Chile, and farther south by the narrower Moraleda channel, which terminates southward in a confusing network of passages between the mainland and the islands of the Chonos group. One of the narrow parts of the Chilean mainland is to be found opposite the upper islands of this group, where the accidental juxtaposition of Magdalena island, which indents the continent over half a degree at this point, and the basin of Lake Fontana, which gives the Argentine boundary a sharp

wedge-shaped projection westward, narrows the distance between the two to about 26 m. The Taytao peninsula, incorrectly called the Tres Montes on some maps, is a westward projection of the mainland, with which it is connected by the narrow isthmus of Ofqui, over which the natives and early missionaries were accustomed to carry their boats between the Moraleda Channel and Gulf of Peñas. A short ship canal here would give an uninterrupted and protected inside passage from Chacao Channel all the way to the Straits of Magellan, a distance of over 760 m. A southern incurving projection of the outer shore-line of this peninsula is known as Tres Montes peninsula, the most southern point of which is a cape of the same name. Below the Taytao peninsula is the broad open Gulf of Peñas, which carries the coast-line eastward fully 100 m. and is noticeably free from islands. The northern entrance to Messier Channel is through this gulf. Messier, Pitt, Sarmiento and Smyth's Channels, which form a comparatively safe and remarkably picturesque inside route for small steamers, about 338 m. in length, separate another series of archipelagos from the mainland. These channels are in places narrow and tortuous. Among the islands which thickly fringe this part of the coast, the largest are Azopardo (lying within Baker Inlet), Prince Henry, Campaña, Little Wellington, Great Wellington and Mornington (of the Wellington archipelago), Madre de Dios, Duke of York, Chatham, Hanover, Cambridge, Contreras, Rennell and the Queen Adelaide group of small barren rocks and islands lying immediately north of the Pacific entrance to the Straits of Magellan. The large number of English names on this coast is due to the fact that the earliest detailed survey of this region was made by English naval officers; the charts prepared from their surveys are still in use and form the basis of all subsequent maps. None of these islands is inhabited, although some of them are of large size, the largest (Great Wellington) being about 100 m. long. It has likewise been determined, since the boundary dispute with Argentina called attention to these territories and led to their careful exploration at the points in dispute, that Skyring Water, in lat. 53° S., opens westward into the Gulf of Xautegua, which transforms Ponsonby Land and Cordoba (or Croker) peninsula into an island, to which the name of Riesco has been given. The existence of such a channel was considered probable when these inland waters were first explored in 1829 by Captain FitzRoy, but it was not discovered and surveyed until three-quarters of a century had elapsed. Belonging to the Fuegian group south of the Straits of Magellan are Desolation, Santa Ines, Clarence, Dawson, Londonderry, Hoste, Navarin and Wollaston islands, with innumerable smaller islands and rocks fringing their shores and filling the channels between them. Admirable descriptions of this inhospitable region, the farthest south of the inhabited parts of the globe, may be found in the *Narrative of the Surveying Voyages of His Majesty's Ships "Adventure" and "Beagle" between the years 1826 and 1836* (3 vols., 1839).

The western and larger part of Tierra del Fuego (*q.v.*) belongs to Chile. About 63 m. S.W. of Cape Horn, in lat. 56° 25' S., is the Diego Ramirez group of small, rocky islands, the most southern possession of the republic. Its westernmost possessions are Sala-y-Gomez and Easter islands, the former in about 27° S., 105° W., and the latter, the easternmost inhabited Polynesian island, in 27° 6' S., 109° 17' W. Much nearer the Chilean coast (396 m.), lying between the 33rd and 34th parallels, are the three islands of the Juan Fernandez group, and rising apparently from the same submerged plateau about 500 m. farther north of the latter are the rocky islets of San Ambrosio and San Felix, all belonging to Chile. North of Chiloé there are few islands in close proximity to the coast. The more important of these are La Mocha, off the southern coast of Arauco, in lat. 38° 20' S., which is 8 m. long and rises to an elevation of 1240 ft. above the sea; Santa Maria, 30 m. south-west of Concepción, which partially encloses the Bay of Arauco and is well cultivated; and Quiriquina, lying off the port of Talcahuano in the entrance to Concepción bay. There are a few barren islands on the desert coast, the largest of which are between Coquimbo and Caldera. Since the removal of their guano deposits they have become practically worthless, except where they serve to shelter anchorages.

The coast of northern and central Chile is singularly deficient in good harbours. Those of the desert region are only slight indentations in a remarkably uniform coast-line, sheltered on one side by a point of land, or small island. The landings **Harbours.** are generally dangerous because of the surf, and the anchorages are unsafe from storms on the unprotected side. Among the most frequented of these are Valparaíso, Coquimbo, Caldera, Iquique and Arica. There are some small harbours for coasting vessels of light draught along the coast of central Chile, usually at the partially obstructed mouths of the larger rivers, as San Antonio near the mouth of the Maipo, Constitución at the mouth of the Maule, and Llico on the outlet of Lake Vichuquen, but there is no harbour of importance until Concepción (or Talcahuano) Bay is reached. There are three harbours on this bay, El Tomé, Penco and Talcahuano (*q.v.*), the last being the largest and best-protected port on the inhabited part of the Chilean coast. Immediately south of this bay is the large Bay of Arauco, into which the Bio-Bio river discharges, and on which, sheltered by the island of Santa Maria, are the ports of Coronel and Lota. The next important harbour is that of El Corral, at the mouth of the Valdivia river and 15 m. below

the city of Valdivia. The Bay of San Carlos on the northern coast of Chiloé, which opens upon the narrow Chacao channel, has the port of Ancud, or San Carlos, and is rated an excellent harbour for vessels of light and medium draught. Inside the island of Chiloé the large gulfs of Chacao (or Ancud) and Corcovado are well protected from the severe westerly storms of these latitudes, but they are little used because the approach through the Chacao channel is tortuous and only 2 to 3 m. wide, and the two gulfs, though over 30 m. wide and 150 m. long, are beset with small rocky islands. At the north end of the first is the Reloncavi, a large and nearly landlocked bay, on which stands Puerto Montt, the southern terminus of the Chilean central railway. The large Gulf of Peñas, south of Taytao peninsula, is open to the westerly storms of the Pacific, but it affords entrance to several natural harbours. Among these are the Gulfs of Tres Montes and San Estevan, and Tarn Bay at the entrance to Messier Channel. The next 300 m. of the Chilean coast contain numerous bays and inlets affording safe harbours, but the mainland and islands are uninhabited and the climate inhospitable. Behind Rennell Island in lat. 52° S., however, is a succession of navigable estuaries which penetrate inland nearly to the Argentine frontier. The central part of this group of estuaries is called Worsley Sound, and the last and farthest inland of its arms is Last Hope Inlet (Ultima Esperanza), on which is situated the Chilean agricultural colony of Puerto Consuelo. The Straits of Magellan, about 360 m. in length, lie wholly within Chilean territory. Midway of them is situated Punta Arenas, the most southern town and port of the republic.

Except in the extreme south the hydrography of Chile is of the simplest description, all the larger rivers having their sources in the Andes and flowing westward to the Pacific. Their courses are necessarily short, and only a few have navigable channels, the aggregate length of which is only 705 m. Nearly all rivers in the desert region are lost in the sands long before reaching the coast. Their waterless channels are interesting, however, as evidence of a time when climatological conditions on this coast were different. The principal rivers of this region are Sama (which forms the provisional boundary line with Peru), Tacna, Camarones, Loa, Copiapó, Huasco, Elqui, Limari and Choapa. The Loa is the largest, having its sources on the slopes of the Cordillera south of the Minho volcano, between 21° and 21° 30' S. lat., and flowing south on an elevated plateau to Chiuchiu, and thence west and north in a great curve to Quillaga, whence its dry channel turns westward again and reaches the Pacific in lat. 21° 28' S., a few miles south of the small port of Huanillos. Its total length is estimated at 250 m. The upper courses of the river are at a considerable elevation above the sea and receive a large volume of water from the Cordilleras. The water of its upper course and tributaries is sweet, and is conducted across the desert in pipes to some of the coast towns, but in its lower course, as in all the rivers of this region, it becomes brackish. The Copiapó, which once discharged into the sea, is now practically exhausted in irrigating a small fertile valley in which stands the city of that name. The Copiapó and Huasco have comparatively short courses, but they receive a considerable volume of water from the higher sierras. The latter is also used to irrigate a small, cultivated valley. The rivers of the province of Coquimbo—the Elqui or Coquimbo, Limari and Choapa—exist under less arid conditions, and like those of the province of Aconcagua—the Ligua and Aconcagua—are used to irrigate a much larger area of cultivated territory. The central agricultural provinces are traversed by several important rivers, all of them rising on the western slopes of the snow-clad Andes and breaking through the lower coast range to the Pacific after being extensively used to irrigate the great central valley of Chile. These are the Maipó (Maypó or Maipú), Rapel, Mataquito, Maule, Itata, Bio-Bio, Imperial, Tolten, Valdivia or Calle-Calle, Bueno and Maullin. With the exception of the first three, these rivers have short navigable channels, but they are open only to vessels of light draught because of sand-bars at their mouths. The largest is the Bio-Bio, which has a total length of 220 m., 100 of which are navigable. These rivers have been of great service in the agricultural development of this part of Chile, affording means of transportation where railways and highways were entirely lacking. Some of the larger tributaries of these rivers, whose economic value has been equally great, are the Mapocho, which flows through Santiago and enters the Maipó from the north; the turbulent Cachapoal, which joins the Rapel from the north; the Claro, which waters an extensive part of the province of Talca and enters the Maule from the north; the Nuble, which rises in the higher Andes north of the peaks of Chillan and flows entirely across the province of Nuble to join the Itata on its western frontier; the Laja, which rises in a lake of the same name near the Argentine frontier in about lat. 35° 30' S. and flows almost due west to the Bio-Bio; and the Cautin, which rises in the north-east corner of Cautin and after a tortuous course westward nearly across that province forms the principal confluent of the Imperial. The unsettled southern regions of Chiloé (mainland) and Magallanes are traversed by a number of important rivers which have been only partially explored. They have their sources in the Andes, some of them on the eastern side of the line of highest summits. The Puelo has its origin in a lake of the same name in Argentine territory, and flows north-west through the Cordilleras into an estuary (Reloncavi Inlet) of the Gulf of Reloncavi at the northern end of the Gulf of Chacao. Its lower

course is impeded in such a manner as to form three small lakes, called Superior, Inferior and Taguatagua. A large northern tributary of the Puelo, the Manso, has its sources in Lake Mascardi and other lakes and streams south-east of the Cerro Tronador, also in Argentina, and flows south-west through the Cordilleras to unite with the Puelo a few miles west of the 72nd meridian. The Reloncavi Inlet also receives the outflow of Lake Todos los Santos through a short tortuous stream called the Petrohue. The Comau Inlet and river form the boundary line between the provinces of Llanquihue and Chiloé, and traverse a densely wooded country in a north-westerly direction from the Andes to the north-eastern shore of the Gulf of Chacao. Continuing southward, the Yelcho is the next important river to traverse this region. It drains a large area of Argentine territory, where it is called the Rio Fetaleufu or Fetalaufen, its principal source being a large lake of the same name. It flows south-west through the Andes, and then north-west through Lake Yelcho to the Gulf of Corcovado. The Argentine colony of the 16th of October, settled principally by Welshmen from Chubut, is located on some of the upper tributaries of this river, in about lat. 43° S. The Palena is another river of the same character, having its source in a large frontier lake called General Paz and flowing for some distance through Argentine territory before crossing into Chile. It receives one large tributary from the south, the Rio Pico, and enters an estuary of the Gulf of Corcovado a little north of the 44th parallel. The Frias is wholly a Chilean river, draining an extensive Andean region between the 44th and 45th parallels and discharging into the Puyuguapi channel, which separates Magdalena island from the mainland. The Aisen also has its source in Argentine territory near the 46th parallel, and drains a mountainous region as far north as the 45th parallel, receiving numerous tributaries, and discharging a large volume of water into the Moraleda channel in about lat. 45° 20' S. The lower course of this river is essentially an inlet, and is navigable for a short distance. The next large river is the Las Heras, or Baker, through which the waters of Lakes Buenos Aires and Pueyrredon, or Cochrane, find their way to the Pacific. Both of these large lakes are crossed by the boundary line. The Las Heras discharges into Martinez Inlet, the northern part of a large estuary called Baker or Calen Inlet which penetrates the mainland about 75 m. and opens into Tarn Bay at the south-east corner of the Gulf of Peñas. Azopardo (or Merino Jarpa) island lies wholly within this great estuary, while at its mouth lies a group of smaller islands, called Baker Islands, which separate it from Messier Channel. The course of the Las Heras from Lake Buenos Aires is south and south-west, the short range of mountains in which are found the Cerros San Valentin and Arenales forcing it southward for an outlet. Baker Inlet also receives the waters of still another large Argentine-Chilean lake, San Martin, whose far-reaching fjord-like arms extend from lat. 49° 10' to 48° 20' S.; its north-west arm drains into the Toro, or La Pascua, river. Lake San Martin lies in a crooked deeply cut passage through the Andes, and the divide between its southern extremity (Laguna Tar) and Lake Viedma, which discharges through the Santa Cruz river into the Atlantic, is so slight as to warrant the hypothesis that this was once a strait between the two oceans. After a short north-westerly course the Toro discharges into Baker Inlet in lat. 48° 15' S., long. 73° 24' W. South of the Toro there are no large rivers on this coast, but the narrow fjords penetrate deeply into the mountains and bring away the drainage of their snow-capped, storm-swept elevations. A peculiar network of fjords and connecting channels terminating inland in a peculiarly shaped body of water with long, widely branching arms, called Worsley Sound, Obstruction Sound and Last Hope Inlet, covers an extensive area between the 51st and 53rd parallels, and extends nearly to the Argentine frontier: It has the characteristics of a tidewater river and drains an extensive region. The sources of the Argentine river Coile are to be found among the lakes and streams of this same region, within Chilean territory. A noteworthy peculiarity of southern Chile, from the Taytao peninsula (about 46° 50' S. lat.) to Tierra del Fuego, is the large number of glaciers formed on the western and southern slopes of the Cordilleras and other high elevations, which discharge direct into these deeply cut estuaries. Some of the larger lakes of the Andes have glaciers discharging into them. The formation of these icy streams at comparatively low levels, with their discharge direct into tidewater estuaries, is a phenomenon not to be found elsewhere in the same latitudes.

The lakes of Chile are numerous and important, but they are found chiefly in the southern half of the republic. In the north the only lakes are large lagoons, or morasses, on the upper saline plateaus between the 23rd and 28th parallels. **Lakes.** They are fed from the melting snows and periodical storms of the higher Andes, and most of them are completely dry part of the year. Their waters are saturated with saline compounds, which in some cases have considerable commercial value. In central Chile above the Bio-Bio river the lakes are small and have no special geographical interest, with the exception perhaps of the Laguna del Maule, in 36° 7' S., and Laguna de la Laja, in 37° 20', which lie in the Andes near the Argentine frontier and are sources of the two rivers of the same names. Below the Bio-Bio river there is a line of large picturesque lakes extending from the province of Cautin, south through that of Llanquihue, corresponding in character and position to the dry lacustrine depressions extending northward in the same valley.

They lie on the eastern side near the Cordilleras, and serve the purpose of great reservoirs for the excessive precipitation of rain and snow on their western slopes. With one exception they all drain westward into the Pacific through short and partly navigable rivers, and some of the lakes are also utilized for steamship navigation. These lakes are Villarica on the southern frontier of Cautin, Rinihue and Ranco in Valdivia, and Puyehue, Rupanco, Llanquihue and Todos los Santos in Llanquihue. The largest of the number are Lakes Ranco and Llanquihue, the former with an estimated area of 200 sq. m. and the latter of 300 sq. m. Lake Todos los Santos is situated well within the Andean foothills north-east of Puerto Montt and at an elevation of 509 ft., considerably above that of the other lakes, Lake Ranco being 230 ft. above sea-level. The great Andean lakes of General Paz (near the 44th parallel), Buenos Aires (in lat. 46° 30' S.), Pueyrredon, or Cochrane (47° 15' S.) and San Martin (49° S.), lie partly within Chilean territory. In the extreme south are Lagoa Blanca, a large fresh-water lake in lat. 52° 30' S., and two large inland salt-water sounds, or lagoons, called Otway Water and Skyring Water, connected by FitzRoy Passage.

Geology.—Chile may be divided longitudinally into two regions which differ from each other in their geological structure. Along the coast lies a belt of granite and schist overlaid unconformably by Cretaceous and Tertiary deposits; inland the mountains are formed chiefly of folded Mesozoic beds, together with volcanic rocks of later date. The great longitudinal valley of Chile runs approximately, but only approximately, along the boundary between the two zones. Towards the north the coastal zone disappears beneath the sea and the Andean zone reaches to the shore. The ancient rocks which form the most characteristic feature of the former do indeed occur upon the coast of Peru, but in the north of Chile they are found only in isolated masses standing close to the shore or, as at Mejillones, projecting into the sea. South of Antofagasta the old rocks form a nearly continuous band along the coast, extending as far as Cape Horn and Staten Island, and occupying the greater part of the islands of southern Chile. Lithologically they are crystalline schists, together with granite, diorite, gabbro and other igneous rocks. They are known to be pre-Jurassic, but whether they are Palaeozoic or Archaean is uncertain. They are strongly folded and are overlaid unconformably by Cretaceous and Tertiary deposits. In the north both the Cretaceous and Tertiary beds of this zone are limited in extent, but towards the south Mesozoic beds, which are at least in part Cretaceous, form a band of considerable width. The Tertiary beds include both marine and terrestrial deposits, and appear to be chiefly of Miocene and Pliocene age. The whole of the north part of Tierra del Fuego is occupied by plateaus of horizontal Tertiary strata.

The Chilean Andes correspond with the Western Cordillera of Bolivia and Peru, and consist almost entirely of Jurassic and Cretaceous beds, together with the products of the Tertiary eruptions. The Mesozoic beds are thrown into a series of parallel folds which run in the direction of the chain and which are generally free from any complications such as overthrusting or overfolding. The Cretaceous beds form a synclinal upon the eastern side of the chain (and, in general, beyond the Chilean boundary), while the Jurassic beds are thrown into a number of folds which form the axis and the western flank. Through the Mesozoic beds are intruded granitic and other igneous rocks of Tertiary age, and upon the folded Mesozoic foundation rise the volcanic cones of Tertiary and later date. The Trias is known only at La Ternerera near Copiapó, where coal-seams with Rhaetic plants have been found; but the rest of the Mesozoic series, from the Lias to the Upper Cretaceous, appears to be represented without a break of more than local importance. The deposits are marine, consisting mainly of sandstone and limestone, together with tuffs and conglomerates of porphyry and porphyrite. These porphyritic rocks form a characteristic feature of the southern Andes, and were at one time supposed to be metamorphic; but they are certainly volcanic, and as they contain marine fossils they must have been laid down beneath the sea. They are not confined to any one horizon, but occur irregularly throughout the Jurassic and occasionally also amongst the Cretaceous strata. They form, in fact, a special facies which may frequently be traced laterally into the more normal marine deposit of the same age. The fauna of the Mesozoic beds is very rich, and includes forms which are found in northern Europe, others which occur in central Europe, and others again which are characteristic of the Mediterranean region. It lends no support to Neumayr's theory of climatic zones. A large part of the chain is covered by the products of the great volcanoes which still form the highest summits of the Chilean and Argentine Andes. The rocks are liparites, dacites, hornblende and pyroxene andesites. The recent lavas of the still active volcanoes of the south are olivine-bearing hypersthene-andesite and basalt.¹

Climate.—The climate of Chile varies widely, from the tropical

¹ See A. Pissis, "Sur la constitution géologique de la chaîne des Andes entre le 16° et le 55° degré de latitude sud," *Ann. des mines*, ser. 7, vol. iii. (Mém.), 1873, pp. 402-426, pls. ix., x.; R. A. Philipp, *Die tertiären und quartären Versteinerungen Chiles* (Leipzig, 1887), (includes also descriptions of some Cretaceous fossils), and *Los Fósiles secundarios de Chile* (Santiago, 1899); Karl Burckhardt, "Profils géologiques transversaux de la Cordillère argentine-chilienne. Stratigraphie et tectonique," *Anales Mus.*

heat and extreme arid conditions of the northern coast to the low temperatures and extreme humidity of western Tierra del Fuego and the southern coast. The high altitudes of the Andean region also introduce vertical zones of temperature, modified to some extent by the rainless plateaus of the north, and by the excessive rainfall of the south. In general terms it may be said that the extremes of temperature are not so great as in corresponding latitudes of the northern hemisphere, because of the greater expanse of water in comparison with the land areas, the summers being cooler and the winters warmer. The cold antarctic, or Humboldt, current sweeps northward along the coast and greatly modifies the heat of the arid, tropical plateaus. The climate of northern and central Chile is profoundly affected by the high mountain barrier on the eastern frontier and by the broad treeless pampas of Argentina, which raise the easterly moisture-laden winds from the Atlantic to so high an elevation that they sweep across Chile without leaving a drop of rain. At very rare intervals light rains fall in the desert regions north of Coquimbo, but these are brought by the prevailing coast winds. With this exception these regions are the most arid on the face of the globe, highly heated by a tropical sun during the day and chilled at night by the proximity of snow-covered heights and a cold ocean current. Going south the temperature slowly falls and the rainfall gradually increases, the year being divided into a short rainy season and a long, dry, cloudless season. At Copiapó, in 27° 22' S., 1300 ft. above the sea, the mean annual temperature is 60° and the rainfall about 1 in., but at Coquimbo, in 29° 56' S., the temperature is 59.2° and the rainfall 1½ in. At Santiago, in 33° 27' S., 1755 ft. above the sea, the mean temperature is 54° and the annual rainfall 16½ in., though the latter varies considerably. The number of rainy days in the year averages about 21. At Talca, in 35° 36' S. and 334 ft. above sea-level, the mean annual temperature is nearly one degree above that of Santiago, but the rainfall has increased to 19.7 in. The long dry season of this region makes irrigation necessary, and vegetation has something of a subtropical appearance, palms growing naturally as far south as 37°. The climate is healthy and agreeable, though the death-rate among the common people is abnormally high on account of personal habits and unsanitary surroundings. In southern Chile the climate undergoes a radical change—the prevailing winds becoming westerly, causing a long rainy season with a phenomenal rainfall. The plains as well as the western slopes of the Andes are covered with forest, the rivers become torrents, and the sky is covered with heavy clouds a great part of the year. At Valdivia, in 39° 49' S. and near the sea-level, the mean annual temperature is 52.9° and the annual rainfall 108 to 115 in., with about 150 rainy days in the year. These meteorological conditions are still more accentuated at Ancud, at the north end of the island of Chiloé, in 41° 46' S., where the mean annual temperature is 50.7° and the annual rainfall 134 in. The equable character of the climate at this point is shown by the limited range between its summer and winter temperatures, the mean for January being 56.5° and the mean for July 45.9°. The almost continual cloudiness is undoubtedly a principal cause, not only of the low summer temperatures, but also of the comparatively high winter temperatures. Frosts are infrequent, and snow does not lie long. The climate is considered to be healthful notwithstanding the excessive humidity. The 600 m. of coast from the Chonos Archipelago south to the Fuegian islands have a climate closely approximating that of the latter. It is wet and stormy all the year through, though the rainfall is much less than that of Ancud and Valdivia. The line of perpetual snow, which is 6000 ft. above sea-level between lat. 41° and 43°, descends to 3500 (to 4000) ft. in Tierra del Fuego, affording another indication of the low maximum temperatures ruling during the summer. At the extreme south, where Chilean territory extends across to the Atlantic entrance to the Straits of Magellan, a new climatic influence is encountered in the warm equatorial current flowing down the east coast of South America, which gives to eastern Tierra del Fuego a higher temperature than that of the western shore. The Andes, although much broken in these latitudes, also exert a modifying influence on these eastern districts, sheltering them from the cold westerly storms and giving them a drier climate. This accounts for the surprising meteorological data obtained from Punta Arenas, in 53° 10' S., where the mean annual temperature is 43.2° and the annual rainfall only 22.5 in. Other observations reduce this annual precipitation to less than 16 in. According to observations made by the Swedish Antarctic Expedition (1901-1903), at Orange Bay, Hoste Island, in lat. 55° 31' S., long. 68° 05' W., which is more exposed to the westerly storms, the mean temperature for 11 months was 41.98° and the total precipitation (rain and snow) 53.1 in. The mean maximum temperature was 49.24°, and the mean minimum 35.83°. The observations showed 284 days with rain or snow, of which 70 were with snow.

Flora.—The indigenous flora of Chile is less extensive and less interesting than those of Argentina and Brazil, but contains many peculiar genera and species. A classification of this flora necessitates

La Plata, 1900, and "Beiträge zur Kenntnis der Jura- und Kreideformation der Cordillere," *Palaeontographica*, vol. 1. (1903-1904), pp. 1-144, pls. i.-xvi.; see also a series of papers on South American geology by G. Steinmann and his collaborators in *Neues Jahrb. für Min. Beil.-band* viii. et seq.

its division into at least three general zones—the desert provinces of the north, central Chile, and the humid regions of the south. The first is an arid desert absolutely barren along part of the coast, between Tacna and Copiapó, but with a coarse scanty vegetation near the Cordilleras along watercourses and on the slopes where moisture from the melting snows above percolates through the sand. In the valleys of the Copiapó and Huasco rivers a meagre vegetation is to be found near their channels, apart from what is produced by irrigation, but the surface of the plateau and the dry river channels below the sierras are completely barren. Continuing southward into the province of Coquimbo a gradual change in the arid conditions may be observed. The higher summits of the Cordilleras afford a larger and more continuous supply of water, and so dependent are the people in the cultivated river valleys on this source of water supply that they watch for snowstorms in the Cordilleras as an indication of what the coming season is to be. The arborescent growth near the mountains is larger and more vigorous, in which are to be found the "algarrobo" (*Prosopis siliquastrum*) and "chañar" (*Gourelia chilensis*), but the only shrub to be found on the coast is a species of *Skylanthus*. Near the sierras where irrigation is possible, fruit-growing is so successful, especially the grape and fig, that the product is considered the best in Chile. In regard to the indigenous flora of this region John Ball¹ says: "The species which grow here are the more or less modified representatives of plants which at some former period existed under very different conditions of life." Proceeding southward cacti become common, first a dwarfed species, and then a larger columnar form (*Cereus quisco*). The streams are fringed with willows; fruit trees and alfalfa fields fill the irrigated valleys, and the lower mountain slopes are better covered with a thorny arborescent growth. The divides between the streams, however, continue barren as far south as the transverse ranges of mountains across the province of Aconcagua.

To some degree the flora of central Chile is of a transition character between the northern and southern zones. It is much more than this, however, for it has a large number of genera and species peculiarly its own. A large majority of the 198 genera peculiar to the South American temperate regions belong exclusively to central Chile. This zone extends from about the 30th to the 36th parallel, perhaps a little farther south to include some characteristic types. The evergreens largely predominate here as well as in the extreme south, and on the open, sunburnt plains the vegetation takes on a sub-tropical aspect. One of the most characteristic trees of this zone is the *peumo* (*Cryptocarya peumus*), whose dense evergreen foliage is everywhere conspicuous. The *quillay* (*Quillaja saponaria*) is another characteristic evergreen tree of this region, whose bark possesses saponaceous properties. In earlier times the coquito palm (*Jubaea spectabilis*) was to be found throughout this part of Chile, but it has been almost completely destroyed for its saccharine sap, from which a treacle was made. One of the most striking forest trees is the *pehuen* or Chilean pine (*Araucaria imbricata*), which often grows to a height of 100 ft. and is prized by the natives for its fruit. Three indigenous species of the beech—the *roble* (*Fagus obliqua*), *coyhue* (*F. Dombeyi*), and *raulí* (*F. procera*)—are widely diffused and highly prized for their wood, especially the first, which is misleadingly called *roble* (oak). Most of the woods used in construction and manufactures are found between the Bio-Bio river and the Taytao peninsula, among which are the *alerce* (*Fitzroya patagonica*), *ciprés* or *Chiloé cypress* (*Lobocedrus tetragona*), the Chilean cypress (*L. Chilensis*), *lingue* (*Persea lingue*), laurel (*Laurus aromatica*), *avellano* (*Guevina avellana*), *luma* (*Myrtus luma*), *espino* (*Acacia cavenia*) and many others. Several exotic species have been introduced into this part of Chile, some of which have thriven even better than in their native habitats. Among these are the oak, elm, beech (*F. sylvatica*), walnut, chestnut, poplar, willow and eucalyptus. Through the central zone the plains are open and there are forests on the mountain slopes, but in the southern zone there are no plains, with the exception of small areas near the Straits of Magellan, and the forests are universal. In the variety, size and density of their growth these forests remind one of the tropics. They are made up, in great part, of the evergreen beech (*Fagus betuloides*), the deciduous antarctic beech (*F. antarctica*),² and Winter's bark (*Drimys Winteri*), intermingled with a dense undergrowth composed of a great variety of shrubs and plants, among which are *Maytenus magellanica*, *Arbutus rigida*, *Myrtus memmolaria*, two or three species of *Berberis*, wild currant (*Ribes antarctica*), a trailing blackberry, tree ferns, reed-like grasses and innumerable parasites. On the eastern side of the Cordillera, in the extreme south, the climate is drier and open, and grassy plains are found, but on the western side the dripping forests extend from an altitude of 1000 to 1500 ft. down to the level of the sea. A peculiar vegetable product of this inclement region is a small globular fungus growing on the bark of the beech, which is a staple article of food among the Fuegians—probably the only instance where a fungus is the bread of a people.

It is generally conceded that the potato originated in southern Chile, as it is found growing wild in Chilóe and neighbouring islands and on the adjacent mainland. The strawberry is also indigenous to these latitudes on both sides of the Andes, and Chile is credited

with a species from which the cultivated strawberry derives some of its best qualities. Maize and quinoa (*Chenopodium quinoa*) were known in Chile before the arrival of Europeans, but it is not certain that they are indigenous. Species of the bean and pepper plant are also indigenous, and the former is said to have been cultivated by the natives. Among the many economic plants which have been introduced into Chile and have become important additions to her resources, the more prominent are wheat, barley, hemp and alfalfa (*Medicago sativa*), together with the staple European fruits, such as the apple, pear, peach, nectarine, grape, fig, olive and orange. The date-palm has also been introduced into the southern provinces of the desert region. Among the marine productions on the southern coast, a species of kelp, *Macrocystis pyrifera*, merits special mention because of its extraordinary length, its habit of clinging to the rocks in strong currents and turbulent seas, and its being a shelter for innumerable species of marine animals. Captain FitzRoy found it growing from a depth of 270 ft.

Fauna.—The fauna of Chile is comparatively poor, both in species and individuals. A great part of the northern deserts is as barren of animal life as of vegetation, and the dense humid forests of the south shelter surprisingly few species. There are no large mammals in all this extensive region except the Cetacea and a species of the *Phocidae* of southern waters. Neither are there any dangerous species of Carnivora, which are represented by the timid puma (*Felis concolor*), three species of wildcats, three of the fox, two of *Conepatus*, a weasel, sea-otter and six species of seal. The rodents are the most numerous represented order, which includes the *coypu* or *nutria* (*Myopotamus coypus*), the chinchilla (*Chinchilla laniger*), the tuco-tuco (*Ctenomys brasiliensis*), a rabbit, and 12 species of mice—in all some 12 genera and 25 species. The *coypu*, sometimes called the South American beaver, inhabits the river-banks, and is highly prized for its fur. It is also found along the river-courses of Argentina. The ruminants are represented by a few species only—the guanaco (*Auchenia huanaco*), *vicuna* (*A. vicugna*), *huemul* (*Cervus chilensis*), which appears on the Chilean escutcheon, and the *puhu* deer, a small and not very numerous species. There are two species of the Edentata, *Dasybus* and *Pichiciego*, the latter very rare, and one of the opossums. European animals, such as horses, cattle, sheep, swine and goats, have been introduced into the country and do well. Sheep-raising has also been inaugurated with some degree of success in the vicinity of the Straits of Magellan. The avifauna, with the exception of waterfowl, is also limited to comparatively few species. Birds of prey are represented by the condor, vulture, two species of the carrion-hawk (*Polyborus*), and owl. The Chilean slopes of the Andes appear to be a favourite haunt of the condor, where neighbouring stock-raisers suffer severe losses at times from its attacks. The *Insessores* are represented by a number of species. Parrots are found as far south as Tierra del Fuego, where Darwin saw them feeding on seeds of the Winter's bark. Humming-birds have a similar range on this coast, one species (*Mellisuga Kingii*) being quite numerous as far south as Tierra del Fuego. A characteristic genus is that of *Pteroptachus*, of which there are three or four species each characterized by some conspicuous peculiarity. These are *P. megapodius*, called *El Turco* by the natives, which is noticeable for its ungainly appearance and awkward gait; the *P. albicollis*, which inhabits barren hillsides and is called *tapacollo* from the manner of carrying its tail turned far forward over its back; the *P. rubecula*, of Chilóe, a small timid denizen of the gloomy forest, called the *cheucau* or *chuca*, whose two or three notes are believed by the superstitious natives to be auguries of impending success or disaster; and an allied species (*Hylactes Tarnii*, King) called the *guid-guid* or barking bird, whose cry is a close imitation of the yelp of a small dog. The southern coast and its inland waters are frequented by several species of petrel, among which are the *Procellaria gigantea*, whose strength and rapacity led the Spaniards to call it *quebranta huesos* (breakbones), the *Puffinus cinereus*, which inhabits the inland channels in large flocks, and an allied species (*Puffinuria Berardii*) which inhabits the inland sounds and resembles the auk in some particulars of habit and appearance. There are numerous species in these sheltered channels, inlets and sounds of geese, ducks, swans, cormorants, ibises, bitterns, red-beaks, curlew, snipe, plover and moorhens. Conspicuous among these are the great white swan (*Cygnus anatoides*), the black-necked swan (*Anser nigricollis*), the antarctic goose (*Anas antarctica*) and the "race-horse" or "steamer duck" (*Micropterus brachypterus*).

The marine fauna is less known than the others, but it is rich in species and highly interesting in its varied forms and characteristics. The northern coast has no sheltered waters of any considerable extent, and the shore slopes abruptly to a great depth, which gives it a marine life of no special importance. In the shoal waters about Juan Fernandez are found a species of codfish (possibly *Gadus macrocephalus*), differing in some particulars from the Newfoundland cod, and a large crayfish, both of which are caught for the Valparaiso market. The sheltered waters of the broken southern coast, however, are rich in fish and molluscs, especially in mussels, limpets and barnacles, which are the principal food resource of the nomadic Indian tribes of those regions. A large species of barnacle, *Balanus psittacus*, is found in great abundance from Concepción to Puerto Montt, and is not only eaten by the natives, by whom it is called *pico*, but is also esteemed a great delicacy in the markets of Valparaiso

¹ Notes of a Naturalist in South America, p. 134.

² Also classified as *Nothofagus* (Mirb.).

and Santiago. Oysters of excellent flavour are found in the sheltered waters of Chiloé. The Cetacea, which frequent these southern waters, are represented by four species—two dolphins and the sperm and right whale—and the *Phocidae* by six species, one of which (*Phoca lupina*) differs but little from the common seal. Another species (*Macrorhinus leoninus*), popularly known as the sea-elephant, is provided with short tusks and a short trunk and sometimes grows to a length of 20 ft. Still another species, the sea-lion (*Otaria jubata*), furnishes the natives of Tierra del Fuego with an acceptable article of food, but like the *Phoca lupina* it is becoming scarce.

Of Reptilia Chile is singularly free, there being recorded only eleven species—five saurians, four ophidians, one frog and one toad—but a more thorough survey of the uninhabited territories of the south may increase this list. There are no alligators in the streams, and the tropical north has very few lizards. There are no poisonous snakes in the country, and, in a region so filled with lakes and rivers as the rainy south, only two species of batrachians. The insect life of these strangely associated regions is likewise greatly restricted by adverse climatic conditions, a considerable part of the northern desert being absolutely barren of animal and vegetable life, while the climate of Tierra del Fuego and the southern coast is highly unfavourable to terrestrial animal life, for which reason comparatively few species are to be found. Writing of a journey inland from Iquique, Charles Darwin says (*Journal of Researches, &c.*, p. 444): "Excepting the *Vultur aura*, . . . I saw neither bird, quadruped, reptile, nor insect." Of his entomological collection in Tierra del Fuego, which was not large, the majority were of Alpine species. Moreover, he did not find a single species common to that island and Patagonia. These conditions subsist with but few modifications, if any, from the Straits northward to the 42nd parallel, the extreme humidity, abnormal rainfall and dark skies being unfavourable to the development of insect life, while the Andes interpose an impassable barrier to migration from the countries of the eastern coast. The only venomous species to be found in central Chile is that of a spider which frequents the wheat fields in harvest time.

Population.—The population of Chile is largely concentrated in the twelve agricultural provinces between and including Coquimbo and Concepción, though the next six provinces to the south, of more recent general settlement, have received some foreign immigrants, and are rapidly growing. In the desert provinces the population is limited to the mining communities, and to the ports and supply stations maintained for their support and for the transport, smelting and export of their produce. The province of Atacama has, in addition to its mining population, a considerable number of agriculturists located in a few irrigated river valleys, which class is largely increased in the adjoining province of Coquimbo. The more northern provinces, however, maintain their populations without the support of such small cultivated areas. In the southern territories unfavourable conditions of a widely different character prevail, and the population is restricted to a few small settlements and some nomadic tribes of Indians. Here, however, there are localities where settlements could be maintained by ordinary means and the population could be greatly increased. Since the census of 1895 the population of Punta Arenas has been largely increased by the discovery of gold in the vicinity. The twelve provinces first mentioned, which include the celebrated "Vale of Chile," comprise only 17% of the area of the republic, but the census of 1895 showed that 72% of the total population was concentrated within their borders. The four desert provinces north of Coquimbo had only 8% of the total, and the seven provinces and one territory south of Concepción had 20%. According to the census of 1895 the total population was 2,712,145, to which the census officials added 10% to cover omissions. This shows an increase slightly over 7% for the preceding decennial period, the population having been returned as 2,527,320 in 1885. The census returns of 1875 and 1866 gave respectively 2,068,447 and 2,084,943, showing an actual decrease in population. During these years Chile held the anomalous position of a country spending large sums annually to secure immigrants while at the same time her own labouring classes were emigrating by thousands to the neighbouring republics to improve their condition. Writing in 1879, a correspondent of *The Times*¹ stated that this emigration then averaged 8000 a year, and in bad times had reached as many as 30,000 in one year. The condition of the Chilean labourer has been much improved since then, however, and Chile no longer suffers so serious a loss of

¹ A. Gallenga, *South America* (London, 1880), p. 181.

population. In 1895, the foreigners included in the Chilean population numbered 72,812, of which 42,105 were European, 29,687 American, and 1020 Asiatic, &c. According to nationality there were 8269 Spanish, 7809 French, 7587 Italian, 7049 German, 6241 British, 1570 Swiss, 1490 Austro-Hungarian, 13,695 Peruvian, 7531 Argentine, 6654 Bolivian, 701 American (U.S.), 797 Chinese. According to residence, 1,471,792 were inhabitants of rural districts, and 1,240,353 of towns. The registration of births, marriages and deaths is compulsory since the 1st of January 1885, but the provisions of the law are frequently eluded. Notwithstanding the healthiness of the climate, the death-rate is high, especially in the large cities. In Santiago and Valparaiso the death-rate sometimes rises to 42 and 60 per 1000, and infant mortality is very high, being 73% of the births in some of the provincial towns. This unfavourable state of affairs is due to the poverty, ignorance and insanitary habits of the lower classes. The government has made repeated efforts to secure immigrants from Europe, but the lands set apart for immigrant settlers are in the forested provinces south of the Bio-Bio, where the labour and hardships involved in establishing a home are great, and the protection of the law against bandits and criminal assaults is weak. The Germans have indeed settled in many parts of these southern provinces since 1845, and by keeping together have succeeded in building up several important towns and a large number of prosperous agricultural communities. One German authority (Hüber) estimates the number of Germans in two of these provinces at 5000. The arrivals, however, have been on the whole discouragingly small, the total for the years 1901-1905 being only 14,000.

Although Chileans claim a comparatively small admixture with the native races, it is estimated that the whites and creoles of white extraction do not exceed 30 to 40% of the population, while the *mestizos* form fully 60%. This estimate is unquestionably conservative, for there has been no large influx of European blood to counterbalance the race mixtures of earlier times. The estimated number of Indians living within the boundaries of Chile is about 50,000, which presumably includes the nomadic tribes of the Fuegian archipelago, whose number probably does not reach 5000. The semi-independent Araucanians, whose territory is slowly being occupied by the whites, are concentrated in the eastern forests of Bio-Bio, Malleco and Cautin, all that remains to them of the Araucania which they so bravely and successfully defended for more than three centuries. Their number does not much exceed 40,000, which is being steadily reduced by drunkenness and epidemic diseases. A small part of these Indians live in settled communities and include some very successful stock-raisers, but the greater part live apart from civilization. There are also some remnants of tribes in the province of Chiloé, which inhabit the island of that name, the Chonos and Guaytecas archipelagoes and the adjacent mainland, who have the reputation of being good boatmen and fishermen; and there are remnants of a people called Changos, on the desert coast, and traces of Calchaqui blood in the neighbouring Andean foothills.

There is a wide difference in every respect between the upper or ruling class and the common people. The former includes the landed proprietors, professional men and a part of those engaged in commercial and industrial pursuits. These educated classes form only a small minority of the population. Many of them, especially the landed proprietors, are descendants of the original Spanish settlers and are celebrated for their politeness and hospitality. The political control of the republic was secured to them by the constitution of 1833. The common people were kept in ignorance and practically in a state of hopeless servitude. They were allowed to occupy small leaseholds on the large estates on condition of performing a certain amount of work for the landlord. Every avenue toward the betterment of their condition was practically closed. The condition of the itinerant labourers (*peons*) was still worse, the wages paid them being hardly sufficient to keep them from starvation. The Chilean *peon*, however, comes from a hardy stock, and has borne all

these hardships with a fortitude and patience which go far to counterbalance his faults. Recent reforms in education, &c., together with the growth of manufacturing industries, are slowly leading to improvements in the material condition of the common people.

The political organization of the country has not been favourable to the development of artistic or scientific tastes, though Chile has produced political leaders, statesmen and polemical writers in abundance. Historical literature has been enriched by the works of Diego Barros Arana, Benjamin Vicuña Mackenna, Miguel Luis Amunátegui, Carlos Walker Martínez, and others. One of the earliest native histories of Chile was that of Abbé J. Ignacio Molina, an English translation of which has long been a recognized authority; it is full of errors, however, and should be studied only in connexion with modern standard works. Among these must be included Claude Gay's monumental work, *Historia General de Chile*, and Sir C. R. Markham's admirable studies on special parts of the subject. In science, nearly all the important work has been done by foreigners, among whom are Charles Darwin, Claude Gay, Eduard Pöppig, Rudolph A. Philippi and Hans Steffen, who deserves special mention for his excellent geographical work in the southern Andes.

Divisions and Towns.—Chile contains 23 provinces and one territory, which are subdivided into 75 departments, 855 subdelegations and 3068 districts. The territory north of the Bio-Bio was originally divided into 13 provinces, besides which the Spaniards held Chiloé, Juan Fernandez and Valdivia, the latter being merely a military outpost. During the years which have elapsed since the War of Independence the territory south of the Bio-Bio has been effectively occupied and divided into six provinces, Chiloé and the neighbouring islands and mainland to the east became a province, and four provinces in the northern deserts were acquired from Bolivia and Peru. In addition to this, Chile claimed Patagonia and the adjacent islands, and has finally secured not only the forested

strip of territory west of the Andes, but also a large piece of the Patagonian mainland, south of lat. 52° S., the larger part of Tierra del Fuego, and all the western islands. This extensive region, comprising an area of 71,127 sq. m., has been provisionally organized as the territory of Magallanes. For a list of provinces, their areas, reduced from official returns, their populations, and the names and populations of their capitals, see the bottom of this page.

In addition to the provincial capitals there are few towns of importance. Among these may be mentioned:—

	Population.			Population.	
	1895.	Est. 1902.		1895.	Est. 1902.
Arica	2,853	2824	Parral	8,586	10,219
Pisagua	3,635	4720	Constitución	6,400	6,453
Taltal	5,834	6574	San Carlos	7,051	6,579
Tocopilla	3,383	4752	Coronel	4,575	5,959
Vallenar	5,052	5199	Lota	9,797	..
Coquimbo	7,322	8165	Talcahuano	10,431	13,499
Ovalle	5,565	5772	El Tomé	3,977	6,189
Los Andes (Santa Rosa)	5,504	6854	Arauco	3,008	3,334
Quillota	9,621	9876	Cañete	2,000	2,552
Vina del Mar	10,651	..	Mulchen	4,268	4,332
Melipilla	4,286	5023	Traiguén	5,732	7,099
Rengo	6,463	7232	Victoria	6,989	10,002
Vichuquen	826	3714	La Unión	2,830	3,908
Molina	3,609	3222	Osorno	4,667	5,888
			Castro(Chiloé)	1,935	2,166

The population is not concentrated in large cities, but is well distributed through the cultivated parts of the country. The large number of small towns, important as ports, market towns, or manufacturing centres, is a natural result. Many of the foregoing towns are only villages in size, but their importance is not to be measured in this way. Arica is one of the oldest ports on the coast, and has long been a favoured port for Bolivian trade because the passes through the Cordilleras at that point are not so difficult. Moreover, the railway from Arica to La Paz will still further add to its importance, though it may not greatly increase its population. Another illustration is that of Vichuquen, province of Curicó, situated on a tide-water lake on the coast, which is the centre of a large salt-making industry. Still another instance is that of Castro, the oldest settlement and former capital of Chiloé, which after a century of decay is increasing again through the efforts to develop the industries of that island.

Communications.—Railway construction in Chile dates from 1850, when work was begun on a short line between Copiapó and the port of Caldera, in the Atacama desert region. Since then lines have been built by private companies from the coast at several points to inland mining centres. One of these, running from Antofagasta to the Caracoles district, was afterwards extended to Oruro, Bolivia, and has become a commercial route of international importance, with a total length of 574 m., 224 of which are in Chile. It should be remembered that many of these railway enterprises of the desert region originated at a time when the territory belonged to Bolivia and Peru. The first railway to be constructed in central Chile was the government line from Valparaiso to Santiago, 115 m. in length, which was opened to traffic in 1863. About the same time the government began the construction of a longitudinal trunk line running southward from Santiago midway between the Andes and the Coast range, and connecting with all the provincial capitals and prominent ports. This is the only railway "system" it is possible for Chile to have. The civil war of 1891 called attention to the need of a similar inland route through the northern provinces. A branch of the Valparaiso and Santiago line runs to Los Andes, and its extension across the Andes connects with the Argentine lines from Buenos Aires to Mendoza and the Chilean frontier—all sections together forming a transcontinental route about 850 m. in length. The Transandine section of this route crosses the Cordillera through the

Provinces.	Area.	Population. Census 1895.	Capitals.	Population.	
				Census 1895.	Est. 1902.
Tacna	9,251	24,160	Tacna	9,418	11,504
Tarapacá	18,131	89,751	Iquique	33,031	42,788
Antofagasta	46,611	44,085	Antofagasta	13,530	16,084
Atacama	30,729	59,713	Copiapó	9,301	8,991
Coquimbo	13,461	160,898	La Serena	15,712	19,536
Aconcagua	5,487	113,165	San Felipe	11,313	11,660
Valparaiso	1,953	220,756	Valparaiso	122,447	142,282
Santiago	5,665	415,636	Santiago	256,403	332,059
O'Higgins	2,342	85,277	Rancagua	6,665	7,133
Colchagua	3,856	157,566	San Fernando	7,447	8,164
Curicó	2,978	103,242	Curicó	12,669	14,340
Talca	3,840	128,961	Talca	33,232	42,766
Lináres	3,942	101,858	Lináres	7,331	7,256
Maule	2,475	119,791	Cauquenes	8,574	9,895
Nuble	3,407	152,935	Chillan	28,738	36,382
Concepción	3,252	188,190	Concepción	39,837	49,351
Arauco	2,458	59,237	Lebú	2,784	3,178
Bio-Bio	5,246	88,749	Los Angeles	7,868	7,777
Malleco	2,973	98,032	Angol	7,056	7,638
Cautín	5,832	78,221	Temuco	7,078	9,699
Valdivia	8,649	60,687	Valdivia	8,060	9,704
Llanquihue	45,515	78,315	Puerto Montt	3,480	4,140
Chiloé	8,593	77,750	Ancud	3,182	3,787
Magallanes (Ter.)	71,127	5,170	Punta Arenas	3,227	8,327
Total, official	307,774	2,712,145			
Total according to Gotha computation	293,062				
With 10% added for omissions		2,983,359			
Official estimate for 1902		3,173,783			

Uspallata pass. A further Transandine scheme provides for a line through the Pino Hachado pass (38° 30' to 39° S.), and the Argentine Great Southern Company obtained a concession in 1909 to extend its Neuquen line to the frontier of Chile. The railways of the republic had a total mileage at the end of 1906 of 2950 m., of which 1495 m. were owned by the state, and 1455 m. belonged to private companies. The private lines are located in the northern provinces and are for the most part built and maintained for the transportation of mining products and supplies.

In addition to her railway lines Chile has about 21,000 m. of public roads of all descriptions, 135 m. of tramways, and 705 m. of navigable river channels, besides a very considerable mileage of lake and coast navigation. Telegraphic communication between all the important towns of the republic, initiated in 1855 with a line between Santiago and Valparaiso, is maintained by the state, which in 1903 owned 9306 m. of line in a total of 11,080 m. Cable communication with Europe by way of Buenos Aires was opened in 1875, and is now maintained by means of two underground cables across the Andes, 32 m. in length. A West Coast cable also connects with Europe and North American states by way of Panama. There were 15,853 m. of telephone wires in the republic in 1906, all the principal cities having an admirable service. Modern postal facilities date from 1853. The Chilean post-office is administered by a director-general at Santiago, and has a high degree of efficiency and liberality, compared with those of other South American states. The postal rates are low, and newspapers and other periodical publications circulate free, as a means of popular instruction. The postal revenues for 1904 amounted to 2,775,730 pesos and the expenditures to 2,407,753 pesos. Chile is a member of the International Postal Union, and has arrangements with the principal commercial nations for the exchange of postal money values.

The sea has been the only means of communication with distant parts of the country, and must continue to be the chief transportation route. There are said to be 56 ports on the Chilean coast, of which only 12 are prominent in foreign trade. Many of the so-called ports are only landing-places on an open coast, others are on shallow bays and obstructed river-mouths, and some are little-known harbours among the channels and islands of the south. The prosperity of Chile is intimately connected with her ocean-going trade, and no elaborate system of national railway lines and domestic manufactures can ever change this relationship. These conditions should have developed a large merchant marine, but the Chileans are not traders and are sailors only in a military sense. In 1905 their ocean-going merchant marine consisted of only 148 vessels, of which 54 were steamers of 42,873 tons net, and 94 were sailing vessels of 39,346 tons. Nineteen of the 54 steamers belonged to a subsidized national line whose West Coast service once extended to San Francisco, California, and a large part of the others belongs to a Lota coal-mining and copper-smelting company which employs them in carrying coal to the northern ports and bringing back metallic ores for smelting. The navigable rivers and inland lakes employ a number of small steamers. The foreign commerce of the republic is carried chiefly by foreign vessels, and the coasting trade is also open to them. Three or four foreign companies maintain a regular steamship service to Valparaiso and other Chilean ports. The shipping entries at all Chilean ports during the year 1904, both national and foreign, numbered 11,756, aggregating 17,723,138 tons, and the clearances 11,689, aggregating 17,370,763 tons. Very nearly one-half this tonnage was British, a little over 18% German, and about 29% Chilean.

Commerce.—In the aggregate, the commerce of Chile is large and important; in proportion to population it is exceeded among South American states only by Argentina, Uruguay and the Guianas. Unlike those states, it depends in great part on mining and its allied occupations. The values of imports and exports (including bullion, specie and re-exports) in pesos of 18d. during the five years 1901-1905 were as follows:—

Year.	Imports. pesos.	Exports. pesos.
1901	139,300,766	171,844,976
1902	132,428,204	185,879,965
1903	149,081,524	210,442,144
1904	164,874,928	232,493,598
1905	188,596,418	265,209,192

The principal imports comprise live animals, fish, coffee, maté (*Ilex paraguayensis*), tea, sugar, wood and its manufactures, structural iron and steel, hardware and machinery, railway and telegraph supplies, lime and cement, glass and earthenware, cotton, woollen and silk manufactures, coal, petroleum, paints, &c. Import duties are imposed at the rates of 60, 35, 15, 5 and 25%, and certain classes of merchandise are admitted free. The higher rates are designed chiefly to protect national industries, while wines, liquors, cigars and tobacco are admitted at the lowest rate. The 25% rate covers all articles not mentioned in the schedules, which number 2260 items. The duty free list includes raw cotton, certain descriptions of live animals, agricultural machinery and implements, metal wire, fire engines, structural iron and steel, and machinery in general. The tariff is nominally *ad valorem*, but as the rates are imposed on fixed official valuations it is essentially specific. The duties on

imports in 1905 amounted to 91,321,860 pesos, and in 1906 to 103,507,556 pesos. The principal exports are gold, silver, copper (bars, regulus and ores), cobalt and its ores, lead and its ores, vanadium ores, manganese, coal, nitrate of soda, borate of lime, iodine, sulphur, wheat and guano. Nitrate of soda forms from 70 to 75% of the exports, and the royalty received from it is the principal source of national revenue, yielding about £4,000,000 per annum. In 1904 mineral products made up fully seven-eighths of the exports, while agricultural and pastoral products did not quite reach one-eighth.

Agriculture.—According to the census returns about one-half the population of Chile lives in rural districts, and is engaged nominally in agricultural pursuits. What may be called central Chile is singularly well adapted to agriculture. The northern part of this region has a sub-tropical climate, light rainfall and a long, dry summer, but with irrigation it produces a great variety of products. Alfalfa, or lucerne (*Medicago sativa*), is grown extensively for shipment to the mining towns of the desert provinces. There were no less than 108,384 acres devoted to it in 1904, a considerable part of which was in the irrigated river valleys of Coquimbo and Aconcagua. Considerable attention is also given to fruit cultivation in these sub-tropical provinces, where the orange, lemon, fig, melon, pineapple and banana are produced with much success. Some districts, especially in Coquimbo, have gained a high reputation for the excellence of their preserved fruits. The vine is cultivated all the way from Atacama and Coquimbo, where excellent raisins are produced, south to Concepción, where some of the best wines of Chile are manufactured. In 1904 there were 93,370 acres devoted to grape production in this region, the product for that year being 30,184,704 gallons of wine and 212,366 gallons of brandy. The universal beverage of the people—*chicha*—is made from Indian corn. Although wheat is produced in the northern part of this region, it is grown with greater success in the south, where the rainfall is heavier and the average temperature is lower. There were 1,044,025 acres devoted to this cereal in 1903, which produced 17,910,614 bushels, or an average of 17 bushels (of 60 lb) to the acre. In 1904 the production was increased to 19,999,324 bushels, but in 1905 it fell off to 15,771,477 bushels. At one time Chile supplied Argentina and the entire West Coast as far north as California with wheat, but Argentina and California have become wheat producers and exporters, and Chile has been driven from all her old consuming markets. Great Britain is now her best customer, and Brazil takes a small quantity for milling mixtures. Chile has been badly handicapped by her crude methods of cultivation, but these are passing away and modern methods are taking their place. Formerly wheat was grown chiefly in the region of long rainless summers, and the ripened grain was thrown upon uncovered earth floors and threshed by horses driven about over the straw, but this antiquated process was not suited to the climate and enterprise of the more southern provinces, and the modern threshing-machine has been introduced. Barley is largely produced, chiefly for home consumption. Maize (Indian corn) is grown in every part of Chile except the rainy south where the grain cannot ripen, and is a principal article of food. The green maize furnishes two popular national dishes, *chados* and *humitas*, which are eaten by both rich and poor. Potatoes also are widely cultivated, but the humid regions of the south, particularly from Valdivia to Chiloé, produce the greatest quantity. The total annual production exceeds three million bushels. The kidney bean (*Phaseolus vulgaris*) is another staple product in every part of the country, and is perhaps the most popular article of food among all classes of Chileans. Peas are largely cultivated south of the Maule. Walnuts have become another important product and are exported, the average annual produce being 48,000 to 50,000 bushels. The olive was introduced from Spain in colonial times and is widely distributed through the north central provinces, but its economic importance is not great. Of the European fruits introduced into the southern provinces, the apple has been the most successful. It grows with little care and yields even better than in its original home. The peach, apricot, plum, quince and cherry are also cultivated with success. Wild strawberries are found on both sides of the Andes; the cultivated varieties are unsurpassed, especially those of the province of Concepción.

The pastoral industries of Chile have been developed chiefly for the home market. The climate is admirably suited to cattle-raising, as the winters are mild and pasture is to be found throughout the whole year, but the proximity of the Argentine pampas is fatal to its profitable development. The government has been trying to promote cattle-breeding by levying duties (as high as 16 pesos a head) on cattle imported from Argentina, but with no great success. The importation, which formerly numbered about 140,000 per annum, still numbers not far from 100,000 head. There are some districts in central Chile where cattle-raising is the principal occupation, but the long dry summers limit the pasturage on the open plains and prevent the development which perhaps would otherwise result. As in Argentina, beef is generally dried in the sun to make *charqui* (jerked beef), in which form it is exported to the desert provinces. Horse and mule breeding are carried on to a limited extent, and since the opening of the far South more attention has been given to sheep. Goats and swine are raised in small numbers on the large estates, but in Chiloé swine-raising is one of the chief occupations

of the people. Some attention has been given to the production of butter and cheese, but the industry has attained no great importance. A new industry which has made noteworthy progress, however, is that of bee-keeping, which is greatly favoured by the mild climate and the long season and abundance of flowers.

Manufactures.—The manufacturing interests of Chile have become influential enough to force a high tariff policy upon the country. They have been restricted principally to articles of necessity—food preparations, beverages, textiles and wearing apparel, leather and leatherwork, woodwork, pottery, chemicals, ironware, &c. In earlier days, when Chile had less competition in the production of wheat, flour mills were to be found everywhere in the wheat-producing provinces, and flour was one of the leading exports. Concepción, Talca, and other provincial capitals developed important milling industries, which were extended to all the chief towns of the newer provinces south of the Bio-Bio. There are over 500 large flour mills in Chile, the greater part of which are equipped with modern roller-process machinery. The development of the coal deposits in the provinces of Concepción and Arauco has made possible other industries besides those of smelting mineral ores, and numerous small manufacturing establishments have resulted, especially in Santiago, Valparaíso, Copiapó and other places where no permanent water power exists. Tanning leather is an important industry, especially in the south, some of the Chilean trees, notably the *algarroballa* (*Balsamocarpon brevifolium*) and *lingue* (*Persea lingue*), being rich in tannin. To provide a market for the leather produced, factories have been established for the manufacture of boots and shoes, harness and saddles, and under the protection of a high tariff are doing well. Brewing and distilling have made noteworthy progress, the domestic consumption of their products being very large. The breweries are generally worked by Germans and are situated chiefly in the south, though there are large establishments in Santiago and Valparaíso. Small quantities of their products are exported. Furniture and carriage factories, cooperages, and other manufactories of wood are numerous and generally prosperous. There are likewise a large number of factories for canning and preserving fruits and vegetables. Foundries and machine shops have been established, especially for the manufacture of railway material. The sugar beet has been added to the productions of Chile, and with it the manufacture on a small scale of beet sugar. There is one large refinery at Viña del Mar, however, which imports raw cane sugar from Peru for refining. The manufacture of textiles is carried on at Santiago and El Tomé, and numerous small factories are devoted to clothing of various descriptions. The great mining industries have led to a noteworthy development in the production of chemicals, and a considerable number of factories are engaged in the production of pharmaceutical preparations, perfumeries, soaps, candles, &c.

Mining.—The most important of all the national industries, however, is that of mining. In 1903 there were 11,746 registered mines, on which mining dues were paid, the aggregate produce being valued at 178,768,170 pesos. These mines gave employment to 46,592 labourers, of whom 24,445 were employed by the nitrate companies, 13,710 in various metalliferous mines, 6437 in coal mines, and 2000 in other mines. Gold is found in nearly all the provinces from Antofagasta to Concepción, and in Llanquihue, Chiloé and Magallanes territory, but the output is not large. There are a great many placer washings, among which are some extensive deposits near the Straits of Magellan. Silver is found principally on the elevated slopes and plateaus of the Andes in the desert provinces of the north. The second most important mining industry in Chile, however, is that of copper, which is found in the provinces of Antofagasta, Atacama, Coquimbo, Aconcagua, Valparaíso, Santiago, O'Higgins, Colchagua, Curicó and Talca, but the richest deposits are in the three desert provinces. Chile was once the largest producer of copper in the world, her production in 1860-1864 being rated at 60 to 67% of the total. Low prices afterwards caused a large shrinkage in the output, but she is still classed among the principal producers. Iron mining has never been developed in Chile, although extensive deposits are said to exist. Manganese ores are mined in Atacama and Coquimbo, and their export is large. The other metals reported in the official returns are lead, cobalt and vanadium, of which only small quantities are produced. Bolivian tin is exported from Chilean ports. Among the non-metallic minerals are nitrate of soda, borate of lime, coal, salt and sulphur, together with various products derived from these minerals, such as iodine, sulphuric acid, &c. Guano is classed among the mineral products and still figures as an export, though the richest Chilean deposits were exhausted long before the war with Peru. Of non-metallic products nitrate of soda is by far the most important. Extensive deposits of the salt (called *caliche* in its crude, impure state) in the provinces of Tacna, Tarapacá, Antofagasta and Atacama owe their existence to the rainless character of the climate. Those of the first-named province have been discovered since the war between Chile and Peru, and have greatly extended the prospective life of the industry. The nitrate fields, which lie between 50 and 100 m. from the coast and at elevations exceeding 2000 ft. above sea-level, have been officially estimated at 89,177 hectares (344 sq. m.) and to contain 2316 millions of metric quintals (254,760,000 short tons). The first export of nitrates was in 1830, and in 1884 it reached an aggregate of 550,000 tons, and in 1905 of 1,603,140 tons. The latter

figure is apparently about the production agreed upon between the Chilean government and the nitrate companies to prevent over-production and a resulting decline in price. Nearly all the *oficinas*, or working plants, are owned and operated by British companies, and the railways of this desolate region are generally owned by the same companies and form a part of the working plant. Borate of lime also furnishes another important export, though a less valuable one than nitrate of soda. Extensive deposits of borax and common salt have been found in the same region, which with several other products of these saline deposits, such as iodine, add considerably to its exports. The coal deposits of Chile are found chiefly in the provinces of Concepción and Arauco, the principal mines being on the coast of the Bay of Arauco at Coronel and Lota. Coal is found also in Valdivia, on the island of Chiloé, and in the vicinity of Punta Arenas on the Straits of Magellan. Sulphur is found in the volcanic regions of the north, but the principal mines are in the provinces of Talca.

The relative magnitude and value of these mineral products may be seen in the following abstract from the official returns of 1903:—

	Unit.	Quantity.	Value pesos (of 18d.).
Gold	grammes	1,424,625	1,745,115
Silver	"	39,012,382	1,284,308
Copper	kilogrs.	29,923,132	21,438,397
Lead	"	70,984	9,097
Cobalt ore	"	284,990	99,695
Lead and Vanadium ores	"	2,000	
Manganese ore	"	17,110,000	682,400
Coal	tons	827,112	8,250,720
Nitrates	metric quintals	14,449,200	140,102,012
Iodine	kilogrs.	157,444	1,687,327
Borates	"	16,878,913	2,363,048
Salt	metric quintals	162,635	324,270
Sulphur	kilogrs.	3,440,642	337,515
Sulphuric acid	"	1,600,000	176,000
Guano	metric quintals	111,335	267,466
Various	kilogrs.	200	800

Government.—Chile is a centralized republic, whose government is administered under the provisions of the constitution of 1833 and the amendments of the 9th of August 1888, the 11th of August 1890, the 20th of August 1890, the 22nd of December 1891, and the 7th of July 1892. According to this constitution the sovereignty resides in the nation, but suffrage is restricted to married citizens over twenty-one and unmarried citizens over twenty-five years of age, not in domestic service, who can read and write, and who are the owners of real estate, or who have capital invested in business or industry, or who receive salaries or incomes proportionate in value to such real estate as investment; and as 75% of the population is classed as illiterate, and a great majority of the labouring classes is landless, badly paid, and miserably poor, it is apparent that political sovereignty in Chile is the well-guarded possession of a small minority. The dominant element in this minority is the rich landholding interest, and the constitution and the laws of the first half-century were framed for the special protection of that interest.

The supreme powers of government are vested in three distinct branches—legislative, executive and judicial. The legislative power is exercised by a national congress, which consists of two chambers—a senate of 32 members, and a chamber of deputies of 94 members. The membership of the lower house is in the proportion of one deputy for each 30,000 of the departmental population, and each fraction over 15,000; and the senate is entitled to one-third the membership of the chamber. The senators are elected by provinces and by a direct cumulative vote, and hold office for six years, one-half of the senate being renewed every three years. The deputies are elected by departments and by a direct cumulative vote, and hold office for three years. Both senators and deputies must have reached the age of thirty-six, must have a specified income, and are required to serve without salary. A permanent committee of 14 members represents the two chambers during the congressional recess and exercises certain supervisory and advisory powers in the administration of public affairs. Congress convenes each year on the 1st of June and sits until the 1st of September, but the president may prorogue an ordinary session for a period of 50

days, and with the consent of the council of state may convene it in extraordinary session. Congress has the privilege of giving or withholding its confidence in the acts of the government.

The executive is a president who is elected for a term of five years and is ineligible for the next succeeding term. He is chosen by electors, who are elected by departments in the manner prescribed for deputies and in the proportion of three electors for each deputy. These elections are held on the 25th of June in the last year of a presidential term, the electors cast their votes on the 25th of July, and the counting takes place in a joint session of the two chambers of congress on the 30th of August, congress in joint session having the power to complete the election when no candidate has been duly chosen by the electors. The formal installation of the president takes place on the 18th of September, the anniversary of the declaration of national independence. In addition to the prerogatives commonly invested in his office, the president is authorized to supervise the judiciary, to nominate candidates for the higher ecclesiastical offices, to intervene in the enforcement of ecclesiastical decrees, papal bulls, &c., to exercise supervisory police powers, and to appoint the intendants of provinces and the governors of departments, who in turn appoint the sub-delegates and inspectors of subordinate political divisions. The president, who is paid £2250 per annum, must be native-born, not less than thirty years of age, and eligible for election to the lower house. He is assisted and advised by a cabinet of six ministers whose departments are: interior, foreign affairs, worship and colonization, justice and public instruction, war and marine, finance, industry and public works. In case of a vacancy in the presidential office, the minister of interior becomes the "vice-president of the republic" and discharges the duties of the executive office until a successor can be legally elected. A council of state of 12 members, consisting of the president, 6 members appointed by congress and 5 by the president, has advisory functions, and its approval is required in many executive acts and appointments.

The provinces are administered by *intendentes*, and the departments by *gobernadores*, both appointees of the national executive. The sub-delegacies are governed by *sub-delegados* appointed by the governors, and the districts by *inspectores* appointed by the sub-delegates. Directly and indirectly, therefore, the administration of all these political divisions is in the hands of the president, who, in like manner, makes and controls the appointments of all judicial functionaries, subject, however, to receiving recommendations of candidates from the courts and to submitting appointments to the approval of the council of state. This gives the national executive absolute control of all administrative matters in every part of the republic. The police force also is a national organization under the immediate control of the minister of interior, and the public prosecutor in every department is a representative of the national government. There is no legislative body in any of these political divisions, nor any administrative official directly representing the people, with this exception: under the law of the 22nd of December 1891, municipalities, or communes, are created and invested with certain specified powers of local government affecting local police services, sanitation, local improvements, primary instruction, industrial and business regulations, &c.; they are authorized to borrow money for sanitary improvements, road-making, education, &c., and to impose certain specified taxes for their support; these municipalities elect their own *alcaldes*, or mayors, and municipal councils, the latter having legislative powers within the limits of the law mentioned.

Justice.—The judicial power consists of a Supreme Court of Justice of seven members located in the national capital, which exercises supervisory and disciplinary authority over all the law courts of the republic; six courts of appeal, in Tacna, Serena, Valparaiso, Santiago, Talca and Concepción; tribunals of first instance in the department capitals; and minor courts, or justices of the peace, in the sub-delegacies and districts. The jury system does not exist in Chile, and juries are unknown except in cases where the freedom of the press has been abused. All trials, therefore, are heard by one or more judges, and appeals may be taken from a lower to a higher court. The government is represented in each department by a public prosecutor. The police officials, who are under the direct

control of the minister of interior, also exercise some degree of judicial authority. This force is essentially military in its organization, and consisted in 1901 of 500 officers, 934 non-commissioned officers and 5400 police soldiers. Small forces of local policemen are supported by various municipalities. The judges of the higher courts are appointed by the national executive, and those of the minor tribunals by the federal official governing the political division in which they are located.

Army.—For military purposes the republic is divided into five districts, the northern desert provinces forming the first, the central provinces as far south as the Bio-Bio the second and third, and the southern provinces and territory the fourth and fifth. Large sums of money have been expended in arms, equipment, guns and fortifications. The army is organized on the German model and has been trained by European officers who have been employed both for the school and regiment. Though the president and minister of war are the nominal heads of the army, its immediate direction is concentrated in a general staff comprising six service departments, at the head of which is a chief of staff. After the triumph of the revolutionists in the civil war of 1891, the army was reorganized under the direction of Colonel Emil Körner, an accomplished German officer, who subsequently served as chief of the general staff. In 1904 the permanent force consisted of 12 battalions of infantry, 6 regiments of cavalry, 4 regiments of mountain artillery, 1 regiment of horse artillery, 2 regiments of coast artillery, and 5 companies of engineers—aggregating 915 officers and 4757 men. To this nucleus were added 6160 recruits, the contingent for that year of young men twenty-one years of age compelled to serve with the colours. Under the law of the 5th of September 1900, military service is obligatory for all citizens between eighteen and forty-five years, all young men of twenty-one years being required to serve a certain period with the regular force. After this period they are transferred to the 1st reserve for 9 years, and then to the 2nd reserve. The military rifle adopted for all three branches of the service is the Mauser, 1895 model, of 7 mm. calibre, and the batteries are provided with Krupp guns of 7 and 7.5 cm. calibre. Military instruction is given in a well-organized military school at Santiago, a war academy and a school of military engineering.

Navy.—The Chilean navy is essentially British in organization and methods, and all its best fighting ships were built in British yards. In 1906 the effective fighting force consisted of 1 battleship, 2 belted cruisers, 4 protected cruisers, 3 torpedo gunboats, 6 destroyers and 8 modern torpedo boats. In addition to these there are several inferior armed vessels of various kinds which bring the total up to 40, not including transports and other auxiliaries. The administration of the navy, under the president and minister of war and marine, is confided to a general naval staff, called the "Dirección general de la Armada," with headquarters at Valparaiso. Its duties also include the military protection of the ports, the hydrographic survey of the coast, and the lighthouse service. The *personnel* comprises about 465 officers, including those of the staff, and 4000 petty officers and men. There is a military port at Talcahuano, in Concepción Bay, strongly fortified, and provided with arsenal and repair shops, a large dry dock and a patent slip. The naval school, which occupies one of the noteworthy edifices of Valparaiso, is attended by 90 cadets and is noted for the thoroughness of its instruction.

Education.—Under the old conservative régime very little was done for the public school outside the larger towns. As a large proportion of the labouring classes lived in the small towns and rural communities, they received comparatively little attention. The increasing influence of more liberal ideas greatly improved the situation with reference to popular education, and the government now makes vigorous efforts to bring its public school system within the reach of all. The constitution provides that free instruction must be provided for the people. School attendance is not compulsory, however, and the gain upon illiteracy (75 %) appears to be very slow. The government also gives primary instruction to recruits when serving with the colours, which, with the increasing employment of the people in the towns, helps to stimulate a desire for education among the lower classes. Education in Chile is very largely under the control of the national government, the minister of justice and public instruction being charged with the direction of all public schools from the university down to the smallest and most remote primary school. The system includes the University of Chile and National Institute at Santiago, lyceums or high schools in all the provincial capitals and larger towns, normal schools at central points for the training of public school teachers, professional and industrial schools, military schools and primary schools. Instruction in all these is free, and under certain conditions text-books are supplied. In the normal schools, where the pupils are trained to enter the public service as primary teachers, not only is the tuition free, but also books, board, lodging and everything needed in their school work. The national university at Santiago comprises faculties of theology, law and political science, medicine and pharmacy, natural sciences and mathematics, and philosophy. The range of studies is wide, and the attendance large. The National Institute at Santiago is the principal high school of the secondary grade in Chile. There were 30 of these high schools for males and 12 for females in 1903, with an aggregate of 11,504 matriculated students. The normal schools for males are located at Santiago, Chillán and

Valdivia; and for females at La Serena, Santiago and Concepción. The mining schools at Copiapó, La Serena and Santiago had an aggregate attendance of 180 students in 1903, and the commercial schools at Iquique and Santiago an attendance of 214. The more important agricultural schools are located at Santiago, Chillán, Concepción and Ancud, the Quinta Normal de Agricultura in the national capital having a large attendance. The School of Mechanic Arts and Trades (*Escuela de Artes y Oficios*) of Santiago has a high reputation for the practical character of its instruction, in which it is admirably seconded by a normal handicraft school (Slöyd system) and a night school of industrial drawing in the same city, and professional schools for girls in Santiago and Valparaiso, where the pupils are taught millinery, dress-making, knitting, embroidery and fancy needlework. The government also maintains schools for the blind and for the deaf and dumb. The public primary schools numbered 1961 in 1903, with 3608 teachers, 166,928 pupils enrolled, and an average attendance of 108,582. The cost of maintaining these schools was 4,146,574 pesos, or an average of £2 : 17 : 3 per pupil in attendance. In addition to the public schools there are a Roman Catholic university at Santiago, which includes law and civil engineering among its regular courses of study; numerous private schools and seminaries of the secondary grade, with a total of 11,184 students of both sexes in 1903; and 506 private primary schools, with an attendance of 29,684. The private schools usually conform to the official requirements in regard to studies and examinations, which facilitates subsequent admission to the university and the obtainment of degrees; probably they do better work than the public schools, especially in the German settlements of the southern provinces. A Consejo de Instrucción Pública (council of public instruction) of 14 members exercises a general supervision over the higher and secondary schools. There are schools of music and fine arts in Santiago. The national library at Santiago, with 116,300 volumes in 1906, and the national observatory, are both efficiently administered. At the beginning of the 20th century there were 41 public libraries in the republic, including public school collections, with an aggregate of 240,000 volumes.

Charities.—According to the returns of 1903 there were 88 hospitals in the republic, which reported 79,051 admissions during the year, and had 6215 patients under treatment at its close; 628,536 patients received gratuitous medical assistance at the public dispensaries during the year; there were 24 foundling hospitals with 5570 children; and there were 3092 persons in the various *hospicios* or asylums, and 1478 in the imbecile asylums.

Religion.—The Roman Catholic religion is declared by the constitution to be the religion of the state, and the inaugural oath of the president pledges him to protect it. A considerable part of its income is derived from a subsidy included in the annual budget, which makes it a charge upon the national treasury like any other public service. The secular supervision of this service is entrusted to a member of the president's cabinet, known as the minister of worship and colonization. The executive and legislative powers intervene in the appointments to the higher offices of the Church. The greater part of the population remains loyal to the established faith. The law of 1865 gives the privilege of religious worship to other faiths, and the laws of 1883 made civil marriage and the civil registry of births, deaths and marriages obligatory, and secularized the cemeteries. Under the reform of 1865 full religious freedom is practically accorded, and it is provided that the services of religious organizations other than the Roman Catholic may be held in private residences or in edifices owned by private individuals or corporations. Of the 72,812 foreigners residing in Chile in 1895, about 16,000 were described as Protestants. Notwithstanding the opposition of some political elements to the Church, the Chileans themselves may all be classed as Roman Catholics. The ecclesiastical organization includes one archbishop, who resides at Santiago, three bishops residing at La Serena, Concepción and Ancud, and two vicars residing in Antofagasta and Tarapacá. These benefices are filled by appointments from lists of three prepared by the council of state and sent to Rome by the president, and in the case of an archbishop or bishop the appointment must also receive the approval of the Senate. The Chilean clergy are drawn very largely from the higher classes, and their social standing is much better than in many South American states. The Church also possesses much property of its own, and is therefore able to maintain itself on a comparatively small subsidy from the public treasury, which was 985,910 pesos (£73,943) in 1902. The Church maintains seminaries in all cathedral towns, and these also receive a subsidy from the government.

Finance.—For a long time Chile was considered one of the poorest states of Spanish America, but the acquisition of the rich mineral-producing provinces of the north, together with the development of new silver and copper mines in Atacama and Coquimbo, largely increased her revenues and enabled her to develop other important resources. During the decade 1831–1840 the annual revenues averaged about 2,100,000 pesos (of 48d.), which in the decade 1861–1870 had increased to an average of only 8,200,000 pesos—and this during a period of considerable agricultural activity on account of wheat exports to California and Australia. After 1870 the revenues increased more rapidly owing to the development of new mining industries, the receipts in 1879 amounting to 15,300,000 pesos, and in 1882 to 28,900,000 pesos. The revenues from the captured

Peruvian nitrate fields then became an important part of the national income, which ten years later (1902) reached an aggregate of 138,507,178 pesos (of 18d.), of which 105,072,832 pesos were in gold. In 1906 the receipts from all sources were estimated at 149,100,000 pesos, of which 62,200,000 pesos gold were credited to the tax on nitrate, 39,800,000 pesos gold to import duties, and 23,500,000 pesos currency to railway receipts. During these years of fiscal prosperity the country suffered much from financial crises caused by industrial stagnation, an excessive and depreciated paper currency and political disorder. To ensure an income that would meet its foreign engagements, the government collected the nitrate and iodine taxes and import duties in gold. As a considerable part of the expenditures were in gold, the practice was adopted of keeping the gold and currency accounts separate. In 1895 a conversion law was passed in which the sterling value of the peso was reduced to 18d., at which rate the outstanding paper should be redeemed. A conversion fund was also created, and, although the government afterwards authorized two more large issues, the beneficial effects of this law were so pronounced that the customs regulations were modified in 1907 to permit the payment of import duties in paper. The national revenue is derived chiefly from the nitrate taxes, customs duties, alcohol tax, and from railway, postal and telegraph receipts. There is no land tax, and licence or business taxes are levied by the municipalities for local purposes. The national expenditures are chiefly for the interest and amortization charges on the public debt, official salaries, military expenses in connexion with the army and navy, public works (including railway construction, port improvements, water and sewage works), the administration of the state railways, telegraph lines and post office, church subsidies, public instruction and foreign representation.

The ordinary and extraordinary receipts and expenditures for the five years 1899–1903, in gold and currency, in pesos of 18d., were as follows:—

	Receipts, pesos.		Expenditures, pesos.	
	Gold.	Paper.	Gold.	Paper.
1899	83,051,604	45,239,970	31,732,797	76,749,793
1900	89,869,178	46,515,102	30,564,821	82,143,742
1901	74,665,061	35,394,434	39,808,517	91,087,171
1902	105,072,832	33,434,346	45,093,278 ¹	89,170,087 ¹
1903	108,503,565	32,490,145	12,508,075	84,721,437

For 1906 the expenditures were fixed at 149,000,000 pesos, and the revenues were estimated to produce 149,100,000 pesos, which included 62,200,000 pesos gold from nitrate taxes, 39,800,000 pesos gold and 200,000 pesos paper from import duties, 23,500,000 pesos paper from the state railways, 2,500,000 pesos paper from postal and telegraph receipts, and 15,000,000 pesos gold from loans. How the revenues are expended is shown in the estimates for 1907, in which the total expenditures were estimated at 134,830,532 pesos paper and 58,796,780 pesos gold, the principal appropriations being 16,192,780 pesos paper and 99,733 gold for the war department, 10,460,781 paper and 6,315,731 gold for the marine department, 40,934,273 paper and 16,984,671 gold for railways, and 6,324,817 paper for public works. In addition to these the budget of 1906 provided for gold expenditures in 1907 of 7,000,000 pesos on sanitary works and 8,000,000 pesos on the Arica-La Paz railway. The custom of dividing receipts and expenditures into ordinary and extraordinary, of treating the receipts from loans as revenue, of adding six months to the fiscal year for closing up accounts, and of dividing receipts and expenditures into separate gold and currency accounts, leads to much confusion and complication in the returns, and is the cause of unavoidable discrepancies and contradictions.

In May 1906 the external debt of the republic aggregated £21,700,000, including the loans of 1905 and 1906, amounting to £5,700,000, for sanitary works and railway construction. At the same time the internal debt was 107,000,000 pesos (£8,025,000), which increases the funded indebtedness to £29,725,000. Like Brazil, Chile has been careful to preserve her foreign credit, and though an average indebtedness of about £10 per capita may seem large for a nation with so much absolute poverty among its people, the government is finding no difficulty in negotiating new loans, the mineral resources of the country and the conservative instincts of the people being considered satisfactory guarantees. According to official returns, the real-estate valuations in 1903–1904 aggregated 1,777,217,704 pesos, of which 1,020,609,215 pesos were in urban and 754,608,489 pesos in rural property. Of the total returned, 1,775,217,704 is described as taxable, and 262,626,576 pesos as nontaxable. The large and steadily increasing receipts from import duties, amounting to 91,321,860 pesos in 1905, and 103,507,556 pesos in 1906, appears to indicate an encouraging state of prosperity in the country, although an average of 3½ pesos a year (nearly £2 : 12s.), in addition to the increased prices paid for home manufactures, seems to be a very heavy indirect tax upon so poor a people.

Currency.—The monetary circulation in Chile consists almost wholly of paper currency, nominally based on a gold standard of

¹ The expenditures of 1902 are also given as 25,882,702 pesos gold, and 108,844,693 pesos currency.

18d. per peso. The conversion law of 1895 made the currency convertible at this rate, although the gold peso was rated at 48d. previous to that date; but the financial crisis of 1898 caused the suspension of specie payments, and a forced issue of additional paper led to a further postponement of conversion and the prompt withdrawal of specie from circulation. The paper circulation consists of national and bank issues. The former owes its existence very largely to the war with Peru, the civil war of 1891, and the financial troubles of 1898. On the 1st of January 1890 the national issues stood at 22,487,916 pesos, and the bank issues at 16,679,790 pesos, making a total of 39,167,706 pesos currency in circulation. This total was largely increased by President Balmaceda in 1891. On the 31st of July 1898 the conversion of paper notes, under the law of 1st June 1895, was suspended, and the government issued 27,989,929 pesos to the banks of issue, which was described as a loan at 2 %, and raised their outstanding circulation to 40,723,089 pesos, and at the same time issued on its own account 17,693,890 pesos and assumed responsibility for 1,193,641 pesos which had been illegally put into circulation before 1896. This gave an aggregate registered circulation of 86,045,166 pesos in 1898. In 1904 another issue of 30,000,000 pesos was authorized and the date of conversion was still further postponed, and in 1907 a more general act provided that the maximum paper circulation should not exceed 150,000,000 pesos of the value of 18d. per peso, and that new issues should be made only through the issue department and against deposits of gold, which deposits would be returned to depositors on the presentation of the currency issued. The redemption of this issue was guaranteed by a conversion fund of 100,000,000 pesos, and by an authorization to issue a loan of 50,000,000 pesos to redeem the balance, if necessary. The conversion fund under the act of 1895 stood at 77,282,257 pesos (£5,796,170) on the 31st of May 1907. There are 23 joint-stock banks of issue, with an aggregate registered capital of 40,689,665 pesos (£3,051,724). Their circulating notes are secured by deposits in the national treasury of gold, government notes and other approved securities. There is no state bank, though the Bank of Chile, with its numerous agencies and its paid-up capital of 20,000,000 pesos, may be said to fill the place of such an institution. Besides these, there are four non-issue banks, two foreign banks and their agencies, and three mortgage banks, with agencies at the important provincial centres, which loan money on real-estate security and issue interest bearing hypothecary notes to bearer. There are 8 savings banks in the republic, whose aggregate deposits on the 31st of December 1906 were 14,799,728 pesos.

The monetary unit, the gold peso, does not form a part of the actual coinage. The gold coins authorized by this law are the *condor* of 20 pesos, the *medio condor*, or *doblon*, of 10 pesos, and the *escudo* of 5 pesos. The silver coins are the *peso* of 100 centavos and its fractional parts of 20, 10 and 5 centavos. The bronze coins are of 2½, 2, 1, and ½ centavos.

The metric system of weights and measures is the legal standard in Chile, but the old Spanish standards are still widely used, especially in handling mining and farm produce. Nitrate of soda is estimated in Chilean quintals (101.41 lb) in the field, and metric quintals (220.46 lb) at the port of shipment. In silver and copper mining the *marc* (8 oz.) is commonly used in describing the richness of the ores. Farm produce is generally sold by the *arroba* or *fanega*; the *vara* is used in lineal measurement, and the *cuadra* is used by country people in land measurement. (A. J. L.)

HISTORY.

Chile was the recognized name of the country from the beginning of its known history. The land was originally inhabited by tribes of Indians, who, though not mere savages, were far below the level of civilization distinguishing the races of Mexico and Peru. When the country first became known to the Spaniards in the 16th century the northern tribes were found to be more civilized and much more submissive than those of the south. The difference was no doubt due to the invasion and conquest of northern Chile in the 15th century by

Yupanqui, Inca of Peru, grandfather of Atahualpa, ruler of Peru at the time of its conquest by Pizarro.

The dominion of the Incas in Chile was probably bounded by the Rapel river (lat. 34° 10' S.), and, though their control of the country was slight, the Peruvian influence led to the introduction of a higher civilization, and, by weakening the power of the tribes, paved the way for the invasion of the Spaniards. Beyond the limits of the Inca conquest the Indians of Chile were distinguished by fierce independence of character and by their warlike qualities. Rude and ignorant as they were, they possessed a rough military organization; each community was led by its *ulmen* (chief), and in war the tribes fought together under an elected leader (*toqui*). The name of the Araucanians, the most powerful of the tribes, came to be applied to the whole confederation of Indians living south of the Bio-bio river.

The first Spanish invasion of Chile took place in 1535, when Diego de Almagro, the companion and rival of Pizarro in the conquest of Peru, marched into Chile in search of gold. Disappointed in his quest, and meeting with obstinate *Spanish invasions.* resistance from the southern tribes, he returned to Peru with his whole force in 1538. In 1540 Pizarro sent Pedro de Valdivia to make a regular conquest and settlement of Chile. Valdivia founded Santiago, the present capital of Chile, in February 1541, and proceeded to build the towns of La Serena, Concepción, Villarica, Imperial, Valdivia and Angol, in order to secure his hold on the country. But the Indians fought desperately for their independence, and in 1553 a general rising of the tribes ended in the defeat and death of Valdivia and in the destruction of most of his settlements. This was the beginning of nearly a century of continuous warfare. As there was no gold in the country the number of settlers was small, the loose tribal organization of the natives made it impossible to inflict a vital defeat on them, and the mountainous and thickly wooded country lent itself admirably to a warfare of surprises and ambushes. General after general and army after army were despatched from Spain and Peru; Chile was given a government independent of the viceroy of Lima; attack after attack was made on the Indians, their lands were laid waste, and the struggle was conducted with merciless ferocity: all in vain. Settlements and forts were never free from assault and were taken and retaken; if one Indian army was destroyed another took its place, if one *toqui* was killed another was chosen; when defeated, the Indians retired to their forests, marshes and hills, recruited their forces, and fell on the pursuing Spaniards. In 1612 an attempt was made by a Jesuit missionary to negotiate a peace, but not till 1640 was the desperate struggle ended by the treaty of Quillin, which left the Indians all the land south of the Bio-bio river. Up to 1800 the peace was broken by three wars, in 1655, in 1723 and in 1766, the last ended by a treaty which actually gave the Araucanians the right to have a minister at Santiago.

It was this constant warfare with the Indians and the necessity for hard continuous work, owing to the lack of precious metals in Chile, that no doubt helped to produce in the settlers the strength and hardihood of character that distinguishes the Chilcans among South American races. But not unnaturally the material condition of the country was the reverse of prosperous. The expenditure far exceeded the revenue. The Indian warfare occupied nearly the whole attention of the governors and much of the time of the settlers. By the Spanish colonial system the development of manufactures was prohibited and the trade of the colony was limited not only to Spain but to the one port of Cadiz. Till the 18th century ships were not allowed to sail round Cape

Horn, so that the Chileans had to trade indirectly through Peru and the Argentine. Agriculture was the one resource of the colony, and wheat was grown for export to Peru, but the land was concentrated in the hands of a few big landowners, and the cultivation of the vine and olive was forbidden. At the end of the 17th century Santiago was a town of poor one-storeyed houses and had only 8000 inhabitants; the other towns, Valparaiso, Concepción, La Serena, were only large villages. Books were not allowed to be imported, and education was limited to such as was given here and there by priests and monks. The Indians within the limits of the Spanish colony were treated like slaves, and horribly mutilated to prevent their escape; but at the same time a gradual fusion of races was taking place, and the Chilean peasant (*peon*) of to-day is as much of Indian as of Spanish descent. The Araucanians, however, continued to preserve their independence; they jealously resented the introduction of Spanish influence, and the missionary efforts of the Jesuits met with little success.

During the 18th century the condition of the colony was improved in many ways. The Bourbon kings of Spain were more liberal in their colonial policy. Merchant-ships were allowed to sail direct to Chile, trade with France was sometimes permitted, and a large batch of hardy emigrants was sent out

from the Biscay provinces of Spain. Freed from the preoccupation of the Indian wars, the governors gave more attention to the general welfare of the country: a university was started in Santiago in 1747, many towns were built about the same time, agriculture and industries were promoted and a coasting trade grew up. In 1778 Charles III. threw open all the ports of Spain to the colonies and allowed freedom of trade with France. But in general the administration of the colony was burdensome, oppressive and inefficient. The people had no voice in the government. Ruling with the help of the Royal Audience, the governor was absolute master of the country, and regulated the smallest details of life. Such time as the officials could spare from the main object of enriching themselves by extortion and corruption was given up to endless official and religious ceremonies and to petty disputes of etiquette and precedence. All the high posts and offices were filled by men sent from Spain, with the result that bitter jealousy reigned between them and the native-born colonists (*criollos*). The *criollos* as a rule filled the posts in the municipalities (*cabildos*), disposed of by sale, so that when the revolution broke out the *cabildos* naturally became the centres of the movement. As in all Spanish colonies, so in Chile, the Church played a large part in the public life. Chile was divided into the two bishoprics of Santiago and Concepción, and the Church managed to accumulate most of the wealth of the country. At the same time the monks and Jesuits did useful work in teaching industrial and agricultural arts, and in giving the people a certain degree of education; but the influence of the Church was used to bolster up the traditional narrow colonial system, and the constant quarrels between the clergy and the secular powers often threw the country into confusion.

At the opening of the 19th century Chile was a colony whose resources had hardly been touched, with a population of about 500,000 persons, of Spanish and mixed Spanish and Indian blood: a people endowed with the vigour of character bred by a mountainous country and a bracing climate and by a hard struggle for existence, but ignorant through lack of education, shut out by a narrow-minded commercial system from knowledge of the outside world, and destitute of the character-training that free institutions afford.

The national independence of Chile dates from the second decade of the 19th century. The revolt of England's North American colonies, and the events of the French

Revolution naturally suggested the idea of a struggle for independence to the Spanish colonists, and the deposition of Ferdinand VII. by Napoleon, and the ensuing disorganization of Spain, supplied the desired opportunity. In 1809 risings took place in Venezuela, in Ecuador, in Upper Peru and in the Argentine; the revolutionary fever spread to Chile, and on the 18th of September 1810 the *cabildo* of Santiago secured the resignation of the governor and vested his powers in an elected *Junta* (board) of seven members. This event was the beginning of the independence of Chile. But it was some time before independence was fully attained. The mass of the people were ignorant, intercourse between them was slight, and there was a strong section attached to the old régime. The party determined on independence was at first small, and compelled to conceal its aims till the ground had been prepared for open decisive action. Further, there were divisions between the patriots of Santiago and those of Concepción, and bitter jealousies between the leaders, the chief of whom were Juan Martínez de Rozas, José Miguel Carrera and Bernardo O'Higgins. Owing to the apathy of the people and the enmities existing among the leaders, the Spanish forces, sent by the viceroy of Peru to crush the revolutionary movement, succeeded after two years' indecisive fighting in completely defeating the patriots at Rancagua in 1814. For three years the Spaniards maintained their hold on Chile, ruling the country with tyrannical harshness, but in the spring of 1817 a patriot force which had been organized at Mendoza in the Argentine by José de San Martín, an Argentine officer, and by O'Higgins, crossed the Andes and overwhelmed the royalists at the battle of Chacabuco. O'Higgins was named director-general of Chile, while San Martín, realizing that the

independence of each colony depended on the Spanish being expelled from the whole of South America, set about preparing an invasion of Peru. The viceroy of Lima made one more effort to uphold the power of Spain in Chile, but the army he despatched under Mariano Osorio, the victor of Rancagua, was decisively defeated at the river Maipo on the 3rd of April 1818. By this battle the independence of Chile, formally proclaimed by O'Higgins in the previous February, was finally secured.

The next few years witnessed the expulsion of the royalists from the south of Chile, the equipment of a small fleet, placed under the command of Manuel Blanco Encalada and Lord Cochrane (earl of Dundonald), and the invasion of Peru by San Martín with the help of the fleet, ending in the proclamation of Peruvian independence in 1821; though the Spanish power was not finally broken until Bolívar's victory at Ayacucho in 1824. Relieved from all fear of Spanish attacks from the north, the new republic of Chile entered upon a period of internal confusion and dissension bordering upon anarchy. As soon as the necessity for establishing a stable government arose the lack of training in self-government among the Chilcans became painfully obvious. O'Higgins as director-general, rightly perhaps, considered that firm orderly government was more important than the concession of liberal institutions, but his administration roused strong hostility, and in 1823 he was compelled to resign. From that date up to 1830 there were no less than ten governments, while three different constitutions were proclaimed. The nation was divided into small mutually hostile parties; there were ecclesiastical troubles owing to the hostility of the Church to the new republic; there were Indian risings in the south and royalist revolts in the island of Chiloé; the expenditure exceeded the revenue, and the employment of the old Spanish financial expedients naturally increased the general discontent. Up to 1830 the Liberal party, which favoured a free democratic régime, held the upper hand, but in that year the Conservatives, backed by a military rising led by General Joaquín Prieto, placed themselves in power after a sanguinary battle at Lircay. Prieto was elected president in 1831, and a new constitution was drafted and promulgated in 1833, which, with some modifications, remains the constitution of Chile at the present time. This constitution invested the executive with almost dictatorial powers, and the Conservatives entered upon a long term of office.

The aim of the Conservative policy was to secure above all a strong administration; power was concentrated in the hands of a small circle; public liberties were restricted and all opposition crushed by force. Inaugurated under General Prieto's administration (1831-1841) by his able minister Diego Portales, this policy was continued by his successors General Manuel Bulnes (1841-1851) and Manuel Montt (1851-1861), each of whom like Prieto was elected to a double term of office. In spite of the discontent of the Liberals, the Conservative ascendancy secured a long period of firm stable government, which was essential to put an end to the confusion in public life and to give time for the people to awake to a fuller realization of the duties and responsibilities of national independence. The internal peace of the country was only disturbed three times, by Liberal risings in 1835, in 1851 and in 1859, all of which were crushed, but not without severe fighting. In 1836 Chile also became involved in a war with a confederation of Peru and Bolivia, which ended in the victory of Chile and the dissolution of the confederation.

While refusing to allow the people any share in, or control over, the government, the Conservative leaders devoted themselves to improving the condition of the people and of the country, and under their firm rule Chile advanced rapidly in prosperity. The government established a department for education, a training college for teachers, and numerous schools and libraries; literary magazines were started and a school of art and an academy of music founded. By the consolidation of the foreign debt, by the regular payment of interest, by the establishment of several banks, and by the negotiation of commercial treaties, the financial position of the country was improved. Internal development was promoted by the working

of the silver mines of Copiápo and the coal mines of Lota, by the building of railways and erection of telegraphs, and by the colonization of the rich Valdivia province with German settlers.

The Straits of Magellan were occupied; under an American engineer, William Wheelwright, a line of steamers was started on the coast, and, by a wise measure allowing merchandise to be landed free of duty for re-exportation, Valparaíso became a busy port and trading centre; while the demand for food-stuffs in California and Australia, following upon the rush for gold, gave a strong impetus to agriculture. A code of law was drawn up and promulgated, and the ecclesiastical system was organized under an archbishop appointed by the pope. To Montt, as minister under Bulnes and afterwards as president, must be given the main credit for the far-seeing policy which laid the foundations of the prosperity of Chile; and though the administration was in many ways harsh and narrow, firm government, rather than liberty that would have tended to anarchy, was essential for the success of the young republic.

After 1861, however, a Liberal reaction set in, aided by divisions in the Conservative party arising mainly over church questions. Montt's successors, José Joaquín Pérez (1861-1871), Federico Errázuriz (1871-1876) and Aníbal Pinto (1876-1881), abandoned the repressive policy of their predecessors, invited the co-operation of the Liberals, and allowed discontent to vent itself freely in popular agitation. Some democratic changes were made in the constitution, notably a law forbidding the re-election of a president, and the gradual and peaceful transition to a Liberal policy was a proof of the progress which the nation had made in political training. Outside the movement for constitutional reform, the most important internal question was the successful Liberal attack on the privileged position and narrow views of the Church, which led to the birth of a strong ultramontane party among the clergy. The government continued to be animated by a progressive spirit: schools, railways, telegraphs were rapidly extended; a steamship mail service to Europe was subsidized, and the stability of the government enabled it to raise new foreign loans in order to extinguish the old high interest-bearing loans and to meet the expenses of public works. In 1877 a financial crisis occurred, met by the emission of paper money, but the depression was only temporary, and the country soon rallied from the effects.

During this period there was desultory fighting with the Indians; there was a long boundary dispute with the Argentine, settled in 1880; and in 1865 Chilean sympathy with Peru in a quarrel with Spain led to a foolish war with Spain. The blockade of their ports and the bombardment of Valparaíso by a Spanish squadron impressed the Chileans with the necessity of possessing an adequate fleet to defend their long coast-line; and it was under President Errázuriz that the ships were obtained and the officers trained that did such good service in the great war with Peru. With a population of over two millions, a rapidly increasing revenue, ruled by a government that was firm and progressive and that enjoyed the confidence of all classes, Chile was well equipped for the struggle with Peru that began in 1879.

The war of 1879-82 between Chile and Peru is the subject of a separate article (see CHILE-PERUVIAN WAR). By the

beginning of 1881 the war had reached a stage when the final struggle was close at hand. On the 13th of January of that year the Chilean forces under command of General Baquedano attacked the entrenched positions of the Peruvians at daybreak in the vicinity of Chorillos, a village some few miles from Lima, and forming the outer line of defence for the capital. After a stubborn fight the day ended in victory for the attacking forces; but the losses on both sides were great, and on the following day negotiations for peace were attempted by the representatives of the foreign powers in Lima, the object being to avoid, if possible, any further bloodshed. This attempt to end the conflict proved, however, abortive, and on the 15th of January at 2 P.M. hostilities recommenced in the neighbourhood of Miraflores. After severe fighting for some four hours the Chileans again proved victorious, and drove the Peruvians from the second line of defence back upon the city of

Lima. Lima was now at the mercy of the Chileans, and on the 17th of January a division of 4000 men of all arms, under the command of General Cornelio Saavedra, was sent forward to occupy the Peruvian capital and restore order within the town limits. A portion of the Chilean forces was shortly afterwards withdrawn from Peru, and the army of occupation remaining in the conquered country was in charge of Admiral Patricio Lynch, an officer who had been specially promoted for distinguished services during the war. President Aníbal Pinto of Chile now set about to find means to conclude a treaty of peace with Peru, but his efforts in this direction were frustrated by the armed resistance offered in the country districts to the Chilean authorities by the remainder of the Peruvian forces under command of General Cáceres. So matters continued—the Chileans administering on the seaboard and in the principal towns, the Peruvians maintaining a guerilla warfare in the mountainous districts of the interior. In September 1881 the term of office of president Pinto expired, and he was succeeded in the post of chief executive of Chile by President Domingo Santa María. Ex-President Pinto died three years later in Valparaíso, leaving a memory respected and admired by all political parties in his country. The name of Pinto will always occupy a prominent place in the annals of Chilean history, not only because the war with Peru took place during his term of office, but also on account of the fact that it was largely due to the intelligent direction of all details by the president during the struggle that the Chilean arms proved so absolutely successful by land and sea.

Señor Domingo Santa María, who now acceded to the presidency of Chile, was a Liberal in politics, and had previously held various important posts under the government.

Under the rule of President Montt he had been an active member of the opposition and involved in various revolutionary conspiracies; for his participation in these plots he was at one time exiled from the country, but returned and received official employment under President Pérez. The principal task confronting President Santa María on assuming the presidency was to negotiate a treaty of peace with Peru and provide for the evacuation of the Chilean army of occupation. The presence of the Peruvian general Cáceres and his forces in the interior of Peru prevented for some two years the formation of any Peruvian national administration in Lima with which the Chilean authorities could deal. In August of 1883 the Peruvians were defeated by the forces commanded by Admiral Lynch, and a government was then organized under the leadership of General Iglesias. A provisional treaty of peace was then drawn up and signed by General Iglesias and the Chilean representative, and this was finally ratified by the Chilean and Peruvian congresses respectively in April 1884. By the terms of this treaty Peru ceded to Chile unconditionally the province of Tarapacá, and the provinces of Tacna and Arica were placed under Chilean authority for the term of ten years, the inhabitants having then to decide by a general vote whether they remained a part of Chile or elected to belong once more to Peru. In the event of the decision being favourable to Peru a sum of 10,000,000 dollars was to be paid by Peru to Chile. On the ratification of this treaty the Chilean forces were immediately withdrawn from Lima and other points of occupation in Peruvian territory. The government of Bolivia also attempted to negotiate a treaty of peace with Chile in 1884, and for this purpose sent representatives to Santiago. No satisfactory terms, however, could be arranged, and the negotiations ended in only an armistice being agreed to, by which Chile remained in occupation of the Bolivian seaboard pending a definite settlement at some future period.

The administration of President Santa María met with violent opposition from the Conservatives, who included the Clerical party in their ranks, and also from a certain section of the Liberals. The dislike of the Conservatives to President Santa María was occasioned by his introduction of the law of civil marriage, the civil registration of births and deaths, and the freeing of the cemeteries. Hitherto no marriage was legal unless celebrated

*President
Santa
María.*

according to the rites of the Roman Catholic religion, and all registers of births and deaths were kept by the parish priests. Civil employees were now appointed under the new laws to attend to this work. Formerly the cemeteries were entirely under the control of the Church, and, with the exception of a few places specially created for the purpose, were reserved solely for the burial of Roman Catholics. Under the new régime these cemeteries were made common to the dead of all religions. Under President Perez, in 1865, a clause in the law of constitution had been introduced permitting the exercise of all creeds of religion, and this was now put into practice, all restrictions being removed. On several occasions, notably in 1882 and 1885, President Santa Maria used his influence in the elections of senators and deputies to congress for the purpose of creating a substantial majority in his favour. He was induced to take this course in consequence of the violent opposition raised in the chambers by the liberal policy he pursued in connexion with Church matters. This intervention caused great irritation amongst the Conservatives and dissentient Liberals, and the political situation on more than one occasion became so strained as to bring the country to the verge of armed revolution. No outbreak, however, took place, and in 1886 the five years of office for which President Santa Maria had been elected came to an end, and another Liberal, Señor José Manuel Balmaceda, then succeeded to power.

The election of Balmaceda was bitterly opposed by the Conservatives and dissentient Liberals, but was finally successfully carried by the official influence exercised by President Santa Maria. On assuming office President Balmaceda endeavoured to bring about a reconciliation of all sections of the Liberal party in congress and so form a solid majority to support the administration, and to this end he nominated as ministers representatives of the different political groups. Six months later the cabinet was reorganized, and two most bitter opponents to the recent election of President Balmaceda were accorded portfolios. Believing that he had now secured the support of the majority in congress on behalf of any measures he decided to put forward, the new president initiated a policy of heavy expenditure on public works, the building of schools, and the strengthening of the naval and military forces of the republic. Contracts were given out to the value of £6,000,000 for the construction of railways in the southern districts; some 10,000,000 dollars were expended in the erection of schools and colleges; three cruisers and two sea-going torpedo boats were added to the squadron; the construction of the naval port at Talcahuano was actively pushed forward; new armament was purchased for the infantry and artillery branches of the army, and heavy guns were acquired for the purpose of permanently and strongly fortifying the neighbourhoods of Valparaiso, Talcahuano and Iquique. In itself this policy was not unreasonable, and in many ways extremely beneficial for the country. Unfortunately corruption crept into the expenditure of the large sums necessary to carry out this programme. Contracts were given by favour and not by merit, and the progress made in the construction of the new public works was far from satisfactory. The opposition in congress to President Balmaceda began to increase rapidly towards the close of 1887, and further gained ground in 1888. In order to ensure a majority favourable to his views, the president threw the whole weight of his official influence into the elections for senators and deputies in 1888; but many of the members returned to the chambers through this official influence joined the opposition shortly after taking their seats. In 1889 congress became distinctly hostile to the administration of President Balmaceda, and the political situation became grave, and at times threatened to involve the country in civil war. According to usage and custom in Chile, a ministry does not remain in office unless supported by a majority in the chambers. Balmaceda now found himself in the impossible position of being unable to appoint any ministry that could control a majority in the senate and chamber of deputies and at the same time be in accordance with his own views of the administration of public

affairs. At this juncture the president assumed that the constitution gave him the power of nominating and maintaining in office any ministers he might consider fitting persons for the purpose, and that congress had no right of interference in the matter. The chambers were now only waiting for a suitable opportunity to assert their authority. In 1890 it was stated that President Balmaceda had determined to nominate and cause to be elected as his successor at the expiration of his term of office in 1891 one of his own personal friends. This question of the election of another president brought matters to a head, and congress refused to vote supplies to carry on the government. To avoid trouble Balmaceda entered into a compromise with congress, and agreed to nominate a ministry to their liking on condition that the supplies for 1890 were voted. This cabinet, however, was of short duration, and resigned when the ministers understood the full amount of friction between the president and congress. Balmaceda then nominated a ministry not in accord with the views of congress under Señor Claudio Vicuña, whom it was no secret that Balmaceda intended to be his successor in the presidential chair, and, to prevent any expression of opinion upon his conduct in the matter, he refrained from summoning an extraordinary session of the legislature for the discussion of the estimates of revenue and expenditure for 1891. When the 1st of January 1891 arrived, the president published a decree in the *Diario Oficial* to the effect that the budget of 1890 would be considered the official budget for 1891. This act was illegal and beyond the attributes of the executive power. As a protest against the action of President Balmaceda, the vice-president of the senate, Señor Waldo Silva, and the president of the chamber of deputies, Señor Ramon Barros Luco, issued a proclamation appointing Captain Jorje Montt in command of the squadron, and stating that the navy could not recognize the authority of Balmaceda so long as he did not administer public affairs in accordance with the constitutional law of Chile. The majority of the members of the chambers sided with this movement, and on the 7th of January Señores Waldo Silva, Barros Luco and a number of senators and deputies embarked on board the Chilean warship "Blanco Encalada," accompanied by the "Esmeralda," and "O'Higgins" and other vessels, sailing out of Valparaiso harbour and proceeding northwards to Tarapaca to organize armed resistance against the president (see CHILEAN CIVIL WAR). It was not alone this action of Balmaceda in connexion with congress that brought about the revolution. He had alienated the sympathy of the aristocratic classes of Chile by his personal vanity and ambition. The oligarchy composed of the great landowners have always been an important factor in the political life of the republic; when President Balmaceda found that he was not a *persona grata* to this circle he determined to endeavour to govern without their support, and to bring into the administration a set of men who had no traditions and with whom his personality would be all-powerful. The Clerical influence was also thrown against him in consequence of his radical ideas in respect of Church matters.

Immediately on the outbreak of the revolution President Balmaceda published a decree declaring Montt and his companions to be traitors, and without delay organized an army of some 40,000 men for the suppression of the insurrectionary movement. While both sides were preparing for extremities, Balmaceda administered the government under dictatorial powers with a congress of his own nomination. In June 1891 he ordered the presidential election to be held, and Señor Claudio Vicuña was duly declared chosen as president of the republic for the term commencing in September 1891. The resources of Balmaceda were running short on account of the heavy military expenses, and he determined to dispose of the reserve of silver bullion accumulated in the vaults of the Casa de Moneda in accordance with the terms of the law for the conversion of the note issue. The silver was conveyed abroad in a British man-of-war, and disposed of partly for the purchase of a fast steamer to be fitted as an auxiliary cruiser and partly in payment for other kinds of war material.

Revolution
of 1891.

Balmaceda
elected
president.

The organization of the revolutionary forces went on slowly. Much difficulty was experienced in obtaining the necessary arms and ammunition. A supply of rifles was bought in the United States, and embarked on board the "Itata," a Chilean vessel in the service of the rebels. The United States authorities refused to allow this steamer to leave San Diego, and a guard was stationed on the ship. The "Itata," however, slipped away and made for the Chilean coast, carrying with her the representatives of the United States. A fast cruiser was immediately sent in pursuit, but only succeeded in overhauling the rebel ship after she was at her destination. The "Itata" was then forced to return to San Diego without landing her cargo for the insurgents. The necessary arms and ammunition were arranged for in Europe; they were shipped in a British vessel, and transferred to a Chilean steamer at Fortune Bay, in Tierra del Fuego, close to the Straits of Magellan and the Falkland Islands, and thence carried to Iquique, where they were safely disembarked early in July 1891. A force of 10,000 men was now raised by the *junta* of the revolution, and preparations were rapidly pushed forward for a move to the south with the object of attacking Valparaiso and Santiago. Early in April a portion of the revolutionary squadron, comprising the "Blanco Encalada" and other ships, was sent to the southward for reconnoitring purposes and put into the port of Caldera. During the night of the 23rd of April, and whilst the "Blanco Encalada" was lying quietly at anchor, a torpedo boat called the "Almirante Lynch," belonging to the Balmaceda faction, steamed into the bay of Caldera and discharged a torpedo at the rebel ship. The "Blanco Encalada" sank in a few minutes and 300 of her crew perished.

In the middle of August 1891 the rebel forces were embarked at Iquique (where a provisional government under Captain Jorje Montt had been set up), numbering in all about 9000 men, and sailed for the south. On the 20th of August the congressist army was disembarked at Quinteros, about 20 m. north of Valparaiso, and marched to Concon, where the Balmacedists were entrenched. A severe fight ensued, in which the troops of President Balmaceda were defeated with heavy loss. This reverse roused the worst passions of the president, and he ordered the arrest and imprisonment of all persons suspected of sympathy with the revolutionary cause. The population generally were, however, distinctly antagonistic to Balmaceda; and this feeling had become accentuated since the 17th of August 1891, on which date he had ordered the execution of a number of youths belonging to the military college at San Lorenzo on a charge of seditious practices. The shooting of these boys created a feeling of horror throughout the country, and a sensation of uncertainty as to what measures of severity might not be practised in the future if Balmaceda won the day. After the victory at Concon the insurgent army, under command of General Campos, marched in a southerly direction towards Viña del Mar, and thence to Placilla, where the final struggle in the conflict took place. Balmaceda's generals Barbosa and Alcérria had here massed their troops in a strong position. The battle, on the 28th of August, resulted in victory for the rebels. Both the Balmacedist generals were killed and Valparaiso was at once occupied.

Defeat and suicide of Balmaceda. Three days later the victorious insurgents entered Santiago and assumed the government of the republic. After the battle of Placilla it was clear to President Balmaceda that he could no longer hope to find a sufficient strength amongst his adherents to maintain himself in power, and in view of the rapid approach of the rebel army he abandoned his official duties to seek an asylum in the Argentine legation. The president remained concealed in this retreat until the 18th of September. On the evening of that date, when the term for which he had been elected president of the republic terminated, he committed suicide by shooting himself. The excuse for this act, put forward in letters written shortly before his end, was that he did not believe the conquerors would give him an impartial trial. The death of Balmaceda finished all cause of contention in Chile, and was the closing act of the most severe and bloodiest struggle that country had ever witnessed. In the various engagements throughout the conflict more than

10,000 lives were lost, and the joint expenditure of the two governments on military preparations and the purchase of war material exceeded £10,000,000 sterling.

An unfortunate occurrence soon after the close of the revolution brought strained relations for a short period between the governments of the United States and Chile. A number of men of the U.S.S. "Baltimore" having been given liberty on shore, an argument arose between some of them and a group of Chilean sailors in a drinking den in Valparaiso. Words led to blows. The Americans were badly handled, one of their number being killed and others severely hurt. The United States government characterized the affair as an outrage, demanding an indemnity as satisfaction. The Chilean authorities demurred at this attitude, and attempted to argue the matter. James G. Blaine, then secretary of state, refused peremptorily to listen to any explanations. In the end Chile paid an indemnity of \$75,000 as asked, but the affair left bad feeling in its train.

The close of the revolution against Balmaceda left the government of Chile in the hands of the *junta* under whose guidance the military and naval operations had been organized. Admiral Jorje Montt had been the head of this revolutionary committee, and he acted as president of the provisional government when the administration of the country changed hands after the victory of the Congressional party. An election was now immediately ordered for the choice of a president of the republic and for representatives in the senate and chamber of deputies. Admiral Montt, as head of the executive power, stanchly refused to allow official influence to be brought to bear in any way in the presidential campaign. The great majority of the voters, however, required no pressure to decide who was in their opinion the man most fitted to administer the affairs of the republic. For the first time in the history of Chile a perfectly free election was held, and Admiral Montt was duly chosen by a nearly unanimous vote to be chief magistrate for the constitutional term of five years. The senate and chamber of deputies were formally constituted in due course, and the government of the republic resumed normal conditions of existence. The new president showed admirable tact in dealing with the difficult problem he was called upon to face. Party feeling still ran high between the partisans of the two sides of the recent conflict. Admiral Montt took the view that it was politic and just to let bygones be bygones, and he acted conscientiously by this principle in all administrative measures in connexion with the supporters of the late President Balmaceda. Early in 1892 an amnesty was granted to the officers of the Balmaceda régime, and they were freely permitted to return to Chile without any attempt being made to molest them. The first political act of national importance of the new government was the grant of control to the municipalities, which hitherto had possessed little power to direct local affairs, and were not even permitted to dispose of the municipal revenues to any important amount without first obtaining the consent of the central government. Almost absolute power was now given these corporations to manage their own concerns, and the organization of the police was placed in their hands; at a later period, however, it was found necessary to modify this latter condition.

President Montt next turned his attention towards the question of how best to repair the damage occasioned to the country by eight months of civil warfare. The plan of public works authorized in 1887 was reconsidered, and the construction of portions of the various undertakings recommenced. The army and navy were reorganized. Additional instructors were brought from Germany, and all arms of the military service were placed on a thoroughly efficient footing in matters of drill and discipline. Several new and powerful cruisers were added to the navy, and the internal economy of this branch of the national defence was thoroughly inspected and many defects were remedied. President Montt then took in hand the question of a reform of the currency, the abolition of inconvertible paper money, and the re-establishment of a gold basis as the monetary standard of the republic. This reform of the currency became the keynote of the president's policy during the remainder of

*President
Jorje
Montt.*

his term of office. Great opposition was raised by the representatives of the debtor class in congress to the suppression of the inconvertible paper money, but in the end President Montt carried the day, and on the 11th of February 1895 a measure finally became law establishing a gold currency as the only legal tender in Chile. In July 1896 the Conversion Act was put in force, a dollar of 18d. being the monetary unit adopted. In 1895 relations with the neighbouring republic of Argentina began to become somewhat strained in regard to the interpretation of the treaty concerning the boundary between the two countries. The treaties of 1881, 1893 and 1895 left doubts in the minds of both Chileans and Argentines as to the position of the frontier line. On the 17th of April 1896 another protocol was drawn up, by which the contending parties agreed to submit any differences to the arbitration of Great Britain, at the instance of one or both governments. President Montt had now fulfilled his term of office, and on the 18th of September 1896 he handed over the presidential power to his successor, Señor Federico Errázuriz, who had been duly elected in the month of June previously.

The election for the position of president of the republic was closely contested in 1896 between Señor Errázuriz and Señor Reyes, and ended in the triumph of the former candidate by the narrow majority of one vote. The father of the new president had been chief magistrate of

President Errázuriz.

Chile from 1871 to 1876, and his administration had been one of the best the country had ever enjoyed; his son had therefore traditions to uphold in the post he was now called upon to fill. At the beginning of 1897 the public attention was absorbed by foreign political questions. The problems to be solved were the frontier difficulty with Argentina, the question of the possession of Tacna and Arica with Peru, and the necessity of fulfilling the obligation contracted with Bolivia to give that country a seaport on the Pacific coast. The treaty made in 1896 with the Argentine government, referring to the arbitration of disputed points concerning the boundary, became practically for the moment a dead letter, and both Argentines and Chileans began to talk openly of an appeal to arms to settle the matter once for all. The governments of both countries began to purchase large supplies of war material, and generally to make preparations for a possible conflict. In these circumstances no final settlement with Peru and Bolivia was possible, the authorities of those republics holding back to see the issue of the Chile-Argentine dispute, and Chile being in no position at the time to insist on any terms being arranged. So matters drifted until the beginning of 1898. In July of that year the crisis reached an acute stage. Both Chile and Argentina put forward certain pretensions to territory in the Atacama district to the north, and also to a section of Patagonia in the south. Neither side would give way, nor was any disposition exhibited to refer the matter to arbitration under the protocol of 1896. The cry of an acute financial crisis emanating from the fear of war with Argentina was now raised in Chile. The president was advised that the only way of averting the financial ruin of the banking institutions of the republic was to suspend the conversion law and lend from the national treasury inconvertible notes to the banks. Señor Errázuriz weakly gave

Crisis with Argentina.

way, and a decree was promulgated placing the currency once more on an inconvertible paper money basis until 1902. In August of 1898 the Chilean government determined to insist upon the terms of the protocol of 1896 being acted upon, and intimated to Argentina that they demanded the fulfilment of the clause relating to arbitration on disputed points. This was practically an ultimatum, and a refusal on the part of the Argentine government to comply with the terms of the 1896 agreement meant a declaration of war by Chile. For a few days the issue hung in the balance, and then the Argentine government accepted the provisions made in 1896 for arbitration. The dispute concerning the Atacama district was submitted to an arbitration tribunal, consisting of the representative of the United States in Argentina, assisted by one Argentine and one Chilean commissioner. This tribunal, after due investigation, gave their decision in April

1899, and the verdict was accepted unreservedly by both governments. The dispute regarding the Patagonian territory was submitted to the arbitration of Great Britain, and a commission—consisting of Lord Macnaghten, Sir John Ardagh and Sir T. H. Holdich—was appointed in 1899 to hear the case.

The Argentine difficulty was ended, but Chile still had to find a settlement with Peru and Bolivia. The treaty made with the former country in 1893 was not ratified, as it was thought to concede too much to Peru, and the subsequent *ad referendum* treaty was rejected on account of Peru claiming that only Peruvians, and not all residents, should have the right to vote in the plebiscite to be taken by the terms of the treaty of 1883 for the possession of Tacna and Arica. By the terms of the armistice of 1883 between Chile and Bolivia, a three years' notice had to be given by either government wishing to denounce that agreement. By the protocol of 1895 Chile agreed to give to Bolivia the port of Arica, or some other suitable position on the seaboard. On these lines a settlement was proposed. Vitor, a landing-place a little to the south of Arica, was offered by the Chilean government to Bolivia, but refused as not complying with the conditions stated in the protocol of 1895; the Bolivians furthermore preferred to wait and see if Arica was finally ceded by Peru to Chile, and if so to claim the fulfilment of the terms of the protocol.

After the accession to office of President Errázuriz there was no stability of any ministry. Political parties in congress were so evenly balanced and so subdivided into groups that a vote against the ministry was easy to obtain, and the resignation of the cabinet immediately followed in accordance with the so-called parliamentary system in vogue in Chile. The president of the republic has no power to dissolve the chambers, to endeavour to remedy the evil by one or another political party obtaining a substantial working majority, but must wait to see the results of the triennial elections. As a consequence of these conditions Conservative, Liberal and coalition ministries held office at short intervals. These unsettled political circumstances checked any continuity of policy, and tended to block the passage of all useful legislation to help forward the economic development of the country and inhabitants; on the other hand, the financial situation was better by the end of 1899 than in the previous year, since all proposals for a fresh paper issue had been vetoed; and the elections for congress and municipal office at the opening of 1900 returned a majority favourable to a stable currency policy.

In September 1900 a fresh outburst of hostile feeling against Chile was created in Argentina by a note addressed by the Chilean government to Bolivia, intimating that Chile was no longer inclined to hand over the port of Arica or any other port on the Pacific, but considered the time ripe for a final settlement of the questions connected with the Chilean occupation of Bolivian territory, which had now been outstanding for sixteen years. The foreign policy of Chile, as indicated by this note, was considered by Argentina to be grasping and unconciliatory, and there were rumours of an anti-Chilean South American federation. Chile disclaimed any aggressive intentions; but in December the Bolivian congress declined to relinquish their claim to a port, and refused to conclude a definite treaty of peace. The year closed with a frontier incident between Chile and Argentina in the disputed territory of Ultima Esperanza, where some Argentine colonists were ejected by Chilean police; but both governments signed protocols agreeing not to take aggressive action in consequence.

At the opening of 1901 the country was chiefly interested in the forthcoming presidential election, for which the candidates were Don Pedro Montt (Conservative and Clerical) and Señor German Riesco (Liberal). The relations between President Errázuriz and congress became rather strained, owing to the former's inclination to retain in office a ministry on which congress had passed a vote of censure; but Errázuriz had been in ill-health for more than a year, and on the 1st of May he resigned, and died in July. At the ensuing election Riesco was elected president. The attitude of Chile

President Riesco.

towards the Pan-American Congress at Mexico became a matter of interest in the autumn, particularly in connexion with the proposal for compulsory arbitration between all American governments. The Chilean government made it quite clear that they would withdraw from the congress if this proposal was meant to be retroactive; and their unyielding attitude testified to the apprehensions felt by Chile concerning United States interference. In October the Chilean government announced that the contemplated conversion scheme, for which gold had been accumulated, would be postponed for two years (till October 1903), the gold being held as a reserve fund pending the result of the arbitration over the Argentine frontier. This was generally considered to be a reasonable and statesmanlike course. Unfortunately, a recrudescence of the excitement over the boundary dispute was occasioned by the irritation created in Argentina by the fact that, pending a decision, Chile was constructing roads in the disputed territory. During December 1901 relations were exceedingly strained, and troops were called out on both sides. But at the end of the month it was agreed to leave the question to the British arbitrators, and the latter decided to send one of their number, Sir T. H. Holdich, to examine the territory.

The survey occupied some eight months, and it was not until the autumn that Sir T. H. Holdich returned to England to make

**Argentine
boundary
award.**

his report. The difficulty of ascertaining the true line of the watershed had been very great, but the result was eminently successful. The award of King Edward was signed on the 20th of November 1902, and both parties to the litigation were satisfied. In order that future disputes might be amicably settled, a treaty was signed by which it was agreed that any question that might arise should be submitted to the arbitration of Great Britain or in default of that power to the Swiss Confederation. The removal of this source of irritation and the restoration of friendly relations between the two republics was a great relief to the finance of Chile. Had it not been for the political instability of the country, the effects of the diminution of expenditure on military and naval preparations would have effected a rapid improvement in its financial position. The constant change of ministry (there being no stable majority in the congress) prevented during 1903 any settled policy, or that confidence in the government which is the basis of commercial prosperity. In 1904, however, both trade and revenue showed signs of improvement, and the sale of the warships "Esmeralda" and "Chambuco" for £1,000,000 furnished a surplus, which was devoted to the improvement of the port of Valparaiso. This was the beginning of a period of steady industrial growth and development. The settlement of the long outstanding dispute with Bolivia in a treaty of peace signed on the 17th of October 1905 was very advantageous to both countries. By this treaty Bolivia ceded all claims to a seaport and strip of the coast, on condition that Chile constructed at her own charges a railway to Lapaz from the port of Arica, giving at the same time to Bolivia free transit across Chilean territory to the sea. A cash indemnity of £300,000 was also paid, and certain stipulations were made with regard to the construction of other railways giving access from Chile to the Bolivian interior.

The prosperity of Chile was to suffer a rude shock. On the 17th of August 1906 a terrible earthquake visited Valparaiso and the surrounding district. The town of Valparaiso was almost entirely destroyed, while Santiago and other towns were severely shaken and suffered much damage. It was estimated that about 3000 persons were killed, a still larger number injured, and at least 100,000 rendered homeless. The loss of property was enormous. The fire which broke out after the earthquake shock had subsided added to the horror of the catastrophe. Measures were, however, promptly taken for succouring the people, who had been driven from their homes, and the task of restoration was vigorously taken in hand. Before the end of the year the rebuilding of the city was rapidly progressing.

In 1906 Señor Pedro Montt was elected president and entered upon his office on the 17th of September. The personality of

the president, however, had become of much less importance in modern Chile than in earlier days. Up to 1870 the government was in the hands of a small oligarchy of Santiago families, but the president enjoyed large powers of initiative. Nowadays the congress has virtually absorbed the executive power, with the result that the cabinet is often changed many times in one year. This prevents indeed any continuity of policy, for the majority in congress is perpetually fluctuating, and ministerial crises rapidly follow one another. Chile, however, except in the Balmacedist civil war, is happily distinguished by its freedom from revolution and serious political unrest. Its history in this respect is in marked contrast to that of the neighbouring South American states. The completion of the Trans-Andean railway between Valparaiso and Buenos Aires was bound to be of immense commercial and industrial value; and eventually the making of a longitudinal railway route uniting the nitrate province of the north with Santiago, and Santiago with Puerto Montt in the distant south, opened up further important prospects. Such a line of through communication, binding together the different provinces forming the long narrow strip of territory stretching along more than 2000 m. of the Pacific littoral, could only be looked forward to, both politically and economically, as an inestimable benefit to the country.

**President
Pedro
Montt.**

BIBLIOGRAPHY.—*General History.*—The most valuable authority is D. Barros Arana's *Historia jeneral de Chile* (15 vols., Santiago, 1884), from the earliest days up to 1830. Smaller handbooks covering the whole period are: A. U. Hancock, a *History of Chile* (Chicago, 1893), the only general history in English, and containing a bibliography; Gaspar Toro, *Compendio de la historia de Chile* (Santiago, 1879), a good clear abstract of Chilean history; and F. Valdes Vergara, *Historia de Chile* (Valparaiso, 1898), written primarily for schools, but containing useful sketches of leading figures in Chilean history.

Works on Special Periods.—Colonial Period: M. L. Amunátequi, *Descubri miento y conquista de Chile* (Santiago, 1885), a valuable detailed account of the Spanish conquest; by same author, *Los Precursores de la independencia de Chile* (Santiago, 1870), a clear useful description of the evils of the Spanish colonial system; Horacio Lara, *Cronica de la Araucania* (Santiago, 1889), a history of the Araucanian Indians right up to recent dates; Abbé Eyzaguirre, *Histoire du Chili* (Lille, 1855), mainly dealing with the position of the Church during the colonial period. Perez Garcia's *Historia del reino de Chile* (Santiago, 1900), an old history by a Spanish officer written about 1780, and Molina's *History of Chili* in the English translation (London, 1809), will also be found useful. Useful material for research exists in J. T. Medina's *Coleccion de documentos para la historia de Chile* (Santiago, 1888), a collection of despatches and official documents; his *Cosas de la colonia* (Santiago, 1889), an accumulation of undigested information about life in the colonial period; and *Historiadores de Chile* (21 vols., Santiago, 1861), a collection of ancient chronicles and official documents up to the early part of the 17th century.

Revolutionary Period.—A. Roldan, *Las Primeras Asambleas nacionales* (Santiago, 1890), an account of the struggles in the first national assemblies; A. Valdes, *Revolucion Chilena y campañas de la independencia* (Santiago, 1888), an account of the early fighting and rivalry of the revolutionary leaders; W. Pilling, *Emancipation of South America* (London, 1893), a translation of B. Mitre's life of San Martin, describing the fighting in the wars of independence; Lord Cochrane, *Narrative of Services in Chile, Peru and Brazil* (London, 1859), an autobiography describing the naval exploits that helped to secure the expulsion of the Spaniards; B. Vicuña Machenna, *Vida de O'Higgins* (Santiago, 1882), giving a useful account of the revolutionary struggle and the main actors; and the same author's *Historia jeneral de la republica de Chile*, a collection of essays on the early republican history by various writers.

Later History.—R. Sotomayor Valdes, *Historia de Chili, 1831-1871*, a detailed account of the period (Santiago, 1875); the same author's *Campaña del ejército Chileno en 1837* (Santiago, 1896), describing the fighting of the first Peruvian War; B. Vicuña Machenna, *D. Diego Portales* (Valparaiso, 1863), a good account of the life and time of Portales, the famous minister of the Conservative party; P. B. Figueroa, *Historia de la revolucion constituyente 1858-59* (Santiago, 1889), an account of the revolution at the end of Montt's presidency; F. Fonch, *Chile in der Gegenwart* (Berlin, 1870), a description of Chile at the time; *Statement on Behalf of Chile* (in the Chilean-Argentine Boundary Arbitration) (6 vols., London, 1901-1902); Sir Thomas Holdich, *Countries of the King's Award* (1904); Beltran y Rospido, *Los Pueblos hispano-americanos en el siglo XX.* (Madrid, 1904); P. F. Martin, *Through Five Republics of South America* (London, 1906); Wright, *The Republic of Chile* (London, 1905); G. F. Scott Elliot, *Chilé* (London, 1907); Sir W. M.

**Valparaiso
earth-
quake.**

Conway, *Aconcagua and Tierra del Fuego* (London, 1902); "Chile-Argentine Arbitration" in the *Geog. Journal* (January 1903); C. M. Pepper, *Panama to Patagonia* (London, 1907); C. E. Akers, *History of South America, 1854-1904* (London, 1904); M. Hume, *Lecture on the Republic of Chile* (London, 1902).

(E. G. J. M.; C. E. A.; G. E.)

CHILEAN CIVIL WAR (1891). The Chilean civil war grew out of political dissensions between the president of Chile, J. M. Balmaceda, and his congress (see **CHILE: History**), and began in January 1891. On the 6th, at Valparaiso, the political leaders of the Congressional party went on board the ironclad "Blanco Encalada," and Captain Jorje Montt of that vessel hoisted a broad pennant as commodore of the Congressional fleet. Preparations had long been made for the naval *pronunciamento*, and in the end but few vessels of the Chilean navy adhered to the cause of the "dictator" Balmaceda. But amongst these were two new and fast torpedo gunboats, "Almirante Condell" and "Almirante Lynch," and in European dockyards (incomplete) lay the most powerful vessel of the navy, the "Arturo Prat," and two fast cruisers. If these were secured by the Balmacedists the naval supremacy of the congress would be seriously challenged. For the present, and without prejudice to the future, command of the sea was held by Montt's squadron (January). The rank and file of the army remained faithful to the executive, and thus in the early part of the war the "Gobernistas," speaking broadly, possessed an army without a fleet, the congress a fleet without an army. Balmaceda hoped to create a navy; the congress took steps to recruit an army by taking its sympathizers on board the fleet. The first shot was fired, on the 16th of January, by the "Blanco" at the Valparaiso batteries, and landing parties from the warships engaged small parties of government troops at various places during January and February. The dictator's principal forces were stationed in and about Iquique, Coquimbo, Valparaiso, Santiago and Concepción. The troops at Iquique and Coquimbo were necessarily isolated from the rest and from each other, and military operations began, as in the campaign of 1879 in this quarter, with a naval descent upon Pisagua followed by an advance inland to Dolores. The Congressional forces failed at first to make good their footing (16th-23rd of January), but, though defeated in two or three actions, they brought off many recruits and a quantity of munitions of war. On the 26th they retook Pisagua, and on the 15th of February the Balmacedist commander, Euliojio Robles, who offered battle in the expectation of receiving reinforcements from Tacna, was completely defeated on the old battlefield of San Francisco. Robles fell back along the railway, called up troops from Iquique, and beat the invaders at Haura on the 17th, but Iquique in the meanwhile fell to the Congressional fleet on the 16th. The Pisagua line of operations was at once abandoned, and the military forces of the congress were moved by sea to Iquique, whence, under the command of Colonel Estanislao Del Canto, they started inland. The battle of Pozo Almonte, fought on the 7th of March, was desperately contested, but Del Canto was superior in numbers, and Robles was himself killed and his army dispersed. After this the other Balmacedist troops in the north gave up the struggle. Some were driven into Peru, others into Bolivia, and one column made a laborious retreat from Calama to Santiago, in the course of which it twice crossed the main chain of the Andes.

The Congressional *Junta de Gobierno* now established in Iquique prosecuted the war vigorously, and by the end of April the whole country was in the hands of the "rebels" from the Peruvian border to the outposts of the Balmacedists at Coquimbo and La Serena. The *Junta* now began the formation of a properly organized army for the next campaign, which, it was believed universally on both sides, would be directed against Coquimbo. But in a few months the arrival of the new ships from Europe would reopen the struggle for command of the sea; the *torpederas* "Condell" and "Lynch" had already weakened the Congressional squadron severely by sinking the "Blanco Encalada" in Caldera Bay (23rd of April), and the Congressional party could no longer aim at a methodical conquest of successive provinces, but was compelled to attempt to crush the dictator at a blow.

Where this blow was to fall was not decided up to the last moment, but the instrument which was to deliver it was prepared with all the care possible under the circumstances. Del Canto was made commander-in-chief, and an ex-Prussian officer, Emil Körner, chief of staff. The army was organized in three brigades of all arms, at Iquique, Caldera and Vallenar. Körner superintended the training of the men, gave instruction in tactics to the officers, caused maps to be prepared, and in general took every precaution that his experience could suggest to ensure success. Del Canto was himself no mere figurehead, but a thoroughly capable leader who had distinguished himself at Tacna (1880) and Miraflores (1881), as well as in the present war. The men were enthusiastic, and the officers unusually numerous. The artillery was fair, the cavalry good, and the train and auxiliary services well organized. About one-third of the infantry were armed with the (Männlicher) magazine rifle, which now made its first appearance in war, the remainder had the Gras and other breech-loaders, which were also the armament of the dictator's infantry. Balmaceda could only wait upon events, but he prepared his forces as best he was able, and his *torpederas* constantly harried the Congressional navy. By the end of July Del Canto and Körner had done their work as well as time permitted, and early in August the troops prepared to embark, not for Coquimbo, but for Valparaiso itself.

The expedition by sea was admirably managed, and Quinteros, N. of Valparaiso and not many miles out of range of its batteries, was occupied on the 20th of August 1891. Balmaceda was surprised, but acted promptly. The first battle was fought on the Aconcagua at Concon on the 21st. The eager infantry of the Congressional army forced the passage of the river and stormed the heights held by the Gobernistas, capturing 36 guns. The killed and wounded of the Balmacedists numbered 1600, and nearly all the prisoners, about 1500 men, enrolled themselves in the rebel army, which thus more than made good its loss of 1000 killed and wounded. The victors pressed on towards Valparaiso, but were soon brought up by the strong fortified position of the Balmacedist general Barbosa at Viña del Mar, whither Balmaceda hurried up all available troops from Valparaiso and Santiago, and even from Concepción. Del Canto and Körner now resolved on a daring step. Supplies of all kinds were brought up from Quinteros to the front, and on the 24th of August the army abandoned its line of communications and marched inland. The flank march was conducted with great skill, little opposition was encountered, and the rebels finally appeared to the south-east of Valparaiso. Here, on the 28th, took place the decisive battle of La Placilla. Concon had been perhaps little more than the destruction of an isolated corps; the second battle was a fair trial of strength, for Barbosa was well prepared, and had under his command the greater part of the existing forces of the dictator. But the splendid fighting qualities of the Congressional troops and the superior generalship of their leaders prevailed in the end over every obstacle. The government army was practically annihilated, 941 men were killed, including Barbosa and his second in command, and 2402 wounded. The Congressional army lost over 1800 men. Valparaiso was occupied the same evening and Santiago soon afterwards. There was no further fighting, for so great was the effect of the battles of Concon and La Placilla that even the Coquimbo troops surrendered without firing a shot.

BIBLIOGRAPHY.—Lieut. Sears and Ensign Wells, U.S.N., *The Chilean Revolution of 1891* (Office of Naval Intelligence, Washington, 1893); *The Capture of Valparaiso, 1891* (Intelligence Department, War Office, London, 1892); Hermann Kunz, *Taktische Beispiele aus den Kriegen der neuesten Zeit; der Bürgerkrieg in Chile* (Berlin, 1901); *Revista militar de Chile* (February-March 1892); Hugo Kunz, *Der Bürgerkrieg in Chile* (Vienna, 1892); *Militär Wochenblatt* (5th supplement, 1892); Sir W. Laird Clowes, *Four Modern Naval Campaigns* (London, 1902); *Proceedings of U. S. Naval Institute* (1894) (for La Placilla); and the military and naval periodicals of 1892.

CHILE-PERUVIAN WAR (1879-1882). The proximate cause of this war was the seizure, by the authorities of Bolivia, of the effects of the Chilean Nitrate Company at Antofagasta, then part of the Bolivian province of Atacama. The first act of

hostility was the despatch of 500 soldiers to protect Chilean interests at Antofagasta. This force, under Colonel Sotomayor, landed and marched inland; the only resistance encountered was at Calama on the river Loa, where a handful of newly raised militia was routed (23rd March 1879). About the same time Chilean warships occupied Cobija and Tocopilla, and Sotomayor, after his victory at Calama, marched to the latter port. Bolivia had declared war on the 1st of March, but Peru not till the 5th of April: this delay gave the Chileans time to occupy every port on the Bolivian coast. Thus the Chilean admiral was able to proceed at once to the blockade of the southern ports of Peru, and in particular Iquique, where there took place the first naval action of the war. On the 21st of April the Chilean sloop "Esmeralda" and the gunboat "Covadonga"—both small and weak ships—engaged the Peruvian heavy ironclads "Huascar" and "Independencia"; after a hot fight the "Huascar" under Miguel Grau sank the "Esmeralda" under Arturo Prat, who was killed, but Carlos Condell in the "Covadonga" manœuvred the "Independencia" aground and shelled her into a complete wreck. The Chileans now gave up the blockade and concentrated all their efforts on the destruction of the "Huascar," while the allies organized a field army in the neighbourhood of Tacna and a large Chilean force assembled at Antofagasta.

On the 8th of October 1879 the "Huascar" was brought to action off Angamos by the "Blanco Encalada," and the "Almirante Cochrane." Grau was outmatched as hopelessly and made as brave a fight as Prat at Iquique. Early in the action a shot destroyed the Peruvian's conning tower, killing Grau and his staff, and another entered her turret, killing the flag captain and nearly all the crew of the turret guns. When the "Huascar" finally surrendered she had but one gun left in action, her fourth commander and three-quarters of her crew were killed and wounded, and the steering-gear had been shot away. The Peruvian navy had now ceased to exist. The Chileans resumed the blockade, and more active operations were soon undertaken. The whole force of the allies was about 20,000 men, scattered along the seaboard of Peru. The Chileans on the other hand had a striking force of 16,000 men in the neighbourhood of Antofagasta, and of this nearly half was embarked for Pisagua on the 26th of October. The expeditionary force landed, in the face of considerable opposition, on the 2nd of November, and captured Pisagua. From Pisagua the Peruvians and Bolivians fell back along the railway to their reinforcements, and when some 10,000 men had been collected they moved forward to attack the Chilean position of San Francisco near Dolores station (19th November). In the end the Chileans were victorious, but their only material gain was the possession of Iquique and the retreat of the allies, who fell back inland towards Tarapacá. The tardy pursuit of the Chileans ended in the battle of Tarapacá on the 27th. In this the allies were at first surprised, but, rapidly recovering themselves, took the offensive, and after a murderous fight, in which more men were killed than were wounded, the Chileans suffered a complete defeat. For some inexplicable reason the allies made no use of their victory, continued to retreat and left the Chileans in complete possession of the Tarapacá region. With this the campaign of 1879 ended. Chile had taken possession of the Bolivian seaboard and of the Peruvian province of Tarapacá, and had destroyed the hostile navy.

The objective of the Chileans in the second campaign was the province of Tacna and the field force of the allies at Tacna and Arica. The invasion was again carried out by sea, and 12,000 Chileans were landed at Pacocha (Ylo), far to the N. of Arica. Careful preparations were made for a desert march, and on the 12th of March 1880 the advanced corps started inland for Moquegua, which was occupied on the 20th. Near Moquegua the Peruvians, some 2000 strong, took up an unusually strong position in the defile of Cuesta de los Angeles. But the great numerical superiority of the assailants enabled them to turn the flanks and press the front of the Peruvian position, and after a severe struggle the defence collapsed (March 22nd). In April the army began its advance southward from Moquegua to Tacna, while the Chilean warships engaged in a series of minor naval operations in and about the bay of Callao. Arica was also

watched, and the blockade was extended north of Lima. The land campaign had ere this culminated in the battle of Tacna (May 26th), in which the Chileans attacked at first in several disconnected bodies, and suffered severely until all their forces came on the field. Then a combined advance carried all before it. The allies engaged under General Narciso Campero, the new president of Bolivia, lost nearly 3000 men, and the Chileans, commanded by Manuel Baquedano, lost 2000 out of 8500 on the field. The defeated army was completely dissolved, and it only remained for the Chileans to march on Arica from the land side. The navy co-operated with its long-range guns, on the 7th of June a general assault was made, and before nightfall the whole of the defences were in the hands of the Chileans. Their second campaign had given them entire possession of another strip of Peru (from Pisagua to Ylo), and they had shown themselves greatly superior, both in courage and leadership, to their opponents. While the army prepared for the next campaign, the Chilean navy was active; the blockade became more stringent and several fights took place, in one of which the "Covadonga" was sunk; an expeditionary force about 3000 strong, commanded by Patricio Lynch, a captain in the Chilean navy, carried out successful raids at various places on the coast and inland.

The Chilean army was reorganized during the summer, and prepared for its next operation, this time against Lima itself. General Baquedano was in command. The leading troops disembarked at Pisco on the 18th of November 1880, and the whole army was ready to move against the defences of Lima six weeks later. These defences consisted of two distinct positions, Chorrillos and Miraflores, the latter being about 4000 yds. outside Lima. The first line of defence was attacked by Baquedano on the 13th of January 1881. Reconnaissances proved that the Peruvian lines could not be turned, and the battle was a pure frontal attack. The defenders had 22,000 men in the lines, the Chileans engaged about 24,000. The battle of Chorrillos ended in the complete defeat of the Peruvians, less than a quarter of whose army rallied behind the Miraflores defences. The Chileans lost over 3000 men. Two days later took place the battle of Miraflores (January 15th). Here the defences were very strong, and the action began with a daring counter-attack by some Peruvians. Neither party had intended to fight a battle, for negotiations were in progress, but the action quickly became general. Its result was, as before, the complete dissolution of the defending army. Lima, incapable of defence, was occupied by the invaders on the 17th, and on the 18th Callao surrendered. The resistance of the Peruvians was so far broken that Chile left only a small army of occupation to deal with the remnants of their army. The last engagement took place at Caxacamarca in September 1882, when the Peruvians won an unimportant success.

See T. B. M. Mason, *The War on the Pacific Coast, 1879-1881* (U.S. Office of Naval Intelligence, Washington, 1883); Captain Châteauminois (transl.), *Mémoire du Ministre de la Guerre du Chili sur la guerre Chilo-Péruvienne* (1882); Barros Arana, *Hist. de la guerre du Pacifique* (1884); Sir W. Laird Clowes, *Four Modern Naval Campaigns* (London, 1902); Anon., *Précis de la guerre du Pacifique* (Paris, 1886); Clements R. Markham, *The War between Peru and Chile*.

CHILIASM (from Gr. χιλιασμός; χίλιοι, a thousand), the belief that Christ will return to reign in the body for a thousand years, the doctrine of the Millennium (*q.v.*).

CHILLÁN, a city and the capital of the province of Ñuble, in the southern part of central Chile, 35° 56' S., 71° 37' W., 246 m. by rail S.S.W. of Santiago and about 56 m. direct (108 by rail) N.E. of Concepción. Pop. (1895) 28,738; (1902, official estimate) 36,382. Chillán is one of the most active commercial cities of central Chile, and is surrounded by a rich agricultural and grazing country. Chillán was founded by Ruiz de Gambóa in 1594. Its present site was chosen in 1836. The original site, known as Chillán Viejo, forms a suburb of the new city. The hot sulphur springs of Chillán, which were discovered in 1795, are about 45 m. E.S.E. They issue from the flanks of the "Volcan Viejo," about 7000 ft. above sea-level. The highest temperature of the water issuing from these springs is a little over 135°. The principal volcanoes of the Chillán group are the Nevado (9528 ft.) and the Viejo. After a repose of about two centuries the Nevado de Chillán broke out in eruption early in 1861 and caused great destruction. The eruption ceased in 1863, but broke out again in 1864.

CHILLIANWALLA, a village of British India in the Punjab, situated on the left bank of the river Jhelum, about 85 m. N.W. of Lahore. It is memorable as the scene of a battle on the 13th of January 1849, between a British force commanded by Lord Gough and the Sikh army under Sher Singh. The loss of the Sikhs was estimated at 4000, while that of the British in killed and wounded amounted to 2800, of whom nearly 1000 were Europeans and 89 were British and 43 native officers. An

obelisk erected at Chillianwalla by the British government preserves the names of those who fell.

CHILlicoTHE, a city and the county-seat of Livingston county, Missouri, U.S.A., situated in the N. part of the state, on the Grand river, about 80 m. N.E. of Kansas City. Pop. (1890) 5717; (1900) 6905 (538 negroes); (1910) 6265. It is served by the Chicago, Milwaukee & St Paul, the Wabash, and the Chicago, Burlington & Quincy railways. There are various manufactures. Coal and limestone are found in the vicinity, and much live stock is raised, wool and hides being shipped from Chillicothe. Chillicothe was settled about 1830, and the town was laid out in 1837 on land granted directly by the Federal government; it was incorporated in 1855.

CHILlicoTHE, a city and the county-seat of Ross county, Ohio, U.S.A., on the W. bank of the Scioto river, on the Ohio & Erie Canal, about 50 m. S. of Columbus. Pop. (1890) 11,288; (1900) 12,976, of whom 986 were negroes, and 910 were foreign-born; (1910 census) 14,508. Chillicothe is served by the Baltimore & Ohio South-Western (which has railway shops here), and other railways. The city has two parks. There are several ancient mounds in the vicinity. Chillicothe is built on a plain about 30 ft. above the river, in the midst of a fertile agricultural region, and has a large trade in grain and coal, and in manufactures. The value of the city's factory products increased from \$1,615,959 in 1900 to \$3,146,890 in 1905, or 94.7%. Chillicothe was founded in 1796, and was first incorporated in 1802. In 1800-1803 it was the capital of the North-West Territory, and in 1803-1810 and 1812-1816 the capital of Ohio. Three Indian villages bore the name Chillicothe, each being in turn the chief town of the Chillicothe, one of the four tribal divisions of the Shawnee, in their retreat before the whites; the village near what is now Oldtown in Greene county was destroyed by George Rogers Clark in 1780; that in Miami county, where Piqua is now, was destroyed by Clark in 1782; and the Indian village near the present Chillicothe was destroyed in 1787 by Kentuckians.

See Henry Howe, *Historical Collections of Ohio* (Columbus, 1891).

CHILLINGWORTH, WILLIAM (1602-1644), English divine and controversialist, was born at Oxford in October 1602. In June 1618 he became a scholar of Trinity College, Oxford, and was made a fellow of his college in June 1628. He had some reputation as a skilful disputant, excelled in mathematics, and gained some credit as a writer of verses. The marriage of Charles I. with Henrietta Maria of France had stimulated the propaganda of the Roman Catholic Church, and the Jesuits made the universities their special point of attack. One of them, "John Fisher," who had his sphere at Oxford, succeeded in making a convert of young Chillingworth, and prevailed upon him to go to the Jesuit college at Douai. Influenced, however, by his godfather, Laud, then bishop of London, he resolved to make an impartial inquiry into the claims of the two churches. After a short stay he left Douai in 1631 and returned to Oxford. On grounds of Scripture and reason he at length declared for Protestantism, and wrote in 1634, but did not publish, a confutation of the motives which had led him over to Rome. This paper was lost; the other, on the same subject, was probably written on some other occasion at the request of his friends. He would not, however, take orders. His theological sensitiveness appears in his refusal of a preferment offered to him in 1635 by Sir Thomas Coventry, lord keeper of the great seal. He was in difficulty about subscribing the Thirty-nine Articles. As he informed Gilbert Sheldon, then warden of All Souls, in a letter, he was fully resolved on two points—that to say that the Fourth Commandment is a law of God appertaining to Christians is false and unlawful, and that the damnatory clauses in the Athanasian Creed are most false, and in a high degree presumptuous and schismatical. To subscribe, therefore, he felt would be to "subscribe his own damnation." At this time his principal work was far towards completion. It was undertaken in defence of Dr Christopher Potter, provost of Queen's College in Oxford, who had for some time been carrying on a controversy with a Jesuit known as Edward Knott, but

whose real name was Matthias Wilson. Potter had replied in 1633 to Knott's *Charity Mistaken* (1630), and Knott retaliated with *Mercy and Truth*. This work Chillingworth engaged to answer, and Knott, hearing of his intention and hoping to bias the public mind, hastily brought out a pamphlet tending to show that Chillingworth was a Socinian who aimed at perverting not only Catholicism but Christianity.

Laud, now archbishop of Canterbury, was not a little solicitous about Chillingworth's reply to Knott, and at his request, as "the young man had given cause why a more watchful eye should be held over him and his writings," it was examined by the vice-chancellor of Oxford and two professors of divinity, and published with their approbation in 1637, with the title *The Religion of Protestants a Safe Way to Salvation*. The main argument is a vindication of the sole authority of the Bible in spiritual matters, and of the free right of the individual conscience to interpret it. In the preface Chillingworth expresses his new view about subscription to the articles. "For the Church of England," he there says, "I am persuaded that the constant doctrine of it is so pure and orthodox, that whosoever believes it, and lives according to it, undoubtedly he shall be saved, and that there is no error in it which may necessitate or warrant any man to disturb the peace or renounce the communion of it. This, in my opinion, is all intended by subscription." His scruples having thus been overcome, he was, in the following year (1638), promoted to the chancellorship of the church of Sarum, with the prebend of Brixworth in Northamptonshire annexed to it. In the great civil struggle he used his pen against the Scots, and was in the king's army at the siege of Gloucester, inventing certain engines for assaulting the town. Shortly afterwards he accompanied Lord Hopton, general of the king's troops in the west, in his march; and, being laid up with illness at Arundel Castle, he was there taken prisoner by the parliamentary forces under Sir William Waller. As he was unable to go to London with the garrison, he was conveyed to Chichester, and died there in January 1644. His last days were harassed by the diatribes of the Puritan preacher, Francis Cheynell.

Besides his principal work, Chillingworth wrote a number of smaller anti-Jesuit papers published in the posthumous *Additional Discourses* (1687), and nine of his sermons have been preserved. In politics he was a zealous Royalist, asserting that even the unjust and tyrannous violence of princes may not be resisted, although it might be avoided in terms of the instruction, "when they persecute you in one city, flee into another." His writings long enjoyed a high popularity. The *Religion of Protestants* is characterized by much fairness and acuteness of argument, and was commended by Locke as a discipline of "perspicuity and the way of right reasoning." The charge of Socinianism was frequently brought against him, but, as Tillotson thought, "for no other cause but his worthy and successful attempts to make the Christian religion reasonable." His creed, and the whole gist of his argument, is expressed in a single sentence, "I am fully assured that God does not, and therefore that men ought not to, require any more of any man than this, to believe the Scripture to be God's word, and to endeavour to find the true sense of it, and to live according to it."

A *Life* by Rev. T. Birch was prefixed to the 1742 edition of Chillingworth's *Works*.

CHILOÉ (from *Chile* and *hué*, "part of Chile"), a province of southern Chile, and also the name of a large island off the Chilean coast forming part of the province. The province, area 8593 sq. m., pop. (1895) 77,750, is composed of three groups of islands, Chiloe, Guaitecas and Chonos, and extends from the narrow strait of Chacao in 41° 40' S. to the peninsula of Taytao, about 45° 45' S. The population is composed mainly of Indians, distantly related to the tribes of the mainland, and mestizos. The capital of the province is Ancud or San Carlos, at the northern end of the island of Chiloe, on the sheltered bay of San Carlos, once frequented by whalers. It is the seat of a bishopric; pop. (1905) 3182. Other towns are Castro, the former capital, on the eastern shore of Chiloe, and the oldest town of the island (founded 1566), once the seat of a Jesuit mission, and Melinca on an island of the Guaitecas group.

The island of Chiloe, which lies immediately south of the province of Llanquihue, is a continuation of the western Chilean formation, the coast range appearing in the mountainous range of western Chiloe and the islands extending south along the coast. Between this coast

range and the Andes, the gulfs of Chacao, or Ancud and Corcovado (average width, 30 m.) separate the island from the mainland. Chilóé has an extreme length north to south of about 118 m., and an average width of 35 to 40 m., with an area of about 4700 sq. m. There are several lakes on the island—Cucaco, 12 m. long, being the largest,—and one small river, the Pudeto, in the northern part of the island, is celebrated as the scene of the last engagement in the war for independence, the Spanish retaining possession of Chilóé until 1826.

CHILON, of Sparta, son of Damagetus, one of the Seven Sages of Greece, flourished about the beginning of the 6th century B.C. In 560 (or 556) he acted as ephor, an office which he is even said to have founded. The tradition was that he died of joy on hearing that his son had gained a prize at the Olympic games. According to Chilon, the great virtue of man was prudence, or well-grounded judgment as to future events.

A collection of the sayings attributed to him will be found in F. W. Mullach, *Fragmenta Philosophorum Græcorum*, i.; see Herodotus i. 69; Diogenes Laertius i. 68; Pausanias iii. 16, x. 24.

CHILPERIC, the name of two Frankish kings.

CHILPERIC I. (d. 584) was one of the sons of Clotaire I. Immediately after the death of his father in 561 he endeavoured to take possession of the whole kingdom, seized the treasure amassed in the royal town of Berny and entered Paris. His brothers, however, compelled him to divide the kingdom with them, and Soissons, together with Amiens, Arras, Cambrai, Théroüanne, Tournai and Boulogne, fell to Chilperic's share, but on the death of Charibert in 567 his estates were augmented. When his brother Sigebert married Brunhilda, Chilperic also wished to make a brilliant marriage. He had already repudiated his first wife, Audovera, and had taken as his concubine a serving-woman called Fredegond. He accordingly dismissed Fredegond, and married Brunhilda's sister, Galswintha. But he soon tired of his new partner, and one morning Galswintha was found strangled in her bed. A few days afterwards Chilperic married Fredegond. This murder was the cause of long and bloody wars, interspersed with truces, between Chilperic and Sigebert. In 575 Sigebert was assassinated by Fredegond at the very moment when he had Chilperic at his mercy. Chilperic retrieved his position, took from Austrasia Tours and Poitiers and some places in Aquitaine, and fostered discord in the kingdom of the east during the minority of Childebert II. One day, however, while returning from the chase to the town of Chelles, Chilperic was stabbed to death.

Chilperic may be regarded as the type of Merovingian sovereigns. He was exceedingly anxious to extend the royal authority. He levied numerous imposts, and his fiscal measures provoked a great sedition at Limoges in 579. He wished to bring about the subjection of the church, and to this end sold bishoprics to the highest bidder, annulled the wills made in favour of the bishoprics and abbey, and sought to impose upon his subjects a rationalistic conception of the Trinity. He pretended to some literary culture, and was the author of some halting verse. He even added letters to the Latin alphabet, and wished to have the MSS. rewritten with the new characters. The wresting of Tours from Austrasia and the seizure of ecclesiastical property provoked the bitter hatred of Gregory of Tours, by whom Chilperic was stigmatized as the Nero and the Herod of his time.

See Sérésia, *L'Église et l'État sous les rois francs au VI^e siècle* (Ghent, 1888).

CHILPERIC II. (d. 720) was the son of Childeric II. He became king of Neustria in 715, on which occasion he changed his name from Daniel to Chilperic. At first he was a tool in the hands of Ragenfrid, the mayor of the palace. Charles Martel, however, overthrew Ragenfrid, accepted Chilperic as king of Neustria, and, on the death of Clotaire IV., set him over the whole kingdom. The young king died soon afterwards. (C. P.F.)

CHILTERN HILLS, or **THE CHILTERNs**, a range of chalk hills in England, extending through part of Oxfordshire, Buckinghamshire and Bedfordshire. Running from S.W. to N.E., they form a well-marked escarpment north-westward, while the south-eastern slope is long. The name of Chilterns is applied to the hills between the Thames in the neighbourhood of Goring

and the headwaters of its tributary the Lea between Dunstable and Hitchin, the crest line between these points being about 55 m. in length. But these hills are part of a larger chalk system, continuing the line of the White Horse Hills from Berkshire, and themselves continued eastward by the East Anglian ridge. The greatest elevation of the Chilterns is found in the centre from Watlington to Tring, where heights from 800 to 850 ft. are frequent. Westward towards the Thames gap the elevation falls away but little, but eastward the East Anglian ridge does not often exceed 500 ft., though it continues the northward escarpment across Hertfordshire. There are several passes through the Chilterns, followed by main roads and railways converging on London, which lies in the basin of which these hills form part of the northern rim. The most remarkable passes are those near Tring, Wendover and Prince's Risborough, the floors of which are occupied by the gravels of former rivers. The Chilterns were formerly covered with a forest of beech, and there is still a local supply of this wood for the manufacture of chairs and other articles in the neighbourhood of Wycombe.

CHILTERN HUNDREDS. An old principle of English parliamentary law declared that a member of the House of Commons, once duly chosen, could not *resign* his seat. This rule was a relic of the days when the local gentry had to be compelled to serve in parliament. The only method, therefore, of avoiding the rule came to be by accepting an office of profit from the crown, a statute of 1707 enacting that every member accepting an office of profit from the crown should thereby vacate his seat, but should be capable of re-election, unless the office in question had been created since 1705, or had been otherwise declared to disqualify for a seat in parliament. Among the posts of profit held by members of the House of Commons in the first half of the 18th century are to be found the names of several crown stewardships, which apparently were not regarded as places of profit under the crown within the meaning of the act of 1707, for no seats were vacated by appointment to them. The first instance of the acceptance of such a stewardship vacating a seat was in 1740, when the house decided that Sir W. W. Wynn, on inheriting from his father, in virtue of a royal grant, the stewardship of the lordship and manor of Bromfield and Yale, had *ipso facto* vacated his seat. On the passing of the Place Act of 1742, the idea of utilizing the appointment to certain crown stewardships (possibly suggested by Sir W. W. Wynn's case) as a pretext for enabling a member to resign his seat was carried into practice. These nominal stewardships were eight in number, but only two survived to be used in this way in contemporary practice—those of the Chilterns and Northstead; and when a member wished to vacate his seat, he was accordingly spoken of as taking the Chiltern Hundreds.

1. *Steward and Bailiff of the Chiltern Hundreds, County Bucks.*—The Chiltern Hundreds formed a bailiwick of the ordinary type. They are situated on the Chiltern Hills, and the depredations of the bandits, who found shelter within their recesses, became at an early period so alarming that a special officer, known as the steward of the Chiltern Hundreds, was appointed for the protection of the inhabitants of the neighbouring districts. It is doubtful at what date the necessity for such an appointment disappeared, but the three hundreds of Stoke, Burnham and Desborough are still distinguished by the old name. The appointment of steward was first used for parliamentary purposes in 1750, the appointment being made by the chancellor of the exchequer (and at his discretion to grant or not), and the warrant bestowing on the holder "all wages, fees, allowances and other privileges and pre-eminences." Up to the 19th century there was a nominal salary of 20s. attached to the post. It was laid down in 1846 by the chancellor of the exchequer that the Chilterns could not be granted to more than one person in the same day, but this rule has not been strictly adhered to, for on four occasions subsequent to 1850 the Chilterns were granted twice on the same day. The Chilterns might be granted to members whether they had taken the oath or not, or during a recess, though in this case a new writ could not be issued until the House met again. Each new warrant expressly revoked the grant to the last holder, the new steward retaining it in his turn until another should be appointed.

2. *Steward and Bailiff of the Manor of East Hundred, or Hendred, Berks.*—This stewardship was first used for parliamentary purposes in 1763, and was in more or less constant use until 1840, after which it disappeared. This manor comprised copyholds, the usual courts were held, and the stewardship was an actual and active office, the duties being executed by a deputy steward. The manor was sold by

public auction in 1823 for £910, but in some manner the crown retained the right of appointing a steward for seventeen years after that date.

3. *Steward and Bailiff of the Manor of Northstead, Yorkshire.*—This manor was crown property before 1750, but was in lease until 1838. It has no copyhold lands, nor are there any records of manor courts. There are no traces of any profits having ever been derived from the office. It was used for parliamentary purposes in 1844 and subsequently.

4. *Steward of the Manor of Hempholme, Yorkshire.*—This manor appears to have been of the same nature as that of Northstead. It was in lease until 1835. It was first used for parliamentary purposes in 1845 and was in constant use until 1865. It was sold in 1866.

5. *Escheator of Munster.*—Escheators were officers commissioned to secure the rights of the crown over property which had legally escheated to it. In Ireland mention is made of escheators as early as 1256. In 1605 the escheatorship of Ireland was split up into four, one for each province, but the duties soon became practically nominal. The escheatorship of Munster was first used for parliamentary purposes in the Irish parliament from 1793 to 1800, and in the united parliament (24 times for Irish seats and once for a Scottish seat) from 1801 to 1820. After 1820 it was discontinued and finally abolished in 1838.

6. *Steward of the Manor of Old Shoreham, Sussex.*—This manor belonged to the duchy of Cornwall, and it is difficult to understand how it came to be regarded as a crown appointment. It was first used for parliamentary purposes in 1756, and then, occasionally, until 1799, in which year it was sold by the duchy to the duke of Norfolk.

7. *Steward of the Manor of Poynings, Sussex.*—This manor reverted to the crown on the death of Lord Montague about 1804, but was leased up to about 1835. It was only twice used for parliamentary purposes, in 1841 and 1843.

8. *Escheator of Ulster.*—This appointment was used in the united parliament three times, for Irish seats only; the last time in 1819.

See parliamentary paper—*Report from the Select Committee on House of Commons (Vacating of Seats) (1894).* (T. A. I.)

CHILWA (incorrectly **SHIRWA**), a shallow lake in south-east Africa, S.S.E. of Lake Nyasa, cut by 35° 20' E., and lying between 15° and 15° 35' S. The lake is undergoing a process of desiccation, and in some dry seasons (as in 1879 and 1903) the "open water" is reduced to a number of large pools. Formerly the lake seems to have found an outlet northwards to the Lujenda branch of the Rovuma, but with the sinking of its level it is now separated from the Lujenda by a wooded ridge some 30 to 40 ft. above the surrounding plains. There are four islands, the largest rising 500 ft. above the water. The lake was discovered by David Livingstone in 1859 and was by him called Shirwa, from a mishearing of the native name.

CHIMAERA, in Greek mythology, a fire-breathing female monster resembling a lion in the fore part, a goat in the middle, and a dragon behind (*Iliad*, vi. 179), with three heads corresponding. She devastated Caria and Lycia until she was finally slain by Bellerophon (see H. A. Fischer, *Bellerophon*, 1851). The origin of the myth was the volcanic nature of the soil of Lycia (Pliny, *Nat. Hist.* ii. 110; Servius on *Aeneid*, vi. 288), where works have been found containing representations of the Chimaera in the simple form of a lion. In modern art the Chimaera is usually represented as a lion, with a goat's head in the middle of the back, as in the bronze Chimaera of Arezzo (5th century). The word is now used generally to denote a fantastic idea or fiction of the imagination.

CHIMAY, a town in the extreme south-east of the province of Hainaut, Belgium, dating from the 7th century. Pop. (1904) 3383. It is more commonly spoken of as being in the district *entre Sambre et Meuse*. Owing to its proximity to the French frontier it has undergone many sieges, the last of which was in 1640, when Turenne gave orders that it should be reduced to such ruin that it could never stand another. The town is chiefly famous for the castle and park that bear its name. Originally a stronghold of the Cröy family, it has passed through the D'Arenbergs to its present owners, the princes of Caraman-Chimay. The castle, which before Turenne's order to demolish it possessed seven towers, has now only one in ruins, and a modern château was built in the Tudor style in the 18th century. This domain carried with it the right to one of the twelve peerages of Hainaut. Madame Tallien, daughter of Dr Cabarrus, the Lady of Thermidor, married as her second husband the prince de Chimay, and held her little court here down to her death in 1835. There is a

memorial to her in the church, which also contains a fine monument of Phillippe de Cröy, chamberlain and comrade in arms of the emperor Charles V. John Froissart the chronicler died and was buried here. There is a statue in his honour on the Grand Place. Chimay is situated on a stream called the White Water, which in its lower course becomes the Viroin and joins the Meuse.

CHIME. (1) (Probably derived from a mistaken separation into two words, *chimbe bell*, of *chymbal* or *chymbel*, the old form of "cymbal," Lat. *cymbalum*), a mechanical arrangement by which a set of bells in a church or other tower, or in a clock, are struck so as to produce a sequence of musical sounds or a tune. For the mechanism of such an arrangement in a clock and in a set of bells, see the articles **CLOCK** and **BELL**. The word is also applied to the tune thus played by the bells and also to the harmonious "fall" of verse, and so, figuratively, to any harmonious agreement of thought or action. (2) (From Mid. Eng. *chimb*, a word meaning "edge," common in varied forms to Teutonic languages, cf. Ger. *Kimme*), the bevelled rim formed by the projecting staves at the ends of a cask.

CHIMERE (Lat. *chimera*, *chimacra*; O. Fr. *chamarre*, Mod. Fr. *simarre*; Ital. *zimarra*; cf. Span. *zamarra*, a sheepskin coat; possibly derived ultimately from Gr. *χειμέριος*, "wintry," i.e. a winter overcoat), in modern English use the name of a garment worn as part of the ceremonial dress of Anglican bishops. It is a long sleeveless gown of silk or satin, open down the front, gathered in at the back between the shoulders, and with slits for the arms. It is worn over the rochet (*q.v.*), and its colour is either black or scarlet (convocation robes). By a late abuse the sleeves of the rochet were, from motives of convenience, sometimes attached to the chimere. The origin of the chimere has been the subject of much debate; but the view that it is a modification of the cope (*q.v.*) is now discarded, and it is practically proved to be derived from the medieval tabard (*tabardum*, *taberda* or *collobium*), an upper garment worn in civil life by all classes of people both in England and abroad. It has therefore a common origin with certain academic robes (see **ROBES**, § *Academic dress*).

The word "chimere," which first appears in England in the 14th century, was sometimes applied not only to the tabard worn over the rochet, but to the sleeved cassock worn under it. Thus Archbishop Scrope is described as wearing when on his way to execution (1405) a blue chimere with sleeves. But the word properly applies to the sleeveless tabard which tended to supersede, from the 15th century onwards, the inconvenient *cappa clausa* (a long closed cloak with a slit in front for the arms) as the out-of-doors upper garment of bishops. These chimeres, the colours of which (murrey, scarlet, green, &c.) may possibly have denoted academical rank, were part of the civil costume of prelates. Thus in the inventory of Walter Skirlawe, bishop of Durham (1405-1406), eight chimeres of various colours are mentioned, including two for riding (*pro equitalura*). The chimere was, moreover, a cold weather garment. In summer its place was taken by the tippet.

In the Anglican form for the consecration of bishops the newly consecrated prelate, hitherto vested in rochet, is directed to put on "the rest of the episcopal habit," i.e. the chimere. The robe has thus become in the Church of England symbolical of the episcopal office, and is in effect a liturgical vestment. The rubric containing this direction was added to the Book of Common Prayer in 1662; and there is proof that the development of the chimere into at least a choir vestment was subsequent to the Reformation. Foxe, indeed, mentions that Hooper at his consecration wore "a long scarlet chymere down to the foot" (*Acts and Mon.*, ed. 1563, p. 1051), a source of trouble to himself and of scandal to other extreme reformers; but that this was no more than the full civil dress of a bishop is proved by the fact that Archbishop Parker at his consecration wore surplice and tippet, and only put on the chimere, when the service was over, to go away in. This civil quality of the garment still survives alongside the other; the full dress of an Anglican prelate at civil functions of importance (e.g. in parliament, or at court) is still rochet and chimere.

The continental equivalent of the chimere is the *zimarra* or *simarre*, which is defined by foreign ecclesiologists (Moroni, Barbier de Montault) as a kind of *soutane* (cassock), from which it is distinguished by having a small cape and short, open arms (*manches-faussees*) reaching to the middle of the upper arm and decorated with buttons. In France and Germany it is fitted more or less to the figure; in Italy it is wider and falls down straight in front. Like the *soutane*, the *zimarra* is not proper to any particular rank of clergy, but in the case of bishops and prelates it is ornamented with red buttons and bindings. It never has a train (*cauda*). It is not universally worn, e.g. in Germany apparently only by prelates. G. Moroni identifies the *zimarra* with the *epitogium* which Domenico Magri, in his *Hierolexicon* (ed. 1677), calls the uppermost garment of the clergy, worn over the *soutane* (*loga*) instead of the *mantellum* (*vestis suprema clericorum loco pallii*), with a cross-reference to *Tabardum*, the "usual" upper garment (*pallium usuale*); and this definition is repeated in the 8th edition of the work (1732). From this it appears that so late as the middle of the 18th century the *zimarra* was still in common use as an out-of-doors overcoat. But, according to Moroni, by the latter half of the 19th century the *zimarra*, though still worn by certain civilians (e.g. notaries and students), had become in Italy chiefly the domestic garment of the clergy, notably of superiors, parish priests, rectors, certain regulars, priests of congregations, bishops, prelates and cardinals. It was worn also by the Roman senators, and is still worn by university professors. A black *zimarra* lined with white, and sometimes ornamented with a white binding and gold tassels, is worn by the pope.

More analogous to the Anglican chimere in shape, though not in significance, is the purple *mantelletum* worn over the rochet by bishops, and by others authorized to wear the episcopal insignia, in presence of the pope or his legates. This symbolizes the temporary suspension of the episcopal jurisdiction (symbolized by the rochet) so long as the pope or his representative is present. Thus at the Curia cardinals and prelates wear the *mantelletum*, while the pope wears the *zimarra*, and the first act of the cardinal camerlengo after the pope's death is to expose his rochet by laying aside the *mantelletum*, the other cardinals following his example, as a symbol that during the vacancy of the papacy the pope's jurisdiction is vested in the Sacred College. On the analogy of the *mantelletum* certain Anglican prelates, American and colonial, have from time to time appeared in purple chimeres; which, as the Rev. N. F. Robinson justly points out, is a most unhappy innovation, since it has no historical justification, and its symbolism is rather unfortunate.

AUTHORITIES.—See the *Report* of the sub-committee of Convocation on the ornaments of the church and its ministers, p. 31 (London, 1908); the Rev. N. F. Robinson, "The black chimere of Anglican Prelates: a plea for its retention and proper use," in *Transactions of the St Paul's Ecclesiological Soc.* vol. iv. pp. 181-220 (London, 1898); Herbert Druitt, *Costume on Brasses* (London, 1906); G. Moroni, *Dizionario dell' erudizione storico-ecclesiastica* (Venice, 1861), vol. 103, s.v. "Zimarra"; X. Barbier de Montault, *Traité pratique de la construction, &c., des églises*, ii. 538 (Paris, 1878). (W. A. P.)

CHIMESYAN (*Tsimshian*), a tribe of North American Indians, now some 3000 in number, living around the mouth of the Skeena river, British Columbia, and on the islands near the coast. They are a powerfully built people, who tattoo and wear labrets and rings in noses and ears. They are skilful fishermen, and live in large communal houses. They are divided into clans and distinct social orders.

CHIMKENT, a town of Asiatic Russia, in the province of Syr-darya, 70 m. by rail N.N.E. of Tashkent. Pop. (1897) 10,756, mostly Sarts. It occupies a strategical position at the west end of the valley between the Alexander range and the Ala-tau (or Talaş-tau), at the meeting of commercial routes from (1) Vyernyi and Siberia beyond, from the north-east, (2) the Aral Sea and Orenburg (connected with it by rail since 1905) to the north-west, and (3) Ferghana and Bokhara to the south. The citadel, which was stormed by the Russians in 1864, stands on high ground above the town, but is now in ruins. Chimkent is visited by consumptive patients who wish to try the koumiss cure. It has cotton mills and soap-works.

CHIMNEY (through the Fr. *cheminée*, from *caminata*, sc. *camera*, a Lat. derivative of *caminus*, an oven or furnace), in architecture, that portion of a building, rising above the roof, in which are the flues conveying the smoke to the outer air. Originally the term included the fireplace as well as the chimney shaft. At Rochester Castle (1130) and Heddington, Essex, there were no external chimney shafts, and the flue was carried through the wall at some height above the fireplace. In the early examples the chimney shaft was circular, with one flue only, and was terminated with a conical cap, the smoke issuing from

openings in the side, which at Sherborne Abbey (A.D. 1300) were treated decoratively. It was not till the 15th century that the smoke issued at the top, and later in the century that more than one flue was carried up in the same shaft. There are a few examples of the clustered shaft in stone, but as a rule they are contemporaneous with the general use of brick. The brick chimney shafts, of which there are fine specimens at Hampton Court, were richly decorated with chevrons and other geometrical patterns. One of the best examples is that at Thornton Castle, Gloucestershire.

In the 15th and 16th centuries in France the chimney shaft was recognized as an important architectural feature, and was of considerable elevation in consequence of the great height of the roofs. In the château of Meillant (1503) the chimney shafts are decorated with angle buttresses, niches and canopies, in the late Flamboyant style; and at Chambord and Blois they are carved with pilasters and niches with panelling above, carved with the salamander and other armorial devices. In the Roman palaces they are sometimes masked by the balustrades, and (when shown) take the form of sepulchral urns, as if to disguise their real purpose. Though not of a very architectural character, the chimneys at Venice present perhaps the greatest variety of terminations, and as a rule the smoke comes out on the sides and not through the top. (R. P. S.)

Factory Chimneys.—Chimneys, besides removing the products of combustion, also serve to provide the fire with the air requisite for burning the fuel. The hot air in the shaft, being lighter than the cold air outside it, tends to rise, and as it does so air flows in at the bottom to take its place. An ascending current is thus established in the chimney, its velocity, other things being equal, varying as the square root of the height of the shaft above the grate. The velocity also increases with increase of temperature in the gas column, but since the weight of each cubic foot grows less as the gases expand, the amount of smoke discharged by a chimney does not increase indefinitely with the temperature; a maximum is reached when the difference in temperature between the gases in the shaft and the outside air is about 600° F., but the rate of increase is very slow after the difference has passed about 300° F. In designing a chimney the dimensions (height and sectional area) have to be so proportioned to the amount of fuel to be burnt in the various furnaces connected with it that at the temperature employed the products of combustion are effectively removed, due allowance being made for the frictional retardation of the current against the sides of the flues and shafts and in passing through the fire. The velocity of the current in actual chimneys varies widely, from 3 or 4 to 50 or 60 ft. a second. Increased velocity, obtainable by increasing the height of the shaft, gives increased delivering capacity, but a speed of 10 or 12 ft. a second is regarded as good practice. Ordinary factory chimneys do not in general exceed 180 or 200 ft. in height, but in some cases, especially when, as in chemical works, they are employed to get rid of objectionable vapours, they have been made double that height, or even more. In section they are round, octagonal or square. The circular form offers the least resistance to wind pressure, and for a given height and sectional area requires less material to secure stability than the octagonal and still less than the square; on the other hand, there is more liability to cracking. Brick is the material commonly used, but many chimneys are now made of iron or steel. Reinforced concrete is also employed.

CHIMNEYPIECE, the term given to the projecting hood which in medieval times was built over a fireplace to catch the smoke, and at a later date to the decorative framework, often carried up to the ceiling. "Chimney-piece" or "mantelpiece" is now the general term for the jambs, mantelshelf and external accessories of a fireplace. For many centuries the chimney-piece was the most ornamental and most artistic feature of a room, but as fireplaces have become smaller, and modern methods of heating have been introduced, its artistic as well as its practical significance has grown less.

Up to the 12th century rooms were warmed entirely by a hypocaust, or with braziers, or by fires on the hearth, the smoke finding its way up to a lantern in the roof. The earliest chimney-piece known is that in the King's House at Southampton, with Norman shafts in the joints carrying a segmental arch, which is attributed to the first half of the 12th century. At a later date, in consequence of the greater width of the fireplace, flat or segmental arches were thrown across and constructed with voussoirs, sometimes joggled, the thrust of the arch being resisted by bars of iron at the back. In domestic work of the 14th century the chimney-piece was greatly increased in order to allow of the members of the family sitting on either side of the fire on the hearth, and in these cases great beams of timber were employed to carry the hood; in such cases the fireplace was so

deeply recessed as to become externally an important architectural feature, as at Haddon Hall. The largest chimney-piece existing is in the great hall of the Palais des Comtes at Poitiers, which is nearly 30 ft. wide, having two intermediate supports to carry the hood; the stone flues are carried up between the tracery of an immense window above. In the early Renaissance style, the chimney-piece of the Palais de Justice at Bruges is a magnificent example; the upper portion, carved in oak, extends the whole width of the room, with statues of nearly life size of Charles V. and others of the royal family of Spain. The most prolific modern designer of chimney-pieces was J. B. Piranesi, who in 1765 published a large series, on which at a later date the Empire style in France was based. In France the finest work of the early Renaissance period is to be found in the chimney-pieces, which are of infinite variety of design.

The English chimney-pieces of the early 17th century, when the purer Italian style was introduced by Inigo Jones, were extremely simple in design, sometimes consisting only of the ordinary mantel-piece, with classic architraves and shelf, the upper part of the chimney breast being panelled like the rest of the room. In the latter part of the century the classic architrave was abandoned in favour of a much bolder and more effective moulding, as in the chimney-pieces at Hampton Court, and the shelf was omitted.

In the 18th century the architects returned to the Inigo Jones classic type, but influenced by the French work of Louis XIV. and XV. Figure sculpture, generally represented by graceful figures on each side, which assisted to carry the shelf, was introduced, and the overmantel developed into an elaborate frame for the family portrait over the chimney-piece. Towards the close of the 18th century the designs of the brothers Adam superseded all others, and a century later they came again into fashion. The Adam mantels are in wood enriched with ornament, cast in moulds, sometimes copied from the carved wood decoration of old times. (R. P. S.)

CHIMPANZEE (*Chimpanzi*), the vernacular name of the highest species of the man-like apes, forming the typical representatives of the genus *Anthropopithecus*. Chimpanzees, of which there appear to be at least two species, range through the tropical forest-zone of Africa from the west coast to Uganda. The typical *A. troglodytes* has been long known to European science, Dr Tyson, a celebrated surgeon and anatomist of his time, having dissected a young individual, and described it, as a pigmy or *Homo sylvestris*, in a book published in 1699. Of this baby chimpanzee the skeleton may be seen in the Natural History branch of the British Museum alongside the volume in which it is described. It was not, however, till 1788 that the chimpanzee received what is now recognized as a scientific name, having been christened in that year *Simia troglodytes* by the naturalist Johann Friedrich Gmelin. In his classification it was included in the same genus as the orang-utan; and it has recently been suggested that the name *Simia* pertains of right to the chimpanzee rather than to the orang-utan. Between the typical West African chimpanzee and the gorilla (*q.v.*) there is no difficulty in drawing a distinction; the difficulty comes in when we have to deal with the aberrant races, or species, of chimpanzee, some of which are so gorilla-like that it is by no means easy to determine to which group they really pertain. In height the adult male chimpanzee of the typical form does not exceed 5 ft., and the colour of the hair is a full black, while the skin, especially that of the face, is light-coloured; the ears are remarkably large and prominent, and the hands reach only a short distance below the knees. The head is rounded and short, without prominent beetling ridges above the eyes, or a strong crest along the middle line of the back of the skull; and the tusks of the old males are of no very great length and prominence. Moreover, there is no very marked difference in the size of the two sexes. Gentleness and docility are specially characteristic of the species, even when full-grown; while in the native state its habits are thoroughly arboreal.

In central Africa the chimpanzees assume more or less marked gorilla-like traits. The first of these aberrant types is Schweinfurth's chimpanzee (*Anthropopithecus troglodytes schweinfurthi*), which inhabits the Niam-Niam country, and, although evidently belonging to the same species as the typical race, exhibits certain gorilla-like features. These traits are still more developed in the bald chimpanzee (*A. ischego*) of Loango, the Gabun, and other regions of French Congo, which takes its English name from the sparse covering of hair on the head. The most gorilla-like of all the races is, however, the kulu-kamba chimpanzee (*A. kulu-kamba*) of du Chaillu, which inhabits central Africa. The celebrated ape "Mafuka," which lived in the Dresden zoological gardens during 1875, and came from Loango, was apparently a member of this species, although it was at one time regarded as a hybrid between a chimpanzee and a gorilla. These gorilla-like traits were still more pronounced in "Johanna," a female

chimpanzee living in Barnum & Bailey's show in 1899, which has been described and figured by Dr A. Keith. The heavy ridges over the brow, originally supposed to be distinctive of the gorilla, are particularly well marked in "Johanna," and they would doubtless be still more noticeable in the male of the same race, which seems to be undoubtedly du Chaillu's kulu-kamba. Still the large size and prominence of the ears proclaim that both "Mafuka" and "Johanna" were chimpanzees and not gorillas. A gorilla-like feature in "Johanna" is, however, the presence of large folds at the sides (*ala*) of the nostrils, which are absent in the typical chimpanzee, but in the gorilla extend down to the upper lip. Chimpanzees exhibit great docility in confinement, where, however, they seldom survive for any great length of time. They likewise display a much higher degree of intelligence than any of the other man-like apes. (See PRIMATES.) (R. L. *)

CHINA, a country of eastern Asia, the principal division of the Chinese empire. In addition to China proper the Chinese Empire includes Manchuria, Mongolia, Tibet and Sin-kiang (East Turkestan, Kulja, Dzungaria, &c., *i.e.* all the Chinese dependencies lying between Mongolia on the north and Tibet on the south). Its most southern point is in 18° 50' N.; its most northern in 53° 25' N.; its most western in 74° E., and its most eastern in 135° E. It lies, however, mainly between 20° and 50° N. and 80° and 130° E. It is considerably larger than the whole of Europe. Though its area has not been exactly ascertained the various estimates closely approximate, varying between 4,277,000 and 4,300,000 sq. m. It is bounded N.W., N. and N.E. by Asiatic Russia, along a frontier extending some 6000 m.; E. by Korea and those parts of the Pacific known as the Yellow Sea and China Sea; S. and S.W. by the China Sea, French Indo-China, Upper Burma and the Himalayan states. It is narrowest in the extreme west. Chinese Turkestan along the meridian of Kashgar (76° E.) has a breadth of but 250 m. It rapidly broadens and for the greater part of its area is over 1800 m. across in a direct N. and S. line. Its greatest length is from the N.E. corner of Manchuria to the S.W. confines of Tibet, a distance of 3100 m. in a direct line. Its seaboard, about 5000 m. following the indentations of the coast, is almost wholly in China proper, but the peninsula of Liao-tung and also the western shores of the Gulf of Liao-tung are in Manchuria.

China¹ proper or the Eighteen Provinces (*Shih-pa-shêng*) occupies the south-eastern part of the empire. It is bounded N. by Mongolia, W. by Turkestan and Tibet, S.W. by Burma, S. by Tongking and the gulf of that name, S.E. by the South China Sea, E. by the East China Sea, the Yellow Sea, Gulf of Chih-li and Manchuria. Its area is approximately 1,500,000 sq. m.

This vast country is separated from the rest of continental Asia by lofty tablelands and rugged mountain ranges, which determine the general course—west to east—of its principal rivers. On the north and west the Mongolian and Tibetan tablelands present towards China steep escarpments across which are very few passes. On the S.W. and S., on the borders of Yun-nan, high mountains and deep valleys separate China from Burma and Tongking. On the narrow N.E. frontier the transition from the Manchurian plateau to the alluvial plain of northern China is not abrupt, but, before the advent of railways, Manchuria afforded few and difficult means of access to other regions. Thus China was almost cut off from the rest of the world save by sea routes.

I. THE COUNTRY

Western China consists of highlands often sparsely, and eastern China of lowlands densely peopled. Western China contains the only provinces where the population is under 100 per sq. m. From the Tibetan and Mongolian tablelands project mountain ranges which, ramifying over the western region, enclose elevated level tracts and lower basins and valleys. East of this mountainous region, which extends into central China and covers probably

¹ As to the origin of the names China and Cathay (the medieval name) see below § *History*. According to one theory the name China is of Malay origin, designating originally the region now called Indo-China, but transferred in early times to China proper. By the Chinese the country is often called *Shih-pa-shêng*, "the Eighteen Provinces," from the number of its great territorial divisions. It is also called *Chung-kuo*, "the Middle Kingdom," properly used of the central part of China, and *Hwa-kuo*, "the Flowery Kingdom."

fully half of the kingdom, are, in the north a great alluvial plain and in the south a vast calcareous tableland traversed by hill ranges of moderate elevation (see §§ *Mountains and Geology*). In north-eastern China there is only one mountain system, the group of hills—highest peak 5060 ft.—forming the Shan-tung peninsula. This peninsula was formerly an island, but has been attached to the mainland by the growth of the alluvial plain. Besides the broad division of the country into western and eastern China it may also be considered as divided into three regions by the basins of its chief rivers, the Hwang-ho (Yellow river) in the north, the Yangtze-kiang in the centre, and the Si-kiang (West river) in the south. In the northern provinces of Kan-suh and Shen-si the basins of the Hwang-ho and Yangtze-kiang are separated by a mountain chain with various names—the eastern termination of the Kuen-lun range of central Asia. These mountains, in China, attain, in the Tsing-ling Shan, a maximum elevation of 13,000 ft. East of Shen-si, in Ho-nan the Fu-niu-shan continue the range, but with decreasing elevation, and beyond this the deltaic plain is entered.

The watershed between the Yangtze-kiang and that of the Si-kiang is less clearly marked. It traverses the immense tableland which occupies a great part of the south-west provinces of Yun-nan and Kwei-chow and is continued eastward by the lower tableland of Kwang-si and the Nanshan hills (whose elevation seldom exceeds 6000 ft.). The basin of the Yangtze-kiang forms the whole of central China. Its western border, in Sze-ch'uen and Yun-nan, is wholly mountainous, with heights exceeding 19,000 ft. Central Sze-ch'uen, which is shut in by these mountains on the west, by the Yun-nan and Kwei-chow plateau on the south, by the Kiu-lung range on the north, and by highlands eastward (save for the narrow valley through which the Yangtze-kiang forces its way), is a vast red sandstone tableland of about 1600 ft. elevation. It is exceedingly fertile and supports a dense population. Eastward of Sze-ch'uen the Yangtze valley is studded with lakes. Finally it enters the deltaic plain. The basin of the Si-kiang fills the two southern provinces of Kwang-si and Kwang-tung and contains no very striking orographic features. It may be added that in the extreme S.W. portion of China is part of a fourth drainage area. Here the Mekong, Salween, Song-koi (Red river), &c. flow south to Indo-China.

The Coast.—The coast-line, following all the minor indentations, is reckoned at over 4500 m.; if only the larger inlets and promontories be regarded, the coast-line is about 2150 m. in length. Its shape is that of a semicircle, with its most easterly point midway (30° N.) between its northern and southern extremities. At either end of this semicircular sweep lies a peninsula, and beyond the peninsula a gulf. In the north are the peninsula of Shan-tung and the gulf of Chih-li; in the south the Lien-chow peninsula and the gulf of Tongking. Due south of Lien-chow peninsula, separated from it by a narrow strait, is Hai-nan, the only considerable island of China. From the northern point of the gulf of Chih-li to 30° N., where is Hang-chow bay, the shores are flat and alluvial save where the Shan-tung peninsula juts out. Along this stretch there are few good natural harbours, except at the mouths of rivers and in the Shan-tung promontory; the sea is shallow and has many shoals. The waters bordering the coast of Chih-li are partly frozen in winter; at 10 m. from the shore the water is only 20 ft. deep. The proximity of Peking gives its few ports importance; that of Taku is at the mouth of the Peiho. In Shan-tung, deeply indented on its southern coast, are the ports of Chi-fu, Wei-hai-wai and Tsing-tao (the last in Kiao-chow bay). South of Shan-tung and north of the mouth of the Yangtze huge sandbanks border the coast, with narrow channels between them and the shore. The estuary of the Yangtze is 60 m. across; it contains islands and sandbanks, but there is easy access to Wusung (Shanghai) and other river ports. The bay of Hang-chow, as broad at its entrance as the Yangtze estuary, forms the mouth of the Tsien-tang-kiang. The Chusan and other groups of islands lie across the entrance of the bay.

South of Hang-chow bay the character of the coast alters. In place of the alluvial plain, with flat, sandy and often marshy shores, the coast is generally hilly, often rocky and abrupt; it abounds in small indentations and possesses numerous excellent harbours; in this region are Fu-chow, Amoy, Swatow, Hongkong, Macao, Canton and other well-known ports. The whole of this coast is bordered by small islands. Formosa lies opposite the S.E. coast, the channel between it and Fu-kien province being about 100 m. wide. Formosa protects the neighbouring regions of China from the typhoons experienced farther north and farther south.

Surface.—As already indicated, one of the most noticeable features in the surface of China is the immense deltaic plain in the north-

eastern portion of the country, which, curving round the mountainous districts of Shan-tung, extends for about 700 m. in a southerly direction from the neighbourhood of Peking and varies from 150 to 500 m. in breadth. This plain is the delta of the Yellow river and, to some extent, that of the Yangtze-kiang also. Beginning in the prefecture of Yung-p'ing Fu, in the province of Chih-li, its outer limit passes in a westerly direction as far as Ch'ang-p'ing Chow, north-west of Peking. Thence running a south-south-westerly course it passes westward of Ch'eng-ting Fu and Kwang-p'ing Fu till it reaches the upper waters of the Wei river in Ho-nan. From this point it turns westward and crosses the Hwang-ho or Yellow river in the prefecture of Hwai-k'ing. Leaving this river it takes a course a little to the east of south, and passing west of Ju-ning Fu, in the province of Ho-nan, it turns in a more easterly direction as far as Luchow Fu. From this prefecture an arm of the plain, in which lies the Chao Lake, stretches southward from the Hwai river to the Yangtze-kiang, and trending eastward occupies the region between that river and Hangchow Bay. To the north of this arm rises a hilly district, in the centre of which stands Nanking. The greater part of this vast plain descends very gently towards the sea, and is generally below the level of the Yellow river, hence the disastrous inundations which so often accompany the rise of that river. Owing to the great quantity of soil which is brought down by the waters of the Yellow river, and to the absence of oceanic currents, this delta is rapidly increasing and the adjoining seas are as rapidly becoming shallower. As an instance, it is said that the town of P'utai was one Chinese mile¹ west of the seashore in the year 200 B.C., and in 1730 it was 140 m. inland, thus giving a yearly encroachment upon the sea of about 100 ft. Again, Sienshwuy-kow on the Peiho was on the seashore in A.D. 500, and it is now about 18 m. inland.

Some of the ranges connected with the mountain system of central Asia which enter the western provinces of China have been mentioned above, others may be indicated here. In the eastern portion of Tibet the Kuen-lun range throws off a number of branches, which spread first of all in a south-easterly direction and eventually take a north and south course, partly in the provinces of Sze-ch'uen and Yun-nan, where they divide the beds of the rivers which flow into Siam and French Indo-China, as well as the principal northern tributaries of the Yangtze-kiang. In the north-west, traversing the western portion of the province of Kan-suh, are parallel ranges running N.W. and S.E. and forming a prolongation of the northern Tibetan mountains. They are known as the Lung-shan, Richthofen and Nan-shan, and join on the south-east the Kuen-lun range. The Richthofen range (locally called Tien-shan, or Celestial Mountains) attains elevations of over 20,000 ft. Several of its peaks are snowclad, and there are many glaciers. Forming the northern frontier of the province of Sze-ch'uen run the Min-shan and the Kiu-lung (or Po-m'eng) ranges, which, entering China in 102° E., extend in a general easterly course as far as 112° E. in the province of Hu-peh. These ranges have an average elevation of 8000 and 11,000 ft. respectively. In the south a number of parallel ranges spread from the Yun-nan plateau in an easterly direction as far as the province of Kwang-tung. Then turning north-eastward they run in lines often parallel with the coast, and cover large areas of the provinces of Fu-kien, Kiang-si, Ch'eh-kiang, Hu-nan and southern Ngan-hui, until they reach the Yangtze-kiang; the valley of that river from the Tung-ting Lake to Chinking Fu forming their northern boundary. In Fu-kien these hills attain the character of a true mountain range with heights of from 6500 to nearly 10,000 ft. Besides the chief ranges there are the Tai-hang Mountains in Shan-si, and many others, among which may be mentioned the ranges—part of the escarpment of the Mongolian plateau—which form the northern frontier of Chih-li. Here the highest peak is Ta-kuang-ting-tzu (6500 ft.), about 300 m. N.N.E. of Peking and immediately north of Wei Ch'ang (the imperial hunting grounds).

Rivers and Canals.—The rivers of China are very numerous and there are many canals. In the north the rivers are only navigable by small craft; elsewhere they form some of the most frequented highways in the country. The two largest rivers, the Yangtze-kiang and the Hwang-ho (Yellow river), are separately noticed. The Hwang-ho (length about 2400 m.) has only one important tributary in China, the Wei-ho, which rises in Kan-suh and flows through the centre of Shen-si. Below the confluence the Hwang-ho enters the plains. According to the Chinese records this portion of the river has changed its course nine times during 2500 years, and has emptied itself into the sea at different mouths, the most northerly of which is represented as having been in about 39° N., or in the neighbourhood of the present mouth of the Peiho, and the most southerly being that which existed before the change in 1851–1853, in 34° N. Owing to its small value as a navigable highway and to its propensity to inundate the regions in its neighbourhood, there are no considerable towns on its lower course.

The Yangtze-kiang is the chief waterway of China. The river, flowing through the centre of the country, after a course of 2900 m., empties itself into the Yellow Sea in about 31° N. Unlike the Yellow river, the Yangtze-kiang is dotted along its navigable portions with many rich and populous cities, among which are Nanking, An-ch'ing (Ngank'ing), Kiu-kiang, Hankow and I-ch'ang.

¹ A Chinese mile, *li*, or *le* = 0.36 English mile.

From its mouth to I-ch'ang, about 1000 m., the river is navigable by large steamers. Above this last-named city the navigation becomes impossible for any but light native craft or foreign vessels specially constructed for the navigation, by reason of the rapids which occur at frequent intervals in the deep mountain gorges through which the river runs between Kwei-chow and I-ch'ang. Above Kwei-chow it receives from the north many tributaries, notably the Min, which water the low tableland of central Sze-ch'uen. The main river itself has in this province a considerable navigable stretch, while below I-ch'ang it receives the waters of numerous navigable affluents. The Yangtze system is thus all important in the economic and commercial development of China.

Perhaps the most remarkable of the affluents of the Yangtze is the Han-kiang or Han river. It rises in the Po-mêng mountains to the north of the city of Ning-kiang Chow in Shen-si. Taking a generally easterly course from its source as far as Fan-cheng, it from that point takes a more southerly direction and empties itself into the Yangtze-kiang at Han-kow, "the mouth of the Han." Here it is only 200 ft. wide, while higher up it widens to 2600 ft. It is navigable by steamers for 300 m. The summer high-water line is for a great part of its course, from I-ch'eng Hien to Han-kow, above the level of its banks. Near Sien-t'ao-chên the elevation of the plain above low water is no more than 1 ft., and in summer the river rises about 26 ft. above its lowest level. To protect themselves against inundations the natives have here, as elsewhere, thrown up high embankments on both sides of the river, but at a distance from the natural banks of about 50 to 100 ft. This intervening space is flooded every year, and by the action of the water new layers of sand and soil are deposited every summer, thus strengthening the embankments from season to season.

The Hwai-ho is a large river of east central China flowing between the Hwang-ho and the Yangtze-kiang. The Hwai-ho and its numerous affluents (it is said to have 72 tributaries) rise in Ho-nan. The main river flows through the centre of Ngan-hui, in which province it receives from the N.W. the Sha-ho, Fei-ho and other important affluents. Formerly it received through the Sha-ho part of the waters of the Hwang-ho. The Hwai-ho flows into the Hungtso lake, through which it feeds the Grand Canal, not far from the old course of the Hwang-ho, and probably at one time joined that river not far from its mouth. It has a length of about 800 m. and is navigable from the point where it leaves the hill country of Ho-nan to Lake Hungtso. It is subject to violent floods, which inundate the surrounding country for a distance of 10 to 20 m. Many of its tributaries are also navigable for considerable distances.

Next in importance to the Yangtze-kiang as a water highway is the Yun-ho, or, as it is generally known in Europe, the Grand Canal.

This magnificent artificial river reaches from Hang-chow Fu in the province of Cheh-kiang to Tientsin in Chih-li, where it unites with the Peiho, and thus may be said to extend to Tung-chow in the neighbourhood of Peking. According to the itineraries published by Père Gandar, the total length of the canal is 3630 li, or about 1200 m. A rough measurement, taking account only of the main bends of the canal, makes its length 850 m. After leaving Hang-chow the canal passes round the eastern border of the Tai-hu or Great Lake, surrounding in its course the beautiful city of Su-chow, and then trends in a generally north-westerly direction through the fertile districts of Kiang-su as far as Chin-kiang on the Yangtze-kiang. In this, the southern section, the slope is gentle and water is plentiful (from 7 ft. at low water to 11 ft., and occasionally 13 ft. at high water). Between Su-chow and Chin-kiang the canal is often over 100 ft. wide, and its sides are in many places faced with stone. It is spanned by fine stone bridges, and near its banks are many memorial arches and lofty pagodas. In the central portion of the canal, that is between Chin-kiang and Tsing-kiang-pu, at which latter place it crosses the dry channel which marks the course of the Yellow river before 1852, the current is strong and difficult to ascend in the upward (northern) journey. This part of the canal skirts several lakes and is fed by the Hwai-ho as it issues from the Hungtso lake. The country lying west of the canal is higher than its bed; while the country east is lower than the canal. The two regions are known respectively as Shang-ho (above the river) and Ssia-ho (below the river). Waste weirs opening on the Ssia-ho (one of the great rice-producing areas of China) discharge the surplus water in flood seasons. The northern and considerably the longest section of the canal extends from the old bed of the Yellow river to Tientsin. It largely utilizes existing rivers and follows their original windings. Between Tsing-kiang-pu and the present course of the Yellow river the canal trends N.N.W., skirting the highlands of Shan-tung. In this region it passes through a series of lagoons, which in summer form one lake—Chow-yang. North of that lake on the east bank of the canal is the city of Tsi-ning-chow. About 25 m. N. of that city the highest level of the canal is reached at the town of Nan Wang. Here the river Wen enters the canal from the east, and about 30 m. farther N. the Yellow river is reached. On the west side of the canal, at the point where the Yellow river now cuts across it, there is laid down in Chinese maps of the 18th century a dry channel which is described as being that once followed by the Yellow river, *i.e.* before it took the channel it abandoned in 1851-1853. The passage of the Yellow river to the part of the canal lying north of that stream is difficult, and can only be effected at

certain levels of the river. Frequently the waters of the river are either too low or the current is too strong to permit a passage. Leaving this point the canal passes through a well-wooded and hilly country west of Tung-p'ing Chow and east of Tung-ch'ang Fu. At Lin-ching Chow it is joined at right angles by the Wei river in the midst of the city. Up to this point, *i.e.* from Tsing-kiang-pu to Lin-ching Chow, a distance of over 300 m., navigation is difficult and the water-supply often insufficient. The differences of level, 20 to 30 ft., are provided for by barrages over which the boats—having discharged their cargo—are hauled by windlasses. Below the junction with the Wei the canal borrows the channel of the river and again becomes easily navigable. Crossing the frontier into Chih-li, between Te Chow and Tsang Chow, which it passes to the west, it joins the Peiho at Tientsin, after having received the waters of the Keto river in the neighbourhood of Tsing Hien.¹

The most ancient part of the canal is the section between the Yangtze and the Hwai-ho. This part is thought, on the strength of a passage in one of the books of Confucius, to have been built *c.* 486 B.C. It was repaired and enlarged in the 3rd century A.D. The southern part, between the Yangtze and Hang-chow, was built early in the 7th century A.D. The northern part is stated to have been constructed in the three years 1280-1283. The northern portion of the canal is now of little use as a means of communication between north and south.² It is badly built, neglected and charged with the mud-laden waters of the Yellow river. The "tribute fleet" bearing rice to Peking still uses this route; but the rice is now largely forwarded by sea. The central and southern portions of the canal are very largely used.

The Peiho (length about 350 m.) is of importance as being the high waterway to Peking. Taking its rise in the Si-shan, or Western Mountains, beyond Peking, it passes the city of T'sung-chow, the port of Peking, and Tientsin, where it meets the waters of the Hun-ho and empties itself into the gulf of Chih-li at the village of Taku. The Peiho is navigable for small steamers as far as Tientsin during the greater part of the year, but from the end of November to the beginning of March it is frozen up.

In the southern provinces the Si-kiang, or Western river, is the most considerable. It has a length of over 1000 m. This river takes its rise in the prefecture of Kwang-nan Fu in Yun-nan, whence it reaches the frontier of Kwang-si at a distance of about 90 li from its source. Then trending in a north-easterly direction it forms the boundary between the two provinces for about 150 li. From this point it takes a generally south-easterly course, passing the cities of Tsien Chow, Fung-e Chow, Shang-lin Hien, Lung-ngan Hien, Yung-kang Chow and Nan-ning Fu to Yung-shan Hien. Here it makes a bend to the north-east, and continues this general direction as far as Sin-chow Fu, a distance of 800 li, where it meets and joins the waters of the Kien-kiang from the north. Its course is then easterly, and after passing Wu-chow Fu it crosses the frontier into Kwang-tung. In this part of its course it flows through a gorge 3 m. long and in places but 270 yds. in width. Both above and below this gorge it is 1 m. wide. Some 30 m. above Canton it divides into two main and several small branches. The northern branch, called Chu-kiang, or Pearl river, flows past Fat-shan and Canton and reaches the sea through the estuary called the Bocca Tigris or Bogue, at the mouth of which is the island of Hong-Kong. The southern branch, which retains the name of Si-kiang, reaches the sea west of Macao. Near the head of its delta the Si-kiang receives the Pei-kiang, a considerable river which flows through Kwang-tung in a general N. to S. direction. Like the Yangtze-kiang the Si-kiang is known by various names in different parts of its course. From its source to Nan-ning Fu in Kwang-si it is called the Si-yang-kiang, or river of the Western Ocean; from Nan-ning Fu to Sin-chow Fu it is known as the Yu-kiang, or the Bending river; and over the remainder of its course it is recognized by the name of the Si-kiang, or Western river. The Si-kiang is navigable as far as Shao-king, 130 m., for vessels not drawing more than 15 ft. of water, and vessels of a light draught may easily reach Wu-chow Fu, in Kwang-si, which is situated 75 m. farther up. In winter the navigation is difficult above Wu-chow Fu. Above that place there is a rapid at low water, but navigation is possible to beyond Nan-ning Fu.

Lakes.—There are numerous lakes in the central provinces of China. The largest of these is the Tung-t'ing in Hu-nan, which, according to the Chinese geographers, is upwards of 800 li, or 266 m., in circumference. In native gazetteers its various portions are known under distinct names; thus it is said to include the Ts'ing-ts'ao, or Green Grass Lake; the Ung, or Venerable Lake; the Chih-sha, or Red Sand Lake; the Hwang-yih, or Imperial Post-house Lake; the Ngan-nan, or Peaceful Southern Lake; and the Ta-tung, or

¹ For the Grand Canal the chief authority is Dominique Gandar, S.J., "Le Canal Impérial. Étude historique et descriptive," *Variétés sinologiques* No. 4 (Shanghai, 1903); see also Stenz, "Der Kaiserkanal," in *Beiträgen zur Kolonialpolitik*, Band v. (Berlin, 1903-1904), and the works of Ney Elias, Sir J. F. Davis, A. Williamson, E. H. Parker and W. R. Carles.

² Nevertheless there is considerable local traffic. The transit trade with Shan-tung, passing the Chin-kiang customs and using some 250 m. of the worst part of the canal, was valued in 1905 at 3,331,000 taels.

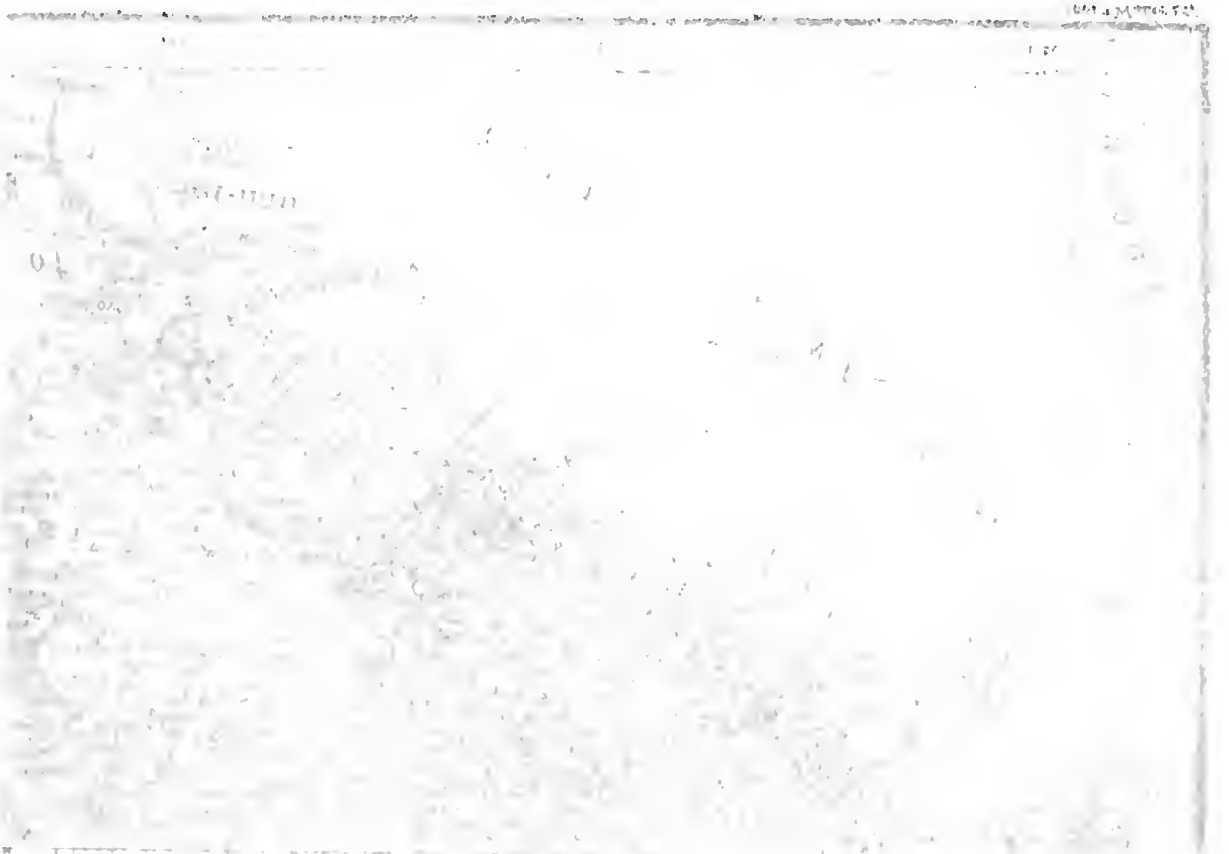
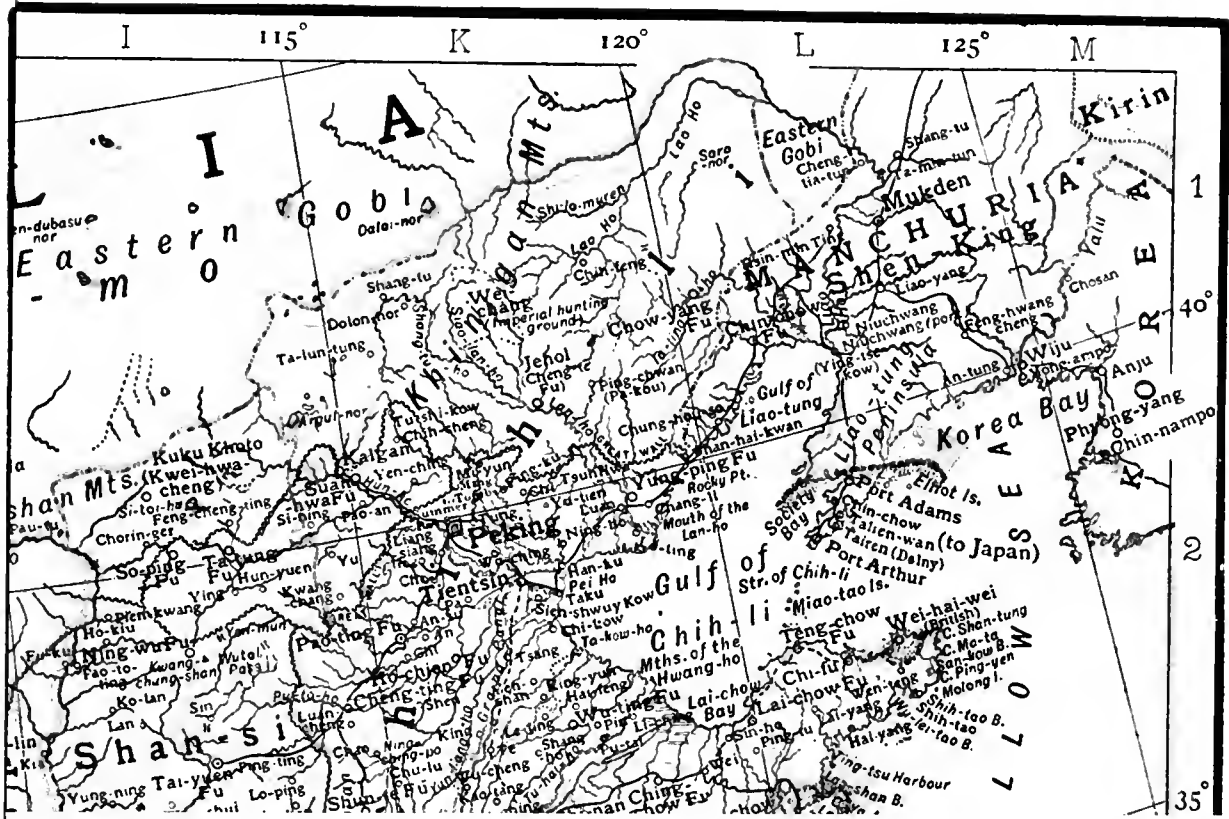



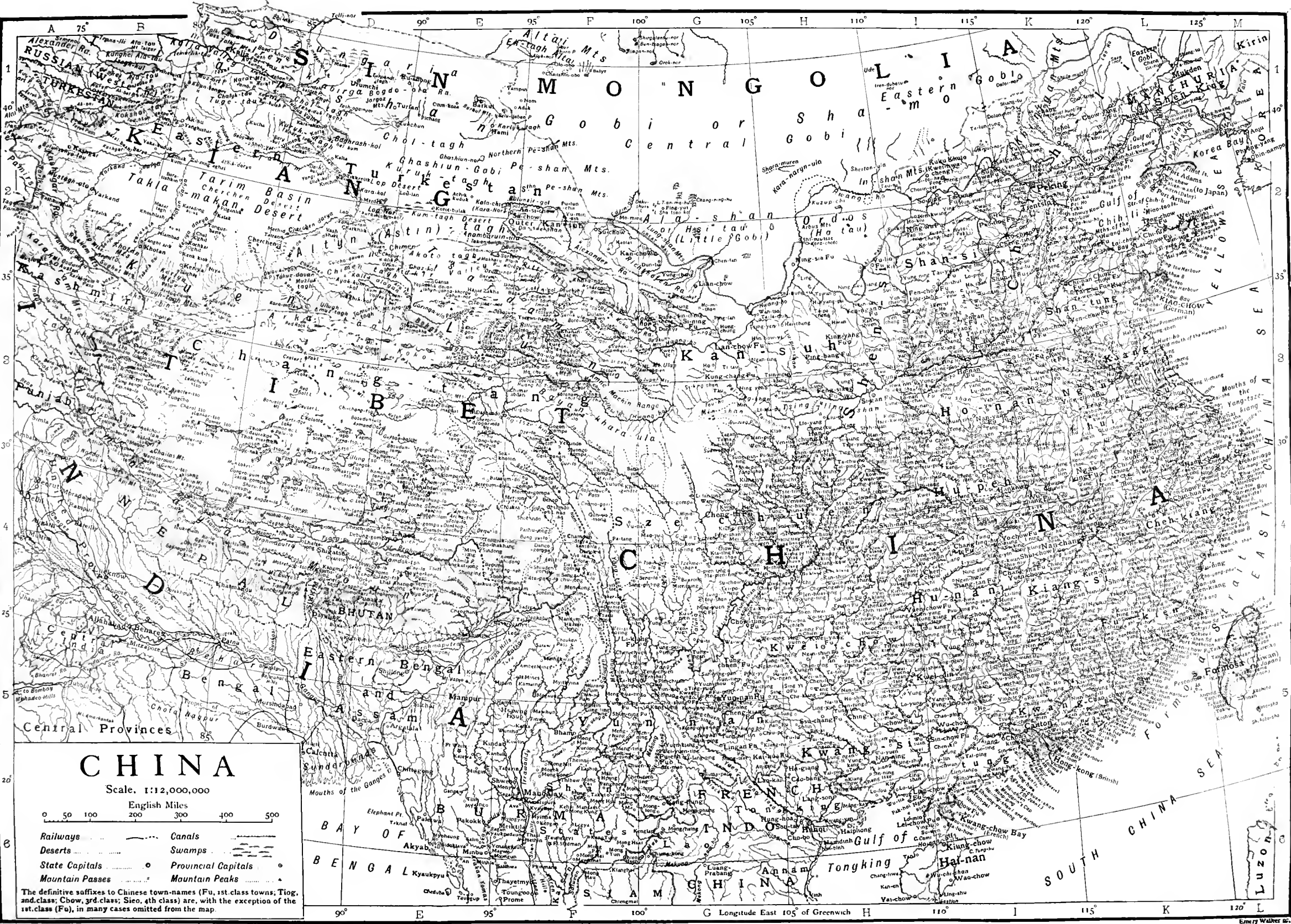

CHINA

Scale: 1:12,000,000

- English Miles
 0 50 100 200 300 400 500
- Railways ————
 - Deserts
 - State Capitals
 - Mountain Passes
 - Canals ————
 - Swamps
 - Provincial Capitals
 - Mountain Peaks

The definitive suffixes to Chinese town-names (Fu, 1st class towns; Tiog, 2nd class; Chow, 3rd class; Siao, 4th class) are, with the exception of the 1st class (Fo), in many cases omitted from the map.



Great Deep Lake. In ancient times it went by the name of the Kiu-kiang Hu, or Lake of the Nine Rivers, from the fact that nine rivers flowed into it. Its chief affluents are the Siang-kiang, which rises in the highlands in the north of Kwang-si and flows in a general N.N.E. direction, and the Yuen-kiang, which flows N. and then E. from the eastern border of Kwei-chow. The lake is connected with the Yangtze-kiang by two canals, the Taping and the Yochow Fu. In summer it is fed by the overflow from the Yangtze-kiang; in winter it pours its waters into that river through the Yochow Fu canal. During the winter and spring the water of the lake is so low that the shallow portions become islands, separated by rivers such as the Siang and Yuen, and numberless streams; but in summer, owing to the rise in the waters of the Yangtze-kiang, the whole basin of the lake is filled. It is then about 75 m. long and 60 m. broad. About 180 m. E. of the Tung-t'ing lake is the Poyang lake, which occupies the low-lying part of the province of Kiang-si, and is connected with the Yangtze by the Hu-kow canal. The Poyang lake is also subject to a wide difference between high and low water, but not quite to the same extent as the Tung-t'ing lake, and its landmarks are more distinctly defined. It is about 90 m. long by 20 broad. The T'ai lake, in the neighbourhood of Su-chow Fu, is also celebrated for its size and the beauty of its surroundings. It is about 150 m. in circumference, and is dotted over with islands, on which are built temples for the devotees of religion, and summer-houses for the votaries of pleasure from the rich and voluptuous cities of Hang-chow and Su-chow. The boundary line between the provinces of Cheh-kiang and Kiang-su crosses its blue waters, and its shores are divided among thirteen prefectures. Besides these lakes there are, among others, two in Yun-nan, the Kun-yang-hai (Tien-chi) near Yun-nan Fu, which is 40 m. long and is connected with the Yangtze-kiang by the Pu-to river, and the Erh-hai (Urh-hai) to the east of the city of Tali.

The Great Wall.—Along the northern provinces of Chih-li, Shan-si, Shen-si and Kan-suh, over 22° of longitude (98° to 120° E.), stretches the Great Wall of China, built to defend the country against foreign aggression. It was begun in the 3rd century B.C., was repaired in the 15th century, and in the 16th century was extended by 300 m. Following the windings the wall is 1500 m. long. Starting near the seashore¹ at Shan-hai-kwan on the gulf of Liao-tung, where the Chinese and Manchurian frontiers meet, it goes eastward past Peking (which is about 35 m. to the south) and then trends S. and E. across Shan-si to the Hwang-ho. From the neighbourhood of Peking to the Hwang-ho there is an inner and an outer wall. The outer (northern) wall passes through Kalgan, thus guarding the pass into Mongolia. A branch wall separates the greater part of the western frontier of Chih-li from Shan-si. West of the Hwang-ho the Great Wall forms the northern frontier of Shen-si, and west of Shen-si it keeps near the northern frontier of Kan-suh, following for some distance in that province the north bank of the Hwang-ho. It ends at Kiayu-kwan (98° 14' E.) just west of Su-chow. This part of the wall was built to protect the one main artery leading from central Asia to China through Kan-suh and Shen-si by the valley of the Wei-ho, tributary of the Hwang-ho. There is a branch wall in Kan-suh running west and south to protect the Tibetan frontier. The height of the wall is generally from 20 to 30 ft., and at intervals of some 200 yds. are towers about 40 ft. high. Its base is from 15 to 25 ft. thick and its summit 12 ft. wide. The wall is carried over valleys and mountains, and in places is over 4000 ft. above sea-level. Military posts are still maintained at the chief gates or passes—at Shan-hai-kwan, the Kalgan pass, the Yenmun pass (at the N. of Shan-si) and the Kaiyu pass in the extreme west, through which runs the caravan route to Barkal in Turkestan. Colonel A. W. S. Wingate, who in the opening years of the 20th century visited the Great Wall at over twenty places widely apart and gathered many descriptions of it in other places, states that its position is wrongly shown "on the maps of the day" (1907) in a number of places; while in others it had ceased to exist, "the only places where it forms a substantial boundary being in the valley bottoms, on the passes and where it crosses main routes. These remarks apply with particular force to the branch running south-west from the Nan-k'ow pass and forming the boundary of Chih-li and Shan-si provinces." In Colonel Wingate's opinion the wall was originally built by degrees and in sections, not of hewn stone, but of round boulders and earth, the different sections being repaired as they fell into ruin. "Only in the valley bottoms and on the passes was it composed of masonry or brickwork. The Mings rebuilt of solid masonry all those sections through which led a likely road for invading Tatars to follow, or where it could be seen at a distance from the sky-line." The building of the wall "was a sufficiently simple affair," not to be compared with the task of building the pyramids of Egypt.²

¹ The portion of the wall which abutted on to the sea has been destroyed.

² See the *Geog. Jnl.* (Feb. and March 1907). For a popular account of the wall, with numerous photographs, see *The Great Wall of China* (London, 1909), by W. E. Giel, who in 1908 followed its course from east to west. Consult also A. Williamson, *Journey in North China* (London, 1870); Martin, "La Grande Muraille de la Chine," *Revue scientifique* (1891).

Climate—The climate over so vast an area as China necessarily varies greatly. The southern parts of Yun-nan, Kwang-si and Kwang-tung (including the city of Canton) lie within the tropics. The northern zone (in which lies Peking) by contrast has a climate which resembles that of northern Europe, with winters of Arctic severity. The central zone (in which Shanghai is situated) has a generally temperate climate. But over both northern and central China the influence of the great plateau of Mongolia tends to establish uniform conditions unusual in so large an area. The prevailing winds during summer—the rainy season—are south-easterly, caused by heat and the ascending current of air over the sandy deserts of central Asia, thus drawing in a current from the Pacific Ocean. In the winter the converse takes place, and the prevailing winds, descending from the Mongolian plateau, are north and north-west, and are cold and dry. From October to May the climate of central China is bracing and enjoyable. The rainfall is moderate and regular.

In northern China the inequalities both of temperature and rainfall are greater than in the central provinces. In the province of Chih-li, for example, the heat of summer is as intense as is the cold of winter. In summer the rains often render the plain swampy, while the dry persistent westerly winds of spring create dust storms (experienced in Peking from March to June). The rainfall is, however, uncertain, and thus the harvests are precarious. The provinces of Shan-tung and Shan-si are peculiarly liable to prolonged periods of drought, with consequent severe famines such as that of 1877-1878, when many millions died. In these regions the air is generally extremely dry, and the daily variations of temperature consequent on excessive radiation are much greater than farther south.

Accurate statistics both of heat and rainfall are available from a few stations only. The rainfall on the southern coasts is said to be about 100 in. yearly; at Peking the rainfall is about 24 in. a year. In the coast regions the temperatures of Peking, Shanghai and Canton may be taken as typical of those of the northern, central and southern zones. In Peking (39° N.) the mean annual temperature is about 53° F., the mean for January 23°, for July 79°. In Shanghai (31° 11' N.) the mean annual temperature is 59°, the mean for January 36·2°, for July 80·4°. In Canton (23° 15' N.) the mean annual temperature is 70°, the mean for January 54°, for July 82°. The range of temperature, even within the tropics, is noteworthy. At Peking and Tientsin the thermometer in winter falls sometimes to 5° below zero and rises in summer to 105° (at Taku 107° has been recorded); in Shanghai in winter the thermometer falls to 18° and in summer rises to 102°. In Canton frost is said to have been recorded, but according to the *China Sea Directory* the extreme range is from 38° to 100°. The climate of Shanghai, which resembles, but is not so good as, that of the Yangtze-kiang valley generally, is fairly healthy, but there is an almost constant excess of moisture. The summer months, July to September, are very hot, while snow usually falls in December and January.

At Canton and along the south coast the hot season corresponds with the S.W. monsoon; the cool season—mid October to end of April—with the N.E. monsoon. Farther north, at Shanghai, the S.W. monsoon is sufficiently felt to make the prevailing wind in summer southerly.

Provinces.—China proper is divided into the following provinces: Cheh-kiang, Chih-li, Fu-kien, Ngan-hui (An-hui), Ho-nan, Hu-nan, Hu-peh, Kan-suh, Kiang-si, Kiang-su, Kwang-si, Kwang-tung, Kwei-chow, Shan-si, Shan-tung, Shen-si, Sze-ch'uen and Yun-nan. See the separate notices of each province and the article on Shêng-king, the southern province of Manchuria. X.

Geology.

The Palaeozoic formations of China, excepting only the upper part of the Carboniferous system, are marine, while the Mesozoic and Tertiary deposits are estuarine and freshwater or else of terrestrial origin. From the close of the Palaeozoic period down to the present day the greater part of the empire has been dry land, and it is only in the southern portion of Tibet and in the western Tian Shan that any evidence of a Mesozoic sea has yet been found. The geological sequence may be summarized as follows:—

Archean.—Gneiss, crystalline schists, phyllites, crystalline limestones. Exposed in Liao-tung, Shan-tung, Shan-si, northern Chih-li and in the axis of the mountain ranges, e.g. the Kuen-lun and the ranges of southern China.

Sinian.—Sandstones, quartzites, limestones. Sometimes rests unconformably upon the folded rocks of the Archean system; but sometimes, according to Lóczy, there is no unconformity. Covers a large area in the northern part of China proper; absent in the eastern Kuen-lun; occurs again in the ranges of S.E. China. In Liao-tung Cambrian fossils have been found near the summit of the series; they belong to the oldest fauna known upon the earth, the fauna of the *Olenellus* zone. It is, however, not improbable that in many places beds of considerably later date have been included in the Sinian system.

³ For Shanghai the figures are compiled from twenty-six years' observations. See *China Sea Directory*, vol. iii. (4th ed., 1904) p. 660.

⁴ The thermometer registered 23° F. in January 1893, on the river 28 m. below Canton. This is the lowest reading known. *Ibid.* pp. 104-105.

Ordovician.—Ordovician fossils have been found in the Lung-shan, Kiang-su (about 50 m. east of Nan-king), in the south-west of Cheh-kiang and in the south-east of Yun-nan. Ordovician beds probably occur also in the Kuen-lun.

Silurian.—Limestones and slates with Silurian corals and other fossils have been found in Sze-ch'uen.

Devonian.—Found in Kan-suh and in the Tsing-ling-shan, but becomes much more important in southern China. Occurs also on the south of the Tian-shan, in the Altyn-tagh, the Nan-shan and the western Kuen-lun.

Carboniferous.—Covers a large area in northern China, in the plateau of Shen-si and Shan-si, extending westwards in tongues between the folds of the Kuen-lun. In this region it consists of a lower series of limestones and an upper series of sandstones with seams of coal, which may perhaps be in part of Permian age. This is probably the most extensive coalfield in the world.

In south China the whole series consists chiefly of limestones, and the coal seams are comparatively unimportant. Carboniferous beds are also found in the Tian-shan, the Nan-shan, Kan-suh, on the southern borders of the Gobi, &c.

Mesozoic.—Marine Triassic beds containing fossils similar to those of the German Muschelkalk have been found by Lóczy near Chung-tien, on the eastern border of the Tibetan plateau. Elsewhere, however, the Mesozoic is represented chiefly by a red sandstone, which covers the greater part of Sze-ch'uen and fills also a number of troughs amongst the older beds of southern China. No marine fossils are found in this sandstone, but remains of plants are numerous, and these belong to the Rhaetic, Lias and Lower Oolite. No Cretaceous beds are known in China excepting in S. Tibet (on the shores of the 'Tengri-nor) and in the western portion of the Tian-shan.

Cainozoic and Recent.—No marine deposits of this age are known. Although the loess of the great plain and the sand of the desert are still in process of formation, the accumulation of these deposits probably began in the Tertiary period.

Volcanic Rocks.—Amongst the Archean rocks granitic and other intrusions are abundant, but of more modern volcanic activity the remains are comparatively scanty. In south China there is no evidence of Tertiary or Post-Tertiary volcanoes, but groups of volcanic cones occur in the great plain of north China. In the Liao-tung and Shan-tung peninsulas there are basaltic plateaus, and similar outpourings occur upon the borders of Mongolia. All these outbursts appear to be of Tertiary or later date.

Loess.—One of the most characteristic deposits of China is the loess, which not merely imparts to north China the physical character of the scenery, but also determines the agricultural products, the transport, and general economic life of the people of that part of the country. It is peculiar to north China and it is not found south of the Yangtze. The loess is a solid but friable earth of brownish-yellow colour, and when triturated with water is not unlike loam, but differs from the latter by its highly porous and tubular structure. The loess soil is extremely favourable to agriculture. (See LOESS and *infra*, § Agriculture.)

The loess is called by the Chinese *Hwang-t'u*, or yellow earth, and it has been suggested that the imperial title *Hwang-ti*, Yellow Emperor or Ruler of the Yellow, had its origin in the fact that the emperor is lord of the loess or yellow earth.

Structurally, China proper may be divided into two regions, separated from each other by the folded range of the Tsing-ling-shan, which is a continuation of the folded belt of the

Structure. Kuen-lun. North of this chain the Palaeozoic beds are in general nearly horizontal, and the limestones and sandstones of the Sinian and Carboniferous systems form an extensive plateau which rises abruptly from the western margin of the great plain of northern China. The plateau is deeply carved by the rivers which flow through it; and the strata are often faulted, but they are never sharply folded. South of the Tsing-ling-shan, on the other hand, the Palaeozoic beds are thrown into a series of folds running from W. 30° S. to E. 30° N., which form the hilly region of southern China. Towards Tongking these folds probably bend southwards and join the folds of Further India. Amongst these folded beds lie trough-like depressions filled with the Mesozoic red sandstone which lies unconformably upon the Palaeozoic rocks.

The present configuration of China is due, in a very considerable degree, to faulting. The abrupt eastern edge of the Shan-si plateau, where it overlooks the great plain, is a line of fault, or rather a series of step faults, with the downthrow on the east; and von Richthofen has shown reason to believe that this line of faulting is continued far to the south and to the north. He believed also that the present coast-line of China has to a large extent been determined by similar faults with their downthrow on the east.

Concerning the structure of the central Asian plateau our knowledge is still incomplete. The great mountain chains, the Kuen-lun, the Nan-shan and the Tian-shan, are belts of folding; but the Mongolian Altai is a horst—a strip of ancient rock lying between two faults and with a depressed area upon each side. In the whole of this northern region faulting, as distinct from folding, seems to have played an important part. Along the southern margin of the Tian-shan there is a remarkable trough-like depression which appears to lie between two approximately parallel faults. (P. LA.)

Fauna.

China lies within two zoological provinces or regions, its southern portion forming a part of the Oriental or Indian region and having a fauna close akin to that of the western Himalaya, Burma and Siam, whereas the districts to the north of Fu-chow and south of the Yangtze-kiang lie within the eastern Holarctic (Palaeartic) region, or rather the southern fringe of the latter, which has been separated as the Mediterranean transitional region. Of these two divisions of the Chinese fauna, the northern one is the more interesting, since it forms the chief home of a number of peculiar generic types, and also includes types represented elsewhere at the present day (exclusive in one case of Japan) only in North America. The occurrence in China of these types common to the eastern and western hemispheres is important in regard to the former existence of a land-bridge between Eastern Asia and North America by way of Bering Strait.

Of the types peculiar to China and North America the alligator of the Yangtze-kiang is generically identical with its Mississippi relative. The spoon-beaked sturgeon of the Yangtze and Hwang-ho is, however, now separated, as *Psephurus*, from the closely allied American *Polyodon*. Among insectivorous mammals the Chinese and Japanese shrew-moles, respectively forming the genera *Uropsilus* and *Urotrichus*, are represented in America by *Neurotrichus*. The giant salamander of the rivers of China and Japan and the Chinese mandarin duck are by some included in the same genera as their American representatives, while by others they are referred to genera apart. Whichever view we take does not alter their close relationship. One wapiti occurs on the Tibetan frontier, and others in Manchuria and Amurland.

As regards mammals and birds, the largest number of generic and specific types peculiar to China are met with in Sze-ch'uen. Foremost among these is the great panda (*Aelurapus melanoleucus*), representing a genus by itself, probably related to bears and to the true panda (*Aclurus*), the latter of which has a local race in Sze-ch'uen. Next come the snub-nosed monkeys (*Rhinopithecus*), of which the typical species is a native of Sze-ch'uen, while a second is found on the upper Mekong, and a third in the mountains of central China. In the Insectivora the swimming-shrew (*Nectogale*) forms another generic type peculiar to Sze-ch'uen, which is also the sole habitat of the mole-like *Scaptochirus*, of *Uropsilus*, near akin to the Japanese *Urotrichus*, of *Scaptonyx*, which connects the latter with the moles (*Talpa*), and of *Neotetracus*, a relative of the Malay rat-shrews (*Gymnura*). Here also may be mentioned the raccoon-dog, forming the subgenus *Nyctereutes*, common to China and Japan. The Himalayan black and the Malay bear have each a local race in Sze-ch'uen, where the long-haired Fontanier's cat (*Felis tristis*) and the Tibet cat (*F. scripta*) connect Indo-Malay species with the American ocelots, while the bay cat (*F. temminckii*), a Malay type, is represented by local forms in Sze-ch'uen and Fu-chow. The Amurland leopard and Manchurian tiger likewise constitute local races of their respective species.

Among ruminants, the Sze-ch'uen takin represents a genus (*Budorcas*) found elsewhere in the Mishmi Hills and Bhutan, while serows (*Nemorhaedus*) and gorals (*Urotragus*), allied to Himalayan and Burmo-Malay types, abound. The Himalayan fauna is also represented by a race of the Kashmir hangul deer. Of other deer, the original habitat of Père David's milu (*Elaphurus*), formerly kept in the Peking park, is unknown. The sika group, which is peculiar to China, Japan and Formosa, is represented by *Cervus hortulorum* in Manchuria and the smaller *C. manchuricus* and *sika* in that province and the Yangtze valley; while musk-deer (*Moschus*) abound in Kan-suh and Sze-ch'uen. The small water-deer (*Hydropotes* or *Hydrelaphus*) of the Yangtze valley represents a genus peculiar to the country, as do the three species of tufted deer (*Elaphodus*), whose united range extends from Sze-ch'uen to Ning-po and I-ch'ang. Muntjacs (*Cervulus*) are likewise very characteristic of the country, to which the white-tailed, plum-coloured species, like the Tenasserim *C. crinifrons*, are peculiar. The occurrence of races of the wapiti in Manchuria and Amurland has been already mentioned.

To refer in detail to the numerous forms of rodents inhabiting China is impossible here, and it must suffice to mention that the flying-squirrels (*Pteromys*) are represented by a large and handsome species in Sze-ch'uen, where is also found the largest kind of bamboo-rat (*Rhizomys*), the other species of which are natives of the western Himalaya and the Malay countries. Dwarf hamsters of the genus *Cricetulus* are natives of the northern provinces. In the extreme south, in Hai-nan, is found a gibbon ape (*Hylobates*), while langur (*Semnopithecus*) and macaque monkeys (*Macacus*) likewise occur in the south, one of the latter also inhabiting Sze-ch'uen.

To give an adequate account of Chinese ornithology would require space many times the length of this article. The gorgeous mandarin duck (*Aix galericula*) has already been mentioned among generic types common to America. In marked distinction to this is the number of species of pheasants inhabiting north-western China, whence the group ranges into the eastern Himalaya. Among Chinese species are two of the three species of blood-pheasants (*Ithagenes*), two tragopans (*Cervionis* or *Tragopan*), a monal (*Lophophorus*), three out of the five species of *Crossopitulum*, the other two being Tibetan, two kinds of *Pucrasia*, the gorgeous golden and Amherst's pheasants alone representing the genus *Chrysolophus*, together with several species of the typical genus *Phasianus*, among which it will suffice to mention the

long-tailed *P. reevesi*. The Himalayan bamboo-partridges (*Bambusicola*) have also a Chinese representative. The only other large bird that can be mentioned is the Manchurian crane, misnamed *Grus japonensis*. Pigeons include the peculiar subgenus *Dendroteron*; while among smaller birds, warblers, tits and finches, all of an Eastern Holarctic type, constitute the common element in the avifauna. Little would be gained by naming the genera, peculiar or otherwise.

China has a few peculiar types of freshwater tortoises, among which *Ocadia sinensis* represents a genus unknown elsewhere, while there is also a species of the otherwise Indian genus *Damonia*. The Chinese alligator, *Alligator sinensis*, has been already mentioned. Among lizards, the genera *Plestiodon*, *Mabuia*, *Tachydromus* and *Gecko*, of which the two latter are very characteristic of the Oriental region, range through China to Japan; and among snakes, the Malay python (*Python reticulatus*) is likewise Chinese. The giant salamander (*Cryptobranchus*, or *Megalobatrachus maximus*) represents, as mentioned above, a type found elsewhere only in North America, while *Hynobius* and *Onychodactylus* are peculiar generic types of salamanders. Among fishes, it must suffice to refer to the spoon-beaked sturgeon (*Psephurus*) of the Yangtze-kiang, and the numerous members of the carp family to be found in the rivers of China. From these native carp the Chinese have produced two highly coloured breeds, the goldfish and the telescope-eyed carp.

Among the invertebrates special mention may be made of the great ailanthus silk-moth (*Attacus cyathia*) of northern China and Japan, and also of its Manchurian relative *A. pernyi*; while it may be added that the domesticated "silkworm" (*Bombyx mori*) is generally believed to be of Chinese origin, although this is not certain. Very characteristic of China is the abundance of handsomely coloured swallow-tailed butterflies of the family *Papilionidae*. The Chinese kermes (*Coccus sinensis*) is also worth mention, on account of its yielding wax. As regards land and freshwater snails, China exhibits a marked similarity to Siam and India; the two groups in which the Chinese province displays decided peculiarities of its own being *Helix* (in the wider sense) and *Clausilia*. There are, for instance, nearly half a score of subgenera of *Helix* whose headquarters are Chinese, while among these, forms with sinistral shells are relatively common. The genus *Clausilia* is remarkable on account of attaining a second centre of development in China, where its finest species, referable to several subgenera, occur. Carnivorous molluscs include a peculiar slug (*Rathouisia*) and the shelled genera *Ernea* and *Streptaxis*. In the western provinces species of *Buliminus* are abundant, and in the operculate group *Heudeia* forms a peculiar type akin to *Helicina*, but with internal foldings to the shell.

Lastly, it has to be mentioned that the waters of the Yangtze-kiang are inhabited by a small jelly-fish, or medusa (*Limnocoelium kawati*), near akin to *L. sowerbii*, which was discovered in the hot-house tanks in the Botanical Gardens in the Regent's Park, London, but whose real home is probably the Amazon. (R. L. *)

Flora.

The vegetation of China is extremely rich, no fewer than 9000 species of flowering plants having been already enumerated, of which nearly a half are endemic or not known to occur elsewhere. Whole provinces are as yet only partially explored; and the total flora is estimated to comprise ultimately 12,000 species. China is the continuation eastward of the great Himalayan mass, numerous chains of mountains running irregularly to the sea-board. Thousands of deep narrow valleys form isolated areas, where peculiar species have been evolved. Though the greater part of the country has long ago been cleared of its primeval forest and submitted to agriculture, there still remain some extensive forests and countless small woods in which the original flora is well preserved. Towards the north the vegetation is palaeartic, and differs little in its composition from that of Germany, Russia and Siberia. The flora of the western and central provinces is closely allied to that of the Himalayas and of Japan; while towards the south this element mingles with species derived from Indo-China, Burma and the plain of Hindostan. Above a certain elevation, decreasing with the latitude, but approximately 6000 ft. in the Yangtze basin, there exist in districts remote from the traffic of the great rivers, extensive forests of conifers, like those of Central Europe in character, but with different species of silver fir, larch, spruce and Cembra pine. Below this altitude the woods are composed of deciduous and evergreen broad-leaved trees and shrubs, mingled together in a profusion of species. Pure broad-leaved forests of one or two species are rare, though small woods of oak, of alder and of birch are occasionally seen. There is nothing comparable to the extensive beech forests of Europe, the two species of Chinese beech being sporadic and rare trees. The heaths, *Calluna* and *Erica*, which cover great tracts of barren sandy land in Europe, are absent from China, where the Ericaceae vegetation is made up of numerous species of *Rhododendron*, which often cover vast areas on the mountain slopes. Pine forests occur at low levels, but are always small in extent.

The appearance of the vegetation is very different from that of the United States, which is comparable to China in situation and in extent. Though there are 60 species of oak in China, many with magnificent foliage and remarkable cupules, the red oaks, so characteristic of North America, with their bristle-pointed leaves, turning beautiful

colours in autumn, are quite unknown. The great coniferous forest west of the Rocky Mountains has no analogue in China, the gigantic and preponderant Douglas fir being absent, while the giant *Sequoias* are represented only on a small scale by *Cryptomeria*, which attains half their height.

Certain remnants of the Miocene flora which have disappeared from Europe are still conspicuous and similar in North America and China. In both regions there are several species of *Magnolia*; one species each of *Liriodendron*, *Liquidambar* and *Sassafras*; and curious genera like *Nyssa*, *Hamamelis*, *Decumaria* and *Gymnocladus*. The swamps of the south-eastern states, in which still survive the once widely spread *Taxodium* or deciduous cypress, are imitated on a small scale by the marshy banks of rivers near Canton, which are clad with *Glyptostrobus*, the "water-pine" of the Chinese. *Pseudolarix*, *Cunninghamia* and *Keteleeria* are coniferous genera peculiar to China, which have become extinct elsewhere. The most remarkable tree in China, the only surviving link between ferns and conifers, *Ginkgo biloba*, has only been seen in temple gardens, but may occur wild in some of the unexplored provinces. Its leaves have been found in the tertiary beds of the Isle of Mull.

Most of the European genera occur in China, though there are curious exceptions like the plane tree, and the whole family of the *Cistaceae*, which characterize the peculiar *maquis* of the Mediterranean region. The rhododendrons, of which only four species are European, have their headquarters in China, numbering 130 species, varying in size from miniature shrubs 6 in. high to tall trees. *Lysimachia*, *Primula*, *Clematis*, *Rubus* and *Gentiana* have each a hundred species, extraordinary variable in habit, in size and in colour of the flowers. The ferns are equally polymorphic, numbering 400 species, and including strange genera like *Archangiopteris* and *Cheiropteris*, unknown elsewhere. About 40 species of bamboos have been distinguished; the one with a square stem from Fu-kien is the most curious.

With a great wealth of beautiful flowering shrubs and herbaceous plants, the Chinese at an early period became skilled horticulturists. The emperor Wu Ti established in 111 B.C. a botanic garden at Ch'ang-an, into which rare plants were introduced from the west and south. Many garden varieties originated in China. The chrysanthemum, perhaps the most variable of cultivated flowers, is derived from two wild species (small and inconspicuous plants), and is mentioned in the ancient Chinese classics. We owe to the skill of the Chinese many kinds of roses, lilies, camellias and peonies; and have introduced from China some of the most ornamental plants in our gardens, as *Wistaria*, *Diervilla*, *Kerria*, *Incarvillea*, *Deutzia*, *Primula sinensis*, *Hemerocallis*, &c. The peach and several oranges are natives of China. The varnish tree (*Rhus vernicifera*), from which lacquer is obtained; the tall tree (*Sapium sebiferum*); the white mulberry, on which silkworms are fed; and the tea plant were all first utilized by the Chinese. The Chinese have also numerous medicinal plants, of which ginseng and rhubarb are best known. Nearly all our vegetables and cereals have their counterpart in China, where there are numerous varieties not yet introduced into Europe, though some, like the Soy bean, are now attracting great attention. (A. HE. *)

AUTHORITIES.—L. Richard (S.J.), *Géographie de l'empire de Chine* (Shanghai, 1905)—the first systematic account of China as a whole in modern times. The work, enlarged, revised and translated into English by M. Kennelly (S.J.), was reissued in 1908 as Richard's *Comprehensive Geography of the Chinese Empire and Dependencies*. This is the standard authority for the country and gives for each section bibliographical notes. It has been used in the revision of the present article. Valuable information on northern, central and western China is furnished by Col. C. C. Manifold and Col. A. W. S. Wingate in the *Geog. Journ.* vol. xxxiii. (1904) and vol. xxix. (1907). Consult also Marshall Broomhall (ed.), *The Chinese Empire: a General and Missionary Survey* (London, 1907); B. Willis, E. Blackwelder and others, *Research in China*, vol. i. part i. "Descriptive Topography and Geology," part ii. "Petrography and Zoology," and Atlas (Washington, Carnegie Institution, 1906-1907); Forbes and Hemsley, "Enumeration of Chinese Plants," in *Journ. Linnean Soc. (Bot.)*, vols. xxxiii. and xxxvi.; Bretschneider, *History of European Botanical Discoveries in China*; E. Tiessen, *China das Reich der achtzehn Provinzen*, Teil i. "Die allgemeine Geographie des Landes" (Berlin, 1902); and *The China Sea Directory* (published by the British Admiralty), a valuable guide to the coasts; vol. ii. (5th ed., 1906) deals with Hong-Kong and places south thereof, vol. iii. (4th ed., 1906, supp. 1907) with the rest of the Chinese coast; vol. i. (5th ed., 1906) treats of the islands and straits in the S.W. approach to the China Sea. Much of China has not been surveyed, but considerable progress has been made since 1900. *The Atlas of the Chinese Empire* (London, 1908), a good general atlas, which, however, has no hill shading, gives maps of each province on the scale of 1 : 3,000,000. The preface contains a list of the best regional maps. *The Journal of the China Branch of the Royal Asiatic Society* contains papers on all subjects relating to China.

II. THE PEOPLE

China is noted for the density of its population, but no accurate statistics are forthcoming. The province of Shan-tung is reputed

to have a population of 680 per sq. m. The provinces of central China, in the basin of the Yangtze-kiang—namely Sze-ch'uen, Hu-peh, Ngan-hui, Kiang-su and Cheh-kiang—contain probably a third of the total population, the density of the people in these provinces being represented as from 490 to 310 per sq. m. Ho-nan, which belongs partly to the basin of the Hwang-ho and partly to that of the Yangtze-kiang, as well as the S.E. coast provinces of Fu-kien and Kwang-tung, are also densely peopled, Ho-nan being credited with 520 persons per sq. m., Fu-kien with 490 and Kwang-tung with about 320.

The Chinese government prints from time to time in the *Peking Gazette* returns of the population made by the various provincial authorities. The method of numeration is to count the households, and from that to make a return of the total inhabitants of each province. There would be no great difficulty in obtaining fairly accurate returns if sufficient care were taken. It does not appear, however, that much care is taken. Mr E. H. Parker published in the *Statistical Society's Journal* for March 1899 tables translated from Chinese records, giving the population from year to year between 1651 and 1860. These tables show a gradual rise, though with many fluctuations, up till 1851, when the total population is stated to be 432 millions. From that point it decreases till 1860, when it is put down at only 261 millions. The Chinese Imperial Customs put the total population of the empire in 1906 at 438,214,000 and that of China proper at 407,253,000. It has been held by several inquirers that these figures are gross over-estimates. Mr Rockhill, American minister at Peking (1905-1909), after careful inquiry¹ concluded that the inhabitants of China proper did not exceed, in 1904, 270,000,000. Other competent authorities are inclined to accept the round figure of 400,000,000 as nearer the accurate number. Eleven cities were credited in 1908 with between 500,000 and 1,000,000 inhabitants each, and smaller cities are very numerous, but the population is predominantly rural. In addition to the Chinese the population includes a number of aboriginal races such as the Lolos (*q.v.*), the Miaotsze (*q.v.*), the Ikias of Kwei-chow and Kwang-si, the Hakka, found in the south-east provinces, and the Hoklos of Kwang-tung province.² The Manchus resident in China are estimated to number 4,000,000. According to the Imperial Customs authorities, the number of foreigners resident in China in 1908 was 69,852. Of these 44,143 were Japanese, 9520 Russian, 9043 British, 3637 German, 3545 American, 3353 Portuguese, 2029 French, 554 Italian and 282 Belgian.

The Chinese are a colonizing race, and in Manchuria, Mongolia and Turkestan they have brought several districts under cultivation. In the regions where they settle they become the dominant race—thus southern Manchuria now differs little from a province of China proper. In Indo-China, the Malay Peninsula and throughout the Far East Chinese are numerous as farmers, labourers and traders; in some places, such as Singapore, Chinese are among the principal merchants. This colonizing spirit is probably due more to the enterprise of the people than to the density of the population. There were Chinese settlements at places on the east coast of Africa before the 10th century A.D. Following the discovery of gold in California there was from 1850 onwards a large emigration of Chinese to that state and to other parts of America. But in 1879 Chinese exclusion acts were passed by the United States, an example followed by Australia, where Chinese immigration was also held to be a public danger. Canada also adopted the policy of excluding Chinese, but not before there had been a considerable immigration into British Columbia. Two factors, a racial and an economic, are at work to bring about these measures of exclusion. As indentured labourers Chinese have been employed in the West Indies, South America and other places (see *COOLIE*).

In addition to several million Chinese settlers in Manchuria, and smaller numbers in Mongolia, Turkestan and Tibet, it was estimated in 1908 that there were over 9,000,000 Chinese resident beyond the empire. Of these 2,250,000 were in Formosa, which for long formed a part of the empire, and over 6,000,000 in neighbouring regions of Asia and in Pacific Islands. In the West Indies (chiefly Cuba) the number of Chinese was estimated at 100,000, in South America (Brazil, Peru and Chile) at 72,000, in the United States at 150,000, in Canada at 12,000, and in Australia and New Zealand at 35,000. There are comparatively few Chinese in Japan (if Formosa be excepted) and Korea. The number is given in 1908 as 17,000 in Japan and 11,000 in Korea.

Social Life.

The awakening of the East which has followed the Russo-Japanese War of 1904-5 has affected China also. It is too soon to say how far the influx of European ideas will be able to modify

¹ See W. W. Rockhill, *Inquiry into the Population of China* (Washington, 1904).

² For a bibliography of works relating to the aboriginal races of China see Richard's *Comprehensive Geography of the Chinese Empire* (1908 ed.), pp. 371-373.

the immemorial customs and traditions of perhaps the most conservative people in the world; but the process has begun, and this fact makes it difficult to give a picture of Chinese habits and customs which shall be more than historical or provisional. Moreover, the difficulty of presenting a picture which shall be true of China as a whole is enhanced by the different characteristics observable in various regions of so vast a country. The Chinese themselves, until the material superiority of Western civilization forced them to a certain degree to conform to its standards, looked down from the height of their superior culture with contempt on the "Western barbarians." Nor was their attitude wholly without justification. Their civilization was already old at a time when Britain and Germany were peopled by half-naked barbarians, and the philosophical and ethical principles on which it was based remain, to all appearances, as firmly rooted as ever. That these principles have, on the whole, helped to create a national type of a very high order few Europeans who know the Chinese well would deny. The Chinese are naturally reserved, earnest and good-natured; for the occasional outbursts of ferocious violence, notably against foreign settlements, are no index to the national character. There is a national proverb that "the men of the Four Seas are all brothers," and even strangers can travel through the country without meeting with rudeness, much less outrage. If the Chinese character is inferior to the European, this inferiority lies in the fact that the Chinaman's whole philosophy of life disinclines him to change or to energetic action. He is industrious; but his industry is normally along the lines marked out by authority and tradition. He is brave; but his courage does not naturally seek an outlet in war. The jealously exclusive empire, into which in the 19th century the nations of the West forced an entrance, was organized for peace; the arts of war had been all but forgotten, and soldiers were of all classes the most despised.

The whole social and political organization of the Chinese is based, in a far more real sense than in the West, on the family. The supreme duty is that of the child to its parent; on this the whole Chinese moral system is built up. Filial piety, according to the teaching of Confucius, is the very foundation of society; the nation itself is but one great family, and the authority of the government itself is but an extension of the paternal authority, to which all its children are bound to yield implicit obedience. The western idea of the liberty and dignity of the individual, as distinct from the community to which he belongs, is wholly alien to the Chinese mind. The political unit in China is not the individual but the family, and the father of the family is supposed to be responsible for the qualities and views of all his kin. He is rewarded for their virtues, punished for their faults; the deserts of a son ennoble the father and all his ancestors, and conversely his crimes disgrace them.

An outcome of this principle is the extraordinary importance in China of funeral rites, especially in the case of the father. The eldest son, now head of the family, or, failing him, his first-born or adopted son, fixes one of the three souls of the dead in the tablet commemorating his virtues, burns incense to his shade, and supplies him with paper money and paper representations of everything (clothes, servants, horses) that he may require in his journey to the other world. Mourning lasts for three years, during which the mourners wear white garments and abstain from meat, wine and public gatherings. Custom, too, dictates that wherever the Chinaman may die he must be brought back for burial to the place of his birth; one of the objects of the friendly societies is to provide funds to charter ships to transport home the bodies of those who have died abroad. Annually, in May, the white-clad people stream to the graves and mortuary temples with flowers, fruit and other offerings for the dead. Christian missionaries have found in this ancestor worship the most serious obstacle to the spread of a religion which teaches that the convert must, if need be, despise his father and his mother and follow Christ.

The same elaborate ceremonialism that characterizes the Chinese funeral customs is found also in their marriage rites and the rules of their social intercourse generally. Confucius is reported to have said that "all virtues have their source in etiquette," and the due observance of the "ceremonial" (*li*) in the fulfilling of social duties is that which, in Chinese opinion, distinguishes civilized from barbarous peoples. The Board of Rites, one of the departments of the central government, exists for the purpose of giving decisions in matters of etiquette and ceremony. As to marriage, the rule that the individual counts for nothing obtains here in its fullest significance. The breeding of sons to carry on the ancestral cult is a matter of prime importance, and the marriage of a young man is arranged at the earliest possible age. The bride and bridegroom have little voice

in the matter, the match being arranged by the parents of the parties; the lifting of the bride's veil, so that the bridegroom may see her face, is the very last act of the long and complicated ceremony.

In the traditional Chinese social system four classes are distinguished: the literary, the agricultural, the artisan and the trading class. Hereditary nobility, in the European sense, scarcely exists, and the possession of an hereditary title gives in itself no special privileges. Official position is more highly esteemed than birth and the bureaucracy takes the place of the aristocracy in the west. There are, nevertheless, besides personal decorations for merit, such as the yellow jacket, five hereditary rewards for merit; these last only for a fixed number of lives. A few Chinese families, however, enjoy hereditary titles in the full sense, the chief among them being the Holy Duke of Yen (the descendant of Confucius). The Imperial Clansmen consist of those who trace their descent direct from the founder of the Manchu dynasty, and are distinguished by the privilege of wearing a yellow girdle; collateral relatives of the imperial house wear a red girdle. Twelve degrees of nobility (in a descending scale as one generation succeeds another) are conferred on the descendants of every emperor in the thirteenth generation the descendants of emperors are merged in the general population, save that they retain the yellow girdle. The heads of eight houses, the "Iron-capped" (or helmeted) princes, maintain their titles in perpetuity by rule of primogeniture in virtue of having helped the Manchu in the conquest of China. Imperial princes apart, the highest class is that forming the civil service. (See also *Government and Administration*.) The peasant class forms the bulk of the population. The majority of Chinese are small landowners; their standard of living is very low in comparison with European standards. This is in part due to the system of land tenure. A parent cannot, even if he wished to do so, leave all his land to one son. There must be substantially an equal division, the will of the father notwithstanding. As early marriages and large families are the rule, this process of continual division and subdivision has brought things down to the irreducible minimum in many places. Small patches of one-tenth or even one-twentieth of an acre are to be found as the estate of an individual landowner, and the vast majority of holdings run between one and three acres. With three acres a family is deemed very comfortable, and the possession of ten acres means luxury.

The only class which at all resembles the territorial magnates of other countries is the class of retired officials. The wealth of an official is not infrequently invested in land, and consequently there are in most provinces several families with a country seat and the usual insignia of local rank and influence. On the decease of the heads or founders of such families it is considered dignified for the sons to live together, sharing the rents and profits in common. This is sometimes continued for several generations, until the country seat becomes an agglomeration of households and the family a sort of clan. A family of this kind, with literary traditions, and with the means to educate the young men, is constantly sending its scions into the public service. These in turn bring their earnings to swell the common funds, while the rank and dignity which they may earn add to the importance and standing of the group as a whole. The members of this class are usually termed the *literati* or gentry.

The complex character of the Chinese is shown in various ways. Side by side with the reverence of ancestors the law recognizes the right of the parent to sell his offspring into slavery and among the poor this is not an uncommon practice, though in comparison with the total population the number of slaves is few. The kidnapping of children for sale as slaves is carried on, but there is no slave raiding. There are more female than male slaves; the descendants of male slaves acquire freedom in the fifth generation. While every Chinese man is anxious to have male children, girls are often considered superfluous.

The position of women is one of distinct inferiority; a woman is always subject to the men of her family—before marriage to her father, during marriage to her husband, in widowhood to her son; these states being known as "the three obediences." Sons who do not, however, honour their mothers outrage public opinion. Polygamy is tolerated, secondary wives being sometimes provided by the first wife when she is growing old. Secondary wives are subordinate to first wives. A wife may be divorced for any one of seven reasons. The sale of wives is practised, but is not recognized by law. Women of the upper classes are treated with much respect. The home of a Chinese man is often in reality ruled by his mother, or by his wife as she approaches old age, a state held in veneration. Chinese women frequently prove of excellent business capacity, and those of high rank—as the recent history of China has conspicuously proved—exercise considerable influence on public affairs.

Deforming the feet of girls by binding and stopping their growth has been common for centuries. The tottering walk of the Chinese lady resulting from this deformation of the feet is the admiration of her husband and friends. Foot-binding is practised by rich and poor in all parts of the country, but is not universal. In southern and western China Hakka women and certain others never have their feet bound. It has been noted that officials (who all serve on the itinerary system) take for secondary wives natural-footed women, who are frequently

slaves.¹ Every child is one at birth, and two on what Europeans call its first birthday, the period of gestation counting as one year.

In their social intercourse the Chinese are polite and ceremonious; they do not shake hands or kiss, but prostrations (koting), salutations with joined hands and congratulations are common. They have no weekly day of rest, but keep many festivals, the most important being that of New Year's Day. Debts are supposed to be paid before New Year's Day begins and for the occasion new clothes are bought. Other notable holidays are the Festival of the First Full Moon, the Feast of Lanterns and the Festival of the Dragon Boat. A feature of the festivals is the employment of thousands of lanterns made of paper, covered with landscapes and other scenes in gorgeous colours. Of outdoor sports kite-flying is the most popular and is engaged in by adults; shuttle-cock is also a favourite game, while cards and dominoes are indoor amusements. The theatre and marionette shows are largely patronized. The habit of opium smoking is referred to elsewhere; tobacco smoking is general among both sexes.

Except in their head-dress and their shoes little distinction is made between the costumes of men and women.² Both sexes wear a long loose jacket or robe which fits closely round the neck and has wide sleeves, and wide short trousers. Over the robe shorter jackets—often sleeveless—are worn, according to the weather. For winter wear the jackets are wadded, and a Chinaman will speak of "a three, four or six coat cold day." A man's robe is generally longer than that of a woman. Petticoats are worn by ladies on ceremonial occasions and the long robe is removed when in the house. "It is considered very unwomanly not to wear trousers, and very indelicate for a man not to have skirts to his coat." No Chinese woman ever bares any part of her body in public—even the hands are concealed in the large sleeves—and the evening dress of European ladies is considered indelicate; but Hakka women move about freely without shoes or stockings. A Chinese man will, however, in warm weather often strip naked to the waist. Coolies frequently go bare-legged; they use sandals made of rope and possess rain-coats made of palm leaves. The garments of the poorer classes are made of cotton, generally dyed blue. Wealthy people have their clothes made of silk. Skirts and jackets are elaborately embroidered. Costly furs and fur-lined clothes are much prized, and many wealthy Chinese have fine collections of furs. Certain colours may only be used with official permission as denoting a definite rank or distinction, e.g. the yellow jacket. The colours used harmonize—the contrasts in colour seen in the clothes of Europeans is avoided. Dark purple over blue are usual colour combinations. The mourning colour is white. Common shoes are made of cotton or silk and have thick felt soles; all officials wear boots of satin into which is thrust the pipe or the fan—the latter carried equally by men and women. The fan is otherwise stuck at the back of the neck, or attached to the girdle, which may also hold the purse, watch, snuff-box and a pair of chop-sticks.

Formerly Chinese men let their hair grow sufficiently long to gather it in a knot at the top; on the conquest of the country by the Manchu they were compelled to adopt the queue or pigtail, which is often artificially lengthened by the employment of silk thread, usually black in colour. The front part of the head is shaved. As no Chinese dress their own hair, barbers are numerous and do a thriving trade. Women do not shave the head nor adopt the queue. Men wear in general a close-fitting cap, and the peasants large straw hats. Circular caps, larger at the crown than round the head and with an outward slope are worn in winter by mandarins, conical straw hats in summer. Women have elaborate head ornaments, decking their hair with artificial flowers, butterflies made of jade, gold pins and pearls. The faces of Chinese ladies are habitually rouged, their eyebrows painted. Pearl or bead necklaces are worn both by men and women. Officials and men of leisure let one or two finger nails grow long and protect them with a metal case.

The staple food of the majority of the Chinese in the south and central provinces is rice; in the northern provinces millet as well as rice is much eaten. In separate bowls are placed morsels of pork, fish, chicken, vegetables and other relishes. Rice-flour, bean-meat, macaroni, and shell fish are all largely used. Flour balls cooked in sugar are esteemed. Beef is never eaten, but Mahomedans eat mutton, and there is hardly any limit to the things the Chinese use as food. In Canton dogs which have been specially fed are an article of diet. Eggs are preserved for years in a solution of salt, lime and wood-ash, or in spirits made from rice. Condiments are highly prized, as are also preserved fruits. Special Chinese dishes are soups made from sea-slugs and a glutinous substance found in certain birds' nests, ducks' tongues, sharks' fins, the brains of chickens and of fish, the sinews of deer and of whales, fish with pickled fir-tree cones, and roots of the lotus lily. A kind of beer brewed from rice is a usual drink; *samshu* is a spirit distilled from the same grain and at dinners is served hot in small bowls. Excellent

¹ Evidences of the social changes taking place in China are to be found in the strong movement for the education of girls, and in the formation of societies, under official patronage, to prevent the binding of women's feet.

² It must be remembered that there is great variety in the costumes worn in the various provinces. The particulars here given are of the most general styles of dress.

native wines are made. The Chinese are, however, abstemious with regard to alcoholic liquors. Water is drunk hot by the very poor, as a substitute for tea. Tea is drunk before and after meals in cups without handle or saucer; the cups are always provided with a cover. Two substantial meals are taken during the day—luncheon and dinner; the last named at varying hours from four till seven o'clock. At dinner a rich man will offer his guest twenty-four or more dishes (always a multiple of 4), four to six dishes being served at a time. Food is eaten from bowls and with chop-sticks (*q.v.*) and little porcelain spoons. Men dine by themselves when any guests are present; dinner parties are sometimes given by ladies to ladies. Chinese cookery is excellent; in the culinary art the Chinese are reputed to be second only to the French.

Ethnologically the Chinese are classed among the Mongolian races (in which division the Manchus are also included), although they present many marked contrasts to the Mongols. The Tatars, Tibetans, Burmese, Shans, Manchu and other races—including the Arab and Japanese—have mingled with the indigenous population to form the Chinese type, while aboriginal tribes still resist the pressure of absorption by the dominant race (see ante, *Population*). The Chinese are in fact ethnically a very mixed people, and the pure Mongol type is uncommon among them. Moreover, natives of different provinces still present striking contrasts one to another, and their common culture is probably the strongest national link. By some authorities it is held that the parent stock of the Chinese came from the north-west, beyond the alluvial plain; others hold that it was indigenous in eastern China. Notwithstanding the marked differences between the inhabitants of different provinces and even between those living in the same province, certain features are common to the race. "The stature is below the average and seldom exceeds 5 ft. 4 in., except in the North. The head is normally brachycephalic or round horizontally, and the forehead low and narrow. The face is round, the mouth large, and the chin small and receding. The cheek-bones are prominent, the eyes almond-shaped, oblique upwards and outwards, and the hair coarse, lank and invariably black. The beard appears late in life, and remains generally scanty. The eyebrows are straight and the iris of the eye is black. The nose is generally short, broad and flat. The hands and feet are disproportionately small, and the body early inclines to obesity. The complexion varies from an almost pale-yellow to a dark-brown, without any red or ruddy tinge. Yellow, however, predominates."¹

A few words may be added concerning the Manchus, who are the ruling race in China. Their ethnic affinities are not precisely known, but they may be classed among the Ural-Altai tribes, although the term Ural-Altai (*q.v.*) denotes a linguistic rather than a racial group. By some authorities they are called Tung-tatze, *i.e.* Eastern Tatars—the Tatars of to-day being of true Mongol descent. Manchu is the name adopted in the 13th century by one of several tribes which led a nomadic life in Manchuria and were known collectively in the 11th century as Nüchih. Some authorities regard the Khitans (whence the European form Cathay), who in the 9th and 10th centuries dwelt in the upper Liao region, as the ancestors of this race. It was not until the 16th century that the people became known generally as Manchus and obtained possession of the whole of the country now bearing their name (see MANCHURIA). They had then a considerable mixture of Chinese and Korean blood, but had developed a distinct nationality and kept their ancient Ural-Altai language. In China the Manchus retained their separate nationality and semi-military organization. It was not until the early years of the 20th century that steps were officially taken to obliterate the distinction between the two races. The Manchus are a more robust race than the inhabitants of central and southern China, but resemble those of northern China save that their eyes are horizontally set. They are a lively and enterprising people, but have not in general the intellectual or business ability of the Chinese. They are courteous in their relations with strangers. The common people are frugal and industrious. The Manchu family is generally large. The women's feet are unbound; they twist their hair round a silver bangle placed cross-wise on the top of the head. The Manchus have no literature of their own, but as the language of the court Manchu has been extensively studied in China.

AUTHORITIES.—Sir John F. Davies, *China* (2 vols., London, 1857); É. Réclus, *The Universal Geography*, vol. vii. (Eng. trans. ed. by E. G. Ravenstein and A. H. Keane); É. and O. Réclus, *L'Empire du milieu* (Paris, 1902); Sir R. K. Douglas, *Society in China* (London, 1895); J. Doolittle, *Social Life of the Chinese* (2 vols., New York, 1867); H. A. Giles, *China and the Chinese* (1902); E. Bard, *Les Chinois chez eux* (Paris, 1900); A. G. Jones, *Desultory Notes on Chinese Etiquette* (Shanghai, 1906); Mrs Archibald Little, *Intimate China* (London, 1899) and *The Land of the Blue Gown* (London, 1902); E. H. Parker, *John Chinaman and a Few Others* (London, 1901); J. Dyer-Ball, *Things Chinese* (Shanghai, 1903); Cheng Kitung, *The Chinese Painted by Themselves* (Eng. trans. by J. Millington, London, 1885); L. Richard, *Comprehensive Geography of the Chinese Empire* (Shanghai, 1908). (X.)

¹ Richard's *Comprehensive Geography*, &c. (1908 edition), pp. 340-341.

Religion.

The earliest traces of religious thought and practice in China point to a simple monotheism. There was a Divine Ruler of the universe, abiding on high, beyond the ken of man. This Power was not regarded as the Creator of the human race, but as a Supreme Being to whom wickedness was abhorrent and virtuous conduct a source of joy, and who dealt out rewards and punishments with unerring justice, claiming neither love nor reverence from mankind. If a man did his duty towards his neighbour, he might pass his whole time on earth oblivious of the fact that such a Power was in existence; unless perchance he wished to obtain some good or attain some end, in which case he might seek to propitiate Him by sacrifice and prayer. There was no Devil to tempt man astray, and to rejoice in his fall; neither was there any belief that righteous behaviour in this world would lead at death to absorption in the Deity. To God, understood in this sense, the people gave the name *T'ien*, which in the colloquial language was used of the sky; and when, in the first stages of the written character, it became necessary to express the idea of *T'ien*, they did not attempt any vague picture of the heavens, but set down the rude outline of a man. Perhaps about this period the title *Shang Ti*, or Supreme Ruler, came into vogue as synonymous with *T'ien*. But although the two terms were synonyms, and both may be equally rendered by "God," there is nevertheless an important distinction to be observed, much as though *T'ien* and *Shang Ti* were two Persons in one substance. *T'ien* is far more an abstract Being, while *Shang Ti* partakes rather of the nature of a personal God, whose anthropomorphic nature is much more strongly accentuated. *Shang Ti* is described as walking and talking, as enjoying the flavour of sacrifices, as pleased with music and dancing in his honour, and even as taking sides in warfare; whereas *T'ien* holds aloof, wrapped in an impenetrable majesty, an *ignotum pro mirifico*. So much for religion in primeval days, gathered scrap by scrap from many sources; for nothing like a history of religion is to be found in Chinese literature.

Gradually to this monotheistic conception was added a worship of the sun, moon and constellations, of the five planets, and of such noticeable individual stars as (*e.g.*) Canopus, which is now looked upon as the home of the God of Longevity. Earth, too—Mother Earth—came in for her share of worship, indicated especially by the God of the Soil, and further distributed among rivers and hills. Wind, rain, heat, cold, thunder and lightning, as each became objects of desire or aversion, were invested with the attributes of deities. The various parts of the house—door, kitchen-stove, courtyard, &c.—were also conceived of as sheltering some spirit whose influence might be benign or the reverse. The spirits of the land and of grain came to mean one's country, the commonwealth, the state; and the sacrifices of these spirits by the emperor formed a public announcement of his accession, or of his continued right to the throne. Side by side with such sacrificial rites was the worship of ancestors, stretching so far back that its origin is not discernible in such historical documents as we possess. In early times only the emperor, or the feudal nobles, or certain high officials, could sacrifice to the spirits of nature; the common people sacrificed to their own ancestors and to the spirits of their own homes. For three days before performing such sacrifices, a strict vigil with purification was maintained; and by the expiration of that time, from sheer concentration of thought, the mourner was able to see the spirits of the departed, and at the sacrifice next day seemed to hear their movements and even the murmur of their sighs. Ancestral worship in China has always been, and still is, worship in the strict sense of the term. It is not a memorial service in simple honour of the dead; but sacrifices are offered, and the whole ceremonial is performed that the spirits of former ancestors may be induced to extend their protection to the living and secure to them as many as possible of the good things of this world.

For Confucianism, which cannot, strictly speaking, be classed as a religion, see CONFUCIUS.

*The
ancient
faith.*

Around the scanty utterances of Lao Tzu or Lao-tze (*q.v.*; see also § *Chinese Literature*, §§ *Philosophy*) an attempt was made by later writers to weave a scheme of thought which should serve to satisfy the cravings of mortals for some definite solution of the puzzle of life. Lao Tzu himself had enunciated a criterion which he called *Tao*, or the Way, from which is derived the word Taoism; and in his usual paradoxical style he had asserted that the secret of this Way, which was at the beginning apparently nothing more than a line of right conduct, could not possibly be imparted, even by those who understood it. His disciples, however, of later days proceeded to interpret the term in the sense of the Absolute, the First Cause, and finally as One, in whose obliterating unity all seemingly opposed conditions of time and space were indistinguishably blended. This One, the source of human life, was placed beyond the limits of the visible universe; and for human life to return thither at death and to enjoy immortality, it was only necessary to refine away all corporeal grossness by following the doctrines of Lao Tzu. By and by, this One came to be regarded as a fixed point of dazzling luminosity in remote ether, around which circled for ever and ever, in the supremest glory of motion, the souls of those who had left the slough of humanity behind them. These transcendental notions were entirely corrupted at a very early date by the introduction of belief in an elixir of life, and later still by the practice of alchemistic experiments. Opposed by Buddhism, which next laid a claim for a share in the profits of popular patronage, Taoism rapidly underwent a radical transformation. It became a religion, borrowing certain ceremonial, vestments, liturgies, the idea of a hell, arrangement of temples, &c., from its rival; which rival was not slow in returning the compliment. As Chu Hsi said, "Buddhism stole the best features of Taoism; Taoism stole the worst features of Buddhism. It is as though one took a jewel from the other, and the loser recouped the loss with a stone." At the present day there is not much to choose between the two religions, which flourish peaceably together. As to their temples, priests and ceremonial, it takes an expert to distinguish one from the other.

There is no trustworthy information as to the exact date at which Buddhism first reached China. It is related that the emperor Ming Ti (A.D. 58-76) had a dream in which a golden man appeared to him, and this mysterious visitant was interpreted by the emperor's brother to be none other than Shākyamuni Buddha, the far-famed divinity of the West. This shows that Buddhism must then have been known to the Chinese, at any rate by hearsay. The earliest alleged appearance of Buddhism in China dates from 217 B.C., when certain Shamans who came to proselytize were seized and thrown into prison. They escaped through the miraculous intervention of a golden man, who came to them in the middle of the night and opened their prison doors. Hsi Kuan, a writer of the Sung dynasty, quotes in his *Tung Chai Chi* passages to support the view that Buddhism was known in China some centuries before the reign of Ming Ti; among others, the following from the *Sui Shu Ching Chi Chih*: "These Buddhist writings had long been circulated far and wide, but disappeared with the advent of the Ch'in dynasty," under which (see § *Chinese Literature*, §§ *History*) occurred the Burning of the Books. It is, however, convenient to begin with the alleged dream of Ming Ti, as it was only subsequent to that date that Buddhism became a recognized religion of the people. It is certain that in A.D. 65 a mission of eighteen members was despatched to Khotan to make inquiries on the subject, and that in 67 the mission returned, bringing Buddhist writings and images, and accompanied by an Indian priest, Kashiapmadanga, who was followed shortly afterwards by another priest, Gobharana. A temple was built for these two at Lo-yang, then the capital of China, and they settled down to the work of translating portions of the Buddhist scriptures into Chinese; but all that now remains of their work is the Sūtra of Forty-two Sections, translated by Kashiapmadanga. During the next two hundred and fifty years an unbroken line of foreign priests came to China to continue the task of translation, and to assist in spreading the faith. Such work was indeed entirely in their hands, for until the 4th century the Chinese people were prohibited from taking orders as priests; but by that date Buddhism had taken a firm hold upon the masses, and many Chinese priests were attracted towards India, despite the long and dangerous journey, partly to visit the birthplace of the creed and to see with their own eyes the scenes which had so fired their imaginations, and partly in the hope of adding to the store of books and images already available in China (see § *Chinese Literature*, §§ *Geography and Travel*). Still, the train of Indian missionaries, moving in the opposite direction, did not cease. In 401, Kumarajiva, the nineteenth of the Western Patriarchs and translator of the Diamond Sūtra, finally took up his residence at the court of the soi-disant emperor, Yao Hsing. In 405 he became State Preceptor and dictated his commentaries on the sacred books of Buddhism to some eight hundred priests, besides composing a *śāstra* on Reality and Semblance. Dying in 417, his body was cremated, as is still usual with priests, but his tongue, which had done such eminent service during life, remained unharmed in the midst of the flames. In the year 520 Bōdhidharma, or Ta-mo, as he is affectionately known to the Chinese, being also called the White Buddha, reached Canton, bringing with him the sacred bowl of the Buddhist Patriarchate, of which he was the last representative in the west and the first to hold office in the east. Summoned to Nanking,

he offended the emperor by asserting that real merit lay, not in works, but solely in purity and wisdom combined. He therefore retired to Lo-yang, crossing the swollen waters of the Yangtze on a reed, a feat which has ever since had a great fascination for Chinese painters and poets. There he spent the rest of his life, teaching that religion was not to be learnt from books, but that man should seek and find the Buddha in his own heart. Thus Buddhism gradually made its way. It had to meet first of all the bitter hostility of the Taoists; and secondly, the fitful patronage and opposition of the court. Several emperors and empresses were infuriated supporters of the faith; one even went so far as to take vows and lead the life of an ascetic, further insisting that to render full obedience to the Buddhist commandment, "Thou shalt not kill," the sacrificial animals were to be made of dough. Other emperors, instigated by Confucian advisers, went to the opposite extreme of persecution, closed all religious houses, confiscated their property, and forced the priests and monks to return to the world. From about the 11th century onwards Buddhism has enjoyed comparative immunity from attack or restriction, and it now covers the Chinese empire from end to end. The form under which it appears in China is to some extent of local growth; that is to say, the Chinese have added and subtracted not a little to and from the parent stock. The cleavage which took place under Hanishka, ruler of the Indo-Scythian empire, about the 1st century A.D., divided Buddhism into the Mahāyāna, or Greater Vehicle, and the Hināyāna, as it is somewhat contemptuously styled, or Lesser Vehicle. The latter was the nearer of the two to the Buddhism of Shākyamuni, and exhibits rather the mystic and esoteric sides of the faith. The former, which spread northwards and on to Nepal, Tibet, China, Mongolia and Japan, leaving southern India, Burma and Siam to its rival, began early to lean towards the deification of Buddha as a personal Saviour. New Buddhas and Bōdhisarvas were added, and new worlds were provided for them to live in; in China, especially, there was an enormous extension of the mythological element. In fact, the Mahāyāna system of Buddhism, inspired, as has been observed, by a progressive spirit, but without contradicting the inner significance of the teachings of Buddha, broadened its scope and assimilated other religio-philosophical beliefs, whenever this could be done to the advantage of those who came within its influence. Such is the form of this religion which prevails in China, of which, however, the Chinese layman understands nothing. He goes to a temple, worships the gods with prostrations, lighted candles, incense, &c., to secure his particular ends at the moment; he may even listen to a service chanted in a foreign tongue and just as incomprehensible to the priests as to himself. He pays his fees and departs, absolutely ignorant of the history or dogmas of the religion to which he looks for salvation in a future state. All such knowledge, and there is now not much of it, is confined to a few of the more cultured priests.

The 7th century seems to have been notable in the religious history of China. Early in that century, Mazdaism, or the religion of Zoroaster, based upon the worship of fire, was introduced into China, and in 621 the first temple under that denomination was built at Ch'ang-an in Shensi, then the capital. But the harvest of converts was insignificant; the religion failed to hold its ground, and in the 9th century disappeared altogether.

Mahomedans first settled in China in the Year of the Mission, A.D. 628, under Wahb-Abū-Kabba, a maternal uncle of Mahomet; who was sent with presents to the emperor. Wahb-Abū-Kabba travelled by sea to Canton, and thence over-land to Ch'ang-an, the capital, where he was well received. The first mosque was built at Canton, where after several restorations, it still exists. Another mosque was erected in 742; but many of the Mahomedans went to China merely as traders, and afterwards returned to their own country. The true stock of the present Chinese Mahomedans was a small army of 4000 Arab soldiers sent by the caliph Abu Giafar¹ in 755 to aid in putting down a rebellion. These soldiers had permission to settle in China, where they married native wives; and four centuries later, with the conquests of Jenghiz Khan, large numbers of Arabs penetrated into the empire and swelled the Mahomedan community. Its members are now indistinguishable from the general population; they are under no civic disabilities, and are free to open mosques wherever they please, so long as, in common with Buddhists and Taoists, they exhibit the tablet of the emperor's sovereignty in some conspicuous position.

In A.D. 631 the Nestorians sent a mission to China and introduced Christianity under the name of the Luminous Doctrine. In 636 they were allowed to settle at Ch'ang-an; and in 638 an Imperial Decree was issued, stating that Olopan, a Nestorian priest who is casually mentioned as a Persian, had presented a form of religion which his Majesty had carefully examined and had found to be in every way satisfactory, and that it would henceforth be permissible to preach this new doctrine within the boundaries of the empire. Further, the establishment of a monastery was authorized, to be served by twenty-one priests. For more than a century after this, Nestorian Christianity seems to have flourished in China. In 781 the famous Nestorian Tablet,

¹ Otherwise Abū Ja'far Ibn Mahomed al-Mansūr (see CALIPHATE, C. § 2).

giving a rough outline of the object and scope of the faith, was set up at Ch'ang-an (the modern Si-gan Fu), disappearing soon afterwards in the political troubles which laid the city in ruins, to be brought to light again in 1625 by Father Semedo, S. J. The genuineness of this tablet was for many years in dispute, Voltaire, Renan, and others of lesser fame regarding it as a pious Jesuit fraud; but all doubts on the subject have now been dispelled by the exhaustive monograph of Père Havret, S. J., entitled *La Siècle de Si-ngan*. The date of the tablet seems to mark the zenith of Nestorian Christianity in China; after this date it began to decay. Marco Polo refers to it as existing in the 13th century; but then it fades out of sight, leaving scant traces in Chinese literature of ever having existed.

The Manichaeans, worshippers of the Chaldaean Mani or Manēs, who died about A.D. 274, appear to have found their way to China in the year 694. In 719 an envoy from Tokharistan reached Ch'ang-an, bringing a letter to the emperor, in which a request was made that an astronomer who accompanied the mission might be permitted to establish places of worship for persons of the Manichaean faith. Subsequently, a number of such chapels were opened at various centres; but little is known of the history of this religion, which is often confounded by Chinese writers with Mazdeism, the fate of which it seems to have shared, also disappearing about the middle of the 9th century.

By "the sect of those who take out the sinew," the Chinese refer to the Jews and their peculiar method of preparing meat in order to make it *kosher*. Wild stories have been told of their arrival in China seven centuries before the Christian era, after one of the numerous upheavals mentioned in the Old Testament; and again, of their having carried the Pentateuch to China shortly after the Babylonish captivity, and having founded a colony in Ho-nan in A.D. 72. The Jews really reached China for the first time in the year A.D. 1163, and were permitted to open a synagogue at the modern K'ai-fêng Fu in 1164. There they seem to have lived peaceably, enjoying the protection of the authorities and making some slight efforts to spread their tenets. There their descendants were found, a dwindling community, by the Jesuit Fathers of the 17th century; and there again they were visited in 1850 by a Protestant mission, which succeeded in obtaining from them Hebrew rolls of parts of the Pentateuch in the square character, with vowel points. After this, it was generally believed that the few remaining stragglers, who seemed to be entirely ignorant of everything connected with their faith, had become merged in the ordinary population. A recent traveller, however, asserts that in 1909 he found at K'ai-fêng Fu a Jewish community, the members of which keep as much as possible to themselves, worshipping in secret, and preserving their ancient ritual and formulary.

See H. Hackmann, *Buddhism as a Religion* (1910); H. A. Giles, *Religions of Ancient China* (1905); G. Smith, *The Jews at K'ae-fung-foo* (1851); Dabry de Thiersant, *Le Mahométisme en Chine* (1878); P. Havret, S. J., *La Siècle chrétienne de Si-ngan-fou* (1895).

(H. A. G.)

[Christian missions, both Roman Catholic and Protestant, are established in every province in China. Freedom to embrace the Christian faith has been guaranteed by the Chinese government since 1860, and as a rule the missionaries have free scope in teaching and preaching, though local disturbances are not infrequent. The number of members of the Roman Catholic Church in China was reckoned by the Jesuit fathers at Shanghai to be, in 1907, "about one million"; in the same year the Protestant societies reckoned in all 250,000 church members. By the Chinese, Roman Catholicism is called the "Religion of the Lord of Heaven"; Protestantism the "Religion of Jesus." For the progress and effects of Christianity in China see § *History*, and *Missions*, § *China*. Ed.]

Education and the Press.

The educational system of China till nearly the close of the 19th century was confined in its scope to the study of Chinese classics. Elementary instruction was not provided by the state. The well-to-do engaged private tutors for their sons; the poorer boys were taught in small schools on a voluntary basis. No curriculum was compulsory, but the books used and the programme pursued followed a traditional rule. The boys (there were no schools for girls) began by memorizing the classics for four or five years. Then followed letter-writing and easy composition. This completed the education of the vast majority of the boys not intended for the public service. The chief merit of the system was that it developed the memory and the imitative faculty. For secondary education somewhat better provision was made, practically the only method of attaining eminence in the state being through the schools (see § *Civil Service*). At prefectural cities and provincial capitals colleges were maintained at the public expense, and at these institutions a more or less thorough knowledge of the classics might be obtained. At the public examinations

held periodically the exercises proposed were original poems and literary essays. Three degrees were conferred, *Siu-is'ai* (budding talent), *Chü-jên* (promoted scholar) and *Chin-shih* (entered scholar). The last degree was given to those who passed the final examination at Peking, and the successful candidates were also called metropolitan graduates.

The first education on western lines was given by the Roman Catholic missionaries. In 1852 they founded a college for the education of native priests; they also founded and maintained many primary and some higher schools—mainly if not exclusively for the benefit of their converts. The Protestant missions followed the example of the Roman Catholics, but a new departure, which has had a wide success, was initiated by the American Protestant missionary societies in founding schools—primary and higher—and colleges in which western education was given equally to all comers, Christian or non-Christian. Universities and medical schools have also been established by the missionary societies. They also initiated a movement for the education of girls and opened special schools for their instruction.

Missionary effort apart, the first step towards western education was the establishment of two colleges in 1861, one at Peking, the other at Canton in connexion with the imperial maritime customs. These institutions were known as T'ung Wen Kwan, and were provided with a staff of foreign professors and teachers. These colleges were mainly schools of languages to enable young Chinese to qualify as interpreters in English, French, &c. Similar schools were established at Canton, Fuchow and one or two other places, with but indifferent results. A more promising plan was conceived in 1880, or thereabouts, by the then viceroy of Nanking, who sent a batch of thirty or forty students to America to receive a regular training on the understanding that on their return they would receive official appointments. The promise was not kept. A report was spread that these students were becoming too much Americanized. They were hastily recalled, and when they returned they were left in obscurity. The next step was taken by the viceroy Chang Chih-tung after the Sino-Japanese War of 1894-95. The viceroy wrote a book, *China's Only Hope*, which he circulated throughout the empire, and in which he strongly advocated a reform of the traditional educational system. His scheme was to make Chinese learning the foundation on which a western education should be imparted.¹ The book was one of the factors in the 1898 reform movement, and Chang Chih-tung's proposals were condemned when that movement was suppressed. But after the Boxer rising the Peking government adopted his views, and in 1902 regulations were issued for the reform of the old system of public instruction. A university on western lines was established in that year at Peking, the T'ung Wen Kwan at the capital being incorporated in it. The new educational movement gained enormously in strength as the result of the Russo-Japanese War, and in 1906 a new system, theoretically almost perfect, was established. The new system comprises the study of the Chinese language, literature and composition, modern sciences, history and geography, foreign languages,² gymnastics, drill and, in the higher grades, political economy, and civil and international law.

By 1910 primary and secondary government schools and schools for special subjects (such as agriculture and engineering) had been established in considerable numbers. In every province an Imperial University was also established. The Imperial University at Peking now teaches not only languages and Chinese subjects but also law, chemistry, mathematics, &c. A medical school was founded at Peking in 1906 through the energy of British Protestant missionaries, and is called the Union Medical College. When in 1908, the United States, finding that the indemnity for the Boxer outrages awarded her was excessive, agreed to forgo the payment of £2,500,000, China undertook to spend an equal amount in sending students to America.

The general verdict of foreign observers on the working of the new system up to 1910 was that in many instances the teaching was ineffective, but there were notable exceptions. The best teachers, next to Europeans, were foreign or mission-trained Chinese. The Japanese employed as teachers were often ignorant of Chinese and were not as a rule very successful. (See further § *History*.) A remarkable indication of the thirst for western learning and culture was the translation into Chinese and their diffusion throughout the country of numerous foreign standard and other works, including modern fiction.

The *Peking Gazette*, which is sometimes called the oldest paper in the world, is not a newspaper in the ordinary sense, but merely a court gazette for publishing imperial decrees and such public documents as the government may wish to give out. It never contains original articles nor any discussion of public affairs. The first

¹ For a summary of Chang Chih-tung's treatise, see *Changing China* (1910 edition), chap. xxii.

² It was announced in June 1910 that the throne had approved a recommendation of the Board of Education that English should be the official language for scientific and technical education, and that the study of English should be compulsory in all provincial scientific and technical schools.

genuine native newspaper was published at Shanghai about 1870. It was termed the *Shen Pao* or *Shanghai News*, and was a Chinese speculation under foreign protection, the first editor being an Englishman. It was some years before it made much headway, but success came, and it was followed by various imitators, some published at Shanghai, some at other treaty ports and at Hong-Kong. In 1910 there were over 200 daily, weekly or monthly journals in China. The effect of this mass of literature on the public mind of China is of first-rate importance.

The attitude of the central government towards the native press is somewhat undefined. Official registration of a newspaper is required before postal facilities are given. There are no press laws, but as every official is a law unto himself in these matters, there is nothing to prevent him from summarily suppressing an obnoxious newspaper and putting the editor in prison. The emperor, among other reform edicts which provoked the *coup d'état* of 1898, declared that newspapers were a boon to the public and appointed one of them a government organ. The empress-dowager revoked this decree, and declared that the public discussion of affairs of state in the newspapers was an impertinence, and ought to be suppressed. Nevertheless the newspapers continued to flourish, and their outspoken criticism had a salutary effect on the public and on the government. The official classes seem to have become alarmed at the independent attitude of the newspapers, but instead of a campaign of suppression the method was adopted, about 1908, of bringing the vernacular press under official control. This was accomplished chiefly by the purchase of the newspapers by the mandarins, with the result that at the beginning of 1910 there was said to be hardly an independent native daily newspaper left in China. The use of government funds to subsidize or to purchase newspapers and thus to stifle or mislead public opinion provoked strong protests from members of the Nanking provincial council at its first sitting in the autumn of 1909. The appropriation by the Shanghai Taot'ai of moneys belonging to the Huangpu conservancy fund for subsidizing papers led to his impeachment by a censor and to the return of the moneys.¹ (X.)

III. ECONOMICS

Agriculture and Industry.

China is pre-eminently an agricultural country. The great majority of its inhabitants are cultivators of the soil. The holdings are in general very small, and the methods of farming primitive. Water is abundant and irrigation common over large areas. Stock-raising, except in Sze-ch'uen and Kwang-tung, is only practised to a small extent; there are few large herds of cattle or flocks of sheep, nor are there any large meadows, natural or cultivated. In Sze-ch'uen yaks, sheep and goats are reared in the mountains, and buffaloes and a fine breed of ponies on the plateau. Cattle are extensively reared in the mountainous districts of Kwang-tung. The camel, horse and donkey are reared in Chih-li. Forestry is likewise neglected. While the existing forests, found mainly in high regions in the provinces of Hu-nan, Fu-kien and Kwei-chow, are disappearing and timber has to be imported, few trees are planted. This does not apply to fruit trees, which are grown in great variety, while horticulture is also a favourite pursuit.

The Chinese farmer, if his methods be primitive, is diligent and persevering. In the richer and most thickly populated districts terraces are raised on the mountain sides, and even the tops of lofty hills are cultivated. The nature of the soil and means of irrigation as well as climate are determining factors in the nature of the crops grown; rice and cotton, for example, are grown in the most northern as well as the most southern districts of China. This is, however, exceptional and each climatic region has its characteristic cultures.

The loess soil (see § *Geology*) is the chief element in determining the agricultural products of north China. Loess soil bears excellent crops, and not merely on the lower grounds, but at altitudes of 6000 and 8000 ft. Wherever loess is found the peasant can live and thrive. Only one thing is essential, and that is the annual rainfall. As, owing to the porous nature of loess, no artificial irrigation is possible, if the rain fails the crops must necessarily fail. Thus seasons of great famine alternate with seasons of great plenty. It appears, also, that the soil needs little or no manuring and very little tillage. From its extremely friable nature it is easily broken up, and thus a less amount of labour is required than in other parts. The extreme porosity of the soil probably also accounts for the length of time it will go on bearing crops without becoming exhausted. The rainfall, penetrating deeply into the soil in the absence of stratification, comes into contact with the moisture retained below, which holds in solution whatever inorganic salts

¹See *The Times* of the 19th of February and the 3rd of May 1910.

the soil may contain, and thus the vegetation has an indefinite store to draw upon.²

There is no one dominant deposit in south China, where red sandstone and limestone formations are frequent. Cultivation here is not possible on the high elevations as in the north, but in the plains and river valleys the soil is exceedingly fertile, while the lower slopes of the mountains are also cultivated. In the north, moreover, but one crop, in general, can be raised in the year. In the centre two and sometimes three crops are raised yearly, and in the south, especially in the lower basin of the Si-kiang, three crops are normally gathered. In the north, too, the farmer has frequently to contend with drought or with rain or floods; in the central and southern regions the weather is more settled.

In the north of China wheat, barley, millet, buckwheat and maize are the staple crops. Beans and peas are also cultivated. Rice thrives in north-east Kan-suh, in some districts of Shan-si, in the extreme south of Shan-tung and in parts of the Wei-ho plain in Shen-si. Cotton is grown in Shen-si and Shan-tung. In Kan-suh and Shen-si two crops are raised in favoured localities, cereals in spring and cotton or rice in summer. Tobacco and the poppy are also grown in several of the northern provinces. Rhubarb and fruit trees are largely cultivated in the western part of north China.

Distribution of crops.

In the central provinces tea, cotton, rice and ramie fibre are the chief crops. Tea is most largely cultivated in Ngan-hui, Kiang-si, Hu-peh, Hu-nan, Sze-ch'uen and Yun-nan. Cotton is chiefly grown in Kiang-su, Ngan-hui and Hu-peh. The seed is sown in May and the crops gathered in September. The cotton is known as white and yellow, the white variety being the better and the most cultivated. The poppy is largely cultivated and, in connexion with the silk industry, the mulberry tree. The mulberry is found principally in the provinces of Sze-ch'uen, Kiang-su and Cheh-kiang. The central provinces are also noted for their gum-lac, varnish and tallow trees.

The crops of the south-eastern provinces are much the same as those of the central provinces, but are predominantly rice, the sugar-cane, ground-nuts and cinnamon. Tea is the chief crop in Fu-kien. The sugar-cane is principally cultivated in Kwang-tung, Fu-kien and Sze-ch'uen. In the south-western provinces the poppy, tea, tobacco and rice are the chief crops. Wheat, maize and barley are also largely raised.

While rice does not, unlike tea and cotton, form the principal crop of any one province it is more universally cultivated than any other plant and forms an important item in the products of all the central and southern provinces. Regarding China as a whole it forms the staple product and food of the country. Two chief varieties are grown, that suited only to low-lying regions requiring ample water and the red rice cultivated in the uplands. Next to rice the most extensively cultivated plants are tea and cotton, the sugar-cane, poppy and bamboo. Besides the infinite variety of uses to which the wood of the bamboo is applied, its tender shoots and its fruit are articles of diet.

Fruit is extensively cultivated throughout China. In the northern provinces the chief fruits grown are pears, plums, apples, apricots, peaches, medlars, walnuts and chestnuts, and in Kan-suh and Shan-tung the jujube (*q.v.*). Strawberries are an important crop in Kan-suh. In Shan-si, S.W. Chih-li and Shan-tung the vine is cultivated; the grapes of Shan-si are reputed to produce the best wine of China. Oranges are also grown in favoured localities in the north. The chief fruits of the central and southern provinces are the orange, lichi, mango, persimmon, banana, vine and pineapple, but the fruits of the northern regions are also grown. The coco-nut and other palms flourish on the southern coast.

Fruits.

As shown above, the poppy has been grown in almost every district of China. In 1906 it was chiefly cultivated in the following provinces: Yun-nan, Kwei-chow, Sze-ch'uen, Kan-suh, Shen-si, Shan-si, Shan-tung, Ho-nan, Kiang-su (northern part) and Cheh-kiang. The poppy is first mentioned in Chinese literature in a book written in the first half of the 8th century A.D., and its medicinal qualities are referred to in the *Herbalist's Treasury* of 973. It was not then nor for centuries later grown in China for the preparation of opium.³ There is no evidence to show that the Chinese ever took opium in the shape of pills (otherwise than medicinally). The cultivation of the poppy for the manufacture of opium began in China in the 17th century, but it was not until after 1796, when the importation of foreign opium was declared illegal, that the plant was cultivated on an extensive scale. After 1906 large areas which had been devoted to the poppy were given over to other crops, in consequence of the imperial edict aimed at the suppression of opium-smoking (see § *History*).

The poppy.

Mining.—The mineral resources of China are great, but the government has shown a marked repugnance to allow foreigners

²Another peculiarity of loess in China is that it lends itself readily to the excavation of dwellings for the people. In many places whole villages live in cave dwellings dug out in the vertical wall of loess. They construct spiral staircases, selecting places where the ground is firm, and excavate endless chambers and recesses which are said to be very comfortable and salubrious.

³See J. Edkins, *The Poppy in China*, and H. B. Morse, *The Trade and Administration of the Chinese Empire*, chap. xi.

to work mines, and the mineral wealth has been very inadequately exploited. Mining operations are controlled by the Board of Commerce. In 1907 this board drew up regulations respecting the constitution of mining and other companies. They contained many features against which foreign powers protested.

Coal, iron, copper and tin are the principal minerals found in China; there are also extensive deposits of coal and other minerals in Manchuria. In China proper the largest coal measures are found in Shan-si, Hu-nan, Kwei-chow and Sze-ch'uen.

Coal. There are also important coalfields in Chih-li, Shan-tung, Shen-si, Ho-nan, Yun-nan, Hu-peh and Kwang-tung—and almost all of the seven other provinces have also coal measures of more or less value. The lack of transport facilities as well as the aversion from the employment of foreign capital has greatly hindered the development of mining. Numerous small mines have been worked for a long period by the natives in the province of Hu-nan. There are two principal local fields in this province, one lying in the basin of the Lei river and yielding anthracite, and the other in the basin of the Siang river yielding bituminous coal. Both rivers drain into the Yangtze, and there is thus an easy outlet by water to Hankow. The quality of the coal, however, is inferior, as the stratification has been much disturbed, and the coal-seams have been in consequence crushed and broken. The largest coalfield in China lies in the province of Shan-si. Coal and iron have here been worked by the natives from time immemorial, but owing to the difficulty of transport they have attained only a limited local circulation. The whole of southern Shan-si, extending over 30,000 sq. m., is one vast coalfield, and contains, according to the estimate of Baron von Richthofen, enough coal to last the world at the present rate of consumption for several thousand years. The coal-seams, which are from 20 to 36 ft. in thickness, rest conformably on a substructure of limestone. The stratification is throughout undisturbed and practically horizontal. As the limestone bed is raised some 2000 ft. above the neighbouring plain the coal-seams crop out in all directions. Mining is thus carried on by adits driven into the face of the formation, rendering the mining of the coal extremely easy. The coalfield is divided into two by a mountain range of ancient granitic formation running north-east and south-west, termed the Ho-shan. It is of anterior date to the limestone and coal formations, and has not affected the uniformity of the stratification, but it has this peculiarity, that the coal on the east side is anthracite, and that on the west side is bituminous. A concession to work coal and iron in certain specified districts in this area was granted to a British company, the Peking Syndicate, together with the right to connect the mines by railway with water navigation. The syndicate built a railway in Shan-si from P'ingyang to Tsi-chow-fu, the centre of a vast coalfield, and connected with the main Peking-Hankow line; lines to serve coal mines have also been built in Hu-nan and other provinces. The earliest in date was that to the K'ai-ping collieries in the east of the province of Chih-li, the railway connecting the mines with the seaport of Taku. The coal at K'ai-ping is a soft bituminous coal with a large proportion of dust. The output is about 1,500,000 tons per annum. A mine has also been opened in the province of Hu-peh, about 60 m. below Hankow, and near the Yangtze, in connexion with iron-works.

Iron ore of various qualities is found almost as widely diffused as coal. The districts where it is most worked at present lie within the coalfield of Shan-si, viz. at Tsi-chow-fu and P'ing-tung-chow. The ore is a mixture of clay iron ore and spathic ore, together with limonite and hematite. It is found abundantly in irregular deposits in the Coal Measures, and is easily smelted by the natives in crucibles laid in open furnaces. This region supplies nearly the whole of north China with the iron required for agricultural and domestic use. The out-turn must be very considerable, but no data are available for forming an accurate estimate. The province of Sze-ch'uen also yields an abundance of iron ores of various kinds. They are worked by the natives in numerous places, but always on a small scale and for local consumption only. The ores occur in the Coal Measures, predominant among them being a clay iron ore. Hu-nan, Fu-kien, Cheli-kiang and Shan-tung all furnish iron ores. Iron (found in conjunction with coal) is worked in Manchuria.

Copper is found chiefly in the provinces of Kwei-chow and Yun-nan, where a rich belt of copper-bearing ores runs east and west across both provinces, and including south Sze-ch'uen. The chief centres of production are at the cities of Tung-ch'uen-fu, Chow-t'ung and Ning-yuen. The mines are worked as a government monopoly, private mining being nominally prohibited. The output is considerable, but no statistics are published by government. Rich veins of copper ore are also worked near Kiu-kiang. Tin is mined in Yun-nan, the headquarters of the industry being the city of Meng-tsze, which since 1909 has been connected with Hanoi by railway. This is an important industry, the value of tin exported in 1908 being £600,000. Tin is also mined in Hai-nan and lead in Yun-nan. Antimony ore is exported from Hu-nan; petroleum is found in the upper Yangtze region. Quick-silver is obtained in Kwei-chow. Salt is obtained from brine wells in Shan-si and Sze-ch'uen, and by evaporation from sea water.

Copper, tin, &c.

Excellent kaolin abounds in the north-eastern part of Kiang-si, and is largely used in the manufacture of porcelain.

The Chinese government has opened small gold mines at Hai-nan, in which island silver is also found. A little gold-washing is done in the sandy beds of certain rivers, for instance, the Han river and the upper Yangtze, above Su-chow (Suifu), which here goes by the name of the "Goldsand" river. The amount so extracted is extremely small and hardly pays the labour of washing, but the existence of gold grains points to a matrix higher up. The whole of south-western China has the reputation of being highly metalliferous. Gold is obtained in some quantities on the upper waters of the Amur river, on the frontier between China and Siberia. The washings are carried on by Chinese. Gold has also been found in quartz veins at P'ing-tu, in Shan-tung, but hardly in paying quantities. There are silver mines in Yun-nan.

Manufactures.—The principal native manufactures before the competition of western nations made itself felt were—apart from the preparation of tea and other produce for the market—those of porcelain and silk. The silks and gauzes of Su-chow and Nanking in the province of Kiang-su, and those of Hang-chow in Cheh-kiang, are highly esteemed throughout China. Silk-weaving is still carried on solely in native looms and chiefly in the cities named. The greater part of the silk spun is used in China, but a considerable export trade has grown up and 27% of the world's supply of raw silk is from China. The reeling of silk cocoons by steam-machinery is supplanting native methods. There are filatures for winding silk at Shanghai, Canton, Chifu and other cities.

The most famous porcelain came from the province of Kiang-si, the seat of the industry being the city of King-te-chen. Imperial works were established here about the year A.D. 1000, and the finest porcelain is sent to Peking for the use of the emperor. At one time 1,000,000 work-people were said to be employed, and the kilns numbered 600. The Taiping rebels destroyed the kilns in 1850. Some of them have been rebuilt. "Activity begins to reign anew, but the porcelain turned out is far from equalling in colour and finish that of former times. At the present day King-te-chen has but 160 furnaces and employs 160,000 workmen." The common rice bowls sold throughout China are manufactured here. The value of the export sales is said to be about £500,000 yearly.

The spinning and weaving of cotton on hand-loom is carried on almost universally. Besides that locally manufactured, the whole of the large import of Indian yarn is worked up into cloth by the women of the household. Four-fifths of the clothing of the lower classes is supplied by this domestic industry. Of minor industries Indian ink is manufactured in Ngan-hui and Sze-ch'uen, fans, furniture, lacquer ware and matting in Kwang-tung, dyes in Chch-kiang and Chih-li, and varnished tiles in Hu-nan. Paper, bricks and earthenware are made in almost all the provinces.

Of industries on a large scale—other than those indicated—the most important are cotton-spinning and weaving mills established by foreign companies at Shanghai. Permission to carry on this industry was refused to foreigners until the right was secured by the Japanese treaty following the war of 1894-95. Some native-owned mills had been working before that date, and were reported to have made large profits. Nine mills, with an aggregate of 400,000 spindles, were working in 1906, five of them under foreign management. There are also four or five mills at one or other of the ports working 80,000 spindles more. These mills are all engaged in the manufacture of yarn for the Chinese market, very little weaving being done. Chinese-grown cotton is used, the staple of which is short; only the coarser counts can be spun.

At certain large centres flour and rice mills have been erected and are superseding native methods of treating wheat and rice; at Canton there are sugar refineries. At Hanyang near Hankow are large iron-works owned by Chinese. They are supplied with ore from the mines at Ta-ye, 60 m. distant, and turn out (1909) about 300 steel rails a day.

Commerce.

The foreign trade of China is conducted through the "treaty ports," i.e. sea and river ports and a few inland cities which by the treaty of Nanking (1842) that of Tientsin (1860) and subsequent treaties have been thrown open to foreigners for purposes of trade. (The Nanking treaty recognized five ports only as open to foreigners—Canton,¹ Amoy, Fu-chow, Ning-po and Shanghai.) These places are as follows, treaty ports in Manchuria being included: Amoy, Antung, Canton, Chang-sha, Dairen, Chin-kiang, Clinwantao, Ch'ungking, Chifu, Fu-chow, Funing (Santua), Hang-chow, Hankow, I-ch'ang, Kang-moon, Kiao-chow, Kiu-kiang, K'ung-chow, Kowloon, Lappa, Lung-chow, Mengtze, Mukden, Nanking, Nanning, Ning-po, Niu-chwang, Pakhoi, Sanshui, Shanghai, Shasi, Su-chow, Swatow, Szemao, Tatungkow, Tientsin, Teng-yueh, Wên-chow, Wu-chow, Wuhu, Yo-chow.

¹ Richard's *Comprehensive Geography, &c.* (1908 edition), p. 144.

² In the 18th century foreign trade was restricted to Canton. In the 17th century, however, the Dutch traded to Formosa and Amoy, and the English to Amoy also. The Portuguese traded with Canton as early as 1517. For the early intercourse between Portugal and China see the introductory chapter in Donald Ferguson's *Letters from Portuguese Captives in Canton* (Bombay, 1902).

The progress of the foreign trade of China is set out in the following table. The values are given both in currency and sterling, but it is to be remarked that during the period when silver was falling, that is, from 1875 to 1893, the silver valuation represents much more accurately variations in the volume of trade than does the gold valuation. Gold prices fell continuously during this period, while silver prices were nearly constant. Since 1893 silver prices have tended to rise, and the gold valuation is then more accurate. The conversion from silver to gold is made at the rate of exchange of the day, and therefore varies from year to year.

Table of Imports and Exports, exclusive of Bullion.

Year.	Imports.		Exports.	
	Value in Taels.	Equivalent in Sterling.	Value in Taels.	Equivalent in Sterling.
1875	66,344,000	£19,903,000	77,308,000	£23,193,000
1885	84,803,000	22,618,000	73,899,000	19,206,000
1890	113,082,000	29,213,000	96,695,000	24,980,000
1895	154,685,000	25,136,000	154,964,000	25,181,000
1898	189,991,000	28,498,000	170,743,000	25,612,000
*1904	344,060,000	49,315,000	239,486,000	34,326,000
*1905	447,100,791	67,065,118	227,888,197	34,183,229

* This marked increase is partly owing to a more complete presentation of statistics; in 1903 an additional number of vessels were placed under the control of the imperial maritime customs.

In 1907 the net imports were valued at £67,664,222 and the exports at £42,961,863. In 1908 China suffered from the general depression in trade. In that year the imports were valued at £52,600,730, the exports at £36,888,050. The distribution of the trade among the various countries of the world is shown in the table which is given below. Hong-Kong is a port for trans-shipment. The imports into China from it come originally from Great Britain, India,

Imports into China. (000's omitted.)

Imports from	1875.	1880.	1885.	1890.	1895.	1905.	1908.
United Kingdom . . .	£6340	£6382	£6396	£6,357	£5,518	£1,971	£9,647
Hong-Kong	8282	8829	9404	18,615	14,331	22,240	20,033
India	4451	6039	4306	2,661	2,753	5,220	4,066
Other British possessions	396	346	542	571	732	963	..
United States	304	351	884	949	827	11,538	5,499
Continent of Europe (except Russia)	230	671	671	638	1,227	4,295	3,332†
Russian Empire	231	309	302	422
Japan	746	1021	1404	1,909	2,794	9,197	7,000

Exports from China. (000's omitted.)

Exports to	1875.	1880.	1885.	1890.	1895.	1905.	1908.
United Kingdom . . .	£8749	£8125	£5864	£3383	£1718	£2,710	£1,673
Hong-Kong	3824	4844	4232	8507	5651	12,218	12,281
India	72	323	157	273	449	408	545
Other British possessions	948	874	818	886	586	647	..
United States	2302	2906	2213	2109	2499	4,055	3,176
Continent of Europe (except Russia)	2524	3760	1948	3004	3440	4,697	7,128†
Russian Empire	1339	1260	1293	2288	2535	1,419	1,123
Japan	586	642	398	1248	2408	5,320	4,949

† Germany, France, Belgium and Italy only.

Germany, France, America, Australia, the Straits Settlements, &c., and the exports from China to it go ultimately to the same countries.

The chief imports are cotton goods, opium, rice and sugar, metals, oil, coal and coke, woollen goods and raw cotton, and fish. Cotton goods are by far the most important of the imports. They come chiefly from the United Kingdom, which also exports to China woollen manufactures, metals and machinery. China is next to India the greatest consumer of Manchester goods. The export of plain cotton cloths to China and Hong-Kong has for some years averaged 500,000,000 yds. per annum. The only competitor which Great Britain has in this particular branch of trade is the United States of America, which has been supplying China with increasing quantities of cotton goods. The value in sterling of the total imports into China from the United Kingdom long remained nearly constant, but inasmuch as the gold prices were falling the volume of the export was in reality steadily growing. The imports into England, however, of Chinese produce have fallen off, mainly because China tea has been driven out of the English market by the growth of the India and Ceylon tea trade, and also because the bulk of the China silk is now shipped directly to Lyons and other continental ports instead of to London, as formerly was the rule. The growth of the import of Indian yarn into China has been very rapid. In 1884 the import was

35,000,000 lb and in 1904 it reached 217,171,066 lb. The imports into China from all countries for 1908 were as follows:—

Opium	£4,563,000	Coal and coke . . .	£1,124,000
Cotton goods . . .	14,786,000	Oil, kerosene . . .	2,666,000
Raw cotton	232,000	Rice	3,543,000
Woollen goods . . .	717,000	Sugar	3,514,000
Metals	2,956,000	Fish, &c.	1,028,000

The principal exports from China are silk and tea. These two articles, indeed, up to 1880 constituted more than 80% of the whole export. Owing, however, mainly to the fall in silver, and partly also to cheap ocean freights, it has become profitable to place on the European market a vast number of miscellaneous articles of Chinese produce which formerly found no place in the returns of trade. The silver prices in China did not change materially with the fall in silver, and Chinese produce was thus able to compete favourably with the produce of other countries. The following table shows the relative condition of the export trade in 1880 and 1908:—

Exports of	1880.	1908.
Silk	£9,750,000	£11,055,000
Tea	11,774,000	4,384,000
Miscellaneous . . .	4,058,000	21,448,000
Total	£25,582,000	£36,888,000

In the miscellaneous class the chief items of exports in 1908 were beans and beancake, £3,142,000; raw cotton, £1,379,000; hides, £1,028,000; straw braid, £1,002,000; furs and skin rugs, £760,000; paper, £458,000; and clothing, £177,000. Sugar, tobacco, mats and matting are also exported. The export of all cereals except pulse is forbidden. Of the tea exported in 1908 the greater part went to Russia and Siberia, the United States and Great Britain. There is a regular export of gold amounting on an average to about a million sterling per annum. A part of it would seem to be the hoardings of the nation brought out by the high price of gold in terms of silver, but a part is virgin gold derived from gold workings in Manchuria on the upper waters of the Amur river.

Customs duty is levied on exports as well as imports, both being assessed at rates based on a nominal 5% ad val.

Shipping and Navigation.— Besides the over-sea trade China has a large coasting and river trade which is largely carried on by British and other foreign vessels. During the year 1908, 207,605 vessels, of 83,991,289 tons (86,600 being steamers of 77,955,525 tons), entered and cleared Chinese ports.† Of these 28,445 vessels of 34,405,761 tons were British; 33,539 of 11,998,588 tons, Chinese vessels of foreign type; 103,124 of 4,947,272 tons, Chinese junks; 5496 vessels of 6,585,671 tons, German; 30,708 of 18,055,138 tons, Japanese; 653 of 998,775 tons, American; 3901 of 5,071,689 tons, French; 1033 of 980,635 tons, Norwegian.

Of vessels engaged in the foreign trade only the entrances during the year numbered 38,556 of 12,187,140 tons, and the clearances 36,602 of 12,057,126 tons. The nationality of the vessels (direct foreign trade) was mainly as follows:—

Nationality 1908.	Entrances.		Clearances.	
	No.	Tons.	No.	Tons.
British	4,569	4,678,094	4,614	4,754,087
German	891	1,195,775	928	1,124,872
Norwegian	255	254,211	259	255,295
French	468	629,680	468	616,883
American	136	440,602	131	439,947
Japanese	2,187	2,587,818	2,046	2,461,132
Chinese	29,775	2,001,872	27,888	1,915,258

† The tonnage of the Dutch, Austrian and Russian vessels cleared and entered was in each case between 102,000 and 127,000.

Communications.

External communication is carried on by ancient caravan routes crossing Central Asia, by the trans-Siberian railway, which is

† From *The Statesman's Year Book*, 1910 edition.

increasingly used for passenger traffic, but chiefly by steamship, the steamers being almost entirely owned by foreign companies. There is regular and rapid communication with Europe (via the Suez canal route) and with Japan and the Pacific coast of America. Other lines serve the African and the Australasian trade. The only important Chinese-owned steamers are those of the Chinese Merchants' Steam Navigation Company, which has its headquarters at Shanghai.

Internal communications are by river, canal, road and railway, the railways since the beginning of the 20th century having become a very important factor. In 1898 the Chinese government agreed that all internal waterways should be open to foreign and native steamers, and in 1907 there were on the registers of the river ports for inland water traffic 609 steamers under the Chinese flag and 255 under foreign flags.

Railways.—A short line of railway between Shanghai and Wusung was opened in 1875. The fate of this pioneer railway may be mentioned as an introduction to what follows. The railway was really built without any regular permission from the Chinese government, but it was hoped that, once finished and working, the

irregularity would be overlooked in view of the manifest benefit to the people. This might have been accomplished but for an unfortunate accident which happened on the line a few months after it was opened. A Chinaman was run over and killed, and this event, of course, intensified the official opposition, and indeed threatened to bring about a riot. The working of the line was stopped by order of the British minister, and thereupon negotiations were entered into with a view to selling the line to the Chinese government. A bargain was struck sufficiently favourable to the foreign promoters of the line, and it was further agreed that, pending payment of the instalments which were spread over a year, the line should continue to be worked by the company. The expectation was that when the officials once got the line into their own hands, and found it a paying concern, they would continue to run it in their own interest. Not so, however, did things fall out. The very day that the twelve months were up the line was closed; the engines were dismantled, the rails and sleepers were torn up, and the whole concern was shipped off to the distant island of Formosa, where carriages, axles and all the rest of the gear were dumped on the shore and left for the most part to disappear in the mud. The spacious area of the Shanghai station was cleared of its buildings, and thereon was erected a temple to the queen of heaven by way of purifying the sacred soil of China from such abomination. This put a stop for nearly twenty years to all efforts on the part of foreigners to introduce railways into China. The next step in railway construction was taken by the Chinese themselves, and on the initiative of Li Hung-chang. In 1886 a company was formed under official patronage, and it built a short line, to connect the coal-mines of K'ai-p'ing in Chih-li with the mouth of the Peiho river at Taku. The government next authorized the formation of a Native Merchants' Company, under official control, to build a line from Taku to Tientsin, which was opened to traffic in 1888. It was not, however, till nine years later, viz. in 1897, that the line was completed as far as Peking. A British engineer, Mr Kinder, was responsible for the construction of the railway. Meantime, however, the extension had been continued north-east along the coast as far as Shanhai-kwan, and a farther extension subsequently connected with the treaty port of Niu-chwang. The money for these extensions was mostly found by the government, and the whole line is now known as the Imperial Northern railway. The length of the line is 600 m. Meanwhile the high officials of the empire had gradually been brought round to the idea that railway development was in itself a good thing. Chang Chih-tung, then viceroy of the Canton provinces, memorialized strongly in this sense, with the condition, however, that the railways should be built with Chinese capital and of Chinese materials. In particular, he urged the

making of a line to connect Peking with Hankow for strategic purposes. The government took him at his word, and he was transferred from Canton to Hankow, with authority to proceed forthwith with his railway. True to his purpose, he at once set to work to construct iron-works at Hankow. Smelting furnaces, rolling mills, and all the machinery necessary for turning out steel rails, locomotives, &c., were erected. Several years were wasted over this preliminary work, and over £1,000,000 sterling was spent, only to find that the works after all were a practical failure. Steel rails could be made, but at a cost two or three times what they could be procured for in Europe. After the Japanese War the hope of building railways with Chinese capital was abandoned. A prominent official named Sheng Hsuan-hwai was appointed director-general of railways, and empowered to enter into negotiations with foreign financiers for the purpose of raising loans. It was still hoped that at least the main control would remain in Chinese hands, but the diplomatic pressure of France and Russia caused even that to be given up, and Great Britain insisting on equal privileges for her subjects, the future of railways in China remained in the hands of the various concessionaires. But after the defeat of Russia by Japan (1904-1905) the theory of the undivided Chinese control of railways was resuscitated. The new spirit was exemplified in the contracts for the financing and construction of three railways—the Canton-Kowloon line in

1907, and the Tientsin-Yangtze and the Shanghai-Hangchow-Ning-po lines in 1908. In the first of these instances the railway was mortgaged as security for the loan raised for its construction, and its finance and working were to be modelled on the arrangements obtaining in the case of the Imperial Northern railway, under which the administration, while vested in the Chinese government, was supervised by a British accountant and chief engineer. In the other two instances, however, no such security was offered; the Chinese government undertook the unfettered administration of the foreign capital invested in the lines, and the Europeans connected with these works became simply Chinese employes. Moreover, in 1908 the Peking-Hankow line was redeemed from Belgian concessionaires, a 5% loan of £5,000,000 being raised for the purpose in London and Paris. In that year there was much popular outcry against foreign concessionaires being allowed to carry out the terms of their contract, and the British and Chinese corporation in consequence parted with their concession for the Su-chow, Ning-po and Hang-chow railway, making instead a loan of £1,500,000 to the ministry of communications for the provinces through which the line would run. A double difficulty was encountered in the construction and management of the railways; the reconciliation of the privileges accorded to foreign syndicates and governments with the "Recovery of Rights" campaign, and the reconciliation of the claims of the central government at Peking with the demands of the provincial authorities. As to the foreigners, Great Britain, France, Germany, the United States, Russia and Japan, all had claims and concessions, many of them conflicting; while as between Peking and the provinces there was a quarrel mainly concerned with the spoils and "squeezes" to be obtained by railway construction; in some instances the provinces proved more powerful than the central government, as in the case of the Su-chow-Ning-po line, and notably in the matter of the Tientsin-Pukau (Nanking) railway. In that case the provincial authorities overrode the central government, with the result that "for wholesale jobbery, waste and mismanagement the enterprise acquired unenviable notoriety in a land where these things are generally condoned." The good record of one or two lines notwithstanding, the management of the railways under Chinese control had proved, up to 1910, inefficient and corrupt.¹ Nevertheless, so great was the economic development following the opening of the line, that in Chinese hands the Peking-Hankow railway yielded a profit.

The main scheme of the railway systems of China is simple. It consists of lines, more or less parallel, running roughly north and south, linked by cross lines with coast ports, or abutting on navigable rivers. One great east and west line will run through central China, from Hankow to Sze-ch'uen. Connexion with Europe is afforded by the Manchuria-trans-Siberia main line, which has a general east and west direction. From Harbin on this railway a branch runs south to Mukden, which since 1908 has become an important railway centre. Thence one line goes due south to Port Arthur; another south-east to An-tung (on the Yalu) and Korea; a third south and west to Tientsin and Peking. A branch from the Mukden-Tientsin line goes round the head of the Gulf of Liao-tung and connects Niu-chwang with the Mukden-Port Arthur line. By this route it is 470 m. from Peking to Niu-chwang.

From Peking the trunk line (completed in 1905) runs south through the heart of China to Hankow on the Yangtze-kiang. This section (754 m. long) is popularly known as "the Lu-Han line," from the first part of the names of the terminal stations. The continuation south of this line from Hankow to Canton was in 1910 under construction. Thus a great north and south connexion nearly 2000 m. long is established from Canton to Harbin. From Mukden southward the line is owned and worked by China.

A railway (German concession) starts from Kiao-chow and runs westward through Shan-tung to Chinan Fu, whence an extension farther west to join the main Lu-Han line at Cheng-ting Fu in Chih-li was undertaken. Westward from Cheng-ting Fu a line financed by the Russo-Chinese Bank runs to T'ai-yuen Fu in Shan-si.

Another main north and south railway parallel to, but east of, the Lu-Han line and following more or less the route of the Grand Canal, is designed to connect Tientsin, Su-chow (in Kiang-su), Chin-kiang, Nanking, Shanghai, Hang-chow and Ning-po. The southern section (Nanking, Shanghai, &c.) was open in 1909. This Tientsin-Ning-po railway connects at Chinan-Fu with the Shan-tung lines.

A third north and south line starts from Kiu-Kiang on the Yangtze below Hankow and traversing the centre of Kiang-si province will join the Canton-Hankow line at Shao-Chow in Kwang-tung province. The construction of the first section, Kiu-Kiang to Nanchang (76 m.), began in 1910.

In southern China besides the main Canton to Hankow railway (under construction) a line (120 m. long) runs from Canton to Kowloon (opposite Hong-Kong), and there are local lines running inland from Swatow and Fuchow. The French completed in 1909 a trunk line (500 m. long) from Haiphong in Tong King to Yun-nan Fu, the capital of Yun-nan, some 200 m. being in Chinese territory. The French hold concessions for railways in Kwang-si and Kwang-tung.

¹ See *The Times* of the 28th of March 1910.

The British government has the right to extend the Burma railway system through Yun-nan and north to the Yangtze.

There are local lines in Hu-nan and Ho-nan which connect with the trunk line from Canton to Peking. The Peking-Kalgan line (122 m. long) is a distinct undertaking. The Chinese propose to continue it another 530 m. north-westward to Urga in Mongolia, and an eventual junction with the trans-Siberian railway in the neighbourhood of Lake Baikal is contemplated. This line would greatly shorten the distance between Moscow and Peking.

In 1910 there were open for traffic in China (not reckoning the Russian and Japanese systems in Manchuria, *q.v.*) over 3000 m. of railway, and 1500 m. of trunk lines were under construction.

China is traversed in all directions by roads. Very few are paved or metalled and nearly all are badly kept; speaking generally, the government spends nothing in keeping either the roads or canals in repair. The roads in several instances are subsidiary to the canals and navigable rivers as a means of communication. The ancient trade routes were twelve in number, viz. 1:—

1. The West river route (W. from Canton).
2. The Cheling Pass route (N.W. from Canton).
3. The Meiling Pass route (N. from Canton).
4. The Min river route (N.W. from Fu-chow).
5. The Lower Yangtze route (as far W. as Hu-peh and Hu-nan).
6. The Upper Yangtze route (from I'chang to Sze-ch'uen).
7. The Kwei-chow route.
8. The Han river route (Hankow to Shen-si).
9. The Grand Canal (already described).
10. The Shan-si route.
11. The Kiakhta route.
12. The Manchurian route.

Of the routes named, that by the West river commands the trade of Kwang-si and penetrates to Yun-nan (where it now has to meet the competition of the French railway from Tong King) and Kwei-chow. The Cheling Pass route from Canton is so named as it crosses that pass (1500 ft. high) to reach the water-ways of Hu-nan at Chen-chow on an affluent of the Siang, and thus connects with the Yangtze. The trade of this route—whence in former times the teas of Hu-nan (Oonam) and Hu-peh (Oopaek) reached Canton—has been largely diverted via Shanghai and up the Yangtze. The Canton-Hankow railway also supersedes it for through traffic. The route by the Meiling Pass (1000 ft. high) links Canton and Kiu-kiang. This route is used by the King-te Chen porcelain works to send to Canton the commoner ware, there to be painted with florid and multicoloured designs. The Min river route serves mainly the province of Fu-kien. The Lower Yangtze is a river route, now mainly served by steamers (though the salt is still carried by junks), and the Upper Yangtze is a river route also, but much more difficult of navigation. The Kwei-chow route is up the river Yuen from Changte and the Tung-t'ing lake. The Han river route becomes beyond Sing-nagn Fu a land route over the Tsingling mountains to the capital of Shen-si, and thence on to Kan-suh, Mongolia and Siberia. The Shan-si route from Peking, wholly by road, calls for no detailed account; the Manchurian route is now adequately served by railways. There remains the important Kiakhta route. From Peking it goes to Kalgan (this section is now served by a railway), whence the main route traverses Mongolia, while branches serve Shan-si, Shen-si, Kan-suh, Turkestan, &c. By this route go the caravans bearing tea to Siberia and Russia. Other routes are from Yun-nan to Burma and from Sze-ch'uen province to Tibet.

The government maintains a number of courier roads, which, like the main trade roads, keep approximately to a straight line. These courier roads are sometimes cut in the steep sides of mountains or run through them in tunnels. They are, in the plains, 20 to 25 ft. wide and are occasionally paved. The chief courier roads starting from Peking go to Sze-ch'uen, Yun-nan, Kweilin (in Kwang-si), Canton and Fu-chow. Canals are numerous, especially in the deltas of the Yangtze and Si-kiang.

In the centre and south of China the roads are rarely more than 5 ft. broad and wheeled traffic is seldom possible. Bridges are generally of stone, sometimes of wood—large rivers are crossed by bridges of boats. In the north carts drawn by ponies, mules or oxen are employed; in the centre and south passengers travel in sedan-chairs or in wheelbarrows, or ride on ponies. Occasionally the local authorities employ the *corvée* system to dig out the bed of a canal, but as a rule roads are left to take care of themselves.

Posts and Telegraphs.—Every important city is now connected by telegraph with the capital, and the service is reasonably efficient. In 1907 there were 25,913 m. of telegraph lines. Connexion is also established with the British lines in Burma and the Russian lines in Siberia. The Great Northern Telegraph Company (Danish) and the Eastern Extension Telegraph Company (British) connect Shanghai by cable with Hong-Kong, Japan, Singapore and Europe. An imperial postal service was established in 1896 under the general control of the maritime customs.² By an edict of November 1906 the control

of the postal services was transferred to the Board of Communication. The Post Office serves all the open ports, and every important city in the interior. There were in 1910 some 4000 native post-offices, employing 15,000 persons, of whom about 200 only were foreigners. The treaty powers however, still maintain their separate post offices at Shanghai, and several other treaty ports for the despatch and receipt of mails from Europe. During the years 1901–1908 mail matters increased from ten millions to two hundred and fifty-two millions of items; and the 250 tons of parcels handled to 27,155 tons. In postal matters China has adopted a most progressive attitude. The imperial post conforms in all respects to the universal Postal Union regulations. (G. J.; X.)

IV. GOVERNMENT AND ADMINISTRATION

Changes in the traditional form of government in China—an autocracy based on parental rule—were initiated in 1905 when a commission was appointed to study the forms of government in other countries.³ On the 1st of September 1906 an imperial edict was issued in which the establishment of parliamentary institutions in China was foreshadowed. In 1907 an advisory council—as a sort of stepping-stone to representative government—was established by another edict. On the 27th of August 1908 an edict announced the convocation of a parliament in the ninth year from that date. An edict of the 3rd of December 1908 reaffirmed that of the 27th of August. An edict of the 31st of October 1909 fixed the classes from which an Imperial Assembly (or Senate) was to be selected, and an edict of the 9th of May 1910 gave the names of the senators, all of whom had been nominated by the throne. The assembly as thus constituted consisted of 200 members drawn from eight classes: (1) princes and nobles of the imperial house—16 members; (2) Manchu and Chinese nobles—12 members; (3) princes and nobles of dependencies—14 members; (4) imperial clansmen other than those mentioned—6 members; (5) Peking officials—32 members; (6) eminent scholars—10 members; (7) exceptional property owners—10 members; (8) representatives of provincial assemblies—100 members. The national assembly, which was opened by the regent on the 3rd of October 1910, thus contained the elements of a two-chambered parliament. The edict summoning the assembly contained the following exhortations:—

The members should understand that this assemblage of the senate is an unprecedented undertaking in China and will be the forerunner of the creation of a parliament. They are earnestly desired to devote to it their patriotism and sincerity, to observe proper order, and to fulfil their duties in representing public opinion. Thus it is hoped that our sincere wish to effect constitutional reforms in their proper order and to aim at success may be duly satisfied.

Concurrently with these steps towards a fundamental alteration in the method of government, changes were made in many departments of the state, and an elective element was introduced into the provincial administrations. The old conception of government with such modifications as had been made up to 1910 are set forth below.

The laws of the state prescribe the government of the country to be based on the government of the family.⁴ The emperor is the sole and supreme head of the state, his will being absolute alike in the highest affairs and in the humblest details of private life. The highest form of legislation was an imperial decree, whether promulgated in general terms or to meet a special case. In either form it was the law of the land, and no privilege or prescriptive right could be pleaded against it. All officers of state, all judges and magistrates, hold their offices entirely at the imperial pleasure. They can be dismissed, degraded, punished, without reason assigned and without form of trial—even without knowing by whom or of what they are accused. The monarch has an advisory council, but he is not bound by its advice, nor need he pretend that he is acting by and with its advice and concurrence. This condition of affairs dates back to a primitive state of society, which probably existed among the Chinese who first developed a civilized form of government. That this system should have been maintained in China through many centuries

public in 1876. An organized service for the conveyance of government despatches has existed in China for many centuries, and the commercial classes maintain at their own expense a system ("letter hongs") for the transmission of correspondence.

³ For the causes leading to this movement and the progress of reform see § History.

⁴ For recent authoritative accounts of the government of China see H. B. Morse, *The Trade and Administration of the Chinese Empire*, chap. iii.; Richard's *Comprehensive Geography*, &c., Bk. I. § v., and *The Statesman's Year Book*.

¹ See Morse, *op. cit.* chap. x.

² The maritime customs had established a postal service for its own convenience in 1861, and it first gave facilities to the general

The Chinese conception of government.

is a fact into the causes of which it is worth while to inquire. We find it pictured in the records which make up the *Book of History*, and we find it enforced in the writings of the great apostle of patriarchal institutions, Confucius, and in all the other works which go to make up the Confucian Canon. The reverence with which these scriptures are viewed was the principal means of perpetuating the primitive form of Chinese imperialism. The contents of their pages formed the study of every schoolboy, and supplied the themes at the competitive examinations through which every one had to pass who sought an official career. Thus the mind of the nation was constantly and almost exclusively turned towards them, and their dogmas became part and parcel of the national training. The whole theory of government is the embodiment of parental love and filial piety. As the people are the children of the emperor, so is he the *T'ien-tszé* or the Son of Heaven.

In practice the arbitrary power of the emperor is tempered in several ways. Firstly, although the constitution conferred this absolute and unchecked power on the emperor, it was not for his gratification but that he might exercise it for the good of his people. He rules by divine authority, and as the vicergerent of heaven upon earth. If he rules corruptly or unjustly, heaven will send disasters and calamity on the people as a reproof; if the rule becomes tyrannical, heaven may withdraw its favour entirely, and then rebellion may be justified. The Manchu dynasty came to the throne as foreign conquerors, nevertheless they base their right to rule, not on the power of the sword, but on divine approval. On this moral ground they claim the obedience of their subjects, and submit themselves to the corresponding obligations. The emperor, unless he has gained the throne by conquest, is selected by his predecessor or by the imperial family in conclave. He is usually a son (but seldom the eldest son) of his predecessor, and need not be the child of the empress-consort,¹ though (other things being equal) a son of the empress is preferred. Failing a son another prince of the imperial house is chosen, the choice being properly among the princes of a generation below that of the preceding emperor, so that the new emperor may be adopted as the son of his predecessor, and perform for him the due ceremonies at the ancestral tablets. Apart from this ancestor-worship the emperor worships only at the Altar of Heaven, leaving Buddhism, Taoism, and any other form of worship to his subjects. The emperor's sacrifices and prayers to heaven are conducted with great parade and ceremony. The chief of these state observances is the sacrifice at the winter solstice, which is performed before sunrise on the morning of the 21st of December at the Temple of Heaven. The form of the altar is peculiar.

"It consists of a triple circular terrace, 210 ft. wide at the base, 150 in the middle, and 90 at the top. . . . The emperor, with his immediate suite, kneels in front of the tablet of Shang-ti (The Supreme Being, or Heaven), and faces the north. The platform is laid with marble stones, forming nine concentric circles; the inner circle consists of nine stones, cut so as to fit with close edges round the central stone, which is a perfect circle. Here the emperor kneels, and is surrounded first by the circles of the terraces and their enclosing walls, and then by the circle of the horizon. He then seems to himself and to his court to be in the centre of the universe, and turning to the north, assuming the attitude of a subject, he acknowledges in prayer and by his position that he is inferior to heaven, and to heaven alone. Round him on the pavement are the nine circles of as many heavens, consisting of nine stones, then eighteen, then twenty-seven, and so on in successive multiples of nine till the square of nine, the favourite number of Chinese philosophy, is reached in the outermost circle of eighty-one stones."

On this occasion, also, a bullock of two years old, and without blemish, is offered as a whole burnt-offering in a green porcelain furnace which stands close beside the altar. The emperor's life is largely occupied with ceremonial observances, and custom ordains that except on state occasions he should not leave the walls of the palace.

For his knowledge of public affairs the emperor is thus largely dependent upon such information as courtiers and high officers of state permit to reach him.² The palace eunuchs have often exercised great power, though their influence has been less under the Manchus than was the case during previous dynasties. Though in theory the throne commands the services and money of all its subjects yet the crown as such has no revenues peculiarly its own. It is dependent on contributions levied through the high officials on the several provinces, subject always to the will of the people, and without their concurrence and co-operation nothing can be done.³ The power of the purse and the power of the sword are thus exercised mediately, and the autocratic power is in practice transferred to the general body of high functionaries, or to that clique which for the time being has

¹ The empress-consort is chosen by the emperor from a number of girls selected by his ministers from the families of Manchu nobles. From the same candidates the emperor also selects secondary-empresses (usually not more than four). Concubines, not limited in number, are chosen from the daughters of Manchu nobles and freemen. All the children are equally legitimate.

² Recent emperors have been children at accession and have been kept in seclusion.

³ See "Democratic China" in H. A. Giles, *China and the Chinese*.

the ear of the emperor, and is united enough and powerful enough to impose its will on the others.

The functionaries who thus really wield the supreme power are almost without exception civil officials. Naturally the court has shown an inclination to choose Manchu rather than Chinese, but of late years this preference has become less marked, and in the imperial appointments to provincial administrations the proportion of Manchus chosen was at the beginning of the 20th century not more than one-fifth of the whole number. The real reason for this change is the marked superiority of the Chinese, in whose hands the administration is stated to be safer for the Manchu dynasty. Practically all the high Chinese officials have risen through the junior ranks of the civil service, and obtained their high position as the reward—so it must be presumed—of long and distinguished public service.

Through the weakness of some of the emperors the functions of the central government gradually came to be to check the action of the provincial governments rather than assume a direct initiative in the conduct of affairs. "The central government may be said to criticize rather than to control the action of the provincial administrations, wielding, however, at all times the power of immediate removal from his post of any official whose conduct may be found irregular or considered dangerous to the stability of the state."⁴ This was written in 1877, and since then the pressure of foreign nations has compelled the central government to assume greater responsibilities, and the empire is now ruled from Peking in a much more effective manner than was the case when Lord Napier in 1834 could find no representative of the central government with whom to transact business.

If the central authorities take the initiative, and issue orders to the provincial authorities, it, however, does not follow that they will be carried out. The orders, if unwelcome, are not directly disobeyed, but rather ignored, or specious pleas are put forward, showing the difficulty or impossibility of carrying them out at that particular juncture. The central government always wields the power of removing or degrading a recalcitrant governor, and no case has been known where such an order was not promptly obeyed. But the central government, being composed of officials, stand by their order, and are extremely reluctant to issue such a command, especially at the bidding of a foreign power. Generally the opinion of the governors and viceroys has great weight with the central government.

Under the Ming dynasty the *Nuiko* or Grand Secretariat formed the supreme council of the empire. It is now of more honorific than actual importance. Active membership is limited to six persons, namely, four grand secretaries and two assistant grand secretaries, half of whom, according to a general rule formerly applicable to nearly all the high offices in Peking, must be Manchu and half Chinese. It constitutes the imperial chancery or court of archives, and admission to its ranks confers the highest distinction attainable by Chinese officials, though with functions that are almost purely nominal. Members of the grand secretariat are distinguished by the honorary title of *Chung-fang*. The most distinguished viceroys are usually advanced to the dignity of grand secretary while continuing to occupy their posts in the provinces. The best known of recent grand secretaries was Li Hung-chang.

Under the Manchu dynasty the Grand Council (*Chün Ch'ü Ch'u*) became the actual privy council of the sovereign, in whose presence its members daily transacted the business of the state. This council is composed of a small knot of men holding various high offices in the government boards at Peking. The literal meaning of *Chün Ch'ü Ch'u* is "place of plans for the army," and the institution derived its name from the practice established by the early emperors of the Manchu dynasty of treating public affairs on the footing of a military council. The usual time of transacting business is from 4 to 6 a.m. In addition to the grand council and the grand secretariat there were boards to supervise particular departments. By a decree of the 6th of November 1906 the central administration was remodelled, subsequent decrees making other changes. The administration in 1910 was carried on by the following agencies:—

A. *Councils*.—(1) The grand council. Its title was modified in 1906 and it is now known as the Grand Council of State Affairs or Privy Council. It has no special function, but deals with all matters of general administration and is presided over by the emperor (or regent). (2) The Grand Secretariat. This body gained no increase of power in 1906. (3) The advisory council or senate (*Tu Chêng Yuen*) created in 1907 and containing representatives of each province. It includes all members of the grand council and the grand secretariat and the heads of all the executive departments.⁵ The members of these three bodies form advisory cabinets to the emperor.

B. *Boards*.—Besides boards concerned with the affairs of the court there were, before the pressure of foreign nations and the movement for reform caused changes to be made, six boards charged with the

⁴ W. F. Mayers, *The Chinese Government* (1878).

⁵ This body is superseded by the Imperial Senate summoned to meet for the first time on the 3rd of October 1910.

China governed by its civil service.

Functions of the central government.

Departments of the central administration.

conduct of public affairs. They were: (1) *Li Pu*, the Board of Civil Appointments, controlling all appointments in the civil service from the rank of district magistrate upwards. (2) *Hu Pu*, the Board of Revenue, dealing with all revenues which reached the central government. (3) *Li Pu*, the Board of Ceremonies. (4) *Ping Pu*, the Board of War. It controlled the provincial forces. The Manchu forces were an independent organization attached to the palace. (5) *Hsing Pu*, the Board of Punishments. It dealt with the criminal law only, especially the punishment of officials guilty of malpractices. (6) *Kung Pu*, the Board of Works. Its work was limited to the control of the construction and repair of official residences.

As rearranged and enlarged there are now the following boards, given in order of precedence:—

1. *Wai-wu Pu*.—This was established in 1901 in succession to the *Tsung-li Yamên*,¹ which was created in 1861 after the Anglo-Chinese War in 1860 as a board for foreign affairs. Previous to that war, which established the right of foreign powers to have their representatives in Peking, all business with Western nations was transacted by provincial authorities, chiefly the viceroy at Canton. The only department at Peking which dealt specially with foreign affairs was the *Li Fan Yuen*, or board of control for the dependencies, which regulated the affairs of Mongolia, Tibet and the tributary states generally. With the advent of formally accredited ambassadors from the European powers something more than this was required, and a special board was appointed to discuss all questions with the foreign envoys. The number was originally four, with Prince Kung, a brother of the emperor Hien Fêng, at their head. It was subsequently raised to ten, another prince of the blood, Prince Ching, becoming president. The members were spoken of collectively as the prince and ministers. For a long time the board had no real power, and was looked on rather as a buffer between the foreign envoys and the real government. The importance of foreign affairs, however, especially since the Japanese War, identified the *Yamên* more with the grand council, several of the most prominent men being members of both. At the same time that the *Tsung-li Yamên* was created, two important offices were established in the provinces for dealing with foreign commercial questions, viz. the superintendencies of trade for the northern and southern ports. The negotiations connected with the Boxer outbreak proved so conclusively that the machinery to the *Tsung-li Yamên* was of too antiquated a nature to serve the new requirements, that it was determined to abolish the *Yamên* and to substitute for it a board (*Pu*) to be styled the *Wai-wu Pu*, or "board of foreign affairs."

2. Board of Civil Appointments.
3. Board of Home Affairs.
4. Board of Finance and Paymaster General's Department.
5. Board of Ceremonies.
6. Army Board or Ministry of War (instituted 1906).²
7. Board of Judicature.
8. Board of Agriculture, Works and Commerce (instituted 1903).
9. Board of dependencies.
10. Board of Education (instituted 1903).
11. Board of Communications (instituted 1906).

Each board has one president and two vice-presidents, with the exception of the *Wai-wu Pu*, which has a comptroller-general and two presidents, and the Boards of War and Education, each of which has a comptroller-general in addition to the president. According to the decree of 1906 no distinction, in filling up the various boards, is to be made between Manchu and Chinese.

Besides the boards named there are other departments of state, some of them not limited to any one branch of the public service. The more important are those that follow:—

The Censorate (*Tu Ch'a Yuen*).—An institution peculiar to China. The constitution provides a paid body of men whose duty it is to inform the emperor of all facts affecting the welfare of the people and the conduct of government, and in particular to keep an eye on the malfeasance of his officers. These men are termed *Yü shih* (imperial recorder), generally translated censors. Their office has existed since the 3rd century B.C. The body consists of two presidents, a Chinese and a Manchu, 24 supervising censors attached to the ministries at Peking, and 56 censors, divided into fifteen divisions, each division taking a particular province or area, so as to embrace the whole eighteen provinces, besides one metropolitan division. The censors are privileged to animadvert on the conduct even of the emperor himself; to censure the manner in which all other officials perform or neglect their duties and to denounce them to the throne. They receive appeals made to the emperor, either by the people against the officials or by subordinate officials against their superiors. They exercise, in accord with the Board of Justice, an oversight over all criminal cases and give their opinion whenever the death penalty is

to be pronounced. They superintend the working of the different boards and are sometimes sent to various places as imperial inspectors, hence they are called *êrh mu kuan* (the eyes and ears of the emperor). The censors exercise their office at times with great boldness; their advice if unpalatable may be disregarded and the censor in question degraded. The system of the censorate lends itself to espionage and to bribery, and it is said to be more powerful for mischief than for good. With the growth in influence of the native press the institution appears to lose its *raison d'être*.

The grand court of revision (*Ta-li sze*) or Court of Cassation exercises, in conjunction with the Board of Justice and the Censorate, a general supervision over the administration of the criminal law. These bodies are styled collectively *San-fah sze* (the Three High Justices).

The Hanlin College (*Hanlin Yuen*, literally Forest of Pencils) is composed of all the literate who have passed the palace examination and obtained the title of *Hanlin* or imperial academicist. It has two chancellors—a Manchu and a Chinese. Its functions are of a purely literary character and it is of importance chiefly because the heads of the college, who are presumably the most eminent scholars of the empire, have the right of advising the throne on all public affairs, and are eligible as members of the grand council or of the *Wai-wu Pu*. The Chinese set fire to it during the fighting in Peking in June 1900 in the hope of burning out the adjoining British legation. The whole of the library, containing some of the most valuable manuscripts in the world, was destroyed.

Each of the eighteen provinces of China proper, the three provinces of Manchuria and the province of Sin-kiang are ruled by a viceroy placed over one, two and in one instance three provinces, or by a governor over a single province either under a viceroy or depending directly on the central government, the viceroy or the governor being held responsible to the emperor for the entire administration, political, judicial, military and fiscal. The most important viceroalties are those of Chih-li, Liang-kiang and Liang-kwang. The viceroalty of Liang-kiang comprises the provinces of Kiang-su, Ngan-hui and Kiang-si. The viceroy resides at Nanking and hence is sometimes called the viceroy of Nanking. Similarly the viceroy of Liang-kwang (comprising the provinces of Kwang-tung and Kwang-si) through having his residence at Canton is sometimes styled the viceroy of Canton. The three provinces adjoining the metropolitan province of Chih-li—Shan-tung, Shan-si and Hon-an—have no viceroys over them; seven provinces—including Chih-li—have no governors, the viceroy officiating as governor. In provinces where there are both a viceroy and a governor they act conjointly, but special departments are administered by the one rather than the other. The viceroy controls the military and the salt tax; the governor the civil service generally.

The viceroy or governor is assisted by various other high officials, all of whom down to the district magistrate are nominated from Peking. The chief officials are the treasurer, the judicial commissioner or provincial judge, and the commissioner of education (this last post being created in 1903). The treasurer controls the finances of the whole province, receiving the taxes and paying the salaries of the officials. The judge, the salt commissioner, and the grain collector are the only other officials whose authority extends over the whole province. Each province is subdivided into prefectures ruled by prefects, and each prefecture into districts ruled by a district magistrate, *Chih-hsien*, the official through whom the people in general receive the orders of the government. Two or more prefectures are united into a *tao* or circuit, the official at the head of which is called a *Taot'ai*. Each town and village has also its unofficial governing body of "gentry."³ The officials appointed from Peking hold office for three years, but they may be re-appointed once, and in the case of powerful viceroys they may hold office for a prolonged period. Another rule is that no official is ever appointed to a post in the province of his birth; a rule which, however, did not apply to Manchuria. The Peking authorities take care also in making the high appointments to send men of different political parties to posts in the same province.

The edict of the 6th of November 1906 initiating changes in the central administration was accompanied by another edict outlining changes in the provincial government, and an edict of the 22nd of July 1908 ordered the election of provincial assemblies. The edict made it clear that the functions of the assemblies were to be purely consultative. The elections took place according to the regulations, the number of members allotted to each province varying from 30 (Kirin province, Manchuria, and two others) to 140 in Chih-li. The franchise was restricted, but the returns for the first elections showed nearly 1000 voters for each representative. The first meetings of the assemblies were held in October 1909.

¹ Yamên is the name given to the residences of all high officials. *Tsung-li Yamên* = the bureau for managing each (foreign) kingdom's affairs.

² An edict of the 15th of July 1909 created a naval and military advisory board. Up to that time the navy was controlled by the viceroys at Canton, Nanking, Fu-chow and Tientsin; the viceroys at Canton and Tientsin being ministers superintendent of the southern and northern ports respectively.

³ Thus in 1910 Prince Ching, president of the grand council, was, for the third time, impeached by censors, being denounced as an "old treacherous minister," who filled the public service with a crowd of men as unworthy as himself. The censor who made the charge was stripped of his office (see *The Times* of the 30th of March 1910).

⁴ For details of local government see Richard's *Comprehensive Geography*, 1908 edition, pp. 301 et seq.

The Civil Service.—The bureaucratic element is a vital feature in the government of China, the holding of office being almost the only road to distinction. Officials are by the Chinese called collectively *Kwan* (rulers or magistrates) but are known to foreigners as mandarins (*q.v.*). The mandarins are divided into nine degrees, distinguished by the buttons worn on the top of their caps. These are as follows:—first and highest, a plain red button; second, a flowered red button; third, a transparent blue button; fourth, an opaque blue button; fifth, an uncoloured glass button; sixth, an opaque white shell button; seventh, a plain gilt button; eighth, a gilt button with flowers in relief; ninth, a gilt button with engraved flowers. The buttons indicate simply rank, not office. The peacock feathers worn in their hats are an order granted as reward of merit, and indicate neither rank nor office. The Yellow Jacket similarly is a decoration, the most important in China.

The ranks of the civil service are recruited by means of examinations. Up to the beginning of 1906 the subjects in which candidates were examined were purely Chinese and literary with a smattering of history. In 1906 this system was modified and an official career was opened to candidates who had obtained honours in an examination in western subjects (see § *Education*). The old system is so closely identified with the life of China that some space must be devoted to a description of it.

As a general rule students preparing for the public examination read with private tutors. There were neither high schools nor universities where a regular training could be got. In most of the provincial capitals, and at some other places, there were indeed institutions termed colleges, supported to some extent from public funds, where advanced students could prosecute their studies; but before the movement initiated by the viceroy Chang Chih-tung after the China-Japan War of 1894, they hardly counted as factors in the national education. The private tutors, on the other hand, were plentiful and cheap. After a series of preliminary trials the student obtained his first qualification by examination held before the literary chancellor in the prefecture to which he belonged. This was termed the *Siuls'ai*, or licentiate's degree, and was merely a qualification to enter for the higher examinations. The number of licentiate degrees to be given was, however, strictly limited; those who failed to get in were set back to try again, which they might do as often as they pleased. There was no limit of age. Those selected next proceeded to the great examination held at the capital of each province, once in three years, before examiners sent from Peking for the purpose. Here again the number who passed was strictly limited. Out of 10,000 or 12,000 competitors only some 300 or 350 could obtain degrees. The others, as before, must go back and try again. This degree, termed *Chü jên*, or provincial graduate, was the first substantial reward of the student's ambition, and of itself qualified for the public service, though it did not immediately nor necessarily lead to active employment. The third and final examination took place at Peking, and was open to provincial graduates from all parts of the empire. Out of 6000 competitors entering for this final test, which was held triennially, some 325 to 350 succeeded in obtaining the degree of *Chin shih*, or metropolitan graduate. These were the finally selected men who became the officials of the empire.

Several other doors were, however, open by which admission to the ranks of bureaucracy could be obtained. In the first place, to encourage scholars to persevere, a certain number of those who failed to reach the *chü jên*, or second degree, were allowed, as a reward of repeated efforts, to get into a special class from which selection for office might be made. Further, the government reserved to itself the right to nominate the sons and grandsons of distinguished deceased public servants without examination. And, lastly, by a system of "recommendation," young men from favoured institutions or men who had served as clerks in the boards, might be put on the roster for substantive appointment. The necessities of the Chinese government also from time to time compelled it to throw open a still wider door of entry into the civil service, namely, admission by purchase. During the T'ai'ping rebellion, when the government was at its wits' end for money, formal sanction was given to what had previously been only intermittently resorted to, and since then immense sums of money have been received by the sale of patents of rank, to secure either admission to office or more rapid promotion of those already employed. As a result of this policy, the country has been saddled with thousands of titular officials far in excess of the number of appointments to be given away. Deserving men were kept waiting for years, while inferior and less capable officials were pushed ahead, because they had money wherewith to bribe their way. Nevertheless the purchase system admitted into the service a number of men free from that bigoted adherence to Confucian doctrine which characterizes the literary classes, and more in touch with modern progress.

All candidates who succeed in entering the official ranks are eligible

for active employment, but as the number of candidates is far in excess of the number of appointments a period of weary waiting ensues. A few of the best scholars get admitted at once into the Hanlin college or into one or other of the boards at Peking. The rest are drafted off in batches to the various provinces to await their turn for appointment as vacancies occur. During this period of waiting they are termed "expectants" and draw no regular pay. Occasional service, however, falls in their way, as when they are commissioned for special duty in outlying districts, which they perform as *Weiyuens*, or deputies of the regular officials. The period of expectancy may be abridged by recommendation or purchase, and it is generally supposed that this last lever must invariably be resorted to to secure any lucrative local appointment. A poor but promising official is often, it is said, financed by a syndicate of relations and friends, who look to recoup themselves out of the customary perquisites which attach to the post. Appointments to the junior provincial posts are usually left to the provincial government, but the central government can always interfere directly. Appointments to the lucrative posts of customs, *laol'ai*, at the treaty ports are usually made direct from Peking, and the officer selected is neither necessarily nor usually from the provincial staff. It would perhaps be safe to say that this appointment has hitherto always been the result of a pecuniary arrangement of greater or less magnitude.

During the first five years (1906-1910) of the new method, by which candidates for the civil service were required, in addition to Chinese classics, to have a knowledge of western science, great efforts were made in several provinces to train up a better class of public official. The old system of administration had many theoretical excellences, and there had been notable instances of upright administration, but the regulation which forbade a mandarin to hold any office for more than three years made it the selfish interest of every office-holder to get as much out of the people within his jurisdiction as he possibly could in that time. This corruption in high places had a thoroughly demoralizing effect. While among the better commercial classes Chinese probity in business relations with foreigners is proverbial, the people generally set little or no value upon truth, and this has led to the use of torture in their courts of justice; for it is argued that where the value of an oath is not understood, some other means must be resorted to to extract evidence.

Justice.—The *Chih-Hsien* or district magistrate decides ordinary police cases; he is also coroner and sheriff, he hears suits for divorce and breach of promise, and is a court of first instance in all civil cases; "the penalty for taking a case first to a higher court is fifty blows with the bamboo on the naked thigh."¹ Appeal from the *Hsien* court lies to the *Fu*, or prefectural court, and thence cases may be taken to the provincial judge, who signs death warrants, while there are final courts of appeal at Peking. Civil cases are usually settled by trade guilds in towns and by village elders, or by arbitration in rural districts. Reference has been made to the use of torture. Flogging is the only form of torture which has been allowed under the Manchus. The obdurate witness is laid on his face, and the executioner delivers his blows on the upper part of the thighs with the concave side of a split bamboo, the sharp edges of which mutilate the sufferer terribly. The punishment is continued until the man either supplies the evidence required or becomes insensible. Punishment by bamboo was formally abolished by imperial edict in 1905, and other judicial reforms were instituted. They remained largely inoperative, and even in Shanghai, under the eyes of foreign residents, gross cases of the infliction of torture occurred in 1909.²

For capital offences the usual modes of inflicting the extreme penalty of the law are—in bad cases, such as parricides, "cutting to pieces," and for less aggravated crimes either strangulation or decapitation. The culprit who is condemned to be "cut to pieces" is fastened to a cross, and while thus suspended cuts are made by the executioner on the fleshy parts of the body; and he is then beheaded. Strangulation is reserved for lesser degrees of guilt, it being considered a privilege to pass out of life with a whole body. When it has been granted to a criminal of rank thus to meet his end, a silken cord is sent to him at his own home. No explanatory message is considered necessary, and he is left to consummate his own doom. Popular sentiment regards decapitation as a peculiarly disgraceful mode of death. Constant practice makes the executioners wonderfully expert in the performance of their office. No block or resting-place for the head is used. The neck is simply outstretched to its full length by the aid of an assistant, and one blow invariably leaves the body headless.

The laws are in accord with the principle which regards the family as a unit. Thus there is no bankruptcy law—if a debtor's own estate will not suffice to pay his debts the deficiency must be made good by his relatives; if a debtor absconds his immediate family are imprisoned. By analogy if one member of a party commits an offence and the guilty person cannot be detected, the whole party must suffer. Foreigners residing in China resented the application of this principle of law to themselves. As a result extra-territorial rights were sought by European powers. They were secured by Russia as early as 1689,

**Bribery
and
torture.**

**Consular
jurisdiction.**

¹ Morse, *op. cit.*, 1908 edition, p. 70.

² See *The Times* of the 28th of February 1910.

but it was not until 1843 that any other nation acquired them. In that year Great Britain obtained the right to try British subjects by its own consuls, a right secured in more explicit terms by the United States and France in 1844. Now eighteen powers, including Japan, have consular courts for the trial of their own subjects according to the laws of their native lands. Mixed courts have also been established, that is, a defendant is tried in the court of his own nationality, the court giving its decision under the supervision of a representative of the plaintiff's nationality. In practice the Chinese have seldom sent representatives to sit on the bench of consular courts, but, as the Europeans lack confidence in the administration of Chinese justice, no suit brought by a foreigner against a Chinese is decided without the presence of an assessor of the plaintiff's nationality.

Defence.—The Chinese constitution in the period before the reform edicts of 1905-1906 provided for two independent sets of military organizations—namely, the Manchu army and the several provincial armies. On the establishment

Army. of the dynasty in 1644 the victorious troops, composed mainly of Manchus, but including also Mongols and Chinese, were permanently quartered in Peking, and constituted a hereditary national army. The force was divided into eight banners, and under one or other of these all Manchus and all the descendants of the members of other nationalities were enrolled. They form the bulk of the population of the "Tatar city" of Peking. Each adult male was by birth entitled to be enrolled as a soldier, and by virtue of his enrolment had a right to draw rations—i.e. his allowance of the tribute rice, whether on active service or not. Detachments from one or other of the banners were stationed as garrisons in the chief provincial centres, as at Canton, Fuchow and Hang-chow, &c., and their descendants still occupy the same position. As a fighting force the Manchu garrisons both in the capital and in the provinces had long become quite effete. In the capital, however, the *élite* of the Manchu soldiery were formed into a special corps termed the Peking Field Force. Its nominal strength was 20,000, the men were armed and drilled after the European fashion, and fairly well paid. There were other corps of picked Manchus better paid and better armed than the ordinary soldier, and it was computed that in 1901 the Manchu army in or near Peking could muster 40,000, all more or less efficient.

The second organization was termed the army of the Green Standard, being the Chinese provincial forces. The nominal strength was from 20,000 to 30,000 for each province, or about 500,000 in all; the actual strength was about one-third of this. They were enrolled to keep the peace within their own province, and resembled a militia or local constabulary rather than a national army. They were generally poorly paid and equally badly drilled and armed.

The only real fighting force which China possessed at the beginning of the 20th century was made up of certain special corps which were not provided for in the constitution, and consequently used to be termed *yung*, "braves," or irregulars, but had acquired various distinctive names. They were enlisted by provincial governors, and all had some smattering of foreign drill. They were also fairly well paid and armed. After the Chino-Japanese War of 1894-95 some of these corps were quartered near Peking and Tientsin, and came generally to be spoken of as the Army of the North.

An imperial decree issued in 1901 after the Boxer rising ordered the reorganization of the military forces of the empire, and on provincial lines something was accomplished—especially in Chih-li under Yuan Shih-k'ai, who practically created "the Army of the North." It was not, however, until after the Russo-Japanese War that determined efforts were made to organize a national army on western lines; an army which should be responsible to the central government and not dependent upon the provincial administrations. A decree of 1905 provided (on paper) for training schools for officers in each of the provinces, middle grade military schools in selected provinces, and a training college and military high school in Peking. The Army Board was reorganized and steps taken to form a general staff. Considerable progress had been made by 1910 in the evolution of a body of efficient officers. In practice the administration remained largely provincial—for instance the armament of the troops was provided by the provincial governors and was far from uniform. The scheme¹ contemplated the creation of a force about 400,000 strong in 36 divisions and in two armies, the northern and the southern. Recruitment is on the voluntary principle, except in the case of the Manchus, who apparently enter the new army instead of the "eight banners." The terms of service are three years with the colours, three in the reserve and four in the territorial army. The Japanese system of training is followed. Reservists are called out for 30 days every year and the territorialists for 30 days every other year.

Up to 1909 six divisions and one mixed brigade of the northern army had been organized in Shan-tung, Chih-li and Ho-nan; elsewhere three divisions and six mixed brigades; total strength about 60,000 with 350 guns. (These figures do not include all the provincial foreign trained troops.) The efficiency of the troops varied; the northern army was superior to the others in training and armament. About a third of the 60,000 men of the new army were in 1909 stationed in Manchuria. (See also § *History*.)

¹ See *The Statesman's Year-Book* (1910 edition).

An imperial edict of the 15th of September 1907 reorganized the army of the Green Standard. It was placed under the control of the minister of war and formed in battalions and squadrons. The duty of the troops in peace time remained much as previously. In war they pass under the control of regular officers, though their use outside their own provinces does not seem to be contemplated.

The Chinese navy in 1909 consisted of the 4300 ton cruiser "Hai Chi" (two 8-in., ten 4.7-in. guns) of 24 knot original speed, three 3000 ton cruisers, "Hai Yung," "Hai Schew" and "Hai Shen" (three 6-in., eight 4-in. guns) of 19.5 knot original speed, some modern gunboats built in Japan, a few miscellaneous vessels and some old torpedo boats. With the destruction of the northern fleet by the Japanese at the capture of Wei-hai-wei in 1895, the Chinese navy may be said to have ceased to exist. Previously it consisted of two divisions, the northern and southern, of which the former was by far the more formidable. The southern was under the control of the viceroy of Nanking, and took no part in the Chino-Japanese War. While the northern fleet was grappling in a death-struggle, the southern was lying snugly in the Yangtze waters, the viceroy of Nanking apparently thinking that as the Japanese had not attacked him there was no reason why he should risk his ships.

The New Scheme.—An edict of the 15th of July 1909 created a naval and military advisory board. Nimrod Sound, centrally situated on the coast of Cheli-kiang, was chosen as naval base, and four naval schools were ordered to be established: a navigation school at Chifu, an engineering school at Whampoa, a school for naval artificers at Fuchow, and a gunnery and musketry school at Nimrod Sound. A superior naval college was founded at Peking. The coast defences were placed under the control of the naval department, and the reorganization of the dockyards undertaken. During 1910 orders for cruisers were placed abroad.

Arsenals and Dockyards.—After the loss of Port Arthur, China possessed no dockyard which could dock vessels over 3000 tons. Many years ago the Chinese government established at Fuchow a shipbuilding yard, placing it in the hands of French engineers. Training schools both for languages and practical navigation were at the same time organized, and a training ship was procured and put under the command of a British naval officer. Some twenty-five or thirty small vessels were built in the course of a few years, but gradually the whole organization was allowed to fall into decay. Except for petty repairs this establishment was in 1909 valueless to the Chinese government. There were also small dockyards at Kiang-nan (near Shanghai), Whampoa and Taku. There are well-equipped arsenals at Shanghai and at Tientsin, but as they are both placed up shallow rivers they are useless for naval repairs. Both are capable of turning out heavy guns, and also rifles and ammunition in large quantities. There are also military arsenals at Nanking, Wuchang, Canton and Chêngtu.

Forts.—A great number of forts and batteries have been erected along the coast and at the entrance to the principal rivers. Chief among these, now that the Taku forts formerly commanding the entrance to Tientsin have been demolished, are the Kiangyin forts commanding the entrance to the Yangtze, the Min forts at the entrance of the Fuchow river, and the Bogue forts at the entrance to the Canton river. These are supplied with heavy armament from the Krupp and Armstrong factories.

Finance.

In fiscal matters, as for many other purposes, the Chinese empire is an agglomeration of a number of quasi-independent units. Each province has a complete administrative staff, collects its own revenue, pays its own civil service, and other charges placed upon it, and out of the surplus contributes towards the expenses of the imperial government a sum which varies with the imperiousness of the needs of the latter and with its own comparative wealth or poverty. The imperial government does not collect directly any part of the revenues, unless the imperial maritime customs be excepted, though these, too, pass through the books of the provincial authorities.²

It has hitherto been extremely difficult to obtain anything like trustworthy figures for the whole revenue of China, for the reason that no complete statistics are published by the central government at Peking.³ The only available data are, first, the returns published by the imperial maritime customs for the duties levied on foreign trade; and, secondly, the memorials sent to Peking by the provincial authorities on revenue matters, certain of which are published from time to time in the *Peking Gazette*.

² A few of the old native customs stations, which are deemed prerequisites of the imperial court, may also be excepted, as, for instance, the native custom-house at Canton, Hwei Kwan on the Grand Canal, and various stations in the neighbourhood of Peking.

³ The production of a budget in 1915 was promised in one of the reform edicts of 1908.

These are usually fragmentary, being merely reports which the governor has received from his subordinates, detailing, as the case may be, the yield of the land tax or the likin for his particular district, with a dissertation on the causes which have made it more or less than for the previous period. Or the return may be one detailing the expenditure of such and such a department, or reporting the transmission of a sum in reply to a requisition of the board of revenue, with a statement of the source from which it has been met. It is only by collating these returns over a long period that anything like a complete statement can be made up. And even then these returns do not represent anything like the total of taxation paid by the people, but, as far as they go, they may be taken to represent the volume of taxation on which the Peking government can draw revenue.

The following table, taken from a memorandum by Sir Robert Hart, dated the 25th of March 1901, shows the latest official estimate (up to 1910) of the revenue and expenditure of China:—

Revenue.		Taels. ¹
Land tax		26,500,000
Provincial duties		1,600,000
" receipts (various)		1,000,000
Grain commutation		3,100,000
Salt gabelle		13,500,000
Li-kin		16,000,000
Native customs		2,700,000
Maritime customs:—		
General cargo		17,000,000
Foreign opium		5,000,000
Native opium		1,800,000
Total		88,200,000
Expenditure.		Taels.
Provincial		20,000,000
Military and naval		35,000,000
Metropolitan		10,000,000
Bannermen (Manchu "soldiers")		1,380,000
Palace		1,100,000
Customs		3,600,000
Legations		1,000,000
River works		940,000
Railways		800,000
Loans		24,000,000
Contingent reserve		3,300,000
Total		101,120,000

A calculation of revenue from all sources published by the Shanghai *Shen Pao* in 1908, apparently derived from official sources, gave a total revenue of 105,000,000 taels, or about 15 million sterling. This sum is obviously less than the actual figures. In 1907 Mr H. B. Morse, commissioner of customs and statistical secretary in the inspectorate general of customs, drew up the following table based on the amounts presumed to be paid by the tax payer:—

	Imperial Administration.	Provincial Administration.	Local Administration.
	Taels.	Taels.	Taels.
I. Land Tax	25,887,000	67,060,000	9,315,000
II. Tribute	7,420,000	15,582,000	2,300,000
III. Native Customs	3,790,000	1,290,000	249,000
IV. Salt Gabelle	13,050,000	26,000,000	25,000,000
V. Miscellaneous	3,856,000	5,998,000	985,000
VI. Foreign Customs	31,169,000	3,942,000	1,230,000
VII. Li-kin	13,890,000	22,502,000	3,639,000
Total	99,062,000	142,374,000	42,718,000

Mr Morse adds that the grand total shown, taels 284,150,000,² "is an obviously insufficient sum on which to maintain the fabric of government in an empire like China, but it has been reached by calculations based on a few known facts and . . . is offered as throwing some light on a subject veiled in obscurity."³

¹ In this article the tael used as a standard is the Haikwan (i.e. customs) tael, worth about 3s. It fluctuates with the value of silver.

² Roughly £43,000,000.

³ *Trade and Administration of the Chinese Empire* (1910), p. 118.

The service of the foreign debt, together with the pressure of other needs—such as the cost of education and the army—made more manifest than previously the chaos of the Chinese fiscal system. A scheme to reform the national finances was promulgated under an edict of the 11th of January 1909, but it did not appear to be of a practical character.

Sources of Revenue. 1. *Land Tax.*—In China, as in most oriental countries, the land has from time immemorial been the mainstay of the revenue. In the early years of the present dynasty there was levied along with the land tax a poll tax on all adult males, but in 1712 the two were amalgamated, and the whole burden was thrown upon land, families not possessing land being thereafter exempted from taxation. At the same time it was decreed that the amount of the land tax as then fixed should be permanent and settled for all time coming. It would appear from the records that this promise has been kept as far as the central government has been concerned. In all its many financial difficulties it does not seem ever to have tried to increase the revenue by raising the land tax. The amount of tax leviable on each plot is entered on the title deed, and, once entered, it cannot be changed.⁴ The tax on almost all lands is thus stated to be so much in silver and so much in rice, wheat or whatever the principal crop may be. Except in two provinces, however, the grain tax is now commuted and paid in silver. The exceptions are Kiang-su and Cheh-kiang, which still send forward their taxes in grain. The value of the grain forwarded (generally called tribute rice) is estimated at taels 6,500,000. The total collection in silver, as reported by the responsible officials, amounts in round numbers to taels 25,000,000. The total yield of the land tax, therefore, is taels 31,500,000, or say £4,725,000. It will readily be granted that for such a large country as China this is a very insignificant one. In India the land tax yields about £20,000,000, and China has undoubtedly a larger cultivated area, a larger population, and soil that is on the whole more fertile; but it is certain that this sum by no means represents the amounts actually paid by the cultivators. It is the sum which the various magistrates and collectors have to account for and remit in hard cash. But as nothing is allowed them for the costs of collection, they add on a percentage beforehand to cover the cost. This they usually do by declaring the taxes leviable not in silver, but in copper "cash," which indeed is the only currency that circulates in country places, and by fixing the rate of exchange to suit themselves. Thus while the market rate is, say, 1500 cash to the tael, they declare by general proclamation that for tax-paying purposes cash will be received at the rate of 3500 or 4000 to the tael. Thus while the nominal land tax in silver remains the same it is in effect doubled or tripled, and, what is worse, no return is made or account required of the extra sums thus levied. Each magistrate or collector is in effect a farmer. The sum standing opposite the name of his district is the sum which he is bound to return under penalty of dismissal, but all sums which he can scrape together over and above are the perquisites of office less his necessary expenses. Custom, no doubt, sets bounds to his rapacity. If he went too far he would provoke a riot; but one may safely say there never is any reduction, what change can be effected being in the upward direction. According to the best information obtainable a moderate estimate of the sums actually paid by the cultivators would give two shillings per acre. This on an estimate of the area under cultivation should give for the eighteen provinces £19,000,000 as being actually levied, or more than four times what is returned.

2. *The Salt Duty.*—The trade in salt is a government monopoly. Only licensed merchants are allowed to deal in it, and the import of foreign salt is forbidden by the treaties. For the purpose of salt administration China is divided into seven or eight main circuits, each of which has its own sources of production. Each circuit has carefully defined boundaries, and salt produced in one circuit is not allowed to be consigned into or sold in another. There are great differences in price between the several circuits, but the consumer is not allowed to buy in the cheapest market. He can only buy from the licensed merchants in his own circuit, who in turn are debarred from procuring supplies except at the depot to which they belong. Conveyance from one circuit to another is deemed smuggling, and subjects the article to confiscation.

Duty is levied under two heads, the first being a duty proper, payable on the issue of salt from the depot, and the second being likin levied on transit or at the place of destination. The two together amount on an average to about taels 1.50 per picul of 133½ lb or 3s. 9d. per cwt. The total collection returned by the various salt collectorates amounts to taels 13,500,000 (£2,025,000) per annum. The total consumption of salt for all China is estimated at 25 million piculs, or nearly 1½ million tons, which is at the rate of 9½ per annum per head of the population. If the above amount of taels 1.50 were uniformly levied and returned, the revenue would be 37½ million taels instead of 13½. In this calculation, however, no allowance is made for the cost of collection.

3. *Likin on General Merchandise.*—By the term likin is meant

⁴ Temporary reductions are granted in provinces affected by rebellion, drought or flood.

a tax on inland trade levied while in transit from one district to another. It was originally a war tax imposed as a temporary measure to meet the military expenditure required by the T'ai-p'ing and Mahomedan rebellions of 1850-1870. It is now one of the permanent sources of income, but at the same time it is in form as objectionable as a tax can be, and is equally obnoxious to the native and to the foreign merchant. Tolls or barriers are erected at frequent intervals along all the principal routes of trade, whether by land or water, and a small levy is made at each on every conceivable article of commerce. The individual levy is small, but over a long transit it may amount to 15 or 20%. The objectionable feature is the frequent stoppages with overhauling of cargo and consequent delays. By treaty, foreign goods may commute all transit dues for a single payment of one-half the import tariff duty, but this stipulation is but indifferently observed. It must also be remembered, *per contra*, that dishonest foreign merchants will take out passes to cover *native-owned* goods. The difficulty in securing due observance of treaty rights lies in the fact that the *likin* revenue is claimed by the provincial authorities, and the transit dues when commuted belong to the central government, so that the former are interested in opposing the commutation by every means in their power. As a further means of neutralizing the commutation they have devised a new form of impost, viz. a terminal tax which is levied on the goods after the termination of the transit. The amount and frequency of *likin* taxation are fixed by provincial legislation—that is, by a proclamation of the governor. The levy is authorized in general terms by an imperial decree, but all details are left to the local authorities. The yield of this tax is estimated at taels 13,000,000 (£1,950,000), a sum which probably represents one-third of what is actually paid by the merchants, the balance being costs of collection.

4. *Imperial Maritime Customs*.—The maritime customs is the one department of finance in China which is managed with probity and honesty, and this it owes to the fact that it is worked under foreign control. It collects all the duties leviable under the treaties on the foreign trade of China, and also all duties on the coasting trade so far as carried on by vessels of foreign build, whether Chinese or foreign owned. It does not control the trade in native craft, the so-called junk trade, the duties on which are still levied by the native custom-house officials. By arrangement between the British and Chinese governments the foreign customs levy at the port of entry a *likin* on Indian opium of taels 80 per chest, in addition to the tariff duty of taels 30. This levy frees the opium from any further duty on transit into the interior. The revenue of the maritime customs rose from taels 8,200,000 in 1865 to taels 35,111,000 in 1905.

5. *Native Customs*.—The administration of the native customs continues to be similar to what prevailed in the maritime customs before the introduction of foreign supervision. Each collector is constituted a farmer, bound to account for a fixed minimum sum, but practically at liberty to retain all he may collect over and above. If he returns more he may claim certain honorary rewards as for extra diligence, but he generally manages to make out his accounts so as to show a small surplus, and no more. Only imperfect and fragmentary returns of the native collectorates have been published, but the total revenue accruing to the Chinese government from this source did not appear up to 1900 much to exceed two million taels (£300,000). In November 1901 native customs offices within 15 m. of a treaty port were placed under the control of the maritime customs, their revenues having been hypothecated for the service of the Boxer indemnity. The result was that the amount of the native customs collected by the commissioners of customs increased from taels 2,206,000 in 1902 to taels 3,699,000 in 1906.

6. *Duty on Native Opium*.—The collection of the duty on opium is in the hands of the provincial officials, but they are required to render a separate account of duty and *likin* collected on the drug, and to hold the sum at the disposal of the board of revenue at Peking. The annual import into China of Indian opium used to amount to about 50,000 chests, the exact amount of opium imported in 1904 being 54,750 piculs, on which the Chinese government received from duty and *likin* combined about 5½ million taels (£825,000). The total amount of native-grown opium was estimated in 1901 at about 400,000 chests (53,000,000 lb), and if this were taxed at taels 60 per chest, which in proportion to its price was a similar rate to that levied on Indian opium, it should give a revenue of 24 million taels. Compared with this the sums actually levied, or at least returned by the local officials as levied, were insignificant. The returns gave a total levy for all the eighteen provinces of only taels 2,200,000 (£330,000). The anti-opium smoking campaign initiated by the Chinese government in 1905 affected the revenue both by the decreased importation of the drug and the decrease in the area under poppy cultivation in China. In 1908 the opium *likin* revenue had fallen to taels 3,800,000.

7. *Miscellaneous*.—Besides the main and regular sources of income, the provincial officials levy sums which must in the aggregate amount to a very large figure, but which hardly find a place in the returns. The principal are land transfer fees, pawnbrokers' and other licences, duties on reed flats, commutation of *corvée* and personal services, &c. The fee on land transfers is 3%, and it could be shown, from a calculation based on the extent and value of the arable land and the probable number of sales, that this item alone ought to yield an annual return of between one and two millions

sterling. Practically the whole of this is absorbed in office expenses. Under this heading should also be included certain items which though not deemed part of the regular revenue, have been so often resorted to that they cannot be left out of account. These are the sums derived from sale of office or of brevet rank, and the subscriptions and benevolences which under one plea or another the government succeeds in levying from the wealthy. Excluding these, the government is always ready to receive subscriptions, rewarding the donor with a grant of official rank entitling him to wear the appropriate "button." The right is much sought after, and indeed there are very few Chinamen of any standing that are not thus decorated, for not only does the button confer social standing, but it gives the wearer certain very substantial advantages in case he should come into contact with the law courts. The minimum price for the lowest grade is taels 120 (£18), and more of course for higher grades. The proceeds of these sales go directly to the Peking government, and do not as a rule figure in the provincial returns. The total of the miscellaneous items accruing for the benefit of the government is estimated at taels 5,500,000.

Expenditure.—In regard to expenditure a distinction has to be drawn between that portion of the revenue which is controlled by the central government, and that controlled by the several provincial authorities. As the provinces collect the revenue, and as the authorities there are held responsible for the peace, order and good government of their respective territories, it follows that the necessary expenses of the provinces form a sort of first charge on the revenue. (As the tables given show, the provinces spend the greater part of the revenue collected.) The board of revenue at Peking, which is charged with a general supervision of finance matters all over the empire, makes up at the end of the year a general estimate of the funds that will be required for imperial purposes during the ensuing year, and apportions the amount among the several provinces and the several collectorates in each province. The estimate is submitted to the emperor, and, when sanctioned, instructions are sent to all the viceroys and governors in that sense, who, in turn, pass them on to their subordinate officers. In ordinary times these demands do not materially vary from year to year, and long practice has created a sort of equilibrium between imperial and provincial demands. The remittances to the capital are, as a rule, forwarded with reasonable regularity, mostly in the form of hard cash. There is, however, a constant pull going on between Peking and the provinces—the former always asking for more, the latter resisting and pleading impecuniosity, yet generally able to find the amounts required. The expenses which the central government has to meet are:—

(1) Imperial household; (2) pay of the Manchu garrison in and about Peking; (3) costs of the civil administration in the capital; (4) cost of the army so far as the expenses are not borne by the provinces; (5) naval expenses; (6) foreign loans—interest and sinking fund. To meet all these charges the Peking government for several years up to 1900 drew on the provinces for about taels 20,000,000 (£3,000,000), including the value of the tribute rice, which goes to the support of the Manchu bannerment.² No estimates are furnished of the sums allowed under such heading. The imperial household appears to receive in silver about taels 1,500,000 (£225,000) but it draws besides large supplies in kind from the provinces, e.g. silks and satins from the imperial factories at Su-chow and Hang-chow, porcelain from the Kiang-si potteries, &c., the cost of which is defrayed by the provinces. The imperial government has also at its disposal the revenue of the foreign customs. Prior to the Sino-Japanese war of 1894-95 this revenue, which, after allowing for the costs of collection, amounted to about 20,000,000 taels (£3,000,000), was nominally shared with the provinces in the proportion of four-tenths and six-tenths. The whole of the customs revenue is now pledged to foreign bondholders and absorbed by the service of the several loans. Besides supplying its own wants the imperial government has to provide for outlying portions of the empire which are unable to maintain themselves—(1) Manchuria, (2) Kan-suh and the central Asian dominion, (3) the south-western provinces of Yun-nan, Kwei-chow and Kwang-si. Manchuria, or, as it is termed, the north-east frontier defence, costs about taels 2,000,000 over and above its own resources. The central Asian territories constitute a drain on the imperial government of about taels 4,000,000 a year. This is met by subsidies from Sze-ch'uen, Shan-si, Ho-nan and other wealthy provinces. Yun-nan, Kwei-chow and Kwang-si require aids aggregating taels 2,000,000 to keep things going.

External Debt.—Prior to the war with Japan in 1894 the foreign debt of China was almost nil. A few trifling loans had been contracted at 7 and 8%, but they had been punctually paid off, and only a fraction of one remained. The expenses of the war, however, and the large indemnity of taels 230,000,000 (£34,500,000) which Japan exacted, forced China for the first time into the European market as a serious borrower. The sum of £6,635,000 was raised in 1894-1895 in four small loans at 6 or 7% interest. In 1895 a

¹ Information as to what extent the expenses of the new army and navy are met by the central government is lacking.

² To meet the expenditure on interest and redemption of the indemnities for the Boxer outrages the Peking government required the provincial authorities to increase their annual remittances by taels 18,700,000 during the years 1902-1910.

Franco-Russian loan of fr. 440,000,000 (£15,820,000) was raised in Paris. Two Anglo-German loans, each of £16,000,000 (one in 1896, the other in 1898) were raised through the Hong Kong and Shanghai Bank. The Franco-Russian loan bears 4% interest, the first Anglo-German 5%, the second 4%. The foreign loans contracted up to 1900 amounted altogether to £54,455,000. The charges for interest and sinking fund, which amounted to over £3,000,000, were secured on the revenue of the maritime customs, and on the likin taxes of certain specified provinces. The net income from these two sources amounted to over taels 24,000,000, equivalent at existing rate of exchange to £3,400,000, which was amply sufficient.

Between 1899 and 1907 (both years inclusive) £12,200,000 was raised on loan for railway purposes. The charges on the first loan—for £2,300,000—were secured on the revenue of the Imperial Northern railway, the interest being 5%. The same interest was secured on the other loans, save one for £1,000,000 in which the Hong Kong government was concerned, which bears 4% interest.

The foreign debt also includes the indemnities exacted in 1901 by the powers for the Boxer outrages. These indemnities, secured on imperial revenue, are divided into five series amounting altogether to £67,500,000, the amount payable on these indemnities (at 4% interest) in 1907 being £2,824,425. The burden of meeting this amount was apportioned between the eighteen provinces—the sums allocated ranging from taels 2,500,000 for Kiang-su to taels 300,000 for Kwei-chow. In 1909 the grand total of China's indebtedness exceeded £140,000,000 and the interest called for the payment of £7,427,450 in gold.

Banks and Banking.—Native banks for purposes of inland exchange are to be found in most large cities. They are private banks using their own capital, and seldom receiving deposits from the public. The best known are the Shan-si banks, which have branches all over the empire. They work on a small capital, seldom over £50,000 each, and do a small but profitable business by selling their drafts on distant places. None of them issues notes, although they are not debarred from doing so by law. They lend money on personal security, but do not advance against shipments of goods. In some places there are small local banks, usually called cash shops, which issue paper notes for small sums and lend money out on personal security. The notes never reach more than a very limited local circulation, and pass current merely on the credit of the institution. There is no law regulating the formation of banks or the issue of notes. **Pawnshops** occupy a prominent position in the internal economy of China. They lend on deposit of personality at very high rates, 18 and 24%, and they receive deposits of money from the public, usually allowing 6 to 10%. They are the real banks of deposit of the country, and the better class enjoy good credit. **Foreign Banks** do a large business at Shanghai and other treaty ports, and a **Government Bank** has been established at Peking.

Currency.—In the commercial treaty between Great Britain and China of 1902 China agreed to provide a uniform national coinage. An imperial decree of October 1908 commanded the introduction of a uniform tael currency; but another decree of May 1910 established a standard currency dollar weighing 72 candareens (a candareen is the 100th part of the tael ounce) and subsidiary coins of fixed values in decimal ratio. This decree properly enforced would introduce a much needed stability into the monetary system of China.

The actual currency (1910) consists of (1) **Silver**, which may be either uncoined ingots passing current by weight, or imported coins, Mexican dollars and British dollars; and (2) **Copper** "cash," which has no fixed relation to silver. The standard is silver, the unit being the Chinese ounce or tael, containing 365 grains. The tael is not a coin, but a weight. Its value in sterling consequently fluctuates with the value of silver; in 1870 it was worth about 6s. 8d., in 1907 it was worth 3s. 3d.¹ The name given in China to uncoined silver in current use is "sycee." It is cast for convenience sake into ingots weighing one to 50 taels. Its average fineness is 916-66 per 1000. When foreign silver is imported, say into Shanghai, it can be converted into currency by a very simple process. The bars of silver are sent to a quasi-public office termed the "Kung K'u," or public valuers, and by them melted down and cast into ingots of the customary size. The fineness is estimated, and the premium or betterness, together with the exact weight, is marked in ink on each ingot. The whole process only occupies a few hours, and the silver is then ready to be put into use. The Kung K'u is simply a local office appointed by the bankers of the place, and the weight and fineness are only good for that locality. The government takes no responsibility in the matter, but leaves merchants and bankers to adjust the currency as they please. For purposes of taxation and payment of duties there is a standard or treasury tael, which is about 10% heavier than the tael of commerce in use at Shanghai. Every large commercial centre has its own customary tael, the weight and therefore the value of which differ from that of every other. Silver dollars coined in Mexico, and British dollars coined in Bombay, also circulate freely at the open ports of trade and for some distance inland, passing at a little above their intrinsic value. Carolus dollars, introduced long ago and no longer coined, are retained in current use in several parts of the interior, chiefly the tea-growing districts. Being preferred by the people, and as the

supply cannot be added to, they have reached a considerable premium above their intrinsic value. Provincial mints in Canton, Wuchang, and other places have issued silver coins of the same weight and touch as the Mexican dollar, but very few have gone into use. As they possess no privilege in debt-paying power over imported Mexican dollars there is no inducement for the people to take them up unless they can be had at a cheaper rate than the latter, and these are laid down at so small a cost above the intrinsic value that no profit is left to the mint. The coinage has in consequence been almost discontinued. Subsidiary coins, however, came largely into use, being issued by the local mints. One coin "the hundredth part of a dollar" proved very popular (the issue to the end of 1906 being computed at 12,500,000,000), but at rates corresponding closely to the intrinsic value of the metal in it. The only coin officially issued by the government—up to 1910—was the so-called copper *cash*. It is a small coin which by regulation should weigh $\frac{1}{10}$ of a tael, and should contain 50 parts of copper, 40 of zinc, and 10 of lead or tin, and it should bear a fixed ratio to silver of 1000 cash to one tael of silver. In practice none of these conditions was observed. Being issued from a number of mints, mostly provincial, the standard was never uniform, and in many cases debased. Excessive issues lowered the value of the coins, and for many years the average exchange was 1600 or more per tael. The rise in copper led to the melting down of all the older and superior coins, and as for the same reason coining was suspended, the result was an appreciation of the "cash," so that a tael in 1909 exchanged for about 1220 cash or about 35 to a penny English. Inasmuch as the "cash" bore no fixed relation to silver, and was, moreover, of no uniform composition, it formed a sort of mongrel standard of its own, varying with the volume in circulation. (G. J.; X.)

V. HISTORY

(A)—*European Knowledge of China up to 1615.*

China as known to the Ancients.—The spacious seat of ancient civilization which we call China has been distinguished by different appellations, according as it was reached by the southern sea-route or by the northern land-route traversing the longitude of Asia. In the former aspect the name has nearly always been some form of the name *Sin*, *Chin*, *Sinoe*, *China*. In the latter point of view the region in question was known to the ancients as the land of the *Seres*, to the middle ages as the empire of *Cathay*. The name of *Chin* has been supposed (doubtfully) to be derived from the dynasty of *Ts'in*, which a little more than two centuries before the Christian era enjoyed a vigorous existence, uniting all the Chinese provinces under its authority, and extending its conquests far beyond those limits to the south and the west. The mention of the *Chinas* in ancient Sanskrit literature, both in the laws of Manu and in the *Mahābhārata*, has often been supposed to prove the application of the name long before the predominance of the *Ts'in* dynasty. But the coupling of that name with the *Daradas*, still surviving as the people of Dardistan, on the Indus, suggests it as more probable that those *Chinas* were a kindred race of mountaineers, whose name as *Shinas* in fact likewise remains applied to a branch of the Dard races. Whether the *Sinim* of the prophet Isaiah should be interpreted of the Chinese is probably not susceptible of any decision; by the context it appears certainly to indicate a people of the extreme east or south. The name probably came to Europe through the Arabs, who made the *China* of the farther east into *Sin*, and perhaps sometimes into *Thin*. Hence the *Thin* of the author of the *Pcriplus of the Erythraean Sea*, who appears to be the first extant writer to employ the name in this form (*i.e.* assuming Max Müller's view that he belongs to the 1st century); hence also the *Sinae* and *Thinae* of Ptolemy.

It has often indeed been denied that the *Sinae* of Ptolemy really represented the Chinese. But if we compare the statement of Marcianus of Heraclea (a mere condenser of Ptolemy), when he tells us that the "nations of the *Sinae* lie at the extremity of the habitable world, and adjoin the eastern *Terra Incognita*," with that of Cosmas, who says, in speaking of *Tzinista*, a name of which no one can question the application to China, that "beyond this there is neither habitation nor navigation"—we cannot doubt the same region to be meant by both. The fundamental error of Ptolemy's conception of the Indian Sea as a closed basin rendered it impossible but that he should misplace the Chinese coast. But considering that the name of *Sin* has come down among the Arabs from time immemorial as applied to the Chinese, considering that in the work of Ptolemy this name certainly represented the farthest known East, and considering how inaccurate are Ptolemy's configurations and longitudes much nearer home, it seems almost as reasonable to deny the identity of his India with ours as to deny that his *Sinae* were Chinese.

If we now turn to the *Seres* we find this name mentioned by classic

¹ It must be remembered that the Haikwan tael is here indicated.

authors much more frequently and at an earlier date, for the passages of Eratosthenes (in Strabo), formerly supposed to speak of a parallel passing through *Thinae*—*διὰ Θινῶν*—are now known to read correctly *δι' Ἀθηνῶν*. The name *Seres* indeed is familiar to the Latin poets of the Augustan age, but always in a vague way, and usually with a general reference to Central Asia and the farther East. We find, however, that the first endeavours to assign more accurately the position of this people, which are those of Mela and Pliny, gravitate distinctly towards China in its northern aspect as the true ideal involved. Thus Mela describes the remotest east of Asia as occupied by the three races (proceeding from south to north), Indians, Seres and Scyths; just as in a general way we might still say that eastern Asia is occupied by the Indies, China and Tartary.

Ptolemy first uses the names of *Sera* and *Serice*, the former for the chief city, the latter for the country of the Seres, and as usual defines their position with a precision far beyond what his knowledge justified—the necessary result of his system. Yet even his definition of *Serice* is most consistent with the view that this name indicated the Chinese empire in its northern aspect, for he carries it eastward to the 180th degree of longitude, which is also, according to his calculation, in a lower latitude the eastern boundary of the Sinae.

Ammianus Marcellinus devotes some paragraphs to a description of the Seres and their country, one passage of which is startling at first sight in its seeming allusion to the Great Wall, and in this sense it has been rashly interpreted by Lassen and by Reinaud. But Ammianus is merely converting Ptolemy's dry tables into fine writing, and speaks only of an encircling rampart of mountains within which the spacious and happy valley of the Seres lies. It is true that Ptolemy makes his *Serice* extend westward to Imaus, *i.e.* to Pamir. But the Chinese empire *did* so extend at that epoch, and we find Lieut. John Wood in 1838 speaking of "*China*" as lying immediately beyond Pamir, just as the Arabs of the 8th century spoke of the country beyond the Jaxartes as "*Sin*," and as Ptolemy spoke of "*Serice*" as immediately beyond Imaus.

If we fuse into one the ancient notices of the Seres and their country, omitting anomalous statements and manifest fables, the result will be somewhat as follows: "The region of the Seres is a vast and populous country, touching on the east the ocean and the limits of the habitable world, and extending west to Imaus and the confines of Bactria. The people are civilized, mild, just and frugal, eschewing collisions with their neighbours, and even shy of close intercourse, but not averse to dispose of their own products, of which raw silk is the staple, but which included also silk-stuffs, fine furs, and iron of remarkable quality." That is manifestly a definition of the Chinese.

That Greek and Roman knowledge of the true position of so remote a nation should at best have been somewhat hazy is nothing wonderful. And it is worthy of note that the view entertained by the ancient Chinese of the Roman empire and its inhabitants, under the name of *Ta-thsin*, had some striking points of analogy to those views of the Chinese which are indicated in the classical descriptions of the Seres. There can be no mistaking the fact that in this case also the great object was within the horizon of vision, yet the details ascribed to it are often far from being true characteristics, being only the accidents of its outer borders.

The Medieval Cathay.—"Cathay" is the name by which the Chinese empire was known to medieval Europe, and it is in its original form (*Kitai*) that China is still known in Russia and to most of the nations of Central Asia. West of Russia this name has long ceased to be a geographical expression, but it is associated with a remarkable phase in the history of geography and commerce. The name first became known to Europe in the 13th century, when the vast conquests of Jenghiz Khan and his house drew a new and vivid attention to Asia. For some three centuries previously the northern provinces of China had been detached from indigenous rule, and subject to northern conquerors. The first of these foreign dynasties was of a race called *Khitán* issuing from the basin of the Sungari river, and supposed (but doubtfully) to have been of the blood of the modern Tunguses. The rule of this race endured for two centuries and originated the application of the name *Khitát* or *Khitái* to northern China. The dynasty itself, known in Chinese history as *Liao*, or "Iron," disappeared from China 1123, but the name remained attached to the territory which they had ruled.

The *Khitán* were displaced by the *Nüchih* (*Nyüchê* or *Chürchê*) race, akin to the modern Manchus. These reigned, under the title of *Kin*, or "Golden," till Jenghiz and his Mongols invaded them in turn. In 1234 the conquest of the *Kin* empire was completed, and the dynasty extinguished under Ogdai (*Ogotai*), the son and successor of Jenghiz Khan. Forty years later, in the reign of Kublai, grandson and ablest successor of Jenghiz, the Mongol rule was extended over southern China (1276),

which till then had remained under a native dynasty, the Sung, holding its royal residence in a vast and splendid city, now known as Hang-chow, but then as Ling-nan, or more commonly as *King-sze*, *i.e.* the court. The southern empire was usually called by the conquerors *Mantzi* (or as some of the old travellers write, *Mangi*), a name which western Asiatics seem to have identified with *Mâchin* (from the Sanskrit *Mahâchin*), one of the names by which China was known to the traders from Persian and Arabian ports.

The conquests of Jenghiz and his successors had spread not only over China and the adjoining East, but westward also over all northern Asia, Persia, Armenia, part of Asia Minor and Russia, threatening to deluge Christendom. Though the Mongol wave retired, as it seemed almost by an immediate act of Providence, when Europe lay at its feet, it had levelled or covered all political barriers from the frontier of Poland to the Yellow Sea, and when western Europe recovered from its alarm, Asia lay open, as never before or since, to the inspection of Christendom. Princes, envoys, priests—half-missionary, half-envoy—visited the court of the great khan in Mongolia; and besides these, the accidents of war, commerce or opportunity carried a variety of persons from various classes of human life into the depths of Asia. "'Tis worthy of the grateful remembrance of all Christian people," says an able missionary friar of the next age (Ricold of Monte Croce), "that just at the time when God sent forth into the Eastern parts of the world the Tatars to slay and to be slain, He also sent into the West his faithful and blessed servants, Dominic and Francis, to enlighten, instruct and build up in the faith." Whatever on the whole may be thought of the world's debt to Dominic, it is to the two mendicant orders, but especially to the Franciscans, that we owe a vast amount of information about medieval Asia, and, among other things, the first mention of *Cathay*. Among the many strangers who reached Mongolia were (1245-1247) John de Plano Carpini and (1253) William of Rubruk (Rubruquis) in French Flanders, both Franciscan friars of high intelligence, who happily have left behind them reports of their observations.

Carpini, after mentioning the wars of Jenghiz against the *Kitai*, goes on to speak of that people as follows: "Now these *Kitai* are heathen men, and have a written character of their own. . . . They seem, indeed, to be kindly and polished folks enough. They have no beard, and in character of countenance have a considerable resemblance to the Mongols" [are *Mongoloid*, as our ethnologists would say], "but are not so broad in the face. They have a peculiar language. Their betters as craftsmen in every art practised by man are not to be found in the whole world. Their country is very rich in corn, in wine, in gold and silver, in silk, and in every kind of produce tending to the support of mankind." The notice of Rubruk, shrewder and more graphic, runs thus: "Farther on is Great Cathay, which I take to be the country which was anciently called the Land of the Seres. For the best silk stuffs are still got from them. . . . The sea lies between it and India. Those Cathayans are little fellows, speaking much through the nose, and, as is general with all those eastern people, their eyes are very narrow. They are first-rate artists in every kind, and their physicians have a thorough knowledge of the virtues of herbs, and an admirable skill in diagnosis by the pulse. . . . The common money of Cathay consists of pieces of cotton-paper, about a palm in length and breadth, upon which certain lines are printed, resembling the seal of Mangu Khan. They do their writing with a pencil, such as painters paint with, and a single character of theirs comprehends several letters, so as to form a whole word."

Here we have not only what is probably the first European notice of paper-money, but a *partial* recognition of the peculiarity of Chinese writing, and a perception that puts to shame the perverse boggling of later critics over the identity of these Cathayans with the Seres of classic fame.

But though these travellers saw Cathayans in the bazaars in the great khan's camps, the first actual visitors of Cathay itself were the Polo family, and it is to the book of Marco Polo's recollections mainly that Cathay owed the growing familiarity of its name in Europe during the 14th and 15th centuries. It is, however, a great mistake to suppose, as has often been assumed, that the residence of the Polos in that country remained an isolated fact. They were but the pioneers of a very considerable intercourse, which endured till the decay of the Mongol dynasty in Cathay, *i.e.* for about half a century.

We have no evidence that either in the 13th or 14th century Cathayans, *i.e.* Chinese, ever reached Europe, but it is possible that some did, at least in the former century. For, during the campaigns of Hulagu in Persia (1256-1265), and the reigns of his successors, Chinese engineers were employed on the banks of the Tigris, and Chinese astrologers and physicians could be consulted at Tabriz. Many diplomatic communications passed between the Hulaguid Ilkhans and the princes of Christendom. The former, as the great khan's liegemen, still received from him their seals of state; and two of their letters which survive in the archives of France exhibit the vermilion impressions of those seals in Chinese characters—perhaps affording the earliest specimen of that character which reached western Europe.

Just as the Polos were reaching their native city (1295), after an absence of a quarter of a century, the forerunner of a new series of travellers was entering southern China by way of the Indian seas. This was John of Monte Corvino, another Franciscan who, already some fifty years of age, was plunging single-handed into that great ocean of paganism to preach the gospel according to his lights. After years of uphill and solitary toil converts began to multiply; coadjutors joined him. The Papal See became cognizant of the harvest that was being reaped in the far East. It made Friar John archbishop in Cambaluc (or Peking), with patriarchal authority, and sent him batches of suffragan bishops and preachers of his own order. The Roman Church spread; churches and Minorite houses were established at Cambaluc, at Zayton or Tsuan-chow in Fu-kien, at Yangchow and elsewhere; and the missions flourished under the smile of the great khan, as the Jesuit missions did for a time under the Manchu emperors three centuries and a half later. Archbishop John was followed to the grave, about 1328, by mourning multitudes of pagans and Christians alike. Several of the bishops and friars who served under him have left letters or other memoranda of their experience, *e.g.* Andrew, bishop of Zayton, John of Cora, afterwards archbishop of Sultania in Persia, and Odoric of Pordenone, whose fame as a pious traveller won from the *vox populi* at his funeral a beatification which the church was fain to seal. The only ecclesiastical narrative regarding Cathay, of which we are aware, subsequent to the time of Archbishop John, is that which has been gathered from the recollections of Giovanni de' Marignolli, a Florentine Franciscan, who was sent by Pope Benedict XII. with a mission to the great khan, in return for one from that potentate which arrived at Avignon from Cathay in 1338, and who spent four years (1342-1346) at the court of Cambaluc as legate of the Holy See. These recollections are found dispersed incoherently over a chronicle of Bohemia which the traveller wrote by order of the emperor Charles IV., whose chaplain he was after his return.

But intercourse during the period in question was not confined to ecclesiastical channels. Commerce also grew up, and flourished for a time even along the vast line that stretches from Genoa and Florence to the marts of Chch-kiang and Fu-kien. The record is very fragmentary and imperfect, but many circumstances and incidental notices show how frequently the remote East was reached by European traders in the first half of the 14th century—a state of things which it is very difficult to realize when we see how all those regions, when reopened to knowledge two centuries later, seemed to be discoveries as new as the empires which, about the same time, Cortes and Pizarro were conquering in the West.

This commercial intercourse probably began about 1310-1320. John of Monte Corvino, writing in 1305, says it was twelve years since he had heard any news from Europe; the only Western stranger who had arrived in all that time being a certain Lombard chirurgeon (probably one of the *Patarini* who got hard measure at home in those days), who had spread the most incredible blasphemies about the Roman Curia and the order of St Francis. Yet even on his first entrance to Cathay Friar John had been accompanied by one Master Peter of Lucolongo, whom he describes as a faithful Christian man and a great merchant, and who seems to have remained many years at Peking. The letter of Andrew, bishop of Zayton (1326), quotes the opinion of Genoese merchants at that port regarding a question of exchanges. Odoric, who was in Cathay about 1323-1327, refers for confirmation of the wonders which he related of the great city of Cansay (*i.e.* King-sze, or Hang-chow) to the many persons

whom he had met at Venice since his return, who had themselves been witnesses of those marvels. And Marignolli, some twenty years later, found attached to one of the convents at Zayton, in Fu-kien, a *fondaco* or factory for the accommodation of the Christian merchants.

But by far the most distinct and notable evidence of the importance and frequency of European trade with Cathay, of which silk and silk goods formed the staple, is to be found in the commercial hand-book (*c.* 1340) of Francesco Balducci Pegolotti, a clerk and factor of the great Florentine house of the Bardi, which was brought to the ground about that time by its dealings with Edward III. of England. This book, called by its author *Libro di divisamenti di Paesi*, is a sort of trade-guide, devoting successive chapters to the various ports and markets of his time, detailing the nature of imports and exports at each, the duties and exactions, the local customs of business, weights, measures and money. The first two chapters of this work contain instructions for the merchant proceeding to Cathay; and it is evident, from the terms used, that the road thither was not unfrequently travelled by European merchants, from whom Pegolotti had derived his information. The route which he describes lay by Azov, Astrakhan, Khiva, Otrar (on the Jaxartes), Almálik (Gulja in Ili), Kan-chow (in Kan-suh), and so to Hang-chow and Peking. Particulars are given as to the silver ingots which formed the currency of Tatar, and the paper-money of Cathay. That the ventures on this trade were not insignificant is plain from the example taken by the author to illustrate the question of expenses on the journey, which is that of a merchant investing in goods there to the amount of some £12,000 (*i.e.* in actual gold value, not as calculated by any fanciful and fallacious equation of values).

Of the same remarkable phase of history that we are here considering we have also a number of notices by Mahomedan writers. The establishment of the Mongol dynasty in Persia, by which the great khan was acknowledged as lord paramount, led (as we have already noticed in part) to a good deal of intercourse. And some of the Persian historians, writing at Tabriz, under the patronage of the Mongol princes, have told us much about Cathay, especially Rashiduddin, the great minister and historian of the dynasty (died 1318). We have also in the book of the Moorish traveller Ibn Batuta, who visited China about 1347-1348, very many curious and in great part true notices, though it is not possible to give credence to the whole of this episode in his extensive travels.

About the time of the traveller first named the throne of the degenerate descendants of Jenghiz began to totter to its fall, and we have no knowledge of any Frank visitor to Cathay in that age later than Marignolli; missions and merchants alike disappear from the field. We hear, indeed, once and again of ecclesiastics despatched from Avignon, but they go forth into the darkness, and are heard of no more. Islam, with all its jealousy and exclusiveness, had recovered its grasp over Central Asia; the Nestorian Christianity which once had prevailed so widely was vanishing, and the new rulers of China reverted to the old national policy, and held the foreigner at arm's length. Night descended upon the farther East, covering Cathay with those cities of which the old travellers had told such marvels, Cambaluc and Cansay, Zayton and Chinkalan. And when the veil rose before the Portuguese and Spanish explorers of the 16th century, those names are heard no more. In their stead we have China, Peking, Hangchow, Chinchew, Canton. Not only were the old names forgotten, but the fact that those places had ever been known before was forgotten also. Gradually new missionaries went forth from Rome—Jesuits and Dominicans now; new converts were made, and new vicariates constituted; but the old Franciscan churches, and the Nestorianism with which they had battled, had alike been swallowed up in the ocean of pagan indifference. In time a wreck or two floated to the surface—a MS. Latin Bible or a piece of Catholic sculpture; and when the intelligent missionaries called Marco Polo to mind, and studied his story, one and another became convinced that Cathay and China were one.

But for a long time all but a sagacious few continued to regard Cathay as a region distinct from any of the new-found Indies; whilst map-makers, well on into the 17th century, continued to represent it as a great country lying entirely to the north of China, and stretching to the Arctic Sea.

It was Cathay, with its outlying island of Zipangu (Japan), that Columbus sought to reach by sailing westward, penetrated as he was by his intense conviction of the smallness of the earth, and of the vast extension of Asia eastward; and to the day of his death he was full of the imagination of the proximity of the domain of the great khan to the islands and coasts which he had discovered. And such imaginations are curiously embodied in some of the maps of the early 16th century, which intermingle on the same coast-line the new discoveries from Labrador to Brazil with the provinces and rivers of Marco Polo's Cathay.

Cathay had been the aim of the first voyage of the Cabots in 1496, and it continued to be the object of many adventurous voyages by English and Hollanders to the N.W. and N.E. till far on in the 16th century. At least one memorable land-journey also was made by Englishmen, of which the exploration of a trade-route to Cathay was a chief object—that in which Anthony Jenkinson and the two Johnsons reached Bokhara by way of Russia in 1558-1559. The country of which they collected notices at that city was still known to them only as *Cathay*, and its great capital only as *Cambaluc*.

Cathay as a supposed separate entity may be considered to come to an end with the journey of Benedict Goës, the lay-Jesuit. This admirable person was, in 1603, despatched through Central Asia by his superiors in India with the specific object of determining whether the Cathay of old European writers and of modern Mahomedans was or was not a distinct region from that China of which parallel marvels had now for some time been recounted. Benedict, as one of his brethren pronounced his epitaph, "seeking Cathay found Heaven." He died at Suchow, the frontier city of China, but not before he had ascertained that China and Cathay were the same. After the publication of the narrative of his journey (in the *Expeditio Christiana apud Sinas* of Trigault, 1615) inexcusable ignorance alone could continue to distinguish between them, but such ignorance lingered many years longer. (H. Y.)

(B)—Chinese Origins.

Chinese literature contains no record of any kind which might justify us in assuming that the nucleus of the nation may have immigrated from some other part of the world; and the several ingenious theories pointing to Babylonia, Egypt, India, Khotan, and other seats of ancient civilization as the starting-points of ethnical wanderings must be dismissed as untenable. Whether the Chinese were seated in their later homes from times immemorial, as their own historians assume, or whether they arrived there from abroad, as some foreign scholars have pretended, cannot be proved to the satisfaction of historical critics. Indeed, anthropological arguments seem to contradict the idea of any connexion with Babylonians, Egyptians, Assyrians, or Indians. The earliest hieroglyphics of the Chinese, ascribed by them to the Shang dynasty (second millennium B.C.), betray the Mongol character of the nation that invented them by the decided obliquity of the human eye wherever it appears in an ideograph. In a pair of eyes as shown in the most ancient pictorial or sculptural representations in the west, the four corners may be connected by a horizontal straight line; whereas lines drawn through the eyes of one of the oldest Chinese hieroglyphics cross each other at a sharp angle, as shown in the accompanying diagrams:—



Egyptian.

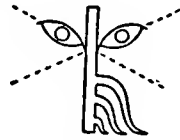

Chinese.

This does not seem to speak for racial consanguinity any more than the well-known curled heads and bearded faces of Assyrian sculptures as compared to the straight-haired and almost beardless Chinese. Similarities in the creation of cultural elements may, it is true, be shown to exist on either side, even at periods when mutual intercourse was probably out of the question; but this may be due to uniformity in the construction of the human brain, which leads man in different parts of the world to arrive at similar ideas under similar conditions, or to prehistoric connexions which it is as impossible for us to trace now as is the origin of mankind itself. Our standpoint as regards the origin of the Chinese race is, therefore, that of the agnostic. All we can do is to reproduce the tradition as it is found in Chinese literature. This tradition, as applying to the very earliest periods, may be nothing more than historical superstition, yet it has its historical importance. Supposing it were possible to prove that none of the persons mentioned in the Bible from Adam down to the Apostles ever lived, even the most sceptical critic would still have to admit that the history of a great portion of the human race has been materially affected by the belief in the examples of their alleged lives. Something similar may be said of the alleged earliest history of the Chinese with its model emperors and detestable tyrants, the accounts of which, whether based on reality or not, have exercised much influence on the development of the nation.

The Chinese have developed their theories of prehistoric life. Speculation as to the origin and gradual evolution of their civilization has resulted in the expression of views by authors who may have reconstructed their systems from remnants of

ancestral life revealed by excavations, or from observation of neighbouring nations living in a state of barbarism. This may account for a good deal of the repetition found in the Chinese mythological and legendary narratives, the personal and chronological part of which may have been invented merely as a framework for illustrating social and cultural progress. The scene of action of all the prehistoric figures from P'an-ku, the first human being, down to the beginning of real history has been laid in a part of the world which has never been anything but Chinese territory. P'an-ku's epoch, millions of years ago, was followed by ten distinct periods of sovereigns, including the "Heavenly emperors," the "Terrestrial emperors," and the "Human emperors," the *Yu-ch'au* or "Nest-builders," and *Sui-jön*, the "Fire Producer," the Prometheus of the Chinese, who borrowed fire from the stars for the benefit of man. Several of the characteristic phases of cultural progress and social organization have been ascribed to this mythological period. Authors of less fertile imagination refer them to later times, when the heroes of their accounts appear in shapes somewhat resembling human beings rather than as gods and demigods.

The Chinese themselves look upon Fu-hi as their first historical emperor; and they place his lifetime in the years 2852-2738 B.C. Some accounts represent him as a supernatural being; and we see him depicted as a human figure with a fish tail something like a mermaid. He is credited with having established social order among his people, who, before him, had lived like animals in the wilds. The social chaos out of which Chinese society arose is described as being characterized by the absence of family life; for "children knew only their mothers and not their fathers." Fu-hi introduced matrimony; and in so doing he placed man as the husband at the head of the family and abolished the original matriarchate. This quite corresponds with his views on the dualism in natural philosophy, of which he is supposed to have laid the germs by the invention of the so-called *pa-kua*, eight symbols, each consisting of three parallel lines, broken or continuous. The continuous lines represented the male element in nature; the broken ones, the female. It is characteristic that the same ruler who assigned to man his position as the head of the family is also credited with the invention of that natural philosophy of the "male and female principles," according to which all good things and qualities were held to be male, while their less sympathetic opposites were female, such as heaven and earth, sun and moon, day and night, south and north. If these traditions really represent the oldest prehistoric creations of the popular mind, it would almost seem that the most ancient Chinese shared that naive sentiment which caused our own forefathers to invent gender. The difference is that, with us, the conception survives merely in the language, where the article or suffixes mark gender, whereas with the Chinese, whose language does not express gender, it survives in their system of metaphysics. For all their attempts at fathoming the secrets of nature are based on the idea that male or female powers are inherent in all matter.

To the same Emperor Fu-hi are ascribed many of the elementary inventions which raise man from the life of a brute to that of a social being. He taught his people to hunt, to fish, and to keep flocks; he constructed musical instruments, and replaced a kind of knot-writing previously in use by a system of hieroglyphics. All this cannot of course be considered as history; but it shows that the authors of later centuries who credited Fu-hi with certain inventions were not quite illogical in starting from the matriarchal chaos, after which he is said to have organized society with occupations corresponding to those of a period of hunting, fishing and herding. This period was bound to be followed by a further step towards the final development of the nation's social condition; and we find it quite logically succeeded by a period of agricultural life, personified in the Emperor, Shön-nung, supposed to have lived in the twenty-eighth century B.C. His name may be freely translated as "Divine Labourer"; and to him the Chinese ascribe the invention of agricultural implements, and the discovery of the medicinal properties of numerous plants.

The third historical emperor was Huang-ti, the "Yellow emperor," according to the literal translation. Ssi-ma Ts'ien, the Herodotus of the Chinese, begins his history with him; but Fu-hi and Shön-nung are referred to in texts much older than this historian, though many details relating to their alleged reigns have been added in later times. Huang-ti extended the boundaries of the empire, described as being originally confined to a limited territory near the banks of the Yellow river and the present city of Si-an-fu. Here were the sites of cities used as capitals of the empire under various names during long periods since remote antiquity. To Huang-ti, whose reign is said to have commenced in 2704 according to one source and in 2491 according to another, are ascribed most of the cultural innovations which historians were not able otherwise to locate within historical times. Under Huang-ti we find the first mention of a nation called the Hun-yü, who occupied the north of his empire and with whom he is represented to have engaged in warfare. The Chinese identify this name with that of the Hiung-nu, their old hereditary enemy and the ancestors of Attila's Huns. Even though the details of these legendary accounts may deserve little confidence, there must have been an old tradition that a nation called the Hun-yü, occupying the northern confines of China, were the ancestors of the Hiung-nu tribes, well known in historical times, a scion of whose great khans settled in territory belonging to the king of Sogdiana during the first century B.C., levied tribute from his neighbours, the Alans, and with his small but warlike horde initiated that era of migrations which led to the overrunning of Europe with Central-Asiatic Tatars.

Fu-hi, Shön-nung and Huang-ti represent a group of rulers comprised by the Chinese under the name of *San-huang*, i.e. "The Three Emperors." Although we have no reason to deny their existence, the details recorded concerning them contain enough in the way of improbabilities to justify us in considering them as mythical creations. The chronology, too, is apparently quite fictitious; for the time allotted to their reigns is much too long as a term of government for a single human life, and, on the other hand, much too short, if we measure it by the cultural progress said to have been brought about in it. Fu-hi's period of hunting life must have lasted many generations before it led to the agricultural period represented by the name Shön-nung; and this period in turn could not possibly have led within a little more than one hundred years to the enormous progress ascribed to Huang-ti. Under the latter ruler a regular board of historians is said to have been organized with Ts'ang-kié as president, who is known also as Shi-huang, i.e. "the Emperor of Historians," the reputed inventor of hieroglyphic writing placed by some authors into the Fu-hi period and worshipped as Tzi-shön, i.e. "God of writing," to the present day. Huang-ti is supposed to have been the first builder of temples, houses and cities; to have regulated the calendar, to which he added the intercalary month; and to have devised means of traffic by cars drawn by oxen and by boats to ply on the lakes and rivers of his empire. His wife, known as "the lady of Si-ling," is credited with the invention of the several manipulations in the rearing of silkworms and the manufacture of silk. The invention of certain flutes, combined to form a kind of reed organ, led to a deeper study of music; and in order to construct these instruments with the necessary accuracy a system of weights and measures had to be devised. Huang-ti's successors, Shau-hau, Chuan-hü, and Ti-k'u, were less prominent, though each of them had their particular merits.

The Model Emperors.—Most of the stories regarding the "Three Emperors" are told in comparatively late records. The *Shu-king*, sometimes described as the "Canon of History," our oldest source of pre-Confucian history, supposed to have been edited by Confucius himself, knows nothing of Fu-hi, Shön-nung and Huang-ti; but it begins by extolling the virtues of the emperor Yau and his successor Shun. Yau and Shun are probably the most popular names in Chinese history as taught in China. Whatever good qualities may be imagined of the rulers of a great nation have been heaped upon their heads; and the example of their lives has at all times been held up by Confucianists as the height of perfection in a sovereign's character. Yau, whose reign has been placed by the fictitious standard chronology of the Chinese in the years 2357-2258, and about

200 years later by the less extravagant "Annals of the Bamboo Books," is represented as the patron of certain astronomers who had to watch the heavenly bodies; and much has been written about the reputed astronomical knowledge of the Chinese in this remote period. Names like Deguignes, Gaubil, Biot and Schlegel are among those of the investigators. On the other side are the sceptics, who maintain that later editors interpolated statements which could have been made only with the astronomical knowledge possessed by their own contemporaries. According to an old legend, Shun banished "the four wicked ones" to distant territories. One of these bore the name *T'au-t'ie*, i.e. "Glutton"; called also San-miau. *T'au-t'ie* is also the name of an ornament, very common on the surface of the most ancient bronze vessels, showing the distorted face of some ravenous animal. The San-miau as a tribe are said to have been the forefathers of the Tangutans, the Tibetans and the Miao-tzi in the south-west of China. This legend may be interpreted as indicating that the non-Chinese races in the south-west have come to their present seats by migration from Central China in remote antiquity. During Yau's reign a catastrophe reminding one of the biblical deluge threatened the Chinese world. The emperor held his minister of works, Kun, responsible for this misfortune, probably an inundation of the Yellow river such as has been witnessed by the present generation. Its horrors are described with poetical exaggeration in the *Shu-king*. When the efforts to stop the floods had proved futile for nine years, Yau wished to abdicate, and he selected a virtuous young man of the name of Shun as his successor. Among the legends told about this second model emperor is the story that he had a board before his palace on which every subject was permitted to note whatever faults he had to find with his government, and that by means of a drum suspended at his palace gate attention might be drawn to any complaint that was to be made to him. Since Kun had not succeeded in stopping the floods, he was dismissed and his son Yü was appointed in his stead. Probably the waters began to subside of their own accord, but Yü has been praised up as the national hero who, by his engineering works, saved his people from utter destruction. His labours in this direction are described in a special section of the Confucian account known as *Yü-kung*, i.e. "Tribute of Yü." Yü's merit has in the sequel been exaggerated so as to credit him with more than human powers. He is supposed to have cut canals through the hills, in order to furnish outlets to the floods, and to have performed feats of engineering compared to which, according to Von Richthofen, the construction of the St Gotthard tunnel without blasting materials would be child's play, and all this within a few years.

The Hia Dynasty.—As a reward for his services Yü was selected to succeed Shun as emperor. He divided the empire into nine provinces, the description of which in the *Yü-kung* chapter of the "Canon of History" bears a suspicious resemblance to later accounts. Yü's reign has been assigned to the years 2205-2198, and the Hia Dynasty, of which he became the head, has been made to extend to the overthrow in 1766 B.C. of Kié, its eighteenth and last emperor, a cruel tyrant of the most vicious and contemptible character. Among the Hia emperors we find *Chung-k'ang* (2159-2147), whose reign has attracted the attention of European scholars by the mention of an eclipse of the sun, which his court astronomers had failed to predict. European astronomers and sinologues have brought much acumen to bear on the problem involved in the *Shu-king* account in trying to decide which of the several eclipses known to have occurred about that time was identical with the one observed in China under Chung-k'ang.

The Shang, or Yin, Dynasty.—This period, which preceded the classical Chóu dynasty, is made to extend from 1766 to 1122 B.C. We must now be prepared to see an energetic or virtuous ruler at the head of a dynasty and either a cruel tyrant or a contemptible weakling at the end of it. It seems natural that this should be so; but Chinese historians, like the writers of Roman history, have a tendency to exaggerate both good and bad qualities. Ch'öng-tang, its first sovereign, is represented as a model of goodness and of humane feeling towards his subjects. Even the animal world benefited by his kindness, inasmuch as he abolished all useless torture in the chase. His great minister I Yin, who had greatly assisted him in securing the throne, served two of his successors. P'an-köng (1401) and Wu-ting (1324) are described as good rulers among a somewhat indifferent set of monarchs. The Shang dynasty, like the Hia, came to an end through the reckless vice and cruelty of a tyrant (Chóu-sin with his consort Ta-ki). China had even in those days to maintain her position as a civilized nation by keeping at bay the barbarous nations by which she was surrounded. Chief among these were the ancestors of the Hiung-nu

tribes, or Huns, on the northern and western boundaries. To fight them, to make pacts and compromises with them, and to befriend them with gifts so as to keep them out of the Imperial territories, had been the rôle of a palatinate on the western frontier, the duchy of Chóu, while the court of China with its vicious emperor gave itself up to effeminate luxury. Chóu-sin's evil practices had aroused the indignation of the palatine, subsequently known as Wön-wang, who in vain remonstrated with the emperor's criminal treatment of his subjects. The strength and integrity of Wön-wang's character had made him the corner-stone of that important epoch; and his name is one of the best known both in history and in literature. The courage with which he spoke his mind in rebuking his unworthy liege lord caused the emperor to imprison him, his great popularity alone saving his life. During his incarceration, extending over three years, he compiled the *I-king*, or "Canon of Changes," supposed to be the oldest book of Chinese literature, and certainly the one most extensively studied by the nation. Wön-wang's son, known as Wu-wang, was destined to avenge his father and the many victims of Chóu-sin's cruelty. Under his leadership the people rose against the emperor and, with the assistance of his allies, "men of the west," possibly ancestors of the Huns, overthrew the Shang dynasty after a decisive battle, whereupon Chóu-sin committed suicide by setting fire to his palace.

Chóu Dynasty.—Wu-wang, the first emperor of the new dynasty, named after his duchy of Chóu on the western frontier, was greatly assisted in consolidating the empire by his brother, Chóu-kung, *i.e.* "Duke of Chóu." As the loyal prime-minister of Wu-wang and his successor the duke of Chóu laid the foundation of the government institutions of the dynasty, which became the prototype of most of the characteristic features in Chinese public and social life down to recent times. The brothers and adherents of the new sovereign were rewarded with fiefs which in the sequel grew into as many states. China thus developed into a confederation, resembling that of the German empire, inasmuch as a number of independent states, each having its own sovereign, were united under one liege lord, the emperor, styled "The Son of Heaven," who as high priest of the nation reigned in the name of Heaven. The emperor represented the nation in sacrificing and praying to God. His relations with his vassals and government officials, and those of the heads of the vassal states with their subjects as well as of the people among themselves were regulated by the most rigid ceremonial. The dress to be worn, the speeches to be made, and the postures to be assumed on all possible occasions, whether at court or in private life, were subject to regulations. The duke of Chóu, or whoever may have been the creator of this system, showed deep wisdom in his speculations, if he based that immutability of government which in the sequel became a Chinese characteristic, on the physical and moral immutability of individuals by depriving them of all spontaneous action in public and private life. Originally and nominally the emperor's power as the ruler over his vassals, who again ruled in his name, was unquestionable; and the first few generations of the dynasty saw no decline of the original strength of central power. A certain loyalty based on the traditional ancestral worship counteracted the desire to revolt. The rightful heir to the throne was responsible to his ancestors as his subjects were to theirs. "We have to do as our ancestors did," the people argued; "and since they obeyed the ancestors of our present sovereign, we have to be loyal to him." Interference with this time-honoured belief would have amounted to a rupture, as it were, in the nation's religious relations, and as long as the people looked upon the emperor as the Son of Heaven, his moral power would outweigh strong armies sent against him in rebellion. The time came soon enough when central power depended merely on this spontaneous loyalty.

Not all the successors of Wu-wang profited by the lessons given them by past history. Incapacity, excessive severity and undue weakness had created discontent and loosened the relations between the emperor and his vassals. Increase in the extent of the empire greatly added to this decline of central power. For the emperor's own dominion was centrally situated

and surrounded by the several confederate states; its geographical position prevented it from participating in the general aggrandisement of China, and increase in territory, population and prestige had become the privilege of boundary states. Tatar tribes in the north and west and the aboriginal Man barbarians in the south were forced by warfare to yield land, or enticed to exchange it for goods, or induced to mingle with their Chinese neighbours, thus producing a mixed population combining the superior intelligence of the Chinese race with the energetic and warlike spirit of barbarians. These may be the main reasons which gradually undermined the Imperial authority and brought some of the confederate states to the front, so as to overshadow the authority of the Son of Heaven himself, whose military and financial resources were inferior to those of several of his vassals. A few out of the thirty-five sovereigns of the Chóu dynasty were distinguished by extraordinary qualities. Mu-wang of the 10th century performed journeys far beyond the western frontier of his empire, and was successful in warfare against the Dog Barbarians, described as the ancestors of the Hiung-nu, or Huns. The reign of Süan-wang (827-782 B.C.) was filled with warfare against the Tangutans and the Huns, called Hiên-yün in a contemporaneous poem of the "Book of Odes"; but the most noteworthy reign in this century is that of the lascivious Yu-wang, the oppressiveness of whose government had caused a bard represented in the "Book of Odes" to complain about the emperor's evil ways. The writer of this poem refers to certain signs showing that Heaven itself is indignant at Yu-wang's crimes. One of these signs was an eclipse of the sun which had recently occurred, the date and month being clearly stated. This date corresponds exactly with August 29, 776 B.C.; and astronomers have calculated that on that precise date an eclipse of the sun was visible in North China. This, of course, cannot be a mere accident; and since the date falls into the sixth year of Yu-wang's reign, the coincidence is bound to increase our confidence in that part of Chinese history. Our knowledge of it, however, is due to mere chance; for the record of the eclipse would probably not have been preserved until our days had it not been interpreted as a kind of *tekel ufharsin* owing to the peculiarity of the political situation. It does not follow, therefore, as some foreign critics assume, that the historical period begins as late as Yu-wang's reign. China has no architectural witnesses to testify to her antiquity as Egypt has in her pyramids and temple ruins; but the sacrificial bronze vessels of the Shang and Chóu dynasties, with their characteristic ornaments and hieroglyphic inscriptions, seem to support the historical tradition inasmuch as natural development may be traced by the analysis of their artistic and paleographic phases. Counterfeiters, say a thousand years later, could not have resisted the temptation to introduce patterns and hieroglyphic shapes of later periods; and whatever bronzes have been assigned to the Shang dynasty, *i.e.* some time in the second millennium B.C., exhibit the Shang characteristics. The words occurring in their inscriptions, carefully collected, may be shown to be confined to ideas peculiar to primitive states of cultural life, not one of them pointing to an invention we may suspect to be of later origin. But, apart from this, it seems a matter of individual judgment how far back beyond that indisputable year 776 B.C. a student will date the beginning of real history.

In the 7th century central authority had declined to such an extent that the emperor was merely the nominal head of the confederation, the hegemony in the empire falling in turn to one of the five principal states, for which reason the Chinese speak of a period of the "Five Leaders." The state of Ts'i, corresponding to North Shan-tung, had begun to overshadow the other states by unprecedented success in economic enterprise, due to the prudent advice of its prime minister, the philosopher Kuan-tz'i. Other states attained leadership by success in warfare. Among these leaders we see duke Mu of T'sin (659 B.C.), a state on the western boundary which was so much influenced by amalgamation with its Hunnic neighbours that the purely Chinese states regarded it as a barbarian country. The emperor was in those days a mere shadow; several of his vassals had

grown strong enough to claim and be granted the title "king," and they all tried to annihilate their neighbours by ruse in diplomacy and by force of arms, without referring to their common ruler for arbitration, as they were in duty bound. In this *bellum omnium contra omnes* the state of Ts'in, in spite of repeated reverses, remained in possession of the field.

The period of this general struggle is spoken of by Chinese historians as that of "The Contending States." Like that of the "Five Leaders" it is full of romance; and the examples of heroism, cowardice, diplomatic skill and philosophical equanimity which fill the pages of its history have become the subject of elegant literature in prose and poetry. The political development of the Ch'ou dynasty is the exact counterpart of that of its spiritual life as shown in the contemporaneous literature. The orthodox conservative spirit which reflects the ethical views of the emperor and his royal partisans is represented by the name Confucius (551-479 B.C.). The great sage had collected old traditions and formulated the moral principles which had been dormant in the Chinese nation for centuries. His doctrines tended to support the maintenance of central power; so did those of other members of his school, especially Mencius. Filial love showed itself as obedience to the parents in the family and as loyalty to the emperor and his government in public life. It was the highest virtue, according to the Confucian school. The history of the nation as taught in the *Shu-king* was in its early part merely an illustration of Confucianist ideas about good and bad government. The perpetual advice to rulers was: "Be like Yau, Shun and Yü, and you will be right." Confucianism was dominant during the earlier centuries of the Ch'ou dynasty, whose lucky star began to wane when doctrines opposed to it got the upper hand. The philosophical schools built up on the doctrines of Lau-tzi had in the course of generations become antagonistic, and found favour with those who did not endorse that loyalty to the emperor demanded by Mencius; so had other thinkers, some of whom had preached morals which were bound to break up all social relations, like the philosopher of egotism, Yang Chu, according to Mencius disloyalty personified and the very reverse of his ideal, the duke of Ch'ou. The egotism recommended by Yang Chu to the individual had begun to be practised on a large scale by the contending states, their governments and sovereigns, some of whom had long discarded Confucian rites under the influence of Tatar neighbours. It appears that the anti-Confucian spirit which paved the way towards the final extinction of Wu-wang's dynasty received its chief nourishment from the Tatar element in the population of the northern and western boundary states. Among these Ts'in was the most prominent. Having placed itself in the possession of the territories of nearly all of the remaining states, Ts'in made war against the last shadow emperor, Nan-wang who had attempted to form an alliance against the powerful usurper, with the result that the western part of the Ch'ou dominion was lost to the aggressor.

Nan-wang died soon after (256 B.C.), and a relative whom he had appointed regent was captured in 249 B.C., when the king of Ts'in put an end to this last remnant of the once glorious Ch'ou dynasty by annexing its territory. The king had already secured the possession of the Nine Tripods, huge bronze vases said to have been cast by the emperor Yü as representing the nine divisions of his empire and since preserved in the treasuries of all the various emperors as a symbol of Imperial power. With the loss of these tripods Nan-wang had forfeited the right to call himself "Son of Heaven." Another prerogative was the offering of sacrifice to Shang-ti, the Supreme Ruler, or God, with whom only the emperor was supposed to communicate. The king of Ts'in had performed the ceremony as early as 253 B.C. (F. H.*)

(C)—From the Ts'in Dynasty to 1875.

After the fall of the Ch'ou dynasty a kind of interregnum followed during which China was practically without an emperor.

Ts'in dynasty 249-210 B.C. This was the time when the state of Ts'in asserted itself as the leader and finally as the master of all the contending states. Its king, Chau-siang, who died in 251 B.C., though virtually emperor, abstained from adopting the imperial title. He was succeeded by his son, Hiao-wên Wang, who died after a three days' reign. Chwan-siang Wang, his son and successor, was a man of no mark. He died in 246 B.C. giving place to Shi Hwang-ti, "the first universal emperor." This sovereign was then only thirteen, but he speedily made his influence felt everywhere. He chose Hien-yang, the modern Si-gan Fu, as his capital, and built there a magnificent palace, which was the wonder and admiration of his contemporaries. He abolished the feudal system, and divided the country into provinces over whom he set officers directly responsible to himself. He constructed roads through the empire, he formed canals, and erected numerous and handsome public buildings.

Having settled the internal affairs of his kingdom, he turned his attention to the enemies beyond his frontier. Chief among these were the Hiung-nu Tatars, whose attacks had for years disquieted the Chinese and neighbouring principalities. Against these foes he marched with an army of 300,000 men, exterminating those in the neighbourhood of China, and driving the rest into Mongolia. On his return from this campaign he was called upon to face a formidable rebellion in Ho-nan, which had been set on foot by the adherents of the feudal princes whom he had dispossessed. Having crushed the rebellion, he marched southwards and subdued the tribes on the south of the Nan-shan ranges, i.e. the inhabitants of the modern provinces of Fu-kiên, Kwang-tung and Kwang-si. The limits of his empire were thus as nearly as possible those of modern China proper. One monument remains to bear witness to his energy. Finding that the northern states of Ts'in, Chao and Yen were building lines of fortification along their northern frontier for protection against the Hiung-nu, he conceived the idea of building one gigantic wall, which was to stretch across the whole northern limit of the huge empire from the sea to the farthest western corner of the modern province of Kan-suh. This work was begun under his immediate supervision in 214 B.C. His reforming zeal made him unpopular with the upper classes. Schoolmen and pedants held up to the admiration of the people the heroes of the feudal times and the advantages of the system they administered. Seeing in this propaganda danger to the state Shi Hwang-ti determined to break once and for all with the past. To this end he ordered the destruction of all books having reference to the past history of the empire, and many scholars were put to death for failing in obedience to it. (See *infra* § Chinese Literature, §§ History.) The measure was unpopular and on his death (210 B.C.) rebellion broke out. His son and successor Erh-shi, a weak and debauched youth, was murdered after having offered a feeble resistance to his enemies. His son Tsze-yung surrendered to Liu Pang, the prince of Han, one of the two generals who were the leaders of the rebellion. He afterwards fell into the hands of Hiang Yu, the other chieftain, who put him and his family and associates to death. Hiang Yu aspiring to imperial honours, war broke out between him and Liu Pang. After five years' conflict Hiang Yu was killed in a decisive battle before Wu-kiang. Liu Pang was then proclaimed emperor (206 B.C.) under the title of Kao-ti, and the new line was styled the Han dynasty.

Kao-ti established his capital at Lo-yang in Ho-nan, and afterwards removed it to Chang-an in Shen-si. Having founded his right to rebel on the oppressive nature of the laws promulgated by Shi Hwang-ti, he abolished the ordinances of Ts'in, except that referring to the destruction of the books—for, like his great predecessor, he dreaded the influence exercised by the *litterati*—and he exchanged the worship of the gods of the soil of Ts'in for that of those of Han, his native state. His successor Hwei-ti (194-179 B.C.), however, gave every encouragement to literature, and appointed a commission to restore as far as possible the texts which had been destroyed by Shi Hwang-ti. In this the commission was very successful. It was discovered that in many cases the law had been evaded, while in numerous instances scholars were found to write down from memory the text of books of which all copies had been destroyed, though in some cases the purity of the text is doubtful and in other cases there were undoubted forgeries. A period of repose was now enjoyed by the empire. There was peace within its borders, and its frontiers remained unchallenged, except by the Hiung-nu, who suffered many severe defeats. Thwarted in their attacks on China, these marauders attacked the kingdom of the Yueh-chi, which had grown up in the western extremity of Kan-suh, and after much fighting drove their victims along the T'ien-shan-nan-lu to the territory between Turkestan and the Caspian Sea. This position of affairs suggested to the emperor the idea of forming an offensive and defensive alliance with the Yueh-chi against the Hiung-nu. With this object the general Chang K'ien was sent as an ambassador to western Tatar. After having been twice imprisoned by the Hiung-nu he returned to China. Chang K'ien had actually reached the court of the Yueh-chi, or Indo-Scythians as they were called owing to their having become masters of India later on, and paid a visit to the kingdom of Bactria, recently conquered by the Yueh-chi. His report on the several kingdoms of western Asia opened up a new world to the Chinese, and numerous elements of culture, plants and animals were then imported for the first time from the west into China. While in Bactria Chan K'ien's attention was first drawn to the existence of India, and attempts to send expeditions,

Han
dynasty
206 B.C.

though at first fruitless, finally led to its discovery. Under Wu-ti (140–86 B.C.) the power of the Hiung-nu was broken and eastern Turkestan changed into a Chinese colony, through which caravans could safely pass to bring back merchandise and art treasures from Persia and the Roman market. By the Hans the feudal system was restored in a modified form; 103 feudal principalities were created, but they were more or less under the jurisdiction of civil governors appointed to administer the thirteen *chows* (provinces) into which the country was divided. About the beginning of the Christian era Wang Mang rose in revolt against the infant successor of P'ing-ti (A.D. 1), and in A.D. 9 proclaimed himself emperor. He, however, only gained the suffrages of a portion of the nation, and before long his oppressive acts estranged his supporters. In A.D. 23 Liu Siu, one of the princes of Han, completely defeated him. His head was cut off, and his body was torn in pieces by his own soldiery.

Liu Siu, was proclaimed emperor under the title of Kwang-wu-ti, reigned from A.D. 58 to 76. Having fixed on Lo-yang in Ho-nan as his capital, the line of which he was the first emperor became known as the Eastern Han dynasty. It is also known as the Later Han dynasty.

Eastern Han dynasty, A.D. 23. During the reign of his successor Ming-ti, A.D. 65, Buddhism was introduced from India into China (see *ante* § *Religion*). About the same time the celebrated general Pan Ch'ao was sent on an embassy to the king of Shen-shen, a small state of Turkestan, near the modern Pidjan. Before long he added the states of Shen-shen, Khotan, Kucha and Kashgar as apanages to the Chinese crown, and for a considerable period the country enjoyed prosperity. The Han dynasty (including in the term the Eastern Han dynasty) has been considered the first national dynasty and is one of the most famous in China; nor has any ruling family been more popular. The Chinese, especially the northern Chinese, still call themselves "the sons of Han." The wealth and trade as well as the culture of the country was greatly developed, and the competitive examinations for literary degrees instituted. The homogeneity of the nation was so firmly established that subsequent dissensions and conquests could not alter fundamentally the character of the nation.

Towards the end of the 2nd century the power of the Eastern Hans declined. In 173 a virulent pestilence, which continued for eleven years, broke out. A magical cure for this plague was said to have been discovered by a Taoist priest named Chang Chio, who in a single month won a sufficiently large following to enable him to gain possession of the northern provinces of the empire. He was, however, defeated by Ts'ao P'ei, another aspirant to imperial honours, whose son, Ts'ao P'ei, on the death of Hien-ti (A.D. 220), proclaimed himself emperor, adopting the title of Wei as the appellation of his dynasty. There were then, however, two other claimants to the throne, Liu Pei and Sun Ch'üan, and the three adventurers agreed to divide the empire between them.

Wei dynasty. Ts'ao P'ei, under the title of Wên-ti, ruled over the kingdom of Wei (220), which occupied the whole of the central and northern portion of China. Liu Pei established the Shuh Han dynasty in the modern province of Sze-ch'uen (221), and called himself Chao-lieh-ti; and to Sun Ch'üan fell the southern provinces of the empire, from the Yangtze-kiang southwards, including the modern Tong-king, which he formed into the kingdom of Wu with Nan-king for his capital, adopting for himself the imperial style of Ta-tê (A.D. 222).

China during the period of the "Three Kingdoms" was a house divided against itself. Liu Pei, as a descendant of the house of Han, looked upon himself as the rightful sovereign of the whole empire, and he despatched an army under Chu-ko Liang to support his claims. This army was met by an opposing force under the Wei commander Sze-ma I, of whom Chinese historians say that "he led armies like a god," and who, by adopting a Fabian policy, completely discomfited his adversary. But the close of this campaign brought no peace to the country. Wars became chronic, and the reins of power slipped out of the hands of emperors into those of their generals. Foremost among these were the members of the Sze-ma family of Wei. Sze-ma I left a son, Sze-ma Chao, scarcely less distinguished than himself, and when Sze-ma Chao died his honours descended to Sze-ma Yen, who deposed the ruling sovereign of Wei, and proclaimed himself emperor of China (A.D. 265). His dynasty he styled the Western Tsin dynasty, and he adopted for himself the title of Wu-ti. The most noticeable event in this reign was the advent of the ambassadors of the emperor Diocletian in 284. For some years the neighbouring states appear to have transferred their allegiance from the house of Wei to

that of Tsin. Wu-ti's successors proving, however, weak and incapable, the country soon fell again into disorder. The Hiung-nu renewed incursions into the empire at the beginning of the 4th century, and in the confusion which followed, an adventurer named Liu Yuen established himself (in 311) as emperor, first at P'ing-yang in Shan-si and afterwards in Lo-yang and Chang-an. The history of this period is very chaotic. Numerous states sprang into existence, some founded by the Hiung-nu and others by the Sien-pi tribe, a Tungusic clan, inhabiting a territory to the north of China, which afterwards established the Liao dynasty in China. In 419 the Eastern Tsin dynasty came to an end, and with it disappeared for nearly two hundred years all semblance of united authority. The country became divided into two parts, the north and the south. In the north four families reigned successively, two of which were of Sien-pi origin, viz. the Wei and the How Chow, the other two, the Pih Ts'i and the How Liang, being Chinese. In the south five different houses supplied rulers, who were all of Chinese descent.

This period of disorder was brought to a close by the establishment of the Suy dynasty (590). Among the officials of the ephemeral dynasty of Chow was one Yang Kien, who on his daughter becoming empress (578) was created duke of Suy. Two years later Yang Kien proclaimed himself emperor. The country, weary of contention, was glad to acknowledge his undivided authority; and during the sixteen years of his reign the internal affairs of China were comparatively peaceably administered. The emperor instituted an improved code of laws, and added 5000 volumes to the 10,000 which composed the imperial library. Abroad, his policy was equally successful. He defeated the Tatars and chastised the Koreans, who had for a long period recognized Chinese suzerainty, but were torn by civil wars and were disposed to reject her authority. After his death in 604 his second son forced the heir to the throne to strangle himself, and then seized the throne. This usurper, Yang-ti, sent expeditions against the Tatars, and himself headed an expedition against the Uighurs, while one of his generals annexed the Lu-chu Islands to the imperial crown. During his reign the volumes in the imperial library were increased to 54,000, and he spent vast sums in erecting a magnificent palace at Lo-yang, and in constructing unprofitable canals. These and other extravagances laid so heavy a burden on the country that discontent began again to prevail, and on the emperor's return from a successful expedition against the Koreans, he found the empire divided into rebellious factions. In the troubles which followed General Li Yuen became prominent. On the death of the emperor by assassination this man set Kung-ti, the rightful heir, on the throne (617) until such time as he should have matured his schemes.

Kung-ti was poisoned in the following year and Li Yuen proclaimed himself as Kao-tsu, the first emperor of the T'ang dynasty. At this time the Turks were at the height of their power in Asia (see *TURKS: History*), and Kao-tsu was glad to purchase their alliance with money.

T'ang dynasty. But divisions weakened the power of the Turks, and T'ai-tsung (reigned 627–650), Kao-tsu's son and successor, regained much of the position in Central Asia which had formerly been held by China. In 640 Hami, Turfan and the rest of the Turkish territory were again included within the Chinese empire, and four military governorships were appointed in Central Asia, viz. at Kucha, Khotan, Kharastan and Kashgar. At the same time the frontier was extended as far as eastern Persia and the Caspian Sea. So great was now the fame of China, that ambassadors from Nepal, Magadha, Persia and Constantinople (643) came to pay their court to the emperor. Under T'ai-tsung there was national unity and peace, and in consequence agriculture and commerce as well as literature flourished. The emperor gave direct encouragements to the Nestorians, and gave a favourable reception to an embassy from Mahommed (see *ante* § *Religion*). On the accession of Kao-tsung (650) his wife, Wu How, gained supreme influence, and on the death of her husband in 683 she set aside his lawful successor, Chung-tsung, and took possession of the throne. This was the first occasion the country was ruled by a dowager empress. She governed with discretion, and her armies defeated the Khitán in the north-east and also the Tibetans, who had latterly gained possession of Kucha, Khotan and Kashgar. On her death, in 705, Chung-tsung partially left the obscurity in which he had lived during his mother's reign. But his wife, desiring to play a similar rôle to that enjoyed by her mother-in-law, poisoned him and set his son, Jui-tsung (710), on the throne. This monarch, who was weak and vicious, was succeeded by Yuen-tsung (713), who introduced reform into the administration and encouraged literature and learning. The king of Khokand applied for aid against the Tibetans and Arabs, and Yuen-tsung

sent an army to his succour, but his general was completely defeated. During the disorder which arose in consequence of the invasion of the northern provinces by the Khitán, General An Lu-shan, an officer of Turkish descent, placed himself at the head of a revolt, and having secured Tung-kwan on the Yellow river, advanced on Chang-an. Thereupon the emperor fled, and placed his son, Su-tsung (756-762), on the throne. This sovereign, with the help of the forces of Khotan, Khokand and Bokhara, of the Uighurs and of some 4000 Arabs sent by the caliph Mansur, completely defeated An Lu-shan. During the following reigns the Tibetans made constant incursions into the western provinces of the empire, and T'ai-tsung (763-780) purchased the assistance of the Turks against those intruders by giving a Chinese princess as wife to the khan.

At this epoch the eunuchs of the palace gained an unwonted degree of power, and several of the subsequent emperors fell victims to their plots. The T'ang dynasty, which for over a hundred years had governed firmly and for the good of the nation, began to decline. The history of the 8th and 9th centuries is for the most part a monotonous record of feeble governments, oppressions and rebellions. Almost the only event worth chronicling is the iconoclastic policy of the emperor Wu-tsung (841-847). Viewing the increase of monasteries and ecclesiastical establishments as an evil, he abolished all temples, closed the monasteries and nunneries, and sent the inmates back to their families. Foreign priests were subjected to the same repressive legislation, and Christians, Buddhists and Magi were bidden to return whence they came. Buddhism again revived during the reign of the emperor I-tsung (860-874), who, having discovered a bone of Buddha, brought it to the capital in great state. By internal dissensions the empire became so weakened that the prince of Liang found no difficulty in gaining possession of the throne (907). He took the title of T'ai-tsu, being the first emperor of the Later Liang dynasty. Thus ended the T'ang dynasty, which is regarded as being the golden age of Chinese literature.

Five dynasties, viz. the Later Liang, the Later T'ang, the Later Tsin, the Later Han and the Later Chow, followed each other between the years 907 and 960. Though the monarchs of these lines nominally held sway over the empire, their real power was confined to very narrow limits. The disorders which were rife during the time when the T'ang dynasty was tottering to its fall fostered the development of independent states, and so arose Liang in Ho-nan and Shan-tung, Ki in Shen-si, Hwai-nan in Kiang-nan, Chow in Sze-ch'uen and parts of Shen-si and Hu-kwang, Wu-yüeh in Cheh-kiang, Tsu and King-nan in Hu-kwang, Ling-nan in Kwang-tung and the Uighurs in Tangut.

A partial end was made to this recognized disorganization when, in 960, General Chao Kw'ang-yin was proclaimed by the army emperor in succession to the youthful *Sung* *dynasty*. Kung-ti, who was compelled to abdicate. The circumstances of the time justified the change. It required a strong hand to weld the empire together again, and to resist the attacks of the Khitán Tatars, whose rule at this period extended over the whole of Manchuria and Liao-tung. Against these aggressive neighbours T'ai-tsu (*né* Chao Kw'ang-yin) directed his efforts with varying success, and he died in 976, while the war was still being waged. His son T'ai-tsung (976-997) entered on the campaign with energy, but in the end was compelled to conclude a peace with the Khitán. His successor, Chên-tsung (997-1022), paid them tribute to abstain from further incursions. Probably this tribute was not sent regularly; at all events, under Jên-tsung (1023-1064), the Khitán again threatened to invade the empire, and were only bought off by the promise of an annual tribute of tael 200,000 of silver, besides a great quantity of silken piece goods. Neither was this arrangement long binding, and so formidable were the advances made by the Tatars in the following reigns, that Hwei-tsung (1101-1126) invited the Nüchih Tatars to expel the Khitán from Liao-tung. This they did, but having once possessed themselves of the country they declined to yield it to the Chinese, and the result was that a still more aggressive neighbour was established on the north-eastern frontier of China. The Nüchih or Kin, as they now styled themselves, overran the provinces of Chih-li, Shen-si, Shan-si and Ho-nan, and during the reign of Kao-tsung (1127-1163) they advanced their conquests to the line of the Yangtze-kiang. From this time the Sung ruled only over southern China; while the Kin or "Golden" dynasty reigned in the north. The Kin made Chung-tu, which occupied in part the site of the modern Peking, their usual residence. The Sung

fixed their capital at Nanking and afterwards at Hangchow. Between them and the Kin there was almost constant war.

During this period the Mongols began to acquire power in eastern Asia, and about the beginning of the 12th century the forces of Jenghiz Khan (*q.v.*) invaded the north-western frontier of China and the principality of Hia, which at that time consisted of the modern provinces of Shen-si and Kan-suh. To purchase the good-will of the Mongols the king of Hia agreed to pay them a tribute, and gave a princess in marriage to their ruler. In consequence of a dispute with the Kin emperor Wei-shao Wang, Jenghiz Khan determined to invade Liao-tung. He was aided by the followers of the Khitán leader Yeh-lü Ts'u-ts'ai, and in alliance with this general he captured Liao-yang, the capital city.

*Mongol
invasion:
12th
century.*

After an unsuccessful invasion of China in 1212, Jenghiz Khan renewed the attack in 1213. He divided his armies into four divisions, and made a general advance southwards. His soldiers swept over Ho-nan, Chih-li and Shan-tung, destroying upwards of ninety cities. It was their boast that a horseman might ride without stumbling over the sites where those cities had stood. Panicked, the emperor moved his court from Chung-tu to K'ai-fêng Fu, much against the advice of his ministers, who foresaw the disastrous effect this retreat would have on the fortunes of Kin. The state of Sung, which up to this time had paid tribute, now declined to recognize Kin as its feudal chief, and a short time afterwards declared war against its quondam ally. Meanwhile, in 1215, Yeh-lü Ts'u-ts'ai advanced into China by the Shan-hai Kwan, and made himself master of Peking, one of the few cities in Chih-li which remained to Kin. After this victory his nobles wished him to proclaim himself emperor, but he refused, being mindful of an oath which he had sworn to Jenghiz Khan. In 1216 Tung-kwan, a mountain pass on the frontiers of Ho-nan and Shen-si, and the scene of numerous dynastic battles (as it is the only gateway between north-eastern and north-western China), was taken by the invaders. As the war dragged on the resistance offered by the Kin grew weaker and weaker. In 1220 Chi-nan Fu, the capital of Shan-tung, was taken, and five years later Jenghiz Khan marched an army westward into Hia and conquered the forces of the king. Two years later (1227) Jenghiz Khan died.

With the view to the complete conquest of China by the Mongols, Jenghiz declined to nominate either of the eldest two sons who had been born to his Chinese wives as his heir, but chose his third son Ogdai, whose mother was a Tatar. On hearing of the death of Jenghiz Khan the Kin sent an embassy to his successor desiring peace, but Ogdai told them there would be no peace for them until their dynasty should be overthrown. Hitherto the Mongols had been without any code of laws. But the consolidation of the nation by the conquests of Jenghiz Khan made it necessary to establish a recognized code of laws, and one of the first acts of Ogdai was to form such a code. With the help also of Yeh-lü Ts'u-ts'ai, he established custom-houses in Chih-li, Shan-tung, Shan-si and Liao-tung; and for this purpose divided these provinces into ten departments. Meanwhile the war with the Kin was carried on with energy. In 1230 Si-gan Fu was taken, and sixty important posts were captured. Two years later, Tu-lé, brother of Ogdai, took Fêng-siang Fu and Han-chung Fu, in the flight from which last-named place 100,000 persons are said to have perished. Following the course of the river Han in his victorious career, this general destroyed 140 towns and fortresses, and defeated the army of Kin at Mount San-fêng.

In 1232 the Mongols made an alliance with the state of Sung, by which, on condition of Sung helping to destroy Kin, Ho-nan was to be the property of Sung for ever. The effect of this coalition soon became apparent. Barely had the Kin emperor retreated from K'ai-fêng Fu to Ju-ning Fu in Ho-nan when the former place fell into the hands of the allies. Next fell Loyang, and the victorious generals then marched on to besiege Ju-ning Fu. The presence of the emperor gave energy to the defenders, and they held out until every animal in the city had been killed for food, until every old and useless person had suffered death to lessen the number of hungry mouths, until so many able-bodied men had fallen that the women manned the ramparts, and then the allies stormed the walls. The emperor burned himself to death in his palace, that his body might not fall into the hands of his enemies. For a few days the shadow of the imperial crown rested on the head of his heir Chang-lin, but in a tumult which broke out amongst his followers he lost his life, and with him ended the "Golden" dynasty.

*The Kin
dynasty
over-
thrown.*

Notwithstanding the treaty between Ogdai and Sung, no sooner were the spoils of Kin to be divided than war broke out again between them, in prosecuting which the Mongol armies swept over the provinces of Sze-ch'uen, Hu-kwang, Kiang-nan and Ho-nan, and were checked only when they reached the walls of Lu-chow Fu in Ngan-hui. Ogdai died in 1241, and was nominally succeeded by his grandson Cheliemên. But one of his widows, Tolickona, took possession of the throne, and after exercising rule for four years, established her son Kwei-yew as great khan. In 1248 his life was

cut short, and the nobles, disregarding the claims of Cheliemên, proclaimed as emperor Mangu, the eldest son of Tu-lé. Under this monarch the war against Sung was carried on with energy, and Kublai, outstripping the bounds of Sung territory, made his way into the province of Yun-nan, at that time divided into a number of independent states, and having attached them to his brother's crown he passed on into Tibet, Tongking and Cochia-China, and thence striking northwards entered the province of Kwang-si.

On the death of Mangu in 1259 Kublai (*q.v.*) ascended the throne. Never in the history of China was the nation more illustrious, nor its power more widely felt, than under his sovereignty. During the first twenty years of his reign Sung kept up a resistance against his authority. Their last emperor Ping-li, seeing his cause lost, drowned himself in the sea. The Sung dynasty, which had ruled southern China 320 years, despite its misfortunes is accounted one of the great dynasties of China. During its sway arts and literature were cultivated and many eminent writers flourished. His enemies subdued, Kublai Khan in 1280 assumed complete jurisdiction as emperor of China. He took the title of Shit-su and founded what is known as the Yuen dynasty. He built a new capital close to Chung-tu, which became known as Kaanbaligh (city of the khan), in medieval European chronicles, Cambaluc, and later as Peking. At this time his authority was acknowledged "from the Frozen Sea, almost to the Straits of Malacca. With the exception of Hindustan, Arabia and the westernmost parts of Asia, all the Mongol princes as far as the Dnieper declared themselves his vassals, and brought regularly their tribute." It was during this reign that Marco Polo visited China, and he describes in glowing colours the virtues and glories of the "great khan." His rule was characterized by discretion and munificence. He undertook public works, he patronized literature, and relieved the distress of the poor, but the Chinese never forgot that he was an alien and regarded him as a barbarian. He died unregretted in 1294. His son had died during his lifetime, and after some contention his grandson Timur ascended the throne under the title of Yüen-chêng. This monarch died in 1307 after an uneventful reign, and, as he left no son, Wu-tsung, a Mongol prince, became emperor. To him succeeded Jên-tsung in 1312, who made himself conspicuous by the honour he showed to the memory of Confucius, and by distributing offices more equally between Mongols and Chinese than had hitherto been done. This act of justice gave great satisfaction to the Chinese, and his death ended a peaceful and prosperous reign in 1320. At this time there appears to have been a considerable commercial intercourse between Europe and China. But after Jên-tsung's death the dynasty fell on evil days. The Mongols in adopting Chinese civilization had lost much of their martial spirit. They were still regarded as alien by the Chinese and numerous secret societies were formed to achieve their overthrow. Jên-tsung's successors were weak and incapable rulers, and in the person of Shun-ti (1333-1368) were summed up the vices and faults of his predecessors. Revolts broke out, and finally this descendant of Jenghiz Khan was compelled to fly before Chu Yüen-chang, the son of a Chinese labouring man. Deserted by his followers, he sought refuge in Ying-chang Fu, and there the last of the Yüen dynasty died. These Mongol emperors, whatever their faults, had shown tolerance to Christian missionaries and Papal legates (see *ante* § *The Medieval Cathay*).

Chu Yüen-chang met with little opposition, more especially as his first care on becoming possessed of a district was to suppress lawlessness and to establish a settled government. In 1355 he captured Nanking, and proclaimed himself duke of Wu, but carefully avoided adopting any of the insignia of royalty. Even when master of the empire, thirteen years later, he still professed to dislike the idea of assuming the imperial title. His scruples were overcome, and he declared himself emperor in 1368. He carried his arms into Tatar, where he subdued the last semblance of Mongol power in that direction, and then bent his steps towards Liaotung. Here the Mongols defended themselves with the bravery of despair, but unavailingly, and the conquest of this province

left Hung-wu, as the founder of the new or Ming ("Bright") dynasty styled himself, without a foe in the empire.

All intercourse with Europe seems now to have ceased until the Portuguese arrived in the 16th century, but Hung-wu cultivated friendly relations with the neighbouring states. As a quondam Buddhist priest he lent his countenance to that religion to the exclusion of Taoism, whose priests had for centuries earned the contempt of all but the most ignorant by their pretended magical arts and their search after the philosopher's stone. Hung-wu died in 1398 and was succeeded by his grandson Kien-Wên. Aware that the appointment of this youth—his father was dead—would give offence to the young emperor's uncles, Hung-wu had dismissed them to their respective governments. However, the prince of Yen, his eldest surviving son, rose in revolt as soon as the news reached him of his nephew's accession, and after gaining several victories over the armies of Kien-wên he presented himself before the gates of Nanking, the capital. Treachery opened the gates to him, and the emperor having fled in the disguise of a monk, the victorious prince became emperor and took the title of Yung-lo (1403). At home Yung-lo devoted himself to the encouragement of literature and the fine arts, and, possibly from a knowledge that Kien-wên was among the Buddhist priests, he renewed the law prohibiting Buddhism. Abroad he swept Cochia-China and Tongking within the folds of his empire and carried his arms into Tatar, where he made new conquests of waste regions, and erected a monument of his victories. He died in 1425, and was succeeded by his son Hung-hi.

Hung-hi's reign was short and uneventful. He strove to promote only such mandarins as had proved themselves to be able and honest, and to further the welfare of the people. During the reign of his successor, Süen-tê (1426-1436), the empire suffered the first loss of territory since the commencement of the dynasty. Cochia-China rebelled and gained her independence. The next emperor, Chêng-t'ung (1436), was taken prisoner by a Tatar chieftain, a descendant of the Yüen family named Yi-sien, who had invaded the northern provinces. Having been completely defeated by a Chinese force from Liao-tung, Yi-sien liberated his captive, who reoccupied the throne, which during his imprisonment (1450-1457) had been held by his brother King-ti. The two following reigns, those of Chêng-hwa (1465-1488) and of Hung-chi (1488-1506), were quiet and peaceful.

The most notable event in the reign of the next monarch, Chêng-te (1506-1522), was the arrival of the Portuguese at Canton (1517). From this time dates modern European intercourse with China. Chêng-te suppressed a formidable insurrection headed by the prince of Ning, but disorder caused by this civil war encouraged the foreign enemies of China. From the north came a Tatar army under Yen-ta in 1542, during the reign of Kia-tsing, which laid waste the province of Shen-si, and even threatened the capital, and a little later a Japanese fleet ravaged the littoral provinces. Ill-blood had arisen between the two peoples before this, and a Japanese colony had been driven out of Ningpo by force and not without bloodshed a few years previously. Kia-tsing (d. 1567) was not equal to such emergencies, and his son Lung-king (1567-1573) sought to placate the Tatar Yen-ta by making him a prince of the empire and giving him commercial privileges, which were supplemented by the succeeding emperor Wan-li (1573-1620) by the grant of land in Shen-si. During the reign of this sovereign, in the year 1592, the Japanese successfully invaded Korea, and Taikosama, the regent of Japan, was on the point of proclaiming himself king of the peninsula, when a large Chinese force, answering to the invitation of the king, appeared and completely routed the Japanese army, at the same time that the Chinese fleet cut off their retreat by sea. In this extremity the Japanese sued for peace, and sent an embassy to Peking to arrange terms. But the peace was of short duration. In 1597 the Japanese again invaded Korea, defeated the Chinese army, destroyed the Chinese fleet and ravaged the coast. Suddenly, however, when in the full tide of conquest, they evacuated Korea, which again fell under the direction of China. Four years later the missionary Matteo Ricci (*q.v.*) arrived at the Chinese court; and though at first the emperor was inclined to send him out of the country, his abilities gradually won for him the esteem of the sovereign and his ministers, and he remained the scientific adviser of the court until his death in 1610.

Struggle with Japan for Korea.

About this time the Manchu Tatars, goaded into war by the injustice they were constantly receiving at the hands of the Chinese, led an army into China (in 1616) and completely defeated the force which was sent against them. Three years later they gained possession of the province of Liao-tung. These disasters overwhelmed the emperor, and he died of a broken heart in 1620.

In the same year T'ien-ming, the Manchu sovereign, having declared himself independent, moved the court to San-ku, to the east of Mukden, which, five years later, he made his capital. In 1627 Ts'ung-chêng, the last emperor of the Ming dynasty, ascended the Chinese throne. In his reign English merchants first made their appearance at Canton. The empire was now torn by internal dissensions.

Manchu invasion: 17th century.

Kublai Khan emperor.

Ming dynasty.

Rebel bands, enriched by plunder, and grown bold by success, began to assume the proportion of armies. Two rebels, Li Tsze-ch'êng and Shang K'o-hi, decided to divide the empire between them. Li besieged K'ai-fêng Fu, the capital of Ho-nan, and so long and closely did he beleaguer it that in the consequent famine human flesh was regularly sold in the markets. At length an imperial force came to raise the siege, but fearful of meeting Li's army, they cut through the dykes of the Yellow River, "China's Sorrow," and flooded the whole country, including the city. The rebels escaped to the mountains, but upwards of 200,000 inhabitants perished in the flood, and the city became a heap of ruins (1642). From K'ai-fêng Fu Li marched against the other strongholds of Ho-nan and Shen-si, and was so completely successful that he determined to attack Peking. A treacherous eunuch opened the gates to him, on being informed of which the emperor committed suicide. When the news of this disaster reached the general-commanding on the frontier of Manchu Tatar, he, in an unguarded moment, concluded a peace with the Manchus, and invited them to dispossess Li Tsze-ch'êng. The Manchus entered China, and after defeating a rebel army sent against them, they marched towards Peking. On hearing of the approach of the invaders, Li Tsze-ch'êng, after having set fire to the imperial palace, evacuated the city, but was overtaken, and his force was completely routed.

The Chinese now wished the Manchus to retire, but, having taken possession of Peking, they proclaimed the ninth son of T'ien-ming emperor of China under the title of Shun-chi, and adopted the name of Ta-ts'ing, or "Great Pure," for the dynasty (1644). Meanwhile the mandarins at Nanking had chosen an imperial prince to ascend the throne. At this most inopportune moment "a claimant" to the throne, in the person of a pretended son of the last emperor, appeared at court. While this contention prevailed inside Nanking the Tatar army appeared at the walls. There was no need for them to use force. The gates were thrown open, and they took possession of the city without bloodshed. Following the conciliatory policy they had everywhere pursued, they confirmed the mandarins in their offices and granted a general amnesty to all who would lay down their arms. As the Tatars entered the city the emperor left it, and after wandering about for some days in great misery, he drowned himself in the Yangtze-kiang. Thus ended the Ming dynasty, and the empire passed again under a foreign yoke. By the Mings, who partly revived the feudal system by making large territorial grants to members of the reigning house, China was divided into fifteen provinces; the existing division into eighteen provinces was made by the Manchus.

All accounts agree in stating that the Manchu conquerors are descendants of a branch of the family which gave the Kin dynasty to the north of China; and in lieu of any authentic account of their early history, native writers have thrown a cloud of fable over their origin (see MANCHURIA). In the 16th century they were strong enough to cope with their Chinese neighbours. Doubtless the Mings tried to check their ambition by cruel reprisals, but against this must be put numerous Manchu raids into Liao-tung.

The accession to the throne of the emperor Shun-chi did not restore peace to the country. In Kiang-si, Fu-kien, Kwang-tung and Kwang-si the adherents of the Ming dynasty defended themselves vigorously but unsuccessfully against the invaders, while the pirate Chêng Chi-lung, the father of the celebrated Coxinga, kept up a predatory warfare against them on the coast. Eventually he was induced to visit Peking, where he was thrown into prison and died. Coxinga, warned by his father's example, determined to leave the mainland and to seek an empire elsewhere. His choice fell on Formosa, and having driven out the Dutch, who had established themselves in the island in 1624, he held possession until the reign of K'ang-hi, when (1682) he resigned in favour of the imperial government. Meanwhile a prince of the house of Ming was proclaimed emperor in Kwang-si, under the title of Yung-li. The Tatars having reduced Fu-kien and Kiang-si, and having taken Canton after a siege of eight months, completely routed his followers, and Yung-li was compelled to fly to Pegu. Some years later, with the help of adherents in Yun-nan and Kwei-chow, he tried to regain the throne, but his army was scattered, and he was taken prisoner and strangled. Gradually opposition to the new régime became weaker and weaker, and the shaved head with the pig-tail—the symbol of Tatar sovereignty—became more and more adopted. In 1651 died Ama Wang, the uncle of Shun-chi, who had acted as regent during his nephew's minority, and the emperor then assumed the government

of the state. He appears to have taken a great interest in science, and to have patronized Adam Schaal, a German Jesuit, who was at that time resident at Peking. It was during his reign (1656) that the first Russian embassy arrived at the capital, but as the envoy declined to *koutow* before the emperor he was sent back without having been admitted to an audience.

After an unquiet reign of seventeen years Shun-chi died (1661), and was succeeded by his son K'ang-hi. He came into collision with the Russians, who had reached the Amur regions about 1640 and had built a fort on the upper Amur; but by the Treaty of Nerchinsk, concluded in 1689 (the first treaty made between China and a European power), the dispute was settled, the Amur being taken as the frontier. K'ang-hi was indefatigable in administering the affairs of the empire, and he devoted much of his time to literary and scientific studies under the guidance of the Jesuits. The dictionary of the Chinese language, published under his superintendence, proves him to have been as great a scholar as his conquests over the Eleuths show him to have been famous as a general. During one of his hunting expeditions to Mongolia he caught a fatal cold, and he died in 1721. Under his rule Tibet was added to the empire, which extended from the Siberian frontier to Cochin-China, and from the China Sea to Turkestan. During his reign there was a great earthquake at Peking, in which 400,000 people are said to have perished.

K'ien-lung, who began to reign in 1735, was ambitious and warlike. He marched an army into Ili, which he converted into a Chinese province, and he afterwards added eastern Turkestan to the empire. Twice he invaded Burma, and once he penetrated into Cochin-China, but in neither country were his arms successful. He is accused of great cruelty towards his subjects, which they repaid by rebelling against him. During his reign the Mahomedan standard was first raised in Kan-suh. (Since the Mongol conquest in the 13th century there had been a considerable immigration of Moslems into western China; and numbers of Chinese had become converts). But the Mussulmans were unable to stand against the imperial troops; their armies were dispersed, ten thousand of them were exiled; and an order was issued that every Mahomedan in Kan-suh above the age of fifteen should be put to death (1784).

K'ien-lung wrote incessantly, both poetry and prose, collected libraries and republished works of value. His campaigns furnished him with themes for his verses, and in the Summer Palace was found a handsome manuscript copy of a laudatory poem he composed on the occasion of his war against the Gurkhas. This was one of the most successful of his military undertakings. His generals marched 70,000 men into Nepal to within 60 miles of the British frontiers, and having subjugated the Gurkhas they received the submission of the Nepalese, and acquired an additional hold over Tibet (1792). In other directions his arms were not so successful. There is no poem commemorating the campaign against the rebellious Formosans, nor lament over the loss of 100,000 men in that island, and the last few years of his reign were disturbed by outbreaks among the Miaotse, hill tribes living in the mountains in the provinces of Kwei-chow and Kwang-si. In 1795, after a reign of sixty years, K'ien-lung abdicated in favour of his fifteenth son, who adopted the title of Kia-k'ing as the style of his reign. K'ien-lung died at the age of eighty-eight in 1798.

During the reign of K'ien-lung commerce between Europe and Canton—the only Chinese port then open to foreign trade—had attained important dimensions. It was mainly ^{Trade with Europe.} in the hands of the Portuguese, the British and the Dutch. The British trade was then a monopoly of the East India Company. The trade, largely in opium, tea and silk, was subject to many exactions and restrictions,¹ and many acts of gross injustice were committed on the persons of Englishmen. To obtain some redress the British government at length sent an embassy to Peking (1793) and Lord Macartney was chosen to represent George III. on the occasion. The mission was treated as showing that Great Britain was a state tributary to China, and Lord Macartney was received with every courtesy. But the concessions he sought were not accorded, and in this sense his mission was a failure.

Kia-k'ing's reign was disturbed and disastrous. In the northern and western provinces, rebellion after rebellion broke out, due in a great measure to the carelessness, incompetency and obstinacy of the emperor, and the coasts were infested with pirates, whose number and organization enabled them for a long time to hold the imperial fleet in check. Meanwhile the condition of the foreign merchants at Canton had not improved, and to set matters on a better footing the British government despatched a second ambassador in the person of Lord Amherst to Peking in 1816. As he declined to *koutow* before the emperor, he was not admitted to the imperial presence and the mission proved

¹ See Morse's *Trade and Administration of the Chinese Empire*, chap. ix.

abortive. Destitute of all royal qualities, a slave to his passions, and the servant of caprice, Kia-k'ing died in 1820. The event fraught with the greatest consequences to China which occurred in his reign (though at the time it attracted little attention) was the arrival of the first Protestant missionary, Dr R. Morrison (*q.v.*), who reached Canton in 1807.

Tao-kwang (1820-1850), the new emperor, though possessed in his early years of considerable energy, had no sooner ascended the throne than he gave himself up to the pursuit of pleasure. The reforms which his first manifestoes foreshadowed never seriously occupied his attention. Insurrection occurred in Formosa, Kwang-si, Ho-nan and other parts of the empire, and the Triad Society which had originated during the reign of K'ang-hi, again became formidable.

More important to the future of the country than the internal disturbances was the new attitude taken at this time towards China by the nations of Europe. Hitherto the European missionaries and traders in China had been dependent upon the goodwill of the Chinese. The Portuguese had been allowed to settle at Macao (*q.v.*) for some centuries; Roman Catholic missionaries since the time of Ricci had been alternately patronized and persecuted; Protestant missionaries had scarcely gained a foothold; the Europeans allowed to trade at Canton continued to suffer under vexatious regulations—the Chinese in general regarded Europeans as barbarians, "foreign devils." Of the armed strength of Europe they were ignorant. They were now to be undeceived, Great Britain being the first power to take action. The hardships inflicted on the British merchants at Canton became so unbearable that when, in 1834, the monopoly of the East India Company ceased, the British government sent Lord Napier as minister to superintend the foreign trade at that port. Lord Napier was inadequately supported, and the anxieties of his position brought on an attack of fever, from which he died at Macao after a few months' residence in China. The chief cause of complaint adduced by the mandarins was the introduction of opium by the merchants, and for years they attempted by every means in their power to put a stop to its importation. At length Captain (afterwards Admiral Sir Charles) Elliot, the superintendent of trade, in 1839 agreed that all the opium in the hands of Englishmen should be given up to the native authorities, and he exacted a pledge from the merchants that they would no longer deal in the drug. On the 3rd of April 20,283 chests of opium were handed over to the mandarins and were by them destroyed. The surrender of the

War with Great Britain, 1840. opium led to further demands by Lin Tze-su, the Chinese imperial commissioner, demands which were considered by the British government to amount to a *casus belli*, and in 1840 war was declared. In the same year the fleet captured Chusan, and in the following year the Bogue Forts fell, in consequence of which operations the Chinese agreed to cede Hong-Kong to the victors and to pay them an indemnity of 6,000,000 dollars. As soon as this news reached Peking, Ki Shen, who had succeeded Commissioner Lin, was dismissed from his post and degraded, and Yi Shen, another Tatar, was appointed in his room. Before the new commissioner reached his post Canton had fallen into the hands of Sir Hugh Gough, and shortly afterwards Amoy, Ning-po, Tinghai in Chusan, Chapu, Shanghai and Chin-kiang Fu shared the same fate. Nanking would also have been captured had not the imperial government, dreading the loss of the "Southern Capital," proposed terms of peace. Sir Henry Pottinger, who had succeeded Captain Elliot, concluded, in 1842, a treaty with the imperial commissioners, by which the four additional ports of Amoy, Fu-chow, Ningpo and Shanghai were declared open to foreign trade, and an indemnity of 21,000,000 dollars was to be paid to the British.

On the accession of Hien-fêng in 1850, a demand was raised for the reforms which had been hoped for under Tao-kwang, but Hien-fêng possessed in an exaggerated form the selfish and tyrannical nature of his father, together with a voluptuary's craving for every kind of sensual pleasure. For some time Kwang-si had been in a very disturbed state, and when the people found that there was no hope of relief from the oppression

they endured, they proclaimed a youth, who was said to be the representative of the last emperor of the Ming dynasty, as emperor, under the title of T'ien-tê or "Heavenly Virtue." From Kwang-si the revolt spread into Hu-peh and Hu-nan, and then languished from want of a leader and a definite political cry. When, however, there appeared to be a possibility that, by force of arms and the persuasive influence of money, the imperialists would re-establish their supremacy, a leader presented himself in Kwang-si, whose energy of character, combined with great political and religious enthusiasm, speedily gained for him the suffrages of the discontented. This was Hung Siu-ts'üan. He proclaimed himself as sent by heaven to drive out the Tatars, and to restore in his own person the succession to China. At the same time, having been converted to Christianity and professing to abhor the vices and sins of the age he called on all the virtuous of the land to extirpate rulers who were standing examples of all that was base and vile in human nature. Crowds soon flocked to his standard. T'ien-tê was deserted; and putting himself at the head of his followers (who abandoned the practice of shaving the head), Hung Siu-ts'üan marched northwards and captured Wuch'ang on the Yangtze-kiang, the capital of Hu-peh. Then, moving down the river he proceeded to the attack of Nanking. Without much difficulty Hung Siu-ts'üan in 1853 established himself within its walls, and proclaimed the inauguration of the T'ai-p'ing dynasty, of which he nominated himself the first emperor under the title of T'ien Wang or "Heavenly king." During the next few years his armies penetrated victoriously as far north as Tientsin and as far east as Chin-kiang and Su-chow, while bands of sympathizers with his cause appeared in the neighbourhood of Amoy. As if still further to aid him in his schemes, Great Britain declared war against the Tatar dynasty in 1857, in consequence of an outrage known as the "Arrow" affair (see PARKES, SIR HARRY SMITH). In December 1857 Canton was taken by the British and a further blow was struck against the prestige of the Manchu dynasty by the determination of Lord Elgin, who had been sent as special ambassador, to go to Peking and communicate directly with the emperor. In May 1858 the Taku Forts were taken, and Lord Elgin went up the Peiho to Tientsin *en route* for the capital. At Tientsin, however, imperial commissioners persuaded him to conclude a treaty with them on the spot, which treaty it was agreed should be ratified at Peking in the following year. When, however, Sir Frederick Bruce, who had been appointed minister to the court of Peking, attempted to pass Taku to carry out this arrangement, the vessels escorting him were treacherously fired on from the forts and he was compelled to return. Thereupon Lord Elgin was again sent out with full powers, accompanied by a large force under the command of Sir Hope Grant. The French (to seek reparation for the murder of a missionary in Kwang-si) took part in the campaign, and on the 1st of August 1860 the allies landed without meeting with any opposition at Pei-tang, a village 12 m. north of Taku. A few days later the forts at that place were taken, and thence the allies marched to Peking. Finding further resistance to be hopeless, the Chinese opened negotiations, and as a guarantee of their good faith surrendered the An-ting gate of the capital to the allies. On the 24th of October 1860 the treaty of 1858 was ratified by Prince Kung and Lord Elgin, and a convention was signed under the terms of which the Chinese agreed to pay a war indemnity of 8,000,000 taels. The right of Europeans to travel in the interior was granted and freedom guaranteed to the preaching of Christianity. The customs tariff then agreed upon legalized the import of opium, though the treaty of 1858, like that of 1842, was silent on the subject.

Great Britain and France were not the only powers of Europe with whom Hien-fêng was called to deal. On the northern border of the empire Russia began to exercise pressure. Russia had begun to colonize the lower Amur region, and was pressing towards the Pacific. This was a remote region, only part of the Chinese empire since the Manchu conquest, and by treaties of 1858 and 1860 China ceded to Russia all its territory north of the Amur and between the Ussuri and the Pacific (see AMUR, province). The Russians in their newly acquired land founded the port of Vladivostok (*q.v.*).

Hien-fêng died in the summer of the year 1861, leaving the throne to his son T'ung-chi (1861-1875), a child of five years old, whose mother, Tsz'e Hsi (1834-1908), had been raised from the place of favourite concubine to that of Imperial Consort. The legitimate empress, Tsz'e An, was childless, and the two dowagers became joint regents. The conclusion of peace with the allies was the signal for a renewal of the campaign against the T'ai-p'ings, and, benefiting by the friendly feelings of the British authorities engendered by the return of amicable relations, the Chinese government succeeded in enlisting Major Charles George Gordon (*q.v.*) of the Royal Engineers in their service. In a surprisingly short space of time this officer formed the troops, which had formerly been under the command of an American named Ward, into a formidable army, and without delay took the field against the rebels. From that day the fortunes of the T'ai-p'ings declined. They lost city after city, and, finally in July 1864, the imperialists, after an interval of twelve years, once more gained possession of Nanking. T'ien Wang committed suicide on the capture of his capital, and with him fell his cause. Those of his followers who escaped the sword dispersed throughout the country, and the T'ai-p'ings ceased to be.

T'ai-p'ing rebellion.

T'ung-chi, emperor; dowager empress regent.

With the measure of peace which was then restored to the country trade rapidly revived, except in Yun-nan, where the Mahomedan rebels, known as Panthays, under Suleiman, still kept the imperial forces at bay. Against these foes the government was careless to take active measures, until in 1872 Prince Hassan, the adopted son of Suleiman, was sent to England to gain the recognition of the queen for his father's government. This step aroused the susceptibilities of the imperial government, and a large force was despatched to the scene of the rebellion. Before the year was out the Mahomedan capital Ta-li Fu fell into the hands of the imperialists, and the followers of Suleiman were mercilessly exterminated. In February 1873 the two dowager empresses resigned their powers as regents. This long-expected time was seized upon by the foreign ministers to urge their right of audience with the emperor, and on the 29th of June 1873 the privilege of gazing on the "sacred countenance" was accorded them.

The emperor T'ung-chi died without issue, and the succession to the throne, for the first time in the annals of the Ts'ing dynasty, passed out of the direct line. As already stated, the first emperor of the Ts'ing dynasty, Shih-tsu Hwangti, on gaining possession of the throne on the fall of the Ming, or "Great Bright" dynasty, adopted the title of Shun-chi for his reign, which began in the year 1644. The legendary progenitor of these Manchu rulers was Aisin Gioro, whose name is said to point to the fact of his having been related to the race of Nü-chih, or Kin, *i.e.* Golden Tatars, who reigned in northern China during the 12th and 13th centuries. K'ang-hi (1661-1722) was the third son of Shun-chi; Yung-chêng (1722-1735) was the fourth son of K'ang-hi; K'ien-lung (1736-1795) was the fourth son of Yung-chêng; Kia-k'ing (1796-1820) was the fifteenth son of K'ien-lung; Tao-kwang (1821-1850) was the second son of Kia-k'ing; Hien-fêng (1851-1861) was the fourth of the nine sons who were born to the emperor Tao-kwang; and T'ung-chi (1862-1875) was the only son of Hien-fêng. The choice now fell upon Tsai-t'ien (as he was called at birth), the infant son (born August 2, 1872) of Yi-huan, Prince Chun, the seventh son of the emperor Tao-kwang and brother of the emperor Hien-fêng; his mother was a sister of the empress Tsz'e Hsi, who, with the aid of Li Hung-chang, obtained his adoption and proclamation as emperor, under the title of Kwang-su, "Succession of Glory."

In order to prevent the confusion which would arise among the princes of the imperial house were they each to adopt an arbitrary name, the emperor K'ang-hi decreed that each of his twenty-four sons should have a *personal* name consisting of two characters, the first of which should be *Yung*, and the second should be compounded with the determinative *shih*, "to manifest," an arrangement which would, as has been remarked, find an exact parallel in a system by which the sons in an English family might be called *Louis Edward*, *Louis Edwin*, *Louis Edwy*, *Louis Edgar* and so on. This device obtained also in the next generation, all the princes of which had *Hung* for their first name, and the emperor K'ien-lung (1736-1795) extended it into a system, and directed that the succeeding generations should take the four characters *Yung*, *Mien Yih* and *Tsai* respectively, as the first part of their names. Eight other characters, namely, *P'u*, *Yu*, *Hêng*, *K'i*, *Tao*, *K'ai*, *Tsêng*, *Ki*, were subsequently added, thus providing generic names for twelve generations. With the generation represented by Kwang-su the first four characters were exhausted, and any sons of the emperor Kwang-su would therefore have been called *P'u*. By the ceremonial law of the "Great Pure" dynasty, twelve degrees of rank are distributed among the princes of the imperial house, and are as follows: (1) Ho-shih Tsin Wang, prince of the first order; (2) To-lo Keun Wang, prince of the second order; (3) To-lo Beileh, prince of the third order; (4) Ku-shan Beitsze, prince of the fourth order; 5 to 8, Kung, or duke (with distinctive designations); 9 to 12, Tsiang-keun, general (with distinctive designations). The sons of emperors usually receive patents of the first or second order on their reaching manhood, and on their sons is bestowed the title of *Beileh*. A *Beileh*'s sons become *Beitsze*; a *Beitsze*'s sons become *Kung*, and so on. (R. K. D.; X.)

(D)—From 1875 to 1901.

The accession to the throne of Kwang-su in January 1875 attracted little notice outside China, as the supreme power continued to be vested in the two dowager-empresses—the empress Tsz'e An, principal wife of the emperor Hien-fêng, and the empress Tsz'e Hsi, secondary wife of the same emperor, and mother of the emperor T'ung-chi. Yet there were circumstances connected with the emperor Kwang-su's accession which might well have arrested attention. The emperor T'ung-chi, who had himself succumbed to an ominously brief and mysterious illness, left a young widow in an advanced state of pregnancy, and had she given birth to a male child her son would have been the rightful heir to the throne. But even before she sickened and died—of grief, it was officially

stated, at the loss of her imperial spouse—the dowager-empresses had solved the question of the succession by placing Kwang-su on the throne, a measure which was not only in itself arbitrary, but also in direct conflict with one of the most sacred of Chinese traditions. The solemn rites of ancestor-worship, incumbent on every Chinaman, and, above all, upon the emperor, can only be properly performed by a member of a younger generation than those whom it is his duty to honour. The emperor Kwang-su, being a first cousin to the emperor T'ung-chi, was not therefore qualified to offer up the customary sacrifices before the ancestral tablets of his predecessor. The accession of an infant in the place of T'ung-chi achieved, however, for the time being what was doubtless the paramount object of the policy of the two empresses, namely, their undisturbed tenure of the regency, in which the junior empress Tsz'e Hsi, a woman of unquestionable ability and boundless ambition, had gradually become the predominant partner.

The first question that occupied the attention of the government under the new reign was one of the gravest importance, and nearly led to a war with Great Britain. The Indian government was desirous of seeing the old trade relations between Burma and the south-west provinces, which had been interrupted by the Yun-nan rebellion, re-established, and for that purpose proposed to send a mission across the frontier into China. The Peking government assented and issued passports for the party, which was under the command of Colonel Browne. Mr A. R. Margary, a young and promising member of the China consular service, who was told off to accompany the expedition as interpreter, was treacherously murdered by Chinese at the small town of Manwyne and almost simultaneously an attack was made on the expedition by armed forces wearing Chinese uniform (January 1875). Colonel Browne with difficulty made his way back to Bhamo and the expedition was abandoned.

Tedious negotiations followed, and, more than eighteen months after the outrage, an arrangement was come to on the basis of guarantees for the future, rather than vengeance for the past. The arrangement was embodied in the Chifu convention, dated 13th September 1876. The terms of the settlement comprised (1) a mission of apology from China to the British court; (2) the promulgation throughout the length and breadth of the empire of an imperial proclamation, setting out the right of foreigners to travel under passport, and the obligation of the authorities to protect them; and (3) the payment of indemnity. Additional articles were subsequently signed in London relative to the collection of *likin* on Indian opium and other matters.

Simultaneously with the outbreak of the Mahomedan rebellion in Yun-nan, a similar disturbance had arisen in the north-west provinces of Shen-si and Kan-sub. This was followed by a revolt of the whole of the Central Asian tribes, which for two thousand years had more or less acknowledged the imperial sway. In Kashgaria a nomad chief named Yakub Beg, otherwise known as the Atalik Ghâzi, had made himself amir, and seemed likely to establish a strong rule. The fertile province of Kulja or Ili, lying to the north of the Tianshan range, was taken possession of by Russia in 1871 in order to put a stop to the prevailing anarchy, but with a promise that when China should have succeeded in re-establishing order in her Central Asian dominions it should be given back. The interest which was taken in the rebellion in Central Asia by the European powers, notably by the sultan of Turkey and the British government, aroused the Chinese to renewed efforts to recover their lost territories, and, as in the case of the similar crisis in Yun-nan, they undertook the task with sturdy deliberation. They borrowed money—£1,600,000—for the expenses of the expedition, this being the first appearance of China as a borrower in the foreign markets, and appointed the viceroy, Tso Tsung-t'ang, commander-in-chief. By degrees the emperor's authority was established from the confines of Kan-sub to Kashgar and Yarkand, and Chinese garrisons were stationed in touch with the Russian outpost in the region of the Pamirs

Accession of Kwang-su, 1875.

Murder of Mr Margary.

Imperial family nomenclature and rank.

Chifu convention 1876.

Revolt in Central Asia.

(December 1877). Russia was now called upon to restore Kulja, China being in a position to maintain order. China despatched Chung-how, a Manchu of the highest rank, who had been notoriously concerned in the Tientsin massacre of 1870, to St Petersburg to negotiate a settlement. After some months of discussion a document was signed (September 1879), termed

Imperial consolidation.

the treaty of Livadia, whereby China recovered, not indeed the whole, but a considerable portion of the disputed territory, on her paying to Russia five million roubles as the cost of occupation. The treaty was, however, received with a storm of indignation in China. Memorials poured in from all sides denouncing the treaty and its author. Foremost among these was one by Chang Chih-tung, who afterwards became the most distinguished of the viceroys, and governor-general of Hu-peh and Hu-nan provinces. Prince Chun, the emperor's father, came into prominence at this juncture as an advocate for war, and under these combined influences the unfortunate Chung-how was tried and condemned to death (3rd of March 1880). For some months warlike preparations went on, and the outbreak of hostilities was imminent. In the end, however, calmer counsels prevailed. It was decided to send the Marquis Tseng, who in the meantime had become minister in London, to Russia to negotiate. A new treaty which still left Russia in possession of part of the Ili valley was ratified on the 19th of August 1881. The Chinese government could now contemplate the almost complete recovery of the whole extensive dominions which had at any time owned the imperial sway. The regions directly administered by the officers of the emperor extended from the borders of Siberia on the north to Annam and Burma on the south, and from the Pacific Ocean on the east to Kashgar and Yarkand on the west. There was also a fringe of tributary nations which still kept up the ancient forms of allegiance, and which more or less acknowledged the dominion of the central kingdom. The principal tributary nations then were Korea, Lu-chu, Annam, Burma and Nepal.

Korea was the first of the dependencies to come into notice. In 1866 some Roman Catholic missionaries were murdered, and about the same time an American vessel was burnt in one of the rivers and her crew murdered. China refused satisfaction, both to France and America, and suffered reprisals to be made on Korea without protest. America and Japan both desired to conclude commercial treaties for the opening up of Korea, and proposed to negotiate with China. China refused and referred them to the Korean government direct, saying

Korea and Japan.

she was not wont to interfere in the affairs of her vassal states. As a result Japan concluded a treaty in 1876, in which the independence of Korea was expressly recognized. This was allowed to pass without protest, but as other nations proceeded to conclude treaties on the same terms China began to perceive her mistake, and endeavoured to tack on to each a declaration by the king that he was in fact a tributary—a declaration, however, which was quietly ignored. Japan, however, was the only power with which controversy immediately arose. In 1882 a faction fight, which had long been smouldering, broke out, headed by the king's father, the Tai Won Kun, in the course of which the Japanese legation was attacked and the whole Japanese colony had to flee for their lives. China sent troops, and by adroitly kidnapping the Tai Won Kun, order was for a time restored. The Japanese legation was replaced, but under the protection of a strong body of Japanese troops. Further revolutions and riots followed, in which the troops of the two countries took sides, and there was imminent danger of war. To obviate this risk, it was agreed in 1885 between Count Ito and Li Hung-Chang that both sides should withdraw their troops, the king being advised to engage officers of a third state to put his army on such a footing as would maintain order, and each undertook to give the other notice should it be found necessary to send troops again. In this way a *modus vivendi* was established which lasted till 1894.

We can only glance briefly at the domestic affairs of China during the period 1875-1882. The years 1877-1878 were marked by

a famine in Shan-si and Shan-tung, which for duration and intensity has probably never been equalled. It was computed that 12 or 13 millions perished. It was vainly hoped that this loss of life, due mainly to defective communications, would induce the Chinese government to listen to proposals for railway construction.

Domestic affairs, 1875-1882.

The Russian scare had, however, taught the Chinese the value of telegraphs, and in 1881 the first line was laid from Tientsin to Shanghai. Further construction was continued without intermission from this date. A beginning also was made in naval affairs. The arsenal at Fuchow was turning out small composite gunboats, a training ship was bought and put under the command of a British officer. Several armoured cruisers were ordered from England, and some progress was made with the fortifications of Port Arthur and Wei-hai-wei. Forts were also built and guns mounted at Fuchow, Shanghai, Canton and other vulnerable points. Money for these purposes was abundantly supplied by the customs duties on foreign trade, and China had learnt that at need she could borrow from the foreign banks on the security of this revenue.

In 1881 the senior regent, the empress Tsz'e An, was carried off by a sudden attack of heart disease, and the empress Tsz'e Hsi remained in undivided possession of the supreme power during the remainder of the emperor Kwang-su's minority. Li Hung-Chang, firmly established at Tientsin, within easy reach of the capital, as viceroy of the home province of Chihli and superintendent of northern trade, enjoyed a larger share of his imperial mistress's favour than was often granted by the ruling Manchus to officials of Chinese birth, and in all the graver questions of foreign policy his advice was generally decisive.

While the dispute with Japan was still going on regarding Korea, China found herself involved in a more serious quarrel in respect of another tributary state which lay on the southern frontier. By a treaty made between France and Annam in 1874, the Red river or Songkoi, which, rising in south-western China, flows through Tongking, was opened to trade, together with the cities of Haiphong and Hanoi situated on the delta. The object of the French was to find a trade route to Yun-nan and Sze-ch'uen from a base of their own, and it was hoped the Red river would furnish such a route. Tongking at this time, however, was infested with bands of pirates and cut-throats, many of whom were Chinese rebels or ex-rebels who had been driven across the frontier by the suppression of the Yun-nan and Taiping rebellions, conspicuous among them being an organization called the Black Flags. And when in 1882 France sent troops to Tongking to restore order (the Annamese government having failed to fulfil its promises in that respect) China began to protest, claiming that Annam was a vassal state and under her protection.

Tongking and Haool.

France took no notice of the protest, declaring that the claim had merely an archaeological interest, and that, in any case, China in military affairs was a *quantité négligeable*. France found, however, that she had undertaken a very serious task in trying to put down the forces of disorder (see TONGKING). The Black Flags were, it was believed, being aided by money and arms from China, and as time went on, the French were more and more being confronted with regular Chinese soldiers.

Troubles with France.

Several forts, well within the Tongking frontier, were known to be garrisoned by Chinese troops. Operations continued with more or less success during the winter and spring of 1883-1884. Both sides, however, were desirous of an arrangement, and in May 1884 a convention was signed between Li Hung-Chang and a Captain Fournier, who had been commissioned *ad hoc*, whereby China agreed to withdraw her garrisons and to open her frontiers to trade, France agreeing, on her part, to respect the fiction of Chinese suzerainty, and guarantee the frontier from attack by brigands. No date had been fixed in the convention for the evacuation of the Chinese garrisons, and Fournier endeavoured to supplement this by a memorandum to Li Hung-Chang, at the same time announcing the fact to his government. In pursuance of this arrangement the French troops proceeded to occupy Langson on the date fixed (21st June 1884). The Chinese commandant refused to evacuate, alleging, in a despatch which no one in the French camp was competent to translate, that he had received no orders, and begged for a short delay to enable him to communicate with his superiors. The French commandant ordered an attack, which was repulsed with severe loss. Mutual recriminations ensued. From Paris there came a demand for a huge indemnity as reparation

for the insult. The Peking government offered to carry out the convention, and to pay a small indemnity for the lives lost through the misunderstanding. This was refused, and hostilities recommenced, or, as the French preferred to call them, reprisals, for the fiction was still kept up that the two countries were not at war. Under cover of this fiction the French fleet peaceably entered the harbour of Fuchow, having passed the forts at the entrance to the river without hindrance. Once inside, they attacked and destroyed the much inferior Chinese fleet which was then quietly at anchor, destroying at the same time a large part of the arsenal which adjoins the anchorage (23rd August 1884). Retracing its steps, the French fleet attacked and destroyed with impunity the forts which were built to guard the entrance to the Min river, and could offer no resistance to a force coming from the rear. After this exploit the French fleet left the mainland and continued its reprisals on the coast of Formosa. Kelung, a treaty port, was bombarded and taken, October 4th. A similar attempt, however, on the neighbouring port of Tamsui was unsuccessful, the landing party having been driven back to their ships with severe loss. The attempt was not renewed, and the fleet thereafter confined itself to a semi-blockade of the island, which was prolonged into 1885 but led to no practical results. Negotiations for peace, however, which had been for some time in progress through the mediation of Sir Robert Hart, were at this juncture happily concluded (April 1885). The terms were practically those of the Fournier convention of the year before, the demand for an indemnity having been quietly dropped.

China, on the whole, came out of the struggle with greatly increased prestige. She had tried conclusions with a first-class European power and had held her own. Incorrect conclusions as to the military strength of China were consequently drawn, not merely by the Chinese themselves—which was excusable—but by European and even British authorities, who ought to have been better informed. War vessels were ordered by China both from England and Germany, and Admiral Lang, who had withdrawn his services while the war was going on, was re-engaged together with a number of British officers and instructors. The completion of the works at Port Arthur was taken in hand, and a beginning was made in the construction of forts at Wei-hai-wei as a second naval base. A new department was created for the control of naval affairs, at the head of which was placed Prince Chun, father of the emperor, who since the downfall of Prince Kung in 1884 had been taking a more and more prominent part in public affairs.

From 1885 to 1894 the political history of China does not call for extended notice. Two incidents, however, must be recorded, (1) the conclusion in 1886 of a convention with Great Britain, in which the Chinese government undertook to recognize British sovereignty in Burma, and (2) the temporary occupation of Port Hamilton by the British fleet (May 1885–February 1887). In 1890 Admiral Lang resigned his command of the Chinese fleet. During a temporary absence of Lang's colleague, Admiral Ting, the Chinese second in command, claimed the right to take charge—a claim which Admiral Lang naturally resented. The question was referred to Li Hung-Chang, who decided against Lang, whereupon the latter threw up his commission. From this point the fleet on which so much depended began to deteriorate. Superior officers again began to steal the men's pays, the ships were starved, shells filled with charcoal instead of powder were supplied, accounts were cooked, and all the corruption and malfeasance that were rampant in the army crept back into the navy.

The year 1894 witnessed the outbreak of the war with Japan. In the spring, complications again arose with Japan over Korea, and hostilities began in July. The story of the war is told elsewhere (see CHINO-JAPANESE WAR), and it is unnecessary here to recount the details of the decisive victory of Japan. A new power had arisen in the Far East, and when peace was signed by Li Hung-Chang at Shimonoseki on the 17th of April 1895 it meant the beginning of a new epoch. The terms included the cession of Liao-tung peninsula, then in actual occupation by the Japanese troops, the cession of Formosa, an indemnity of H. taels 200,000,000 (about £30,000,000) and various commercial privileges.

The signature of this treaty brought the European powers on the scene. It had been for some time the avowed ambition of Russia to obtain an ice-free port as an outlet to her Siberian

possessions—an ambition which was considered by British statesmen as not unreasonable. It did not, therefore, at all suit her purposes to see the rising power of Japan commanding the whole of the coast-line of Korea. Accordingly in the interval between the signature and the ratification of the treaty, invitations were addressed by Russia to the great powers to intervene with a view to its modification on the ground of the disturbance of the balance of power, and the menace to China which the occupation of Port Arthur by the Japanese would involve. France and Germany accepted the invitation, Great Britain declined. In the end the three powers brought such pressure to bear on Japan that she gave up the whole of her continental acquisitions, retaining only the island of Formosa. The indemnity was on the other hand increased by H. taels 30,000,000. For the time the integrity of China seemed to be preserved, and Russia, France and Germany could pose as her friends. Evidence was, however, soon forthcoming that Russia and France had not been disinterested in rescuing Chinese territory from the Japanese grasp. Russia now obtained the right to carry the Siberian railway across Chinese territory from Stryetensk to Vladivostok, thus avoiding a long détour, besides giving a grasp on northern Manchuria. France obtained, by a convention dated the 20th of June 1895, a rectification of frontier in the Mekong valley and certain railway and mining rights in Kiang-si and Yun-nan. Both powers obtained concessions of land at Hankow for the purposes of a settlement. Russia was also said to have negotiated a secret treaty, frequently described as the "Cassini Convention," but more probably signed by Li Hung-Chang at Moscow, giving her the right in certain contingencies to Port Arthur, which was to be refortified with Russian assistance. And by way of further securing her hold, Russia guaranteed a 4% loan of £15,000,000 issued in Paris to enable China to pay off the first instalment of the Japanese indemnity.

The convention between France and China of the 20th of June 1895 brought China into sharp conflict with Great Britain. China, having by the Burma convention of 1886 agreed to recognize British sovereignty over Burma, her quondam feudatory, also agreed to a delimitation of boundaries at the proper time. Effect was given to this last stipulation by a subsequent convention concluded in London (1st of March 1894), which traced the boundary line from the Shan states on the west as far as the Mekong river on the east. In the Mekong valley there were two semi-independent native territories over which suzerainty had been claimed in times gone, by both by the kings of Ava and by the Chinese emperors. These territories were named Meng Lun and Kiang Hung—the latter lying partly on one side and partly on the other of the Mekong river, south of the point where it issues from Chinese territory. The boundary line was so drawn as to leave both these territories to China, but it was stipulated that China should not alienate any portion of these territories to any other power without the previous consent of Great Britain. Yielding to French pressure, and regardless of the undertaking she had entered into with Great Britain, China, in the convention with France in June 1895, so drew the boundary line as to cede to France that portion of the territory of Kiang Hung which lay on the left bank of the Mekong. Compensation was demanded by Great Britain from China for this breach of faith, and at the same time negotiations were entered into with France. These resulted in a joint declaration by the governments of France and Great Britain, dated the 15th of January 1896, by which it was agreed as regards boundary that the Mekong from the point of its confluence with the Nam Huk northwards as far as the Chinese frontier should be the dividing line between the possessions or spheres of influence of the two powers. It was also agreed that any commercial privileges obtained by either power in Yun-nan or Sze-ch'uen should be open to the subjects of the other. The negotiations with China resulted in a further agreement, dated the 4th of February 1897, whereby considerable modifications in favour of Great Britain were made in the Burma boundary drawn by the 1894 convention.

European
Inter-
vention.

Increased
prestige
of China.

Mekong
valley
dispute,
1895.

1885-
1894.

War with
Japan,
1894.

While Russia and France were profiting by what they were pleased to call the generosity of China, Germany alone had so far received no reward for her share in compelling the retrocession of Liao-tung; but, in November 1897, she proceeded to help herself by seizing the Bay of Kiaochow in the province of Shan-tung. The act was done ostensibly in order to compel satisfaction for the murder of two German missionaries. A cession was ultimately made by way of a lease for a term of ninety-nine years—Germany to have full territorial jurisdiction during the continuance of the lease, with liberty to erect fortifications, build docks, and exercise all the rights of sovereignty. In December the Russian fleet was sent to winter in Port Arthur, and though this was at first described as a temporary measure, its object was speedily disclosed by a request made, in January 1898, by the Russian ambassador in London that two British cruisers, then also anchored at Port Arthur, should be withdrawn "in order to avoid friction in the Russian sphere of influence." They left shortly afterwards, and their departure in the circumstances was regarded as a blow to Great Britain's prestige in the Far East. In March the Russian government peremptorily demanded a lease of Port Arthur and the adjoining anchorage of Talienwan—a demand which China could not resist without foreign support. After an acrimonious correspondence with the Russian government Great Britain acquiesced in the *fait accompli*. The Russian occupation of Port Arthur was immediately followed by a concession to build a line of railway from that point northwards to connect with the Siberian trunk line in north Manchuria. As a counterpoise to the growth of Russian influence in the north, Great Britain obtained a lease of Wei-hai-wei, and formally took possession of it on its evacuation by the Japanese troops in May 1898.

After much hesitation the Chinese government had at last resolved to permit the construction of railways with foreign capital. An influential official named Sheng Hsuan-hwai was appointed director-general of railways, and empowered to enter into negotiations with foreign capitalists for that purpose. A keen competition thereupon ensued between syndicates of different nationalities, and their claims being espoused by their various governments, an equally keen international rivalry was set up. Great Britain, though intimating her preference for the "open door" policy, meaning equal opportunity for all, yet found herself compelled to fall in with the general movement towards what became known as the "spheres of influence" policy, and claimed the Yangtze valley as her particular sphere. This she did by the somewhat negative method of obtaining from the Chinese government a declaration that no part of the Yangtze valley should be alienated to any foreign power. A more formal recognition of the claim, as far as railway enterprise was concerned, was embodied in an agreement (28th of April 1899) between Great Britain and Russia, and communicated to the Chinese government, whereby the Russian government agreed not to seek for any concessions within the Yangtze valley, including all the provinces bordering on the great river, together with Cheh-kiang and Ho-nan, the British government entering into a similar undertaking in regard to the Chinese dominions north of the Great Wall.¹

In 1899 Talienwan and Kiaochow were respectively thrown open by Russia and Germany to foreign trade, and, encouraged by these measures, the United States government initiated in September of the same year a correspondence with the great European powers and Japan, with a view to securing their definite adhesion to the "open door" policy. The British government gave an unqualified approval to the American proposal, and the replies of the other powers, though more guarded, were accepted at Washington as satisfactory. A further and more definite step towards securing the maintenance of the "open door" in China was the agreement concluded in October 1900 between the British and German governments. The signatories, by the first two articles, agreed to endeavour to keep the ports on the rivers and littoral free and open to international trade and economic activity, and to uphold this rule for all Chinese territory as far as (wo

¹ A supplementary exchange of notes of the same date excepted from the scope of this agreement the Shan-hai-kwan-Niu-chwang extension which had already been conceded to the Hongkong & Shanghai Bank.

in the German counterpart) they could exercise influence; not to use the existing complications to obtain territorial advantages in Chinese dominions, and to seek to maintain undiminished the territorial condition of the Chinese empire. By a third article they reserved their right to come to a preliminary understanding for the protection of their interests in China, should any other power use those complications to obtain such territorial advantages under any form whatever. On the submission of the agreement to the powers interested, Austria, France, Italy and Japan accepted its principles without express reservation—Japan first obtaining assurances that she signed on the same footing as an original signatory. The United States accepted the first two articles, but expressed no opinion on the third. Russia construed the first as limited to ports actually open in regions where the two signatories exercise "their" influence, and favourably entertained it in that sense, ignoring the reference to other forms of economic activity. She fully accepted the second, and observed that in the contingency contemplated by the third, she would modify her attitude according to circumstances.

Meanwhile, negotiations carried on by the British minister at Peking during 1898 resulted in the grant of very important privileges to foreign commerce. The payment of the second instalment of the Japanese indemnity was becoming due, and it was much discussed how and on what terms China would be able to raise the amount. The Russian government, as has been stated, had made China a loan of the sum required for the first portion of the indemnity, viz. £15,000,000, taking a charge on the customs revenue as security. The British government was urged to make a like loan of £16,000,000 both as a matter of friendship to China and as a counterpoise to the Russian influence. An arrangement was come to accordingly, on very favourable terms financially to the Chinese, but at the last moment they drew back, being overawed, as they said, by the threatening attitude of Russia. Taking advantage of the position which this refusal gave him, the British minister obtained from the Tsung-Li-Yamen, besides the declaration as to the non-alienation of the Yangtze valley above mentioned, an undertaking to throw the whole of the inland waterways open to steam traffic. The Chinese government at the same time undertook that the post of inspector-general of customs (then held by Sir Robert Hart) should always be held by an Englishman so long as the trade of Great Britain was greater than that of any other nation. Minor concessions were also made, but the opening of the waterways was by far the greatest advance that had been made since 1860.

Of still greater importance were the railway and mining concessions granted during the same year (1898). The Chinese government had been generally disposed to railway construction since the conclusion of the Japanese War, but hoped to be able to retain the control in their own hands. The masterful methods of Russia and Germany had obliged them to surrender this control so far as concerned Manchuria and Shan-tung. In the Yangtze valley, Sheng, the director-general of railways, had been negotiating with several competing syndicates. One of these was a Franco-Belgian syndicate, which was endeavouring to obtain the trunk line from Hankow to Peking. A British company was tendering for the same work, and as the line lay mainly within the British sphere it was considered not unreasonable to expect it should be given to the latter. At a critical moment, however, the French and Russian ministers intervened, and practically forced the Yamen to grant a contract in favour of the Franco-Belgian company. The Yamen had a few days before explicitly promised the British minister that the contract should not be ratified without his having an opportunity of seeing it. As a penalty for this breach of faith, and as a set-off to the Franco-Belgian line, the British minister required the immediate grant of all the railway concessions for which British syndicates were then negotiating, and on terms not inferior to those granted to the Belgian line. In this way all the lines in the lower Yangtze, as also the Shan-si Mining Companies' lines, were secured. A contract for a trunk line from Canton to Hankow was negotiated in the latter part of 1898 by an American company.

There can be little doubt that the powers, engrossed in the diplomatic conflicts of which Peking was the centre, had entirely underrated the reactionary forces gradually mustering for a struggle against the aggressive spirit of Western civilization. The lamentable consequences of administrative corruption and incompetence, and the superiority of foreign methods which had been amply illustrated by the Japanese War, had at first produced a considerable impression, not only upon the more enlightened commercial classes, but even upon many of the younger members of the official classes in China. The dowager-empress, who, in spite of the emperor Kwang-su having nominally attained his majority, had retained practical control of the supreme power until the conflict with Japan, had been held, not unjustly to blame for the disasters of the war, and even before its conclusion the young emperor was adjured by some of the most responsible among his own subjects to shake himself free from the baneful restraint of "petticoat government,"

and himself take the helm. In the following years a reform movement, undoubtedly genuine, though opinions differ as to the value of the popular support which it claimed, spread throughout the central and southern provinces of the empire. One of the most significant symptoms was the relatively large demand which suddenly arose for the translations of foreign works and similar publications in the Chinese language which philanthropic societies, such as that "for the Diffusion of Christian and General Knowledge amongst the Chinese," had been trying for some time past to popularize, though hitherto with scant success. Chinese newspapers published in the treaty ports spread the ferment of new ideas far into the interior. Fifteen hundred young men of good family applied to enter the foreign university at Peking, and in some of the provincial towns the Chinese themselves subscribed towards the opening of foreign schools. Reform societies, which not infrequently enjoyed official countenance, sprang up in many of the large towns, and found numerous adherents amongst the younger *litterati*. Early in 1898 the emperor, who had gradually emancipated himself from the dowager-empress's control, summoned several of the reform leaders to Peking, and requested their advice with regard to the progressive measures which should be introduced into the government of the empire. Chief amongst these reformers was Kang Yu-wei, a Cantonese, whose scholarly attainments, combined with novel teachings, earned for him from his followers the title of the "Modern Sage." Of his more or less active sympathizers who had subsequently to suffer with him in the cause of reform, the most prominent were Chang Yin-huan, a member of the grand council and of the Tsung-Li-Yamen, who had represented his sovereign at Queen Victoria's jubilee in 1897; Chin Pao-chen, governor of Hu-nan; Liang Chichao, the editor of the reformers' organ, *Chinese Progress*; Su Chiching, a reader of the Hanlin College, the educational stronghold of Chinese conservatism; and his son Su In-chi, also a Hanlin man, and provincial chancellor of public instruction in Hu-nan.

It soon became evident that there was no more enthusiastic advocate of the new ideas than the emperor himself. Within a few months the vermilion pencil gave the imperial sanction to a succession of edicts which, had they been carried into effect, would have amounted to a revolution as far-reaching as that which had transformed Japan thirty years previously. The fossilized system of examinations for the public service was to be altogether superseded by a new schedule based on foreign learning, for the better promotion of which a number of temples were to be converted into schools for Western education; a state department was to be created for the translation and dissemination of the standard works of Western literature and science; even the scions of the ruling Manchu race were to be compelled to study foreign languages and travel abroad; and last, but not least, all useless offices both in Peking and in the provinces were to be abolished. A further edict was even reported to be in contemplation, doing away with the *queue* or pigtail, which, originally imposed upon the Chinese by their Manchu conquerors as a badge of subjection, had gradually become the most characteristic and most cherished feature of the national dress. But the bureaucracy of China, which had battered for centuries on corruption and ignorance, had no taste for self-sacrifice. Other vested interests felt themselves equally threatened, and behind them stood the whole latent force of popular superstition and unreasoning conservatism.

The dowager-empress saw her opportunity. The Summer Palace, to which she had retired, had been for some time the centre of resistance to the new movement, and in the middle of September 1898 a report became current that, in order to put an end to the obstruction which hampered his reform policy, the emperor intended to seize the person of the dowager-empress and have her deported into the interior. Some colour was given to this report by an official announcement that the emperor would hold a review of the foreign-drilled troops at Tientsin, and had summoned Yuan Shihkai, their general, to Peking in order to confer with him on the necessary arrangements. But the re-

formers had neglected to secure the goodwill of the army, which was still entirely in the hands of the reactionaries. During the night of the 20th of September the palace of the emperor was occupied by the soldiers, and on the following day Kwang-su, who was henceforth virtually a prisoner in the hands of the empress, was made to issue an edict restoring her regency. Kang Yu-wei, warned at the last moment by an urgent message from the emperor, succeeded in escaping, but many of the most prominent reformers were arrested, and six of them were promptly executed. The *Peking Gazette* announced a few days later that the emperor himself was dangerously ill, and his life might well have been despaired of had not the British minister represented in very emphatic terms the serious consequences which might ensue if anything happened to him. Drastic measures were, however, adopted to stamp out the reform movement in the provinces as well as in the capital. The reform edicts were cancelled, the reformers' associations were dissolved, their newspapers suppressed, and those who did not care to save themselves by a hasty recantation of their errors were imprisoned, proscribed or exiled. In October the reaction had already been accompanied by such a recrudescence of anti-foreign feeling that the foreign ministers at Peking had to bring up guards from the fleet for the protection of the legations, and to demand the removal from the capital of the disorderly Kan-suh soldiery which subsequently played so sinister a part in the troubles of June 1900. But the unpleasant impression produced by these incidents was in a great measure removed by the demonstrative reception which the empress Tsz'e Hsi gave on the 15th of October to the wives of the foreign representatives — an act of courtesy unprecedented in the annals of the Chinese court.

The reactionary tide continued to rise throughout the year 1899, but it did not appear materially to affect the foreign relations of China. Towards the end of the year the brutal murder of Mr Brooks, an English missionary, in Shan-tung, had compelled attention to a popular movement which had been spreading rapidly throughout that province and the adjoining one of Chih-li with the connivance of certain high officials, if not under their direct patronage. The origin of the "Boxer" movement is obscure. Its name is derived from a literal translation of the Chinese designation, "the fist of righteous harmony." Like the kindred "Big Sword" Society, it appears to have been in the first instance merely a secret association of malcontents chiefly drawn from the lower classes. Whether the empress Tsz'e Hsi and her Manchu advisers had deliberately set themselves from the beginning to avert the danger by deflecting what might have been a revolutionary movement into anti-foreign channels, or whether with Oriental heedlessness they had allowed it to grow until they were powerless to control it, they had unquestionably resolved to take it under their protection before the foreign representatives at Peking had realized its gravity. The outrages upon native Christians and the threats against foreigners generally went on increasing. The Boxers openly displayed on their banners the device: "Exterminate the foreigners and save the dynasty," yet the representatives of the powers were unable to obtain any effective measures against the so-called "rebels," or even a definite condemnation of their methods.¹

Four months (January–April 1900) were spent in futile interviews with the Tsung-Li-Yamen. In May a number of Christian villages were destroyed and native converts massacred near the capital. On the 2nd of June two English missionaries, Mr Robinson and Mr Norman, were murdered at Yung Ching, 40 m. from Peking. The whole country was overrun with bands of Boxers, who tore up the railway and set fire to the stations at different points on the Peking-Tientsin line. Fortunately a

¹ The religious aspect of the Boxer movement gave it strength. Its disciples believed that the spirits which defended China were incensed by the introduction of Western methods and ideals. Many of them believed themselves to be invulnerable to any Western weapon. (See Lord W. Cecil, *Changing China*, 1910, ch. i.)

*The reform
move-
ment,
1898.*

*The
Empress's
coup
d'état.*

*The Boxer
move-
ment,
1900.*

mixed body of marines and bluejackets of various nationalities, numbering 18 officers and 389 men, had reached Peking on the 1st of June for the protection of the legations. The whole city was in a state of turmoil. Murder and pillage were of daily occurrence. The reactionary Prince Tuan (grandson of the emperor Tao-kwang) and the Manchus generally, together with the Kan-suh soldiery under the notorious Tung-fu-hsiang, openly sided with the Boxers. The European residents and a large number of native converts took refuge in the British legation, where preparations were hastily made in view of a threatened attack. On the 11th the chancellor of the Japanese legation, Mr Sugiyama, was murdered by Chinese soldiers. On the night of the 13th most of the foreign buildings, churches and mission houses in the eastern part of the Tatar city were pillaged and burnt, and hundreds of native Christians massacred. On the 20th of June the German minister, Baron von Ketteler, was murdered whilst on his way to the Tsung-Li-Yamen. At 4 P.M. on the afternoon of the 20th the Chinese troops opened fire upon the legations. The general direction of the defence was undertaken by Sir Claude Macdonald, the British minister.

Meanwhile Peking had been completely cut off since the 14th from all communication with the outside world, and in view of

International expedition. the gravity of the situation, naval and military forces were being hurried up by all the powers to the Gulf of Chih-li. On the 10th of June Admiral Sir E. Seymour had already left Tientsin with a mixed force of 2000

British, Russian, French, Germans, Austrians, Italians, Americans and Japanese, to repair the railway and restore communications with Peking. But his expedition met with unexpectedly severe resistance, and it had great difficulty in making good its retreat after suffering heavy losses. When it reached Tientsin again on the 26th of June, the British contingent of 915 men had alone lost 124 killed and wounded out of a total casualty list of 62 killed and 218 wounded. The Chinese had in the meantime made a determined attack upon the foreign settlements at Tientsin, and communication between the city and the sea being also threatened, the Taku forts at the mouth of the Pei-ho were captured by the allied admirals on the 17th. The situation at Tientsin nevertheless continued precarious, and it was not till the arrival of considerable reinforcements that the troops of the allied powers were able to assume the offensive, taking the native city by storm on July 14th, at a cost, however, of over 700 killed and wounded. Even in this emergency international jealousy had grievously delayed the necessary concentration of forces. No power was so favourably situated to take immediate action as Japan, and the British government, who had strongly urged her to act speedily and energetically, undertook at her request to sound the other powers with regard to her intervention. No definite objection was raised, but the replies of Germany and Russia barely disguised their ill-humour. Great Britain herself went so far as to offer Japan the assistance of the British treasury, in case financial difficulties stood in the way, but on the same day on which this proposal was telegraphed to Tokyo (6th of July), the Japanese government had decided to embark forthwith the two divisions which it had already mobilized. By the beginning of August one of the Indian brigades had also reached Tientsin together with smaller reinforcements sent by the other powers, and thanks chiefly to the energetic counsels of the British commander, General Sir Alfred Gaselee, a relief column, numbering 20,000 men, at last set out for Peking on the 4th of August, a British naval brigade having started up river the previous afternoon. After a series of small engagements and very trying marches it arrived within striking distance of Peking on the evening of the 13th. The Russians tried to steal a march upon the allies during the night, but were checked at the walls and suffered heavy losses. The Japanese attacked another point of the walls the next morning, but met with fierce opposition, whilst the Americans were delayed by getting entangled in the Russian line of advance. The British contingent was more fortunate, and skilfully guided to an unguarded water-gate, General Gaselee and a party of Sikhs were the first to force their way through to the British legation. About 2 p.m.

on the afternoon of the 14th of August, the long siege was raised.

For nearly six weeks after the first interruption of communications, no news reached the outside world from Peking except a few belated messages, smuggled through the Chinese lines by native runners, urging the imperative necessity of prompt relief. During the greater part of that period the foreign quarter was subjected to heavy rifle and artillery fire, and the continuous fighting at close quarters with the hordes of Chinese regulars, as well as Boxers, decimated the scanty ranks of the defenders. The supply of both ammunition and food was slender. But the heroism displayed by civilians and professional combatants alike was inexhaustible. In their anxiety to burn out the British legation, the Chinese did not hesitate to set fire to the adjoining buildings of the Hanlin, the ancient seat of Chinese classical learning, and the storehouse of priceless literary treasures and state archives. The *Fu*, or palace, of Prince Su, separated only by a canal from the British legation, formed the centre of the international position, and was held with indomitable valour by a small Japanese force under Colonel Sheba, assisted by a few Italian marines and volunteers of other nationalities and a number of Christian Chinese. The French legation on the extreme right, and the section of the city wall held chiefly by Germans and Americans, were also points of vital importance which had to bear the brunt of the Chinese attack.

Little is known as to what passed in the councils of the Chinese court during the siege.¹ But there is reason to believe that throughout that period grave divergences of opinion existed amongst the highest officials. The attack upon the legations appears to have received the sanction of the dowager-empress, acting upon the advice of Prince Tuan and the extreme Manchu party, at a grand council held during the night of the 18th/19th June, upon receipt of the news of the capture of the Taku forts by the international forces. The emperor himself, as well as Prince Ching and a few other influential mandarins, strongly protested against the empress's decision, but it was acclaimed by the vast majority of those present. Three members of the Tsung-Li-Yamen were publicly executed for attempting to modify the terms of an imperial edict ordering the massacre of all foreigners throughout the provinces, and most of the Manchu nobles and high officials, and the eunuchs of the palace, who played an important part in Chinese politics throughout the dowager-empress's tenure of power, were heart and soul with the Boxers. But it was noted by the defenders of the legations that Prince Ching's troops seldom took part, or only in a half-hearted way, in the fighting, which was chiefly conducted by Tung-fu-hsiang's soldiery and the Boxer levies. The modern artillery which the Chinese possessed was only spasmodically brought into play. Nor did any of the attacking parties ever show the fearlessness and determination which the Chinese had somewhat unexpectedly displayed on several occasions during the fighting at and around Tientsin. Nevertheless, the position of the defenders at the end of the first four weeks of the siege had grown well-nigh desperate. Mining and incendiarism proved far greater dangers than shot and shell. Suddenly, just when things were looking blackest, on the 17th of July the Chinese ceased firing, and a sort of informal armistice secured a period of respite for the beleaguered Europeans. The capture of the native city of Tientsin by the allied forces had shaken the self-confidence of the Chinese authorities, who had hitherto not only countenanced, but themselves directed the hostilities.² Desultory fighting, nevertheless, continued, and grave fears were entertained that the approach of the relief column would prove the signal for a desperate attempt to rush the legations. The attempt was made, but failed. The relief, however, came not a day too soon. Of the small band of defenders which, including civilian volunteers, had never mustered 500, 65 had been killed and 131 wounded. Ammunition and provisions were almost at an end. Even more desperate was the situation at the Pei-tang, the Roman Catholic northern cathedral and mission house, where, with the help of a small body of French and Italian marines, Mgr Favier had organized an independent centre of resistance for his community of over 3000 souls. Their rations were absolutely exhausted when, on the 15th

¹ The diary of a Manchu noble printed in *China under the Empress Dowager* (1910) by J. O. Bland and E. Backhouse throws light on the subject. It was to Jung-Lu, father-in-law of Prince Chin, that the legations owed their escape from extermination.

² It was at this time (July 17th) that the intense anxiety of the civilized world with regard to the fate of the besieged reached its culminating point. Circumstantial accounts of the fall of the legations and the massacre of their inmates were circulated in Shanghai and found general credence. It was not till near the end of the month that an authentic message from the American minister proved these fears to be premature.

of August, a relief party was despatched to their assistance from the legations.

The ruin wrought in Peking during the two months' fighting was appalling. Apart from the wholesale destruction of foreign property in the Tatar city, and of Chinese as well as European buildings in the vicinity of the legations, the wealthiest part of the Chinese city had been laid in ashes. The flames from a foreign drug store fired by the Boxers had spread to the adjoining buildings, and finally consumed the whole of the business quarter with all its invaluable stores of silks, curiosities, furs, &c. The retribution which overtook Peking after its capture by the international forces was scarcely less terrible. Looting was for some days almost universal. Order was, however, gradually restored, first in the Japanese and then in the British and American quarters, though several months elapsed before there was any real revival of native confidence.

So unexpected had been the rapid and victorious advance of the allies, that the dowager-empress with the emperor and the rest of the court did not actually leave Peking until the day after the legations had been relieved. But the northern and western portions of the Tatar city had not yet been occupied, and the fugitives made good their escape on the 15th. When the allies some days later marched through the Forbidden City, they only found a few eunuchs and subordinate officials in charge of the imperial apartments. At the end of September, Field Marshal Count von Waldersee, with a German expeditionary force of over 20,000 men, arrived to assume the supreme command conferred upon him with the more or less willing assent of the other powers.

The political task which confronted the powers after the occupation of Peking was far more arduous than the military one.

The action of the Russians in Manchuria, even in a treaty port like Niu-chwang, the seizure of the railway line not only to the north of the Great Wall, but also from Shan-hai-kwan to Peking, by the Russian military

authorities, and the appropriation of an extensive line of river frontage at Tientsin as a Russian "settlement," were difficult to reconcile with the pacific assurances of disinterestedness which Russia, like the rest of the powers, had officially given. Great anxiety prevailed as to the effect of the flight of the Chinese court in other parts of the empire. The anti-foreign movement had not spread much beyond the northern provinces, in which it had had the open support of the throne and of the highest provincial officials. But among British and Americans alone, over 200 defenceless foreigners, men, women and children, chiefly missionaries, had fallen victims to the treachery of high-placed mandarins like Yü Hsien, and hundreds of others had had to fly for their lives, many of them owing their escape to the courageous protection of petty officials and of the local gentry and peasantry. In the Yangtze valley order had been maintained by the energy of the viceroys of Nanking and Wu-chang, who had acted throughout the critical period in loyal co-operation with the British consuls and naval commanders, and had courageously disregarded the imperial edicts issued during the ascendancy of the Boxers. After some hesitation, an Indian brigade, followed by French, German and Japanese contingents, had been landed at Shanghai for the protection of the settlements, and though the viceroy, Liu Kun-yi, had welcomed British support, and even invited the joint occupation of the Yangtze forts by British and Chinese troops, the appearance of other European forces in the Yangtze valley was viewed with great suspicion. In the south there were serious symptoms of unrest, especially after Li Hung-Chang had left Canton for the north, in obedience, as he alleged at the time, to an imperial edict which, there is reason to believe, he invented for the occasion. The Chinese court, after one or two intermediate halts, had retired to Si-gan-fu, one of the ancient capitals of the empire, situated in the inaccessible province of Shen-si, over 600 m. S.W. of Peking. The influence of the ultra-reactionaries, headed by Prince Tuan and General Tung-fu-hsiang, still dominated its councils, although credentials were sent to Prince Ching and to Li Hung-Chang, who, after waiting upon events at Shanghai, had proceeded to Peking,

authorizing them to treat with the powers for the re-establishment of friendly relations.

The harmony of the powers, which had been maintained with some difficulty up to the relief of the legations, was subjected to a severe strain as soon as the basis of negotiations with the Chinese government came to be discussed. While for various reasons Russia, Japan and the United States were inclined to treat China with great indulgence, Germany insisted upon the signal punishment of the guilty officials as a *conditio sine qua non*, and in this she had the support not only of the other members of the Triple Alliance, but also of Great Britain, and to some extent even of France, who, as protector of the Roman Catholic Church in Eastern countries, could not allow the authors of the atrocities committed upon its followers to escape effectual punishment. It was not until after months of laborious negotiations that the demands to be formally made upon the Chinese government were embodied in a joint note signed by all the foreign ministers on the 20th and 21st of December 1900. The demands were substantially as follows:

Honourable reparation for the murder of von Ketteler and of Mr Sugiyama, to be made in a specified form, and expiatory monuments to be erected in cemeteries where foreign tombs had been desecrated. "The most severe punishment befitting their crimes" was to be inflicted on the personages designated by the decree of the 21st of September, and also upon others to be designated later by the foreign ministers, and the official examinations were to be suspended in the cities where foreigners had been murdered or ill-treated. An equitable indemnity, guaranteed by financial measures acceptable to the powers, was to be paid to states, societies and individuals, including Chinese who had suffered because of their employment by foreigners, but not including Chinese Christians who had suffered only on account of their faith. The importation or manufacture of arms or *matériel* was to be forbidden; permanent legation guards were to be maintained at Peking, and the diplomatic quarter was to be fortified, while communication with the sea was to be secured by a foreign military occupation of the strategic points and by the demolition of the Chinese forts, including the Taku forts, between the capital and the coast. Proclamations were to be posted throughout China for two years, threatening death to the members of anti-foreign societies, and recording the punishment of the ringleaders in the late outrages; and the viceroys, governors and provincial officials were to be declared by imperial edict responsible, on pain of immediate dismissal and perpetual disability to hold office, for anti-foreign outbreaks or violations of treaty within their jurisdictions. China was to facilitate commercial relations by negotiating a revision of the commercial treaties. The Tsung-Li-Yamen was to be reformed and the ceremonial for the reception of foreign ministers modified as the powers should demand. Compliance with these terms was declared to be a condition precedent to the arrangement of a time limit to the occupation of Peking and of the provinces by foreign troops.

Under instructions from the court, the Chinese plenipotentiaries affixed their signatures on the 14th of January 1901 to a protocol, by which China pledged herself to accept these terms in principle, and the conference of ministers then proceeded to discuss the definite form in which compliance with them was to be exacted. This further stage of the negotiations proved even more laborious and protracted than the preliminary proceedings. No attempt was made to raise the question of the dowager-empress's responsibility for the anti-foreign movement, as Russia had from the first set her face against the introduction of what she euphemistically termed "the dynastic question." But even with regard to the punishment of officials whose guilt was beyond dispute, grave divergences arose between the powers. The death penalty was ultimately waived in the case even of such conspicuous offenders as Prince Tuan and Tung-fu-hsiang, but the notorious Yü Hsien and two others were decapitated by the Chinese, and three other metropolitan officials were ordered to commit suicide, whilst upon others sentences of banishment, imprisonment and degradation were passed, in accordance with a list drawn up by the foreign representatives. The question of the punishment of provincial officials responsible for the massacre of scores of defenceless men, women and children was unfortunately reserved for separate treatment, and when it came up for discussion it became impossible to preserve even the semblance of unanimity, the Russian minister at once taking issue with his colleagues, although he had originally pledged himself as formally as the others to the principle. Count

Looting of Peking.

Flight of the Chinese court.

Restoration of order.

Measures of reparation.

Lamsdorff frankly told the British ambassador at St Petersburg that Russia took no interest in missionaries, and as the foreigners massacred in the provinces belonged mostly to that class, she declined to join in the action of the other powers.

The real explanation of Russia's cynical secession from the concert of powers on this important issue must be sought in her anxiety to conciliate the Chinese in view of the separate negotiations in which she was at the same time engaged with China in respect of Manchuria. When the Boxer movement was at its height at the end of June 1900, the Chinese authorities in Manchuria had wantonly "declared war" against Russia, and for a moment a great wave of panic seems to have swept over the Russian administration, civil and military, in the adjoining provinces. The reprisals exercised by the Russians were proportionately fierce. The massacre at Blagovyeshchensk, where 5000 Chinese—men, women and children—were flung into the Amur by the Cossacks, was only one incident in the reign of terror by which the Russians sought to restore their power and their prestige. The resistance of the Chinese troops was soon overcome, and Russian forces overran the whole province, occupying even the treaty port of Niu-chwang. The Russian government officially repudiated all responsibility for the proclamations issued by General Gribsky and others, foreshadowing, if not actually proclaiming, the annexation of Chinese territory to the Russian empire. But Russia was clearly bent on seizing the opportunity for securing a permanent hold upon Manchuria. In December 1900 a preliminary agreement was made between M. Korostovetz, the Russian administrator-general, and Tseng, the Tatar general at Mukden, by which the civil and military administration of the whole province was virtually placed under Russian control. In February 1901 negotiations were opened between the Russian government and the Chinese minister at St Petersburg for the conclusion of a formal convention of a still more comprehensive character. In return for the restoration to China of a certain measure of civil authority in Manchuria, Russia was to be confirmed in the possession of exclusive military, civil and commercial rights, constituting in all but name a protectorate, and she was also to acquire preferential rights over all the outlying provinces of the Chinese empire bordering on the Russian dominions in Asia. The clauses relating to Chinese Turkestan, Kashgar, Yarkand, Khotan and Mongolia were subsequently stated to have been dropped, but the convention nevertheless provoked considerable opposition both in foreign countries and amongst the Chinese themselves. Most of the powers, including Germany, who, however, denied that the Anglo-German agreement of the 16th of October 1900 applied to Manchuria,¹ advised the Chinese government not to pursue separate negotiations with one power whilst collective negotiations were in progress at Peking, and both Japan and Great Britain pressed for definite information at St Petersburg with regard to the precise tenor of the proposed convention. At the same time the two viceroys of the lower Yangtze memorialized the throne in the strongest terms against the convention, and these protests were endorsed not only by the great majority of Chinese officials of high rank throughout the provinces, but by popular meetings and influential guilds and associations. Ultimately the two viceroys, Chang Chih-tung and Liu Kun-yi,² took the extreme step of warning the throne that they would be unable to recognize the convention, even if it were ratified, and notwithstanding the pressure exercised in favour of Russia by Li Hung-Chang, the court finally instructed the Chinese minister at St Petersburg to decline his signature. The attitude of Japan, where public

¹ In negotiating this agreement Lord Salisbury appears to have been largely influenced by the aggressive features of Russia's action in North China, while Germany appears to have been actuated by a desire to forestall isolated action by Great Britain in the Yangtze basin. In Germany the agreement was known as the Yangtze Agreement. Great Britain held, however, that it applied equally to Manchuria.

² Liu Kun-yi died in 1902. In the same year died Tao-mu, the viceroy of Canton. In these men China lost two of her most capable and enlightened officials.

feeling ran high, was equally significant, and on the 3rd of April the Russian government issued a circular note to the powers, stating that, as the generous intentions of Russia had been misconstrued, she withdrew the proposed convention.

The work of the conference at Peking, which had been temporarily disturbed by these complications, was then resumed. Friction between European troops of different nationalities and an Anglo-Russian dispute over the construction of certain roads and railway sidings at Tientsin showed that an international occupation was fraught with manifold dangers. The question of indemnities, however, gave rise to renewed friction. Each power drew up its own claim, and whilst Great Britain, the United States and Japan displayed great moderation, other powers, especially Germany and Italy, put in claims which were strangely out of proportion to the services rendered by their military and naval forces. It was at last settled that China should pay altogether an indemnity of 450 million taels, to be secured (1) on the unhypothecated balance of the customs revenue administered by the imperial maritime customs, the import duties being raised forthwith to an effective 5% basis; (2) on the revenues of the "native" customs in the treaty ports; (3) on the total revenues of the salt gabelle. Finally the peace protocol was drawn up in a form which satisfied all the powers as well as the Chinese court. The formal signature was, however, delayed at the last moment by a fresh difficulty concerning Prince Chun's penitential mission to Berlin. This prince, an amiable and enlightened youth,³ son of the Prince Chun who was the emperor Hien-fêng's brother, and thus himself half-brother to the emperor Kwang-su, had reached Basel towards the end of August on his way to Germany, when he was suddenly informed that he and his suite would be expected to perform *kowtow* before the German emperor. The prince resented this unexpected demand, and referred home for instructions. The Chinese court appear to have remained obdurate, and the German government perceived the mistake that had been made in exacting from the Chinese prince a form of homage which Western diplomacy had for more than a century refused to yield to the Son of Heaven, on the ground that it was barbarous and degrading. The point was waived, and Prince Chun was received in solemn audience by the emperor William at Potsdam on the 4th of September. Three days later, on the 7th of September, the peace protocol was signed at Peking.

The articles recorded the steps to be taken to satisfy the demands of the powers as to commerce. Article 11 provided for the amendment of existing treaties of commerce and navigation, and for river conservancy measures at Tientsin and Shanghai. The British government appointed a special commission, with Sir J. Mackay, member of the council of India, as chief commissioner, to proceed to Shanghai to carry on the negotiations, and a commercial treaty was signed at Shanghai on the 6th of September 1902, by which existing obstacles to foreign trade, such as *likin*, &c., were removed, regulations were made for facilitating steamer navigation on inland waters, and several new ports were opened to foreign commerce.

In accordance with the terms of the protocol, all the foreign troops, except the legation guards, were withdrawn from Peking on the 17th of September, and from the rest of Chih-li, except the garrisons at the different points specified along the line of communications, by the 22nd of September. On the 7th of October it was announced that the Chinese court had left Si-gan-fu on its way back to the northern capital. A month later (7th of November) the death of Li Hung-Chang at Peking removed, if not the greatest of Chinese statesmen, at any rate the one who had enjoyed the largest share of the empress-dowager's confidence.

(V. C.)

(E)—From 1901 to 1910.

The events connected with the Boxer rising and its suppression demonstrated even more forcibly than had the war with Japan in 1894-1895 the necessity for the adoption of

³ Prince Chun was born in 1882. He was the first member of the imperial family to be sent on a foreign mission.

The peace protocol, 1901.

Western methods in many departments of life and administration if China was to maintain the position of a great power.

The necessity for a thorough reform of the administration was widely recognized in 1901; and among the progressive classes of the community much disappointment was manifested because the powers had failed to insist, in the conditions of peace, on a reorganization of the machinery of government. The Yangtze viceroys, the viceroy at Canton, Yuan Shih-kai and other high mandarins repeatedly memorialized the throne to grant effective reforms. While at Si-gan-fu the court did in fact issue several reform decrees, but at the same time all authority remained in the hands of reactionaries. There had been an awakening in China, but another lesson—afforded a few years later by the Russo-Japanese War—was needed before the reform party was able to gain real power.

For three or four years following the signing of the peace protocol of 1901 it seemed indeed that there would be little change in the system of government, though in some directions a return to the old state of affairs was neither possible nor desired. On the 7th of January 1902 the court returned to Peking—a step which marked the restoration, more or less, of normal conditions. The failure of the Boxer movement, in which, as has been shown, she was deeply implicated, had impressed upon the dowager empress the need for living on better terms with foreign powers, but the reform edicts issued from Si-gan-fu remained largely inoperative, though some steps were taken to promote education on Western lines, to readjust the land tax, and especially to reorganize the military forces (though on provincial rather than on a national basis). The building of railways was also pushed on, but the dowager empress was probably at heart as reactionary as she had proved in 1898. The emperor himself from his return to Peking until the day of his death appeared to have little influence on public affairs. The most disquieting feature of the situation in the years immediately following the return of the court to Peking was the continued efforts of Russia to obtain full control of Manchuria and a predominant influence in north China. The Chinese government was powerless to stem the advance of Russia, and the dowager empress herself was credited with indifference to the fate of Manchuria. It was the menace to other powers, notably Japan, involved in Russia's action which precipitated an issue in which the destinies of China were involved. Before considering the results of that struggle (the Russo-Japanese War) the chief events of the years 1902-1905 may be outlined.

The dowager empress from the day of her return from Si-gan-fu set herself to conciliate the foreign residents in Peking. Many foreign onlookers were gathered on the wall of the Tatar city to witness the return of the court, and to these the dowager empress made a deep bow twice, an apparently trivial incident which made a lasting impression. On the 1st of February following the dowager empress received the ladies of the various embassies, when she bewailed the attack on the legations, entertained her guests to tea and presented each with articles of jewelry, and from that time onward, as occasion offered, Tsz'e Hsi exchanged compliments and civilities with the foreign ladies in Peking. Moreover, Sir Robert Hart—after having been nearly forty years in China—was now presented at court, as well as Bishop Favier and others. Henceforth attacks on foreigners received no direct encouragement at court. Tung Fu-hsiang,¹ who had been banished to the remote province of Kan-suh, had at his command there his old Boxer troops, and his attitude caused anxiety at the end of 1902. He was said to have received support from Prince Tuan—who had been obliged to retire to Mongolia—but events proved that the power or the intention of these reactionaries to create trouble had been miscalculated. There were indeed serious Boxer disturbances in Sze-ch'uen in 1902, but they were put down by a new viceroy sent from Peking. Notwithstanding the murder of fifteen missionaries during

¹ Tung Fu-hsiang died in 1908. A sum of some £80,000 belonging to him, and left in the provincial treasury, was appropriated for works of public utility (see *The Times*, April 9th, 1910)

1902-1905, there was in general a marked improvement in the relations between the missionaries, the official classes and the bulk of the people, and an eagerness was shown in several provinces to take advantage of their educational work. This was specially marked in Hu-nan, a province which had been for long hostile to missionary endeavours. Illustrative of the attitude of numbers of high officials was the attendance of the viceroy of Sze-ch'uen, with the whole of his staff, at the opening in 1905 at Cheng-tu of new buildings of the Canadian Methodist Mission. This friendly attitude towards the missions was due in part to the influence of Chinese educated abroad and also, to a large extent, to the desire to take advantage of Western culture. The spread of this new spirit was coincident with an agitation for independence of foreign control and the determination of the Chinese to use modern methods to attain their ends. Thus in 1905 there was an extensive boycott of American goods throughout China, as a retaliatory measure for the exclusion of Chinese from the United States. Regarding China as a whole the attitude of the people towards Europeans was held to indicate that the general view was, not that the Boxer teaching was false, but that the spirits behind Western religion were more powerful than those behind Boxerdom. The spiritual prestige of Christianity and respect for the power of the foreigner were direct outcomes of the failure of the Boxers.² The British expedition to Tibet in 1904, the occupation of Lhasa in August of that year, the flight of the Dalai Lama to Mongolia, gave grave concern to the Chinese government—which showed much persistence in enforcing its suzerain rights in Tibet—but did not, apparently, cause any ill-feeling towards Great Britain among the Chinese people—who viewed with seeming equanimity the flight of the head of the Buddhist religion from the headquarters of that faith. The country generally was peaceful, a rebellion in Kwang-si—where a terrible famine occurred in 1903—being suppressed in 1904 by the forces of the viceroy at Canton.

The expiatory measures required of China in connexion with the Boxer rising were carried through. China during 1902 recovered possession of the Peking-Tientsin railway and of the city of Tientsin, which was evacuated by the foreign troops in August of that year. The foreign troops were also all withdrawn from Shanghai by January 1903. The conclusion of a new commercial treaty between Great Britain and China in September 1902 has already been recorded. The payment of the indemnity instalments occasioned some dispute owing to the fall in silver in 1902, but the rise in the value of the tael in subsequent years led China to agree to the payment of the indemnity on a gold basis. The increase in revenue was a notable feature of the maritime customs in 1903-1905. This result was in part due to the new arrangements under the commercial treaty of 1902, and in part to the opening up of the country by railways. In especial the great trunk line from Peking to Hankow was pushed on. The line, including a bridge nearly 2 m. long over the Yellow river was completed and opened for traffic in 1905. The first section of the Shanghai-Nanking railway was opened in the same year. At this time the Chinese showed a strong desire to obtain the control of the various lines. During 1905, for instance, the Canton-Hankow railway concession was repurchased by the Chinese government from an American company, while the Peking Syndicate, a British concern, also sold their railway in Ho-nan to the Chinese government.

Russia's action regarding Manchuria overshadowed, however, all other concerns during this period. The withdrawal of the proposed Russo-Chinese agreement of 1901 has been chronicled. The Russian government had, however, no intention of abandoning its hold on Manchuria. It aimed not only at effective military control but the reservation to Russian subjects of mining, railway and commercial rights. Both the sovereignty of China and the commercial interests of other nations were menaced. This led to action by various powers. The preamble of the Anglo-Japanese treaty of the 30th of January 1902 declared the main

² Lord W. Cecil, *op. cit.* p. 9.

Commercial and railway progress.



Fig. 1.—Ku K'ai-Chih. Toilet Scene.
(British Museum. 4th Cent. A.D.)

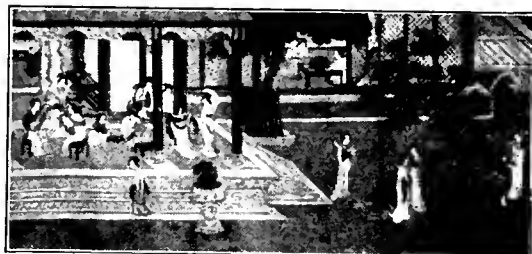

Fig. 6.—Kiu Ying. Court Ladies.
(British Museum. 15th Cent.)



Fig. 3.—Chao Mêng-Fu, after Wang Wei (8th Cent.).
Scene on the Wang Ch'uan.
(Dated 1309. British Museum.)

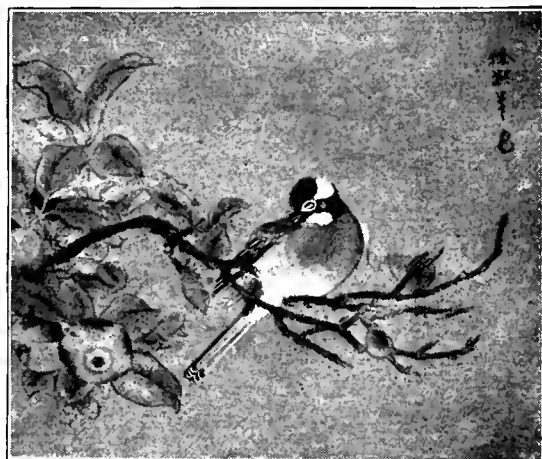

Fig. 4.—Hsü Hsi. Bird on Apple-Bough.
(10th Cent.)



Fig. 2.—Attributed to Wu Taotzü.
Sakyamuni. (8th Cent.)



Fig. 5.—Chien Shun-Chu. The Emperor Huan-Yeh.
(15th Cent.)



Fig. 7.—Eagle. By Lin Liang.
(15th Cent. British Museum.)

Figs. 2, 4, and 5 are reproduced by permission of the Kokka Company, Tokyo.



Fig. 9.—Temple Vase
(c. 1200 B.C.).



Fig. 10.—Wine Vase
(c. 1000 B.C.).



Fig. 11.—Wine Vase
(c. 600 B.C.).



Fig. 12.—Inlaid Vessel
(c. 500 B.C.).



Fig. 13.—Wine Vessel
(c. 100 B.C.).



Fig. 14.—Inlaid Vase
(c. 200 A.D.).
In possession of C. J. Holmes.



Fig. 15.—Vase (c. 1450 A.D.).



Fig. 16.—Wine Vessel
(c. 1450 A.D.).



Fig. 17.—Temple Vase
(c. 1700 A.D.).

Figs. 9-13 and 15-17 are from originals in the Victoria and Albert Museum, South Kensington.

motives of the contracting parties to be the maintenance of the independence and territorial integrity of China and Korea, and the securing of equal opportunities in those countries for the commerce and industry of all nations, *i.e.* the policy of the "open door." Protests were lodged by Great Britain, Japan and the United States against the grant of exclusive rights to Russian subjects in Manchuria. Russia asserted her intention to respect the commercial rights of other nations, and on the 8th of April 1902 an agreement was signed at Peking which appeared to show the good faith of the Russian government, as it provided for the withdrawal of the Russian troops in Manchuria within eighteen months from that date. In accordance with this agreement the Shan-hai-kwan-Niu-chwang railway was transferred to China in October 1902 and the district between Shan-hai-kwan and the Liao river evacuated by Russia. But it soon appeared that Russia's hold on the country had not relaxed. Advantage was taken of the terms of concession granted in August 1896 to the Russo-Chinese Bank¹ to erect towns for Russian colonists and to plant garrisons along the line of railway, and to exclude Chinese jurisdiction altogether from the railway zone. The so-called evacuation became in fact the concentration of the Russian forces along the line of railway. Moreover, the maritime customs at Niu-chwang were retained by the Russo-Chinese Bank despite protests from the Chinese imperial authorities, and a Russian civil administration was established at that port. The evacuation of southern Manchuria should have taken place in April 1903, but in that month, instead of fulfilling the conditions of the 1902 agreement, the Russian chargé d'affaires in Peking made a series of further demands upon China, including the virtual reservation of the commerce of Manchuria for Russian subjects. Though Russia officially denied to the British and American governments that she had made these demands, it was demonstrated that they had been made. The United States and Japan thereupon insisted that China should conclude with them commercial treaties throwing open Mukden and two ports on the Yalu river to foreign trade. The American treaty was signed on the 8th of October 1903—the day fixed for the complete evacuation of Manchuria by Russia—and the Japanese treaty on the day following. Both treaties provided that the ports should be opened after ratifications had been exchanged. From fear of Russia China, however, delayed the ratification of the treaties. Meantime, in August 1903, a regular through railway service between Moscow and Port Arthur was established. In the same month a Russian Viceroyalty of the Far East was created which in effect claimed Manchuria as a Russian province. In September Russia withdrew some of the demands she had made in April, but her concessions proved illusory. When the 8th of October passed and it was seen that the Russians had not withdrawn their troops² there issued for a time threats of war from Peking. Yuan Shih-kai, the viceroy of Chih-li, who had at his command some 65,000 troops trained by Japanese officers, pressed on the government the necessity of action. At this point Japan intervened. Her interests were vitally affected by Russia's action not only in Manchuria, but in Korea, and seeing that China was powerless the Japanese government negotiated directly with St Petersburg. In these negotiations Russia showed that she would not yield her position in either country except to force. Japan chose the issue of war and proved successful.

The Russo-Japanese War did not very greatly alter China's position in Manchuria. In the southern part of that country Japan succeeded to the special privileges Russia had wrung

¹ This institution was nominally a private concern which financed the Manchurian railway, but it acted as part of the Russian government machinery. The existence of the contract of the 27th of August 1896 was frequently denied until expressly admitted by the Russo-Chinese agreement of the 8th of April 1902.

² On the 8th of October the Russian troops had been withdrawn from Mukden, but they reoccupied the town on the 28th of the same month, Admiral Alexeiev, the viceroy of the Far East, alleging that the inertia of the Chinese officials seriously hindered the work of extending civilization in Manchuria.

from China (including the lease of Port Arthur); in the north Russia remained in possession of the railway zone. For Japan's position as at once the legatee of special privileges and the champion of China's territorial integrity and "the open door" see JAPAN, § History. However, the attitude of Japan was more conciliatory than that of Russia had been; Mukden and other places were thrown open to foreign trade and Chinese civil administration was re-established. The important results of the war, so far as China was concerned, were not to be looked for in Manchuria, but in the new spirit generated in the Chinese. They had been deeply humiliated by the fact that in the struggle between Russia and Japan China had been treated as a negligible quantity, and that the war had been fought on Chinese territory. The lesson which the looting of Peking and the fall of the Boxers in 1900 had half taught was now thoroughly mastered; the awakening of China was complete. The war had shown that when an Eastern race adopted Western methods it was capable of defeating a European nation.

It was fortunate that among the influential advisers of the throne at this time (1905-1908) were Prince Chun (the prince who had visited Germany in 1901), Yuan Shih-kai, the viceroy of Chih-li, and Chang Chih-tung, the viceroy of Hu-kwang (*i.e.* the provinces of Hu-peh and Hu-nan), all men of enlightened and strong character. In 1907 both the viceroys named were summoned to Peking and made members of the grand council, of which Prince Ching, a man of moderate views, was president. Yuan Shih-kai was an open advocate of a reform of the civil service, of the abolition of Manchu privileges, of education and other matters. He had specially advocated the reconstitution of the military forces of the empire, and in Chih-li in 1905 he demonstrated before a number of foreign military attachés the high efficiency attained by the forces of the metropolitan province. The success achieved by Yuan Shih-kai in this direction incited Chang Chih-tung to follow his example, while a decree from the throne called upon the princes and nobles of China to give their sons a military education. The formerly despised military profession was thus made honourable, and with salutary effects. The imperial princes sought high commands, officers were awarded ranks and dignities comparable with those of civil servants, and the pay of the troops was increased. The new foreign drilled northern army was called upon to furnish a large proportion of a force sent under Prince Su into Mongolia—a country which had been on the point of falling into the hands of Russia, but over which, as one result of the Russo-Japanese War, China recovered control. In 1906 a step was taken towards the formation of a national army by withdrawing portions of the troops from provincial control and placing them under officers responsible to the central government, which also took over the charge of the provincial arsenals. In the years which followed further evidence was given of the earnestness and success with which the military forces were being reorganized. Less attention was given to naval affairs, but in the autumn of 1909 a naval commission under Tsai Hsün, a brother of the emperor Kwang-su, was sent to Europe to report on the steps necessary for the re-establishment of a fleet. Previously (in 1907) societies had been started in several provinces to collect funds for naval purposes.

The most striking evidence of the change which had occurred was, however, the appointment (in 1905) of an Imperial Commission, headed by Prince Tsai Tse, to study the administrative systems of foreign countries with a view to the possible establishment of a representative government in China. The revolutionary nature of this proposal excited indignation among the adherents to the old order, and a bomb was thrown among the commissioners as they were preparing to leave Peking.³ After visiting Japan, America and Europe the commission returned to

³ The form of outrage, probably the first of its kind in China, was itself a symptom of the changed times. The bomb injured Prince Tsai Tse and another commissioner, and the departure of the commission was consequently delayed some months.

Man-
churia.Lessons
of the
Russo-
Japanese
War.Army
reform.

Peking in July 1906.¹ A committee over which Prince Ching presided was appointed to study the commission's report, and on the 1st of September following an edict was issued in which the establishment of a parliamentary form of government was announced, at a date not fixed. To fit the country for this new form of government (the edict went on to declare) the administration must be reformed, the laws revised, education promoted and the finances regulated. This edict, moreover, was but one of many edicts issued in 1906 and following years which showed how great a break with the past was contemplated. In November 1906 two edicts were issued with the object of reorganizing the central administrative offices. Their effect was to simplify the conduct of business, many useless posts being abolished, while an audit board was created to examine the national accounts. In November 1907 another edict was promulgated stating that for the present the formation of Houses of Lords and of Commons to determine all public questions was not practicable, but that it was proposed, as a preliminary measure, to create an Imperial Assembly. At the same time a scheme of provincial councils was ordered to be prepared. A more definite step followed in 1908 when a decree (dated the 27th of August) announced the convocation of a parliament in the ninth year from that date.

One of the changes made in the public offices brought China into conflict with Great Britain. On the 9th of May 1906 a decree appointed Chinese commissioners to control the Imperial Maritime Customs.² This was the only department of the government under European (British) control, and the only department also against which no charge of inefficiency or corruption could be brought. The change decreed by China was in accord with the new national sentiment, but by all the foreign powers interested it was felt that it would be a retrograde step if the customs were taken out of the control of Sir Robert Hart (*q.v.*), who had been since 1863 inspector-general of the customs. The British secretary of state for foreign affairs (Sir Edward Grey) at once protested against the decree of the 6th of May, pointing out that the continuation of the established system had been stipulated for in the loan agreements of 1896 and 1898. As a result of this and other representations the Board of Control of the Customs was late in 1906 made a department of the Board of Finance. The Chinese controllers-general continued in office, and despite the assurances given to Great Britain by China (in a note of the 6th of June 1906) that the appointment of the controllers-general was not intended to interfere with the established system of administration, the absolute authority of Sir Robert Hart was weakened.³ Sir Robert Hart returned to England in 1908 "on leave of absence," Sir Robert Bredon, the deputy inspector-general, being placed in charge of the service under the authority of the Board of Control, of which on the 5th of April 1910 it was announced that he had been appointed a member. This step was viewed with disfavour by the British government, for, unless Sir Robert Bredon's post was to be merely a sinecure, it imposed two masters on the maritime customs. On the 20th of April Sir Robert Bredon severed his connexion with the Board of Control. At the same time Mr F. A. Aglen (the Commissioner of Customs at Hankow) became acting Inspector General (Sir Robert Hart being still nominally head of the service). The attempt on the part of the Chinese to control the customs was evidence

¹ In 1907 further commissions were appointed, on the initiative of Yuan Shih-kai, to study specifically the constitutions of Great Britain, Germany and Japan.

² This department was organized at Shanghai in 1854. The Taiping rebels being in possession of the native city, the collection of customs dues, especially on foreign ships, was placed in the hands of foreigners. This developed into a permanent institution, the European staff being mainly British.

³ The British official view, as stated in parliament on the 27th of April 1910, was that the changes resulting from the creation of the Board of Control had, so far, been purely departmental changes of form, and that the position of the inspector-general remained unaltered.

of the strength of the "young China" or Recovery of Rights party—the party which aspired to break all the chains, such as extra-territoriality, which stamped the country as not the equal of the other great nations.⁴

In the steps taken to suppress opium smoking evidence was forthcoming of the earnestness with which the governing body in China sought to better the condition of the people.

Opium smoking followed, in China, the introduction of tobacco smoking, and is stated to have been introduced from Java and Formosa in the early part of the 17th century. The first edict against the habit was issued in 1729. At that time the only foreign opium introduced was by the Portuguese from Goa, who exported about 200 chests⁵ a year. In 1773 English merchants in India entered into the trade, which in 1781 was taken over by the East India Company—the import in 1790 being over 4000 chests. In 1796 the importation of foreign opium was declared contraband, and between 1839 and 1860 the central government attempted, without success, to suppress the trade. It was legalized in 1858 after the second "opium war" with Great Britain. At that time the poppy was extensively grown in China, and the bulk of the opium smoked was, and continued to be, of home manufacture. But after 1860 the importation of opium from India greatly increased. Opium was also imported from Persia (chiefly to Formosa, which in 1895 passed into the possession of Japan). The total foreign import in 1863 was some 70,000 piculs,⁶ in 1879 it was 102,000 piculs, but in 1905 had fallen to 56,000 piculs. The number of opium smokers in China in the early years of the 20th century was estimated at from 25 to 30 millions. The evil effects of opium smoking were fully recognized, and Chang Chih-tung, one of the most powerful of the opponents of the habit, was high in the councils of the dowager-empress. On the 20th of September 1906 an edict was issued directing that the growth, sale and consumption of opium should cease in China within ten years, and ordering the officials to take measures to execute the imperial will. The measures promulgated, in November following, made the following provisions:—

(1) The cultivation of the poppy to be restricted annually by one-tenth of its existing area; (2) all persons using opium to be registered; (3) all shops selling opium to be gradually closed, and all places where opium is smoked to discontinue the practice within six months; (4) anti-opium societies to be officially encouraged, and medicines distributed to cure the opium-smoking habit; (5) all officials were requested to set an example to the people, and all officials under sixty were required to abandon opium smoking within six months or to withdraw from the service of the state.

It was estimated that the suppression of opium smoking would entail a yearly loss of revenue of over £1,600,000, a loss about equally divided between the central and provincial governments. The first step taken to enforce the edict was the closing of the opium dens in Peking on the last day of 1906.

During 1907 the opium dens in Shanghai, Canton, Fu-chow and many other large cities were closed, and restrictions on the issue of licences were introduced in the foreign settlements; even the eunuchs of the palace were prohibited from smoking opium under severe penalties. The central government continued during 1908 and 1909 to display considerable energy in the suppression of the use of opium, but the provincial authorities were not all equally energetic. It was noted in 1908 that while in some provinces—even in Yun-nan, where its importance to trade and commerce and its use as currency seemed to render it very difficult to do anything effective—the governor and officials were whole-hearted in carrying out the imperial regulations, in other provinces—notably in Kwei-chow and in the provinces of the lower Yangtze valley—great supineness was exhibited in dealing with the subject. Lord William Cecil, however, stated that travelling in 1909 between Peking and Hankow, through country which in 1907 he had seen covered with the poppy, he could not then see a single poppy flower, and that going up the Yangtze he found only one small patch of poppy cultivation.⁷ The Peking correspondent of *The Times*, in a journey to Turkestan in the early part of 1910, found that in Shen-si province the people's desire to suppress the opium trade was in advance of the views of the government. Every day trains of opium carts were passed travelling under official protection. But in the adjoining province of Shan-si there had been complete

⁴ See *The Times* of the 21st of April and 11th of May 1910.

⁵ A chest contained from 135 lb to 160 lb.

⁶ A picul = 133½ lb.

⁷ *Changing China*, p. 118.

suppression of poppy cultivation and in Kan-suh the officials were conducting a very vigorous campaign against the growth of the poppy.¹

In their endeavours to suppress opium smoking the Chinese government appealed to the Indian government for help, and in 1907 received a promise that India would decrease the production of opium annually by one-tenth for four years and subsequently if China did likewise. The Indian government also assented to Indian opium being taxed equally with Chinese opium, but China did not raise the duty on foreign opium. In 1908 the Indian government undertook to reduce the amount of opium exported by 5100 chests yearly. In the same year the opium dens in Hong-Kong were closed. In February 1909, on the initiative of the United States, an international conference was held at Shanghai to consider the opium trade and habit. At this conference the Chinese representative claimed that the consumption of opium had already been reduced by one-half—a claim not borne out by the ascertained facts. The conference was unable to suggest any heroic measures, but a number of proposals were agreed to (including the closing of opium dens in the foreign settlements), tending to the restriction of the opium trade. The conference also dealt with another and growing habit in China—the use of morphia.² Japan agreed to prohibit the export of morphia to China, a prohibition to which the other powers had previously agreed.

The attempts to reform the educational system of China on a comprehensive scale date from the year of the return of the court to Peking after the Boxer troubles. In 1902 regulations were sanctioned by the emperor which aimed at remodelling the methods of public instruction.

These regulations provided among other things for the establishment at Peking of a university giving instruction in Western learning, a technical college, and a special department for training officials and teachers. A much more revolutionary step was taken in September 1905 when a decree appeared announcing as from the beginning of 1906 the abolition of the existing method of examinations. The new system was to include the study of modern sciences, history, geography and foreign languages, and in the higher grades political economy and civil and international law. Thousands of temples were converted to educational purposes. In Canton, in 1907, the old examination hall was demolished to make way for a college with every appliance on Western lines. Equal zeal was noticeable in such conservative cities as Si-gan-fu, and in remote provinces like Kan-suh. By May 1906 fifteen so-called universities had been founded. Moreover, many young Chinese went abroad to acquire education—in Japan alone in 1906 there were 13,000 students. In the same year primary schools for girls were established.³ Perhaps the most striking evidence of the new spirit regarding education was the tenour of a communication to the throne from the head of the Confucian family. On the 31st of December 1906 an imperial edict had appeared raising Confucius to the same rank as Heaven and Earth—an action taken to indicate the desire of the government to emphasize the value of ethical training. In thanking the throne for the honour conferred on his ancestor the head of the family urged that at the new college founded at the birth-place of Confucius the teaching should include foreign languages, physical culture, political science and military drill.⁴

While China, with the consent of the emperor and the empress-dowager, and under the guidance of Prince Ching, Yuan Shih-kai and Chang Chih-tung, was endeavouring to bring about internal reforms, her attitude to foreign powers was one of reserve and distrust. This was especially marked in the negotiations with Japan and with Russia concerning Manchuria, and was seen also in the negotiations with Great Britain concerning

Tibet. It was not until April 1908, after four years' negotiations, that a convention with Great Britain respecting Tibet was signed, Chinese suzerain rights being respected. In September the Dalai Lama arrived in Peking from Mongolia and was received by the emperor, who also gave audience to a Nepalese mission.⁵

The emperor Kwang-su had witnessed, without being able to guide, the new reform movement. In August 1908 an edict was issued in his name announcing the convocation of a parliament in nine years' time. In November he died. His death occasioned no surprise, as disquieting reports about his health had been current since July, but the announcement that the dowager empress died on the 15th of November (the day after that on which the emperor was officially stated to have died) was totally unexpected. She had celebrated her birthday on the 3rd of November and appeared then to be in good health. The empress dowager had taken part in the choice of a successor to the throne, Kwang-su's valedictory edict had been drawn up under her supervision, and it is believed that the emperor died some days previous to the date officially given for his death. Kwang-su died childless and was succeeded by his infant nephew Pu-Yi (born on the 8th of February 1906), a son of Prince Chun, who was appointed regent. Prince Chun—himself then only twenty-six years old—had exercised considerable influence at court since his mission to Germany in 1901, and was one of the most enlightened of the Manchu princes. The death of the dowager empress removed a powerful obstacle to a reformed regime, and with her passed away the last prominent representative of the old era in China.

The accession to the throne of Pu-Yi, who was given as reigning title Hsuan Tung ("promulgating universally"), was unaccompanied by disturbances, save for an outbreak at Ngan-king, easily suppressed. Prince Chun had the support of Yuan Shih-kai and Chang Chih-tung,⁶ the two most prominent Chinese members of the government at Peking—and thus a division between the Manchus and Chinese was avoided. On the 2nd of December 1908 the young emperor was enthroned with the usual rites. On the day following another edict, which, it was stated, had had the approval of the late dowager empress, was issued, reaffirming that of the 27th of August regarding the grant of a parliamentary constitution in nine years' time, and urging the people to prepare themselves for the change. Other edicts sought to strengthen the position of the regent as *de facto* emperor. Yuan Shih-kai and Chang Chih-tung received the title of Grand Guardians of the Heir, and the year 1908 closed with the chief Chinese members of the government working, apparently, in complete harmony with the regent.

On the 1st of January 1909, however, the political situation was rudely disturbed by the dismissal from office of Yuan Shih-kai. This step led to representations by the British and American ministers to Prince Ching, the head of the foreign office, by whom assurances were given that no change of policy was contemplated by China, while the regent in a letter to President Taft reiterated the determination of his government to carry through its reform policy. The dismissal of Yuan Shih-kai was believed by the Chinese to be due to his "betrayal" of the emperor Kwang-su in the 1898 reform movement. He had nevertheless refused to go to extremes on the reactionary side, and in 1900, as governor of Shan-tung, he preserved a neutrality which greatly facilitated the relief of the Peking legations. During the last years

⁵ The Dalai Lama left Peking in December 1908 on his return to Lhasa, which he reached in November 1909. Differences had arisen between him and the Chinese government, which sought to make the spiritual as well as the temporal power of the Dalai Lama dependent on his recognition by the emperor of China. Early in 1910 the Dalai Lama, in consequence of the action of the Chinese amban in Lhasa, fled from that city and sought refuge in India.

⁶ Chang Chih-tung died in October 1909. He was a man of considerable ability, and one whose honesty and loyalty had never been doubted. He was noted as an opponent of opium smoking, and for over thirty years had addressed memorials to the throne against the use of the drug.

Educa-
tion.

Death
of the
emperor
and of the
dowager
empress.

Accession
of Hsuan
Tung.

Dismissal
of Yuan
Shih-kai.

¹ See *The Times* of 7th and 8th of March and 8th of April 1910.

² The first recorded importation of morphia into China was in 1892, and it is suggested that it was first used as an anti-opium medicine. Morphia-taking, however, speedily became a vice, and in 1902 over 195,000 oz. of morphia were imported (enough for some 300,000,000 injections). To check the evil the Chinese government during 1903 imposed a tax of about 200% *ad valorem*, with the result that the imports declared to the customs fell in 1905 to 54 oz. only. The falling off was explained "not by a diminished demand, but by smuggling" (*Morse's Trade and Administration of the Chinese Empire*, p. 351).

³ A regulation by the ministry of education, dated the 14th of January 1910, ordered that no girl should be admitted to school dressed in foreign clothes or with unnatural (*i.e.* bound) feet.

⁴ For the growth of the education movement see *The Times*, 4th of September 1909.

of the life of the dowager empress it was his influence which largely reconciled her to the new reform movement. Yet Kwang-su had not forgotten the *coup d'état* of 1898, and it is alleged that he left a testament calling upon his brother the prince regent to avenge the wrongs he had suffered.¹ During the

Agreement with Japan.

greater part of the year there was serious estrangement between China and Japan, but on the 4th of September a convention was signed which settled most of the points in dispute respecting Manchuria and Korea. In Korea the boundary was adjusted so that Chientao, a mountainous district in eastern Manchuria regarded as the ancestral home of the reigning families of China and Korea, was definitely assigned to China; while in Manchuria, both as to railways and mines, a policy of co-operation was substituted for one of opposition.² Although Japan had made substantial concessions, those made by China in return provoked loud complaints from the southern provinces—the self-government society calling for the dismissal of Prince Ching. In northern Manchuria the Russian authorities had assumed territorial jurisdiction at Harbin, but on the 4th of May an agreement was signed recognizing Chinese jurisdiction.³

The spirit typified by the cry of "China for the Chinese" was seen actively at work in the determined efforts made to exclude

The control of railways.

foreign capital from railway affairs. The completion in October 1909 of the Peking-Kalgan railway was the cause of much patriotic rejoicing. The railway, a purely Chinese undertaking, is 122 m. long and took four years to build. It traversed difficult country, piercing the Nan K'ow Pass by four tunnels, one under the Great Wall being 3580 ft. long. There was much controversy between foreign financiers, generally backed by their respective governments, as to the construction of other lines. In March 1909 the Deutsch-asiatische Bank secured a loan of £3,000,000 for the construction of the Canton-Hankow railway. This concession was contrary to an undertaking given in 1905 to British firms and was withdrawn, but only in return for the admittance of German capital in the Sze-ch'uen railway. After prolonged negotiations an agreement was signed in Paris on the 24th of May 1910 for a loan of £6,000,000 for the construction of the railway from Hankow to Sze-ch'uen, in which British, French, German and American interests were equally represented. In January 1910 the French line from Hanoi to Yunnan-fu was opened;⁴ the railway from Shanghai to Nanking was opened for through traffic in 1909.

The progress of the anti-opium movement and the dispute over the control of the Imperial Maritime Customs have already

Provincial Assemblies constituted.

A Senate formed.

been chronicled. A notable step was taken in 1909 by the institution of elected assemblies in each of the provinces. The franchise on which the members were elected was very limited, and the assemblies were given consultative powers only. They were opened on the 14th of October (the 1st day of the 9th moon). The businesslike manner in which these assemblies conducted their work was a matter of general comment among foreign observers in China.⁵ In February 1910 decrees appeared approving schemes drawn up by the Commission for Constitutional Reforms, providing for local government in prefectures and departments and for the reform of the judiciary. This was followed on the 9th of May by another decree summoning the senate to meet for the first time on the 1st day of the 9th moon (the 3rd of October 1910). All the members of the senate were nominated, and the majority were Manchus. Neither to the provincial assemblies nor to the senate was any power of the purse given, and the drawing up of a budget was postponed until 1915.⁶

¹ See *The Times* of the 7th of September 1909.

² Proposals made early in 1910 by the American secretary of state for the neutralization of the Manchurian railway received no support.

³ By a convention signed on July 4th, 1910, Russia and Japan agreed to "maintain and respect" the *status quo* in Manchuria.

⁴ See the *Quinzaine coloniale* of the 10th of December 1909.

⁵ See *The Times* of the 20th of January 1910.

⁶ See for the prospects of reform *The Times* of 30th May 1910.

The efforts of the central government to increase the efficiency of the army and to re-create a navy were continued in 1910. China was credited with the intention of spending £40,000,000 on the rehabilitation of its naval and military forces. It was estimated in March 1910 that there were about 200,000 foreign-trained men, but their independent spirit and disaffection constituted a danger to internal peace. The danger was accentuated by the mutual jealousy of the central and provincial governments. The anti-dynastic agitation, moreover, again seemed to be growing in strength. In April 1910 there was serious rioting at Changsha, Hu-nan, a town whence a few years previously had issued a quantity of anti-foreign literature of a vile kind. The immediate causes of the riots seem to have been many: rumours of the intention of the foreign powers to dismember China, the establishment of foreign firms at Changsha competing with native firms and exporting rice and salt at a time when the province was suffering from famine, and the approach of Halley's comet. Probably the famine precipitated the outbreak, which was easily crushed, as was also a rising in May at Yung chow, a town in the south of Hu-nan. Much mission and mercantile property was wrecked at Changsha, but the only loss of life was the accidental drowning of three Roman Catholic priests.

Anti-dynastic movements. Riots in Hu-nan.

An edict of the 17th of August 1910 effected considerable and unexpected changes in the personnel of the central government. Tang Shao-yi, a former lieutenant of Yuan Shih-kai, was appointed president of the Board of Communications, and to him fell the difficult task of reconciling Chinese and foreign interests in the development of the railway system. Sheng Kung-pao regarded as the chief Chinese authority on currency questions, and an advocate of the adoption of a gold standard, was attached to the Board of Finance to help in the reforms decreed

The regent's policy.

by an edict of May of the same year (see *ante*, *Currency*). The issue of the edict was attributed to the influence with the regent of Prince Tsai-tao, who had recently returned from a tour in Europe, where he had specially studied questions of national defence. The changes made among the high officials tended greatly to strengthen the central administration. The government had viewed with some disquiet the Russo-Japanese agreement of the 4th of July concerning Manchuria (which was generally interpreted as in fact lessening the authority of China in that country); it had become involved in another dispute with Great Britain, which regarded some of the measures taken to suppress opium smoking as a violation of the terms of the Chifu convention, and its action in Tibet had caused alarm in India. Thus the appointment to high office of men of enlightenment, pledged to a reform policy, was calculated to restore confidence in the policy of the Peking authorities. This confidence would have been greater had not the changes indicated a struggle for supreme power between the regent and the dowager empress Lung Yu, widow of Kwang-su.

The strength of the various movements at work throughout China was at this time extremely difficult to gauge; the intensity of the desire for the acquisition of Western knowledge was equalled by the desire to secure the independence of the country from foreign control. The second of these desires gave the force it possessed to the anti-dynastic movement. At the same time some of the firmest supporters of reform were found among the Manchus, nor did there seem to be any reason to doubt the intention of the regent—if he retained power—to guide the nation through the troubled period of transition into an era of constitutional government and the full development of the resources of the empire. (X.)

BIBLIOGRAPHICAL NOTE.—Knowledge of the ancient history of China is necessarily derived from the native writers on the subject. Fortunately, the Chinese have always regarded the preservation of the national records as a matter of supreme importance. Confucius set an example in this respect, and has preserved for us in the *Spring and Autumn Annals* and the *Shu-king*, or *Book of History*, records of his country's progress during the past and then present centuries. The celebrated emperor Shih Hwang-ti, in establishing the empire, attempted to strengthen his cause by destroying all works on the national history. But so strongly was the historical sense inculcated in the people that immediately on the death of the

tyrant the nation's records were again brought to light, and have been carefully preserved and edited since that time. Prof. Legge's translation of the *Spring and Autumn Annals* and the *Shu-king, or Book of History*, in the "Sacred Books of the East" series, have opened for students the stores of historical knowledge which were at the command of Confucius, and European writers on Chinese history have found in the dynastic annals a never-failing source of valuable information. It was from these works and epitomes of these that de Maillac gathered the facts for his celebrated *Histoire générale de la Chine*, and it is from similar sources that all other writers on Chinese history have drawn their inspiration.

The following works on ancient and modern Chinese history may be specially mentioned: J. A. de Moyria de Maillac, *Histoire générale de la Chine* (1777), &c.; J. B. du Halde, *General History of China* (4 vols., 1736); M. de Guignes, *Voyages à Péking . . .* (3 vols., 1808); D. Boulger, *A History of China* (3 vols., 1881); Valentine Chirol, *The Far Eastern Question* (1896); E. R. Huc, *The Chinese Empire* (2 vols., 1855); T. T. Meadows, *The Chinese and their Rebellions* (1856); G. Pauthier, *Histoire des relations politiques de la Chine avec les puissances occidentales depuis les temps les plus anciens jusqu'à nos jours . . .* (1859); Sir George Staunton, *Notes of Proceedings and Occurrences during the British Embassy to Peking in 1816* (1824); *Chinese Expansion historically reviewed*, a paper read before the Central Asian Society by Baron Suyematsu on January 11, 1905; F. Hirth, *Ancient History of China* (New York, 1908); Prof. Herbert A. Giles's *Chinese Biographical Dictionary* (1897) is a storehouse of biographical detail and anecdote.

For Chinese relations with foreign powers see H. Cordier, *Histoire des relations de la Chine avec les puissances occidentales, 1860-1902* (3 vols., Paris, 1901-1902); *Hertslet's China Treaties. Treaties, &c., between Great Britain and China, and between China and Foreign Powers, and Orders in Council, &c., affecting British Interests in China* (3rd ed., revised by G. G. P. Hertslet and E. Parkes, London, 1908); J. O. Bland and E. Backhouse, *China under the Empress Dowager* (London, 1910). More general works are Sir R. K. Douglas, *China, history since the time of Marco Polo* (London, 1899); E. H. Parker, *China; Her History, Diplomacy and Commerce* (London, 1901); *China, Past and Present* (London, 1903); A. J. Sargent, *Anglo-Chinese Commerce and Diplomacy*—mainly in the 19th century (Oxford, 1907). For current affairs see the authorities cited in the footnotes.

VI. CHINESE ART

1. *Painting*.—Painting is the pre-eminent art of China, which can boast of a succession of great painters for at least twelve centuries. Though the Chinese have an instinctive gift for harmonious colour, their painting is above all an art of *line*. It is intimately connected with writing, itself a fine art demanding the same skill and supple power in the wielding of the brush. The most typical expression of the Chinese genius in painting is the ink sketch, such as the masters of the Sung dynasty most preferred and the Japanese from the 15th century adopted for an abiding model. Utmost vigour of stroke was here combined with utmost delicacy of modulation. Rich colour and the use of gold are an integral part of the Buddhist pictures, though in the masterpieces of the religious painters a grand rhythm of linear design gives the fundamental character. Exquisite subdued colour is also found in the "flower and bird pieces" and still-life subjects of the Sung artists, and becomes more emphatic and variegated in the decorative artists of the Ming period.

Not to represent facts, but to suggest a poetic idea (often perfumed, so to speak, with reminiscence of some actual poem), has ever been the Chinese artist's aim. "A picture is a voiceless poem." is an old saying in China, where very frequently the artist was a literary man by profession. Oriental critics lay more stress on loftiness of sentiment and tone than on technical qualities. This idealist temper helps to explain the deliberate avoidance of all emphasis on appearances of material solidity by means of chiaroscuro, &c., and the exclusive use of the light medium of water-colour. The Chinese express actual dislike for the representation of relief. Whoever compares the painting of Europe with that of Asia (and Chinese painting is the central type for the one continent, as Italian may claim to be for the other) must first understand this contrast of aim. The limitations of the Chinese are great, but these limitations save them from mistaking advances in science for advances in art, and from petty imitation of fact. Their religious painting has great affinity with the early religious art of Italy (e.g. that of Siena). But the ideas of the Renaissance, its scientific curiosity, its materialism, its glorification of human personality, are wholly missing in China. For Europe, Man is ever the hero and the

foreground—hence the dominant study of the nude, and the tendency to thronged compositions, with dramatic motives of effort and conflict. The Chinese artists, weak in the plastic, weak in the architectural sense, paint mostly in a lyric mood, with a contemplative ideal. Hence the value given to space in their designs, the semi-religious passion for nature, and the supremacy of landscape. Beauty is found not only in pleasant prospects, but in wild solitudes, rain, snow and storm. The life of things is contemplated and portrayed for its own sake, not for its uses in the life of men. From this point of view the body of Chinese painting is much more modern in conception than that of Western art. Landscape was a mature and free art in China more than a thousand years ago, and her school of landscape is the loftiest yet known to the world. Nor was man ever dissociated from nature. As early as the 4th century Ku K'ai-chih says that in painting a certain noble character he must give him a fit background of great peaks and deep ravines. Chinese painting, in sum, finely complements rather than poorly supplements that of Europe; where the latter is strong, it is weak; but in certain chosen provinces it long ago found consummate expression for thoughts and feelings scarcely yet expressed with us.

The origin of Chinese painting is lost in legend, though there is no reason to doubt its great antiquity. References in literature prove that by the 3rd century B.C. it was a developed art. To this period is ascribed the invention of the hair-brush, in the use of which as an instrument both for writing and drawing the Chinese have attained marvellous skill; the usual material for the picture being woven silk, or, less often and since the 1st century A.D., paper. In early times wood panels were employed; and large compositions were painted on walls prepared with white lime. These mural decorations have all disappeared. History and portraiture seem to have been the prevailing subjects; a secular art corresponding to the social ideals of Confucianism. Yet long before the introduction of Buddhism (A.D. 67) with its images and pictures, we find that the two great symbolic figures of the Chinese imagination, the Tiger and the Dragon—typifying the forces of Nature and the power of the Spirit—had been evolved in art; and to imaginative minds the mystic ideas of Lao Tzü and the legends of his hermit followers proved a fruitful field for artistic motives of a kind which Buddhism was still more to enrich and multiply. Early classifications rank Buddhist and Taoist subjects together as one class.

With the 2nd century A.D. we come to individual names of artists and to the beginnings of landscape. Ku K'ai-chih (4th century) ranks as one of the greatest names of Chinese art. A painting by him now in the British Museum (Plate I. fig. 1) shows a maturity which has nothing tentative about it. The dignified and elegant types are rendered with a mastery of sensitive brush-line which is not surpassed in later art. Ku K'ai-chih painted all kinds of subjects, but excelled in portraiture. During the next century the criticism of painting was formulated in six canons by Hsieh Ho. Rhythm, organic or structural beauty, is the supreme quality insisted on.

During the T'ang dynasty the empire expanded to its utmost limits, stretching as far as the Persian Gulf. India was invaded; Buddhism, taught by numbers of Indian missionaries, became firmly established, and controlled the ideals and imaginations of the time. The vigorous style of a great era was impressed upon the T'ang art, which culminated in Wu Taotzü, universally acknowledged as the greatest of all Chinese painters. It is doubtful if any of his work remains. The picture reproduced (Plate I. fig. 2) was long attributed to him, but is now thought to be of later date, like the two landscapes well known under his name in Japan. Wu Taotzü seems to have given supreme expression to the central subject of Buddhist art, the Nirvana of Buddha, who lies serenely asleep, with all creation, from saints and kings to birds and beasts, passionately bewailing him. The composition is known from Japanese copies; and it is in fact from the early religious schools of Japan that we can best conjecture the grandeur of the T'ang style. Wu Taotzü excelled in all subjects: other

History:
Early
periods (to
A.D. 618).

T'ang
dynasty
(A.D. 618-
907).

masters are best known for some particular one. Han Kan was famous for his horses, the models for succeeding generations of painters, both Chinese and Japanese. A specimen of his brush is in the British Museum; and in the same collection is a long roll which gives a glimpse of the landscape of this age. It is a copy by a great master of the Yuen dynasty, Chao Mêng-fu, from a famous painting by Wang Wei, representing scenes on the Wang Ch'uan, the latter's home (Plate I. fig. 3 shows a fragment). With the T'ang age landscape matured, and two schools arose, one headed by Wang Wei, the other by Li Ssü-hsün. The style of Wang Wei, who was equally famous as a poet, had a romantic idealist character—disdainful of mere fact—which in later developments created the "literary man's picture" of the Southern school, as opposed to the vigorous naturalism of the North.

Next come five brief dynasties, memorable less for any corporate style or tradition, than for some fine painters like Hsü Hsi, famous for his flowers, and Huang Ch'uan, a great master in a delicate style. Two pictures by him, fowls and peonies, of extraordinary beauty, are in the British Museum.

The empire, which had been broken up, was reunited, though shorn of its outer dependencies, under the house of Sung. This was an age of culture in which the freedom of the individual was proclaimed anew; glorious in art as in poetry and philosophy; the period which for Asia stands in history as the Periclean age for Europe.

The religious paintings of Li Lung-mien, the grandest of Sung masters, if less forcible than those of T'ang, were unsurpassed in harmonious rhythm of design and colour. But the most characteristic painting of this period is in landscape and nature-subjects. With a passion unmatched in Europe till Wordsworth's day, the Sung artists portrayed their delight in mountains, mists, plunging torrents, the flight of the wild geese from the reed-beds, the moonlit reveries of sages in forest solitudes, the fisherman in his boat on lake or stream. To them also, steeped in the Zen philosophy of contemplation, a flowering branch was no mere subject for a decorative study, but a symbol of the infinite life of nature. A mere hint to the spectator's imagination is often all that they rely on; proof of the singular fullness and reality of the culture of the time. The art of suggestion has never been carried farther. Such traditional subjects as "Curfew from a Distant Temple" and "The Moon over Raging Waves" indicate the poetic atmosphere of this art. Ma Yuan, Hsia Kuei and the emperor Hwei-tsung are among the greatest landscape artists of this period. They belong to the South Sung school, which loved to paint the gorges and towering rock-pinnacles of the Yangtze. The sterner, less romantic scenery of the Hwang-Ho inspired the Northern school, of which Kuo Hsi and Li Ch'eng were famous among many others. Muh Ki was one of the greatest masters of the ink sketch; Chao Tan Lin was famed for his tigers; Li Ti for his flowers; Chao Tan Lin was famed for his tigers; Li Ti for his flowers; Mao I for still-life: to name a few among a host.

The Mongol dynasty continues in art the Sung tradition. Chao Mêng-fu, the greatest master of his time, belongs to both periods, and ranks with the highest names in Chinese painting. A landscape by him, copied from Wang Wei, has been already mentioned as in the British Museum, which also has two specimens of Yen Hui, a painter less known in his own country than in Japan. He painted especially figures of Taoist legend. The portrait by Ch'ien Shun-chü (Plate I. fig. 5) is a fine example of purity of line and lovely colour, reminding us of Greek art.

The simplicity of motive and directness of execution which had been the strength of the Sung art gradually gave way during the Ming era to complicated conceptions and elaborate effects. The high glow of life faded; the lyrical temper and impassioned work of the Sung time were replaced by love of ornament and elegance. In this respect Kiu Ying is typical of the period, with his richly coloured scenes from court life (Plate I. fig. 6). None the less, there were a number of painters who still upheld the grander style of earlier ages. The greatest of these was Lin Liang (Plate I. fig. 7), whose brush work, if somewhat coarser, is as powerful as that of the Sung masters. But though individual painters of the first rank preserved the Ming age from absolute decline, it cannot be said that any new development of importance took place in a vitalizing direction.

The present dynasty prolongs the history of Ming art. The literary school of the South became more prominent, sending out offshoots in Japan. There has been no movement of national life to be reflected in art, though a great body of admirable painting has been produced, to the present day. The four landscape masters known as the "four Wangs," Yün Shou-p'ing and Wu Li are pre-eminent names.

SOURCES AND AUTHORITIES.—While the designs on porcelain, screens, &c., have long been admired in the West, the paintings of which these are merely reproductions have been utterly ignored. Ignorance has gained authority with time, till the very existence of a great school of Chinese painting has been denied. Materials for study are scanty. Fires, wars and the recent armed ravages of Western civilization have left but little. The profound indifference of the Chinese to European admiration has prevented their collections from being known. The Japanese, always enthusiastic students and collectors of the continental art, claim (whether justly or not, is hard to ascertain) that the finest specimens are now in their country. Many of these are reproduced in the invaluable Tokyo publications, the *Kokka*, Mr Tajima's *Select Relics*, &c., with Japanese criticisms in English. Of actual paintings the British Museum possesses a fair number, and the Louvre a few, of real importance. Copies and forgeries abound.

See H. A. Giles, *Introduction to the History of Chinese Pictorial Art* (1905); F. Hirth, *Scraps from a Collector's Note-Book* (1905), (supplements Giles's work and especially valuable for the art of the Ch'ing dynasty); S. W. Bushell, *Chinese Art*, vol. ii. (1906); K. Okakura, *Ideals of the East* (1903); M. Paléologue, *L'Art chinois* (1887); W. Anderson, *Catalogue of Japanese and Chinese Paintings* (1886); Sei-ichi Taki, "Chinese Landscape Painting," *The Kokka*, Nos. 191, &c. (1906); *Chinesische Malereien aus der Sammlung Hirth* (Catalogue of an exhibition held at Dresden) (1897); W. von Seidlitz, article in *Kunstchronik* (1896-1897), No. 16.

2. *Engraving*.—According to native historians, the art of printing from wooden blocks was invented in China in the 6th century A.D., when it was employed for the publication of texts. The earliest evidence we have for the existence of woodcuts made to reproduce pictures or drawings is a passage in a work by Chang Yen-yüan, from which it appears that these were not made before the beginning of the T'ang dynasty, under which that author lived. The method employed was to cut the design with a knife on the plank of the wood, in the manner followed by European artists till the end of the 18th century, when engraving with a burin on boxwood ousted the older process. The Japanese borrowed the art from China; and in Japan a whole school of artists arose who worked specially for the woodcutters and adapted their designs to the limitations of the material employed. In China the art has remained merely reproductive, and its history is therefore of less interest. *Printing in colours* was known to the Chinese in the 17th century, and probably earlier. In the British Museum is a set of prints brought from the East by Kaempfer in 1693, in which eight colours and elaborate *gauffrage* are used. Some fine albums of colour prints have been issued in China, but nothing equal in beauty to the prints produced in Japan by the co-operation of woodcutter and designer. *Engraving on copper* was introduced to China by the Jesuits, and some well-known sets of prints illustrating campaigns in Mongolia were made in the 18th century. But the method has never proved congenial to the artists of the Far East.

See Sir R. K. Douglas, *Guide to the Chinese and Japanese Illustrated Books* (British Museum, 1887); W. Anderson, *Japanese Wood Engraving* (1895).

3. *Architecture*.—In architecture the Chinese genius has found but limited and uncongenial expression. A nation of painters has built picturesquely, but this picturesqueness has fought against the attainment of the finest architectural qualities. There has been little development; the arch, for instance, though known to the Chinese from very early times, has been scarcely used as a principle of design, and the cupola has been undiscovered or ignored; and though foreign architectural ideas were introduced under the influence of the Buddhist and Mahomedan religions, these were more or less assimilated and subdued to the dominant Chinese design. Ruins scarcely exist and no building earlier than the 11th century A.D. is known; but we know from records that the forms of architecture still

prevalent imitate in essentials those of the 4th and 5th centuries B.C. and doubtless represent an immemorial tradition.

The grand characteristic of Chinese architecture is the pre-eminent importance of the roof. The *t'ing* is the commonest model of building. The roof is the main feature; in fact the *t'ing* consists of this roof, massive and immense, with recurved edges, and the numerous short columns on which the roof rests. The columns are of wood, the straight stems of the *nanmu* being specially used for this purpose. The walls are not supports, but merely fill in, with stone or brickwork, the spaces between the columns. The scheme of construction is thus curiously like that of the modern American steel-framed building, though the external form may be derived from the tent of primitive nomads. The roof, being the preponderant feature, is that on which the art of the architect has been concentrated. A double or a triple roof may be devised; the ridges and eaves may be decorated with dragons and other fantastic animals, and the eaves underlaid with carved and lacquered woodwork; the roof itself is often covered with glazed tiles of brilliant hue. In spite of efforts, sometimes desperate, to give variety and individual character by ornament and detail, the general impression is one of poverty of design. "Chinese buildings are usually one-storeyed and are developed horizontally as they are increased in size or number. The principle which determines the plan of projection is that of symmetry" (Bushell). All important buildings must face the south, and this uniform orientation increases the general architectural monotony produced by a preponderance of horizontal lines.

A special characteristic of Chinese architecture is the *pai-lou*, an archway erected only by special authority, usually to commemorate famous persons. The *pai-lou* is commonly made of wood with a tiled roof, but sometimes is built entirely of stone, as is the gateway at the avenue of the Ming tombs. A magnificent example of the *pai-lou* is that on the avenue leading to Wo Fo Ssü, the temple of the Sleeping Buddha, near Peking. This is built of marble and glazed terra-cotta. The *pai-lou*, like the Japanese *torii*, derives its origin from the *toran* of Indian *stupas*. Lofty towers called *t'ai*, usually square and of stone, seem to have been a common type of important building in early times. They are described in old books as erected by the ancient kings and used for various purposes. The towers of the Great Wall are of the same character, and are made of stone, with arched doors and windows. Stone, though plentiful in most provinces of the empire, has been singularly little used by the Chinese, who prefer wood or brick. M. Paléologue attributes this preference of light and destructible materials to the national indifference of the Chinese to posterity and the future, their enthusiasm being wholly devoted to their ancestors and the past.

Temples are designed on the general *t'ing* model. The Temple of Heaven is the most imposing of the Confucian temples, conspicuous with its covering of deep-blue tiles and its triple roof. Near this is the great Altar of Heaven, consisting of three circular terraces with marble balustrades. Buddhist temples are built on the general plan of secular residences, and consist of a series of rectangular courts with the principal building in the centre, the lesser at the sides. Lama temples differ little from these except in the interior decorations and symbolism. Mahommedan mosques are far simpler and severer in internal arrangement, but outwardly these also are in the Chinese style.

The *pagoda* (Chinese *taa*), the type of Chinese architecture most familiar to the West, probably owes its peculiar form to Buddhist influence. In the pagoda alone may be found some trace of a religious imagination such as in Europe made Gothic architecture so full and splendid an expression of the aspiring spirit. The most famous pagoda was the Porcelain Tower of Nanking, destroyed by the T'ai-p'ing rebels in 1854. This was covered with slabs of faience coated with coloured glazes. The ordinary pagoda is built of brick on a stone foundation; it is octagonal with thirteen storeys.

No Chinese buildings show more beauty than some of the graceful stone bridges for which the neighbourhood of Peking has been famous for centuries.

See M. Paléologue, *L'Art chinois* (1887); S. W. Bushell, *Chinese Art*, vol. i. (1904); J. Fergusson, *History of Architecture*; Professor Chûta Itô, articles in *The Kokka*, Nos. 197, 198. (L. B.)

4. *Sculpture*.—Except in the casting and decoration of bronze vessels the Chinese have not obtained distinction as sculptors. They have practised sculpture in stone from an early period, but the incised reliefs of the 2nd century B.C., a number of which are figured in Professor E. Chavannes's standard work,¹ while they display a certain spirit, lack the true plastic sense, and though the power of the Chinese draughtsmen increased rapidly under the T'ang and Sung dynasties, their work in stone showed no parallel progress. The feeling for solidity, which in Japan was a natural growth, was always somewhat exotic in China. With the impulse given to the arts by Buddhism a school of sculpture arose. The pilgrim Fa Hsien records sculpture of distinctive Chinese type in the 5th century. But Indian models dominated the art. Colossal Buddhas of stone were typical of the T'ang era. Little, however, remains of these earlier times, and such true sculpture in stone, wood or ivory as we know dates from the 14th and succeeding centuries. The well-known sculptures on the arch at Chu Yung Kuan (A.D. 1345) are Hindu in style, though not without elements of breadth and strength, which seem to promise a greater development than actually took place. The colossal figures guarding the approach to the Ming tombs (15th century) show that the national taste rapidly became conventional and petrified so far as monumental sculpture was concerned, though occasional examples of devotional or portrait sculpture on a smaller scale in wood and ivory are found, which in power, grace, sincerity and restraint can rank with the work of more gifted nations. Such pieces, however, are extremely rare, and at South Kensington the ivory "Kwanyin and Child" (274. 1808) is a solitary example. As a rule the Chinese sculptor valued his art in proportion to the technical difficulties it conquered. He thus either preferred intractable materials like jade or rock-crystal, or, if he wrought in wood, horn or ivory, sought to make his work curious or intricate rather than beautiful. There is, nevertheless, beauty of a kind in Chinese bowls of jade, and there is dignity in some of the pieces of rock-crystal, but the bulk of the carving done in wood, horn and ivory does not deserve a moment's serious thought from the aesthetic point of view. The few fine specimens may be referred to the earlier part of the Ming dynasty when Chinese art in general was sincere and simple. After the middle of the 15th century there set in the taste for profuse ornament which injured all subsequent Chinese work, and wholly ruined Chinese sculpture.

Bronzes.—In Chinese bronzes we have a more consistent and exceptional form of plastic art, which can be traced continuously for some three thousand years. These bronzes take the form of ritual or honorific vessels, and the archaic shapes used in the service of the prehistoric religion of the country are repeated and copied with slight changes in decoration or detail to the present day.

The oldest extant specimens, chiefly derived from the sack of the Summer Palace at Peking, may be referred to the Shang and Chow dynasties (1766-255 B.C.). These ancient pieces have a certain savage monumental grandeur of design, are usually covered with a rich and thick patina of red, green and brown, and are decorated with simple patterns—scrolls, zigzag lines and a form of what is known as the Greek key-pattern symbolizing respectively waves, mountains and storm clouds. The animal forms used are those of the *tao-tich* (glutton), a fabulous monster (possibly a conventionalized tiger) representing the powers of the earth, the serpent and the bull. These two last in later pieces combine to form the dragon, representing the power of the air. In the Chow dynasty libation vessels were also made in the form of a deer, a ram or a rhinoceros. These characteristics are shown in figures 9-17, Plate II. Fig. 9 is a temple vessel of a shape still in use, but which must date from before 1000 B.C. With this massive piece may be contrasted

¹ *La Sculpture sur pierre en Chine au temps des deux dynasties Han* (Paris, 1893).

the flower-like wine vase shown in fig. 10, a favourite shape which is the prototype of some of the most graceful forms of Chinese porcelain and Japanese bronze. Its date is about 1000 B.C. The large wine vase shown in fig. 11 is some 400 years later. On the body appears the head of the tao-tieh, on the handles are superbly modelled serpents. The technique, which in the previous pieces was somewhat rude, has now become perfect, yet the menacing majestic feeling remains. We see it no less clearly in fig. 12, a marvellous vessel richly inlaid with gold and silver and covered with an emerald-green patina. It may date from about 500 B.C., and indicates that even in this remote epoch the Chinese were not only daring and powerful artists but also master-craftsmen in metal.

It is indeed at this period that the art reaches its climax. The monumental grandeur of the Shang specimens is often allied to clumsiness; the later work, if more elaborate, is always less powerful. Nevertheless, it is to a later period that ninety-nine out of a hundred Chinese bronzes must be referred, and the great majority belong either to the Han and succeeding dynasties (220 B.C.—A.D. 400), or to the Renaissance of the arts which culminated under the Ming dynasty a thousand years later.

The characteristics of the first of these periods is the free use of small solid figures of animals as decoration—the phoenix, the elephant, the frog, the ox, the tortoise, and occasionally men; shapes grow less austere and less significant, as a comparison between figures 11 and 13 will indicate; then towards the end of the 2nd century A.D. the influence of Buddhism is felt in the general tendency towards suavity of form (fig. 14). This vase is most delicately though sparingly inlaid with silver and a few touches of gold. Some small pieces, very richly and delicately inlaid and covered with a magnificent emerald-green patina, belonging to this period, form a connecting link between the inlaid work of the Chow dynasty and that of the Sung and Ming dynasties. The mirrors with Graeco-Bactrian designs, a conclusive proof of the external influences brought to bear upon Chinese art, are also attributed to the Han epoch.

The troubled period between A.D. 400 and A.D. 960, in spite of the interval of activity under the T'ang dynasty, produced, it would seem, but few bronzes, and those few were of no distinct or noteworthy style. Under the Sung dynasty the arts revived, and to this time some of the most splendid specimens of inlaid work—pieces of workmanship and taste no less perfect than that of the Japanese, in which the gold and silver of the earlier work are occasionally reinforced with malachite and lapis-lazuli. The coming of Kublai Khan and the Yuen dynasty (1280–1367) once more brought the East into contact with the West, and to this time we may assign certain fine pieces of Persian form such as pilgrim bottles. The vessels bearing Arabic inscriptions belong to the Ming dynasty (1368–1644), with which the modern history of Chinese art begins.

The work done while the Ming dynasty was still young provides the student of Chinese art with many problems, and in one or two cases even the South Kensington authorities assign to pre-Christian times pieces that are clearly of Ming workmanship. The tendency of the period was eclectic and archaistic. The products of earlier days were reproduced with perfect technical command of materials, and with admirable taste; it is indeed by an excess of these qualities that archaistic Ming work may be distinguished from the true archaic. In fig. 15 we see how the Ming bronze worker took an earlier Buddhist form of vase and gave it a new grace that amounted almost to artifice. A parallel might be found among the products of the so-called *art nouveau* of to-day, in which old designs are revived with just that added suavity or profusion of curvature that robs them of character. Fig. 16 again might be mistaken almost for a piece of the Chow dynasty, were not the grandeur of its form modified by just so much harmony in the curvature of the body and neck, and by just so much finish in the details as to rob the design of the old majestic vigour and to mark it as the splendid effort of an age of culture, and not the natural product of a period of strength.

It is, however, in the inlaid pieces that the difference tells most clearly. Here we find the monstrous forms of the Shang and Chow dynasties revived by men who appreciated their spirit but could not help making the revival an excuse for the display of their own superior skill. The monstrous vases and incense-burners of the past thus appear once more, but are now decorated with a delicate embroidery of inlay, are polished and finished to perfection, but lose therewith just the rudeness of edge and outline which made the older work so gravely significant. At times even some grandly planned vessel will appear with such a festoon of pretty tracery wreathed about it that the incongruity is little short of ridiculous, and we recognize we have passed the turning-point to decline.

Decline indeed came rapidly, and to the latter part of the Ming

epoch we must assign those countless bronzes where dragons and flowers and the stock symbols of happiness, good luck and longevity sprawl together in interminable convolutions. When once we reach this stage of contortion, of elaborate pierced and relief work, we come to the place in history of Chinese bronzes where serious study may cease, except in so far as the study of the symbols themselves throws light upon the history of Chinese porcelain (see CERAMICS). One class of bronze alone needs a word of notice, namely, the profusely decorated pieces which have a Tibetan origin, and are obviously no older than the end of the Ming period. Of these fig. 17 will serve as a specimen, and a comparison with fig. 9 will show how the softer rounded forms and jewelled festoons of Hindu-Greek taste enervated the grand primitive force of the earlier age, and that neither the added delicacy of texture and substance nor the vastly increased dexterity of workmanship can compensate for the vanished majesty. (C. J. H.)

VII. THE CHINESE LANGUAGE

Colloquial.—In treating of Chinese, it will be found convenient to distinguish, broadly, the spoken from the written language and to deal with each separately. This is a distinction which would be out of place if we had to do with any European, or indeed most Oriental languages. Writing, in its origin, is merely a symbolic representation of speech. But in Chinese, as we shall see, for reasons connected with the peculiar nature of the script, the two soon began to move along independent and largely divergent lines. This division, moreover, will enable us to employ different methods of inquiry more suited to each. With regard to the colloquial, it is hardly possible to do more than consider it in the form or forms in which it exists at the present day throughout the empire of China. Although Chinese, like other living languages, must have undergone gradual changes in the past, so little can be stated with certainty about these changes that an accurate survey of its evolution is quite out of the question. Obviously a different method is required when we come to the written characters. The familiar line, “*Litera scripta manet, volat irrevocabile verbum,*” is truer perhaps of Chinese than of any other tongue. We have hardly any clue as to how Chinese was spoken or pronounced in any given district 2000 years ago, although there are written remains dating from long before that time; and in order to gain an insight into the structure of the characters now existing, it is necessary to trace their origin and development.

Beginning with the colloquial, then, and taking a linguistic survey of China, we find not one spoken language but a number of dialects, all clearly of a common stock, yet differing from one another as widely as the various Romance *The dialects.* languages in southern Europe—say, French, Italian and Spanish. Most of these dialects are found fringing the coast-line of China, and penetrating but a comparatively short way into the interior. Starting from the province of Kwangtung in the south, where the Cantonese and farther inland the Hakka dialects are spoken, and proceeding northwards, we pass in succession the following dialects: Swatow, Amoy—these two may almost be regarded as one—Foochow, Wenchow and Ningpo. Farther north we come into the range of the great dialect popularly known as Mandarin (*Kuan hua* or “official language”), which sweeps round behind the narrow strip of coast occupied by the various dialects above-mentioned, and dominates a hinterland constituting nearly four-fifths of China proper. Mandarin, of which the dialect of Peking, the capital since 1421, is now the standard form, comprises a considerable number of sub-dialects, some of them so closely allied that the speakers of one are wholly intelligible to the speakers of another, while others (e.g. the vernaculars of Yangchow, Hankow or Mid-China and Ssü-ch'uan) may almost be considered as separate dialects. Among all these, Cantonese is supposed to approximate most nearly to the primitive language of antiquity, whereas Pekingese perhaps has receded farthest from it. But although philologically and historically speaking Cantonese and certain other dialects may be of greater interest, for all practical purposes Mandarin, in the widest sense of the term, is by far the most important. Not only can it claim to be the native speech of the majority of Chinamen, but it is the recognized vehicle of oral communication between all Chinese officials, even in cases where they come from the same part of the country and speak the same *patois*. For

these reasons, all examples of phraseology in this article will be given in Pekingese.

So far, stress has been laid chiefly on the dissimilarity of the dialects. On the other hand, it must be remembered that they proceed from the same parent stem, are spoken by members of the same race, and are united by the bond of writing which is the common possession of all, and cannot be regarded as derived from one more than from another. They also share alike in the two most salient features of Chinese as a whole: (1) they are all monosyllabic, that is, each individual word consists of only one syllable; and (2) they are strikingly poor in vocables, or separate sounds for the conveyance of speech. The number of these vocables varies from between 800 and 900 in Cantonese to no more than 420 in the vernacular of Peking. This scanty number, however, is eked out by interposing an aspirate between certain initial consonants and the vowel, so that for instance *p'u* is distinguished from *pu*. The latter is pronounced with little or no emission of breath, the "p" approximating the farther north one goes (e.g. at Niuchwang) more closely to a "b." The aspirated *p'u* is pronounced more like our interjection "Pooh!" To the Chinese ear, the difference between the two is very marked. It will be found, as a rule, that an Englishman imparts a slight aspirate to his p's, t's, k's and ch's, and therefore has greater difficulty with the unaspirated words in Chinese. The aspirates are better learned by the ear than by the eye, but in one way or another it is essential that they be mastered by any one who wishes to make himself intelligible to the native.

The influence of the Mongolian population, assisted by the progress of time, has slowly but surely diminished the number of vocables in Pekingese. Thus the initials *ts* and *k*, when followed by the vowel *i* (with its continental value) have gradually become softer and more assimilated to each other, and are now all pronounced *ch*. Again, all consonantal endings in *t* and *k*, such as survive in Cantonese and other dialects, have entirely disappeared from Pekingese, and *n* and *ng* are the only final consonants remaining. Vowel sounds, on the other hand, have been proportionately developed, such compounds as *ao*, *ia*, *iao*, *iu*, *ie*, *ua* occurring with especial frequency. (It must be understood, of course, that the above are only equivalents, not in all cases very exact, for the sounds of a non-alphabetic language.)

An immediate consequence of this paucity of vocables is that one and the same sound has to do duty for different words. Reckoning the number of words that an educated man would want to use in conversation at something over four thousand, it is obvious that there will be an average of ten meanings to each sound employed. Some sounds may have fewer meanings attached to them, but others will have many more. Thus the following represent only a fraction of the total number of words pronounced *shih* (something like the "shi" in shirt): 史 "history," 使 "to employ," 屍 "a corpse," 市 "a market," 師 "an army," 獅 "a lion," 恃 "to rely on," 侍 "to wait on," 詩 "poetry," 時 "time," 識 "to know," 施 "to bestow," 是 "to be," 實 "solid," 失 "to lose," 示 "to proclaim," 視 "to look at," 十 "ten," 拾 "to pick up," 石 "stone," 世 "generation," 食 "to eat," 室 "a house," 氏 "a clan," 始 "beginning," 釋 "to let go," 試 "to test," 事 "affair," 勢 "power," 士 "officer," 誓 "to swear," 逝 "to pass away," 適 "to happen." It would be manifestly impossible to speak without ambiguity, or indeed to make oneself intelligible at all, unless there were some means of supplementing this deficiency of sounds. As a matter of fact, several devices are employed through the combination of which confusion is avoided. One of these devices is the coupling of words in pairs in order to express a single idea. There is a word 哥 *ko* which means "elder brother." But in speaking, the sound *ko* alone would not always be easily understood in this sense. One must either reduplicate it and say *ko-ko*, or prefix 大 (*ta*, "great") and say *ta-ko*. Simple reduplication is mostly confined to family appellations and such adverbial phrases as 慢慢 *man-man*, "slowly." But there is a much larger class of pairs, in which each of the two components has the same meaning.

Examples are: 恐怕 *k'ung-p'a*, "to be afraid," 告訴 *kao-su*, "to tell," 樹木 *shu-mu*, "tree," 皮膚 *p'i-fu*, "skin," 滿盈 *man-ying*, "full," 孤獨 *ku-tu*, "solitary." Sometimes the two parts are not exactly synonymous, but together make up the sense required. Thus in 衣裳 *i-shang*, "clothes," *i* denotes more particularly clothes worn on the upper part of the body, and *shang* those on the lower part. 鳳凰 *feng-huang* is the name of a fabulous bird, *feng* being the male, and *huang* the female. In another very large class of expressions, the first word serves to limit and determine the special meaning of the second: 奶皮 "milk-skin," "cream"; 火腿 "fire-leg," "ham"; 燈籠 "lamp-cage," "lantern"; 海腰 "sea-waist," "strait." There are, besides, a number of phrases which are harder to classify. Thus, 虎 *hu* means "tiger." But in any case where ambiguity might arise, *lao-hu*, "old tiger," is used instead of the monosyllable. 狐 (another *hu*) is "fox," and 狸 *li*, an animal belonging to the smaller cat tribe. Together, *hu-li*, they form the usual term for fox. 知道 *chih tao* is literally "to know the way," but has come to be used simply for the verb "to know." These pairs or two-word phrases are of such frequent occurrence, that the Chinese spoken language might almost be described as bi-syllabic. Something similar is seen in the extensive use of suffixes or enclitics, attached to many of the commonest nouns. 女 *nü* is the word for "girl," but in speech 女子 *nü-tzü* or 女兒 *nü-rh* is the form used. 子 and 兒 both mean child, and must originally have been diminutives. A fairly close parallel is afforded by the German suffix *chen*, as in *Mädchen*. The suffix 兒, it may be remarked, belongs especially to the Peking vernacular. Then, the use of so-called numeratives will often give some sort of clue as to the class of objects in which a substantive may be found. When in pidgin English we speak of "one piece man" or "three piece dollar," the word *piece* is simply a Chinese numerative in English dress. Even in ordinary English, people do not say "four cattle" but "four head of cattle." But in Chinese the use of numeratives is quite a distinctive feature of the language. The commonest of them, 個 *ko*, can be used indifferently in connexion with almost any class of things, animal, vegetable or mineral. But there are other numeratives—at least 20 or 30 in everyday use—which are strictly reserved for limited classes of things with specific attributes. 枚 *mei*, for instance, is the numerative of circular objects such as coins and rings; 顆 *k'o* of small globular objects—pearls, grains of rice, &c.; 口 *k'ou* classifies things which have a mouth—bags, boxes and so forth; 件 *chien* is used of all kinds of affairs; 張 *chang* of chairs and sheets of paper; 隻 *chih* (literally half a pair) is the numerative for various animals, parts of the body, articles of clothing and ships; 把 *pa* for things which are grasped by a handle, such as fans and knives.

This by no means exhausts the list of devices by which the difficulties of a monosyllabic language are successfully overcome. Mention need only be made, however, of the system of "tones," which, as the most curious and important of all, has been kept for the last.

The tones may be defined as regular modulations of the voice by means of which different inflections can be imparted to the same sound. They may be compared with the half-involuntary modulations which express emotional feeling in our words. To the foreign ear, a Chinese sentence spoken slowly with the tones clearly brought out has a certain sing-song effect. If we speak of the tones as a "device" adopted in order to increase the number of vocables, this must be understood rather as a convenient way of explaining their practical function than as a scientific account of their origin. It is absurd to suppose the tones were deliberately invented in order to fit each written character with a separate sound. A tone may be said to be as much an integral part of the word to which it belongs as the sound itself; like the sound, too, it is not fixed once and for all, but is in a constant, though very gradual, state of evolution. This fact is proved by the great differences of

intonation in the dialects. Theoretically, four tones have been distinguished—the even, the rising, the sinking and the entering—each of which falls again into an upper and a lower series. But only the Cantonese dialect possesses all these eight varieties of tone (to which a ninth has been added), while Pekingese, with which we are especially concerned here, has no more than four: the even upper, the even lower, the rising and the sinking. The history of the tones has yet to be written, but it appears that down to the 3rd century B.C. the only tones distinguished were the 平 “even,” 上 “rising” and 入 “entering.” Between that date and the 4th century A.D. the 去 sinking tone was developed. In the 11th century the even tone was divided into upper and lower, and a little later the entering tone finally disappeared from Pekingese. The following monosyllabic dialogue gives a very fair idea of the quality of the four Pekingese tones—1st tone: Dead (spoken in a raised monotone, with slightly plaintive inflection); 2nd tone: Dead? (simple query); 3rd tone: Dead? (an incredulous query long drawn out); 4th tone: Dead! (a sharp and decisive answer). The native learns the tones unconsciously and by ear alone. For centuries their existence was unsuspected, the first systematic classification of them being associated with the name of Shên Yo, a scholar who lived A.D. 441-513. The Emperor Wu Ti was inclined to be sceptical, and one day said to him: “Come, tell me, what are these famous four tones?” “They are 天子聖哲 whatever your Majesty pleases to make them,” replied Shên Yo, skilfully selecting for his answer four words which illustrated, and in the usual order, the four tones in question. Although no native is ever taught the tones separately, they are none the less present in the words he utters, and must be acquired consciously or unconsciously by any European who wishes to be understood. It is a mistake, however, to imagine that every single word in a sentence must necessarily be given its full tonic force. Quite a number of words, such as the enclitics mentioned above, are not intonated at all. In others the degree of emphasis depends partly on the tone itself, partly on its position in the sentence. In Pekingese the 3rd tone (which is really the second in the ordinary series, the 1st being subdivided into upper and lower) is particularly important, and next to it in this respect comes the 2nd (that is, the lower even, or 2nd division of the 1st). It may be said, roughly, that any speaker whose second and third tones are correct will at any rate be understood, even if the 1st and 4th are slurred over.

It is chiefly, however, on its marvellous script and the rich treasures of its literature that the Chinese language depends for its unique fascination and charm. If we take a page ^{The} of printed Chinese or carefully written manuscript ^{characters.} and compare it with a page, say, of Arabic or Sanskrit, the Chinese is seen at once to possess a marked characteristic of its own. It consists of a number of wholly independent units, each of which would fit into a small square, and is called a character. These characters are arranged in columns, beginning on the right-hand side of the page and running from top to bottom. They are words, inasmuch as they stand for articulate sounds expressing root-ideas, but they are unlike our words in that they are not composed of alphabetical elements or letters. Clearly, if each character were a distinct and arbitrarily constructed symbol, only those gifted with exceptional powers of memory could ever hope to read or write with fluency. This, however, is far from being the case. If we go to work synthetically and first see how the language is built up, it will soon appear that most Chinese characters are susceptible of some kind of analysis. We may accept as substantially true the account of native writers who tell us that means of communication other than oral began with the use of knotted cords, similar to the *quipus* of ancient Mexico and Peru, and that these were displaced later on by the practice of notching or scoring rude marks on wood, bamboo and stone. It is beyond question that the first four numerals, as written with simple horizontal strokes, date from this early period. Notching, however, carries us but a little way on the road to a system of writing, which in China,

as elsewhere, must have sprung originally from pictures. In Chinese writing, especially, the indications of such an origin are unmistakable, a few characters, indeed, even in their present form, being perfectly recognizable as pic- ^{Pictorial} tures of objects pure and simple ^{characters.} Thus, for “sun” the ancient Chinese drew a circle with a dot in it: ☉, now modified into 日; for “moon” ☾, now 月; for “God” they drew the anthropomorphic figure 天, which in its modern form appears as 天; for “mountains” 山, now 山; for “child” 子, now 子; for “fish” 魚, now 魚; for “mouth” a round hole, now 口; for “hand” 手, now 手; for “well” 井, now written without the dot. Hence we see that while the origin of all writing is pictographic, in Chinese alone of living languages certain pictures have survived, and still denote what they had denoted in the beginning. In the script of other countries they were gradually transformed into hieroglyphic symbols, after which they either disappeared altogether or became further conventionalized into the letters of an alphabet. These picture-characters, then, accumulated little by little, until they comprised all the common objects which could be easily and rapidly delineated—sun, moon, stars, various animals, certain parts of the body, tree, grass and so forth, to the number of two or three hundred. The next step was to a few compound pictograms which would naturally suggest themselves to primitive man: 旦 the sun just above the horizon=“dawn”; 林 trees side by side=“a forest”; 舌 a mouth with something solid coming out of it=“the tongue”; 言 a mouth with vapor or breath coming out of it=“words.”

But a purely pictographic script has its limitations. The more complex natural objects hardly come within its scope; still less the whole body of abstract ideas. While writing was still in its infancy, it must have occurred to the Chinese ^{Suggestive} to join together two or more pictorial characters in ^{com-} order that their association might suggest to the mind ^{pounds.} some third thing or idea. “Sun” and “moon” combined in this way make the character 明, which means “bright”; woman and child make 好 “good”; “fields” and “strength” (that is, labour in the fields) produce the character 男 “male”; two “men” on “earth” 坐 signifies “to sit”—before chairs were known; the “sun” seen through “trees” 東 designates the east; 家 has been explained as (1) a “pig” under a “roof,” the Chinese idea, common to the Irish peasant, of home, and also (2) as “several persons” under “a roof,” in the same sense; a “woman” under a “roof” makes the character 安 “peace”; “words” and “tongue” 話 naturally suggest “speech”; two hands (友, in the old form 友) indicate friendship; “woman” and “birth” 姓=“born of a woman,” means “clan-name,” showing that the ancient Chinese traced through the mother and not through the father. Interesting and ingenious as many of these combinations are, it is clear that their number, too, must in any practical system of writing be severely limited. Hence it is not surprising that this class of characters, correctly called ideograms, as representing ideas and not objects, should be a comparatively small one. Up to this point there seemed to be but little chance of the written language reaching a free field for expansion. It had run so far on lines sharply distinct from those of ordinary speech. There was nothing in the character *per se* which gave the slightest clue to the sound of the word it represented. Each character, therefore, had to be learned and recognized by a separate effort of memory. The first step in a new, and, as it ultimately proved, the right direction, was the borrowing of a char- ^{Phonetic} acter already in use to represent another word ^{characters.} identical in sound, though different in meaning. Owing to the scarcity of vocables noted above, there might be as many as ten different words in common use, each pronounced *fang*. Out of those ten only one, we will suppose, had a character assigned to it—namely 方 “square” (originally said to be a

picture of two boats joined together). But among the other nine was *fang*, meaning "street" or "locality," in such common use that it became necessary to have some means of writing it. Instead of inventing an altogether new character, as they might have done, the Chinese took 方 "square" and used it also in the sense of "locality." This was a simple expedient, no doubt, but one that, applied on a large scale, could not but lead to confusion. The corresponding difficulty which presented itself in speech was overcome, as we saw, by many devices, one of which consisted in prefixing to the word in question another which served to determine its special meaning. A native does not say *fang* simply when he wishes to speak of a place, but *ti-fang* "earth-place." Exactly the same device was now adopted in writing the character. To *fang* "square" was added another part meaning "earth," in order to show that the *fang* in question had to do with location on the earth's surface. The whole character thus appeared as 坊. Once this phonetic principle had been introduced, all was smooth sailing, and writing progressed by leaps and bounds. Nothing was easier now than to provide signs for the other words pronounced *fang*. "A room" was 房 *door-fang*; "to spin" was 紡 *silk-fang*; "fragrant" was 芳 *herbs-fang*; "to inquire" was 訪 *words-fang*; "an embankment," and hence "to guard against," was 防 *mound-fang*; "to hinder" was 妨 *woman-fang*. This last example may seem a little strange until we remember that man must have played the principal part in the development of writing, and that from the masculine point of view there is something essentially obstructive and unmanageable in woman's nature. It may be remarked, by the way, that the element "woman" is often the determinative in characters that stand for unamiable qualities, e.g. 妒 "jealous," 奸 "treacherous," 妄 "false" and 妖 "uncanny." This class of characters, which constitutes at least nine-tenths of the language, has received the convenient name of *phonograms*. It must be added that the formation of the phonogram or phonetic compound did not always proceed along such simple lines as in the examples given above. Where both parts are pictorial characters, one, the "phonetic," representing the sound, and the other, commonly known as the "radical," giving a clue to the sense. In the first place, most of the phonetics now existing are not simple pictograms, but themselves more or less complex characters made up in a variety of ways. On analysing, for instance, the word 遜 *hsün*, "to withdraw," we find it is composed of the phonetic 孫 combined with the radical 辶, an abbreviated form of 辵 "to walk." But 孫 *sun* means "grandson," and is itself a suggestive compound made up of the two characters 子 "a son" and 系 "connect." The former character is a simple pictogram, but the latter is again resolvable into the two elements 丿 "a down stroke to the left" and 糸 "a strand of silk," which is here understood to be the radical and appears in its ancient form as 糸, a picture of cocoons spun by the silkworm. Again, the sound is in most cases given by no means exactly by the so-called phonetic, a fact chiefly due to the pronunciation having undergone changes which the written character was incapable of recording. Thus, we have just seen that the phonetic of 遜 is not *hsün* but *sun*. There are extreme cases in which a phonetic provides hardly any clue at all as to the sound of its derivatives. The character 欠, for example, which by itself is pronounced *ch'ien*, appears in combination as the modern phonetic of 坎 *k'an*, 軟 *juan*, 飲 *yin* and 吹 *ch'ui*; though in the last instance it was not originally the phonetic but the radical of a character which was analysed as 欠 *ch'ien*, "to emit breath" from 口 "the mouth;" the whole character being a suggestive compound rather than an illustration of radical and phonetic combined. In general, however, it may be said that the "final" or rhyme is pretty accurately indicated, while in not a few cases the phonetic does give the exact sound for all its derivatives. Thus, the characters in which the element 僉 enters are pronounced *chien*, *ch'ien*, *hsien* and *lien*; but 意 and its derivatives are all *i*. A

considerable number of phonetics are nearly or entirely obsolete as separate characters, although their family of derivatives may be a very large one. 𠂔, for instance, is never seen by itself, yet 堅, 緊, and 賢 are among the most important characters in the language. Objections have been raised in some quarters to this account of the phonetic development of Chinese. It is argued that the primitives and sub-primitives, whereby is meant any character which is capable of entering into combination with another, have really had some influence on the meaning, and do not merely possess a phonetic value. But insufficient evidence has hitherto been advanced in support of this view.

The whole body of Chinese characters, then, may conveniently be divided up, for philological purposes, into pictograms, ideograms and phonograms. The first are pictures of objects, the second are composite symbols standing for abstract ideas, the third are compound characters of which the more important element simply represents a spoken sound. Of course, in a strict sense, even the first two classes do not directly represent either objects or ideas, but rather stand for sounds by which these objects and ideas have previously been expressed. It may, in fact, be said that Chinese characters are "nothing but a number of more or less ingenious devices for suggesting spoken words to a reader." This definition exposes the inaccuracy of the popular notion that Chinese is a language of ideographs, a mistake which even the compilers of the *Oxford English Dictionary* have not avoided. Considering that all the earliest characters are pictorial, and that the vast majority of the remainder are constructed on phonetic principles, it is absurd to speak of Chinese characters as "symbolizing the idea of a thing, without expressing the name of it."

The Chinese themselves have always been diligent students of their written language, and at a very early date (probably many centuries B.C.) evolved a sixfold classification of characters, the so-called 六書 *liu shu*, very inaccurately translated by the Six Scripts, which may be briefly noticed:—

1. 指事 *chih shih*, indicative or self-explanatory characters. This is a very small class, including only the simplest numerals and a few others such as 上 "above" and 下 "below."
2. 象形 *hsiang hsing*, pictographic characters.
3. 形聲 *hsing shêng* or 諧聲 *hsieh shêng*, phonetic compounds.
4. 會意 *hui i*, suggestive compounds based on a natural association of ideas. To this class alone can the term "ideographs" be properly applied.
5. 轉注 *chuan chu*. The meaning of this name has been much disputed, some saying that it means "turned round"; e.g. 𠂔 *mu* "eye" is now written 目. Others understand it as comprising a few groups of characters nearly related in sense, each character consisting of an element common to the group, together with a specific and detachable part; e.g. 老, 考, and 耆, all of which have the meaning "old." This class may be ignored altogether, seeing that it is concerned not with the origin of characters but only with peculiarities in their use.
6. 假借 *chia chieh*, borrowed characters, as explained above, that is, characters adopted for different words simply because of the identity of sound.

The order of this native classification is not to be taken as in any sense chronological. Roughly, it may be said that the development of writing followed the course previously traced—that is, beginning with indicative signs, and going on with pictograms and ideograms, until finally the discovery of the phonetic principle did away with all necessity for other devices in enlarging the written language. But we have no direct evidence that this was so. There can be little doubt that phonetic compounds made their appearance at a very early date, probably prior to the invention of a large number of suggestive compounds, and perhaps even before the whole existing stock of pictograms had been fashioned. It is significant that numerous words of daily occurrence, which must have had a place in the earliest

The "Six Scripts."

stages of human thought, are expressed by phonetic characters. We can be fairly certain, at any rate, that the period of "borrowed characters" did not last very long, though it is thought that traces of it are to be seen in the habit of writing several characters, especially those for certain plants and animals, indifferently with or without their radicals. Thus 科蚪 "a tadpole" is frequently written 科斗, without the part meaning "insect" or "reptile."

In the very earliest inscriptions that have come down to us, the so-called 古文 *ku-wên* or "ancient figures," all the above-mentioned forms occur. None are wholly pictorial, with one or two unimportant exceptions. These early inscriptions are found on bronzes dating from the half-legendary period extending from the beginning of the Shang dynasty in the 18th century B.C., or possibly earlier, down to a point in the reign of King Hsüan of the Chou dynasty, generally fixed at 827 B.C. They have been carefully reproduced and for the most part deciphered by painstaking Chinese archaeologists, and form the subject of many voluminous works. The following may be taken as a specimen, in which it will be noticed that only the last character is unmistakably pictorial:

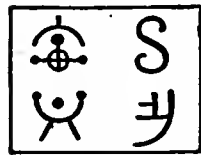

This is read: 申作寶鼎—"Shên made [this] precious *ting*." These ancient bronzes, which mainly take the shape of bells, cauldrons and sacrificial utensils, were until within the last decade our sole source of information concerning the origin and early history of Chinese writing. But recently a large number of inscribed bone fragments have been excavated in the north of

China, providing new and unexpected matter for investigation. The inscriptions on these bones have already furnished a list of nearly 2500 separate characters, of which not more than about 600 have been so far identified. They appear to be responses given by professional soothsayers to private individuals who came to them seeking the aid of divination in the affairs of their daily life. It is difficult to fix their date with much exactitude. The script, though less archaic than that of the earlier bronzes, is nevertheless of an exceedingly free and irregular type. Judging by the style of the inscriptions alone, one would be inclined to assign them to the early years of the Chou dynasty, say 1100 B.C. But Mr L. C. Hopkins thinks that they represent a mode of writing already obsolete at the time of their production, and retained of set purpose by the diviners from obscurantist motives, much as the ancient hieroglyphics were employed by the Egyptian priesthood. He would therefore date them about 500 years later, or only half a century before the birth of Confucius. If that is so, they are merely late specimens of the "ancient figures" appearing long after the latter had made way for a new and more conventionalized form of writing. This new writing is called in Chinese 篆 *chuan*, which is commonly rendered by the word Seal, for the somewhat unscientific reason that many ages afterwards it was generally adopted for use on seals. Under the Chou dynasty, however, as well as the two succeeding it, the meaning of the word was not "seal," but "sinuous curves," as made in writing. It has accordingly been suggested that this epoch marks the first introduction into China of the brush in place of the bamboo or wooden pencil with frayed end which was used with some kind of colouring matter or varnish. There are many arguments both for and against this view; but it is unquestionable, at any rate, that the introduction of a supple implement like the brush at the very time when the forms of characters were fast becoming crystallized and fixed, would be sufficient to account for a great revolution in the style of writing. Authentic specimens of the 大篆 *ta chuan*, older or Greater Seal writing, are exceedingly rare. But it is generally believed that the inscriptions on the famous stone drums, now at Peking, date from the reign of King Hsüan, and they may therefore with practical certainty be cited as examples of the Greater Seal in its original form. These "drums" are really ten roughly chiselled mountain boulders, which were discovered in the early part of the 7th century, lying half buried in the ground near Feng-hsiang Fu in the province of Shensi. On them are engraved ten odes, a complete ode being cut on each drum, celebrating an Imperial hunting and fishing expedition in that part of the country. A facsimile of one of these, taken from an old rubbing and reproduced in Dr Bushell's *Handbook of Chinese Art*, shows that great strides had been made in this writing towards symmetry, compactness and conventionalism. The vogue of the Greater Seal appears to have lasted until the reign of the First Emperor, 221-210 B.C. (see *History*), when a further modification took place. For many centuries China had been split up into a number of practically independent states, and this circumstance seems to have led to considerable variations in the styles of writing. Having succeeded in unifying the empire, the First Emperor proceeded, on the advice of his minister Li Ssü, to standardize its script by ordaining that only the style in use in his own state of Ch'in should henceforward be employed throughout China. It is clear, then, that this new style of writing was nothing more than the Greater Seal characters in the form they had assumed after several

centuries of evolution, with numerous abbreviations and modifications. It was afterwards known as the 小篆 *hsiao chuan*, or Lesser Seal, and is familiar to us from the *Shuo Wên* dictionary (see *Literature*). Though a decided improvement on what had gone before, the Lesser Seal was destined to have but a short career of undisputed supremacy. Reform was in the air; and something less cumbersome was soon felt to be necessary by the clerks who had to supply the immense quantity of written reports demanded by the First Emperor. Thus it came about that a yet simpler and certainly more artistic form of writing was already in use, though not universally so, not

long after the decree abolishing the Greater Seal. This 隸書 *li shu*, or "official script," as it is called, shows a great advance on the Seal character; so much so that one cannot help suspecting the traditional account of its invention. It is perhaps more likely to have been directly evolved from the Greater Seal. If the Lesser Seal was the script of the semi-barbarous state of Ch'in, we should certainly expect to find a more highly developed system of writing in some of the other states. Unlike the Seal, the *li shu* is perfectly legible to one acquainted only with the modern character, from which indeed it differs but in minor details. How long the Lesser Seal continued to exist side by side with the *li shu* is a question which cannot be answered with certainty. It was evidently quite obsolete, however, at the time of the compilation of the *Shuo Wên*, about a hundred years after the Christian era. As for the Greater Seal and still earlier forms of writing, they were not merely obsolete but had fallen into utter oblivion before the Han Dynasty was fifty years old. When a number of classical texts were discovered bricked up in old houses about 150 B.C., the style of writing was considered so singular by the literati of the period that they refused to believe it was the ordinary ancient character at all, and nicknamed it *k'o-l'ou shu*, "tadpole character," from some fancied resemblance in shape. The theory that these tadpole characters were not Chinese but a species of cuneiform script, in which the wedges might possibly suggest tadpoles, must be dismissed as too wildly improbable for serious consideration; but we may advert for a moment to a famous inscription in which the real tadpole characters of antiquity are said to appear. This is on a stone tablet alleged to have been erected on Mount Hêng in the modern Hupeh by the legendary Emperor Yü, as a record of his labours in draining away the great flood which submerged part of China in the 23rd century B.C. After more than one fruitless search, the actual monument is said to have been discovered on a peak of the mountain in A.D. 1212, and a transcription was made, which may be seen reproduced as a curiosity in Legge's *Classics*, vol. iii. For several reasons, however, the whole affair must be regarded as a gross imposture.

Out of the "official script" two other forms were soon developed, namely the 草書 *ts'ao shu*, or "grass character," which so curtails the usual strokes as to be comparable to a species of shorthand, requiring special study, and the 行書 *hsing shu* or running hand, used in ordinary correspondence. Some form of grass character is mentioned as in use as early as 200 B.C. or thereabouts, though how nearly it approximated to the modern grass hand it is hard to say; the running hand seems to have come several centuries later. The final standardization of Chinese writing was due to the great calligrapher Wang Hsi-chih of the 4th century, who gave currency to the graceful style of character known as 楷書 *k'ai shu*, sometimes referred to as the "clerkly hand." When block-printing was invented some centuries later, the characters were cut on this model, which still survives at the present day. It is no doubt owing to the early introduction of printing that the script of China has remained practically unchanged ever since. The manuscript rolls of the T'ang and preceding dynasties, recently discovered by Dr Stein in Turkestan, furnish direct evidence of this fact, showing as they do a style of writing not only clear and legible but remarkably modern in appearance.

The whole history of Chinese writing, then, is characterized by a slow progressive development which precludes the idea of sharply-marked divisions between one period and another. The Chinese themselves, however, have canonized quite a series of alleged inventors, starting from Fu Hsi, a mythical emperor of the third millennium B.C., who is said to have developed a complete system of written characters from the markings on the back of a dragon-horse; hence, by the way, the origin of the dragon as an Imperial emblem. As a rule, the credit of the invention of the art of writing is given to Ts'ang Chieh, a being with fabulous attributes, who conceived the idea of a written language from the markings of birds' claws upon the sand. The diffusion of the Greater Seal script is traced to a work in fifteen chapters published by Shih Chou, historiographer in the reign of King Hsüan. The Lesser Seal, again, is often ascribed to Li Ssü himself, whereas the utmost he can have done in the matter was to urge its introduction into common use. Likewise, Ch'êng Mo, of the 3rd century B.C., is supposed to have invented the *li shu* while in prison, and one account attributes the Lesser Seal to him as well; but the fact is that the whole history of writing, as it stands in Chinese authors, is in hopeless confusion.

Grammar.—When about to embark on the study of a foreign language, the student's first thought is to provide himself with

two indispensable aids—a dictionary and a grammar. The Chinese have found no difficulty in producing the former (see *Literature*). Now what as to the grammar? He might reasonably expect a people so industrious in the cultivation of their language to have evolved some system of grammar which to a certain degree would help to smooth his path. And yet the contrary is the case. No set of rules governing the mutual relations of words has ever been formulated by the Chinese, apparently because the need of such rules has never been felt. The most that native writers have done is to draw a distinction between 實字 and 虛字 “full” and “empty words,” respectively, the former being subdivided into 活字 “living words” or verbs, and 死字 “dead words” or noun-substantives. By “empty words” particles are meant, though sometimes the expression is loosely applied to abstract terms, including verbs. The above meagre classification is their nearest approach to a conception of grammar in our sense. This in itself does not prove that a Chinese grammar is impossible, nor that, if constructed, it might not be helpful to the student. As a matter of fact, several attempts have been made by foreigners to deduce a grammatical system which should prove as rigid and binding as those of Western languages, though it cannot be said that any as yet has stood the test of time or criticism. Other writers have gone to the other extreme, and maintained that Chinese has no grammar at all. In this dictum, exaggerated as it sounds, there is a very substantial amount of truth. Every Chinese character is an indivisible unit, representing a sound and standing for a root-idea. Being free from inflection or agglutination of any kind, it is incapable of indicating in itself either gender, number or case, voice, mood, tense or person. Of European languages, English stands nearest to Chinese in this respect, whence it follows that the construction of a hybrid jargon like pidgin English presents fewer difficulties than would be the case, for instance, with pidgin German. For pidgin English simply consists in taking English words and treating them like Chinese characters, that is, divesting them of all troublesome inflections and reducing them to a set of root-ideas arranged in logical sequence. “You wantchee my no wantchee” is nothing more nor less than literally rendered Chinese: 你要我不要 “Do you want me or not?” But we may go further, and say that no Chinese character can be definitely regarded as being any particular part of speech or possessing any particular function absolutely, apart from the general tenor of its context. Thus, taken singly, the character 上 conveys only the general idea “above” as opposed to “below.” According to its place in the sentence and the requirements of common sense, it may be a noun meaning “upper person” (that is, a ruler); an adjective meaning “upper,” “topmost” or “best”; an adverb meaning “above”; a preposition meaning “upon”; and finally a verb meaning “to mount upon,” or “to go to.” 入 is a character that may usually be translated “to enter” as in 入門 “to enter a door”; yet in the locution 入木 “enter wood,” the verb becomes causative, and the meaning is “to put into a coffin.” It would puzzle grammarians to determine the precise grammatical function of any of the words in the following sentence, with the exception of 何 (an interrogative, by the way, which here happens to mean “why” but in other contexts is equivalent to “how,” “which” or “what”): 事何必古 “Affair why must ancient,” or in more idiomatic English, “Why necessarily stick to the ways of the ancients in such matters?” Or take a proverbial saying like 少所見多所怪, which may be correctly rendered “The less a man has seen, the more he has to wonder at.” It is one thing, however, to translate it correctly, and another to explain how this translation can be inferred from the individual words, of which the bald equivalents might be given as: “Few what see, many what strange.” To say that “strange” is the literal equivalent of 怪 does not mean that 怪 can be definitely classed as an adjective. On the other hand, it would be dangerous even to assert that the word here plays the part of an active verb, because it would

be equally permissible to translate the above “Many things are strange to one who has seen but little.”

Chinese grammar, then, so far as it deals with the classification of separate words, may well be given up as a bad job. But there still remains the art of syntax, the due arrangement of words to form sentences according to certain established rules. Here, at any rate, we are on somewhat firmer ground; and for many years the dictum that “the whole of Chinese grammar depends upon position” was regarded as a golden key to the written language of China. It is perfectly true that there are certain positions and collocations of words which tend to recur, but when one sits down to formulate a set of hard-and-fast rules governing these positions, it is soon found to be a thankless task, for the number of qualifications and exceptions which will have to be added is so great as to render the rule itself valueless. 馬上 means “on a horse,” 上馬 “to get on a horse.” But it will not do to say that a preposition becomes a verb when placed before the substantive, as many other prepositions come before and not after the words they govern. If we meet such a phrase as 警寇, literally “warn rebels,” we must not mentally label 警 as a verb and 寇 as a substantive, and say to ourselves that in Chinese the verb is followed immediately by its object. Otherwise, we might be tempted to translate, “to warn the rebels,” whereas a little reflection would show us that the conjunction of “warning” and “rebels” naturally leads to the meaning “to warn (the populace or whoever it may be) against the rebels.” After all our adventurous incursions into the domain of syntax, we are soon brought back to the starting-point and are obliged to confess that each particular passage is best interpreted on its own merits, by the logic of the context and the application of common sense. There is no reason why Chinese sentences should not be dissected, by those who take pleasure in such operations, into subject, copula and predicate, but it should be early impressed upon the beginner that the profit likely to accrue to him therefrom is infinitesimal. As for fixed rules of grammatical construction, so far from being a help, he will find them a positive hindrance. It should rather be his aim to free his mind from such trammels, and to accustom himself to look upon each character as a root-idea, not a definite part of speech.

The Book Language.—Turning now to some of the more salient characteristics of the book language, with the object of explaining how it came to be so widely separated from common speech, we might reasonably suppose that in primitive times the two stood in much closer relation to each other than now. But it is certainly a striking fact that the earliest literary remains of any magnitude that have come down to us should exhibit a style very far removed from any possible colloquial idiom. The speeches of the Book of History (see *Literature*) are more manifestly fictitious, by many degrees, than the elaborate orations in Thucydides and Livy. If we cannot believe that Socrates actually spoke the words attributed to him in the dialogues of Plato, much less can we expect to find the *ipsissima verba* of Confucius in any of his recorded sayings. In the beginning, all characters doubtless represented spoken words, but it must very soon have dawned on the practical Chinese mind that there was no need to reproduce in writing the bisyllabic compounds of common speech. 見 “to see,” in its written form 見, could not possibly be confused with any other *chien*, and it was therefore unnecessary to go to the trouble of writing 看見 *k'an-chien* “look-see,” as in colloquial. There was a wonderful outburst of literary activity in the Confucian era, when it would seem that the older and more cumbrous form of Seal character was still in vogue. If the mere manual labour of writing was so great, we cannot wonder that all superfluous particles or other words that could be dispensed with were ruthlessly cut away. So it came about that all the old classical works were composed in the tersest of language, as remote as can be imagined from the speech of the people. The passion for brevity and conciseness was pushed to an extreme, and resulted more often than not in such obscurity that detailed commentaries on the classics were found to be necessary, and have always constituted an important branch of Chinese literature. After the introduction of the improved style of script, and when the mechanical means of writing had been simplified, it may be supposed that literary diction also became freer and more expansive. This did happen to some extent, but the classics were held in such veneration as to exercise the profoundest influence over all succeeding schools of writers, and the divorce between literature and popular speech became permanent and irreconcilable. The book language

absorbed all the interest and energy of scholars, and it was inevitable that this elevation of the written should be accompanied by a corresponding degradation of the spoken word. This must largely account for the somewhat remarkable fact that the art of oratory and public speaking has never been deemed worthy of cultivation in China, while the comparatively low position occupied by the drama may also be referred to the same cause. At the same time, the term "book language," in its widest sense, covers a multitude of styles, some of which differ from each other nearly as much as from ordinary speech. The department of fiction (see *Literature*), which the lettered Chinaman affects to despise and will not readily admit within the charmed circle of "literature," really constitutes a bridge spanning the gulf between the severer classical style and the colloquial; while an elegant terseness characterises the higher-class novel, there are others in which the style is loose and shambling. Still, it remains true that no book of any first-rate literary pretensions would be easily intelligible to any class of Chinamen, educated or otherwise, if read aloud exactly as printed. The public reader of stories is obliged to translate, so to speak, into the colloquial of his audience as he goes along. There is no inherent reason why the conversation of everyday life should not be rendered into characters, as is done in foreign handbooks for teaching elementary Chinese; one can only say that the Chinese do not think it worth while. There are a few words, indeed, which, though common enough in the mouths of genteel and vulgar alike, have positively no characters to represent them. On the other hand, there is a vast store of purely book words which would never be used or understood in conversation.

The book language is not only nice in its choice of words, it also has to obey special rules of construction. Of these, perhaps the most apparent is the carefully marked antithesis between characters in different clauses of a sentence, which results in a kind of parallelism or rhythmic balance. This parallelism is a noticeable feature in ordinary poetical composition, and may be well illustrated by the following four-line stanza: "白日依山盡 The bright sun completes its course behind the mountains; 黃河入海流 The yellow river flows away into the sea. 欲窮千里目 Would you command a prospect of a thousand *li*? 更上一層樓 Climb yet one storey higher." In the first line of this piece, every single character is balanced by a corresponding one in the second: 白 white by 黃 yellow, 日 sun by 河 river, and so on. In the 3rd and 4th lines, where more laxity is generally allowed, every word again has its counterpart, with the sole exception of 欲 "wish" and 更 "further."

The question is often asked: What sort of instrument is Chinese for the expression of thought? As a medium for the conveyance of historical facts, subtle emotions or abstruse philosophical conceptions, can it compare with the languages of the Western world? The answers given to this question have varied considerably. But it is noteworthy that those who most depreciate the qualities of Chinese are, generally speaking, theorists rather than persons possessing a profound first-hand knowledge of the language itself. Such writers argue that want of inflection in the characters must tend to make Chinese hard and inelastic, and therefore incapable of bringing out the finer shades of thought and emotion. Answering *a priori* argument with another, one might fairly retort that, if anything, flexibility is the precise quality to be predicated of a language in which any character may, according to the requirements of the context, be interpreted either as noun, verb or adjective. But all such reasoning is somewhat futile. It will scarcely be contended that German, being highly inflected, is therefore superior in range and power to English, from which inflections have largely disappeared. Some of the early Jesuit missionaries, men of great natural ability who steeped themselves in Oriental learning, have left very different opinions on record. Chinese appeared to them as admirable for the superabundant richness of its vocabulary as for the conciseness of its literary style.

And among modern scholars there is a decided tendency to accept this view as embodying a great deal more truth than the other.

Another question, much debated years ago, which time itself is now satisfactorily answering, was whether the Chinese language would be able to assimilate the vast stock of new terminology which closer contact with the West would necessarily carry with it. Two possible courses, it seemed, were open: either fresh characters would be formed on the radical-phonetic principle, or the new idea might be expressed by the conjunction of two or more characters already existing. The former expedient had been tried on a limited scale in Japan, where in the course of time new characters were formed on the same principle as of old, which were yet purely Japanese and find no place in a Chinese dictionary. But although the field for such additions was boundless, the Chinese have all along been chary of extending the language in this way, probably because these modern terms had no Chinese sound which might have suggested some particular phonetic. They have preferred to adopt the other method, of which 昇降機 (rise-descend-machine) for "lift," and 議政國會 (discuss-govern-country-assembly) for "parliament" are examples. Even a metaphysical abstraction like The Absolute has been tentatively expressed by 絕對 (exclude-opposite); but in this case an equivalent was already existing in the Chinese language.

A very drastic measure, strongly advocated in some quarters, is the entire abolition of all characters, to be replaced by their equivalent sounds in letters of the alphabet. Under this scheme 人 would figure as *jên* or *ren*, 馬 as *ma*, and so on. But the proposal has fallen extremely flat. The vocables, as we have seen, are so few in number that only the colloquial, if even that, could possibly be transcribed in this manner. Any attempt to transliterate classical Chinese would result in a mere jumble of sounds, utterly unintelligible, even with the addition of tone-marks. There is another aspect of the case. The characters are a potent bond of union between the different parts of the Empire with their various dialects. If they should ever fall into disuse, China will have taken a first and most fatal step towards internal disruption. Even the Japanese, whose language is not only free from dialects, but polysyllabic and therefore more suitable for romanization, have utterly refused to abandon the Chinese script, which in spite of certain disadvantages has hitherto triumphantly adapted itself to the needs of civilized intercourse.

See P. Premare, *Notitiae Linguae Sinicae* (1831); Ma Kien-chung, *Ma shih wên t'ung* (1899); L. C. Hopkins, *The Six Scripts* (1881) and *The Development of Chinese Writing* (1910); H. A. Giles, *A Chinese-English Dictionary* (2nd ed., 1910). (H. A. G.; L. G.)

VIII. CHINESE LITERATURE

The literature of China is remarkable (1) for its antiquity, coupled with an unbroken continuity down to the present day; (2) for the variety of subjects presented, and for the exhaustive treatment which, not only each subject, but also each subdivision, each separate item, has received, as well as for the colossal scale on which so many literary monuments have been conceived and carried out; (3) for the accuracy of its historical statements, so far as it has been possible to test them; and further (4) for its ennobling standards and lofty ideals, as well as for its wholesome purity and an almost total absence of coarseness and obscenity.

No history of Chinese literature in the Chinese language has yet been produced; native scholars, however, have adopted, for bibliographical purposes, a rough division into four great classes. Under the first of these, we find the Confucian Canon, together with lexicographical, philological, and other works dealing with the elucidation of words. Under the second, histories of various kinds, officially compiled, privately written, constitutional, &c.; also biography, geography and bibliography. Under the third, philosophy, religion, e.g. Buddhism; the arts and sciences, e.g. war, law, agriculture, medicine, astronomy, painting, music and archery; also a host of general works, monographs, and treatises on a number of topics, as well as encyclopaedias. The fourth class is confined to poetry of all

descriptions, poetical critiques, and works dealing with the all-important rhymes.

Poetry.—Proceeding chronologically, without reference to Chinese classification, we have to begin, as would naturally be expected, with the last of the above four classes. Man's first literary utterances in China, as elsewhere, took the form of verse; and the earliest Chinese records in our possession are the national lyrics, the songs and ballads, chiefly of the feudal age, which reaches back to over a thousand years before Christ. Some pieces are indeed attributed to the 18th century B.C.; the latest bring us down to the 6th century B.C. Such is the collection entitled *Shih Ching* (or *She King*), popularly known as the Odes, which was brought together and edited by Confucius, 551-479 B.C., and is now included among the Sacred Books, forming as it does an important portion of the Confucian Canon. These Odes, once over three thousand in number, were reduced by Confucius to three hundred and eleven; hence they are frequently spoken of as "the Three Hundred." They treat of war and love, of eating and drinking and dancing, of the virtues and vices of rulers, and of the misery and happiness of the people. They are in rhyme. Rhyme is essential to Chinese poetry; there is no such thing as blank verse. Further, the rhymes of the Odes have always been, and are still, the only recognized rhymes which can be used by a Chinese poet, anything else being regarded as mere jingle. Poetical licence, however, is tolerated; and great masters have availed themselves freely of its aid. One curious result of this is that whereas in many instances two given words may have rhymed, as no doubt they did, in the speech of three thousand years ago, they no longer rhyme to the ear in the colloquial of to-day, although still accepted as true and proper rhymes in the composition of verse.

It is noticeable at once that the Odes are mostly written in lines of four words, examples of lines consisting of any length from a single word to eight, though such do exist, being comparatively rare. These lines of four words, generally recognized as the oldest measure in Chinese poetry, are frequently grouped as quatrains, in which the first, second and fourth lines rhyme; but very often only the second and fourth lines rhyme, and sometimes there are groups of a larger number of lines in which occasional lines are found without any rhyme at all. A few stray pieces, as old as many of those found among the Odes, have been handed down and preserved, in which the metre consists of two lines of three words followed by one line of seven words. These three lines all rhyme, but the rhyme changes with each succeeding triplet. It would be difficult to persuade the English reader that this is a very effective measure, and one in which many a gloomy or pathetic tale has been told. In order to realise how a few Chinese monosyllables in juxtaposition can stir the human heart to its lowest depths, it is necessary to devote some years to the study of the language.

At the close of the 4th century B.C., a dithyrambic measure, irregular and wild, was introduced and enjoyed considerable vogue. It has indeed been freely adopted by numerous poets from that early date down to the present day; but since the 2nd century B.C. it has been displaced from pre-eminence by the seven-word and five-word measures which are now, after much refinement, the accepted standards for Chinese poetry. The origin of the seven-word metre is lost in remote antiquity; the five-word metre was elaborated under the master-hand of Mei Shêng, who died 140 B.C. Passing over seven centuries of growth, we reach the T'ang dynasty, A.D. 618-905, the most brilliant epoch in the history of Chinese poetry. These three hundred years produced an extraordinarily large number of great poets, and an output of verse of almost incredible extent. In 1707 an anthology of the T'ang poets was published by Imperial order; it ran to nine hundred books or sections, and contained over forty-eight thousand nine hundred separate poems. A copy of this work is in the Chinese department of the University Library at Cambridge.

It was under the T'ang dynasty that a certain finality was reached in regard to the strict application of the tones to Chinese verse. For the purposes of poetry, all words in the language were ranged under one or the other of two tones, the *even* and the *oblique*, the former now including the two even tones, of which prior to the 11th century there was only one, and the latter including the rising, sinking and entering tones of ordinary speech. The incidence of these tones, which may be roughly described as sharps and flats, finally became fixed, just as the incidence of certain feet in Latin metres came to be governed by fixed rules. Thus, reading downward from right to left, as in Chinese, a five-word stanza may run

Sharp	Flat	Flat	Sharp
sharp	flat	flat	sharp
flat	sharp	flat	sharp
flat	sharp	sharp	flat
sharp	flat	sharp	flat

A seven-word stanza may run:

Flat	Sharp	Sharp	Flat
flat	sharp	sharp	flat
sharp	flat	flat	sharp
sharp	flat	flat	sharp
flat	sharp	flat	flat
flat	sharp	sharp	flat
sharp	flat	sharp	sharp

The above are only two metres out of many, but enough perhaps to give to any one who will read them with a pause or quasi-caesura, as marked by ° in each specimen, a fair idea of the rhythmic lilt of Chinese poetry. To the trained ear, the effect is most pleasing; and when this scansion, so to speak, is united with rhyme and choice diction, the result is a vehicle for verse, artificial no doubt, and elaborate, but admirably adapted to the genius of the Chinese language. Moreover, in the hands of the great poets this artificiality disappears altogether. Each word seems to slip naturally into its place; and so far from having been introduced by violence for the ends of prosody, it appears to be the very best word that could have been chosen, even had there been no trammels of any kind, so effectively is the art of the poet concealed by art. From the long string of names which have shed lustre upon this glorious age of Chinese poetry, it may suffice for the present purpose to mention the following, all of the very first rank.

Mêng Hao-jan, A.D. 689-740, failed to succeed at the public competitive examinations, and retired to the mountains where he led the life of a recluse. Later on, he obtained an official post; but he was of a timid disposition, and once when the emperor, attracted by his fame, came to visit him, he hid himself under the bed. His hiding-place was revealed by Wang Wei, a brother poet who was present. The latter, A.D. 699-759, in addition to being a first-rank poet, was also a landscape-painter of great distinction. He was further a firm believer in Buddhism; and after losing his wife and mother, he turned his mountain home into a Buddhist monastery. Of all poets, not one has made his name more widely known than Li Po, or Li T'ai-po, A.D. 705-762, popularly known as the Banished Angel, so heavenly were the poems he dashed off, always under the influence of wine. He is said to have met his death, after a tipsy frolic, by leaning out of a boat to embrace the reflection of the moon. Tu Fu, A.D. 712-770, is generally ranked with Li Po, the two being jointly spoken of as the chief poets of their age. The former had indeed such a high opinion of his own poetry that he prescribed it for malarial fever. He led a chequered and wandering life, and died from the effects of eating roast beef and drinking white wine to excess, immediately after a long fast. Po Chü-i, A.D. 772-846, was a very prolific poet. He held several high official posts, but found time for a considerable output of some of the finest poetry in the language. His poems were collected by Imperial command, and engraved upon tablets of stone. In one of them he anticipates by eight centuries the famous ode by Malherbe, *À Du Perrier, sur la mort de sa fille*.

The T'ang dynasty with all its glories had not long passed away before another imperial house arose, under which poetry flourished again in full vigour. The poets of the Sung dynasty, A.D. 960-1260, were many and varied in style; but their work, much of it of the very highest order, was becoming perhaps a trifle more formal and precise. Life seemed to be taken more seriously than under the gay and pleasure-loving T'angs. The long list of Sung poets includes such names as Ssü-ma Kuang, Ou-yang Hsiu and Wang An-shih, to be mentioned by and by, the first two as historians and the last as political reformer. A still more familiar name in popular estimation is that of Su Tung-p'o, A.D. 1031-1101, partly known for his romantic career, now in court favour, now banished to the wilds, but still more renowned as a brilliant poet and writer of fascinating essays.

The Mongols, A.D. 1260-1368, who succeeded the Sung, and the Mings who followed the Sung and bring us down to the year 1644, helped indeed, especially the Mings, to swell the volume of Chinese verse, but without reaching the high level of the two great poetical periods above-mentioned. Then came the present dynasty of Manchu Tatars, of whom the same tale must be told, in spite of two highly-cultured emperors, K'ang Hsi and Ch'ien Lung, both of them poets and one of them author of a collection containing no fewer than 33,950 pieces, most of which, it must be said, are but four-line stanzas, of no literary value whatever. It may be stated in this connexion that whereas China has never produced an epic in verse, it is not true that all Chinese poems are quite short, running only to ten or a dozen lines at the most. Many pieces run to several hundred lines, though the Chinese poet does not usually affect length, one of his highest efforts being the four-line stanza, known as the "stop-short," in which "the words stop while the sense goes on," expanding in the mind of the reader by the suggestive art of the poet. The "stop-short" is the converse of the epigram, which ends in a satisfying turn of thought to which the rest of the composition is intended to lead up; it aims at producing an impression which, so far from being final, is merely the prelude to a long series of visions and of feelings. The last of the four lines is called the "surprise line"; but the revelation it gives is never a complete one: the words stop, but the sense goes on. Just as in the pictorial art of China,

so in her poetic art is suggestiveness the great end and aim of the artist. Beginners are taught that the three canons of verse composition are lucidity, simplicity and correctness of diction. Yet some critics have boldly declared for obscurity of expression, alleging that the piquancy of a thought is enhanced by its skilful concealment. For the foreign student, it is not necessary to accentuate the obscurity and difficulty even of poems in which the motive is simple enough. The constant introduction of classical allusions, often in the vaguest terms, and the almost unlimited licence as to the order of words, offer quite sufficient obstacles to easy and rapid comprehension. Poetry has been defined by one Chinese writer as "clothing with words the emotions which surge through the heart." The chief moods of the Chinese poet are a pure delight in the varying phenomena of nature, and a boundless sympathy with the woes and sufferings of humanity. Erotic poetry is not absent, but it is not a feature proportionate in extent to the great body of Chinese verse; it is always restrained, and never lapses from a high level of purity and decorum. In his love for hill and stream which he peoples with genii, and for tree and flower which he endows with sentient souls, the Chinese poet is perhaps seen at his very best; his views of life are somewhat too deeply tinged with melancholy, and often loaded with an overwhelming sadness "at the doubtful doom of human kind." In his lighter moods he draws inspiration, and in his darker moods consolation from the wine-cup. Hard-drinking, not to say drunkenness, seems to have been universal among Chinese poets, and a considerable amount of talent has been expended upon the glorification of wine. From Taoist, and especially from Buddhist sources, many poets have obtained glimpses to make them less forlorn; but it cannot be said that there is any definitely religious poetry in the Chinese language.

History.—One of the labours undertaken by Confucius was connected with a series of ancient documents—that is, ancient in his day—now passing under a collective title as *Shu Ching* (or *Shoo King*), and popularly known as the Canon, or Book, of History. Mere fragments as some of these documents are, it is from their pages of unknown date that we can supplement the pictures drawn for us in the Odes, of the early civilization of China. The work opens with an account of the legendary emperor Yao, who reigned 2357–2255 B.C., and was able by virtue of an elevated personality to give peace and happiness to his "black-haired" subjects. With the aid of capable astronomers, he determined the summer and winter solstices, and calculated approximately the length of the year, availing himself, as required, of the aid of an intercalary month. Finally, after a glorious reign, he ceded the throne to a man of the people, whose only claim to distinction was his unwavering practice of filial piety. Chapter ii. deals with the reign, 2255–2205 B.C., of this said man, known in history as the emperor Shun. In accordance with the monotheism of the day, he worshipped God in heaven with prayer and burnt offerings; he travelled on tours of inspection all over his then comparatively narrow empire; he established punishments, to be tempered with mercy; he appointed officials to superintend forestry, care of animals, religious observances, and music; and he organized a system of periodical examinations for public servants. Chapter iii. is devoted to details about the Great Yü, who reigned 2205–2197 B.C., having been called to the throne for his engineering success in draining the empire of a mighty inundation which early western writers sought to identify with Noah's Flood. Another interesting chapter gives various geographical details, and enumerates the articles, gold, silver, copper, iron, steel, silken fabrics, feathers, ivory, hides, &c., &c., brought in under the reign of the Great Yü, as tribute from neighbouring countries. Other chapters include royal proclamations, speeches to troops, announcements of campaigns victoriously concluded, and similar subjects. One peculiarly interesting document is the Announcement against Drunkenness, which seems to have been for so many centuries a national vice, and then to have practically disappeared as such. For the past two or three hundred years, drunkenness has always been the exception rather than the rule. The Announcement, delivered in the 12th century B.C., points out that King Wên, the founder of the Chou dynasty, had wished for wine to be used only in connexion with sacrifices, and that divine favours had always been liberally showered upon the people when such a restriction had been observed. On the other hand, indulgence in strong drink had invariably attracted divine vengeance, and the fall and dis-

ruption of states had often been traceable to that cause. Even on sacrificial occasions, drunkenness is to be condemned. "When, however, you high officials and others have done your duty in ministering to the aged and to your sovereign, you may then eat to satiety and drink to elevation." The Announcement winds up with an ancient maxim, "Do not seek to see yourself reflected in water, but in others,"—whose base actions should warn you not to commit the same; adding that those who after a due interval should be unable to give up intemperate habits would be put to death. It is worth noting, in concluding this brief notice of China's earliest records, that from first to last there is no mention whatever of any distant country from which the "black-haired people" may have originally come; no vestige of any allusion to any other form of civilization, such as that of Babylonia, with its cuneiform script and baked-clay tablets, from which an attempt has been made to derive the native-born civilization of China. A few odd coincidences sum up the chief argument in favour of this now discredited theory.

The next step lands us on the confines, though scarcely in the domain, of history properly so called. Among his other literary labours, Confucius undertook to produce the annals of Lu, his native state; and beginning with the year 722 B.C., he carried the record down to his death in 479, after which it was continued for a few years, presumably by Tso-ch'iu Ming, the shadowy author of the famous Commentary, to which the text is so deeply indebted for vitality and illumination. The work of Confucius is known as the *Ch'un Ch'iu*, the Springs and Autumns, *q.d.* Annals. It consists of a varying number of brief entries under each year of the reign of each successive ruler of Lu. The feudal system, initiated more than four centuries previously, and consisting of a number of vassal states owing allegiance to a central suzerain state, had already broken hopelessly down, so far as allegiance was concerned. For some time, the object of each vassal ruler had been the aggrandizement of his own state, with a view either to independence or to the hegemony, and the result was a state of almost constant warfare. Accordingly, the entries in the *Ch'un Ch'iu* refer largely to covenants entered into between contracting rulers, official visits from one to another of these rulers, their births and deaths, marriages, invasions of territory, battles, religious ceremonies, &c., interspersed with notices of striking natural phenomena such as eclipses, comets and earthquakes, and of important national calamities, such as floods, drought and famine. For instance, Duke Wên became ruler of Lu in 625 B.C., and under his 14th year, 612 B.C., we find twelve entries, of which the following are specimens:—

2. In spring, in the first month, the men of the Chu State invaded our southern border.
3. In summer, on the I-hai day of the fifth month, P'an, Marquis of the Ch'i State, died.
5. In autumn, in the seventh month, there was a comet, which entered Pei-tou ($\alpha\beta\gamma\delta$ in Ursa Major).
9. In the ninth month, a son of the Duke of Ch'i murdered his ruler.

Entry 5 affords the earliest trustworthy instance of a comet in China. A still earlier comet is recorded in what is known as The Bamboo Annals, but the genuineness of that work is disputed.

It will be readily admitted that the *Ch'un Ch'iu*, written throughout in the same style as the quotations given, would scarcely enable one to reconstruct in any detail the age it professes to record. Happily we are in possession of the *Tso Chuan*, a so-called commentary, presumably by some one named Tso, in which the bald entries in the work of Confucius are separately enlarged upon to such an extent and with such dramatic brilliancy that our commentary reads more like a prose epic than "a treatise consisting of a systematic series of comments or annotations on the text of a literary work." Under its guidance we can follow the intrigues, the alliances, the treacheries, the ruptures of the jealous states which constituted feudal China; in its picture pages we can see, as it were with our own eyes, assassinations, battles, heroic deeds, flights, pursuits and the sufferings of the vanquished from the retribution exacted by the victors. Numerous wise and witty sayings are scattered throughout the work, many of which are in current use at the present day.

History as understood in Europe and the west began in China with the appearance of a remarkable man. Ssu-ma Ch'ien, who flourished 145–87 B.C., was the son of an hereditary grand astrologer, also an eager student of history and the actual planner of the great work so successfully carried out after his death. By the time he was ten years of age, Ssu-ma Ch'ien was already well advanced with his studies; and at twenty he set forth on a round of travel which carried him to all parts of the empire. Entering the public service, he was employed upon a mission of inspection to the newly-conquered regions of Ssüch'uan and Yünnan; in 110 B.C. his father died, and he stepped into the post of grand astrologer. After devoting some time and energy to the reformation

*Annals
of the
Lu state.*

*The
Historical
Record.*

of the calendar, he took up the work which had been begun by his father and which was ultimately given to the world as the *Shih Chi*, or Historical Record. This was arranged under five great headings, namely, (1) Annals of Imperial Reigns, (2) Chronological Tables, (3) Monographs, (4) Annals of Vassal Princes, and (5) Biographies.

The Historical Record begins with the so-called Yellow Emperor, who is said to have come to the throne 2698 B.C. and to have reigned a hundred years. Four other emperors are given, as belonging to this period, among whom we find Yao and Shun, already mentioned. It was China's Golden Age, when rulers and ruled were virtuous alike, and all was peace and prosperity. It is discreetly handled in a few pages by Ssü-ma Ch'ien, who passes on to the somewhat firmer but still doubtful ground of the early dynasties. Not, however, until the Chou dynasty, 1122-255 B.C., had held sway for some three hundred years can we be said to have reached a point at which history begins to separate itself definitely from legend. In fact, it is only from the 8th century before Christ that any trustworthy record can be safely dated. With the 3rd century before Christ, we are introduced to one of the feudal princes whose military genius enabled him to destroy beyond hope of revival the feudal system which had endured for eight hundred years, and to make himself master of the whole of the China of those days. In 221 B.C. he proclaimed himself the "First

Burning of the Books.

Emperor," a title by which he has ever since been known. Everything, including literature, was to begin with his reign; and acting on the advice of his prime minister, he issued an order for the burning of all books, with the exception only of works relating to medicine, divination and agriculture. Those who wished to study law were referred for oral teaching to such as had already qualified in that profession. To carry out the scheme effectively, the First Emperor made a point of examining every day about 120 lb weight of books, in order to get rid of such as he considered to be useless; and he further appointed a number of inspectors to see that his orders were carried out. The result was that about four hundred and sixty scholars were put to death for having disobeyed the imperial command, while many others were banished for life. This incident is known as the Burning of the Books; and there is little doubt that, but for the devotion of the literati, Chinese literature would have had to make a fresh start in 212 B.C. As it was, books were bricked up in walls and otherwise widely concealed in the hope that the storm would blow over; and this was actually the case when the Ch'in (Ts'in) dynasty collapsed and the House of Han took its place in 206 B.C. The Confucian books were subsequently recovered from their hiding-places, together with many other works, the loss of which it is difficult now to contemplate. Unfortunately, however, a stimulus was provided, not for the recovery, but for the manufacture of writings, the previous existence of which could be gathered either from tradition or from notices in the various works which had survived. Forgery became the order of the day; and the modern student is confronted with a considerable volume of literature which has to be classified as genuine, doubtful, or spurious, according to the merits of each case. To the first class belongs the bulk, but not all, of the Confucian Canon; to the third must be relegated such books as the *Tao Tê Ching*, to be mentioned later on.

Ssü-ma Ch'ien, dying in 87 B.C., deals of course only with the opening reigns of the Han dynasty, with which he brings to a close the first great division of his history. The second division consists of chronological tables; the third, of eight monographs on the following topics: (1) Rites and Ceremonies, (2) Music, (3) Natural Philosophy, (4) The Calendar, (5) Astronomy, (6) Religion, (7) Water-ways, and (8) Commerce. On these eight a few remarks may not be out of place. (1) The Chinese seem to have been in possession, from very early ages, of a systematic code of ceremonial observances, so that it is no surprise to find the subject included, and taking an important place, in Ssü-ma Ch'ien's work. The *Li Chi*, or Book of Rites, which now forms part of the Confucian Canon, is however a comparatively modern compilation, dating only from the 1st century B.C. (2) The extraordinary similarities between the Chinese and Pythagorean systems of music force the conclusion that one of these must necessarily have been derived from the other. The Jesuit Fathers jumped to the conclusion that the Greeks borrowed their art from the Chinese; but it is now common knowledge that the Chinese scale did not exist in China until two centuries after its appearance in Greece. The fact is that the ancient Chinese works on music perished at the Burning of the Books; and we are told that by the middle of the 2nd century B.C. the hereditary Court music-master was altogether ignorant of his art. What we may call modern Chinese music reached China through Bactria, a Greek kingdom, founded by Diodotus in 256 B.C., with which intercourse had been established by the Chinese at an early date. (3) The term Natural Philosophy can only be applied by courtesy to this essay, which deals with twelve bamboo tubes of varying lengths, by means of which, coupled with the twenty-eight zodiacal constellations and with certain calendaric accords, divine communication is established with the influences of the five elements and the points of the compass corresponding with the eight winds. (4) In this connexion, it is worth noting that in 104 B.C. the Chinese first adopted a cycle of nineteen years, a period which exactly brings together the solar and the lunar years; and further that this very cycle is said to have been introduced by Meton, 5th century B.C., and was adopted at Athens about 330 B.C., probably reaching China, via Bactria, some two centuries afterwards. (5) This chapter deals

specially with the sun, moon and five planets, which are supposed to aid in the divine government of mankind. (6) Refers to the solemn sacrifices to Heaven and Earth, as performed by the emperor upon the summit of Mt. T'ai in Shan-tung. (7) Refers to the management of the Hoang Ho, or Yellow river, so often spoken of as "China's Sorrow," and also of the numerous canals with which the empire is intersected. (8) This chapter, which treats of the circulation of money, and its function in the Chinese theory of political economy, is based upon the establishment in 110 B.C. of certain officials whose business it was to regularize commerce. It was their duty to buy up the chief necessities of life when abundant and when prices were in consequence low, and to offer these for sale when there was a shortage and when prices would otherwise have risen unduly. Thus it was hoped that a stability in commercial transactions would be attained, to the great advantage of the people. The fourth division of the *Shih Chi* is devoted to the annals of the reigns of vassal princes, to be read in connexion with the imperial annals of the first division. The final division, which is in many ways the most interesting of all, gives biographical notices of eminent or notorious men and women, from the earliest ages downwards, and enables us to draw conclusions at which otherwise it would have been impossible to arrive. Confucius and Mencius, for instance, stand out as real personages who actually played a part in China's history; while all we can gather from the short life of Lao Tzū, a part of which reads like an interpolation by another hand, is that he was a more or less legendary individual whose very existence at the date usually assigned to him, 7th and 6th centuries B.C., is altogether doubtful. Scattered among these biographies are a few notices of frontier nations; e.g. of the terrible nomads known as the Hsiung-nu, whose identity with the Huns has now been placed beyond a doubt.

Ssü-ma Ch'ien's great work, on which he laboured for so many years and which ran to five hundred and twenty-six thousand five hundred words, has been described somewhat at length for the following reason. It has been accepted as the model for all subsequent dynastic histories, of which twenty-four have now been published, the whole being produced in 1747 in a uniform edition, bound up (in the Cambridge Library) in two hundred and nineteen large volumes. Each dynasty has found its historian in the dynasty which supplanted it; and each dynastic history is notable for the extreme fairness with which the conquerors have dealt with the vanquished, accepting without demur such records of their predecessors as were available from official sources. The T'ang dynasty, A.D. 618-906, offers in one sense a curious exception to the general rule. It possesses two histories, both included in the above series. The first of these, now known as the Old T'ang History, was ultimately set aside as inaccurate and inadequate, and a New T'ang History was compiled by Ou-yang Hsiu, a distinguished scholar, poet and statesman of the 11th century. Nevertheless, in all cases, the scheme of the dynastic history has, with certain modifications, been that which was initiated in the 1st century B.C. by Ssü-ma Ch'ien.

The output of history, however, does not begin and end with the voluminous records above referred to, one of which, it should be mentioned, was in great part the work of a woman. *The Mirror of History.* History has always been a favourite study with the Chinese, and innumerable histories of a non-official character, long and short, complete and partial, political and constitutional, have been showered from age to age upon the Chinese reading world. Space would fail for the mere mention of a tithe of such works; but there is one which stands out among the rest and is especially enshrined in the hearts of the Chinese people. This is the *T'ung Chien*, or Mirror of History, so called because "to view antiquity as though in a mirror is an aid in the administration of government." It was the work of a statesman of the 11th century, whose name, by a coincidence, was Ssü-ma Kuang. He had been forced to retire from office, and spent nearly all the last sixteen years of his life in historical research. The Mirror of History embraces a period from the 5th century B.C. down to A.D. 960. It is written in a picturesque style; but the arrangement was found to be unsuited to the systematic study of history. Accordingly, it was subjected to revision, and was to a great extent reconstructed by Chu Hsi, the famous commentator, who flourished A.D. 1130-1200, and whose work is now regarded as the standard history of China.

Biography.—In regard to biography, the student is by no means limited to the dynastic histories. Many huge biographical collections have been compiled and published by private individuals, and many lives of the same personages have often been written from different points of view. There is nothing very much by which a Chinese biography can be distinguished from biographies produced in other parts of the world. The Chinese writer always begins with the place of birth, but he is not so particular about the year, sometimes leaving that to be gathered from the date of death taken in connexion with the age which the person may have attained. Some allusion is usually made to ancestry, and the steps of an official career, upward by promotion or downward by disgrace, are also carefully noted.

Geography and Travel.—There is a considerable volume of

Chinese literature which comes under this head; but if we exclude certain brief notices of foreign countries, there remains nothing in the way of general geography which had been produced prior to the arrival of the Jesuit Fathers at the close of the 16th century. Up to that period geography meant the topography of the Chinese empire; and of topographical records there is a very large and valuable collection. Every prefecture and department, some eighteen hundred in all, has each its own particular topography, compiled from records and from tradition with a fullness that leaves nothing to be desired. The buildings, bridges, monuments of archaeological interest, &c., in each district, are all carefully inserted, side by side with biographical and other local details, always of interest to residents and often to the outside public. An extensive general geography of the empire was last published in 1745; and this was followed by a chronological geography in 1794.

The Chinese have always been fond of travel, and hosts of travellers have published notices, more or less extensive, of the different parts of the empire, and even of adjacent nations, which they visited either as private individuals or, in the former case, as officials proceeding to distant posts. With Buddhism came the desire to see the country which was the home of the Buddha; and several important pilgrimages were undertaken with a view to bring back images and sacred writings to China. On such a journey the Buddhist priest, Fa Hsien, started in A.D. 399; and after practically walking the whole way from central China, across the desert of Gobi, on to Khoten, and across the Hindu Kush into India, he visited many of the chief cities of India, until at length reaching Calcutta he took ship, and after a most adventurous voyage, in the course of which he remained two years in Ceylon, he finally arrived safely, in A.D. 414, with all his books, pictures, and images, at a spot on the coast of Shantung, near the modern German port of Kiao-chow.

Another of these adventurous priests was Hsüan Tsang (wrongly, Yüan Chwang), who left China on a similar mission in 629, and returned in 645, bringing with him six hundred and fifty-seven Buddhist books, besides many images and pictures, and one hundred and fifty relics. He spent the rest of his life in translating, with the help of other learned priests, these books into Chinese, and completed in 648 the important record of his own travels, known as the Record of Western Countries.

Philosophy.—Even the briefest *résumé* of Chinese philosophical literature must necessarily include the name of Lao Tzū, although his era, as seen above, and his personality are both matters of the vaguest conjecture. A number of his sayings, scattered over the works of early writers, have been pieced together, with the addition of much incomprehensible jargon, and the whole has been given to the world as the work of Lao Tzū himself, said to be of the 6th century B.C., under the title of the *Tao Tê Ching*. The internal evidence against this book is overwhelming; e.g. one quotation had been detached from the writer who preserved it, with part of that writer's text clinging to it—of course by an oversight. Further, such a treatise is never mentioned in Chinese literature until some time after the Burning of the Books, that is, about four centuries after its alleged first appearance. Still, after due expurgation, it forms an almost complete collection of such apophthegms of Lao Tzū as have come down to us, from which the reader can learn that the author taught the great doctrine of Inaction—Do nothing, and all things will be done. Also, that Lao Tzū anticipated the Christian doctrine of returning good for evil, a sentiment which was highly reprobated by the practical mind of Confucius, who declared that evil should be met by justice. Among the more picturesque of his utterances are such paradoxes as, "He who knows how to shut, uses no bolts; yet you cannot open. He who knows how to bind uses no ropes; yet you cannot untie"; "The weak overcomes the strong; the soft overcomes the hard," &c.

These, and many similar subtleties of speech, seem to have fired the imagination of Chuang Tzū, 4th and 3rd centuries B.C., with the

result that he put much time and energy into the glorification of Lao Tzū and his doctrines. Possessed of a brilliant style and a master of irony, Chuang Tzū attacked the schools of Confucius and Mo Ti (see below) with so much dialectic skill that the ablest scholars of the age were unable to refute his destructive criticisms. His pages abound in quaint anecdotes and allegorical instances, arising as it were spontaneously out of the questions handled, and imparting a lively interest to points which might otherwise have seemed dusty and dull. He was an idealist with all the idealist's hatred of a utilitarian system, and a mystic with all the mystic's contempt for a life of mere external activity. Only thirty-three chapters of his work now remain, though so many as fifty-three are known to have been still extant in the 3rd century; and even of these, several complete chapters are spurious, while in others it is comparatively easy to detect here and there the hand of the interpolator. What remains, however, after all reductions, has been enough to secure a lasting place for Chuang Tzū as the most original of China's philosophical writers. His book is of course under the ban of heterodoxy, in common with all thought opposed to the Confucian teachings. His views as mystic, idealist, moralist and social reformer have no weight with the aspirant who has his way to make in official life; but they are a delight, and even a consolation, to many of the older men, who have no longer anything to gain or to lose.

Confucius, 551-479 B.C., who imagined that his Annals of the Lu State would give him immortality, has always been much more widely appreciated as a moralist than as an historian. His talks with his disciples and with others have been preserved for us, together with some details of his personal and private life; and the volume in which these are collected forms one of the Four Books of the Confucian Canon. Starting from the axiomatic declaration that man is born good and only becomes evil by his environment, he takes filial piety and duty to one's neighbour as his chief themes, often illustrating his arguments with almost Johnsonian emphasis. He cherished a shadowy belief in a God, but not in a future state of reward or punishment for good or evil actions in this world. He rather taught men to be virtuous for virtue's sake.

The discourses of Mencius, who followed Confucius after an interval of a hundred years, 372-289 B.C., form another of the Four Books, the remaining two of which are short philosophical treatises, usually ascribed to a grandson of Confucius. Mencius devoted his life to elucidating and expanding the teachings of the Master; and it is no doubt due to him that the Confucian doctrines obtained so wide a vogue. But he himself was more a politician and an economist (see below) than a simple preacher of morality; and hence it is that the Chinese people have accorded to him the title of The Second Sage. He is considered to have effectually "snuffed out" the heterodox school of Mo Ti,

a philosopher of the 5th and 4th centuries B.C. who propounded a doctrine of "universal love" as the proper foundation for organized society, arguing that under such a system all the calamities that men bring upon one another would altogether disappear, and the Golden Age would be renewed. At the same time Mencius exposed the fallacies of the speculations of Yang Chu, 4th century B.C., who founded a school of ethical egoism as opposed to the exaggerated altruism of Mo Ti. According to Mencius, Yang Chu would not have parted with one hair of his body to save the whole world, whereas Mo Ti would have sacrificed all. Another early philosopher is Hsün Tzū, 3rd century B.C. He maintained, in opposition to Mencius, who upheld the Confucian dogma, and in conformity with Christian doctrine, that the nature of man at his birth is evil, and that this condition can only be changed by efficient moral training. Then came Yang Hsiung, 53-18 B.C., who propounded an ethical criterion midway between the rival positions insisted on by Mencius and Hsün Tzū, teaching that the nature of man at birth is neither good nor evil, but a mixture of both, and that development in either direction depends wholly upon circumstances.

There is a voluminous and interesting work, of doubtful age, which passes under the title of *Huai-nan Tzū*, or the Philosopher of Huai-nan. It is attributed to Liu An, prince of Huai-nan, who died 122 B.C., and who is further said to have written on alchemy; but alchemy was scarcely known in China at the date of his death, being introduced about that time from Greece. The author, whoever he may have been, poses as a disciple of Lao Tzū; but the speculations of Lao Tzū, as glorified by Chuang Tzū, were then rapidly sinking into vulgar efforts to discover the elixir of life. It is very difficult in many cases of this kind to decide what books are, and what books are not, partial or complete forgeries. In the present instance, the aid of the *Shuo Wên*, a dictionary of the 1st century A.D. (see below), may be invoked, but not in quite so satisfactory a sense as that in which it will be seen lower down to have been applied to the *Tao Tê Ching*. The *Shuo Wên* contains a quotation said to be taken from *Huai-nan Tzū*; but that quotation cannot be found in the work under consideration. It may be argued that the words in question may have been taken from another work by the same author; but if so, it becomes difficult to believe that a book, more than two hundred years old, from which the author of the *Shuo Wên* quoted, should have been allowed to perish without leaving any trace behind. China has produced its Bentleys

in considerable numbers; but almost all of them have given their attention to textual criticism of the Confucian Canon, and few have condescended to examine critically the works of heterodox writers. The foreign student therefore finds himself faced with many knotty points he is entirely unable to solve.

Of Wang Ch'ung, a speculative and materialistic philosopher, A.D. 27-97, banned by the orthodox for his attacks on Confucius and Mencius, only one work has survived. It consists of eighty-four essays on such topics as the nature of things, destiny, divination, death, ghosts, poisons, miracles, criticisms of Confucius and Mencius, exaggeration, sacrifice and exorcism. According to Wang Ch'ung, man, endowed at birth sometimes with a good and sometimes with an evil nature, is informed with a vital fluid, which resides in the blood and is nourished by eating and drinking, its two functions being to animate the body and keep in order the mind. It is the source of all sensation, passing through the blood like a wave. When it reaches the eyes, ears and mouth, the result is sight, hearing and speech respectively. Disturbance of the vital fluid leads to insanity. Without the fluid, the body cannot be maintained; without the body, the fluid loses its vitality. Therefore, argues Wang Ch'ung, when the body perishes and the fluid loses its vitality, each being dependent on the other, there remains nothing for immortality in a life beyond the grave. Ghosts he held to be the hallucinations of disordered minds, and miracles to be natural phenomena capable of simple explanations. His indictments of Confucius and Mencius are not of a serious character; though, as regards the former, it must be borne in mind that the Chinese people will not suffer the faintest aspersion on the fair fame of their great Sage. It is related in the *Lun Yu* that Confucius paid a visit to the notoriously immoral wife of one of the feudal nobles, and that a certain disciple was "displeased" in consequence, whereupon the Master swore, saying, "If I have done any wrong, may the sky fall and crush me!" Wang Ch'ung points out that the form of oath adopted by Confucius is unsatisfactory and fails to carry conviction. Had he said, "May I be struck dead by lightning!" his sincerity would have been more powerfully attested, because people are often struck dead by lightning; whereas the fall of the sky is too remote a contingency, such a thing never having been known to happen within the memory of man. As to Mencius, there is a passage in his works which states that a thread of predestination runs through all human life, and that those who accommodate themselves will come off better in the end than those who try to oppose; it is in fact a statement of the *οὐκ ἔστιν ἄλλο* principle. On this Wang Ch'ung remarks that the will of God is consequently made to depend on human actions; and he further strengthens his objection by showing that the best men have often fared worst. For instance, Confucius never became emperor; Pi Kan, the patriot, was disembowelled; the bold and faithful disciple, Tzū Lu, was chopped into small pieces.

But the tale of Chinese philosophers is a long one. It is a department of literature in which the leading scholars of all ages have mostly had something to say. The great Chu Hsi, A.D. 1130-1200, whose fame is chiefly perhaps that of a commentator and whose monument is his uniform exegesis of the Confucian Canon, was also a voluminous writer on philosophy. He took a hand in the mystery which surrounds the *I Ching* (or *Yih King*), generally known as the Book of Changes, which is held by some to be the oldest Chinese work and which forms part of the Confucian Canon. It is ascribed to King Wên, the virtual founder of the Chou dynasty, 1122-249 B.C., whose son became the first sovereign and posthumously raised his father to kingly rank. It contains a fanciful system of divination, deduced originally from eight diagrams consisting of triplet combinations of a line and a broken line, either one of which is necessarily repeated twice, and in two cases three times, in the same combination. Thus there may be three lines ☰, or three broken lines ☷, and other such combinations as ☱ and ☲. Confucius declared that he would like to give another fifty years to the elucidation of this puzzling text. Shao Yung, A.D. 1011-1077, sought the key in numbers; Ch'eng I., A.D. 1033-1107, in the eternal fitness of things. "But Chu Hsi alone," says a writer of the 17th century, "was able to pierce through the meaning and appropriate the thoughts of the inspired man who composed it." No foreigner, however, has been able quite to understand what Chu Hsi did make of it, and several have gone so far as to set all native interpretations aside in favour of their own. Thus, the *I Ching* has been discovered by one to be a calendar of the lunar year; by another, to contain a system of phallic worship; and by a third, to be a vocabulary of the language of a tribe, whose very existence had to be postulated for the purpose.

Political Economy.—This department of literature has been by no means neglected by Chinese writers. So early as the 7th century B.C. we find Kuan Chung, the prime minister of the Ch'i state, devoting his attention to economic problems, and thereby making that state the wealthiest and the strongest of all the feudal kingdoms. Beginning life as a merchant, he passed into the public service, and left behind him at death a large work, parts of which, as we now possess it, may possibly have come direct from his own hand, the remainder being written up at a later date in accordance with the principles he inculcated. His ideal State was divided into twenty-one parts, fifteen of which were allotted to

officials and agriculturists, and six to manufacturers and traders. His great idea was to make his own state self-contained; and accordingly he fostered agriculture in order to be independent in time of war, and manufactures in order to increase his country's wealth in time of peace. He held that a purely agricultural population would always remain poor; while a purely manufacturing population would risk having its supplies of raw material cut off in time of war. He warmly encouraged free imports as a means of enriching his countrymen, trusting to their ability, under these conditions, to hold their own against foreign competition. He protected capital, in the sense that he considered capitalists to be necessary for the development of commerce in time of peace, and for the protection of the state in time of war.

Mencius (see above) was in favour of heavily taxing merchants who tried to engross for the purpose of regrating, that is, to buy up wholesale for the purpose of retailing at monopoly prices; he was in fact opposed to all trusts and corners in trade. He was in favour of a tax to be imposed upon such persons as were mere consumers, living upon property which had been amassed by others and doing no work themselves. No tax, however, was to be exacted from property-owners who contributed by their personal efforts to the general welfare of the community. The object of the tax was not revenue, but the prevention of idleness with its attendant evil consequences to the state.

Wang An-shih, the Reformer, or Innovator, as he has been called, flourished A.D. 1021-1086. In 1069 he was appointed state councillor and forthwith entered upon a series of startling reforms which have given him a unique position in the annals of China. He established a state monopoly in commerce, under which the produce of a district was to be used first for the payment of taxes, then for the direct use of the district itself, and the remainder was to be purchased by the government at a cheap rate, either to be held until there was a rise in price, or to be transported to some other district in need of it. The people were to profit by fixity of prices and escape from further taxation; and the government, by the revenue accruing in the process of administration. There was also to be a system of state advances to cultivators of land; not merely to the needy, but to all alike. The loan was to be compulsory, and interest was to be paid on it at the rate of 2% per month. The soil was to be divided into equal areas and taxed according to its fertility in each case, without reference to the number of inhabitants contained in each area. All these, and other important reforms, failed to find favour with a rigidly conservative people, and Wang An-shih lived long enough to see the whole of his policy reversed.

Military Writers.—Not much, relatively speaking, has been written by the Chinese on war in general, strategy or tactics. There is, however, one very remarkable work which has come down to us from the 6th century B.C., as to the genuineness of *Sun-Tzū*, which there now seems to be no reasonable doubt. A biographical notice of the author, Sun Wu, is given in the *Shih Chi* (see above), from which we learn that "he knew how to handle an army, and was finally appointed General." His work, entitled the *Art of War*, is a short treatise in thirteen chapters, under the following headings: "Laying Plans," "Waging War," "Attack by Stratagem," "Tactical Dispositions," "Energy," "Weak Points and Strong," "Manœuvring," "Variation of Tactics," "The Army on the March," "Terrain," "The Nine Situations," "The Attack by Fire," and "The Use of Spies." Although the warfare of Sun Wu's day was the warfare of bow and arrow, of armoured chariots and push of pike, certain principles inseparably associated with successful issue will be found enunciated in his work. Professor Mackail, in his *Latin Literature* (p. 86), declares that Varro's *Imagines* was "the first instance in history of the publication of an illustrated book." But reference to the Art Section of the history of the Western Han dynasty, 206 B.C.—A.D. 25, will disclose the title of fifteen or sixteen illustrated books, one of which is Sun Wu's *Art of War*.

Agriculture.—In spite of the high place accorded to agriculturists, who rank second only to officials and before artisans and traders, and in spite of the assiduity with which agriculture has been practised in all ages, securing immunity from slaughter for the ploughing ox—what agricultural literature the Chinese possess may be said to belong entirely to modern times. Ch'ên Fu of the 12th century A.D. was the author of a small work in three parts, dealing with agriculture, cattle-breeding and silkworms respectively. There is also a well-known work by an artist of the early 13th century, with forty-six woodcuts illustrating the various operations of agriculture and weaving. This book was reprinted under the emperor K'ang Hsi, 1662-1723, and new illustrations with excellent perspective were provided by Chiao Ping-chên, an artist who had adopted foreign methods as introduced by the famous Jesuit, Matteo Ricci. The standard work on agriculture, entitled *Nung Chêng Ch'üan Shu*, was compiled by Hsü Kuang-ch'i, 1562-1634, generally regarded as the only influential member of the mandarin class who has ever become a convert to Christianity. It is in sixty sections, the first three of which are devoted to classical references. Then follow two sections on the division of land, six on the processes of husbandry, none on hydraulics, four on agricultural implements, six on planting, six on rearing silkworms, four on trees, one on breeding animals, one on food and eighteen on provision against a time of scarcity.

Wang
Ch'ung.

Wang
An-shih.

Book of
Changes.

Kuan
Chung.

Hsü
Kuang-
ch'i.

Medicine and Therapeutics.—The oldest of the innumerable medical works of all descriptions with which China has been flooded from time immemorial is a treatise which has been credited to the Yellow Emperor (see above), 2698–2598 B.C. It is entitled *Plain Questions of the Yellow Emperor*, or *Su Wen* for short, and takes the form of questions put by the emperor and answered by Earl Ch'i, a minister, who was himself author of the *Nei Ching*, a medical work no longer in existence. Without accepting the popular attribution of the *Su Wen*, it is most probable that it is a very old book, dating back to several centuries before Christ, and containing traditional lore of a still more remote period. The same may be said of certain works on cautery and acupuncture, both of which are still practised by Chinese doctors; and also of works on the pulse, the variations of which have been classified and allocated with a minuteness hardly credible. Special treatises on fevers, skin-diseases, diseases of the feet, eyes, heart, &c., are to be found in great quantities, as well as veterinary treatises on the treatment of diseases of the horse and the domestic buffalo. But in the whole range of Chinese medical literature there is nothing which can approach the *Pên Ts'ao*, or *Pên Ts'ao*. **Materia Medica**, sometimes called the Herbal, a title (i.e. *Pên Ts'ao*) which seems to have belonged to some book of the kind in pre-historic ages. The work under consideration was compiled by Li Shih-chên, who completed his task in 1578 after twenty-six years' labour. No fewer than eighteen hundred and ninety-two species of drugs, animal, vegetable and mineral, are dealt with, arranged under sixty-two classes in sixteen divisions; and eight thousand one hundred and sixty prescriptions are given in connexion with the various entries. The author professes to quote from the original *Pên Ts'ao*, above mentioned; and we obtain from his extracts an insight into some curious details. It appears that formerly the number of recognized drugs was three hundred and sixty-five in all, corresponding with the days of the year. One hundred and twenty of these were called *sovereigns* (cf. a sovereign prescription); and were regarded as entirely beneficial to health, taken in any quantity or for any time. Another similar number were called *ministers*; some of these were poisonous, and all had to be used with discretion. The remaining one hundred and twenty-five were *agents*; all very poisonous, but able to cure diseases if not taken in over-doses. The modern *Pên Ts'ao*, in its sixteen divisions, deals with drugs classed under water, fire, earth, minerals, herbs, grain, vegetables, fruit, trees, clothes and utensils, insects, fishes, crustacea, birds, beasts and man. In each case the proper name of the drug is first given, followed by its explanation, solution of doubtful points, correction of errors, means of identification by taste, use in prescriptions, &c. The work is fully illustrated, and there is an index to the various medicines, classed according to the complaints for which they are used.

Divination, &c.—The practice of divination is of very ancient date in China, traceable, it has been suggested, back to the Canon of Changes (see above), which is commonly used by the lettered classes for that purpose. A variety of other methods, the chief of which is astrology, have also been adopted, and have yielded a considerable bulk of literature. Even the officially-published almanacs still mark certain days as suitable for certain undertakings, while other days are marked in the opposite sense. The spirit of Zaidkeli pervades the Chinese empire. In like manner, geomancy is a subject on which many volumes have been written; and the same applies to the pseudo sciences of palmistry, physiognomy, alchemy (introduced from Greek sources) and others.

Painting.—Calligraphy, in the eyes of the Chinese, is just as much a fine art as painting; the two are, in fact, considered to have come into existence together, but as might be expected the latter occupies the larger space in Chinese literature, and forms the subject of numerous extensive works. One of the most important of these is the *Hsüan Ho Hua P'u*, the author of which is unknown. It contains information concerning two hundred and thirty-one painters and the titles of six thousand one hundred and ninety-two of their pictures, all in the imperial collection during the dynastic period *Hsüan Ho*, A.D. 1119–1126, from which the title is derived. The artists are classified under one of the following ten headings, supposed to represent the line in which each particularly excelled: Religion, Human Figures, Buildings, Barbarians (including their Animals), Dragons and Fishes, Landscape, Animals, Flowers and Birds, The Bamboo, Vegetables and Fruits.

Music.—The literature of music does not go back to a remote period. The Canon of Music, which was formerly included in the Confucian Canon, has been lost for many centuries; and the works now available, exclusive of entries in the dynastic histories, are not older than the 9th century A.D., to which date may be assigned the *Chieh Ku Lu*, a treatise on the deerskin drum, said to have been introduced into China from central Asia, and evidently of Scythian origin. There are several important works of the 16th and 17th centuries, in which the history and theory of music are fully discussed, and illustrations of instruments are given, with measurements in each case, and the special notation required.

Miscellaneous.—Under this head may be grouped a vast number of works, many of them exhaustive, on such topics as archaeology, seals (engraved), numismatics, pottery, ink (the miscalled "Indian"), mirrors, precious stones, tea, wine, chess, wit and humour, even cookery, &c. There is, indeed, hardly any subject, within

reasonable limits, which does not find some corner in Chinese literature.

Collections.—Reprints of miscellaneous books and pamphlets in a uniform edition, the whole forming a "library," has long been a favourite means of disseminating useful (and other) information. Of these, the *Lung Wei Pi Shu* may be taken as a specimen. In bulk it would be about the equivalent of twenty volumes, 8vo, of four hundred pages to each. Among its contents we find the following. A handbook of phraseology, with explanations; a short account of fabulous regions to the N., S., E. and W.; notes on the plants and trees of southern countries; biographical sketches of ninety-two wonderful personages; an account of the choice of an empress, with standard measurements of the height, length of limb, &c., of the ideal woman; "Pillow Notes" (a term borrowed by the Japanese), or jottings on various subjects, ranging from the Creation to an account of Fusang, a country where the trees are thousands of feet high and of vast girth, thus supporting the California, as opposed to the Mexico, identification of Fusang; critiques on the style of various poets, and on the indebtedness of each to earlier writers; a list of the most famous bronze vessels cast by early emperors, with their dimensions, inscriptions, &c.; a treatise on the bamboo; a list of famous swords, with dates of forging and inscriptions; an account of the old Mongol palace, previous to its destruction by the first Ming emperor; notes on the wild tribes of China; historical episodes; biographical notices of one hundred and four poets of the present dynasty; notes on archaeological, supernatural and other topics, first published in the 9th century; notes for bibliophiles on the care of books, and on paper, ink, pictures and bric-à-brac; a collection of famous criminal cases; night thoughts suggested by a meteor. Add to the above, numerous short stories relating to magic, dreams, bilocation, and to almost every possible phase of supernatural manifestation, and the reader will have some idea of what he may expect in an ordinary "library" of a popular character. It must always be remembered that with the Chinese, style is of paramount importance. Documents, the subject-matter of which would be recognized to be of no educative value, would still be included, if written in a pleasing style, such as might be serviceable as a model.

Individual Authors.—In a similar manner it has always been customary for relatives or friends, sometimes for the trade, to publish the "complete works" of important and often unimportant writers; usually, soon after death. And as literary distinction has hitherto almost invariably led to high office under the state, the collected works of the great majority of authors open with selected Memorials to the Throne and other documents of an official character. The public interest in these may have long since passed away; but they are valued by the Chinese as models of a style to be imitated, and the foreign student occasionally comes across papers on once burning questions arising out of commercial or diplomatic intercourse with western nations. Then may follow—the order is not always the same—the prefaces which the author contributed from time to time to the literary undertakings of his friends. Preface-writing is almost a department of Chinese literature. No one ever thinks of publishing a book without getting one or more of his capable associates to provide prefaces, which are naturally of a laudatory character, and always couched in highly-polished and obscure terms, the difficulty of the text being often aggravated by a fanciful and almost illegible script. Prefaces written by emperors, many examples of which may be seen, are of course highly esteemed, and are generally printed in coloured ink. The next section may comprise biographical notices of eminent men and women, or of mere local celebrities, who happened to die in the author's day. Then will follow Records, a title which covers inscriptions carved on the walls of new buildings, or on memorial tablets, and also notes on pictures which the author may have seen, places which he may have visited, or allegorical incidents which he may have imagined. Then come disquisitions, or essays on various subjects; researches, being short articles of archaeological interest; studies or monographs; birthday congratulations to friends or to official colleagues; announcements, as to deities, a cessation of whose worship is threatened if the necessary rain or fair weather be not forthcoming; funeral orations, letters of condolence, &c. The above items will perhaps fill half a dozen volumes; the remaining volumes, running to twenty or thirty in all, as the case may be, will contain the author's poetry, together with his longer and more serious works. The essential of such a collection is, in Chinese eyes, its completeness.

Fiction.—Although novels are not regarded as an integral part of literature proper, it is generally conceded that some novels may be profitably studied, if for no other reason, from the point of view of style. With the novel, however, we are no longer on perfectly safe ground in regard to that decency which characterizes, as has been above stated, the vast mass of Chinese literature. Chinese novels range, in this sense, from the simplest and most unaffected tale of daily life, down to low—not the lowest—depths of objectionable pornography. The *San Kuo Chih*, an historical romance based upon a period of disruption at the close of the

Lung Wei Pi Shu.

San Kuo Chih.

2nd century A.D., is a delightful book, packed with episodes of battle, heroism, self-sacrifice, skilful strategy, and all that goes to make up a stirring picture of strenuous times. Its author, who might almost have been Walter Scott, cannot be named for certain; but the work itself probably belongs to the 13th century, a date at which the novel begins to make its appearance in China. Previous to that time, there had been current an immense quantity of stories of various kinds, but nothing like a novel, as we understand the term. From the 13th century onwards, the growth of the novel was continuous; and finally, in the 17th century, a point was reached which is not likely to be surpassed. The *Hung Lou Mêng*, the author of which took

Hung Lou Mêng. pains, for political reasons, to conceal his identity, is a creation of a very high order. Its plot is intricate and original, and the *dénouement* startlingly tragic.

In the course of the story, the chief clue of which is love, woven in with intrigue, ambition, wealth, poverty, and other threads of human life, there occur no fewer than over four hundred characters, each one possessed of a distinctive personality drawn with marvellous skill. It contains incidents which recall the licence tolerated in Fielding; but the coarseness, like that of Fielding, is always on the surface, and devoid of the ulterior suggestiveness of the modern psychological novel. But perhaps no work of fiction has ever enjoyed such vogue among literary

Liao Chai. men as a collection of stories, some graceful, some weird, written in 1679 by P'u Sungling, a disappointed candidate at the public examinations. This collection, known as the *Liao Chai*, is exceedingly interesting to the foreign student for its sidelights on folklore and family life; to the native scholar, who professes to smile at the subject-matter as beyond the pale of genuine literature, it is simply invaluable as an expression of the most masterly style of which his language is capable.

Drama.—Simultaneously with the appearance of the novel, stage-plays seem to have come into existence in China. In the earliest ages there were set dances by trained performers, to the accompaniment of music and singing; and something of the kind, more or less ornate as regards the setting, has always been associated with solemn and festive occasions. But not until the days of the Mongol rule, A.D. 1260–1368, can the drama proper be said to have taken root and flourished in Chinese soil. The probability is that both the drama and the novel were introduced from Central Asia in the wake of the Mongol conquerors; the former is now specially essential to the everyday happiness of the Chinese people, who are perhaps the most confirmed playgoers in the world. There is an excellent collection of one hundred plays of the Mongol dynasty, with an illustration to each, first published in 1615; there is also a further large collection, issued in 1845, which contains a great number of plays arranged under sixty headings, according to the style and

Hsi Hsiang Chi. purport of each, besides many others. There is one famous play of the Mongol period which deals largely in plot and passion, and is a great favourite with the educated classes. It is entitled *Hsi Hsiang Chi*, or the Story of the Western Pavilion; and as if there was a doubt as to the reception which would be accorded to the work, a minatory sentence was inserted in the prolegomena: "If any one ventures to call this book indecent, he will certainly have his tongue torn out in hell." So far as the written play is concerned, its language is altogether unobjectionable; on the stage, by means of gag and gesture, its presentation is often unseemly and coarse. What the Chinese playgoer delights in, as an evening's amusement, is a succession of plays which are more of the nature of sketches, slight in construction and generally weak in plot, some of them based upon striking historical episodes, and others dealing with a single humorous incident.

Dictionaries.—The *Erh Ya*, or Nearing the Standard, is commonly classed as a dictionary, and is referred by native scholars generally to the 12th century B.C. The entries are arranged under nineteen heads, to facilitate reference, and explain a large number of words and phrases, including names of beasts, birds, plants and fishes. The work is well illustrated in the large modern edition; but the actual date of composition is an entirely open question, and the insertion of

woodcuts must necessarily belong to a comparatively late age (see *Military Writers*).

With the *Shuo Wen*, or Explanation of Written Words, we begin the long list of lexicographical works which constitute such a notable feature in Chinese literature. A scholar, named Hsü Shên, *Shuo Wen*, who died about A.D. 120, made an effort to bring together and analyse all the characters it was possible to gather from the written language as it existed in his own day. He then proceeded to arrange these characters—about ten thousand in all—on a system which would enable a student to find a given word without having possibly to search through the whole book. To do this, he simply grouped together all such as had a common part, more or less indicative of the meaning of each, much as though an English dictionary were to consist of such groups as

Dog-days
Dog-kennel
Dog-collar
Dog-meat
Dog-nap

and so on.

Horse-collar
Horse-flesh
Horse-back
Horse-fly
Horse-chestnut

and so on.

Hsü Shên selected five hundred and forty of these common parts, or Radicals (see *Language*), a number which, as will be seen later on, was found to be cumbersomely large; and under each Radical he inserted all the characters belonging to it, but with no particular order or arrangement, so that search was still, in many cases, quite a laborious task. The explanations given were chiefly intended to establish the pictorial origin of the language; but whereas no one now disputes this as a general conclusion, the steps by which Hsü Shên attempted to prove his theory must in a large number of instances be dismissed as often inadequate and sometimes ridiculous. Nevertheless, it was a great achievement; and the *Shuo Wen* is still indispensable to the student of the particular script in vogue a century or two before Christ. It is also of value in another sense. It may be used, with discretion, in testing the genuineness of an alleged ancient document, which, if an important or well-known document before the age of Hsü Shên, would not be likely to contain characters not given in his work. Under this test the *Tao Tê Ching*, for instance, breaks down (see *Huai-nan Tzû*).

Passing over a long series of dictionaries and vocabularies which appeared at various dates, some constructed on Hsü Shên's plan, with modifications and improvements, and others, known as phonetic dictionaries, arranged under the finals according to the Tones, we come to the great standard lexicon produced under the auspices, and now bearing the name of the emperor K'ang Hsi, A.D. 1662–1723.

But before proceeding, a rough attempt may be made to exhibit in English terms the principle of the phonetic as compared with the radical dictionary described above. In the spoken language there would occur the word *light*, the opposite of dark, and this would be expressed in writing by a certain symbol. Then, when it became necessary to write down *light*, the opposite of heavy, the result would be precisely what we see in English. But as written words increased, always with a limited number of vocables (see *Language*), this system was found to be impracticable, and Radicals were inserted as a means of distinguishing one kind of *light* from another, but without altering the original sound. Now, in the phonetic dictionary the words are no longer arranged in such groups as

Sun-light
Sun-beam
Sun-stroke
Sun-god, &c.

according to the Radicals, but in such groups as

Sun-light
Moon-light
Foot-light
Gas-light, &c.

according to the phonetics, all the above four being pronounced simply *light*, without reference to the radical portion which guides towards the limited sense of the term. So, in a phonetic dictionary, we should have such a group as

Brass-bound
Morocco-bound
Half-bound
Spell-bound
Homeward-bound
Wind-bound

and so on, all the above six being pronounced simply *bound*. To return to "K'ang Hsi," as the lexicon in question is familiarly styled, the total number of characters given therein amounts to over forty-four thousand, grouped no longer under the five hundred and forty Radicals of Hsü Shên, but under the much more manageable number of two hundred and fourteen,

*Phonetic
diction-
aries.*

K'ang Hsi.

as already used in earlier dictionaries. Further, as the groups of characters would now be more than four times as large as in the *Shuo Wen*, they were subdivided under each Radical according to the number of strokes in the other, or phonetic part of the character. Thus, adopting letters as strokes, for the purpose of illustration, we should have "dog-nap" in the group of Radical "dog" and three strokes, while "dog-days" and "dog-meat" would both be found under Radical "dog" with four strokes, and so on. The two hundred and fourteen Radicals are themselves arranged in groups according to the number of strokes; so that it is not a very arduous task to turn up ordinary characters in a Chinese dictionary. Finally, although Chinese is a monosyllabic and non-alphabetic language, a method has been devised, and has been in use since the 3rd century A.D., by which the sound of any word can be indicated in a dictionary otherwise than by simply quoting a word of similar sound, which of course may be equally unknown to the searcher. Thus, the sound of a word pronounced *ching* can be exhibited by selecting two words, one having the initial *ch*, and the other a final *ing*. E.g. the sound *ching* is given as *chien ling*; that is *chshien ling = ching*.

The Concordance.—Considering the long unbroken series of years during which Chinese literature has always, in spite of many losses, been steadily gaining in bulk, it is not astonishing to find that classical, historical, mythological and other allusions to personages or events of past times have also grown out of all proportion to the brain capacity even of the most brilliant student. Designed especially to meet this difficulty, there are several well-known handbooks, elementary and advanced, which trace such allusions to their source and provide full and lucid explanations; but even the most extensive of these is on a scale incommensurate with the requirements of the scholar. Again, it is due to the emperor K'ang Hsi that we possess one of the most elaborate compilations of the kind ever planned and carried to completion. The *P'ei Wen Yün Fu*, or Concordance to Literature, is a key, not only to allusions in general, but to all phraseology, including allusions, idiomatic expressions and other obscure combinations of words, to be found in the classics, in the dynastic histories, and in all poets, historians, essayists, and writers of recognized eminence in their own lines. No attempt at explanation is given; but enough of the passage, or passages, in which the phrase occurs, is cited to enable the reader to gather the meaning required. The trouble, of course, lies with the arrangement of these phrases in a non-alphabetic language. Recourse has been had to the Rhymes and the five Tones (see *Language*); and all phrases which end with the same word form one of a number of groups which appear under the same Rhyme, the Rhymes themselves being distributed over five Tones. Thus, to find any phrase, the first point is to discover what is its normal Rhyme; the next is to ascertain the Tone of that Rhyme. Then, under this Tone-group the Rhyme-word will be found, and under the Rhyme-word group will be found the final word of the phrase in question. It will now only remain to run through this last group of phrases, all of which have this same final word, and the search—so vast is the collection—will usually yield a satisfactory result. The *P'ei Wen Yün Fu* runs of course to many volumes; a rough estimate shows it to contain over fifteen million words.

Encyclopaedias.—In their desire to bring together condensed, yet precise, information on a large variety of subjects, the Chinese may be said to have invented the encyclopaedia. Though not the earliest work of this kind, the *T'ai Ping Yü Lan* is the first of any great importance. It was produced towards the close of the 10th century A.D., under the direct supervision of the emperor, who is said to have examined three sections every day for about a year, the total number of sections being one thousand in all, arranged under fifty-five headings. Another similar work, dealing with topics drawn from the lighter literature of China, is the *T'ai Ping Kuang Chi*, which was issued at about the same date as the last-mentioned. Both of these, and especially the former, have passed through several editions. They help to inaugurate the great Sung dynasty, which for three centuries to follow effected so much in the cause of literature. Other encyclopaedias, differing in scope and in plan, appeared from time to time, but it will be necessary to concentrate attention upon

two only. The third emperor of the Ming dynasty, known as Yung Lo, A.D. 1403-1425, issued a commission for the production of a work on a scale which was colossal even for China. His idea was to collect together all that had ever been written in the four departments of (1) the Confucian Canon, (2) History, (3) Philosophy and (4) General Literature, including astronomy, geography, cosmogony, medicine, divination, Buddhism, Taoism, arts and handicrafts; and in 1408 such an encyclopaedia was laid before the Throne, received the imperial approval and was named *Yung Lo Ta Tien*, or The Great Standard of Yung Lo. To achieve this, 3 commissioners, with 5 directors, 20 sub-directors and a staff of 2141 assistants, had laboured for the space of five years. Its contents ran to no fewer than 22,877 separate sections, to which must be added an index filling 60 sections. Each section contained about 20 leaves, making a total of 917,480 pages for the whole work. Each page consisted of sixteen columns of characters averaging twenty-five to each column, or a total of 366,992,000 characters, to which, in order to bring the amount into terms of English words, about another third would have to be added. This extraordinary work was never printed, as the expense would have been too great, although it was actually transcribed for that purpose; and later on,

two more copies were made, one of which was finally stored in Peking and the other, with the original, in Nanking. Both the Nanking copies perished at the fall of the Ming dynasty; and a similar fate overtook the Peking copy, with the exception of a few odd volumes, at the siege of the legations in 1900. The latter was bound up in 11,100 volumes, covered with yellow silk, each volume being 1 ft. 8 in. in length by 1 ft. in breadth, and averaging over $\frac{1}{2}$ in. in thickness. This would perhaps be a fitting point to conclude any notice of Chinese encyclopaedias, but for the fact that the work of Yung Lo is gone while another encyclopaedia, also on a huge scale, designed and carried out some centuries later, is still an important work of reference.

The *T'u Shu Chi Ch'eng* was planned, and to a great extent made ready, under instructions from the emperor K'ang Hsi (see above), and was finally brought out by his successor, Yung Ch'eng, 1723-1736. Intended to embrace all departments of *T'u Shu*, knowledge, its contents were distributed over six leading categories, which for want of better equivalents may be roughly rendered by (1) Heaven, (2) Earth, (3) Man, (4) Arts and Sciences, (5) Philosophy and (6) Political Science. These were subdivided into thirty-two classes; and in the voluminous index which accompanies the work a further attempt was made to bring the searcher into still closer touch with the individual items treated. Thus, the category Heaven is subdivided into four classes, namely—again, for want of better terms—(a) The Sky and its Manifestations, (b) The Seasons, (c) Astronomy and Mathematics and (d) Natural Phenomena. Under these classes come the individual items; and here it is that the foreign student is often at a loss. For instance, class *a* includes Earth, in its cosmogonic sense, as the mother of mankind; Heaven, in its original sense of God; the Dual Principle in nature; the Sun, Moon and Stars; Wind; Clouds; Rainbow; Thunder and Lightning; Rain; Fire, &c. But Earth is itself a geographical category; and all strange phenomena relating to many of the items under class *a* are recorded under class *d*. Category No. 6, marked as Political Science, contains such classes as Ceremonial, Music and Administration of Justice, alongside of Handicrafts, making it essential to study the arrangement carefully before it is possible to consult the work with ease. Such preliminary trouble is, however, well repaid, the amount of information given on any particular subject being practically coextensive with what is known about that subject. The method of presenting such information, with variations to suit the nature of the topics handled, is to begin with historical excerpts, chronologically arranged. These are usually followed by sometimes lengthy essays dealing with the subject as a theme, taken from the writings of qualified authors, and like all the other entries, also chronologically arranged. Then come elegant extracts in prose and verse, in all of which the subject may be simply mentioned and not treated as in the essays. After these follow minor notices of incidents, historical and otherwise, and all kinds of anecdotes, derived from a great variety of sources. Occasionally, single poetical lines are brought together, each contributing some thought or statement germane to the subject, expressed in elegant or forcible terms; and also, wherever practicable, biographies of men and women are inserted.

Chronological and other tables are supplied where necessary, as well as a very large number of illustrations, many of these being reproductions of woodcuts from earlier works. It is said that the *T'u Shu Chi Ch'eng* was printed from movable copper type cast by the Jesuit Fathers employed by the emperor K'ang Hsi at Peking; also that only a hundred copies were struck off, the type being then destroyed. An 8vo edition of the whole encyclopaedia was issued at Shanghai in 1889; this is bound up in sixteen hundred and twenty-eight handy volumes of about two hundred pages each. A copy of the original edition stands on the shelves of the British Museum, and a translation of the Index has recently been completed.

Manuscripts and Printing.—At the conclusion of this brief survey of Chinese literature it may well be asked how such an enormous and ever-increasing mass has been handed down from generation to generation. According to the views put forth by early Chinese antiquarians, the first written records were engraved with a special knife upon bamboo slips and wooden tablets. The impracticability of such a process, as applied to books, never seems to have dawned upon those writers; and this snowball of error, started in the 7th century, long after the knife and the tablet had disappeared as implements of writing, continued to gather strength as time went on. Recent researches, however, have placed it beyond doubt that when the Chinese began to write in a literary sense, as opposed to mere scratchings on bones, they traced their characters on slips of bamboo and tablets of wood with a bamboo pencil, frayed at one end to carry the coloured liquid which stood in the place of ink. The knife was used only to erase. So things went on until about 200 B.C., when it would appear that a brush of hair was substituted for the bamboo pencil; after which, silk was called into requisition as an appropriate vehicle in connexion with the more

delicate brush. But silk was expensive and difficult to handle, so that the invention of paper in A.D. 105 by a eunuch, named Ts'ai Lun, came as a great boon, although it seems clear that a certain kind of paper, made from silk floss, was in use before his date. However that may be, from the 1st century onwards the Chinese have been in possession of the same writing materials that are in use at the present day.

In A.D. 170, Ts'ai Yung, who rose subsequently to the highest offices of state, wrote out on stone in red ink the authorized text of the Five Classics, to be engraved by workmen, and thus handed down to posterity. The work covered forty-six huge tablets, of which a few fragments are said to be still in existence. A similar undertaking was carried out in 837, and the later tablets are still standing at a temple in the city of Hsi-an Fu, Shensi. With the T'ang dynasty, rubbings of famous inscriptions, wherein the germ of printing may be detected, whether for the style of the composition or for the calligraphic excellence of the script, came very much into vogue with scholars and collectors. It is also from about the same date that the idea of multiplying on paper impressions taken from wooden blocks seems to have arisen, chiefly in connexion with religious pictures and prayers. The process was not widely applied to the production of books until the 10th century, when in A.D. 932 the Confucian Canon was printed for the first time. In 981 orders were issued for the *T'ai Ping Kuang Chi*, an encyclopaedia extending to many volumes (see above) to be cut on blocks for printing. Movable types of baked clay are said to have been invented by an alchemist, named Pi Shêng, about A.D. 1043; and under the Ming dynasty, 1368-1644, these were made first of wood, and later of copper or lead, but movable types have never gained the favour accorded to block-printing, by means of which most of China's great typographical triumphs have been achieved. The process is, and always has been, the same all over China. Two consecutive pages of a book, separated by a column containing the title, number of section, and number of leaf, are written out and pasted face downwards on a block of wood (*Lindera tzü-mu*, Hemsl.). This paper, where not written upon, is cut away with sharp tools, leaving the characters in relief, and of course backwards, as in the case of European type. The block is then inked, and an impression is taken off, on one side of the paper only. This sheet is then folded down the middle of the separating column above mentioned, so that the blank halves come together, leaving two pages of printed matter outside; and when enough sheets have been brought together, they are stabbed at the open ends and form a volume, to be further wrapped in paper or pasteboard, and labelled with title, &c. It is almost superfluous to say that the pages of a Chinese book must not be cut. There is nothing inside, and, moreover, the column bearing the title and leaf-number would be cut through. The Chinese newspapers of modern times are all printed from movable types, an ordinary fount consisting of about six to seven thousand characters.

See J. Legge, *The Chinese Classics* (1861-1872); A. Wylie, *Notes on Chinese Literature* (1867); E. Chavannes, *Mémoires historiques* (1895-1905); H. A. Giles, *Chuang Tzû* (1889), *A Chinese Biographical Dictionary* (1898), and *A History of Chinese Literature* (1901); A. Forke, *Lun-Hêng* (1907); F. Hirth, *The Ancient History of China* (1908); L. Giles, *Sun Tzû* (1910). (H. A. G.)

CHINA, the common name for ware made of porcelain, given because it came from China, where the first vitrified, translucent, white ware was produced. The Portuguese or Italians gave it the name of "porcelain" (*q.v.*). English usage was influenced by India and the East, where the Persian *chini* was widely prevalent as the name of the ware. This is seen also in some of the earlier forms and pronunciations, e.g. *chinea*, *cheney*, and later *chaney* (see CERAMICS; and for "china-clay" KAOLIN).

CHINANDEGA, or **CHINENDEGA**, the capital of the department of Chinandega in western Nicaragua, 10 m. N.N.E. of the seaport of Corinto by the Corinto-Managua railway. Pop. (1900) about 12,000. Chinandega is the centre of a fertile corn-producing district, and has a large transit trade owing to its excellent situation on the chief Nicaraguan railway. Its manufactures include

coarse cloth, pottery and Indian feather ornaments. Cotton, sugar-cane and bananas are cultivated in the neighbourhood.

CHI-NAN FU, the capital of Shan-tung, China, in 36° 40' N., 117° 1' E. Pop. about 100,000. It is situated in one of the earliest settled districts of the Chinese empire. The city, which lies in the valley of the present channel of the Yellow river (Hwang-Ho), and about 4 m. south of the river, is surrounded by a triple line of defence. First is the city wall, strongly built and carefully guarded, outside this a granite wall, and beyond this again a mud rampart. Three springs outside the west gate throw up streams of tepid water to a height of about 2 ft. This water, which is highly prized for its healing qualities, fills the moat and forms a fine lake in the northern quarter of the city.

Chi-nan Fu was formerly famous for its manufacture of silks and of imitation precious stones. It is now the chief commercial entrepôt of Western Shan-tung but no longer a manufacturing centre. A highway connects it with the Yellow river, and it is joined by a railway 280 m. long to Kiaochow. The city has a university for instruction on Western lines, and an efficient military school. American Presbyterians began mission work in the city in 1873; it is also the see of a Roman Catholic bishop.

CHINCHA ISLANDS, three small islands in the Pacific Ocean, about 12 m. from the coast of Peru (to which country they belong), opposite the town of Pisco, and 106 m. distant from Callao, in 13° 38' S., 76° 28' W. The largest of the group, known as the North Island or Isla del Norte, is only four-fifths of a mile in length, and about a third in breadth. They are of granitic formation, and rise from the sea in precipitous cliffs, worn into countless caves and hollows, which furnish convenient resting-places for the sea-fowl. Their highest points attain an elevation of 113 ft. The islands have yielded a few remains of the Chincha Indian race. They were formerly noted for vast deposits of guano, and its export was begun by the Peruvian government in 1840. The supply, however, was exhausted in 1874. In 1853-1854 the Chincha Islands were the chief object in a contest known as the Guano War between President Echenique and General Castilla, and in April 1864 they were seized by the Spanish rear-admiral Pinzon in order to bring the Peruvian government to apologize for its treatment of Spanish immigrants.

CHINCHEW, or **CHUNCHU**, the name usually given in English charts to an ancient and famous port of China in the province of Fu-kien, of which the Chinese name is *Ch'üanchow-fu* or *Ts'üanchow-fu*. It stands in 24° 57' N., 118° 35' E. The walls have a circuit of 7 or 8 m., but embrace much vacant ground. The chief exports are tea and sugar, tobacco, china-ware, nan-keens, &c. There are remains of a fine mosque, founded by the Arab traders who resorted thither. The English Presbyterian Mission has had a chapel in the city since about 1862. Beyond the northern branch of the Min (several miles from the city) there is a suburb called Loyang, approached by the most celebrated bridge in China.

Ch'üanchow, owing to the obstruction of its harbour by sand banks, has been supplanted as a port by Amoy, and its trade is carried on through the port of Nghanhai. It is still, however, a large and populous city. It was in the middle ages the great port of Western trade with China, and was known to the Arabs and to Europeans as *Zaitûn* or *Zayton*, the name under which it appears in Abulfeda's geography and in the Mongol history of Rashiddudin, as well as in Ibn Batuta, Marco Polo and other medieval travellers. Some argument has been alleged against the identity of Zayton with Ch'üanchow, and in favour of its being rather Changchow (a great city 60 m. W.S.W. of Ch'üanchow), or a port on the river of Changchow near Amoy. "Port of Zayton" may have embraced the great basin called Amoy Harbour, the chief part of which lies within the *Fu* or department of Ch'üanchow; but there is hardly room for doubt that the Zayton of Marco Polo and Abulfeda was the Ch'üanchow of the Chinese. Ibn Batuta informs us that a rich silk texture made here was called *Zaitûniya*, and there can be little doubt that this is the real origin of the word "Satin," *Zellani* in medieval Italian, *Accyluni* in Spanish.

CHINCHILLA, a small grey hopping rodent mammal (*Chinchilla lanigera*), of the approximate size of a squirrel, inhabiting the eastern slopes of the Andes in Chile and Bolivia, at altitudes between 8000 and 12,000 ft. It typifies not only the genus *Chinchilla*, but the family *Chinchillidae*, for the distinctive features of which see RODENTIA. The ordinary chinchilla is about 10 in. in length, exclusive of the long tail, and in the form of its head somewhat resembles a rabbit. It is covered with a dense soft fur $\frac{3}{4}$ in. long on the back and upwards of an inch in length on the sides, of a delicate French grey colour, darkly mottled on the upper surface and dusky white beneath; the ears being long, broad and thinly covered with hair. Chinchillas live in burrows, and these subterranean dwellings undermine the ground in some parts of the Chilean Andes to such an extent as to cause danger to travellers on horseback. They associate in communities, forming their burrows among loose rocks, and coming out to feed in the early morning and towards sunset. They feed chiefly on roots and grasses, in search of which they often travel considerable distances; and when eating they sit on their haunches, holding their food in their fore-paws. The Indians in hunting them employ the grison (*Galictis vittata*), a member of the weasel family, which is trained to enter the crevices of the rocks where the chinchillas lie concealed during the day. The fur (*q.v.*) of this rodent was prized by the ancient Peruvians, who made coverlets and other articles with the skin, and at the present day the skins are exported in large numbers to Europe, where they are made into muffs, tippets and trimmings. That chinchillas have not under such circumstances become rare, if not extinct, is owing to their extraordinary fecundity, the female usually producing five or six young twice a year. They are docile in disposition, and thus well fitted for domestication. The Peruvian chinchilla (*C. brevicaudata*) is larger, with relatively shorter ears and tail; while still larger species constitute the genus *Lagidium*, ranging from the Andes to Patagonia, and distinguished by having four in place of five front-toes, more pointed ears, and a somewhat differently formed skull. (See also VISCACIA). (R. L.)*

CHINDE, a town of Portuguese East Africa, chief port for the Zambezi valley and British Central Africa, at the mouth of the Chinde branch of the Zambezi, in 18° 40' S., 36° 30' E. Pop. (1907) 2790, of whom 218 were Europeans. Large steamers are unable to cross the bar, over which the depth of water varies from 10 to 18 ft. Chinde owes its existence to the discovery in 1889 that the branch of the river on the banks of which it is built is navigable from the ocean (see ZAMBEZI). The Portuguese in 1891 granted on lease for 99 years an area of 5 acres—subsequently increased to 25—to the British government, on which goods in transit to British possessions could be stored duty free. This block of land is known as the British Concession, or British Chinde. The prosperity of the town largely depends on the transit trade with Nyasaland and North East Rhodesia. There is also a considerable export from Portuguese districts, sugar, cotton and ground nuts being largely cultivated in the Zambezi valley, and gold and copper mines worked.

CHINDWIN, a river of Burma, the largest tributary of the Irrawaddy, its entire course being in Burmese territory. It is called Ningthi by the Manipuris. The Chindwin is formed by the junction of the Tanai, the Tawan and the Tarôn or Turông, but it is still uncertain which is the main stream. The Tanai has hitherto been looked on as the chief source. It rises in about 25° 30' N. and 97° E., on the Shwedaung-gyi peak of the Kumôn range, 12 m. N. of Mogaung, and flows due N. for the first part of its course until it reaches the Hukawng valley, when it turns to the W. and flows through the middle of the plain to the end of the valley proper. There it curves round to the S., passes through the Tarôn or Turông valley, takes the name of the Chindwin, and maintains a general southerly course until it enters the Irrawaddy, after flowing through the entire length of the Upper and Lower Chindwin districts, in about 21° 30' N. and 95° 15' E. Its extreme outlets are 22 m. apart, the interval forming a succession of long, low, partially populated islands. The most southerly mouth of the Chindwin is, according to

tradition, an artificial channel, cut by one of the kings of Pagān. It was choked up for many centuries until in 1824 it was opened out by an exceptional flood. The Tanai (it is frequently called Tanaikha, but *kha* is merely the Kachin word for river), as long as it retains that name, is a swift, clear river, from 50 to 300 yds. wide and from 3 to 15 ft. deep. The river is navigated by native boats in the Hukawng valley, but launches cannot come up from the Chindwin proper because of the reefs below Taro.

The Tarôn, Turông or Towang river seems to be the real main source of the Chindwin. It flows into the Hukawng valley from the north, and has a swift current with a succession of rapids. Its sources are in the hills to the south of Sadiya, rising from 10,000 to 11,000 ft. above sea-level. It flows through a deep valley, with a general E. and W. direction, as far as its junction with the Loglai. It then turns S., and after draining an intricate system of hills, breaks into the Hukawng valley a few miles N. of Saraw, and joins or receives the Tanai about 10 m. above Kintaw village. Except the Tanai, the chief branches of the Upper Chindwin rise in mountains that are covered at least with winter snows. Below the Hukawng valley the Chindwin is interrupted at several places by falls or transverse reefs. At the village of Haksa there is a fall, which necessitates transhipment from large boats to canoes. Not far below this the Uyu river comes in on the left bank at Homalin, and from this point downwards the steamers of the Irrawaddy Flotilla Company ply for the greater part of the year. The Uyu flows through a fertile and well-cultivated valley, and during the rainy season it is navigable for a distance of 150 m. from its mouth by steamers of light draught. Ordinarily regular steam communication with Homalin ceases in the dry weather, but from Kindat, nearly 150 m. below it, there are weekly steamers all the year round. Below Kindat the only considerable affluent of the Chindwin is the Myit-tha, which receives the Chin hills drainage. The Chindwin rises considerably during the rains, but in March and April it is here and there so shallow as to make navigation difficult even for small steam launches. Whirlpools and narrows and shifting sandbanks also give some trouble, but much has been done to improve navigation since the British annexation. Kindat, the headquarters of the Upper Chindwin district, and Môngywa of the Lower, are on the banks of the river. (J. G. Sc.)

CHINDWIN, UPPER and LOWER, two districts in the Sagaing division of Upper Burma. Upper Chindwin has an area of 19,062 sq. m., and a population, according to the census of 1901, of 154,551. Lower Chindwin has an area of 3480 sq. m., and a population of 276,383. Upper Chindwin lies to the north of the lower district, and is bounded on the N. by the Chin, Nāga and Kachin hills; on the E. they are bounded by the Myitkyina, Katha and Shwebo districts; Lower Chindwin is bounded on the S. by the Pakòkku and Sagaing districts; and both districts are bounded on the W. by the Chin hills, and by Pakòkku on the southern stretch. The western portion of both districts is hilly, and the greater part of Upper Chindwin is of the same character. Both have valuable teak forests. The total rainfall averages in Lower Chindwin 27 and in Upper Chindwin 60 in. Coal exists in extensive fields, but these are not very accessible. Rice forms the great crop, but a certain amount of til-seed and of indigo is also cultivated. Kindat, a mere village, is the headquarters of the upper district, and Môngywa, with a population of 7869, of the lower. Both are on the Chindwin river, and are served by the steamers of the Irrawaddy Flotilla Company. Alôn, close to Môngywa, and formerly the headquarters, is the terminus of the railway from Sagaing westwards, which was opened in 1900.

CHINESE PAVILLON; TURKISH CRESCENT, TURKISH JINGLE, or JINGLING JOHNNY (Fr. *chapeau chinois*; Ger. *türkischer Halbmond*, *Schellenbaum*; Ital. *cappello cinese*), an instrument of percussion of indefinite sonorosity, *i.e.* not producing definite musical tones. The *chapeau chinois* was formerly an adjunct in military bands, but never in the orchestra, where an instrument of somewhat similar shape, often confused with it and known as the *Glockenspiel* (*q.v.*), is occasionally called into requisition. The Chinese pavillon consists of a pole about 6 ft. high terminating in a conical metal cap or pavillon, hung with small jingling bells and surmounted by a crescent and a star. Below this pavillon are two or more metal bands forming a fanciful double crescent or squat lyre, likewise furnished with tiny bells. The two points of the crescent are curved over, ending in fanciful animal heads from whose mouths hang low streaming tails of horse-hair. The Chinese pavillon is played by shaking or waving the pole up and down and jingling the bells, a movement which can at best be but a slow one repeated once or

at most twice in a bar to punctuate the phrases and add brilliancy to the military music. The Turkish crescent or "jingling Johnny," as it was familiarly called in the British army bands, was introduced by the Janissaries into western Europe. It has fallen into disuse now, having been replaced by the glockenspiel or steel harmonica. Edinburgh University possesses two specimens.¹ In the 18th century at Bartholomew Fair one of the chief bands hired was one well known as playing in London on winter evenings in front of the Spring-Garden coffee house and opposite Wigley's. This band consisted of a double drum, a Dutch organ (see BARREL-ORGAN), a tambourine, a violin, pipes and the Turkish jingle.² (K. S.)

CHINGFORD, an urban district in the Epping parliamentary division of Essex, England, 10½ m. N. of London (Liverpool Street station) by the Great Eastern railway. Pop. (1901) 4373. It lies between the river Lea and the western outskirts of Epping Forest. The church of All Saints has Early English and Perpendicular remains. Queen Elizabeth's or Fair Mead hunting lodge, a picturesque half-timbered building, is preserved under the Epping Forest Preservation Act. A majestic oak, one of the finest trees in the Forest, stands near it. Buckhurst Hill (an urban district; pop. 4786) lies to the N.E.

CHINGLEPUT, or **CHENGALPAT**, a town and district of British India, in the Madras presidency. The town, situated 36 m. by rail from Madras, had a population in 1901 of 10,551. With Chandragiri in North Arcot, Chingleput was once the capital of the Vijayanagar kings, after their overthrow by the Mussulmans at Talikota in 1565. In 1639 a chief, subject to these kings, granted to the East India Company the land on which Fort St George now stands. The fort built by the Vijayanagar kings in the 16th century was of strategic importance, owing to its swampy surroundings and the lake that flanked its side. It was taken by the French in 1751, and was retaken in 1752 by Clive, after which it proved invaluable to the British, especially when Lally in his advance on Madras left it unreduced in his rear. During the wars of the British with Hyder Ali it withstood his power, and afforded a refuge to the natives; and in 1780, after the defeat of Colonel W. Baillie, the army of Sir Hector Munro here found refuge. The town is noted for its manufacture of pottery, and carries on a trade in rice.

The DISTRICT OF CHINGLEPUT surrounds the city of Madras, stretching along the coast for about 115 m. The administrative headquarters are at Saidapet. Area, 3079 sq. m. Pop. (1901) 1,312,122, showing an increase of 9% in the decade. Salt is extensively manufactured all along the coast. Cotton and silk weaving is also largely carried on, and there are numerous indigo vats, tanneries and an English cigar factory.

CHIN HILLS, a mountainous district of Upper Burma. It lies on the border between the Lushai districts of Eastern Bengal and Assam and the plains of Burma, and has an area of 8000 sq. m. It is bounded N. by Assam and Manipur, S. by Arakan, E. by Burma, and W. by Tippera and the Chittagong hill tracts. The Chins, Lushais and Kukis are to the north-east border of India what the Pathan tribes are to the north-west frontier. In 1895 the Chin Hills were declared a part of the province of Burma, and constituted a scheduled district which is now administered by a political officer with headquarters at Falam. The tract forms a parallelogram 250 m. from N. to S. by 100 to 150 m. wide. The country consists of a much broken and contorted mass of mountains, intersected by deep valleys. The main ranges run generally N. to S., and vary in height from 5000 to 9000 ft., among the most important being the Letha or Tang, which is the watershed between the Chindwin and Manipur rivers; the Imbukklang, which divides the Sokte tribe from the Whenchs and sheds the water from its eastern slopes into Upper Burma and that from its western slopes into Arakan; and the Rongklang, which with its prolongations is the main watershed of the southern hills, its eastern slopes draining into the Myittha and thus into the Chindwin, while the western fall drains into the

Boinu river, which winding through the hills discharges itself eventually in the Bay of Bengal. The highest peak yet discovered is the Liklang, between Rawywa and Lungno, some 70 m. S. of Haka (nearly 10,000 ft.).

It is supposed that the Kukis of Manipur, the Lushais of Bengal and Assam, and the Chins originally lived in Tibet and are of the same stock; their form of government, method of cultivation, manners and customs, beliefs and traditions all point to one origin. The slow speech, the serious manner, the respect for birth and the knowledge of pedigrees, the duty of revenge, the taste for and the treacherous method of warfare, the curse of drink, the virtue of hospitality, the clannish feeling, the vice of avarice, the filthy state of the body, mutual distrust, impatience under control, the want of power of combination and of continued effort, arrogance in victory, speedy discouragement and panic in defeat, are common traits. The Chins, Lushais and Kukis were noted for the secrecy of their plans, the suddenness of their raids, and their extraordinary speed in retreating to their fastnesses. After committing a raid they have been known to march two days and two nights consecutively without cooking a meal or sleeping, so as to escape from any parties which might follow them. The British, since the occupation of Upper Burma, have been able to penetrate the Chin-Lushai country from both sides at once. The pacification of the Chin Hills is a triumph for British administration. Roads, on which Chin coolies now readily work, have been constructed in all directions. The rivers have been bridged; the people have taken up the cultivation of English vegetables, and the indigenous districts have been largely developed. The Chin Hills had a population (1901 census) of 87,189, while the Chins in Burma totalled 179,292. The Pakokku Chin Hills, which form a separate tract, have an area of 2260 sq. m.; pop. (1901) 13,116. (J. G. Sc.)

CHINKIANG, or **CHEN-KIANG-FU**, a treaty port of China, in the province of Kiang-su, on the Yangtze-kiang above Shanghai, from which it is distant 160 m. It is in railway communication both with Shanghai and Nanking (40 m. distant), and being at the point where the Grand Canal running N. and S. intersects the Yangtze, which runs E. and W., is peculiarly well situated to be a commercial entrepôt. The total value of exports and imports for 1904 was £4,632,992; estimated pop. 168,000. In the war of 1842 it yielded to the British only after a desperate resistance. It was laid waste by the T'ai-p'ing rebels in 1853, and was recaptured by the imperial forces in 1858.

CHINO-JAPANESE WAR (1894-95). The causes of this conflict arose out of the immemorial rivalry of China and Japan for influence in Korea. In the 16th century a prolonged war in the peninsula had ended with the failure of Japan to make good her footing on the mainland—a failure brought about largely by lack of naval resources. In more modern times (1875, 1882, 1884) Japan had repeatedly sent expeditions to Korea, and had fostered the growth of a progressive party in Seoul. The difficulties of 1884 were settled between China and Japan by the convention of Tientsin, wherein it was agreed that in the event of future intervention each should inform the other if it were decided to despatch troops to the peninsula. Nine years later the occasion arose. A serious rebellion induced the Korean government to apply for military assistance from China. Early in June 1894 a small force of Chinese troops were sent to Asan, and Japan, duly informed of this action, replied by furnishing her minister at Seoul with an escort, rapidly following up this step by the despatch of about 5000 troops under Major-General Oshima. A complicated situation thus arose. Chinese troops were present in Korea by the request of the government to put down rebellion. The Japanese controlled the capital, and declined to recognize Korea as a tributary of China. But she proposed that the two powers should unite to suppress the disturbance and to inaugurate certain specified reforms. China considered that the measures of reform must be left to Korea herself. The reply was that Japan considered the government of Korea "lacking in some of the elements which are essential to responsible independence." By the middle of July war had become inevitable unless the Peking government were willing to abandon all claims over Korea, and as Chinese troops were already in the country by invitation, it was not to be expected that the shadowy suzerainty would be abandoned.

At Seoul the issue was forced by the Japanese minister, who delivered an ultimatum to the Korean government on the 20th of July. On the 23rd the palace was forcibly occupied. Meanwhile China had despatched about 8000 troops to the Yalu river.

¹ See Captain C. R. Day, *Descriptive Catalogue of Musical Instruments* (London, 1891), p. 233.

² See Hone's *Everyday Book*, i. 1248.

The outbreak of war thus found the Japanese in possession of Seoul and ready to send large forces to Korea, while the Chinese occupied Asan (about 40 m. south of the capital), and had a considerable body of troops in Manchuria in addition to those despatched to the Yalu river. To Japan the command of the sea was essential for the secure transport and supply of her troops. Without it the experience of the war of the 16th century would be repeated. China, too, could only utilize overland routes to Korea by submitting to the difficulties and delays entailed. To both powers the naval question was thus important.

By the time war was finally declared (August 1) hostilities had already begun. On the 25th of July Oshima set out from Seoul to attack the Chinese at Asan. On the 29th he won a victory at Söng-hwan, but the Chinese commander escaped with a considerable part of his forces by a détour to Ping-Yang (Phyong-Yang). Meanwhile a portion of the Japanese fleet had encountered some Chinese warships and transports off Phung-Tao, and scored an important success, sinking, amongst other vessels, the transport "Kowshing" (July 25). The loss of more than 1000 Chinese soldiers in this vessel materially lightened Oshima's task. The intention of the Chinese to crush their enemies between their forces at Asan and Ping-Yang was completely frustrated, and the Japanese obtained control of all southern Korea.

Reinforcements from Japan were now pouring into Korea, in spite of the fact that the rival navies had not yet tried conclusions, and General Nozu, the senior Japanese officer present, soon found himself in a position to move on Ping-Yang. Three columns converged upon the place on the 15th of September, and in spite of its strong walls carried it, though only after severe fighting.

Nearly all the troops on either side had been conveyed to the scene of war by sea, though the decisive contest for sea supremacy was still to be fought. The Chinese admiral Ting with the Northern Squadron (which alone took part in the war) had hitherto remained inactive in Wei-hai-wei, and on the other side Vice-Admiral Ito's fleet had not directly interfered with the hostile transports which were reinforcing the troops on the Yalu. But two days after the battle of Ping-Yang, Ting, who had conveyed a large body of troops to the mouth of the Yalu, encountered the Japanese fleet on his return journey off Hai-Yang-Tao on the 17th of September. The heavy battleships "Chen-Yuen" and "Ting-Yuen" constituted the strongest element of the Chinese squadron, for the Japanese, superior as they were in every other factor of success, had no vessels which could compare with these in the matter of protection. Ting advanced in a long irregular line abreast; the battleships in the centre, the lighter vessels on the wings. Ito's fast cruisers steamed in line ahead against the Chinese right wing, crushing their weaker opponents with their fire. In the end the Chinese fleet was defeated and scattered, but the two heavy battleships drew off without serious injury. This battle of the Yalu gave Japan command of the sea, but Ito continued to act with great caution. The remnants of the vanquished fleet took refuge in Port Arthur, whence after repairs Ting proceeded to Wei-hai-wei.

The victory of Ping-Yang had cleared Korea of the Chinese troops, but on the lower Yalu—their own frontier—large forces threatened a second advance. Marshal Yamagata therefore took the offensive with his 1st army, and on the 24th and 25th of October, under great difficulties—though without serious opposition from the enemy—forced the passage of the river and occupied Chiulien-cheng. Part of the Chinese force retired to the north-east, part to Feng-hwang-cheng and Hsiu-yuen (Siu-Yen). The Japanese 1st army advanced several columns towards the mountains of Manchuria to secure its conquests and prepare for a future advance. General Tachimi's brigade occupied Feng-hwang-cheng on the 29th of October. On the 7th of November a column from the Yalu took Takushan, and a few days later a converging attack from these two places was made upon Hsiu-yuen, which was abandoned by the Chinese. Meanwhile Tachimi, skirmishing with the enemy on the Mukden and Liao-Yang roads, found the Chinese in force. A simultaneous forward move by both sides led to the action of Tsao-ho-ku (November 30), after which both sides withdrew—the Chinese to the line of the mountains covering Hai-cheng, Liao-Yang and Mukden, with the Tatar general Ikotenga's force, 14,000 strong, on the Japanese right north-east of Feng-hwang-cheng; and the Japanese to Chiulien-cheng, Takushan and Hsiu-yuen. The difficulties of supply in the hills were almost insurmountable, and no serious advance was intended by the Japanese until January 1895, when it was to be made in co-operation with the 2nd army. This army, under Marshal Oyama, had been formed in September and at first sent to Chemulpo as a support to the forces under Yamagata; but its chief task was the siege and capture of the Chinese fortress, dockyard and arsenal of Port Arthur.

The Liao-Tong peninsula was guarded by the walled city of Kinchow and the forts of Ta-lien-wan (Dalny under the Russian régime, and Tairen under the Japanese) as well as the fortifications around Port Arthur itself. On the 24th of October the disembarkation of the 2nd army began near Pi-tsze-wo, and the successive columns of the Japanese gradually moved towards Kinchow, which

was carried without difficulty on the 6th of November. Even less resistance was offered by the modern forts of Ta-lien-wan. The Japanese now held a good harbour within a few miles of the main fortress. Here they landed siege artillery, and on the 17th of November the advance was resumed. The attack was made on the 19th at dawn. Yamaji's division (Nogi's and Nishi's brigades) after a trying night march assaulted and carried the western defences and moved upon the town. Hasegawa in the centre, as soon as Yamaji began to appear in rear of his opponents in the northern forts, pushed home his attack with equal success, and by 3 P.M. practically all resistance was at an end. The Japanese paid for this important success with but 423 casualties. Meanwhile the Chinese general Sung, who had marched from Hai-cheng to engage the 2nd army, appeared before Kinchow, where he received on the 22nd a severe repulse at the hands of the Japanese garrison. Marshal Oyama subsequently stationed his advanced guard towards Hai-cheng, the main body at Kinchow, and a brigade of infantry at Port Arthur. Soon after this overtures of peace were made by China; but her envoy, a foreigner unfurnished with credentials, was not received by the Tokyo government.

The Japanese 1st army (now under General Nozu) at Antung and Feng-hwang-cheng prepared, in spite of the season, to move across the mountains, and on the 3rd of December General Katsura left Antung for Hai-cheng. His line of march was by Hsi-mu-cheng, and strong flank guards followed parallel routes on either side. The march was accomplished safely and Hai-cheng occupied on the 13th of December. In the meantime Tachimi had moved northward from Feng-hwang-cheng, in order to distract the attention of the Chinese from Hai-cheng, and there were some small engagements between this force and that of Ikotenga, who ultimately retired beyond the mountains to Liao-Yang. Sung had already left Kai-ping to secure Hai-cheng when he heard of the fall of that place; his communications with Ikotenga being now severed, he swerved to the north-west and established a new base at Niu-chwang. Once on his new line Sung moved upon Hai-cheng. As it was essential that he should be prevented from joining forces with Ikotenga, General Katsura marched out of Hai-cheng to fight him. At Kang-wang-tsai (December 19th) the Chinese displayed unusual steadiness, and it cost the Japanese some 343 casualties to dislodge the enemy. The victors returned to Hai-cheng exhausted with their efforts, but secure from attack for some time to come. The advanced troops of the 2nd army (Nogi's brigade) were now ready to advance, and only the Kai-ping garrison (left behind by Sung) barred their junction with Katsura. At Kai-ping (January 10th) the resistance of the Chinese was almost as steady as at Kang-wang-tsai, and the Japanese lost 300 killed and wounded in their successful attack. In neither of these actions was the defeated force routed, nor did it retire very far. On the 17th of January and again on the 22nd Ikotenga attacked Hai-cheng from the north, but was repulsed.

Meanwhile the 2nd army, still under Oyama, had undertaken operations against Wei-hai-wei, the second great fortress and dockyard of northern China, where Admiral Ting's squadron had been refitting since the battle of the Yalu; and it was hoped that both armies would accomplish their present tasks in time to advance in the summer against Peking itself. On the 18th of January a naval demonstration was made at Teng-chow-fu, 70 m. west of Wei-hai-wei, and on the 19th the Japanese began their disembarkation at Yung-cheng Bay, about 12 m. from Wei-hai-wei. The landing was scarcely opposed, and on the 26th the Japanese advance was begun. The south-eastern defences of Wei-hai-wei harbour were carried by the 6th division, whilst the 2nd division reached the inner waters of the bay, driving the Chinese before them. The fleet under Ito co-operated effectively. On the night of the 4th-5th of February the Chinese squadron in harbour was attacked by ten torpedo boats. Two boats were lost, but the armour-clad "Ting-Yuen" was sunk. On the following night a second attack was made, and three more vessels were sunk. On the 9th the "Ching-Yuen" was sunk by the guns in one of the captured forts. On the 12th Admiral Ting wrote to Admiral Ito offering to surrender, and then took poison, other officers following his example. Wei-hai-wei was then dismantled by the Japanese, who recovered the remnant of the Chinese squadron, including the "Chen Yuen," and the 2nd army concentrated at Port Arthur for the advance on Peking.

While this campaign was in progress the Chinese despatched a second peace mission, also with defective credentials. The Japanese declined to treat, and the mission returned to China. In February the Chinese made further unsuccessful attacks on Hai-cheng. Yamaji near Kai-ping fought a severe action on the 21st, 22nd and 23rd of February at Taping-shan against a part of Sung's army under General Ma-yu-kun. This action was fought with 2 ft. of snow on the ground, the thermometer registering zero F., and no less than 1500 cases of frost-bite were reported. It was the intention of General Nozu, after freeing the Hai-cheng garrison from Ikotenga, to seize Niu-chwang port. Two divisions converged on An-shan-chan, and the Chinese, threatened in front and flank, retired to Liao-Yang. Meanwhile two more attacks on Hai-cheng had been repulsed. The 3rd and 5th divisions then moved on Niu-chwang, and Yamaji's 1st division at Kai-ping joined in the advance. The column from An-shan-chan stormed Niu-chwang, which was obstinately defended, and cost the stormers nearly 400 men. All

three divisions converged on Niu-chwang port (Ying-kow), and the final engagement took place at Tien-chwang-tai, which was captured on the 9th of March. The Chinese forces in Manchuria being thoroughly broken and dispersed, there was nothing to prevent the Japanese from proceeding to the occupation of Peking, since they could, after the break-up of the ice, land and supply large forces at Shan-hai-kwan, within 170 m. of the capital. Two more Japanese divisions were sent out, with Prince Komatsu as supreme commander. Seven divisions were at Port Arthur ready to embark, when negotiations were reopened. Li Hung-Chang proceeded to Shimonoseki, where the treaty was signed on the 17th of April 1895. An expedition was sent towards the end of March to the Pescadores, and later the Imperial Guard division was sent to Formosa.

It is impossible to estimate the Chinese losses in the war. The Japanese lost 4177 men by death in action or by sickness, and 56,862 were wounded or disabled by sickness, exclusive of the losses in the Formosa and Pescadores expeditions. Nearly two-thirds of these losses were incurred by the 1st army in the trying winter campaign in Manchuria.

The most important works dealing with the war are: Vladimir, *China-Japan War* (London, 1896); Jukichi Inouye, *The Japan-China War* (Yokohama, &c., 1896); du Boulay, *Építome of the China-Japanese War* (London, 1896), the official publication of the British War Office; Atteridge, *Wars of the Nineties*, pp. 535-636 (London, 1899); von Kunowski and Fretzdorf, *Der japanisch-chinesische Krieg* (Leipzig, 1895); von Müller, *Der Krieg zwischen China und Japan* (Berlin, 1895); Bujac, *Précis de quelques campagnes contemporaines: II. La Guerre sino-japonaise* (Paris and Limoges).

CHINON, a town of western France, capital of an arrondissement in the department of Indre-et-Loire, on the right bank of the Vienne, 32 m. S.W. of Tours on the State railway. Pop. (1906) 4071. Chinon lies at the foot of the rocky eminence which is crowned by the ruins of the famous castle. Its narrow, winding streets contain many houses of the 15th and 16th centuries. The oldest of its churches, St Mexme, is in the Romanesque style, but only the façade and nave are left. The church of St Etienne dates from the 15th century, that of St Maurice from the 12th, 15th and 16th centuries. The castle, which has undergone considerable modern restoration, consists of three portions. That to the east, the Château de St Georges, built by Henry II. of England, has almost vanished, only the foundation of the outer wall remaining. The Château du Millieu (11th to 15th centuries) comprises the keep, the Pavillon de l'Horloge and the Grand Logis, in the principal apartment of which the first meeting between Joan of Arc and Charles VII. took place. Of the Château du Coudray, which is separated by a moat from the Château du Millieu, the chief remains are the Tour du Moulin (10th century) and two less ancient towers. A statue of Rabelais, who was born in the vicinity of the town, stands on the river-quay. Chinon has trade in wheat, brandy, red wine and plums. Basket and rope manufacture, tanning and cooperage are among its industries. Chinon (Caïno) existed before the Roman occupation of Gaul, and was from early times an important fortress. It was occupied by the Visigoths, and subsequently, after forming part of the royal domain, came to the counts of Touraine and from them to the counts of Anjou. Henry II. often resided in the castle, and died there. The place was taken by Philip Augustus in 1205 after a year's siege.

CHINOOK, a tribe of North American Indians, dwelling at the mouth of the Columbia river, Washington. They were fishermen and traders, and used huge canoes of hollowed cedar trunks. The tribe is practically extinct, but the name survives in the trade language known as "Chinook jargon." This has been analysed as composed of two-fifths Chinook, two-fifths other Indian tongues, and the rest English and Canadian French; but the proportion of English has tended to increase. The Chinookan linguistic family includes a number of separate tribes.

The name **CHINOOK** is also applied to a wind which blows from W. or N. over the slopes of the Rocky Mountains, where it descends as a dry wind warm in winter and cool in summer (cf. *Föhn*). It is due to a cyclone passing northward, and continues from a few hours to several days. It moderates the climate of the eastern Rockies, the snow melting quickly on account of its warmth and vanishing on account of its dryness, so that it is said to "lick up" the snow from the slopes.

See Gill, *Dictionary of Chinook Jargon* (Portland, Ore., 1891); Boas, "Chinook Texts," in *Smithsonian Report*, Bureau of Ethno-

logy (Washington, 1894); J. C. Pilling, "Bibliography of Chinookan Languages," *Smithsonian Report*, Bureau of Ethnology (Washington, 1893); Horatio Hale, *Manual of Oregon Trade Language* (London, 1890); G. C. Shaw, *The Chinook Jargon* (Seattle, 1909); *Handbook of American Indians* (Washington, 1907).

CHINSURA, a town of British India, on the Hugli river, 24 m. above Calcutta, formerly the principal Dutch settlement in Bengal. The Dutch erected a factory here in 1656, on a healthy spot of ground, much preferable to that on which Calcutta is situated. In 1759 a British force under Colonel Forde was attacked by the garrison of Chinsura on its march to Chandernagore, but in less than half an hour the Dutch were entirely routed. In 1795, during the Napoleonic wars, the settlement was occupied by a British garrison. At the peace of 1814 it was restored to the Dutch. It was among the cessions in India made by the king of the Netherlands in 1825 in exchange for the British possessions in Sumatra. Hugli College is maintained by government; and there are a number of schools, several of which are carried on by Scottish Presbyterian missionaries. Chinsura is included in the Hugli municipality.

CHINTZ, a word derived from the Hindu *chint*, spotted or variegated. This name was given to a kind of stained or painted calico produced in India. It is now applied to a highly glazed printed calico, commonly made in several colours on a light ground and used for bed hangings, covering furniture, &c.

CHIOGGIA, a town and episcopal see of Venetia, Italy, in the province of Venice, from which it is 18½ m. S. by sea. Pop. (1901) 21,384 (town), 31,218 (commune). It is inhabited mostly by fishermen, and is situated upon an island at the S. end of the lagoons. It is traversed by one main canal, La Vena. The peculiar dialect and customs of the inhabitants still survive to some extent. It is of earlier origin than Venice, and indeed is probably identical with the Roman Portus Aedro, or Ebro, though its name is derived from the Roman Fossa Claudia, a canalized estuary which with the two mouths of the Meduacus (Brenta) went to form the harbour. In 672 it entered the league of the cities of the lagoons, and recognized the authority of the doge. In 809 it was almost destroyed by Pippin, but in 1110 was made a city, remaining subject to Venice, whose fortunes it thenceforth followed. It was captured after a determined resistance by the Genoese in 1379, but recovered in 1380. Chioggia is connected by rail with Rovigo, 35 m. to the southwest. (T. As.)

Naval War of Chioggia (1378-80).—The naval war of 1378-1380, carried on by Venice against the Genoese and their allies, the lord of Carrara and the king of Hungary, is of exceptional interest as one in which a superior naval power, having suffered disaster in its home waters, and having been invaded, was yet able to win in the end by holding out till its squadrons in distant seas could be recalled for its defence.

When the war began in the spring of 1378, Venice was mainly concerned for the safety of its trading stations in the Levant and the Black Sea, which were exposed to the attacks of the Genoese. The more powerful of the two fleets which it sent out was despatched into the eastern Mediterranean under Carlo Zeno, the bailiff and captain of Negropont. A smaller force was sent to operate against the Genoese in the western Mediterranean, and was placed under the command of Vettor Pisani. The possessions of Venice on the mainland, which were then small, were assailed by Francesco Carrara and the Hungarians. Her only ally in the war, Bernabó Visconti of Milan, gave her little help on this side, but his mercenaries invaded the territory of Genoa. The danger on land seemed trifling to Venice so long as she could keep the sea open to her trade and press the war against the Genoese in the Levant.

During the first stage of the war the plans of the senate were carried out with general success. While Carlo Zeno harassed the Genoese stations in the Levant, Vettor Pisani brought one of their squadrons to action on the 30th of May 1378 off Punta di Anzio to the south of the Tiber, and defeated it. The battle was fought in a gale by 10 Venetian against 11 Genoese galleys. The Genoese admiral, Luigi de' Fieschi, was taken with 5 of his galleys, and others were wrecked. Four of the squadron escaped, and steered for Famagusta in Cyprus, then held by Genoa. If Pisani had directed his course to Genoa itself, which was thrown into a panic by the defeat at Anzio, it is possible that he might have dictated peace, but he thought his squadron too weak, and preferred to follow the Genoese galleys which had fled to Famagusta. During the summer of 1378 he was employed partly in attacking the enemy in Cyprus,

but mainly in taking possession of the Istrian and Dalmatian towns which supported the Hungarians from fear of the aggressive ambition of Venice. He was ordered to winter on the coast of Istria, where his crews suffered from exposure and disease. Genoa, having recovered from the panic caused by the disaster at Anzio, decided to attack Venice at home while the best of her ships were absent with Carlo Zeno. She sent a strong fleet into the Adriatic under Luciano Doria. Pisani had been reinforced early in the spring of 1378, but when he was sighted by the Genoese fleet of 25 sail off Pola in Istria on the 7th of May, he was slightly outnumbered, and his crews were still weak. The Venetian admiral would have preferred to avoid battle, and to check an attack on Venice itself, by threatening the Genoese fleet from his base on the Istrian coast. He was forced into battle by the commissioner (*proveditore*) Michael Steno, who as agent of the senate had authority over the admiral. The Venetians were defeated with the loss of all their galleys except six. Luciano Doria fell in the battle, and the Genoese, who had suffered severely, did not at once follow up their success. On the arrival of his successor, Pietro Doria, with reinforcements, they appeared off the Lido, the outer barrier of the lagoon of Venice, in July, and in August they entered on a combined naval and military attack on the city, in combination with the Carrarese and the Hungarians. The Venetians had closed the passages through the outer banks except at the southern end, at the island of Brondolo, and the town of Chioggia. The barrier here approaches close to the mainland, and the position facilitated the co-operation of the Genoese with the Carrarese and Hungarians, but Chioggia is distant from Venice, which could only be reached along the canals across the lagoon. The Venetians had taken up the buoys which marked the fairway, and had placed a light squadron on the lagoon. The allies, after occupying the island of Brondolo, attacked, and on the 13th of August took the town of Chioggia with its garrison of 3000 men.

There appeared to be nothing to prevent the enemy from advancing to the city of Venice except the difficult navigation of the lagoon. The senate applied for peace, but when the Genoese replied that they were resolved to "bit and bridle the horses of Saint Mark" the Venetians decided to fight to the end. Vettor Pisani, who had been imprisoned after the defeat at Pola, but who possessed the confidence of the people and the affection of the sailors, was released and named commander-in-chief against the wish of the aristocracy. Under his guidance the Venetians adopted a singularly bold and ingenious policy of offensive defence. The heavy Genoese vessels were much hampered by the shallow water and intricate passages through the lagoon. By taking advantage of their embarrassment and his own local knowledge, Pisani carried out a series of movements which entirely turned the tables on the invaders. Between the 23rd and 25th of August he executed a succession of night attacks during which he sank vessels laden with stores not only in the canals leading through the lagoon to Venice, but in the fairways leading from Chioggia to the open sea round both ends of the island of Brondolo. The Genoese were thus shut in at the very moment when they thought they were about to besiege Venice. Pisani stationed the galleys under his command in the open sea outside Brondolo, and during the rest of the year blockaded the enemy closely. The distress of the Venetians themselves was great, but the Doge Andrea Contarini and the nobles set an example by sharing the general hardships, and taking an oath not to return to Venice till they had recovered Chioggia. Carlo Zeno had long since been ordered to return, but the slowness and difficulty of communication and movement under 14th century conditions delayed his reappearance. The besiegers of Chioggia were at the end of their powers of endurance, and Pisani had been compelled to give a promise that the siege would be raised, when Zeno's fleet reached the anchorage off Brondolo on the 1st of January 1380. The attack on Chioggia was now pressed with vigour. The Genoese held out resolutely in the hope of relief from home. But the resources of Genoa had been taxed to fit out the squadrons she had already sent to sea. It was not until the 12th of May 1380 that her admiral, Matteo Maruffo, was able to reach the neighbourhood of Brondolo with a relieving force. By this time the Venetians had recovered the island, and their fleet occupied a fortified anchorage from which they refused to be drawn. Maruffo could do nothing, and on the 24th of June 1380 the defenders of Chioggia surrendered. The crisis of the war was past. Venice, being now safe at home, recovered the command of the sea, and before the close of the year was able to make peace as a conqueror.

AUTHORITIES.—S. Romanin, *Storia documentata di Venezia* (Venice, 1855); W. C. Hazlitt, *History of the Venetian Republic* (London, 1860); Horatio F. Brown, *Venice* (London, 1893). (D. H.)

CHIOS, an island on the west coast of Asia Minor, called by the Greeks *Χίος*, 'σ τῆ Χίο) and by the Turks Saki Adasi; the soft pronunciation of X before ι in modern Greek, approximating to *sh*, caused *Χίος* to be Italianized as Scio. It forms, with the islands of Psara, Nikaria, Leros, Calymnus and Cos, a sanjak of the Archipelago vilayet. Chios is about 30 m. long from N. to S., and from 8 to 15 m. broad; pop. 64,000. It well deserves the epithet "craggy" (*παταλόεσσα*) of the Homeric hymn. Its figs were noted in ancient times, but wine and gum

mastic have always been the most important products. The climate is healthy; oranges, olives and even palms grow freely. The wine grown on the N.W. coast, in the district called by Strabo Ariusia, was known as *vinum Arvisium*. Early in the 7th century B.C. Glaucus of Chios discovered the process of welding iron (*κόλλησις*; see J. G. Frazer's *Pausanias*, note on x. 16. 1, vol. v. pp. 313-314), and the iron stand of a large crater whose parts were all connected by this process was constructed by him, and preserved as one of the most interesting relics of antiquity at Delphi. The long line of Chian sculptors (see GREEK ART) in marble bears witness to the fame of Chian art. In literature the chief glory of Chios was the school of epic poets called Homeridae, who helped to create a received text of Homer and gave the island the reputation of being the poet's birthplace. The chief town, Chios (pop. 16,000), is on the E. coast. A theatre and a temple of Athena Poliuchus existed in the ancient city. About 6 m. N. of the city there is a curious monument of antiquity, commonly called "the school of Homer"; it is a very ancient sanctuary of Cybele, with an altar and a figure of the goddess with her two lions, cut out of the native rock on the summit of a hill. On the west coast there is a monastery of great wealth with a church founded by Constantine IX. Monomachus (1042-1054). Starting from the city and encompassing the island, one passes in succession the promontory Posidium; Cape Phanae, the southern extremity of Chios, with a harbour and a temple of Apollo; Notium, probably the south-western point of the island; Laii, opposite the city of Chios, where the island is narrowest; the town Bolissus (now Volisso), the home of the Homeric poets; Melaena, the north-western point; the wine-growing district Ariusia; Cardamyle (now Cardhamili); the north-eastern promontory was probably named Phium, and the mountains that cross the northern part of the island Pelinaeus or Pellenaeus.

The history of Chios is very obscure. According to Pherecydes, the original inhabitants were Leleges, while according to other accounts Thessalian Pelasgi possessed the island before it became an Ionian state. The name Aethalia, common to Chios and Lemnos in very early times, suggests the original existence of a homogeneous population in these and other neighbouring islands. Oenopion, a mythical hero, son of Dionysus or of Rhadamanthus, was an early king of Chios. His successor in the fourth generation, Hector, united the island to the Ionian confederacy (Pausan. vii. 4), though Strabo (xiv. p. 633) implies an actual conquest by Ionian settlers. The regal government was at a later time exchanged for an oligarchy or a democracy. The names of two tyrants, Amphiclus and Polytecneus, are mentioned. The products of the island were largely exported on the ships of Miletus, with which city Chios formed a close mercantile alliance in opposition to the rival league of Phocaea and Samos. Similar commercial considerations determined the Chians in their attitude towards the Persian conquerors: in 546 they submitted to Cyrus as eagerly as Phocaea resisted him; during the Ionian revolt their fleet of 100 sail joined the Milesians in offering a desperate opposition at Lade (494). The island was subsequently punished with great rigour by the Persians. The Chian ships, under the tyrant Strattis, served in the Persian fleet at Salamis. After its liberation in 479 Chios joined the Delian League and long remained a firm ally of the Athenians, who allowed it to retain full autonomy. But in 413 the island revolted, and was not recaptured. After the Peloponnesian War it took the first opportunity to renew the Athenian alliance, but in 357 again seceded. As a member of the Delian League it had regained its prosperity, being able to equip a fleet of 50 or 60 sail. Moreover, it was reputed one of the best-governed states in Greece, for although it was governed alternately by oligarchs and democrats neither party persecuted the other severely. It was not till late in the 4th century that civil dissension became a danger to the state, leaving it a prey to Idrieus, the dynast of Caria (346), and to the Persian admiral Memnon (333). During the Hellenistic age Chios maintained itself in a virtually independent position. It supported the Romans in their Eastern wars, and was made a "free and allied state." Under Roman and Byzantine rule industry and commerce were undisturbed, its chief export at this time being the Arvisian wine, which had become very popular. After temporary occupations by the Seljuk Turks (1089-1092) and by the Venetians (1124-1125, 1172, 1204-1225), it was given in fief to the Genoese family of Zaccaria, and in 1346 passed definitely into the hands of a Genoese *maona*, or trading company, which was organized in 1362 under the name of "the Giustiniani." This mercantile brotherhood, formerly a privileged class, alone exploited the mastic trade; at the same time the Greeks were allowed to retain their rights of self-government and continued to exercise their industries. In 1415 the Genoese became tributary to the Ottomans. In spite of occasional secessions

which brought severe punishment upon the island (1453, 1479), the rule of the Giustiniani was not abolished till 1566. Under the Ottoman government the prosperity of Chios was hardly affected. But the island underwent severe periods of suffering after its capture and reconquest from the Florentines (1595) and the Venetians (1694-1695), which greatly reduced the number of the Latins. Worst of all were the massacres of 1822, which followed upon an attack by some Greek insurgents executed against the will of the natives. In 1881 Chios was visited by a very severe earthquake in which over 5600 persons lost their lives and more than half the villages were seriously damaged. The island has now recovered its prosperity. There is a harbour at Castro, and steam flour-mills, foundries and tanneries have been established. Rich antimony and calamine mines are worked by a French undertaking, and good marble is quarried by an Italian company.

AUTHORITIES.—Strabo xiv. pp. 632 f.; Athenæus vi. 265-266; Herodotus i. 160-165, vi. 15-31; Thucydides viii. 14-61; *Corpus Inscr. Atticarum*, iv. (2), pp. 9, 10; H. Houssaye in *Revue des deux mondes*, xlvii. (1876), pp. 1 ff.; T. Bent in *Historical Review* (1889), pp. 467-480; Fustel de Coulanges, *L'Île de Chio* (ed. Jullian, Paris, 1893); for coinage, B. V. Head, *Historia numorum* (Oxford, 1887), pp. 513-515, and **NUMISMATICS:** *Greek*. (E. GR.; M. O. B. C.)

CHIPPENDALE, THOMAS (d. 1779), the most famous of English cabinetmakers. The materials for the biography of Chippendale are exceedingly scanty, but he is known to have been the son of Thomas Chippendale I., and is believed to have been the father of Thomas Chippendale III. His father was a cabinet-maker and wood-carver of considerable repute in Worcester towards the beginning of the 18th century, and possibly he originated some of the forms which became characteristic of his son's work. Thus a set of chairs and settees was made, apparently at Worcester, for the family of Bury of Knateshill, at a period when the great cabinetmaker could have been no more than a boy, which are practically identical with much of the work that was being turned out of the family factory as late as the 'sixties of the 18th century. Side by side with the Queen Anne or early Georgian feeling of the first quarter of the 18th century we find the interlaced splats and various other details which marked the Chippendale style. By 1727 the elder Chippendale and his son had removed to London, and at the end of 1749 the younger man—his father was probably then dead—established himself in Conduit Street, Long Acre, whence in 1753 he removed to No. 60 St Martin's Lane, which with the addition of the adjoining three houses remained his factory for the rest of his life. In 1755 his workshops were burned down; in 1760 he was elected a member of the Society of Arts; in 1766 his partnership with James Ranni was dissolved by the latter's death.

It has always been exceedingly difficult to distinguish the work executed in Chippendale's factory and under his own eye from that of the many copyists and adapters who throughout the second half of the 18th century—the golden age of English furniture—plundered remorselessly. Apart from his published designs, many of which were probably never made up, we have to depend upon the very few instances in which his original accounts enable us to earmark work which was unquestionably his. For Claydon House, the seat of the Verneys in Buckinghamshire, he executed much decorative work, and the best judges are satisfied that the Chinese bedroom there was designed by him. At Harewood House, the seat of the earl of Harewood in Yorkshire, we are on firmer ground. The house was furnished between 1765 and 1771, and both Robert Adam and Chippendale were employed upon it. Indeed, there is unmistakable evidence to show that certain work, so closely characteristic of the Adams that it might have been assigned to them without hesitation, was actually produced by Chippendale. This may be another of the many indications that Chippendale was himself an imitator, or it may be that Adam, as architect, prescribed designs which Chippendale's cabinetmakers and carvers executed. Chippendale's bills for this Adam work are still preserved. Stourhead, the famous house of the Hoares in Wiltshire, contains much undoubted Chippendale furniture, which may, however, be the work of Thomas Chippendale III.; at Rowton Castle, Shropshire, Chippendale's bills as well as his works still exist.

Our other main source of information is *The Gentleman and Cabinet Maker's Director*, which was published by Thomas Chippendale in 1754. This book, the most important collection

of furniture designs issued up to that time in England, contains one hundred and sixty engraved plates, and the list of subscribers indicates that the author had acquired a large and distinguished body of customers. The book is of folio size; there was a second edition in 1759, and a third in 1762.

In the rather bombastic introduction Chippendale says that he has been encouraged to produce the book "by persons of distinction and taste, who have regretted that an art capable of so much perfection and refinement should be executed with so little propriety and elegance." He has some severe remarks upon critics, from which we may assume that he had already suffered at their hands. Perhaps, indeed, Chippendale may have been hinted at in the caustic remarks of Isaac Ware, surveyor to the king, who bewailed that it was the misfortune of the world in his day "to see an unmeaning scrawl of C's inverted and looped together, taking the place of Greek and Roman elegance even in our most expensive decorations. It is called French, and let them have the praise of it! The Gothic shaft and Chinese bell are not beyond nor below it in poorness of imitation." It is the more likely that these barbs were intended for Chippendale, since he was guilty not only of many essays in Gothic, but of a vast amount of work in the Chinese fashion, as well as in the flamboyant style of Louis XV. The *Director* contains examples of each of the manners which aroused the scorn of the king's surveyor. Chippendale has even shared with Sir William Chambers the obloquy of introducing the Chinese style, but he appears to have done nothing worse than "conquer," as Alexandre Dumas used to call it, the ideas of other people. Nor would it be fair to the man who, whatever his occasional extravagances and absurdities, was yet a great designer and a great transmuter, to pretend that all his Chinese designs were contemptible. Many of them, with their geometrical lattice-work and carved tracery, are distinctly elegant and effective. Occasionally we find in one piece of furniture a combination of the three styles which Chippendale most affected at different periods—Louis XV., Chinese and Gothic—and it cannot honestly be said that the result is as incongruous as might have been expected. Some of his most elegant and attractive work is derived directly from the French, and we cannot doubt that the inspiration of his famous ribbon-backed chair came directly from some of the more artistic performances in rococo.

The primary characteristic of his work is solidity, but it is a solidity which rarely becomes heaviness. Even in his most lightsome efforts, such as the ribbon-backed chair, construction is always the first consideration. It is here perhaps that he differs most materially from his great successor Sheraton, whose ideas of construction were eccentric in the extreme. It is indeed in the chair that Chippendale is seen at his best and most characteristic. From his hand, or his pencil, we have a great variety of chairs, which, although differing extensively in detail, may be roughly arranged in three or four groups, which it would sometimes be rash to attempt to date. He introduced the cabriole leg, which, despite its antiquity, came immediately from Holland; the claw and ball foot of ancient Oriental use; the straight, square, uncompromising early Georgian leg; the carved lattice-work Chinese leg; the pseudo-Chinese leg; the fretwork leg, which was supposed to be in the best Gothic taste; the inelegant rococo leg with the curled or hooped foot; and even occasionally the spade foot, which is supposed to be characteristic of the somewhat later style of Hepplewhite. His chair-backs were very various. His efforts in Gothic were sometimes highly successful; often they took the form of the tracery of a church window, or even of an ovalled rose window. His Chinese backs were distinctly geometrical, and from them he would seem to have derived some of the inspiration for the frets of the glazed book-cases and cabinets which were among his most agreeable work. The most attractive feature of Chippendale's most artistic chairs—those which, originally derived from Louis Quinze models, were deprived of their rococo extravagances—is the back, which, speaking generally, is the most elegant and pleasing thing that has ever been done in furniture. He took the old solid or slightly pierced back, and cut it up into a light openwork design.

exquisitely carved—for Chippendale was a carver before everything—in a vast variety of designs ranging from the elaborate and extremely elegant, if much criticized, ribbon back, to a comparatively plain but highly effective splat. His armchairs, however, often had solid or stuffed backs. Next to his chairs Chippendale was most successful with settees, which almost invariably took the shape of two or three conjoined chairs, the arms, backs and legs identical with those which he used for single seats. He was likewise a prolific designer and maker of book-cases, cabinets and escritaires with doors glazed with fretwork divisions. Some of those which he executed in the style which in his day passed for Gothic are exceedingly handsome and effective. We have, too, from his hand many cases for long clocks, and a great number of tables, some of them with a remarkable degree of Gallic grace. He was especially successful in designing small tables with fretwork galleries for the display of china. His mirrors, which were often in the Chinese taste or extravagantly rococo, are remarkable and characteristic. In his day the cabinetmaker still had opportunities for designing and constructing the four-post bedstead, and some of Chippendale's most graceful work was lavished upon the woodwork of the lighter, more refined and less monumental four-poster, which, thanks in some degree to his initiative, took the place of the massive Tudor and the funereally hung Jacobean bed. From an organ case to a washhand-stand, indeed, no piece of domestic furniture came amiss to this astonishing man, and if sometimes he was extravagant, grotesque or even puerile, his level of achievement is on the whole exceedingly high.

Since the revival of interest in his work he has often been criticized with considerable asperity, but not always justly. Chippendale's work has stood the supreme test of posterity more completely than that of any of his rivals or successors; and, unlike many men of genius, we know him to have been warmly appreciated in his lifetime. He was at once an artist and a prosperous man of business. His claims to distinction are summed up in the fact that his name has by general consent been attached to the most splendid period of English furniture.

Chippendale was buried on the 13th of November 1779, apparently at the church of St Martin-in-the-Fields, and administration of his intestate estate was granted to his widow Elizabeth. He left four children, Thomas Chippendale III., John, Charles and Mary. He was one of the assignees in bankruptcy of the notorious Theresa Cornelys of Soho Square, of whom we read in Casanova and other scandalous chronicles of the time. Thomas Chippendale III. succeeded to the business of his father and grandfather, and for some years the firm traded under the style of Chippendale & Haig. The factory remained in St Martin's Lane, but in 1814 an additional shop was opened at No. 57 Haymarket, whence it was in 1821 removed to 42 Jermyn Street. Like his father, Thomas Chippendale III. was a member of the Society of Arts; and he is known to have exhibited five pictures at the Royal Academy between 1784 and 1801. He died at the end of 1822 or the beginning of 1823. (J. P.-B.)

CHIPPENHAM, a market town and municipal borough in the Chippenham parliamentary division of Wiltshire, England, 94 m. W. of London by the Great Western railway. Pop. (1901) 5074. Chippenham is governed by a mayor, 4 aldermen and 12 councillors. Area, 361 acres. It lies in a hollow on the south side of the Upper Avon, here crossed by a picturesque stone bridge of 21 arches. St Andrew's church, originally Norman of the 12th century, has been enlarged in different styles. A paved causeway running for about 4 m. between Chippenham Cliff and Wick Hill is named after Maud Heath, said to have been a market-woman, who built it in the 15th century, and bequeathed an estate for its maintenance. After the decline of its woollen and silk trades, Chippenham became celebrated for grain and cheese markets. There are also manufactures of broadcloth, churns, condensed milk, railway-signals, guns and carriages; besides bacon-curing works, flour mills, tanneries and large stone quarries. Bowood, the seat of the marquess of Lansdowne, is $3\frac{1}{2}$ m. S.E. of Chippenham. Lanhill barrow, or Hubba's Low, $2\frac{1}{2}$ m. N.W., is an ancient tomb containing a *kistvaen* or sepulchral

chamber of stone; it is probably British, though tradition makes it the grave of Hubba, a Danish leader.

Chippenham (*Chepeham*, *Chippeham*) was the site of a royal residence where in 853 Æthelwulf celebrated the marriage of his daughter Æthelswitha with Burhred, king of Mercia. The town also figured prominently in the Danish invasion of the 9th century, and in 933 was the meeting-place of the witan. In the Domesday Survey Chippenham appears as a crown manor and is not assessed in hides. The town was governed by a bailiff in the reign of Edward I., and returned two members to parliament from 1295, but it was not incorporated until 1553, when a charter from Mary established a bailiff and twelve burgesses and endowed the corporation with certain lands for the maintenance of two parliamentary burgesses and for the repair of the bridge over the Avon. In 1684 this charter was surrendered to Charles II., and in 1685 a new charter was received from James II., which was shortly abandoned in favour of the original grant. The Representation Act of 1868 reduced the number of parliamentary representatives to one, and the borough was disfranchised by the Redistribution Act of 1885. The derivation of Chippenham from *cyppan*, to buy, implies that the town possessed a market in Saxon times. When Henry VII. introduced the clothing manufacture into Wiltshire, Chippenham became an important centre of the industry, which has lapsed. A prize, however, was awarded to the town for this commodity at the Great Exhibition of 1851.

CHIPPewa FALLS, a city and the county-seat of Chippewa county, Wisconsin, U.S.A., on the Chippewa river, about 100 m. E. of St Paul, Minnesota, and 12 m. N.E. of Eau Claire, Wisconsin. Pop. (1890) 8670; (1900) 8094; (1910, census) 8593. It is served by the Minneapolis, St Paul & Sault Ste Marie, the Chicago & North-Western, and the Chicago, Milwaukee & St Paul railways, and by the electric line to Eau Claire. The first settlement on the site was made in 1837; and the city was chartered in 1870.

CHIPPING CAMPDEN, a market town in the northern parliamentary division of Gloucestershire, England, on the Oxford and Worcester line of the Great Western railway. Pop. (1901) 1542. It is picturesquely situated towards the north of the Cotswold hill-district. The many interesting ancient houses afford evidence of the former greater importance of the town. The church of St James is mainly Perpendicular, and contains a number of brasses of the 15th and 16th centuries and several notable monumental tombs. A ruined manor house of the 16th century and some almshouses complete, with the church, a picturesque group of buildings; and Campden House, also of the 16th century, deserves notice.

Apart from a medieval tradition preserved by Robert de Brunne that it was the meeting-place of a conference of Saxon kings, the earliest record of Campden (*Campdene*) is in Domesday Book, when Earl Hugh is said to hold it, and to have there fifty villeins. The number shows that a large village was attached to the manor, which in 1173 passed to Hugh de Gondeville, and about 1204 to Ralph, earl of Chester. The borough must have grown up during the 12th century, for both these lords granted the burgesses charters which are known from a confirmation of 1247, granting that they and all who should come to the market of Campdene should be quit of toll, and that if any free burgess of Campdene should come into the lord's amerciamient he should be quit for 12d. unless he should shed blood or do felony. Probably Earl Ralph also granted the town a portman-mote, for the account of a skirmish in 1273 between the men of the town and the county mentions a bailiff and implies the existence of some sort of municipal government. In 1605 Campdene was incorporated, but it never returned representatives to parliament. Camden speaks of the town as a market famous for stockings, a relic of that medieval importance as a mart for wool that had given the town the name of Chipping.

CHIPPING NORTON, a market town and municipal borough in the Banbury parliamentary division of Oxfordshire, England, 26 m. N.W. of Oxford by a branch of the Great Western railway.

¹ For the Chippewa Indians see OJIBWAY, of which the word is a popular adaptation.

Pop. (1901) 3780. It lies on the steep flank of a hill, and consists mainly of one very wide street. The church of St Mary the Virgin, standing on the lower part of the slope, is a fine building of the Decorated and Perpendicular periods, the hexagonal porch and the clerestory being good examples of the later style. The town has woollen and glove factories, breweries and an agricultural trade. It is governed by a mayor; 4 aldermen and 12 councillors. Area, 2456 acres. Chipping Norton (*Chepyngnorton*) was probably of some importance in Saxon times. At the Domesday Survey it was held in chief by Ernulf de Heding; it was assessed at fifteen hides, and comprised three mills. It returned two members to parliament as a borough in 1302 and 1304-1305, but was not represented after this date, and was not considered to be a borough in 1316. The first and only charter of incorporation was granted by James I., in 1608; it established a common council consisting of 2 bailiffs and 12 burgesses; a common clerk, 2 justices of the peace, and 2 serjeants-at-mace; and a court of record every Monday. In 1205 William Fitz-Alan was granted a four days' fair at the feast of the Invention of the Cross; and in 1276 Roger, earl of March, was granted a four days' fair at the feast of St Barnabas. In the reign of Henry VI. the market was held on Wednesday, and a fair was held at the Translation of St Thomas Becket. These continued to be held in the reign of James I., who annulled the former two fairs, and granted fairs at the feasts of St Mark, St Matthew, St Bartholomew, and SS. Simon and Jude.

CHIQUITOS (Span. "very small"), a group of tribes in the province of Santa Cruz de la Sierra, Bolivia, and between the head waters of the rivers Mamoré and Itenez. When their country was first invaded they fled into the forests, and the Spaniards, coming upon their huts, the doorways of which are built excessively low, supposed them to be dwarfs: hence the name. They are in fact well formed and powerful, of middle height and of an olive complexion. They are an agricultural people, but made a gallant resistance to the Spaniards for nearly two centuries. In 1691, however, they made the Jesuit missionaries welcome, and rapidly became civilized. The Chiquito language was adopted as the means of communication among the converts, who soon numbered 50,000, representing nearly fifty tribes. Upon the expulsion of the Jesuits in 1767 the Chiquitos became decadent, and now number short of 20,000. Their houses, regularly ranged in streets, are built of adobes thatched with coarse grass. They manufacture copper boilers for making sugar and understand several trades, weave ponchos and hammocks and make straw hats. They are fond of singing and dancing, and are a gentle-mannered and hospitable folk. The group is now divided into forty tribes.

CHIROMANCY (from Gr. *χείρ*, hand, and *μανρεία*, divination), the art of telling the character or fortune of persons by studying the lines of the palms of the hands (see **PALMISTRY**).

CHIRON, or **CHEIRON**, in Greek mythology, one of the Centaurs, the son of Cronus and Philyra, a sea nymph. He dwelt at the foot of Mount Pelion, and was famous for his wisdom and knowledge of the healing art. He offers a remarkable contrast to the other Centaurs in manners and character. Many of the most celebrated heroes of Greece were brought up and instructed by him (Apollodorus iii. 10. 13). Accidentally pierced by a poisoned arrow shot by Heracles, he renounced his immortality in favour of Prometheus, and was placed by Zeus among the stars as the constellation *Sagittarius* (Apollodorus ii. 5; Ovid, *Fasti*, v. 414). In a Pompeian wall-painting he is shown teaching Achilles to play the lyre.

See articles in Pauly-Wissowa's *Realencyclopädie* and W. H. Roscher's *Lexikon der Mythologie*; W. Mannhardt, *Wald- und Feldkulte* (1904).

CHIROPODIST (an invented word from Gr. *χείρ*, hand, and *πούς*, foot), properly one who treats the ailments of the hands

and feet, or is consulted as to keeping them in good condition; the use of the word is now restricted, however, to the care of the toes, "manicurist" having been invented for the corresponding attentions to the fingers. The word was first introduced in 1785, by a "corn-cutter" in Davies Street, London.

CHIROPTERA (Greek for "hand-wings"), an order of mammals containing the bats, all of which are unique in the class in possessing the power of true flight, and have their fore-limbs specially modified for this purpose.

The mammals comprised in this order are at once distinguished by the possession of true wings; this peculiarity being accompanied by other modifications of bodily structure having relation to aerial locomotion. Thus, in direct contrast to all other mammals, in which locomotion is chiefly effected by action from behind, and the hind-limbs consequently greatly preponderate in size over the fore, in the Chiroptera the fore-limbs, being the agents in propelling the body forward during flight, immensely exceed the short and weak hinder extremities. The

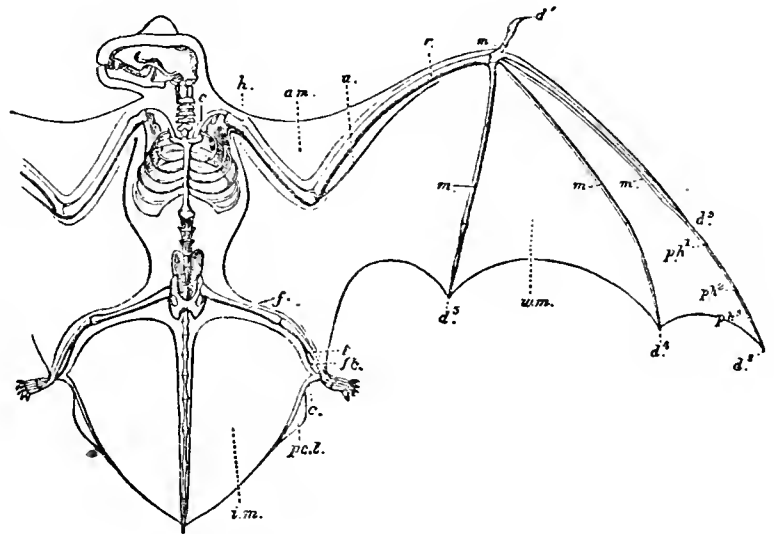

FIG. 1.—Skeleton and Wing-Membranes of the Noctule Bat (*Pipistrellus noctula*).

- | | |
|---|---|
| c, Clavicle. | ph ¹ , First phalanx. |
| h, Humerus. | ph ² , Second phalanx. |
| r, Radius. | ph ³ , Third phalanx. |
| u, Ulna. | am, Antebrachial membrane. |
| d ¹ , First digit. | f, Femur. |
| d ² , d ³ , d ⁴ , d ⁵ , Other digits of the fore-limb supporting <i>um</i> , the wing-membrane. | l, Tibia. |
| m, m, Metacarpal bones. | fb, Fibula. [femoral membrane. |
| | c, Calcar supporting <i>im</i> , the inter- |
| | pc.l, Post-calcarial lobe. |

thorax, giving origin to the great muscles which sustain flight, and containing the proportionately large lungs and heart, is remarkably capacious; and the ribs are flattened and close together; while the shoulder-girdle is greatly developed in comparison with the weak pelvis. The fore-arm (fig. 1) consists of a rudimentary ulna, a long curved radius, and a carpus of six bones supporting a thumb and four elongated fingers, between which, the sides of the body, and the hinder extremities a thin expansion of skin, the wing-membrane, is spread. The knee is directed backwards, owing to the rotation of the hind-limb, outwards by the wing-membrane; an elongated cartilaginous process (the calcar), rarely rudimentary or absent, arising from the inner side of the ankle-joint, is directed inwards, and supports part of the posterior margin of an accessory membrane of flight, extending from the tail or posterior extremity of the body to the hind-limbs, and known as the inter-femoral membrane. The penis is pendent; the testes are abdominal or inguinal; the teats, usually two in number, thoracic; the uterus is simple or with more or less long cornua; the placenta discoidal and deciduate; and the smooth cerebral hemispheres do not extend backwards over the cerebellum. The teeth comprise incisors, canines, premolars and molars; and the dental formula never

exceeds *i.* 3, *c.* 1, *p.* 3, *m.* 3; total 38. Despite the forward position of the teats, which is merely an adaptive feature, bats are evidently mammals of low organization, and are most nearly related to the Insectivora.

In consequence of the backward direction of the knee, a bat, when placed on the ground, rests on all fours, having the knees directed upwards, while the foot is rotated forwards and inwards on the ankle. Walking is thus a kind of shuffle; but, notwithstanding a general belief, bats can take wing from the walking posture.

The bones of the skeleton are characterized by their slenderness and the great size of the medullary canals in those of the extremities. The vertebral column is short, and the vertebrae differ but slightly in number and form throughout the group. The general number of dorso-lumbar vertebrae is 17, whereof 12 are dorsal; the cervical vertebrae are broad, but short. Except in fruit-bats (*Pteropodidae*), the vertebrae, from the third cervical backwards, are devoid of spinous processes. From the first dorsal to the last lumbar the vertebral column forms a single curve, most pronounced in the lumbar region. The bodies of the vertebrae are but slightly movable on each other, and in old individuals become partially welded. The caudal vertebrae are cylindrical bones without processes; their number and length varying in allied species. The development of these vertebrae is correlated with habits, the long tail in the insectivorous species supporting and controlling the position of the interfemoral membrane which aids bats in their doubling motions when in pursuit of insects by acting as a rudder, and assists them in the capture of the larger insects. In the fruit-bats this is not required, and the tail is rudimentary or absent. In all bats the presternum has a prominent keel for the attachment of the great pectoral muscles.

The shape of the skull varies greatly; but post-orbital processes are developed only in some *Pteropodidae* and a few *Nycteridae* and *Emballonuridae*; in *Pteropus leucopterus* alone does a process from the zygomatic arch meet the post-orbital so as to complete the orbital ring. Zygomatic arches, though slender, are present in all except in some of the species of *Phyllostomatidae*.

The milk-teeth differ from those of all other mammals in that they are unlike those of the permanent series. They are slender, with pointed recurved cusps, and are soon shed, but exist for a short time with the permanent teeth. In the *Rhinolophidae* the milk-teeth are absorbed before birth. The permanent teeth exhibit great variety, sometimes even in the same family, as in *Phyllostomatidae*, whilst in other families, as *Rhinolophidae*, the resemblance between the dentition of species differing in many respects is remarkable. In all they are provided with well-developed roots, and their crowns are acutely tuberculate, with more or less well-defined W-shaped cusps, in the insectivorous species, or variously hollowed out or longitudinally grooved in the frugivorous kinds.

The shoulder-girdle varies but slightly, the clavicle being long, strong and curved; and the scapula large, oval and triangular, with a long curved coracoid process. The humerus, though long, is scarcely two-thirds the length of the radius; and the rudimentary ulna is welded with the radius. A sesamoid bone exists in the tendon of the triceps muscle. The upper row of the carpus consists of the united scaphoid, lunar and cuneiform bones.

The "hand" has five digits, the first, fourth and fifth of which consist each of a metacarpal and two phalanges; but in the second and third the number of phalanges is different in certain families. The first digit terminates in a claw, most developed in the frugivorous species, in most of which the second digit is also clawed, although in other bats this and the remaining digits are unarmed.

In the weak pelvis the ilia are long and narrow, while in most species the pubes of opposite sides are loosely united in front in males, and widely separated in females; in the *Rhinolophidae* alone they form a symphysis. Only in the *Molossinae* is there a well-developed fibula; in the rest this bone is either very slender or cartilaginous and ligamentous in its upper third, or

reduced to a small bony process above the heel, or absent. The foot consists of a short tarsus, and of slender, laterally compressed toes, with much-curved claws.

Although the brain is of a low type, probably no animals possess so delicate a sense of touch as Chiroptera. In ordinary bats tactile organs exist, not only in the bristles on the sides of the muzzle, but in the sensitive structures forming the wing-membranes and ears, while in many species leaf-like expansions surrounding the nasal apertures or extending backwards behind them are added. These nose-leaves are made up partly of the extended and thickened integument of the nostrils, and partly of the glandular eminences occupying the sides of the muzzle, in which in other bats the sensitive bristles are implanted.

In no mammals are the ears so developed or so variable in form; in most insectivorous species they are longer than the head, while in the long-eared bat their length nearly equals that of the head and body. The form is characteristic in each of the families; in most the "earlet," or tragus, is large, in some cases extending nearly to the outer margin of the conch; its office appears to be to intensify and prolong the waves of sound by producing undulations in them. In the *Rhinolophidae*, the only family of insectivorous bats wanting the tragus, the auditory bullae reach their greatest size, and the nasal appendages their highest development. In frugivorous bats the ear is simple and but slightly variable. In all bats the ears are extremely mobile, each independently at will.

The oesophagus is narrow, especially in blood-sucking vampires. The stomach presents two types of structure, corresponding respectively to the two divisions of the order, Megachiroptera and Microchiroptera; in the former the pyloric extremity is, with one exception, elongated and folded upon itself, in the latter simple; an exceptional type is met with in the blood-suckers, where the cardiac extremity is elongated, forming a long appendage. The intestine is comparatively short, varying from one and a half to four times the length of the head and body; longest in the frugivorous, shortest in the insectivorous species. In *Rhinopoma* and *Megaderma* a small caecum has been found. The liver is characterized by the great size of the left lateral lobe, which occasionally equals half that of the whole organ; the right and left lateral fissures are usually very deep; in Megachiroptera the spigelian lobe is, with one exception, ill defined or absent, and the caudate is generally large; but in Microchiroptera the former lobe is large, while the caudate is small. The gall-bladder is generally well developed.

In most species the hyoids are simple, consisting of a chain of slender, long, cylindrical bones connecting the basi-hyoid with the skull, while the pharynx is short, and the larynx shallow with feebly developed vocal cords, and guarded by a short pointed epiglottis. In the African epauletted bats, *Epomophorus*, the pharynx is long and capacious, the aperture of the larynx far removed from the fauces, and, opposite to it, opens a canal, leading from the nasal chambers, and extending along the back of the pharynx; the laryngeal cavity is spacious and its walls are ossified; the hyoids are unconnected, except by muscle with the skull; while the cerato-hyals and epi-hyals are cartilaginous and expanded, entering into the formation of the walls of the pharynx, and (in males of some species) supporting the orifices of a pair of air-sacs communicating with the pharynx (fig. 2).

The extent and shape of the wings generally depend on the form of the bones of the fore-limbs, and on the presence or absence of the tail. The wings consist of an "antibrachial membrane," which extends from the point of the shoulder along the humerus and more or less of the fore-arm to the base of the thumb, the metacarpal bone of which is partially or wholly included in it; the "wing-membrane" spread out between the elongated fingers, and extending along the sides of the body to the posterior extremities, generally reaching to the feet; and the "interfemoral membrane," the most variable of all, which is supported between the extremity of the body, the legs and the calcar (fig. 1). The antibrachial and wing membranes are most developed in species fitted only for aerial locomotion which when at rest hang with the body enveloped in the wings;

but in the *Emballonuridae*, and also in the *Molossinae*, which are the best fitted for terrestrial progression, the antebrachial membrane is reduced to a small size, and not developed along the fore-arm, leaving the thumb quite free, while the wing-

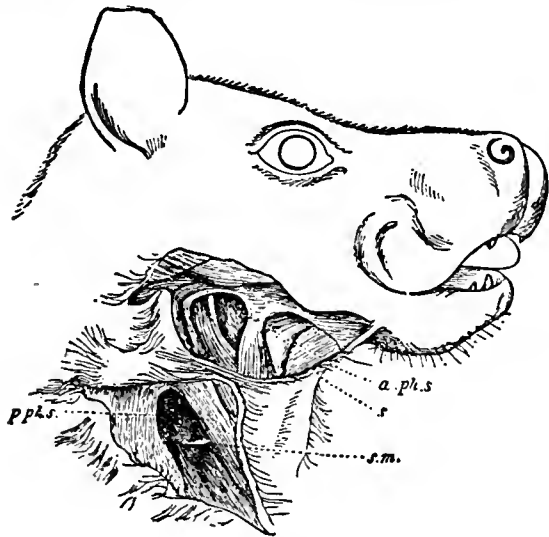

FIG. 2.—Head and Neck of *Epomophorus franqueti* (adult male). From Dobson. The anterior (*a. ph. s.*) and posterior (*p. ph. s.*) pharyngeal sacs are opened from without, the dotted lines indicating the points where they communicate with the pharynx; *s.*, thin membranous partition in middle line between the anterior pharyngeal sacs of opposite sides; *s. m.*, sterno-mastoid muscle separating the anterior from the posterior sac.

membrane is narrow and folded in repose under the fore-arm. The relative development of the interfemoral membrane has been referred to in connexion with the caudal vertebrae. Its small size in the frugivorous and blood-sucking species, which do not



FIG. 3.—Frontal Sac and Nose-Leaf in Male and Female Masked Bat (*Phyllorhina larvata*). From Dobson.

require it, is easily understood. Scent-glands and pouches opening on the surface of the skin are developed in many species, but in most cases more so in males than in females (fig. 3). As a rule, bats produce only a single offspring at a birth, which for some time is carried about by the female parent

clinging to the fur of her breast; but certain North American bats commonly give birth to three or four young ones at a time, which are carried about in the same manner.

Bats are divisible into two suborders, Megachiroptera and Microchiroptera.

Megachiroptera.

The first of these comprises the fruit-eating species, which are generally of large size, with the crowns of the cheek-teeth smooth and marked with a longitudinal groove. The bony palate is continued behind the last molar, narrowing slowly backwards; there are three phalanges in the index finger, the third phalange being terminated generally by a claw; the sides of the ear form a ring at the base; the tail, when present, is inferior to (not contained in) the interfemoral membrane; the pyloric extremity of the stomach is generally much elongated; and the spigelian lobe of the liver is ill-defined or absent, while the caudate is well developed. This group is limited to the tropical and sub-tropical parts of the Eastern Hemisphere.

All the members of this suborder are included in the single family *Pteropodidae*, the first representatives of which are the African epauletted bats, forming the genus *Epomophorus*. In this the dental formula is *i.* $\frac{3}{1}$ (or $\frac{4}{1}$), *c.* $\frac{1}{1}$, *p.* $\frac{3}{1}$, *m.* $\frac{3}{1}$. Tail short or absent, when present free from the interfemoral membrane; second finger with a claw; premaxillae united in front. The species are strictly limited to Africa south of the Sahara, and are distinguished by the large and long head, expansible and often folded lips, and the white tufts of hair on the margins of the ears. The males are provided with glandular pouches, situated in the skin of the side of the neck near the point of the shoulder, which are rudimentary or absent in

females. In the males they are lined with glandular membrane, from which long coarse yellowish hairs project to form conspicuous epaulet-like tufts on the shoulders. The males often have a pair of air-sacs extending outwards on each side from the pharynx beneath the integument of the neck, in the position shown in fig. 2. These bats appear to live principally on figs, the juicy contents of which their voluminous lips and capacious mouths enable them to swallow without loss. The huge and ugly West African hammer-headed bat, *Hypsignathus monstrosus*, represents an allied genus distinguished by the absence of shoulder-pouches, and the presence of leaf-like expansions of skin on the front of the muzzle, and of distinct cusps on the outer sides of the cheek-teeth. The great majority of the bats of this group, commonly known as "flying-foxes," are included in the typical genus *Pteropus*, of which the dental formula is *i.* $\frac{3}{1}$, *c.* $\frac{1}{1}$, *p.* $\frac{3}{1}$, *m.* $\frac{3}{1}$. All are of large size, and the absence of a tail, the long pointed muzzle, and the woolly fur covering the neck render their recognition easy. One of the species, *P. edulis*, inhabiting Java, measures 5 ft. across the fully extended wings, and is the largest member of the order.



FIG. 4.—Head of a Flying-Fox or Fruit-Bat (*Pteropus personatus*). From Gray.

The range of the genus extends from Madagascar through the Seychelles to India, Ceylon, Burma, the Malay Archipelago, Japan, New Guinea, Australia and Polynesia. Although two species inhabit the Comoro Islands, scarcely 200 m. from the mainland, not one is found in Africa; while the common Indian species is closely allied to the Madagascar flying-fox. The Malay Archipelago and Australia form the headquarters of these bats, which in some places occur in countless multitudes. The colonies exhale a strong musky odour, and when awake the occupants utter a loud incessant chatter. Wallace's fruit-bat of Celebes and Macassar has been made the type of a separate genus, as *Styloctenium wallacei*. In *Rousettus* (or *Cynonycteris*) the dentition is as in *Pteropus*, but the tail is short, and the fur of the nape of the neck not different from that of the back: its distribution accords with that of *Pteropus*, except that it includes Africa and does not reach farther east than New Ireland. *R. aegyptiacus* inhabits the chambers of the Great Pyramid and other deserted buildings in Egypt, and is probably the species figured in Egyptian frescoes. *Bonasia*, with two species, from Celebes, differs in having only two upper incisors. *Harpyionycteris* and *Scatonycteris*, respectively from the Philippines and West Africa, are represented by a single species each; but of *Cynopterus*, which is mainly confined to the Indo-Malay countries, there are some half-score different kinds. The dentition is *i.* $\frac{2}{2}$ or $\frac{1}{1}$, *c.* $\frac{1}{1}$, *p.* $\frac{3}{1}$, *m.* $\frac{3}{1}$, the muzzle is

shorter than in *Rousettus*, with the upper lip grooved in front as in *Pteropus*, while the tail and fur resemble those of the former genus. These bats are extremely voracious, a specimen of the Indian *C. marginatus* having eaten a banana twice its own weight in three hours. Among several Austro-Malay genera, such as *Ptenochirus* and *Balionycteris*, the tube-nosed bats of the genus *Gelasinus* (or *Harpyia*) are remarkable for the conformation of the nostrils (fig. 5).

Cephalotes, with one species, ranging from Celebes to the Solomon group, has the dentition *i.* $\frac{1}{1}$, *c.* $\frac{1}{1}$, *p.* $\frac{3}{1}$, *m.* $\frac{3}{1}$, premaxillae not united in front, nostrils simple, muzzle short, index finger without a claw, tail short. As in *Gelasinus*, the wing-membrane arises from the middle line of the back, to which it is attached by a longitudinal thin process of skin; the wings are naked, but the back covered with hair. *Leipenyx* is an allied West African genus with one species.

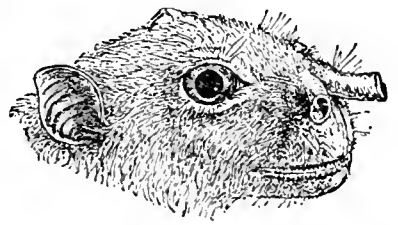

FIG. 5.—Head of Papuan Tube-Nosed Bat (*Gelasinus major*). From G. E. Dobson.

The foregoing belong to the typical subfamily *Pteropodinae*, while the remainder represent a second group, *Carponycterinae* (or *Macroglossinae*), characterized by having the facial part of the skull produced, the molar teeth narrow, and scarcely raised above the gum, and the tongue exceedingly long, attenuated in the anterior third, and armed with long recurved papillae near the tip. The single representative of the first genus, *Notopteris maddonaldi*, inhabiting Fiji, New Guinea and the New Hebrides, is distinguished from other bats of this family by the length of its tail, which is nearly as long

as the forearm. The dentition is $i. \frac{1}{2}, c. \frac{1}{1}, p. \frac{2}{3}, m. \frac{2}{3}$, while the index finger has no claw, and the wings arise from the spine. *Eonycteris*, with the dentition $i. \frac{2}{3}, c. \frac{1}{1}, p. \frac{2}{3}, m. \frac{2}{3}$, is also represented by a single species, *E. spelaea*, from Tenasserim, Burma, and the Malay Peninsula and Islands, which has somewhat the appearance of a *Roussellus*, but the absence of a claw in the index finger and the presence of the characteristic tongue and teeth at once distinguish it. *Carponycteris* (*Macroglossus*) and *Melonycteris*, the former with several and the latter with a single species, are closely allied Indo-Malay and Papuan genera, the index finger in both having a claw, but the number of the teeth being the same as in *Eonycteris*. *C. minimus* is the smallest known species of the suborder, much smaller than the serotine bat of Europe, with the fore-arm scarcely longer than that of the long-eared bat. It is nearly as common in certain parts of Burma as *Cynopterus marginatus*, and extends eastwards through the Malay Archipelago as far as New Ireland, where it is associated with *Melonycteris melanops*, distinguished by its larger size and the total absence of the tail. An allied small *Carpopycteris* inhabits India. *Trygonycteris* (*Megaloglossus*) *woermanni*, of West Africa, is the only member of the group occurring west of the Himalaya. *Callinycteris* of Celebes, with the dentition $i. \frac{2}{3}, c. \frac{1}{1}, p. \frac{2}{3}, m. \frac{2}{3}$, has a short tail and no index-claws, while *Nesonycteris* of the Solomons, with the dentition $i. \frac{2}{3}, c. \frac{1}{1}, p. \frac{2}{3}, m. \frac{2}{3}$, differs by the absence of the tail.

Microchiroptera.

The second and larger suborder, the Microchiroptera, includes all the insectivorous species, the majority of which are of relatively small size as compared with the Megachiroptera. In these *Insect-eating bats.* with a few specialized exceptions, the crowns of the cheek-teeth are surmounted by sharp cusps, divided by transverse grooves. In the skull the bony palate narrows abruptly and is not continued backwards laterally behind the last molar; there is one rudimentary phalange (rarely two or none) in the index finger, which is never terminated by a claw; the outer and inner sides of the ear commence inferiorly from separate points of origin; the tail, when present, is contained in the interfemoral membrane, or appears on its upper surface; the stomach, except in the blood-sucking group, is simple; and the spigelian lobe of the liver large, and the caudate generally small.

The bats included in this suborder are so numerous in genera (to say nothing of species) that only some of the more important types can be mentioned.

Brief references have already been made to the manner in which in many or most of these bats the tail aids in the capture of prey. From the observations of C. Oldham, it appears that these bats, when walking, carry the tail downwards and forwards, so that the membrane connecting this organ with the hind-legs forms a kind of pouch or bag. If a large insect be encountered the bat seizes it with a snatch, and slightly spreading its folded wings and pressing them on the ground in order to steady itself, brings its feet forwards so as to increase the capacity of the tail-pouch, into which, by bending its neck and thrusting its head beneath the body, it pushes the insect. Although the latter, especially if large, will often struggle violently, when once in the pouch it but rarely escapes, from which it is subsequently extracted and devoured. It is assumed that the same method of capture is employed when on the wing; and a naturalist who has observed the long-eared bat picking moths off willows states that the bat always hovers when taking off the moth, and bends up the tail so as to form a receptacle for the insect as it drops.

In the *Rhinolophidae*, Horse-shoe and Leaf-nosed bats of the Old World, the nose-leaf is developed and surrounds the nasal apertures,

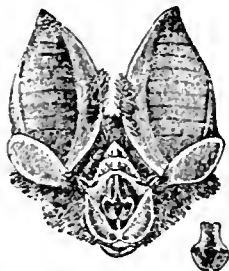

FIG. 6.—Head of Mired Horseshoe Bat (*Rhinolophus mitratus*). From Dobson.

which are situated in a depression on the upper surface of the muzzle so as to look upwards; the ears are large and generally separate, without trace of a tragus or earlet; the premaxillae are rudimentary, suspended from the nasal cartilages, and support a single pair of small incisors; the molars have acute W-shaped cusps; the skull is large, and the nasal bones which support the nose-leaf much expanded vertically and laterally. In females a pair of teat-like appendages are found in front of the pubis; and the long tail extends to the margin of the interfemoral membrane. The middle finger has two phalanges, but the index is rudimentary. The fibula is rudimentary.

The *Rhinolophidae* are the most highly organized insectivorous bats, in which the osseous and cutaneous systems reach the fullest development. Compared with theirs, the bones of the extremities and the wings of other bats appear coarsely formed, and their teeth seem less perfectly fitted to crush the hard bodies of insects. The complicated nasal appendages reach their highest development, and the differences in their form afford characters in the discrimination of the species, which resemble one another closely in dentition and the colour of the fur.

In the first subfamily, *Rhinolophinae*, the first toe has two and the

other toes three phalanges each; and the ilio-pectineal spine is not connected by bone with the antero-inferior surface of the ilium. In the horseshoe bats, *Rhinolophus*, the dentition is $i. \frac{1}{2}, c. \frac{1}{1}, p. \frac{2}{3}, m. \frac{2}{3}$, the nose-leaf has a central process behind and between the nasal orifices, with the posterior extremity lanceolate, and the antitragus large. Among the numerous forms *R. luctus* is the largest, and inhabits elevated hill-tracts in India and Malaysia; *R. hipposiderus* of Europe, extending into south England and Ireland, is one of the smallest; and *R. ferrum-equinum* represents the average size of the species, which are mainly distinguished from one another by the form of the nose-leaf. The last-named species extends from England to Japan, and southward to the Cape of Good Hope, but is represented by a number of local races. When sleeping, the horseshoe bats, at least in some instances, suspend themselves head downwards, with the wings wrapped round the body after the manner of fruit bats. The posture of ordinary bats is quite different, and while the lesser horseshoe (*R. hipposiderus*) alights from the air in an inverted position, other bats, on first coming to rest, do so with the head upwards, and then reverse their position.

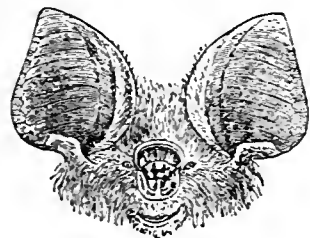

FIG. 7.—Head of Squirrel Leaf-Bat (*Phyllorhina calcarata*). From Dobson.

In the second subfamily, *Hipposiderinae* (formerly called *Phyllorhinae*), the toes are equal and include two phalanges each, while the ilio-pectineal spine is united by a bony isthmus with a process derived from the antero-inferior surface of the ilium. *Hipposiderus*, *Cloëotis*, *Rhinonycteris*, *Triaenops*, *Anthops* and *Coelops* represent this subfamily. *Hipposiderus* (*Phyllorhina*), with many species, ranging over Asia, Africa and Australasia, and the dental formula $i. \frac{1}{2}, c. \frac{1}{1}, p. \frac{2}{3}, m. \frac{2}{3}$, differs from *Rhinolophus* in the form of the nose-leaf, which is not lanceolate behind (fig. 6), and is unprovided with a central process covering the nostrils; the largest species, *H. armiger*, appears to be the most northerly, having been taken at Amoy in China, and in the Himalaya at an elevation of 5500 ft. Many are provided with a frontal sac behind the nose-leaf, rudimentary in females (see fig. 7), which can be everted at pleasure; the sides of this sac secrete a waxy substance, and its extremity supports a tuft of straight hairs. *Rhinonycteris*, represented by *R. aurantia* from Australia, and *Triaenops* by *T. persicus* from Persia and other species from Africa and Madagascar, are closely allied genera. *Triaenops* (fig. 8) is characterized by the remarkable form of its nasal appendages and ears, and the presence of a bony projection from the upper extremity of the second phalange of the fourth finger. *Coelops* (*C. Fritli*), from the Bengal Sanderbans, Java and Siam, is distinguished by the peculiar form of its nose-leaf and the length of the metacarpal bone of the index finger, as well as by the shortness of the calcar and interfemoral membrane. *Cloëotis* is represented by a single East African species, and *Anthops* by one from the Solomon Islands characterized by the nose-leaf covering the whole front of the face.

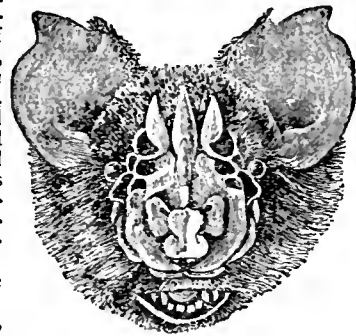

FIG. 8.—Head of Persian Leaf-Bat (*Triaenops persicus*). From Dobson.

The next family, *Nycteridae*, which is also Old World, is a small one, nearly allied to the last, in which it is included by Prof. Max Weber as a subfamily under the name of *Myadermalinae*. It differs by the presence of a small tragus in the ears, which are united at their bases; and by the nasal chamber not being inflated. The premaxillae are either small and separated in front, or rudimentary; and the first phalange of the middle finger when in repose is laid back on the metacarpus. There are only pectoral teats.

Of the two genera, *Megaderma*, as represented by the five species of false vampires, is distinguished by the absence of ossified premaxillae and upper incisors ($i. \frac{1}{2}, p. \frac{2 \text{ or } 1}{2}$), the cylindrical narrow

muzzle surmounted by an erect nose-leaf the base of which conceals the nasal orifices, the immense joined ears with large bifid tragus, and the great extent of the interfemoral membrane, in the base of which the short tail is concealed. *M. gigas* (fig. 9), from central Queensland, is the largest species of the genus, and of the suborder. *M. lyra*, common in India (fore-arm 2.7 in.), has been caught in the act of sucking the blood, while flying, from a small bat which it afterwards devoured. The range of the genus includes Africa, the Indo-Malay countries and Australasia. *Nycteris*, which is common

False
vampires.

to Africa and the Malay Peninsula and Islands, has ossified premaxillae and upper incisors ($i. \frac{2}{2}, p. \frac{3}{3}$), and a long tail, but lacks a nose-leaf. As in *Megaderma*, the frontal bones are deeply hollowed and expanded laterally, the muzzle presents a similar cylindrical form, and the lower jaw also projects; but, instead of a nose-leaf, the face is marked by a deep longitudinal sharp-edged groove ex-

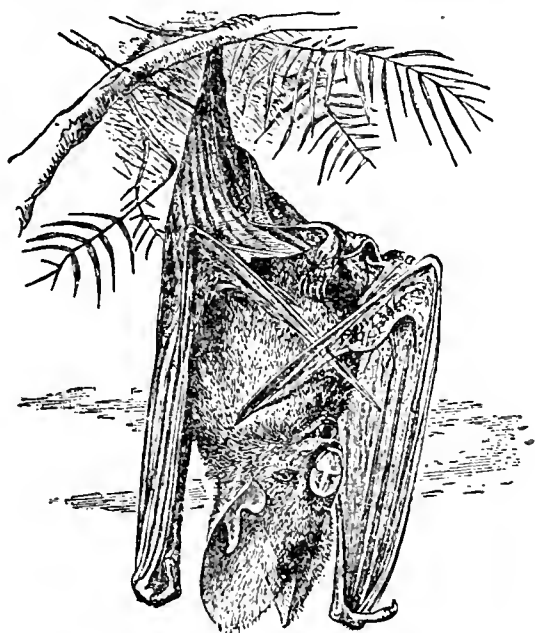

FIG. 9.—The False Vampire (*Megaderma gigas*). From Dobson.

tending from the nostrils to the band connecting the base of the large ears; the sides of this depression being margined as far back as the eyes by small horizontal cutaneous appendages. With the exception of *N. javanica*, the species are limited to Africa.

According to the classification followed by Dr G. E. Dobson, the extensive family of New World bats known as *Phyllostomatidae* was widely sundered from the two preceding groups; but in *Vampires*. Prof. Max Weber's system they are placed next one another—an arrangement which has the great advantage of bringing together all the bats furnished with nose-leaves. It is indeed probable that the vampires, as the members of the present family may be collectively termed, are the New World representatives of the Old World *Rhinolophidae* and *Nycteridae*.

The *Phyllostomatidae* are characterized by the presence of a nose-leaf, or of lappets on the chin, but the nostrils are not directed upwards. The ethmotubular bones of the nasal cavity form simple plates (much as in the two preceding families). The premaxillae are always well developed, with their palatal portions forming a suture and defining the boundaries of distinct palatine foramina (in place of being rudimentary, as in *Nycteridae* and *Rhinolophidae*). The large ears have a tragus. The middle finger has three phalanges, and the index one. There is an incomplete fibula. The tail may be either long or short. Generally the dentition is $i. \frac{2}{2}, c. \frac{1}{1}, p. \frac{3}{3} m. \frac{3}{3}$.

All the bats of this family may be readily recognized by the presence of a well-developed third phalanx in the middle finger,

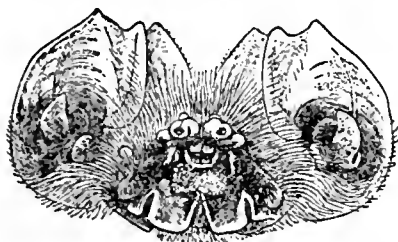

FIG. 10.—Head of Blainville's Vampire (*Mormops blainvilliei*). From Dobson.

with white streaks. A few species, probably all those with the tail and interfemoral membrane well developed, feed principally on insects, while the greater number of the species of the groups *Vampyreae* and *Glossophagae* appear to live on a mixed diet of insects and fruits, and the *Desmodontae*, of which two species are known, are true blood-suckers, and have their teeth and intestinal tract specially modified in accordance with their habits. The group is practically limited to the tropical and subtropical parts of Central and South America, although one species of *Otopterus* reaches Cali-

fornia. In the first subfamily, *Mormopsinae* (*Lobostominae*), the nostrils open by simple apertures at the extremity of the muzzle in front, not margined by a distinct nose-leaf; while, in compensation, the chin is furnished with expanded leaf-like appendages. The tail is short. It includes two genera. In *Chilonycteris* the crown of the head is moderately elevated above the face-line, and the basi-cranial axis is almost in the same plane as the facial, while in *Mormops* (fig. 10) the crown of the head is greatly elevated above the face-line, and the basi-cranial axis is nearly at right angles to the facial; $i. \frac{2}{2}, p. \frac{3}{3}$, in both genera. As regards the species of *Chilonycteris*, the most striking feature is the occurrence of a rufous and a dark brown phase in each. In some the two phases are very marked, but in others they are connected by intermediate shades. Here may be mentioned the two species of tropical American hare-lipped bats, forming the genus *Noctilio*, which presents characters common to this and the following family, to which latter it is often referred. The typical *N. leporinus* is a bat of curious aspect, with strangely folded lips, erect skin-processes on the chin, and enormous feet and claws. The two middle incisors are close together, and so large as to conceal the small outer ones, while in the lower jaw there are but two small incisors; the premolars numbering $\frac{1}{2}$. These bats live near the coast, and feed on small crabs and fishes.

Most of the remaining members of the family are included in the subfamily *Phyllostomatinae*, characterized by the presence of a distinct nose-leaf and the warty chin. The clitoris is imperforate, whereas it is perforated in the *Mormopsinae*. The incisors are generally $\frac{2}{2}$ (occasionally $\frac{1}{1}$), and the molars well developed. The subfamily is divided into a number of groups or sections. The first of them, the *Vampyreae*, is characterized as follows: Muzzle long and narrow in front, the distance between the eyes generally less than (rarely equal to) that from the eye to the extremity of the muzzle; nose-leaf horseshoe-shaped in front, lanceolate behind; interfemoral membrane well developed; tail generally distinct, rarely absent; inner margin of the lips not fringed; $i. \frac{2}{2}$ or $\frac{1}{1}, p. \frac{3}{3}$ or $\frac{2}{2}$; molars with W-shaped cusps, usually well developed.

Nearly all the *Vampyreae* appear to be insectivorous, so that the term cannot be considered indicative of habits; but a few, if not all, probably supplement their insect-diet with fruit. *Vampyrus spectrum* (the largest bat in the New World) is said to be wholly frugivorous, and *Otopterus waterhousei* appears to prey occasionally on smaller bats. The genera may be arranged in two subgroups according as the tail is produced to the margin of the interfemoral membrane or perforates it to appear on its upper surface. In the first division are included three genera, *Lonchorhina*, *Otopterus* (or *Macrotus*) and *Dolichophyllum* (or *Macrophyllum*), the first represented by *L. aurita*, characterized by an extraordinary long nose-leaf, and peculiarly large ears and tragus. In the second subsection are included *Vampyrus*, *Chrotopterus*, *Tonatia* (*Lophostoma*) *Micronycteris*, *Glyphonnycteris*, *Trachyops*, *Phylloderma*, *Phyllostoma*, *Anthorhina* (*Tylostoma*), *Mimon*, *Hemiderma* (*Carollia*) and *Rhinophylla*; all, with the exception of the last, distinguished chiefly by the form of the skull and the presence or absence of the second lower premolar. *Phyllostoma hastatum*, next in point of size to *Vampyrus spectrum*, is a well-known species in South America; *P. elongatum* (fig. 11) differs in its smaller size and larger nose-leaf. *Hemiderma brevicauda*, a small species, closely resembles *Glossophaga soricina*, and forms a connecting link between this and the next group. *Rhinophylla pumilio* is the smallest species of the family; further distinguished by the absence of a tail, the narrowness of its molars, which do not form W-shaped cusps, and the small size of the last upper molar, characters connecting it and the group with the *Stenodermateae*. Both in *Hemiderma* and *Rhinophylla* the zygomatic arch is incomplete.

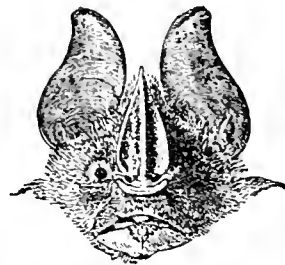

FIG. 11.—Head of Lesser Javelin Vampire (*Phyllostoma elongatum*).

The next subsection, *Glossophagae*, presents the following distinctive features: Muzzle long and narrow; tongue long and extensible, attenuated towards the tip, and beset with long filiform recurved papillae; lower lip with a wide groove above, and in front margined by small warts; nose-leaf small; tail short or none; $i. \frac{2}{2}, p. \frac{3}{3}$ or $\frac{2}{2}, m. \frac{3}{3}$ or $\frac{2}{2}$; teeth narrow; molars with narrow W-shaped cusps, sometimes indistinct or absent; lower incisors small or deciduous. The species included in this group represent some ten genera, distinguished principally by differences in the form and number of the teeth, and the presence or absence of the zygomatic arch of the skull. In *Glossophaga* and *Phyllonycteris* the upper incisors form a continuous row between the canines. In *Mono-phyllus* and *Leptonycteris* (*Isthmoglossa*) they are separated into pairs by a narrow interval in front; while in *Lonchoglossa*, *Glossonycteris* and *Choeronycteris* they are widely separated and placed in pairs near the canines. In the first four of these genera the lower incisors are present (at least to a certain age), in the last three they are deciduous even in youth. The zygomatic arch is wanting in *Phyllonycteris*, *Glossonycteris* and *Choeronycteris*. The typical species is *Glossophaga soricina*, which, as already mentioned, closely resembles *Hemiderma*

brevicauda, both in form and dentition. Its long brush-tipped tongue (which it possesses in common with other species of the group) is used to lick out the pulpy contents of fruits having hard rinds. The food of the species of this group appears to consist of both fruit and insects, and the long tongue may be used for extracting the latter from the deep corollas of flowers. Other genera are *Lonchophylla*, *Rhithronycteris*, *Hylonycteris* and *Lychonycteris*, each with a single species (in 1904).

The third group, *Stenodermateae*, presents the following characteristics:—Muzzle very short and generally broad in front, the distance between the eyes nearly always exceeding (rarely equalling) the distance from the eye to the extremity of the muzzle; nose-leaf

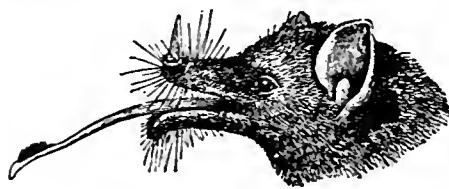

FIG. 12.—Head of Long-tongued Vampire (*Choeronycteris mexicana*), showing brush-tipped tongue. From Dobson.

short, horseshoe-shaped in front, lanceolate behind (except in *Brachyphylla* and *Centurio*); interfemoral membrane concave behind; tail none; inner margin of the lips fringed with conical papillae; $i. \frac{2}{2}$ or $\frac{1}{1}$, $p. \frac{2}{2}$, $m. \frac{2}{2}$ or $\frac{3}{3}$ or $\frac{2}{2}$; cheek-teeth broad (except in *Sturnira*), molars with concave or flat crowns margined externally by raised cutting-edges. Although the *Stenodermateae* are generally easily distinguished from the *Vampyreae* by the shortness and breadth of the muzzle and the form of the cheek-teeth, certain species of the latter resemble the former in external appearance, agreeing almost absolutely in the form of the nose-leaf, the ears and the tragus, and the warts on the chin. These resemblances show that, while the form of the teeth and jaws has become modified to suit the food, the external characters have remained much the same, and indicate the common origin of the two sections. The food of these bats appears to be wholly or in great part fruit. The species are divided into some eleven genera, mostly distinguished by the form of the skull and teeth. *Artibeus* includes the frugivorous *A. perspicillatus*. *Stenoderma achradophilum*, found in Jamaica and Cuba, with the last, from which it is scarcely distinguishable externally except by its much smaller size, differs in the absence of the horizontal plate of the premaxillae on the palate. *Sturnira lilium*, while agreeing with these in the form of the nose-leaf and ears, differs from all the species of the family in its longitudinally-grooved molars, which resemble those of the *Pteropodidae* more closely than those of any other bats; and the presence of tufts of long differently-coloured hairs over glands in the sides of the neck is another character in common with that group. *Centurio senex* (fig. 13) is the type of a small genus distinguished from *Stenoderma* and other genera of this group by the absence of a distinct nose-leaf. Some naturalists make this genus the type of a distinct subgroup, *Centurioneae*. Up to 1904 the genera, exclusive of *Centurio*, included in the *Stenodermateae* were *Artibeus* (with several subgenera), *Vampyrops* (also with subgenera), *Mesophylla*, *Chiroderma*, *Stenoderma* (with 3 subgenera), *Ectophylla*, *Ametrida* (with 2 subgenera), *Pygoderma*, *Sturnira* and *Brachyphylla*.

The third subfamily, *Desmodontieae*, is represented only by the blood-sucking bats, and distinguished by having $i. \frac{1}{1}$, of which the upper pair are cutting, the rudimentary molars, the very short interfemoral membrane, and the blood-sucking habit. They are further characterized as follows: Muzzle short and conical; nose-leaf distinct; $p. \frac{2}{2}$, $m. \frac{1}{1}$ or $\frac{2}{2}$; upper incisors occupying the whole space between the canines; premolars narrow, with sharp-edged longitudinal crowns; molars rudimentary or absent; stomach elongated, and intestiniform.

FIG. 13.—Head of Masked Vampire (*Centurio senex*). From Dobson.

There are two genera, *Desmodus*, without calcar or molars, and *Diphylla*, with a short calcar and a single rudimentary molar on each side—restricted to Central and South America. *Desmodus rufus*, the common species, is a little larger than the noctule bat, and abundant in certain parts of South America, where it is troublesome owing to its attacks upon domestic animals, sucking their blood and leaving them weakened from repeated bleedings. (See VAMPIRE.)

The fourth family of bats, unlike any of the three previous ones, has a cosmopolitan distribution. These free-tailed bats, as they are conveniently called, constituting the family *Emballonuridae*, present the following distinctive features. The nostrils are of normal form and without a nose-leaf. The premaxillae have their palatal portion imperfectly developed, and united by a slender process with the maxillae. The ears are large, with a small tragus. The middle finger has two phalanges, and the index generally a single one. The fibula is incomplete. The tail is generally short, and always partly free from the interfemoral membrane. There is generally only a single pair of

Free-tailed bats.

upper incisors, separated by gaps from the canines, and from one another in the middle line.

The distinctive feature of these bats is the free tail-tip, which pierces the interfemoral membrane to appear on its upper surface, and may project beyond its margin. As a rule, these bats may also be recognized by the peculiar form of the muzzle, which is obliquely truncated, the nostrils projecting more or less in front beyond the lower lip, by the first phalange of the middle finger being folded in repose forwards on the upper surface of the metacarpal bone, and by the upper incisors. Although cosmopolitan, these bats rarely extend north or south of the thirtieth parallels of latitude.

The family may be divided into two subfamilies, of which the *Emballonurinae* is characterized by the incomplete premaxillae, the presence of only one phalange in the index finger, and the short tail. The dental formula is generally $i. \frac{1}{1}$ (sometimes $\frac{2}{2}$ or $\frac{1}{1}$), $c. \frac{1}{1}$, $p. \frac{2}{2}$, $m. \frac{1}{1}$. This subfamily may be further subdivided into subgroups or sections of which the first, *Emballonurinae*, is characterized by the slender tail perforating the interfemoral membrane, so as to appear on its upper surface; the legs long, with a slender fibula; the incisors weak; and the premolars $\frac{2}{2}$. The typical genus *Emballonura* presents the following features: $i. \frac{2}{2}$, extremity of the muzzle more or less produced beyond the lower lip, forehead flat. The genus contains several species, *Emballonura raffrayana*.

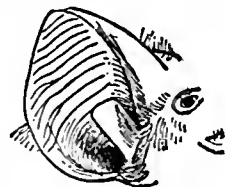

FIG. 14.—Ear of *Emballonura raffrayana*. Inhabiting islands from Madagascar. From Dobson.

through the Malay Archipelago and Siam to the Navigator Islands. *Coleura*, with $i. \frac{1}{1}$, the extremity of the muzzle broad, and the forehead concave, has two species from East Africa and the Seychelles. *Rhynchonycteris* is distinguished from *Coleura* by the produced extremity of the muzzle. The single species, *R. naso*, from Central and South America, is common in the vicinity of streams, where it is usually found during the day resting on the vertical faces of rocks, or on trunks of trees growing over water; it escapes notice owing to the greyish colour of the fur of the body and of small tufts on the antibrachial membrane counterfeiting the weathered surfaces of rocks and bark. As evening approaches it appears on the wing, flying close to the water. *Saccopteryx* has $i. \frac{1}{1}$, and the antibrachial membrane with a pouch opening on its upper surface; it contains several species from Central and South America. This sac is developed only in the male and in the female is rudimentary. In adult males a valvular longitudinal opening occupies the upper surface of the membrane leading into a small pouch, the interior of which is lined with a glandular membrane secreting an unctuous reddish substance with a strong ammoniacal odour. Allied genera are the tropical American *Peropteryx* and the Brazilian *Cormura*. The various species of tomb-bats (*Taphozous*) inhabit the tropical and subtropical parts of all the eastern hemisphere except Polynesia, and are distinguished by the cartilaginous premaxillaries, the deciduous pair of upper incisors, and the presence of only two pairs of lower incisors. Most of the species have a glandular sac (fig. 15) between the angles of the lower jaw, more developed in males than in females, in some species absent in the

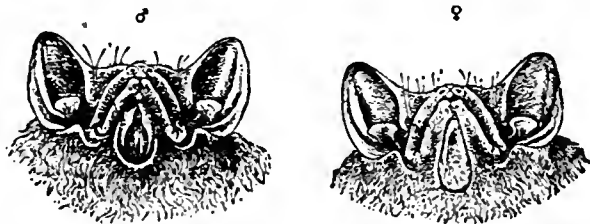

FIG. 15.—Heads of Tomb-Bat (*Taphozous longimanus*), showing relative development of throat-sacs in male and female. From Dobson.

latter. An open throat-sac is wanting in *T. melanopogon*, but about its position are the openings of small pores, the secretion from which probably causes the hairs to grow long, forming the black beard found in many males. The three tropical American white bats, *Dididurus*, with $i. \frac{1}{1}$, $c. \frac{1}{1}$, $p. \frac{2}{2}$, $m. \frac{2}{2}$, resemble *Taphozous* in the form of the head and ears, but, besides other characters, differ from all other bats in possessing a pouch, opening off the centre of the interior surface of the interfemoral membrane; the extremity of the tail enters this, and perforates its base.

The second subfamily of the *Emballonuridae*, *Rhinopomatinae*, is represented only by the genus *Rhinopoma*, with several species ranging from Egypt through Arabia to India, Burma and Sumatra. The premaxillae (fig. 16) are complete; the index finger has two phalanges; the tail is very long and mouse-like; and the dental formula $i. \frac{1}{1}$, $c. \frac{1}{1}$, $p. \frac{2}{2}$, $m. \frac{2}{2}$. Dr G. E. Dobson has remarked that these mouse-tailed bats might be elevated to the rank of a family, for it is difficult to determine their affinities, a kind of cross relationship attaching them to the *Nycteridae* on the one hand and to the *Emballonuridae* on the other. These bats, distinguished from all other *Microchiroptera* by the presence of two phalanges in the index finger.

and the long and slender tail projecting far beyond the narrow inter-femoral membrane, inhabit the subterranean tombs in Egypt and deserted buildings generally from north-east Africa to Burma and Sumatra.

The last group, according to the system adopted by Prof Max Weber, is that of the *Vespertilionidae*, which includes such typical bats as the pipistrelle, the noctule, and the long-eared species. By Mr G. S. Miller¹ the first section of the family—*Natalinae*—is regarded as of family rank, while the last section, or *Molossinae*, is included by Dr G. E. Dobson in the *Emballonuridae*, from the typical forms of which its members differ widely in tail-structure. In this extended sense the family, which has a cosmopolitan distribution, may be defined as follows—The nostrils are normal and without a nose-leaf. The ethmoturbinal bones of the nasal chamber are involuted. The palatine processes of the premaxillae do not form a suture. The ear is mostly large, with a tragus. The middle finger (except in *Thyroptera*) has two phalanges. The fibula is usually rudimentary. The tail is long and does not perforate the interfemoral membrane. The incisors are generally $\frac{2}{3}$ or $\frac{1}{2}$, but may be reduced to $\frac{1}{4}$ in the *Molossinae*.

In the first subfamily, *Natalinae*, which is exclusively tropical American, the other upper incisors are separated from one another and from the canines; palatine processes of the premaxillae are at least partially developed, and the dental formula is $i. \frac{2}{3}, c. \frac{1}{2}, p. \frac{2 \text{ or } 3}{3}, m. \frac{1}{3}$. In general appearance these bats recall the more typical *Vespertilionidae*, although the form of the muzzle is suggestive of the *Mormopsinae* among the *Phyllostomatidae*. Again, while the form of the skull is vespertilionine, the relation of the vomer to the front end of the premaxillae is of the phyllostomine type. The molars and incisors are likewise vespertilionine, whereas the premolars are as distinctly phyllostomine. Finally, while the third, or middle, finger normally has two phalanges, as in typical *Vespertilionidae*, the second of these is elongated and in *Thyroptera* divided into two, as in *Phyllostomatidae*.

The first two genera, *Furipterus* and *Amorphochilus*, each have a single species, the latter being distinguished from the former by the wide separation of the nostrils and the backward prolongation of the palate. In both the crown of the head is elevated, the thumb and first phalange of the middle finger are very short, and the premolars are $\frac{1}{2}$. The same elevation of the crown characterizes the genera *Natalus* and *Chilonatalus* (fig. 17), in which the premolars are $\frac{2}{3}$:

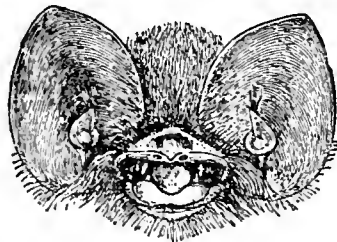

FIG. 17.—Head of *Chilonatalus micropus*. (From Dobson.)

The first two genera, *Furipterus* and *Amorphochilus*, each have a single species, the latter being distinguished from the former by the wide separation of the nostrils and the backward prolongation of the palate. In both the crown of the head is elevated, the thumb and first phalange of the middle finger are very short, and the premolars are $\frac{1}{2}$. The same elevation of the crown characterizes the genera *Natalus* and *Chilonatalus* (fig. 17), in which the premolars are $\frac{2}{3}$:

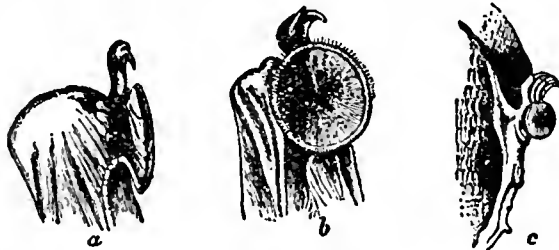

FIG. 18.—Suctorial Disks in *Thyroptera tricolor*. a, side, and b, concave surface, of thumb disk; c, foot with disk, and calcar with projections (all much enlarged). (From Dobson.)

general appearance these bats are very like the Old World vespertilionine genus *Cerivoula*, except for the short triangular tragus. Lastly, *Thyroptera* includes two species distinguished by an additional phalange in the middle finger and by accessory clinging-organs attached to the extremities. In *Thyroptera tricolor*, $i. \frac{2}{3}, p. \frac{2}{3}$, from Brazil, these have the appearance of small, circular, stalked, hollow disks (fig. 18), resembling miniature sucking-cups of cuttle-fishes, and are attached to the inferior surfaces of the thumbs and the soles of the feet. By their aid the bat is able to maintain its hold when creeping over smooth vertical surfaces.

The second or typical subfamily, *Vespertilioninae*, includes all the remaining members of the family with the exception of the aberrant *Molossinae*. The upper incisors are in proximity to the canines, the

premaxillae widely separated; the ears medium or large; the dental formula is $i. \frac{2}{3}$ (or $\frac{1}{2}$), $c. \frac{1}{2}, p. \frac{2}{3}$ ($\frac{2}{3}, \frac{2}{3}$, or $\frac{1}{2}$), $m. \frac{1}{3}$; and the fibula very small and imperfect. All the members of this large cosmopolitan group are closely allied, and differ chiefly by external characters. They may be divided into subgroups. In the first of these, the *Plecoteae*, of which the long-eared bat (*Plecotus auritus*) is the type, the crown of the head is but slightly raised above the face-line, the upper incisors are close to the canines, and the nostrils are margined behind by grooves on the upper surface of the muzzle, or by rudimentary nose-leaves; the ears being generally very large and united. Of the six genera, *Plecotus*, with $i. \frac{2}{3}, p. \frac{2}{3}$, has three species.—one the long-eared European bat referred to above; *P. macrotis*,



FIG. 19.—Head of *Scotophilus emarginatus*. (From Dobson.)

restricted to North America, is distinguished by the great size of the glandular prominences of the sides of the muzzle, which meet in the centre above and behind the nostrils, the third species being also American. The second, *Barbastella*, with $i. \frac{2}{3}, p. \frac{2}{3}$, distinguished by its dentition and by the outer margin of the ear being carried forwards above the mouth and in front of the eye, includes the European barbastelle bat, *B. barbastellus*, and *B. darjelingensis* from the Himalaya. *Ononycteris*, $i. \frac{2}{3}, p.m. \frac{1}{2}$, connecting this group with the *Vespertilioninae*, is represented by *O. hemprichii*, from North Africa and the Himalaya, and an Arabian species. The next two genera are distinguished by the presence of a rudimentary nose-leaf: *Nyctophilus*, $i. \frac{2}{3}, p. \frac{1}{2}$, with three species from Australasia; and *Antrozous*, $i. \frac{1}{2}, p. \frac{1}{2}$, distinguished from all the other members of the subfamily by having but two lower incisors, and from other *Plecoteae* by the separate ears; the two species inhabit California. The sixth genus, *Euderma*, is also represented by a Californian species.

The second group *Vespertilioninae*, with about thirteen genera, includes the great majority of the species; and a large number of these may be classed under *Vespertilio*, which is divisible into subgenera, differing from one another in the number of premolars, and often ranked as separate genera. One group is represented by *V. (Histiotus) magellanicus*, a species remarkable for its extreme southern range, its relatives being also South American. A second group, with $p. \frac{2}{3}$, includes the British serotine, *V. (Eptesicus) serotinus*, of Europe and northern Asia, and represented in North America by the closely allied *V. (E.) fuscus*. In the typical group, which includes the Old World *V. murinus*, one species, *V. borealis*, ranges to the Arctic circle. The European noctule, *V. (Pterogistes) noctula*, and Leisler's bat, *V. (P.) leisleri*, represent another group; and the common pipistrelle, *V. (Pipistrellus) pipistrellus*, yet another, with $p. \frac{2}{3}$. The only other group that need be mentioned is one represented by the North American *V. (Lasionycteris) noctivagans*, with $p. \frac{2}{3}$. The African *Laeophotes*, the Chinese *Ia*, and the Papuan *Philetor* are allied genera, each with a single species. *Chalinolobus* and *Glauconycteris* have the same general dental character as *Vespertilio*, but are distinguished by the presence of a lobe projecting from the lower lip near the gape; the former, with $p. \frac{2}{3}$, is represented by five Australasian species, one of which extends into New Zealand; while the latter, with $p. \frac{1}{2}$, is African. The species of *Glauconycteris* are noticeable for their peculiarly thin membranes traversed by distinct reticulations and parallel lines. *Scotophilus*, with $i. \frac{1}{2}, p. \frac{1}{2}$, includes several species, restricted to the tropical and subtropical regions of the eastern hemisphere, though widely distributed within these limits. These bats, though approaching certain species of *Vespertilio* in many points, are distinguished by the single (in place of two) pair of unicuspidate upper incisors separated by a wide space and placed close to the canines, by the small transverse first lower premolar crushed in between the canine and second premolar, and, generally, by their conical, nearly naked, muzzles and thick leathery membranes. *S. temminckii* is the commonest bat in India, and appears often before the sun has touched the horizon. *S. gigas*, from equatorial Africa, is the largest species. *Nycticejus*, with the same dental formula as *Scotophilus*, is distinguished by the first lower premolar not being crushed in between the adjoining teeth, and the comparatively greater size of the last upper molar. It includes only the North American *N. humeralis (crepuscularis)*, a bat scarcely larger than the pipistrelle. The hairy-membraned bats of the genus *Lasiurus (Atalapha)*, with $i. \frac{2}{3}, p. \frac{2}{3}$ or $\frac{1}{2}$, are also limited to the New World, and generally characterized by the interfemoral membrane being more or less covered with hair and by the peculiar form of the tragus, which is expanded above and abruptly curved inwards. In those species which have two upper premolars the first is extremely small and internal to the tooth-row. The genus, which is divided into *Lasiurus* proper and *Dasypterus*, is further characterized by the presence of four teats in the female, and by the general production



FIG. 20.—Head of *Cerivoula haradwickiei*. (From Dobson.)

¹ Bull. Amer. Mus. Nat. Hist. vol. xii. (1899).

of three or four offspring at a birth. *Rhogessa* and *Tomopeas* are allied tropical American types. *Murina*, with the subgenus *Harptoccephalus*, has $i. \frac{3}{2}$, $p. \frac{3}{2}$, and includes several small bats distinguished by the prominent tube-like nostrils and hairy interfemoral membrane. *M. suilla*, from Java, the Malay and neighbouring islands, is a well-known species, and the closely allied *M. hilgendorfi* is from Japan. The remaining species are from the Himalaya, Tibet and Ceylon, and apparently restricted to the hill-tracts of the countries in which they are found. Next to *Vespertilio* the genus *Myotis* (divisible into several subgenera), with $i. \frac{3}{2}$, $p. \frac{3}{2}$, includes the largest number of species, and has rather a wider geographical distribution in both hemispheres, one species being recorded from the Navigator Islands. The species may be recognized by the peculiar character of the pairs of upper incisors on each side, the cusps of which diverge from each other, by the large number of premolars, of which the second upper is always small, and by the oval elongated ear and narrow tragus. The British *M. bechsteini* and *M. nattereri* are examples of this group. *Cerivoula* (*Kerivoula*), which also has $p. \frac{3}{2}$, is distinguished by the parallel upper incisors and the large second upper premolar. There are numerous African and Indo-Malayan species, of which *C. picta*, from India and Indo-Malay, is characterized by its brilliant orange fur, and membranes variegated with orange and black. The genus includes delicately formed insectivorous, tropical, forest-haunting bats, whose colouring approximates them to the ripe bananas among which they often pass the daytime.

Another subgroup, *Minioplerae*, is represented solely by the genus *Minioplerus*, with $i. \frac{3}{2}$, $p. \frac{3}{2}$. The incisors are separated from one another in front and from the canines; the first phalange of the middle finger is very short, the crown of the head elevated, and the tail long. The genus is represented by some half-dozen Old World species, among which the typical *M. schreibersi* ranges from Europe, southern Asia, and Africa to Japan and Australasia.

The last subfamily is that of the *Molossinae*, included by Dobson in the family *Emballonuridae*. In this group the premaxillae are in contact or but very slightly separated; the ears are large, with the tragus small; the dental formula is $i. \frac{1}{1}$ ($\frac{1}{2}$ or $\frac{3}{2}$), $c. \frac{1}{1}$, $p. \frac{3}{2}$ ($\frac{3}{2}$), $m. \frac{3}{2}$; and the fibula is strongly developed. In their blunt muzzles and many other features these bats undoubtedly resemble the *Emballonuridae*, from the typical members of which they differ by the production of the thick tail far beyond the margin of the interfemoral membrane. They are further characterized by their broad and stout feet, in which the first, and in most cases also the fifth, toe is thicker than the rest, and furnished with long bent hairs; and by the presence of callosities at the base of the thumbs, and a single pair of large upper incisors occupying the centre of the space between the canines. The feet are free from the wing-membrane, which folds up under the fore-arm and legs; the interfemoral membrane is retractile, being movable backwards and forwards along the tail; this power of varying its superficial extent confers on these bats great dexterity in changing the direction of flight. All are able to walk or crawl well, and spend much of their time on trees. The genus *Chiromes*, with $i. \frac{1}{1}$, $c. \frac{1}{1}$, $p. \frac{3}{2}$, $m. \frac{3}{2}$, the first hind-toe much larger than and separate from the others, and the widely sundered ears, is represented by *C. torquata*, a large bat of peculiar aspect, inhabiting the Indo-Malay countries. This species is nearly naked, a collar only of thinly spread hairs half surrounding the neck, and is remarkable for its enormous throat-sac and nursing-pouches. The former consists of a semicircular fold of skin forming a pouch round the neck beneath, concealing the orifices of subcutaneous pectoral glands which discharge an oily fluid of offensive smell. The nursing-pouch is formed on each side by an extension of a fold of skin from the side of the body to the inferior surfaces of the humerus and femur. In the anterior part of this pouch the teat is placed. The typical genus *Molossus* (fig. 21) includes the mastiff-bats, characterized by the dental formula $i. \frac{1}{1}$ or $\frac{1}{2}$, $p. \frac{3}{2}$ or $\frac{3}{2}$; and by the

with one species; while *Nyctinomops* includes a number of tropical American species more nearly related to the next genus, in which some of them (fig. 22) were formerly included. The widely spread *Nyctinomops*, with $i. \frac{1}{2}$ or $\frac{1}{2}$, $p. \frac{3}{2}$ or $\frac{3}{2}$, and the upper incisors separate in front, includes numerous species inhabiting the tropical and subtropical parts of both hemispheres. The lips of the bats of this genus are even more expansible than in *Molossus*, in many of the species (fig. 22) showing vertical wrinkles. *N. tomentosus* (or *castonii*), one of the largest species, alone extends into Europe, as far north as Switzerland. *N. johorensis*, from the Malay Peninsula, is remarkable for the extraordinary form of its ears. *N. brasiliensis* is common in tropical America, and extends as far north as California.

Here may be conveniently noticed two very rare and aberrant bats, *Myzopoda* (or *Myxopoda*) *aurita* of Madagascar, and *Mystacops* (or *Mystacina*) *tuberculatus* of New Zealand, the latter of which is believed to be well-nigh, if not entirely, exterminated. Their systematic position and affinities are somewhat uncertain, but in the opinion of O. Thomas¹ the former should typify a separate family, *Myzopodidae*, in which the latter may also find a place. From all other bats *Myzopoda* is distinguished by the presence of a peculiar mushroom-shaped organ

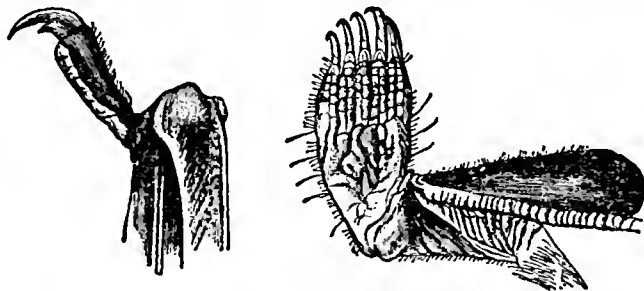

FIG. 23.—Thumb and leg and foot of New Zealand bat (*Mystacops tuberculatus*), enlarged. (From Dobson.)

at the base of the large ear, and by the union of the tragus with the latter, on the inner base of which it forms a small projection. There are three phalanges in the middle finger; and the whole inferior surface of the thumb supports a large scissile horseshoe-shaped adhesive pad, with the circular margin directed forwards and notched along its edge, while a smaller pad occupies part of the sole of the hind-foot. Mr Thomas regards this bat as related on the one hand to the subfamily *Mormopsinae* of the *Phyllostomatidae*, and on the other to the *Natalinae* among the *Vespertilionidae*; both these groups being regarded by him as of family rank.

Mystacops resembles *Myzopoda* in having three phalanges to the middle finger, but differs in that the tail perforates the interfemoral membrane to appear on its upper surface in the manner characteristic of the *Emballonuridae*. The greater part of the wing-membrane is exceedingly thin, but a narrow portion along the fore-arm, the sides of the body, and the legs, is thick and leathery, and beneath this thickened portion the wings are folded. Other peculiarities of structure are found in the form of the claws of the thumbs and toes, each of which has a small heel projecting from its concave surface near the base, also in the sole of the foot and inferior surface of the leg, as shown in fig. 23. The plantar surface, including the toes, is covered with soft and very lax, deeply wrinkled skin, and each toe is marked by a central longitudinal groove with short grooves at right angles to it. The lax wrinkled integument is continued along the inferior flattened surface of the ankle and leg. These peculiarities appear to be related to climbing habits in the species.

Extinct Bats.

Palaeontology tells us nothing with regard to the origin of the Chiroptera, all the known fossil species, some of which date back to the Oligocene, being more or less closely allied to existing types, and therefore of comparatively little interest. The origin of the order from primitive insectivorous mammals must have taken place at least as early as the Lower Eocene. It is, however, noteworthy that several of the earlier extinct species appear to be related to the *Rhinolophidae*, which is the most generalized family of the order. Remains of *Pteropodidae* belonging to existing genera occur in the caves of tropical countries in the eastern hemisphere; and the skeleton of an extinct generic type, *Archaeopteropus*, has been obtained from the Miocene lignite of Italy, which indicates a form to a certain extent transitional in character between typical fruit-bats and the insectivorous bats. The tail, for instance, which in most modern fruit-bats is rudimentary, with only three or four vertebrae, in the fossil has eight complete vertebrae; while the teeth of the

¹ *Proc. Zool. Soc.* (London, 1904), vol. ii.



FIG. 21.—Head of Mastiff-bat (*Molossus glaucinus*). (From Dobson.)

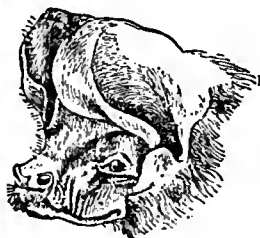

FIG. 22.—Head of *Nyctinomops macrotis*. (From Dobson.)

upper incisors being close together in front. The genus is restricted to the tropical and subtropical regions of the New World. *M. obscurus*, a small species common in tropical America, inhabits the hollow trunks of palms and other trees and the roofs of houses. The males and females live apart (as is the case in most if not all bats). In West Africa the mastiff-bats are represented by *Eomops*,

extinct form are distinctly cusped. Whether, however, the tail is longer than in the existing *Nolopterus* of Fiji and New Guinea, or whether the molars are more distinctly cusped than is the case with the Solomon Island *Pteropus* (*Pteralopex*), is not stated. Still, the fact that the Miocene fruit-bat does show certain signs of approximation to the insectivorous (and more generalized) section of the order is of interest. Of the Oligocene forms, *Pseudorhinolophus* of Europe is apparently a member of the *Rhinolophidae*, but the affinities of *Alastor* and *Vespertilianus*, which are likewise European, are more doubtful, although the latter may be related to *Taphozous*. The North American *Vespertilio* (*Vesperugo*) *anemophilus* and the European *V. aquensis* and *V. parisiensis* are, on the other hand, members of the *Vespertilionidae*, the last being apparently allied to the serotine (*V. serotinus*).

AUTHORITIES.—The above article is based to some extent on the article in the 9th edition of this work by G. E. Dobson, whose British Museum "Catalogue" is, however, now obsolete. Professor H. Winge's "Jordfundae og nulevende Flagermus (Chiroptera)," published in *E. Mus. Lunds* (Copenhagen, 1892), contains much valuable information; and for *Pteropodidae* Dr P. Matschie's *Megachiroptera* (Berlin, 1899), should be consulted. For the rest the student must refer to numerous papers by G. M. Allen, K. Andersen, F. A. Jentink, G. S. Miller, T. S. Palmer, A. G. Rehn, O. Thomas and others, in various English and American zoological serials, all of which are quoted in the volumes of the *Zoological Record*. (R. L.*)

CHIRU, a graceful Tibetan antelope (*Pantholops Hodgsoni*), of which the bucks are armed with long, slender and heavily-ridged horns of an altogether peculiar type, while the does are hornless. Possibly this handsome antelope may be the original of the mythical unicorn, a single buck when seen in profile looking exactly as if it had but one long straight horn. Although far from uncommon, chiru are very wary, and consequently difficult to approach. They are generally found in small parties, although occasionally in herds. They inhabit the desolate plateau of Tibet, at elevations of between 13,000 and 18,000 ft., and, like all Tibetan animals, have a firm thick coat, formed in this instance of close woolly hair of a grey fawn-colour. The most peculiar feature about the chiru is, however, its swollen, puffy nose, which is probably connected with breathing a highly rarefied atmosphere. A second antelope inhabiting the same country as the chiru is the goa (*Gazella plicicaudata*), a member of the gazelle group characterized by the peculiar form of the horns of the bucks and certain features of coloration, whereby it is markedly distinguished from all its kindred save one or two other central Asian species. The chiru, which belongs to the typical or antilopine section of antelopes, is probably allied to the saiga. (R. L.*)

CHIRURGEON, one whose profession it is to cure disease by operating with the hand. The word in its original form is now obsolete. It derives from the Mid. Eng. *cirurgien* or *sirurgien*, through the Fr. from the Gr. *χειρουργός*, one who operates with the hand (from *χείρ*, hand, *εργον*, work); from the early form is derived the modern word "surgeon." "Chirurgeon" is a 16th century reversion to the Greek origin. (See SURGERY.)

CHISEL (from the O Fr *cisel*, modern *ciseau*, Late Lat. *cisellum*, a cutting tool, from *cadere*, to cut), a sharp-edged tool for cutting metal, wood or stone. There are numerous varieties of chisels used in different trades; the carpenter's chisel is wooden-handled with a straight edge, transverse to the axis and bevelled on one side; stone masons' chisels are bevelled on both sides, and others have oblique, concave or convex edges. A chisel with a semicircular blade is called a "gouge." The tool is worked either by hand-pressure or by blows from a hammer or mallet. The "cold chisel" has a steel edge, highly tempered to cut unheated metal. (See TOOL.)

CHISLEHURST, an urban district in the Sevenoaks parliamentary division of Kent, England, 11½ m. S.E. of London, by the South-Eastern & Chatham railway. Pop (1901) 7429. It is situated 300 ft. above sea-level, on a common of furze and heather in the midst of picturesque country. The church of St Nicholas (Perpendicular with Early English portions, but much restored) has a tomb of the Walsingham family, who had a lease of the manor from Elizabeth, Sir Francis Walsingham,

the statesman, being born here in 1536. Another statesman of the same age, Sir Nicholas Bacon, was born here in 1510. Near the church is an ancient cockpit. The mortuary chapel attached to the Roman Catholic church of St Mary was built to receive the body of Napoleon III., who died at Camden Place in 1873; and that of his son was brought hither in 1879. Both were afterwards removed to the memorial chapel at Farnborough in Hampshire. Camden Place was built by William Camden, the antiquary, in 1609, and in 1765 gave the title of Baron Camden to Lord Chancellor Pratt. The house was the residence not only of Napoleon III., but of the empress Eugénie and of the prince imperial, who is commemorated by a memorial cross on Chislehurst Common. The house and grounds are now occupied by a golf club. There are many villa residences in the neighbourhood of Chislehurst.

CHISWICK, an urban district in the Ealing parliamentary division of Middlesex, England, suburban to London, on the Thames, 7½ m. W. by S. of St Paul's cathedral. Pop (1901) 29,809. The locality is largely residential, but there are breweries, and the marine engineering works of Messrs Thornycroft on the river. Chiswick House, a seat of the duke of Devonshire, is surrounded by beautiful grounds; here died Fox (1806) and Canning (1827). The gardens near belonged till 1903 to the Royal Horticultural Society. The church of St Nicholas has ancient portions, and in the churchyard is the tomb of William Hogarth the painter, with commemorative lines by David Garrick. Hogarth's house is close at hand. Chiswick Hall, no longer extant, was formerly a country seat for the masters and sanatorium for the scholars of Westminster school. Here in 1811 the Chiswick Press was founded by Charles Whittingham the elder, an eminent printer (d. 1840).

CHITA, a town of east Siberia, capital of Transbaikalia, on the Siberian railway, 500 m. E. of Irkutsk, on the Chita river, half a mile above its confluence with the Ingoda. Pop. (1883) 12,600; (1897) 11,480. The Imperial Russian Geographical Society has a museum here. Several of the palace revolutionaries, known as Decembrists, were banished to this place from St Petersburg in consequence of the conspiracy of December 1825. The inhabitants support themselves by agriculture and by trade in furs, cattle, hides and tallow bought from the Buriats, and in manufactured wares imported from Russia and west Siberia.

CHITALDRUG, a district and town in the native state of Mysore, India. The district has an area of 4022 sq. m. and a population (1901) of 498,795. It is distinguished by its low rainfall and arid soil. It lies within the valley of the Vedavati or Hagari river, mostly dry in the hot season. Several parallel chains of hills, reaching an extreme height of 3800 ft., cross the district; otherwise it is a plain. The chief crops are cotton and flax; the chief manufactures are blankets and cotton cloth. The west of the district is served by the Southern Mahratta railway. The largest town in the district is Davangere (pop. 10,402). The town of CHITALDRUG, which is the district headquarters (pop. 1901, 5792), was formerly a military cantonment, but this was abandoned on account of its unhealthiness. It has massive fortifications erected under Hyder Ali and Tippoo Sahib towards the close of the 18th century; and near it on the west are remains of a city of the 2nd century A.D.

CHITON, the name¹ given to fairly common littoral animals of rather small size which belong to the phylum Mollusca, and, in the possession of a radula in the buccal cavity, resemble more especially the Gastropoda. Their most important characteristic in comparison with the latter is that they are, both in external and internal structure, bilaterally symmetrical. The dorsal integument or mantle bears, not a simple shell, but eight calcareous plates in longitudinal series articulating with each other. The ventral surface forms a flat creeping "foot," and between mantle and foot is a pallial groove in which there is on each side a series of gills. Originally the Chitons were placed with the limpets, *Patella*, in Cuvier's *Cyclobranchia*, an order of the Gastropoda. In 1876 H. von Jhering demonstrated the affinities

¹ The Gr *χιτών* was a garment in the shape of a loose tunic, varying at different periods. see COSTUME: *Greek*.

of *Neomenia* and *Chaetoderma*, vermiform animals destitute of shell, with the Chitons, and placed them all in a division of worms which he named Amphineura. The discovery by A. A. W. Hubrecht in 1881 of a typical molluscan radula and odontophore in a new genus *Proneomenia*, allied to *Neomenia*, showed that the whole group belonged to the Mollusca. E. Ray Lankester (*Ency. Brit.*, 9th ed., 1883) placed them under the name *Isoptleura* as a subclass of Gastropoda. Paul Pelseneer (1906) raised the group to the rank of a class of Mollusca, under von Jhering's name Amphineura.

The Amphineura are divided into two orders: (1) the Polyplacophora, or Chitons; (2) the Aplacophora, or forms without shells, *Neomenia*, *Chaetoderma* and their allies.

Order I.—POLYPLACOPHORA

Each of the eight valves of the shell is made up of two distinct calcareous layers: (a) an outer or upper called the tegmentum, which is visible externally; (b) a deeper layer called articula-

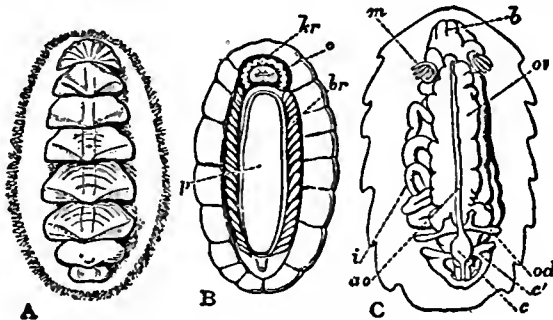

FIG. 1.—Three views of Chiton.

- A. Dorsal view of *Chiton Wosnessenkii*, Midd., showing the eight shells. (After Middendorf.)
- B. View from the pedal surface of a species of *Chiton* from the Indian Ocean. *p*, foot; *o*, mouth (at the other end of the foot is seen the anus raised on a papilla); *kr*, oral fringe; *br*, the numerous ctenidia (branchial plumes); spreading beyond
- C. The same species of *Chiton*, with the shells removed and the dorsal integument reflected. *b*, buccal mass; *m*, retractor muscles of the buccal mass; *ov*, ovary; *od*, oviduct; *i*, coils of intestines; *ao*, aorta; *c'*, left auricle; *c*, ventricle.

mentum which is porcellaneous, quite compact, and entirely covered by the tegmentum. In the lower forms the two layers are coextensive and have smooth edges, but in the higher forms

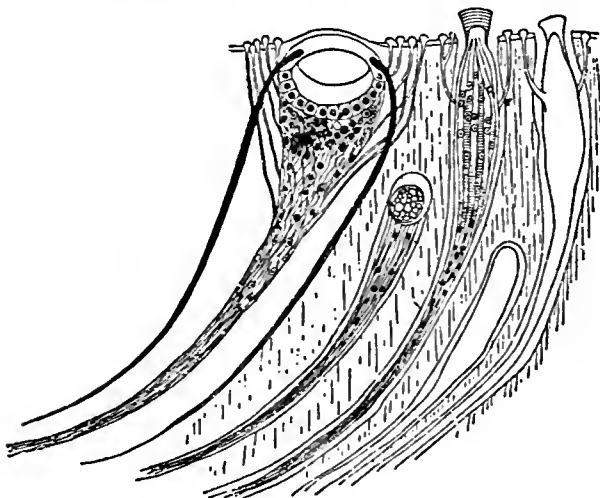
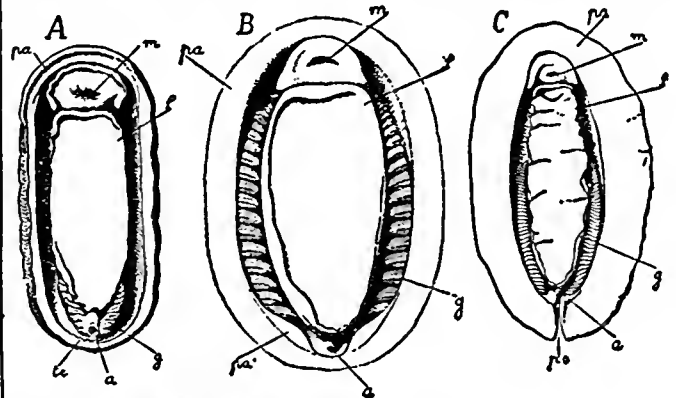

FIG. 2.—Pallial eye and aesthetes of *Acanthopleura spiniger* (Moseley).

the articulamentum projects laterally beyond and beneath the tegmentum into the substance of the mantle. These projections

are termed insertion plates; they are usually slit or notched to form teeth, the edges of which may be smooth and sharp, or may be crenulated. The anterior margin of each valve except the first is provided with two projections called sutural laminae which underlie the posterior margin of the preceding valve.

The tegmentum is formed by the fold of mantle covering the



From Lankester, *Treatise on Zoology*.

FIG. 3.—Ventral aspect of three species of Polyplacophora showing position of gills.

- A. *Lepidopleurus benthus*.
- B. *Boreochiton cinereus*.
- C. *Schizochiton incisus*. *a*, anus; *f*, foot; *g*, gills; *m*, mouth; *pa*, mantle; *pa'*, anal lobe of mantle; *ps*, pallial slit; *te*, pallial tentacles.

edge of the articulamentum, and extends over the latter from the sides. It is the first part of the shell formed in development. The tegmentum is much reduced in *Acanthochiton*, and absent in the adult *Cryptochiton*.

The tegmentum is pierced by numerous vertical ramified epithelial papillae of the epidermis. These papillae form pallial sense-organs, containing nerve-end bulbs, covered by a dome of cuticle, and innervated from the pallial nerve-cords. They are termed according to their size, microaesthetes and megal-aesthetes. In the common species of *Chiton* and many others of the family *Chitonidae* the megal-aesthetes are developed into definite eyes, the most complicated of which have retina, pigment within the eye, cornea and crystalline lens (intra-pigmental eyes) (fig. 2). The eyes are arranged in rows running diagonally from the median anterior beak of each valve to its lateral borders. There may be only one such row on either side, or many rows. In some species the total number present amounts to thousands.

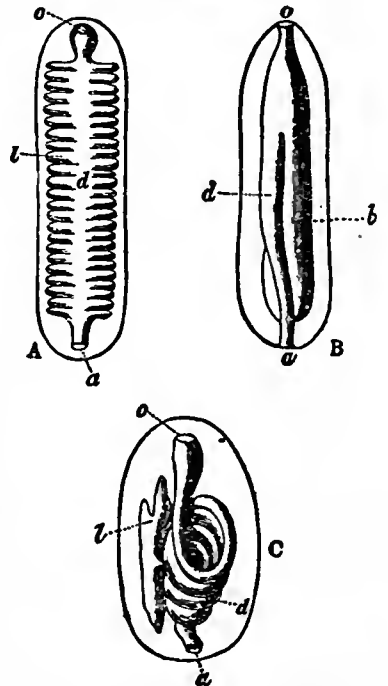

FIG. 4.—Diagrams of the alimentary canal of Amphineura (from Hubrecht).
A. *Neomenia* and *Proneomenia*.
B. *Chaetoderma*.
C. *Chiton*.
o, Mouth.
a, Anus.
d, Alimentary canal.
l, Liver (digestive gland).

Branchiae.—The series of gills may extend the whole length of the body in the pallial groove, or may be confined to the posterior end. Each gill has the structure of a typical molluscan ctenidium, consisting of an axis bearing an anterior and posterior row of filaments or lamellae. The gills are thus metamericly repeated; there may be from four to eighty pairs, but there is

often a numerical asymmetry on the two sides. The largest pair of branchiae is placed immediately behind the renal openings and corresponds to the single pair of other molluscs, the organs being repeated anteriorly only (Metamacrobranchs) or anteriorly and posteriorly (Mesomacrobranchs).

Intestine.—The digestive tube in the Polyplacophora, which are herbivorous, is longer than the body, and thrown into a few coils, the anus being median and posterior. The mouth leads into the buccal cavity, on the ventral side of which opens the radular caecum. Each transverse row of teeth of the radula contains 17 teeth, one of which is median, while the second and the fifth on each side are enlarged. Two pairs of glands open into the buccal cavity, and at the junction of pharynx and oesophagus is another pair called the sugar glands. The stomach is surrounded by the liver or digestive

from the gonad near its posterior end and passes first forwards, then backwards, and lastly outwards to the external opening in the pallial groove, anterior to the renal aperture. There may be from one to nine gills between the genital and renal pores.

Heart and Vascular System.—The heart is enclosed in the pericardium, and consists of a median elongated ventricle and a pair of lateral auricles, so that the structure somewhat resembles that in the Lamellibranchiata. The openings of the auricles into the ventricle vary in different forms. In many of the lower forms (*Lepidopleuridae*, *Mopaliidae*, *Ischnochitonidae*) the opening on each side is single and anterior. In the true *Chitonidae* there are generally two apertures on each side, and in two species three or four, another instance of the tendency to metameric repetition in the group. The auricles are connected with one another posteriorly behind the ventricle. The ventricle leads into a single anterior median aorta. As in other molluscs, the arteries do not extend far, but lead into inter-visceral blood-spaces. The venous blood is conducted from the tissues to a large sinus on either side above the pallial groove, and from this sinus passes to the gills by an afferent vessel in each gill on the internal or pedal margin of the axis. The oxygenated blood is carried from each gill by an efferent vessel on the external or pallial side of the axis to another longitudinal vessel which leads to the auricle on each side.

Nervous System.—There are no well-marked specialized ganglia in the central nervous system, nerve-cells being distributed uniformly along the cords. There are two pairs of longitudinal cords, a pedal pair situated ventrally and united beneath the intestine by numerous commissures, and a pallial pair situated laterally and continuous with one another above the rectum (fig. 7). The four cords are all connected anteriorly with the cerebral commissure which lies above the buccal mass anteriorly. From the points where the cords meet the cerebral commissure, arise on each an anterior labial commissure and a stomatogastric commissure. The latter bears two ganglion swellings, the buccal ganglia. The labial commissure gives off a subradular commissure which also bears two ganglia, these being in close relation to a special sense-organ called the subradular organ, an epithelial projection with nerve-endings, lying in front of the radula and probably gustatory in function. One osphradium or branchial olfactory organ is usually present on each side, on either side of the anus on the inner wall of the mantle, near the base of the last gill.

In *Lepidopleuridae* an osphradium occurs at the base of each gill. The sense organs of the shell-valves have already been described.

Development.—The eggs may be laid separately invested by a chitinous envelope, or as in *Ischnochiton magdalenensis* they may form strings containing nearly 200,000 eggs, or the ova may be retained in the pallial groove and undergo development there, as in *Chiton pallii* and *Hemiarthrum setulosum*. One species *Callistochiton viviparus* is viviparous and its ova develop without a larval stage in the maternal oviduct. Segmentation is total and at first regular, and is followed by invagination, the blastopore passing to the position of the future mouth. By the development of a ciliated ring just in front of the mouth the embryo becomes a trochosphere. In the centre of the praecoral lobe is a tuft of cilia. Just behind the ciliated ring is a pair of larval eyes which disappear in the adult; these correspond to the cephalic eyes of Lamellibranchs. An ectodermic invagination forms a large mucous gland on the foot, which is more or less atrophied in adult life. The gonads originate by proliferation of the anterior wall of the pericardium. The shell-

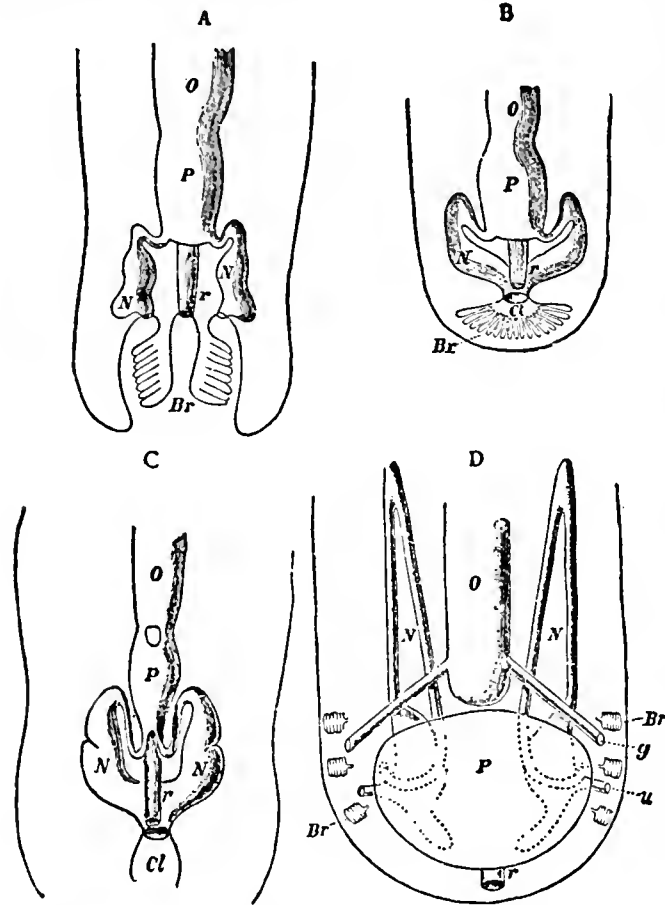
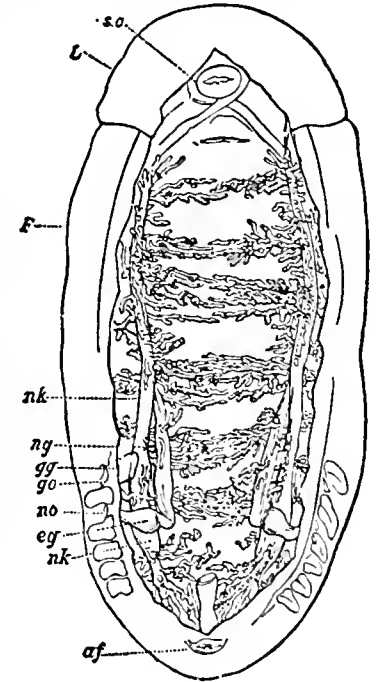

FIG. 5.—Diagrams of the excretory and reproductive organs of Amphineura (after Hubrecht).

- A, Chaetoderma.
- B, Neomenia.
- C, Proneomenia.
- D, Chiton.
- O, Ovary.
- P, Pericardium.
- N, Nephridium.
- u, External aperture of nephridium.
- g, External aperture of genital duct of Chiton.
- r, Rectum.
- Cl, Cloacal or pallial chamber of Neomenia and Chaetoderma.
- Br, Ctenidia (branchial plumes).

gland, consisting of two lobes which are symmetrical in the young animals, but in the adult the right lobe is anterior and smaller.

Coelom, Gonads and Excretory Organs.—As in other molluscs the coelom is represented by a large pericardial cavity, situated above the intestine posteriorly, and a generative sac which is single and median and situated in front of the pericardium, except in the *Nuttallchiton hyadesi*, where the gonads are in a similar position, but are paired. The excretory organs are coelomoducts with an internal ciliated opening into the pericardium and an opening to the exterior. Both the openings are close together, the external opening being just in front of the principal gill near the posterior end of the body. The renal tube is doubled on itself, its middle part where the bend occurs being situated more or less anteriorly. The excretory surface is increased by numerous ramified caeca which extend beneath the body wall laterally and ventrally, and open into the tube (fig. 6). The sexes are distinct, and the ovary is frequently greenish in colour, the testis red. The gonad is transversely wrinkled and lies between the aorta and the intestine, extending from the pericardium to the anterior end of the body. A simple gonoduct on each side arises



After Haller (*Arbeiten zool. Instit.*), Vienna, 1882.

FIG. 6.—Dissection of the renal organs (nephridia) of *Chiton siculus*.

- F, Foot.
- L, Edge of the mantle not removed in the front part of the specimen.
- s.o., Oesophagus.
- af, Anus.
- gg, Genital duct.
- go, External opening of the same.
- eg, Stem of the nephridium leading to no, its external aperture.
- nk, Reflected portion of the nephridial stem.
- ng, Fine caeca of the nephridium, which are seen ramifying transversely over the whole inner surface of the pedal muscular mass.

The shell-

valves arise as transverse thickenings of the dorsal cuticle behind the ciliated ring, the tegmentum being the first part formed.

Classification.

Suborder I. EOPLACOPHORA, Pilsbry.—Tegmentum coextensive with articulamentum, or the latter projecting in smooth unslit plates.

Fam. 1. *Lepidopleuridae*.—Terminal margins of end valves never elevated; form oval or oblong. *Lepidopleurus cancellatus*, Sow. North Atlantic and Mediterranean; various abyssal species. *Hanleya hanleyi*, Bean, north Atlantic. *Hemiarthrum Microplax*. The extinct *Grypochitonidae*, Pilsbry, with other Palaeozoic genera, narrow and elongated in form with terminal margins of end valves elevated, belong to this group.

Suborder II. MESOPLACOPHORA, Pilsbry.—Insertion plates well developed and slit.

Fam. 2. *Ischnochitonidae*.—All the valves with slits, and the inner layer well covered by the outer.

Subfam. 1. *Ischnochitoninae*.—No shell-eyes: sutural laminae separated; slits in the valves 1-7 do not correspond with the ribs of the tegmentum. *Ischnochiton*, *Trachydermon*, *Chaetopleura*, *Stenoplax*, *Stenoradsia*.

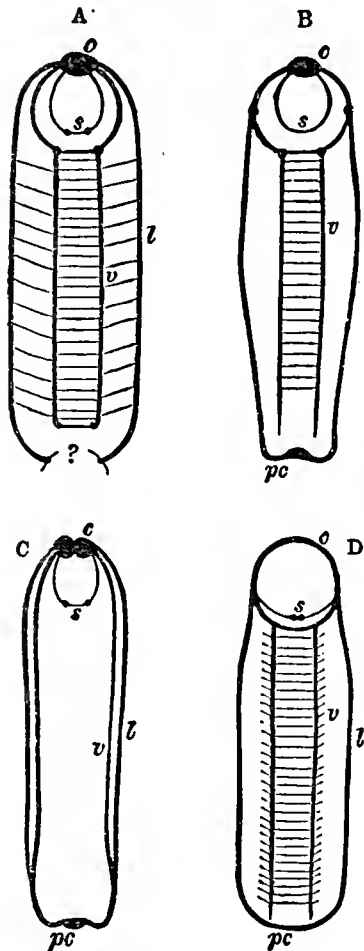

After Hubrecht, loc. cit.

FIG. 7.—Diagrams of the nervous system of Amphineura.

- A, Pronomenia.
- B, Neomenia.
- C, Chaetoderma.
- D, Chiton.
- c, Cerebral ganglia.
- s, Sublingual ganglia.
- v, Pedal (ventral) nerve-cord.
- l, Visceral (lateral) nerve-cord.
- pc, Post-anal junction of the visceral nerve-cords.

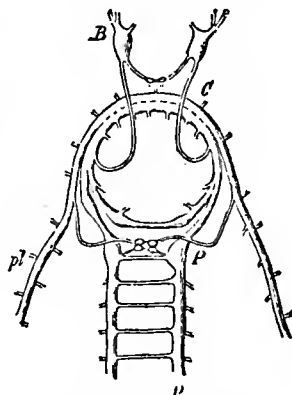

From Gegenbaur, Elements of Comp. Anatomy.

FIG. 8.—Anterior part of the nervous system of *Chiton cinereus*, in more detail. B, Buccal ganglia (concerned with the odontophore). C, Cerebral nerve-mass. P, Pedal ganglion and commencement of pedal nerve-cord. pl, Visceral nerve-cord. The sublingual ganglia are not lettered.

Subfam. 2. *Callochitoninae*. With shell-eyes and united sutural laminae. *Callochiton laevis*, North Atlantic and Mediterranean. Subfam. 3. *Callistoplacinae*. No shell-eyes, slits in the valves 1-7 corresponding with the ribs of the tegmentum. *Callistochiton* (viviparous). *Nuttalochiton*.

Fam. 3. *Mopaliidae*. Each intermediate valve with a single slit; girdle hairy. *Mopalia*, *Placiphorella*, *Plaxiphora*, *Placophoropsis*.

Fam. 4. *Acanthochitonidae*. Valves immersed in the girdle, with small tegmentum. *Acanthochiton* (*A. fascicularis*, North Atlantic and Mediterranean. *Spongiochiton*, *Katharina*, *Amicula*, *Cryptochiton* (*C. stelleri*, arctic).

Fam. 5. *Cryptoplacidae*. Vermiform, with thick girdle and small valves; insertion and sutural plates strongly drawn forward, sharp and smooth. *Cryptoplax*, *Choneplax*.

Suborder III. TELEOPLACOPHORA, Pilsbry.—All the valves, or at

least the seven anterior, with insertion plates cut into teeth by slits.

Fam. 6. *Chitonidae*. Characters of the suborder.

Subfam. 1. *Chitoninae*. No extra-pigmental eyes; insertion plates with pectinations between the fissures. *Chiton*, *Eudoxochiton*, *Trachyodon*, *Radsia*.

Subfam. 2. *Tonicinae*. Extra-pigmental shell-eyes. *Tonicia*, *Acanthopleura*, *Enoplochiton*, *Omithochiton*, *Schizochiton*, *Lorica*, *Loricella*, *Liolophura*.

Order 2.—APLACOPHORA, von Jhering.

Chaetoderma was first described by S. Lovén, in 1841, and was for a long time believed to be a Gephyrean worm. *Neomenia*, mentioned first by Michael Sars in 1868 under the name *Solenopus*, was afterwards included among the Opisthobranchs by J. Koren and D. C. Danielssen. C. Gegenbaur placed the two genera in a division of Vermes which he called Solenogastres.

The chief points in which the Aplacophora differ from the Polyplacophora are: (1) they are worm-like in shape; (2) there is no distinct foot, and the mantle bears no shell-valves, but only numerous calcareous spicules; (3) the digestive tube is straight.

Neomenia and its allies are marine animals living at depths of 15 to 800 fathoms on soft muddy ground; they are found crawling on corals and hydrozoa, on which they feed. The British genera are: *Neomenia*, *Rhopalomenia* and *Myzomenia*. They have been taken in nearly all seas except the South Atlantic and S.E. and N.W. Pacific. About forty species are known. *Chaetoderma*, of which nine species have been described, has similar habits and distribution, but feeds chiefly on Protozoa. The order Aplacophora is divided into two suborders.

Suborder I. NEOMENIOMORPHA.—Aplacophora with a distinct longitudinal ventral groove; bisexual with paired genital glands and no distinct liver. The whole of the skin except the ventral groove corresponds to the mantle of *Chiton*. The cuticle, in some species very thick, contains numerous spicules which are long, hollow and calcified; they are secreted by epithelial papillae. In some species there are also sensory papillae comparable to the aesthetes of *Chitons*. A small longitudinal projection in the ventral groove represents the

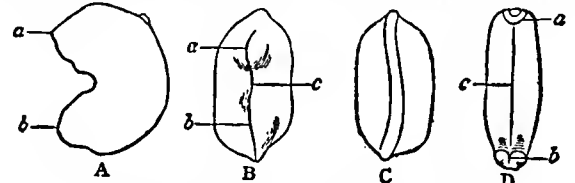

FIG. 9.—*Neomenia carinata*, Tullberg (after Tullberg).

- A, Lateral view.
- B, Ventral view.
- C, Dorsal view.
- D, Ventral view of a more extended specimen.
- a, Anterior.
- b, Posterior extremity.
- c, Furrow, in which the narrow foot is concealed.

foot. Into the groove open mucous glands, a large one anteriorly and another opening into a posteriorly cloacal, branchial cavity.

Branchiae.—In *Neomeniidae* and most of the *Parameniidae* there is a cirlet of gills on the inner walls of the cloacal chamber. These gills are simple folds or laminae of the body wall. In other species they are absent.

Intestine.—The mouth opens into a muscular pharynx lined by a thick cuticle. Into the pharyngeal cavity open salivary glands and radular sac. The former are paired and ventral, and open on a subradular prominence. In some species there is a second dorsal pair. *Neomenia* and other genera have no salivary glands.

The radula when present comprises several transverse rows of teeth, and each transverse row may have several teeth (polystichous), two teeth (distichous), or one tooth (monostichous). It is a curious fact that in the original type *Neomenia* the radula is entirely absent, as it likewise is in several genera of *Pronomeniidae*. The oesophagus is short and leads into a long, straight stomach, provided with numerous symmetrical lateral caeca. The stomach opens into a short straight rectum which opens into the branchial chamber.

Coelom, Gonads and Excretory Organs.—The coelom differs from that of the *Chitons* in the fact that the cavities of the genital organs are continuous with it, and in the fact that there is only one pair of coelomoducts resembling the renal organs of *Chitons*, but serving also as genital ducts. The gonads are paired and hermaphrodite, they form a pair of anterior prolongations of the pericardium, extending nearly to the anterior end of the body. Ova are developed on the median, spermatozoa on the outer wall of each genital tube. The pericardium is ciliated internally on its dorsal and lateral walls. The urino-genital tubes arise from the posterior angles of the pericardium, pass first forwards, then backwards, and unite to open by a common opening into the cloaca below the anus except in

Strophomenia, where the openings are separate. Usually each tube is provided with caecal appendages on its proximal portion, and these serve as vesiculae seminales, while the distal portion is enlarged and glandular and secretes the egg-shell.

Heart and Vascular System.—There is a heart in the pericardium consisting of a median ventricle attached, except in *Neomenia*, to the dorsal wall of the pericardium, and in *Neomenia* a pair of auricular ducts returning blood from the gills to the ventricle. The aorta is not independent as in Chitons, but is a sinus like the other channels of the circulation. A single median ventral sinus passes backwards to the gills or cloaca. The blood is coloured red by haemoglobin in blood corpuscles.

Nervous System.—Ganglionic enlargements are more conspicuous than in the Chitons. In front of the buccal mass is a median cerebral ganglion. From this pass off two pairs of cords, the pleural and pedal, in *Proneomenia* separate from their origin, in *Neomenia* united at first and diverging at a pleural ganglion. The pedal cords anteriorly form a pair of pedal ganglia united by a thick commissure. The supra-rectal commissure may be present and bear an ovoid ganglion; or may be wanting. With regard to sense organs the epithelial papillae of the mantle have been mentioned. There is also in some genera a median retractile sensory papilla on the dorsal posterior surface above the rectum, not covered by the cuticle.

Development has only been described in *Myzomenia banyulensis*, by G. Pruvot. It closely resembles in the early stages that of Chitons. The external surface of the trochosphere is formed of a number of ciliated test-cells. The ectoderm behind the ciliated ring develops spicules, and the post-oral region of the larva elongates. Later the ciliated ring or velum disappears and seven imbricated calcareous plates, made up of flattened spicules, are formed on the dorsal surface. This appears to indicate that the Neomeniomorpha are descended from *Chiton*-like ancestors, and that they have lost their shell valves.

Classification of the NEOMENIOMORPHA.—Fam. 1. *Lepidomeniidae*. Slender, tapering behind, with subventral cloacal orifice; thin cuticle without papillae; flattened spicules; no gills. *Lepidomenia*, *Ismenia*, *Ichthyodes*, *Stylomenia*, *Dondersia*, *Nematomenia*, *Myzomenia*, *M. banyulensis*, Mediterranean and Plymouth.

Fam. 2. *Neomeniidae*. Short, truncate in front and behind; cloacal orifice transverse; gills present; rather thin cuticle; no radula. *Neomenia* (*N. carinata*, N. Atlantic and N. and N.W. Scotland), *Hemimenia*.

Fam. 3. *Proneomeniidae*. Elongated, cylindrical, rounded at both ends; thick cuticle with acicular spicules; radula polystichous or wanting. *Proneomenia*, *Amphimena*, *Echinomenia*, *Rhopalomenia* (*R. aglaopheniae*, Mediterranean and Plymouth), *Notomenia*, *Pruvotia*, *Strophomenia*.

Fam. 4. *Parameniidae*. Short and truncated in front; thick cuticle, often without papillae; gills and radula present. *Paramenia*, *Macellomenia*, *Pararhopalia*, *Dinomenia*, *Cyclo-omenia*, *Proparamenia*, *Uncinemia*, *Kruppomenia*.

Suborder II. CHAETODERMOMORPHA.—Aplacophora without distinct ventral groove, with single median unisexual gonad, with differentiated hepatic sac, and with cloacal chamber furnished with two bipectinate gills. There are only two genera in this suborder: *Chaetoderma*, and *Limifossor* from Alaska.



FIG. 10.—*Chaetoderma nitidulum*, Lovén (after Graff). The cephalic enlargement is to the left, the anal chamber (reduced pallial chamber, containing the concealed pair of ctenidia) to the right.

The anterior extremity forms the enlarged funnel-like branchial or cloacal chamber. The anterior extremity is also somewhat enlarged. The whole surface is uniformly covered with short compressed calcareous spicula embedded in the cuticle.

Branchiae.—The single pair of branchiae are placed symmetrically right and left of the anus, and each has the structure of a ctenidium bearing a row of lamellae on each side as in the Polyplacophora.

Intestine.—The mouth is anterior, terminal and crescentic, and beneath it is a rounded ventral shield. On the floor of the pharynx or buccal mass is a rudimentary radula, which in many species consists of a single large tooth, bearing two small teeth or a row of teeth. In other species the radula is more of the usual type consisting of several transverse rows of two or three teeth each. Two pairs of salivary glands open into the buccal cavity. The digestive tube is straight and simple, wider in its anterior part, into which opens the duct of the hepatic caecum (fig. 4, B). The latter extends backwards on the ventral side of the intestine.

Coelom, Gonads and Excretory Organs.—These are closely similar in their relations to those of the Neomeniomorpha. The chief difference is that the gonad or generative portion of the coelom is single and median, opening into the pericardium by a single posterior aperture. The excretory organs or coelomoducts arise from the posterior corners of the pericardium, run forwards and then back-

wards to open by separate apertures lateral to the gills (fig. 5, A). There are no accessory generative organs.

The heart and vascular system are similar to those of the Neomeniomorpha, the only important differences being that the ventricle is nearly free in the pericardial cavity, and that the latter is traversed by the retractor muscles of the gills.

Nervous System.—There are two closely connected cerebral ganglia, from which arise the usual two pairs of nerve cords. Pallial and pedal on each side are closer together than in the other groups, and posteriorly they unite into a supra-rectal cord provided with a median ganglionic enlargement (fig. 7, C). A small stomatogastric commissure bearing two small ganglia arises from the cerebral ganglia and surrounds the oesophagus.

The development is at present entirely unknown.

General Remarks on the Amphineura.

The most important theoretical question concerning the Amphineura is how far do they represent the original condition of the ancestral mollusc? That is to say, we have to inquire which of their structural features is primitive and which modified. Their bilateral symmetry is obviously to be regarded as primitive, and the nervous system shows an original condition from which that of the asymmetrical twisted Gastropods can be derived. But in many other features both external and internal the three principal divisions differ so much from one another that we have to consider in the case of each organ-system which condition is the more primitive. According to Paul Pelsener the Polyplacophora are the most archaic, the Aplacophora being specialized in (1) the great reduction of the foot, (2) the disappearance of the shell (*Cryplopax* among the Polyplacophora showing both reductions in progress), (3) the disappearance of the radula. But it is a widely recognized principle of morphology that a much modified animal is by no means modified to the same degree in all its organs. A form which is primitive on the whole may show a more advanced stage of evolution in some particular system of organs than another animal which is on the whole more highly developed and specialized. Thus the independent metamorphism of certain organs in the Chitons is not primitive but acquired within the group: e.g. the shell valves and the ctenidia. And although embryology seems to prove that the Neomeniomorpha are derived from forms with a series of shell-valves, nevertheless it seems probable that the calcareous spicules which alone are present in adult Aplacophora preceded the solid shell in evolution.

It is held by some morphologists that the mollusc body is unsegmented, and therefore is to be compared to a single segment of a Chaetopod or Arthropod. In this case there should be only one pair of coelomoducts in the adult, the pair of true nephridia which should also occur being represented by the larval nephridia. There should also be only a single coelom, or a pair of lateral coelomic cavities. On this view then the Aplacophora are more primitive than the Polyplacophora in the relations of coelom, gonad and coelomoducts; and the genital ducts of the Chitons have arisen either by metameric repetition within the group, or by the gradual loss of an original connexion between the generative sac and the renal tube, as in Lamellibranchs and Gastropods, the generative sac acquiring a separate duct and opening to the exterior on each side.

LITERATURE.—A. Sedgwick, "On certain Points in the Anatomy of Chiton," *Proc. R. Soc. Lond.*, xxxiii., 1881; J. Blumrich, "Das Integument der Chitonen," *Zeitsch. f. wiss. Zool.* lii., 1891; A. C. Haddon, "Report on the Polyplacophora," *Challenger Reports. Zool.* pt. xliiii., 1886; H. N. Mosely, "On the presence of Eyes in the Shells of certain Chitonidae, and on the structure of these Organs," *Quart. Journ. Mic. Sci.* new ser. xxv., 1885; A. A. W. Hubrecht, "Proneomenia Sluiteri," *Nied. Arch. f. Zool. Suppl.* 1., 1881; A. Kowalewsky and A. F. Marion, "Contr. à l'histoire des Solenogastres ou Aplacophores," *Ann. Mus. Marseille, Zool.* iii., 1887; A. Kowalewsky, "Sur le genre *Chaetoderma*," *Arch. de zool. expér.* (3) ix., 1901; P. Pelsener, "Mollusca," *Treatise on Zoology*, edited by E. Ray Lankester, pt. v., 1906; E. Ray Lankester, "Mollusca," in the 9th ed. of this Encyclopaedia, to which this article is much indebted. (J. T. C.)

CHITRAL, a native state in the North-West Frontier Province of India. The state of Chitral (see also HINDU KUSH) is somewhat larger than Wales, and supports a population of about 35,000 rough, hardy hillmen. Previous estimates put the number far higher, but as the Mehtar assesses his fighting strength at

8000 only, this number is probably not far wrong. Both the state and its capital are called Chitral, the latter being situated about 47 m. from the main watershed of the range of the Hindu Kush, which divides the waters flowing down to India from those which take their way into the Oxus. Chitral is an important state because of its situation at the extremity of the country over which the government of India exerts its influence, and for some years before 1895 it had been the object of the policy of the government of India to control the external affairs of Chitral in a direction friendly to British interests, to secure an effective guardianship over its northern passes, and to keep watch over what goes on beyond these passes. This policy resulted in a British agency being established at Gilgit (Kashmir territory), with a subordinate agency in Chitral, the latter being usually stationed at Mastuj (65 m. nearer to Gilgit than the Chitral capital), and occasional visits being paid to the capital. Chitral can be reached either by the long circuitous route from Gilgit, involving 200 m. of hill roads and the passage of the Shandur pass (12,250 ft.), or (more directly) from the Peshawar frontier at Malakand by 100 m. of route through the independent territories of Swat and Bajour, involving the passage of the Lowarai (10,450 ft.). It is held by a small force as a British outpost.

The district of Chitral is called Kashgar (or Kashkar) by the people of the country; and as it was under Chinese domination in the middle of the 18th century, and was regarded as a Buddhist centre of some importance by the Chinese pilgrims in the early centuries of our era, it is possible that it then existed as an outlying district of the Kashgar province of Chinese Turkestan, where Buddhism once flourished in cities that have been long since buried beneath the sand-waves of the Takla Makan. The aboriginal population of the Chitral valley is probably to be recognized in the people called Kho (speaking a language called Khowar), who form the majority of its inhabitants. Upon the Kho a people called Ronas have been superimposed. The Ronas, who form the chief caste and fighting race of the Chitral districts, originally came from the north, but they have adopted the language and fashions of the conquered Chitrali.

The town of Chitral (pop. in 1901, 8128), is chiefly famous for a siege which it sustained in the spring of 1895. Owing to complications arising from the demarcation of the boundary of Afghanistan which was being carried out at that time, and the ambitious projects of Umra Khan, chief of Jandol, which was a tool in the hands of Sher Afzul, a political refugee from Chitral supported by the amir at Kabul, the mehtar (or ruler) of Chitral was murdered, and a small British and Sikh garrison subsequently besieged in the fort. A large force of Afghan troops was at that time in the Chitral river valley to the south of Chitral, nominally holding the Kafirs in check during the progress of boundary demarcation. It is considered probable that some of them assisted the Chitralis in the siege. The position of the political agent Dr Robertson (afterwards Sir George Robertson) and his military force of 543 men (of whom 137 were non-combatants) was at one time critical. Two forces were organized for the relief. One was under Sir R. Low, with 15,000 men, who advanced by way of the Malakand pass, the Swat river and Dir. The other, which was the first to reach Chitral, was under Colonel Kelly, commanding the 32nd Pioneers, who was placed in command of all the troops in the Gilgit district, numbering about 600 all told, with two guns, and instructed to advance by the Shandur pass and Mastuj. This force encountered great difficulties owing to the deep snow on the pass (12,230 ft. high), but it easily defeated the Chitrali force opposed to it and relieved Chitral on the 20th of April, the siege having begun on the 4th of March. Sher Afzul, who had joined Umra Khan, surrendered, and eventually Chitral was restored to British political control as a dependency of Kashmir. During Lord Curzon's viceroyalty the British troops were concentrated at the extreme southern end of the Chitral country at Kila Drosh and the force was reduced, while the posts vacated and all outlying posts were handed over to levies raised for the purpose from the Chitralis themselves. The troops in Swat were also concentrated at Chakdara and reduced in strength. The mehtar, Shuja-ul-Mulk, who was installed in September 1895, visited the Delhi durbar in January 1903.

See Sir George Robertson, *Chitral* (1898). (T. H. H.)*

CHITTAGONG, a seaport of British India, giving its name to a district and two divisions of Eastern Bengal and Assam. It is situated on the right bank of the Karnaphuli river, about 12 m. from its mouth. It is the terminus of the Assam-Bengal railway. The municipal area covers about 9 sq. m.; pop. (1901) 22,140. The sea-borne exports consist chiefly of jute, other items being tea, raw cotton, rice and hides. There is also a large trade by country boats, bringing chiefly cotton, rice, spices, sugar and tobacco. Since October 1905 Chittagong has become the chief port of the new province of Eastern Bengal and Assam.

The DISTRICT OF CHITTAGONG is situated at the north-east corner of the province, occupying a strip of coast and hills between the sea and the mountains of Burma. Its area is 2492 sq. m. In 1901 the population was 1,353,250, showing an increase of 5% in the decade. A few unimportant ranges rise within the north-eastern portion, the highest hill being the sacred Sitakund, 1155 ft. high. The principal rivers are the Karnaphuli, on which Chittagong town is situated, navigable by sea-going ships as far as Chittagong port, and by large trading boats for a considerable distance higher up, and the Halda and the Sangu, which are also navigable by large boats. The wild animals are tigers, elephants, rhinoceros, leopards and deer. The climate is comparatively cool, owing to the sea breeze which prevails during the day; but for the same reason, the atmosphere is very moist, with heavy dews at night and fogs. Chittagong was ceded to the East India Company by Nawab Mir Kasim in 1760. The northern portion of the district is traversed by the Assam-Bengal railway. Tea cultivation is moderately successful.

The CHITTAGONG HILL TRACTS formed an independent district from 1860 to 1891, were then reduced to the status of a sub-division, but were again created a district in 1900. They occupy the ranges between Chittagong proper and the south Lushai hills. The area covers 5138 sq. m. In 1901 the population was 124,762, showing an increase of 16% in the decade. The inhabitants, who are either Arakanese or aboriginal tribes, are almost all Buddhists. The headquarters are at Rangamati, which was wrecked by the cyclone of October 1897.

The DIVISION OF CHITTAGONG lies at the north-east corner of the Bay of Bengal, extending northward along the left bank of the Meghna. It consists of the districts of Chittagong, the Hill Tracts, Noakhali and Tippera. Its area covers 11,773 sq. m.; the population in 1901 was 4,737,731.

CHITTUR, a town of British India, in the North Arcot district of Madras, with a station on the South Indian railway. Pop. (1901) 10,893. Formerly a military cantonment, it is now only the civil headquarters of the district. It has an English church, mission chapel, and Roman Catholic chapel, a high school, and several literary institutes.

CHITTY, SIR JOSEPH WILLIAM (1828–1899), English judge, was born in London. He was the second son of Thomas Chitty (himself son and brother of well-known lawyers), a celebrated special pleader and writer of legal text-books, in whose pupil-room many distinguished lawyers began their legal education. Joseph Chitty was educated at Eton and Balliol, Oxford, gaining a first-class in *Literæ Humaniores* in 1851, and being afterwards elected to a fellowship at Exeter College. His principal distinctions during his school and college career had been earned in athletics, and he came to London as a man who had stroked the Oxford boat and captained the Oxford cricket eleven. He became a member of Lincoln's Inn in 1851, was called to the bar in 1856, and made a queen's counsel in 1874, electing to practise as such in the court in which Sir George Jessel, master of the rolls, presided. Chitty was highly successful in his method of dealing with a very masterful if exceedingly able judge, and soon his practice became very large. In 1880 he entered the house of commons as liberal member for Oxford (city). His parliamentary career was short, for in 1881 the Judicature Act required that the master of the rolls should cease to sit regularly as a judge of first instance, and Chitty was selected to fill the vacancy thus created in the chancery division. Sir Joseph Chitty was for sixteen years a popular judge, in the best meaning of the phrase, being noted for his courtesy, geniality, patience and scrupulous fairness, as well as for his legal attainments, and being much respected and liked by those practising before him, in spite of a habit of interrupting counsel, possibly acquired through the example of Sir George Jessel. In 1897, on the retirement of Sir Edward Kay, L.J., he was promoted to the court of appeal. There he more than sustained—in fact, he appreciably increased—his reputation as a lawyer and a judge, proving himself to possess considerable knowledge of the common law as well as of equity. He died in London on the 15th of February 1899. He married in 1858 Clara Jessic, daughter of Chief Baron Pollock, and left children who could thus claim descent from two of the best-known English legal families of the 19th century.

See E. Manson, *Builders of our Law* (1904).

CHIUSI (anc. *Ciusium*), a town of Tuscany, Italy, in the province of Siena, 55 m. S.E. by rail from the town of Siena, and 26 m. N.N.W. of Orvieto. Pop. (1901) 6011. It is situated

on a hill 1305 ft. above sea-level, and is surrounded by medieval walls, in which, in places, fragments of the Etruscan wall are incorporated. The cathedral of S. Mustiola is a basilica with a nave and two aisles, with eighteen columns of different kinds of marble, from ancient buildings. It has been restored and decorated with frescoes in modern times. The campanile belongs to the 13th century. The place was devastated by malaria in the middle ages, and did not recover until the Chiana valley was drained in the 18th century. For the catacombs see CLUSIUM.

CHIVALRY (O. Fr. *chevalerie*, from Late Lat. *caballerius*), the knightly class of feudal times, possessing its own code of rules, moral and social (see KNIGHTHOOD AND CHIVALRY). The primary sense in the middle ages is "knights" or "fully armed and mounted fighting men." Thence the term came to mean that gallantry in battle and high sense of honour in general expected of knights. Thus "to do chivalry" was a medieval phrase for "to act the knight." Lastly, the word came to be used in its present very general sense of "courtesy." In English law chivalry meant the tenure of land by knights' service. It was a service due to the crown, usually forty days' military attendance annually. The *Court of Chivalry* was a court instituted by Edward III., of which the lord high constable and earl marshal of England were joint judges. When both sat the court had summary criminal jurisdiction as regards all offences committed by knights, and generally as to military matters. When the earl marshal alone presided, it was a court of honour deciding as to precedence, coats of arms, &c. This court sat for the last time in 1737. The heraldic side of its duties are now vested in the earl marshal as head of the Heralds' College.

CHIVASSO, a town and episcopal see of Piedmont, Italy, in the province of Turin, 18 m. N.E. by rail from the town of Turin, 600 ft. above sea-level. Pop. (1901) 4169 (town), 9804 (commune). It is situated on the left bank of the Po, near the influx of the Orco. The cathedral is of the 15th century with a fine façade ornamented with statues in terra-cotta. It was an important fortress in the middle ages, and until 1804, when the French dismantled it. One tower only of the old castle of the marquesses of Monferrato, who possessed the town from 1164 to 1435, remains. Chivasso is on the main line from Turin to Milan, and is the junction of branches for Aosta and Casale Monferrato.

CHIVE (*Allium Schoenoprasum*), a hardy perennial plant, with small narrow bulbs tufted on short root-stocks and long cylindrical hollow leaves. It is found in the north of England and in Cornwall, and growing in rocky pastures throughout temperate and northern Europe and Asiatic Russia, and also in the mountain districts of southern Europe. It is cultivated for the sake of its leaves, which are used in salads and soups as a substitute for young onions. It will grow in any good soil, and is propagated by dividing the roots into small clumps in spring or autumn; these are planted from 8 to 12 in. apart and soon form large tufts. The leaves should be cut frequently so as to obtain them tender and succulent.

CHLOPICKI, GREGORZ JOZEF (1772-1854), Polish general, was born in March 1772 in Podolia. He was educated at the school of the Basilians at Szarograd, from which in 1787 he ran away in order to enlist as a volunteer in the Polish army. He was present at all the engagements fought during 1792-1794, especially distinguishing himself at the battle of Raclawice, when he was General Rymkiewicz's adjutant. On the formation of the Italian legion he joined the second battalion as major, and was publicly complimented by General Oudinot for his extraordinary valour at the storming of Peschiera. He also distinguished himself at the battles of Modena, Busano, Casabianca and Ponto. In 1807 he commanded the first Vistulan regiment, and rendered good service at the battles of Eylau and Friedland. In Spain he obtained the legion of honour and the rank of a French baron for his heroism at the battle of Epila and the storming of Saragossa, and in 1809 was promoted to be general of brigade. In 1812 he accompanied the *Grande Armée* to Russia, was seriously wounded at Smolensk, and on the reconstruction of the Polish army in 1813 was made a general

of division. On his return to Poland in 1814, he entered the Russian army with the rank of a general officer, but a personal insult from the grand duke Constantine resulted in his retiring into private life. He held aloof at first from the Polish national rising of 1830, but at the general request of his countrymen accepted the dictatorship on the 5th of December 1830; on the 23rd of January 1831, however, he resigned in order to fight as a common soldier. At Wavre (Feb. 19) and at Grochow (Feb. 20) he displayed all his old bravery, but was so seriously wounded at the battle of Olszyna that he had to be conveyed to Cracow, near which city he lived in complete retirement till his death in 1854.

See Jozef Maczynski, *Life and Death of Joseph Chlopicki* (Pol.) (Cracow, 1858); Ignacy Pradzynski, *The Four Last Polish Commanders* (Pol.) (Posen, 1865).

CHLORAL, or TRICHLORACETALDEHYDE, $\text{CCl}_3\text{-CHO}$, a substance discovered by J. von Liebig in 1832 (*Ann.*, 1832, 1, p. 189) and further studied by J. B. A. Dumas and Staedler. It is a heavy, oily and colourless liquid, of specific gravity 1.541 at 0°C ., and boiling-point 97.7°C . It has a greasy, somewhat bitter taste, and gives off a vapour at ordinary temperature which has a pungent odour and an irritating effect on the eyes. The word *chloral* is derived from the first syllables of *chlorine* and *alcohol*, the names of the substances employed for its preparation. Chloral is soluble in alcohol and ether, in less than its own weight of water, and in four times its weight of chloroform; it absorbs chlorine, and dissolves bromine, iodine, phosphorus and sulphur. Chloral deliquesces in the air, and is converted by water into a hydrate, with evolution of heat; it combines with alcohols and mercaptans. An ammoniacal solution of silver nitrate is reduced by chloral; and nascent hydrogen converts it into aldehyde. By means of phosphorus pentachloride, chlorine can be substituted for the oxygen of chloral, the body $\text{CCl}_3\text{-CCl}_2\text{H}$ being produced; an analogous compound, $\text{CCl}_3\text{-C}(\text{C}_6\text{H}_5)_2\text{H}$, is obtained by treating chloral with benzene and sulphuric acid. With an alkali, chloral gives chloroform (*q.v.*) and a formate; oxidizing agents give trichloroacetic acid, $\text{CCl}_3\text{-CO}(\text{OH})$. When kept for some days, as also when placed in contact with sulphuric acid or a very small quantity of water, chloral undergoes spontaneous change into the polymeride *metachloral* $(\text{C}_2\text{Cl}_3\text{OH})_3$, a white porcellaneous body, slowly volatile in the air, and reconverted into chloral without melting at 180°C . Chloral unites directly with hydrocyanic acid to form β -trichloroacetonitrile, $\text{CCl}_3\text{-CH}(\text{OH})\text{CN}$, and with hydroxylamine it forms chloglyoxime, $\text{C}_2\text{H}_3\text{Cl}_3\text{N}_2\text{O}_2$.

Chloral is prepared by passing dry chlorine into absolute alcohol; the latter must be cooled at first, but towards the end of the operation has to be heated nearly to boiling. The alcohol is converted finally into a syrupy fluid, from which chloral is procured by treatment with sulphuric acid (see P. Fritsch, *Ann.*, 1894, pp. 279, 288). The crude chloral is distilled over lime, and is purified by further treatment with sulphuric acid, and by redistillation. A mixture of starch or sugar with manganese peroxide and hydrochloric acid may be employed instead of alcohol and chlorine for the manufacture of chloral (A. Staedler, *Ann. Ch. Pharm.*, 1847, 61, p. 101). An isomer of chloral, *parachloralide*, is made by passing excess of dry chlorine into absolute methyl alcohol.

Chloral hydrate, $\text{CCl}_3\text{-CH}(\text{OH})_2$, forms oblique, often very short, rhombic prisms. The crystals are perfectly transparent, only slightly odorous, free from powder, and dry to the touch, and do not become white by exposure. The melting-point of pure chloral hydrate is 57° , the boiling-point $96\text{-}98^\circ\text{C}$. When heated with sulphuric acid it is converted into anhydrous chloral and *chloralide*, $\text{C}_2\text{H}_2\text{Cl}_4\text{O}_3$. When mixed with water, chloral hydrate causes a considerable degree of cold; and, as with camphor, small fragments of it placed on the surface of water exhibit gyratory movements. Chloral hydrate does not restore the colour to a solution of fuchsine which has been decolorized by sulphurous acid, and so one must assume that the water present is combined in the molecular condition (V. Meyer, *Ber.*, 1880, 13, p. 2343). Chloral may be estimated by distilling the hydrate with milk of lime and measuring the volume of chloroform produced (C. H. Wood, *Pharm. Journ.*, (3) 1, p. 703), or by hydrolysis with a known volume of standard alkali and back titration with standard acid (V. Meyer, *Ber.*, 1873, 6, p. 600). Chloral hydrate has the property of checking the decomposition of a great number

of albuminous substances, such as milk and meat; and a mixture of it with glycerin, according to J. Personne, is suitable for the preservation of anatomical preparations. When heated with concentrated glycerin to a temperature of 110° to 230° C., chloral hydrate yields chloroform, CHCl_3 , and allyl formate, $\text{HCO}(\text{OC}_2\text{H}_5)$.

Pharmacology and Therapeutics.—The breaking up of chloral hydrate, in the presence of alkalis, with the production of chloroform and formates, led Liebreich to the conjecture that a similar decomposition might be produced in the blood; and hence his introduction of the drug, in 1869, as an anaesthetic and hypnotic. It is now known, however, that the drug circulates in the blood unchanged, and is excreted in the form of urochloralic acid. The dose is from five to twenty grains or somewhat more, and it is often given in the form of the pharmacopoeial *Syrupus Chloral*, which contains ten grains of chloral hydrate to the fluid drachm. Chloral hydrate must be well diluted when given by the mouth, as otherwise it may cause considerable gastro-intestinal irritation. In large doses chloral hydrate is a depressant to the circulation and the respiration, and also lowers the temperature. In the above doses the drug is a powerful and safe hypnotic, acting directly on the brain, and producing no preliminary stage of excitement. Very soon—perhaps twenty minutes—after taking such a dose, the patient falls into a sleep which lasts several hours, and is not distinguishable from natural sleep. When he wakes, it is without disagreeable after-symptoms, but with a feeling of natural refreshment. The pupils are always contracted under its influence, except in large doses. There is also rapidly induced a depression of the anterior horns of grey matter in the spinal cord, and as the symptoms of strychnine poisoning are due to violent stimulation of these areas, chloral hydrate is a valuable antidote in such cases. It should not be hypodermically injected. Its disadvantages are that it is powerless when there is pain, resembling in this feature nearly all hypnotics except opium (morphine) and hyoscin. Its action on the gastro-intestinal canal and on the respiratory and circulatory systems renders its use inadvisable when disease of these organs is present. Its action on the spinal cord has been employed with success in cases of tetanus, whooping-cough, urinary incontinence, and strychnine poisoning. In the latter case twenty grains in "normal saline" solution may be directly injected into a subcutaneous vein, but not into the subcutaneous tissues.

Toxicology.—In cases of acute poisoning by chloral hydrate, the symptoms may be summarized as those of profound coma. The treatment is to give a stimulant emetic such as mustard; to keep up the temperature by hot bottles, &c.; to prevent or disturb the patient's morbid sleep by the injection of hot strong coffee into the rectum, and by shouting, flipping with towels, &c.; to use artificial respiration in extreme cases; and to inject strychnine. Strychnine is much less likely, however, to save life after poisoning by chloral hydrate, than chloral hydrate is to save life in poisoning by strychnine.

Chronic poisoning by chloral is a most pernicious drug-habit. The vice is easily and very rapidly acquired. The victim is usually excited and loquacious. He is easily fatigued and suffers from attacks of easily induced syncope. There are signs of gastro-intestinal irritation, and a tendency to cutaneous eruptions of an erythematous type. The patient may succumb to a dose only slightly larger than usual. The treatment is on general principles, there being no specific remedy. The patient must be persuaded to put himself under restraint, and the drug must be stopped at once and entirely.

CHLORATES, the metallic salts of chloric acid; they are all solids, soluble in water, the least soluble being the potassium salt. They may be prepared by dissolving or suspending a metallic oxide or hydroxide in water and saturating the solution with chlorine; by double decomposition; or by neutralizing a solution of chloric acid by a metallic oxide, hydroxide or carbonate. They are all decomposed on heating, with evolution of oxygen; and in contact with concentrated sulphuric acid with liberation of chlorine peroxide. The most important is potassium chlorate, KClO_3 , which was obtained in 1786 by C. L. Berthollet by the action of chlorine on caustic potash, and this method was at first used for its manufacture. The modern process consists in the electrolysis of a hot solution of potassium chloride, or, preferably, the formation of sodium chlorate by the electrolytic method and its subsequent decomposition by potassium chloride. (See **ALKALI MANUFACTURE**.) Potassium chlorate crystallizes in large white tablets, of a bright lustre. It melts without decomposition, and begins to give off oxygen at about 370° C. According to F. L. Teed (*Proc. Chem. Soc.*, 1886, p. 141), the decomposition of potassium chlorate by heat is not at all simple, the quantities of chloride and perchlorate produced depending on the temperature. A very gentle heating gives decomposition approximating to the equation of $22\text{KClO}_3 = 14\text{KClO}_4 + 8\text{KCl} + 5\text{O}_2$, whilst on a more rapid heating the quantities correspond more nearly to $10\text{KClO}_3 = 6\text{KClO}_4 + 4\text{KCl} + 3\text{O}_2$. The decomposition is rendered

more easy and regular by mixing the salt with powdered manganese dioxide. The salt finds application in the preparation of oxygen, in the manufacture of matches, for pyrotechnic purposes, and in medicine. Sodium chlorate, NaClO_3 , is prepared by the electrolytic process; by passing chlorine into milk of lime and decomposing the calcium chlorate formed by sodium sulphate; or by the action of chlorine on sodium carbonate at low temperature (not above 35° C.). It is much more soluble in water than the potassium salt.

Potassium chlorate is very valuable in medicine. Given in large doses it causes rapid and characteristic poisoning, with alterations in the blood and rapid degeneration of nearly all the internal organs; but in small doses—5 to 15 grains—it partly undergoes reduction in the blood and tissues, the chloride being formed and oxygen being supplied to the body-cells in nascent form. Its special uses are in ulceration of the mouth or tongue (*ulcerative stomatitis*), tonsillitis and pharyngitis. For these conditions it is administered in the form of a lozenge, but may also be swallowed in solution, as it is excreted by the saliva and so reaches the diseased surface. Its remarkable efficacy in healing ulcers of the mouth—for which it is the specific—has been ascribed to a decomposition effected by the carbonic acid which is given off from these ulcers. This releases chloric acid, which, being an extremely powerful antiseptic, kills the bacteria to which the ulcers are due.

CHLORINE (symbol Cl, atomic weight 35.46 (O=16), a gaseous chemical element of the halogen group, taking its name from the colour, greenish-yellow (Gr. *χλωρός*). It was discovered in 1774 by Scheele, who called it *dephlogisticated muriatic acid*; about 1785, C. L. Berthollet, regarding it as being a compound of hydrochloric acid and oxygen, termed it *oxygenized muriatic acid*. This view was generally held until about 1810–1811, when Sir H. Davy showed definitely that it was an element, and gave it the name which it now bears.

Chlorine is never found in nature in the uncombined condition, but in combination with the alkali metals it occurs widely distributed in the form of rock-salt (sodium chloride); as sylvine and carnallite, at Stassfurt; and to a smaller extent in various other minerals such as matlockite and horn-mercury. In the form of alkaline chlorides it is found in sea-water and various spring waters, and in the tissues of animals and plants; while, as hydrochloric acid it is found in volcanic gases.

The preparation of chlorine, both on the small scale and commercially, depends on the oxidation of hydrochloric acid; the usual oxidizing agent is manganese dioxide, which, when heated with concentrated hydrochloric acid, forms manganese chloride, water and chlorine:— $\text{MnO}_2 + 4\text{HCl} = \text{MnCl}_2 + 2\text{H}_2\text{O} + \text{Cl}_2$. The manganese dioxide may be replaced by various other substances, such as red lead, lead dioxide, potassium bichromate, and potassium permanganate. Instead of heating hydrochloric acid with manganese dioxide, use is frequently made of a mixture of common salt and manganese dioxide, to which concentrated sulphuric acid is added and the mixture is then heated:— $\text{MnO}_2 + 2\text{NaCl} + 3\text{H}_2\text{SO}_4 = \text{MnSO}_4 + 2\text{NaHSO}_4 + 2\text{H}_2\text{O} + \text{Cl}_2$. Chlorine may also be obtained by the action of dilute sulphuric acid on bleaching powder.

Owing to the enormous quantities of chlorine required for various industrial purposes, many processes have been devised, either for the recovery of the manganese from the crude manganese chloride of the chlorine stills, so that it can be again utilized, or for the purpose of preparing chlorine without the necessity of using manganese in any form (see **ALKALI MANUFACTURE**).

Owing to the reduction in the supply of available hydrochloric acid (on account of the increasing use of the "ammonia-soda" process in place of the "Leblanc" process for the manufacture of soda) Weldon tried to adapt the former to the production of chlorine or hydrochloric acid. His method consisted in using magnesia instead of lime for the recovery of the ammonia (which occurs in the form of ammonium chloride in the ammonia-soda process), and then by evaporating the magnesium chloride solution and heating the residue in steam, to condense the acid vapours and so obtain hydrochloric acid. One day before him E. Solvay had patented the same process, but neither of them was able to make the method a commercial success. However, in conjunction with Pechiney, of Salindres (near

Alais, France), the Weldon-Pechiney process was worked out. The residual magnesium chloride of the ammonia-soda process is evaporated until it ceases to give off hydrochloric acid, and is then mixed with more magnesia, the magnesium oxychloride formed is broken into small pieces and heated in a current of air, when it gives up its chlorine, partly in the uncombined condition and partly in the form of hydrochloric acid, and leaves a residue of magnesia, which can again be utilized for the decomposition of more ammonium chloride (W. Weldon, *Journ. of Soc. of Chem. Industry*, 1884, p. 387). Greater success attended the efforts of Ludwig Mond, of the firm of Brunner, Mond & Co. In this process the ammonium chloride is volatilized in large iron retorts lined with Doulton tiles, and then led into large upright wrought-iron cylinders lined with fire-bricks. These cylinders are filled with pills, made of a mixture of magnesia, potassium chloride and fireclay, the object of the potassium chloride being to prevent any formation of hydrochloric acid, which might occur if the magnesia was not perfectly dry. At 300° C. the ammonium chloride is decomposed by the magnesia, with the formation of magnesium chloride and ammonia. The mixture is now heated to 600° C. in a current of hot dry gas, containing no free oxygen (the gas from the carbonating plant being used), and then a current of air at the same temperature is passed in. Decomposition takes place and the issuing gas contains 18-20% of chlorine. This percentage drops gradually, and when it is reduced to about 3% the temperature of the apparatus is lowered, by the admission of air, to about 350° C., and the air stream containing the small percentage of chlorine is led off to a second cylinder of pills, which have just been treated with ammonium chloride vapour and are ready for the hot air current. With four cylinders the process is continuous (L. Mond, *British Assoc. Reports*, 1896, p. 734).

More recently, owing to the production of caustic soda by electrolytic methods, much chlorine has consequently been produced in the same manner (see ALKALI MANUFACTURE).

Chlorine is a gas of a greenish-yellow colour, and possesses a characteristic unpleasant and suffocating smell. It can be liquefied at -34° C. under atmospheric pressure, and at -102° C. it solidifies and crystallizes. Its specific heat at constant pressure is 0.1155, and at constant volume 0.08731 (A. Strecker, *Wied. Ann.*, 1877 [2], 13, p. 20); and its refractive index 1.000772, whilst in the liquid condition the refractive index is 1.367. The density is 2.4885 (air = 1) (Treadwell and Christie, *Zeit. anorg. Chem.*, 1905, 47, p. 446). Its critical temperature is 146° C. Liquid and solid chlorine are both yellow in colour. The gas must be collected either by downward displacement, since it is soluble in water and also attacks mercury; or over a saturated salt solution, in which it is only slightly soluble. At ordinary temperatures it unites directly with many other elements; thus with hydrogen, combination takes place in direct sunlight with explosive violence; arsenic, antimony, thin copper foil and phosphorus take fire in an atmosphere of chlorine, forming the corresponding chlorides. Many compounds containing hydrogen are readily decomposed by the gas; for example, a piece of paper dipped in turpentine inflames in an atmosphere of chlorine, producing hydrochloric acid and a copious deposit of soot; a lighted taper burns in chlorine with a dull smoky flame. The solution of chlorine in water, when freshly prepared, possesses a yellow colour, but on keeping becomes colourless, on account of its decomposition into hydrochloric acid and oxygen. It is on this property that its bleaching and disinfecting power depends (see BLEACHING). Water saturated with chlorine at 0° C. deposits crystals of a hydrate $\text{Cl}_2 \cdot 8\text{H}_2\text{O}$, which is readily decomposed at a higher temperature into its constituents. Chlorine hydrate has an historical importance, as by sealing it up in a bent tube, and heating the end containing the hydrate, whilst the other limb of the tube was enclosed in a freezing mixture, M. Faraday was first able to obtain liquid chlorine.

Chlorine is used commercially for the extraction of gold (*g.v.*) and for the manufacture of "bleaching powder" and of chlorates. It also finds an extensive use in organic chemistry as a substituting and oxidizing agent, as well as for the preparation of addition compounds. For purposes of substitution, the free element as a rule only works slowly on saturated compounds, but the reaction may be accelerated by the action of sunlight or on warming, or by using a "carrier." In these latter cases the reaction may proceed in different directions; thus, with the aromatic hydrocarbons, chlorine in the cold or in the presence of a carrier substitutes in the benzene nucleus, but in the presence of sunlight or on warming, substitution takes place in the side chain. Iodine, antimony trichloride, molybdenum pentachloride, ferric chloride, ferric oxide, antimony, tin, stannic oxide and ferrous sulphate have all been used as chlorine carriers.

The atomic weight of chlorine was determined by J. Berzelius

and by F. Penny (*Phil. Trans.*, 1839, 13). J. S. Stas, from the synthesis of silver chloride, obtained the value 35.457 ($\text{O} = 16$), and C. Marignac found the value 34.462. More recent determinations are: H. B. Dixon and E. C. Edgar (*Phil. Trans.*, 1905); T. W. Richards and G. Jones (*Abst. J.C.S.*, 1907); W. A. Noyes and H. C. Weber (*ibid.*, 1908), and Edgar (*ibid.*, 1908).

Hydrochloric Acid.—Chlorine combines with hydrogen to form hydrochloric acid, HCl, the only known compound of these two elements. The acid itself was first obtained by J. R. Glauber in about 1648, but J. Priestley in 1772 was the first to isolate it in the gaseous condition, and Sir H. Davy in 1810 showed that it contained hydrogen and chlorine only, as up to that time it was considered to contain oxygen. It may be prepared by the direct union of its constituents (see Burgess and Chapman, *J.C.S.*, 1906, 89, p. 1399), but on the large scale and also for the preparation of small quantities it is made by the decomposition of salt by means of concentrated sulphuric acid, $\text{NaCl} + \text{H}_2\text{SO}_4 = \text{NaHSO}_4 + \text{HCl}$. It is chiefly obtained as a by-product in the manufacture of soda-ash by the Leblanc process (see ALKALI MANUFACTURE). The commercial acid is usually yellow in colour and contains many impurities, such as traces of arsenic, sulphuric acid, chlorine, ferric chloride and sulphurous acid; but these do not interfere with its application to the preparation of bleaching powder, in which it is chiefly consumed. Without further purification it is also used for "souring" in bleaching, and in tin and lead soldering.

It is a colourless gas, which can be condensed by cold and pressure to a liquid boiling at -83.7° C., and can also be solidified, the solid melting at -112.5° C. (K. Olszewski). Its critical temperature is 52.3° C., and its critical pressure is 86 atmos. The gas fumes strongly in moist air, and it is rapidly dissolved by water, one volume of water at 0° C. absorbing 503 volumes of the gas. The gas does not obey Henry's law, that is, its solubility in water is not proportional to its pressure. It is one of the "strong" acids, being ionized to the extent of about 91.4% in decinormal solution. The strongest aqueous solution of hydrochloric acid at 15° C. contains 42.9% of the acid, and has a specific gravity of 1.212. Perfectly dry hydrochloric acid gas has no action on metals, but in aqueous solution it dissolves many of them with evolution of hydrogen and formation of chlorides.

The salts of hydrochloric acid, known as *chlorides*, can, in most cases, be prepared by dissolving either the metal, its hydroxide, oxide, or carbonate in the acid; or by heating the metal in a current of chlorine, or by precipitation. The majority of the metallic chlorides are solids (stannic chloride, titanous chloride and antimony pentachloride are liquids) which readily volatilize on heating. Many are readily soluble in water, the chief exceptions being silver chloride, mercurous chloride, cuprous chloride and palladium chloride which are insoluble in water, and thallic chloride and lead chloride which are only slightly soluble in cold water, but are readily soluble in hot water. Bismuth and antimony chlorides are decomposed by water with production of oxychlorides, whilst titanium tetrachloride yields titanous acid under the same conditions. All the metallic chlorides, with the exception of those of the alkali and alkaline earth metals, are reduced either to the metallic condition or to that of a lower chloride on heating in a current of hydrogen; most are decomposed by concentrated sulphuric acid. They can be distinguished from the corresponding bromides and iodides by the fact that on distillation with a mixture of potassium bichromate and concentrated sulphuric acid they yield chromium oxychloride, whereas bromides and iodides by the same treatment give bromine and iodine respectively. Some metallic chlorides readily form double chlorides, the most important of these double salts being the platinichlorides of the alkali metals. The chlorides of the non-metallic elements are usually volatile fuming liquids of low boiling-point, which can be distilled without decomposition and are decomposed by water. Hydrochloric acid and its metallic salts can be recognized by the formation of insoluble silver chloride, on adding silver nitrate to their nitric acid solution, and also by the formation of chromium oxychloride (see above). Chlorides can be estimated quantitatively by conversion into silver chloride, or if in the form of alkaline chlorides (in the absence of other metals, and of any free acids) by titration with standard silver nitrate solution, using potassium chromate as an indicator.

Chlorine and oxygen do not combine directly, but compounds can be obtained indirectly. Three oxides are known: chlorine monoxide, Cl_2O , chlorine peroxide, ClO_2 , and chlorine heptoxide, Cl_2O_7 .

Chlorine monoxide results on passing chlorine over dry precipitated mercuric oxide. It is a pale yellow gas which can be condensed, on cooling, to a dark-coloured liquid boiling at 5° C. (under a pressure of 737.9 mm.). It is extremely unstable, decomposing with extreme violence on the slightest shock or disturbance, or on exposure to sunlight. It is readily soluble in water, with which it combines to form hypochlorous acid. Sulphur, phosphorus, carbon compounds,

and the alkali metals react violently with the gas, taking fire with explosive decomposition. A. J. Balard determined the volume composition of the gas by decomposition over mercury on gentle warming, followed by the absorption of the chlorine produced with potassium hydroxide, and then measured the residual oxygen.

Chlorine peroxide was first obtained by Sir H. Davy in 1815 by the action of concentrated sulphuric acid on potassium chlorate. As this oxide is a dangerous explosive, great care must be taken in its preparation; the chlorate is finely powdered and added in the cold, in small quantities at a time, to the acid contained in a retort. After solution the retort is gently heated by warm water when the gas is liberated: $-3\text{KClO}_3 + 2\text{H}_2\text{SO}_4 = \text{KClO}_4 + 2\text{KHSO}_4 + \text{H}_2\text{O} + \text{ClO}_2$. A mixture of chlorine peroxide and chlorine is obtained by the action of hydrochloric acid on potassium chlorate, and similarly, on warming a mixture of potassium chlorate and oxalic acid to 70°C . on the water bath, a mixture of chlorine peroxide and carbon dioxide is obtained. Chlorine peroxide must be collected by displacement, as it is soluble in water and readily attacks mercury. It is a heavy gas of a deep yellow colour and possesses an unpleasant smell. It can be liquefied, the liquid boiling at 9.9°C ., and on further cooling it solidifies at -79°C . It is very explosive, being resolved into its constituents by influence of light, on warming, or on application of shock. It is a very powerful oxidant; a mixture of potassium chlorate and sugar in about equal proportions spontaneously inflames when touched with a rod moistened with concentrated sulphuric acid, the chlorine peroxide liberated setting fire to the sugar, which goes on burning. Similarly, phosphorus can be burned under water by covering it with a little potassium chlorate and running in a thin stream of concentrated sulphuric acid (see papers by Bray, *Zeit. phys. Chem.*, 1906, et seq.).

Chlorine heptoxide was obtained by A. Michael by slowly adding perchloric acid to phosphoric oxide below -10°C .; the mixture is allowed to stand for a day and then gently warmed, when the oxide distils over as a colourless very volatile oil of boiling-point 82°C . It turns to a greenish-yellow colour in two or three days and gives off a greenish gas; it explodes violently on percussion or in contact with a flame, and is gradually converted into perchloric acid by the action of water. On the addition of iodine to this oxide, chlorine is liberated and a white substance is produced, which decomposes, on heating to 380°C ., into iodine and oxygen; bromine is without action (see A. Michael, *Amer. Chem. Jour.*, 1900, vol. 23; 1901, vol. 25).

Several oxy-acids of chlorine are known, namely, hypochlorous acid, HClO , chlorous acid, HClO_2 (in the form of its salts), chloric acid, HClO_3 , and perchloric acid, HClO_4 . Hypochlorous acid is formed when chlorine monoxide dissolves in water, and can be prepared (in dilute solution) by passing chlorine through water containing precipitated mercuric oxide in suspension. Precipitated calcium carbonate may be used in place of the mercuric oxide, or a hypochlorite may be decomposed by a dilute mineral acid and the resulting solution distilled. For this purpose a filtered solution of bleaching-powder and a very dilute solution of nitric acid may be employed. The acid is only known in aqueous solution, and only dilute solutions can be distilled without decomposition. The solution has a pale yellow colour, and is a strong oxidizing and bleaching agent; it is readily decomposed by hydrochloric acid, with evolution of oxygen. The salts of this acid are known as hypochlorites, and like the acid itself are very unstable, so that it is almost impossible to obtain them pure. A solution of sodium hypochlorite (*Eau de Javel*), which can be prepared by passing chlorine into a cold aqueous solution of caustic soda, has been extensively used for bleaching purposes. One of the most important derivatives of hypochlorous acid is bleaching powder. Sodium hypochlorite can be prepared by the electrolysis of brine solution in the presence of carbon electrodes, having no diaphragm in the electrolytic cell, and mixing the anode and cathode products by agitating the liquid. The temperature should be kept at about 15°C ., and the concentration of the hypochlorite produced must not be allowed to become too great, in order to prevent reduction taking place at the cathode.

Chlorous acid is not known in the pure condition; but its sodium salt is prepared by the action of sodium peroxide on a solution of chlorine peroxide: $2\text{ClO}_2 + \text{Na}_2\text{O}_2 = 2\text{NaClO}_2 + \text{O}_2$. The silver and lead salts are unstable, being decomposed with explosive violence at 100°C . On adding a caustic alkali solution to one of chlorine peroxide, a mixture of a chlorite and a chlorate is obtained.

Chloric acid was discovered in 1786 by C. L. Berthollet, and is best prepared by decomposing barium chlorate with the calculated amount of dilute sulphuric acid. The aqueous solution can be concentrated *in vacuo* over sulphuric acid until it contains 40% of chloric acid. Further concentration leads to decomposition, with evolution of oxygen and formation of perchloric acid. The concentrated solution is a powerful oxidizing agent; organic matter being oxidized so rapidly that it frequently inflames. Hydrochloric acid, sulphuretted hydrogen and sulphurous acid are rapidly oxidized by chloric acid. J. S. Stas determined its composition by the analysis of pure silver chlorate. The salts of this acid are known as chlorates (*q.v.*)

Perchloric acid is best prepared by distilling potassium perchlorate with concentrated sulphuric acid. According to Sir H. Roscoe, pure perchloric acid distils over at first, but if the distillation be continued

a white crystalline mass of hydrated perchloric acid, $\text{HClO}_4 \cdot \text{H}_2\text{O}$, passes over; this is due to the decomposition of some of the acid into water and lower oxides of chlorine, the water produced then combining with the pure acid to produce the hydrated form. This solid, on redistillation, gives the pure acid, which is a liquid boiling at 39°C . (under a pressure of 56 mm.) and of specific gravity 1.764 (25°C). The crystalline hydrate melts at 50°C . The pure acid decomposes slowly on standing, but is stable in dilute aqueous solution. It is a very powerful oxidizing agent; wood and paper in contact with the acid inflame with explosive violence. In contact with the skin it produces painful wounds. It may be distinguished from chloric acid by the fact that it does not give chlorine peroxide when treated with concentrated sulphuric acid, and that it is not reduced by sulphurous acid. The salts of the acid are known as the *perchlorates*, and are all soluble in water; the potassium and rubidium salts, however, are only soluble to a slight extent. Potassium perchlorate, KClO_4 , can be obtained by carefully heating the chlorate until it first melts and then nearly all solidifies again. The fused mass is then extracted with water to remove potassium chloride, and warmed with hydrochloric acid to remove unaltered chlorate, and finally extracted with water again, when a residue of practically pure perchlorate is obtained. The alkaline perchlorates are isomorphous with the permanganates.

CHLORITE, a group of green micaceous minerals which are hydrous silicates of aluminium, magnesium and ferrous iron. The name was given by A. G. Werner in 1798, from $\chi\lambda\omega\rho\acute{\iota}\tau\iota\varsigma$, "a green stone." Several species and many rather ill-defined varieties have been described, but they are difficult to recognize. Like the micas, the chlorites (or "hydromicas") are monoclinic in crystallization and have a perfect cleavage parallel to the flat face of the scales and plates. The cleavage is, however, not quite so prominent as in the micas, and the cleavage flakes though pliable are not elastic. The chlorites usually occur as salt ($\text{H}=2-3$) scaly aggregates of a dark-green colour. They vary in specific gravity between 2.6 and 3.0, according to the amount of iron present. Well-developed crystals are met with only in the species clinocllore and penninite; those of the former are six-sided plates and are optically biaxial, whilst those of the latter have the form of acute rhombohedra and are usually optically uniaxial. The species prochlorite and corundophilite also occur as more or less distinct six-sided plates. These four better crystallized species are grouped together by G. Tschermak as orthochlorites, the finely scaly and indistinctly fibrous forms being grouped by the same author as leptochlorites.

Chemically, the chlorites are distinguished from the micas by the presence of a considerable amount of water (about 13%) and by not containing alkalis; from the soft, scaly, mineral talc they differ in containing aluminium (about 20%) as an essential constituent. The magnesia (up to 36%) is often in part replaced by ferrous oxide (up to 30%), and the alumina to a lesser extent by ferric oxide; alumina may also be partly replaced by chromic oxide, as in the rose-red varieties k  mmernerite and k  tschubeite. The composition of both clinocllore and penninite is approximately expressed by the formula $\text{H}_8(\text{Mg},\text{Fe})_5\text{Al}_2\text{Si}_3\text{O}_{18}$, and the formulae of prochlorite and corundophilite are $\text{H}_{40}(\text{Mg},\text{Fe})_{22}\text{Al}_3\text{Si}_{13}\text{O}_{90}$ and $\text{H}_{20}(\text{Mg},\text{Fe})_{11}\text{Al}_3\text{Si}_5\text{O}_{45}$ respectively. The variation in composition of these orthochlorites is explained by G. Tschermak by assuming them to be isomorphous mixtures of $\text{H}_4\text{Mg}_3\text{Si}_2\text{O}_9$ (the serpentine molecule) and $\text{H}_4\text{Mg}_2\text{Al}_2\text{SiO}_9$ (which is approximately the composition of the chlorite amesite). The leptochlorites are still more complex, and the intermixture of other fundamental molecules has to be assumed; the species recognized by Dana are daphnite, cronstedtite, thuringite, stilpnomelane, strigovite, diabantite, aphrosiderite, delessite and rumpfite.

The chlorites usually occur as alteration products of other minerals, such as pyroxene, amphibole, biotite, garnet, &c., often occurring as pseudomorphs after these, or as earthy material filling cavities in igneous rocks composed of these minerals. Many altered igneous rocks owe their green colour to the presence of secondary chlorite. Chlorite is also an important constituent of many schistose rocks and phyllites, and of chlorite-schist it is the only essential constituent. Well-crystallized specimens of the species clinocllore are found with crystals of garnet in cavities in chlorite-schist at Achmatovsk near Zlatoust, in the Urals, and at the Ala valley near Turin,

Piedmont; also as large plates at West Chester in Pennsylvania and at other American localities. Crystals of penninite are found in serpentine at Zermatt in Switzerland and in the green schists of the Zillerthal in Tirol.

Closely allied to the chlorites is another group of micaceous minerals known as the vermiculites, which have resulted by the alteration of the micas, particularly biotite and phlogopite. The name is from the Latin *vermicular*, "to breed worms," because when heated before the blowpipe these minerals exfoliate into long worm-like threads. They have the same chemical constituents as the chlorites, but the composition is variable and indefinite, varying with that of the original mineral and the extent of its alteration. Several indistinct varieties have been named, the most important of which is jeffersonite. (L. J. S.)

CHLOROFORM (trichlor-methane), CHCl_3 , a valuable anaesthetic, a colourless liquid, possessing an agreeable smell and a pleasant taste. It may be prepared by the action of bleaching powder on many carbon compounds, such, for example, as ethyl alcohol and acetone (E. Soubeiran, *Ann. chim. phys.*, 1831 [2], 48, p. 131; J. v. Liebig, *Ann.*, 1832, 1, p. 199), by heating chloral with alkalis (Liebig), $\text{CCl}_3\text{CHO} + \text{NaHO} = \text{CHCl}_3 + \text{NaHCO}_2$, or by heating trichloroacetic acid with ammonia (J. Dumas, *Ann.*, 1839, 32, p. 113). In the preparation of chloroform by the action of bleaching powder on ethyl alcohol it is probable that the alcohol is first oxidized to acetaldehyde, which is subsequently chlorinated and then decomposed. Chloroform solidifies in the cold and then melts at -62°C .; it boils at 61.2°C ., and has a specific gravity 1.52637 ($0^\circ/4^\circ$) (T. E. Thorpe). It is an exceedingly good solvent, especially for fats, alkaloids and iodine. It is not inflammable. The vapour of chloroform when passed through a red-hot tube yields hexachlorbenzene C_6Cl_6 , perchlorethane C_2Cl_6 , and some perchlorethylene C_2Cl_4 (W. Ramsay and S. Young, *Jahresberichte*, 1886, p. 628). Chromic acid converts it into phosgene (carbonyl chloride, COCl_2). It reacts with sodium ethylate to form ortho-formic ester, $\text{CH}(\text{OC}_2\text{H}_5)_3$, and when heated with aqueous ammonia for some hours at $200\text{--}220^\circ \text{C}$. gives carbon monoxide and ammonium formate, $2\text{CHCl}_3 + 7\text{NH}_3 + 3\text{H}_2\text{O} = \text{NH}_4\text{HCO}_2 + \text{CO} + 6\text{NH}_4\text{Cl}$ (G. André, *Jahresb.*, 1886, p. 627). When digested with phenols and caustic soda it forms oxaldehydes (K. Reimer, *Ber.*, 1876, 9, p. 423); and when heated with alcoholic potash it is converted into potassium formate, $\text{CHCl}_3 + 4\text{KHO} = \text{KHCO}_2 + 3\text{KCl} + 2\text{H}_2\text{O}$. It combines with acetoacetic ester to form the aromatic compound meta-oxyvitic acid, $\text{C}_6\text{H}_2\text{CH}_2\text{OH}\cdot(\text{COOH})_2$. A hydrate, of composition $\text{CHCl}_3\cdot 18\text{H}_2\text{O}$, has been described (G. Chancel, *Fresenius Zeitschrift f. anal. Chemie*, 1886, 25, p. 118); it forms hexagonal crystals which melt at 1.6°C .

Chloroform may be readily detected by the production of an isonitrile when it is heated with alcoholic potash and a primary amine; thus with aniline, phenyl isocyanide (recognized by its nauseating smell) is produced,

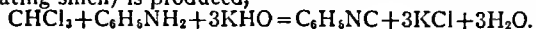

For the action and use of chloroform as an anaesthetic, see ANAESTHESIA. Chloroform may be given internally in doses of from one to five drops. The *British Pharmacopoeia* contains a watery solution—the *Aqua Chloroformi*—which is useful in disguising the taste of nauseous drugs; a liniment which consists of equal parts of camphor liniment and chloroform, and is a useful counter-irritant; the *Spiritus Chloroformi* (erroneously known as "chloric ether"), which is a useful anodyne in doses of from five to forty drops; and the *Tinctura Chloroformi et Morphinae Composita*, which is the equivalent of a proprietary drug called chlorodyne. This tincture contains chloroform, morphine and prussic acid, and must be used with the greatest care.

Externally chloroform is an antiseptic, a local anaesthetic if allowed to evaporate, and a rubefacient, causing the vessels of the skin to dilate, if rubbed in. Its action on the stomach is practically identical with that of alcohol (*q.v.*), though in very much smaller doses. The uses of chloroform which fall to be mentioned here are:—as a counter-irritant; as a local anaesthetic for toothache due to caries, it being applied on a cotton-

wool plug which is inserted into the carious cavity; as an antispasmodic in tetanus and hydrophobia; and as the best and most immediate and effective antidote in cases of strychnine poisoning.

CHLOROPHYLL (from Gr. *χλωρός*, green, *φύλλον*, a leaf), the green colouring matter of leaves. It is universally present in growing vegetable cells. The pigment of leaves is a complex mixture of substances; of these one is green, and to this the name, originally given in 1817 by Pelletier and Caventou, is sometimes restricted; xanthophyll (Gr. *ξανθός*, yellow) is dark brown; carotin is copper-coloured. Chlorophyll is related chemically to the proteids; a decomposition product, phylloporphyrin, being very closely related to haematoporphyrin, which is a decomposition product of haemoglobin, the red colouring matter of the blood. Chlorophyll is neutral in reaction, insoluble in water, but soluble in alcohol, ether, &c., the solutions exhibiting a green colour and a vivid red fluorescence. Magnesium is a necessary constituent. (See S. B. Schryver, *Science Progress*, 1909, 3, p. 425.)

CHLOROSIS (Gr. *χλωρός*, pale green), the botanical term for loss of colour in a plant-organ, a sign of disease; also in medicine, a form of anaemia (see BLOOD: *Pathology*).

CHLORPICRIN (Nitrochloroform), $\text{C}\cdot\text{NO}_2\cdot\text{Cl}_3$, the product of the distillation of many nitro compounds (picric acid, nitromethane, &c.) with bleaching powder; it can also be prepared by the action of concentrated nitric acid on chloral or chloroform. A. W. von Hofmann (*Annalen*, 1866, 139, p. 111) mixed 10 parts of bleaching powder into a paste with cold water and added a solution (saturated at 30°C .) of 1 part of picric acid. A violent reaction is set up and the chlorpicrin distils over, generally without the necessity for any external heating. It is a colourless liquid of boiling-point 112°C ., and of specific gravity 1.692. It is almost insoluble in water, but is readily soluble in alcohol; it has a sharp smell, and its vapour affects the eyes very powerfully. Iron filings and acetic acid reduce it to trimethylamine, whilst alcoholic ammonia converts it into guanidine, $\text{HN}\cdot\text{C}(\text{NH}_2)_2$, and sodium ethylate into ortho-carbonic ester, $\text{C}(\text{OC}_2\text{H}_5)_4$. The corresponding brompicrin is also known.

CHMIELNICKI, BOGDAN (1593–1657), hetman of the Cossacks, son of Michael Chmielnicki, was born at Subatow, near Chigirin in the Ukraine, an estate given to the elder Chmielnicki for his lifelong services to the Polish crown. Bogdan, after learning to read and write, a rare accomplishment in those days, entered the Cossack ranks, was dangerously wounded and taken prisoner in his first battle against the Turks, and found leisure during his two years' captivity at Constantinople to acquire the rudiments of Turkish and French. On returning to the Ukraine he settled down quietly on his paternal estate, and in all probability history would never have known his name if the intolerable persecution of a neighbouring Polish squire, who stole his hayricks and flogged his infant son to death, had not converted the thrifty and acquisitive Cossack husbandman into one of the most striking and sinister figures of modern times. Failing to get redress nearer home, he determined to seek for justice at Warsaw, whither he had been summoned with other Cossack delegates to assist Wladislaus IV. in his long-projected war against the Turks. The king, perceiving him to be a man of some education and intelligence, appointed him *pisarz* or secretary of the registered Cossacks, and he subsequently served under Koniecpolski in the Ukraine campaign of 1646. His hopes of distinction were, however, cut short by a decree of the Polish diet, which, in order to vex the king, refused to sanction the continuance of the war. Chmielnicki, now doubly hateful to the Poles as being both a royalist and a Cossack, was again maltreated and chicaned, and only escaped from gaol by bribing his gaolers. Thirsting for vengeance, he fled to the Cossack settlements on the Lower Dnieper and thence sent messages to the khan of the Crimea, urging a simultaneous invasion of Poland by the Tatars and the Cossacks (1647).

On the 11th of April 1648, at an assembly of the Zaporozhians (see POLAND: *History*), he openly declared his intention of proceeding against the Poles, and was elected ataman by acclamation.

At Zheltnaya Vodui (Yellow Waters) in the Ukraine he annihilated, on the 19th of May, a detached Polish army corps after three days' desperate fighting, and on the 26th routed the main Polish army under the grand hetman, Stephen Potocki, at Kruta Balka (Hard Plank), near the river Korsun. The immediate consequence of these victories was the outbreak of a "serfs' fury." Throughout the Ukraine the Polish gentry were hunted down, flayed and burnt alive, blinded and sawn asunder. Every manor-house was reduced to ashes. Every Uniat and Catholic priest was hung up before his own altar, along with a Jew and a hog. The panic-stricken inhabitants fled to the nearest strongholds, and soon the rebels were swarming all over the palatinates of Volhynia and Podolia. But the ataman was as crafty as he was cruel. Disagreeably awakened to the insecurity of his position by the refusal of the tsar and the sultan to accept him as a vassal, he feigned to resume negotiations with the Poles in order to gain time, dismissed the Polish commissioners in the summer of 1648 with impossible conditions, and on the 23rd of September, after a contest of three days, utterly routed the Polish chivalry, 40,000 strong, at Pildawa, where the Cossacks are said to have reaped an immense booty after the fight was over. All Poland now lay at his feet, and the road to the defenceless capital was open before him; but he wasted the precious months in vain before the fortress of Zamosc, and was then persuaded by the new king of Poland, John Casimir, to consent to a suspension of hostilities. In June 1649, arrayed in cloth-of-gold and mounted on a white charger, Chmielnicki made his triumphal entry into Kiev, where he was hailed as the Maccabaeus of the Orthodox faith, and permitted the committal of unspeakable atrocities on the Jews and Roman Catholics. At the ensuing peace congress at Pereyaslavl he demanded terms so extravagant that the Polish commissioners dared not listen to them. In 1649, therefore, the war was resumed. A bloody battle ensued near Zborow, on the banks of the Strypa, when only the personal valour of the Polish king, the superiority of the Polish artillery, and the defection of Chmielnicki's allies the Tatars enabled the royal forces to hold their own. Peace was then patched up by the compact of Zborow (August 21, 1649), whereby Chmielnicki was virtually recognized as a semi-independent prince.

For the next eighteen months he was the absolute master of the Ukraine, which he divided into sixteen provinces, made his native place Chigirin the Cossack capital, and entered into direct relations with foreign powers. Poland and Muscovy competed for his alliance, and in his more exalted moods he meditated an Orthodox crusade against the Turk at the head of the northern Slavs. But he was no statesman, and his difficulties proved overwhelming. Instinct told him that his old ally the khan of the Crimea was unreliable, and that the tsar of Muscovy was his natural protector, yet he could not make up his mind to abandon the one or turn to the other. His attempt to carve a principality for his son out of Moldavia, which Poland regarded as her vassal, led to the outbreak in 1651 of a third war between subject and suzerain, which speedily assumed the dignity and the dimensions of a crusade. Chmielnicki was now regarded not merely as a Cossack rebel, but as the arch-enemy of Catholicism in eastern Europe, and the pope granted a plenary absolution to all who took up arms against him. But Bogdan himself was not without ecclesiastical sanction. The archbishop of Corinth girded him with a sword which had lain upon the Holy Sepulchre, and the metropolitan of Kiev absolved him from all his sins, without the usual preliminary of confession, before he rode forth to battle. But fortune, so long his friend, now deserted him, and at Beresteczko (July 1, 1651) the Cossack ataman was defeated for the first time. But even now his power was far from broken. In 1652 he openly interfered in the affairs of Transylvania and Walachia, and assumed the high-sounding title of "guardian of the Ottoman Porte." In 1653 Poland made a supreme effort, the diet voted 17,000,000 gulden in subsidies, and John Casimir led an army of 60,000 men into the Ukraine and defeated the arch-rebel at Zranta, whereupon Chmielnicki took the oath of allegiance to the tsar (compact of Pereyaslavl, February 19, 1654),

and all hope of an independent Cossack state was at an end. He died on the 7th of August 1657. With all his native ability, Chmielnicki was but an eminent savage. He was the creature of every passing mood or whim, incapable of cool and steady judgment or of the slightest self-control—an incalculable weather-cock, blindly obsequious to every blast of passion. He could destroy, but he could not create, and other people benefited by his exploits.

See P. Kulish, *On the Defection of Malo-Russia from Poland* (Rus.) (Moscow, 1890); S. M. Solovev, *History of Russia* (Rus.) (Moscow, 1857, &c.), vol. x.; Robert Nisbet Bain, *The First Romanovs*, chaps. 3-4 (London, 1905). (R. N. B.)

CHOATE, JOSEPH HODGES (1832-), American lawyer and diplomat, was born at Salem, Massachusetts, on the 24th of January 1832. He was the son of Dr George Choate, a physician of considerable note, and was a nephew of Rufus Choate. After graduating at Harvard College in 1852 and at the law school of Harvard University in 1854, he was admitted first to the Massachusetts (1855) and then (1856) to the New York bar, and entered the law office of Scudder & Carter in New York City. His success in his profession was immediate, and in 1860 he became junior partner in the firm of Evarts, Southmayd & Choate, the senior partner in which was William M. Evarts. This firm and its successor, that of Evarts, Choate & Beaman, remained for many years among the leading law firms of New York and of the country, the activities of both being national rather than local. During these busy years Mr Choate was associated with many of the most famous litigations in American legal history, including the Tilden, A. T. Stewart, and Stanford will cases, the Kansas prohibition cases, the Chinese exclusion cases, the Maynard election returns case, and the Income Tax Suit. In 1871 he became a member of the "Committee of Seventy" in New York City, which was instrumental in breaking up the "Tweed Ring," and later assisted in the prosecution of the indicted officials. In the retrial of the General Fitz John Porter case he obtained a reversal of the decision of the original court-martial. His greatest reputation was won perhaps in cross-examination. In politics he allied himself with the Republican party on its organization, being a frequent speaker in presidential campaigns, beginning with that of 1856. He never held political office, although he was a candidate for the Republican senatorial nomination against Senator Thomas C. Platt in 1897. In 1894 he was president of the New York state constitutional convention. He was appointed, by President McKinley, ambassador to Great Britain to succeed John Hay in 1899, and remained in this position until the spring of 1905. In England he won great personal popularity, and accomplished much in fostering the good relations of the two great English-speaking powers. He was one of the representatives of the United States at the second Peace Congress at the Hague in 1907.

Several of his notable public addresses have been published. *The Choate Story Book* (New York, 1903) contains a few of his addresses and after-dinner speeches, and is prefaced by a brief biographical sketch.

CHOATE, RUFUS (1799-1859), American lawyer and orator, was born at Ipswich, Massachusetts, on the 1st of October 1799, the descendant of a family which settled in Massachusetts in 1667. As a child he was remarkably precocious; at six he is said to have been able to repeat large parts of the Bible and of *Pilgrim's Progress* by heart. He graduated as valedictorian of his class at Dartmouth College in 1819, was a tutor there in 1819-1820, spent a year in the law school of Harvard University, and studied for a like period at Washington, in the office of William Wirt, then attorney-general of the United States. He was admitted to the Massachusetts bar in 1823 and practised at what was later South Danvers (now Peabody) for five years, during which time he served in the Massachusetts House of Representatives (1825-1826) and in the state senate (1827). In 1828 he removed to Salem, where his successful conduct of several important law-suits brought him prominently into public notice. In 1830 he was elected to Congress as a Whig from the Salem district, defeating the Jacksonian candidate for re-election,

B. W. Crowninshield (1772-1851), a former secretary of the navy, and in 1832 he was re-elected. His career in Congress was marked by a notable speech in defence of a protective tariff. In 1834, before the completion of his second term, he resigned and established himself in the practice of law in Boston. Already his fame as a speaker had spread beyond New England, and he was much sought after as an orator for public occasions. For several years he devoted himself unremittingly to his profession, but in 1841 succeeded Daniel Webster in the United States Senate. Shortly afterwards he delivered one of his most eloquent addresses at the memorial services for President Harrison in Faneuil Hall, Boston. In the Senate he made a series of brilliant speeches on the tariff, the Oregon boundary, in favour of the Fiscal Bank Act, and in opposition to the annexation of Texas. On Webster's re-election to the Senate, Choate resumed (1845) his law practice, which no amount of urging could ever persuade him to abandon for public office, save for a short term as attorney-general of Massachusetts in 1853-1854. In 1853 he was a member of the state constitutional convention. He was a faithful supporter of Webster's policy as declared in the latter's famous "Seventh of March Speech" (1850) and laboured to secure for him the presidential nomination at the Whig national convention in 1852. In 1856 he refused to follow most of his former Whig associates into the Republican party and gave his support to James Buchanan, whom he considered the representative of a national instead of a sectional party. In July 1859 failing health led him to seek rest in a trip to Europe, but he died on the 13th of that month at Halifax, Nova Scotia, where he had been put ashore when it was seen that he probably could not outlive the voyage across the Atlantic. Choate, besides being one of the ablest of American lawyers, was one of the most scholarly of American public men, and his numerous orations and addresses were remarkable for their pure style, their grace and elegance of form, and their wealth of classical allusion.

His *Works* (edited, with a memoir, by S. G. Brown) were published in 2 vols. at Boston in 1862. The *Memoir* was afterwards published separately (Boston, 1870). See also E. G. Parker's *Reminiscences of Rufus Choate* (New York, 1860); E. P. Whipple's *Some Recollections of Rufus Choate* (New York, 1879); and the *Albany Law Review* (1877-1878).

CHOBE, a large western affluent of the middle Zambezi (*q.v.*). The river was discovered by David Livingstone in 1851, and to him was known as the Chobe. It is also called the Linyante and the Kwando, the last name being that commonly used.

CHOCOLATE, a paste of the ground kernels of the cocoa bean, mixed with sugar, vanilla or other flavouring, made into a cake, which is used for the manufacture of various forms of sweetmeat, or in making the beverage, also known as "chocolate," obtained by dissolving cakes of chocolate in boiling water or milk (see COCOA). The word came into Eng. through the Fr. *chocolat* or Span. *chocolate* from the Mex. *chocolall*. According to the *New English Dictionary* (quoting R. Siméon, *Dict. de la langue Nahuatl*), this was "an article of food made of . . . the seeds of cacao and of the tree pochotl (*Bombax ceiba*)," and was etymologically distinct from the Mexican *cacaual*, cacao, or cocoa.

CHOCTAWS, CHAHTAS, or CHACATOS (apparently a corruption of Span. *chato*, flattened), a tribe of North American Indians of Muskogean stock. They are now settled in Oklahoma, but when first known to Europeans they occupied the district now forming the southern part of Mississippi and the western part of Alabama. On the settlement of Louisiana they formed an alliance with the French, and assisted them against the Natchez and Chickasaws; but by degrees they entered into friendly relations with the English, and at last, in 1786, recognized the supremacy of the United States by the treaty of Hopewell. Their emigration westward began about 1800, and the last remains of their original territory were ceded in 1830. In their new settlements the Choctaws continued to advance in prosperity till the outbreak of the Civil War, which considerably diminished the population and ruined a large part of their property. They sided with the Confederates, and their territory was occupied by Confederate troops; and accordingly at the close of the war they were regarded as having lost their rights. Part of their land they

were forced to surrender to the government; their slaves were emancipated; and provision was claimed for them in the shape of either land or money. Since then they have considerably recovered their position. They long constituted a quasi-independent people under the title of the Choctaw nation, and were governed by a chief and a national council of forty members, according to a written constitution, dating in the main from 1838; they possessed a regular judicial system and employed trial by jury. Tribal government virtually ceased in 1906. The Choctaws number 18,000. A few groups still linger in Mississippi and Louisiana. The Choctaw language has been reduced to writing, and brought to some degree of literary precision.

See INDIANS, NORTH AMERICAN; *Handbook of American Indians*, ed. F. W. Hodge (Washington, 1907).

CHODKIEWICZ, JAN KAROL (1560-1621), Polish general, was the son of Hieronymus Chodkiewicz, castellan of Wilna. After being educated at the Wilna academy he went abroad to learn the science of war, fighting in the Spanish service under Alva, and also under Maurice of Nassau. In 1593 he married the wealthy Sophia Mielecka, by whom he had one son who predeceased him. His first military service at home was against the Cossack rising of Nalewajko as lieutenant to Zolkiewski, and he subsequently assisted Zamoyksi in his victorious Moldavian campaign. Honours and dignities were now showered upon him. In 1599 he was appointed starosta of Samogitia, and in 1600 acting commander-in-chief of Lithuania. In the war against Sweden for the possession of Livonia he brilliantly distinguished himself, capturing fortress after fortress and repulsing the duke of Sudermania, afterwards Charles IX, from Riga. In 1604 he captured Dorpat, twice defeated the Swedish generals at Bialy Kamien, and was rewarded with the grand bâton of Lithuania. Criminally neglected by the diet, which from sheer niggardliness turned a deaf ear to all his requests for reinforcements and for supplies and money to pay his soldiers, Chodkiewicz nevertheless more than held his own against the Swedes. His crowning achievement was the great victory of Kirkholm (Aug. 27th, 1605), when with barely 5000 men he annihilated a threefold larger Swedish army; for which feat he received letters of congratulation from the pope, all the Catholic potentates of Europe, and even from the sultan of Turkey and the shah of Persia. Yet this great victory was absolutely fruitless, owing to the domestic dissensions which prevailed in Poland during the following five years. Chodkiewicz's own army, unpaid for years, abandoned him at last *en masse* in order to plunder the estates of their political opponents, leaving the grand hetman to carry on the war as best he could with a handful of mercenaries paid out of the pockets of himself and his friends. Chodkiewicz was one of the few magnates who remained loyal to the king, and after helping to defeat the rebels in Poland a fresh invasion of Livonia by the Swedes recalled him thither, and once more he relieved Riga besides capturing Pernau. Meanwhile the war with Muscovy broke out, and Chodkiewicz was sent against Moscow with an army of 2000 men—though if there had been a spark of true patriotism in Poland he could easily have marshalled 100,000. Moreover, the diet neglected to pay for the maintenance even of this paltry 2000, with the result that they mutinied and compelled their leader to retreat through the heart of Muscovy to Smolensk. Not till the crown prince Wladislaus arrived with tardy reinforcements did the war assume a different character, Chodkiewicz opening a new career of victory by taking the fortress of Drohobu in 1617. The Muscovite war had no sooner been ended by the treaty of Deulina than Chodkiewicz was hastily despatched southwards to defend the southern frontier against the Turks, who after the catastrophe of Cecora (see ZOLKIEWSKI) had high hopes of conquering Poland altogether. An army of 160,000 Turkish veterans led by Sultan Osman in person advanced from Adrianople towards the Polish frontier, but Chodkiewicz crossed the Dnieper in September 1621 and entrenched himself in the fortress of Khotin right in the path of the Ottoman advance. Here for a whole month the Polish hero held the sultan at bay, till the first fall of autumn snow compelled Osman to withdraw

his diminished forces. But the victory was dearly purchased by Poland. A few days before the siege was raised the aged grand hetman died of exhaustion in the fortress (Sept. 24th, 1621).

· See Adam Stanislaw Naruszewicz, *Life of J. K. Chodkiewicz* (Pol.; 4th ed., Cracow, 1857-1858); Lukasz Golebiowski, *The Moral Side of J. K. Chodkiewicz as indicated by his Letters* (Pol.; Warsaw, 1854). (R. N. B.)

CHODOWIECKI, DANIEL NICOLAS (1726-1801), German painter and engraver of Polish descent, was born at Danzig. Left an orphan at an early age, he devoted himself to the practice of miniature painting, the elements of which his father had taught him, as a means of support for himself and his mother. In 1743 he went to Berlin, where for some time he worked as clerk in an uncle's office, practising art, however, in his leisure moments, and gaining a sort of reputation as a painter of miniatures for snuff-boxes. The Berlin Academy, attracted by a small engraving of his, entrusted to him the illustration of its yearly almanac. After designing and engraving several subjects from the story of the Seven Years' War, Chodowiecki produced the famous "History of the Life of Jesus Christ," a set of admirably painted miniatures, which made him at once so popular that he laid aside all occupations save those of painting and engraving. Few books were published in Prussia for some years without plate or vignette by Chodowiecki. It is not surprising, therefore, that the catalogue of his works (Berlin, 1814) should include over 3000 items, of which, however, the picture of "Jean Calas and his Family" is the only one of any reputation. He became director of the Berlin Academy in 1797. The title of the German Hogarth, which he sometimes obtained, was the effect of an admiration rather imaginative than critical, and was disclaimed by Chodowiecki himself. The illustrator of Lavater's *Essays on Physiognomy*, the painter of the "Hunt the Slipper" in the Berlin museum, had indeed but one point in common with the great Englishman—the practice of representing actual life and manners. In this he showed skilful drawing and grouping, and considerable expressional power, but no tendency whatever to the use of the grotesque.

His brother Gottfried (1728-1781) and son Wilhelm (1765-1803) painted and engraved after the style of Daniel, and sometimes co-operated with him.

CHOERILUS. (1) An Athenian tragic poet, who exhibited plays as early as 524 B.C. He was said to have competed with Aeschylus, Pratinas and even Sophocles. According to F. G. Welcker, however, the rival of Sophocles was a son of Choerilus, who bore the same name. Suidas states that Choerilus wrote 150 tragedies and gained the prize 13 times. His works are all lost; only Pausanias (i. 14) mentions a play by him entitled *Alope* (a mythological personage who was the subject of dramas by Euripides and Carcinus). His reputation as a writer of satyric dramas is attested in the well-known line

ἦν ἰκα μὲν βασιλεὺς ἦν Κοιρίλος ἐν Σατύροις.

The Choerilean metre, mentioned by the Latin grammarians, is probably so called because the above line is the oldest extant specimen. Choerilus was also said to have introduced considerable improvements in theatrical masks and costumes.

See A. Nauck, *Tragicorum Graecorum Fragmenta* (1889); F. G. Welcker, *Die griechischen Tragödien*, pp. 18, 892.

(2) An epic poet of Samos, who flourished at the end of the 5th century B.C. After the fall of Athens he settled at the court of Archelaus, king of Macedonia, where he was the associate of Agathon, Melanippides, and Plato the comic poet. The only work that can with certainty be attributed to him is the *Περσική* or *Περσικά*, a history of the struggle of the Greeks against Persia, the central point of which was the battle of Salamis. His importance consists in his having taken for his theme national and contemporary events in place of the deeds of old-time heroes. For this new departure he apologizes in the introductory verses (preserved in the scholiast on Aristotle, *Rhetoric*, iii. 14), where he says that, the subjects of epic poetry being all exhausted, it was necessary to strike out a new path. The story of his intimacy with Herodotus is probably due to the fact that he imitated him and had recourse to his history for the incidents of his poem.

The *Perseis* was at first highly successful and was said to have been read, together with the Homeric poems, at the Panathenaea, but later critics reversed this favourable judgment. Aristotle (*Topica*, viii. 1) calls Choerilus's comparisons far-fetched and obscure, and the Alexandrians displaced him by Antimachus in the canon of epic poets. The fragments are artificial in tone.

G. Kinkel, *Epicorum Graecorum Frag.* i. (1877); for another view of his relations with Herodotus see Müder in *Klio* (1907), 29-44.

(3) An epic poet of Iasus in Caria, who lived in the 4th century B.C. He accompanied Alexander the Great on his campaigns as court-poet. He is well known from the passages in Horace (*Epistles*, ii. 1, 232; *Ars Poetica*, 357), according to which he received a piece of gold for every good verse he wrote in celebration of the glorious deeds of his master. The quality of his verses may be estimated from the remark attributed to Alexander, that he would rather be the Thersites of Homer than the Achilles of Choerilus. The epitaph on Sardanapalus, said to have been translated from the Chaldean (quoted in Athenaeus, viii. p. 336), is generally supposed to be by Choerilus.

See G. Kinkel, *Epicorum Graecorum Fragmenta*, i. (1877); A. F. Näge, *De Choerili Samii Aetate Vita et Poësi atque Choerilis* (1817), where the above poets are carefully distinguished; and the articles in Pauly-Wissowa's *Realencyclopädie*, iii. 2 (1899).

CHOEROBOSCUS, GEORGIUS (c. A.D. 600), deacon and professor at the oecumenical school at Constantinople. He is also called *chartophylax* either as the holder of some ecclesiastical office or as superintendent of the university library. It is not known whether "Choeroboscus" (Gr. for 'swineherd') is an allusion to his earlier occupation or an inherited family name. During his tenure of office he delivered a course of lectures on grammar, which has come down to us in the shape of notes taken by his pupils. He drew from the best authorities—Apollonius Dyscolus, Herodian, Orion, Theodosius of Alexandria. The lectures are written in simple style, but suffer from diffuseness. They were much used by Constantine Lascaris in his Greek grammar and by Urban of Belluno (end of 15th cent.) The chief work of Choeroboscus, which we have in its complete form, is the commentary on the canons of Theodosius on Declension and Conjugation. Mention may also be made of a treatise on orthography, of which a fragment (on Quantity) has been preserved; a tract on prosody; commentaries on Hephæstion and Dionysius Thrax; and grammatical notes on the Psalms.

See C. Krumbacher, *Geschichte der byzantinischen Litteratur* (1897); A. Hilgard, *Grammatici Graeci*, iv. (1889-1894), containing the text of the commentary on Theodosius, and a full account of the life and writings of Choeroboscus; L. Kohn in Pauly-Wissowa's *Realencyclopädie*, iii. 2 (1889); Reitzenstein, *Etymologica*, 190, n. 4.

CHOIR (O. Fr. *cuer* from Lat. *chorus*; pronounced *quire*, and until the end of the 17th century so spelt, the spelling being altered to agree with the Fr. *chœur*), the body of singers who perform the musical portion of the service in a church, or the place set apart for them. Any organized body of singers performing full part choral works or oratorios is also called a choir.

In English cathedrals the choir is composed of men (vicars-choral or lay clerks) and boys (choristers). They are divided into two sets, sitting on the north and south sides of the chancel respectively, called *cantoris* and *decani*, from being on the same side as the *cantor* (precentor) or the *decanus* (dean). This arrangement, together with the custom of vesting choirmen and choristers in surplices (traditional only in cathedrals and collegiate churches), has, since the middle of the 19th century, been adopted in a large number of parish and other churches. Surpliced choirs of women have occasionally been introduced, notably in America and the British colonies, but the practice has no warrant of traditional usage. In the Roman Catholic Church the choir plays a less conspicuous rôle than in the Church of England, its members not being regarded as ministers of the church, and non-Catholics are allowed to sing in it. The singers at Mass or other solemn services are usually placed in a gallery or some other inconspicuous place. The word "choir," indeed, formerly applied to all the clergy taking part in services of the church, and the restriction of the term to the singing men and boys, who were in their origin no more than the representatives

(vicars) of the clergy, is a comparatively late development. The distinction between "choir services" (Mattins, Vespers, Compline, &c.)—consisting of prayers, lections, the singing of the psalms, &c.—and the service of the altar was sharply drawn in the middle ages, as in the modern Roman Church. "Choir vestments" (surplice, &c.) are those worn by the clergy at the former, as distinguished from those used at the Mass (see VESTMENTS). In England at the Reformation the choir services (Mattins, Evensong) replaced the Mass as the principal popular services, and, in general, only the choir vestments were retained in use. In the English cathedrals the members of the choir often retain privileges reminiscent of an earlier definite ecclesiastical status. At Wells, for instance, the vicars-choral form a corporation practically independent of the dean and chapter; they have their own lodgings inside the cathedral precincts (Vicars' Close) and they can only be dismissed by a vote of their own body. (W. A. P.)

In an architectural sense a "choir" is strictly that part of a church which is fitted up for the choir services, and is thus limited to the space between the choir screen and the presbytery. Some confusion has arisen owing to the term being employed by medieval writers to express the entire space enclosed for the performance of the principal services of the church, and therefore to include not only the choir proper, but the presbytery. In the case of a cruciform church the choir is sometimes situated under the central tower, or in the nave, and this is the case in Westminster Abbey, where it occupies four bays to the west of the transept. The choir is usually raised one step above the nave, and its sides are fitted up with seats or stalls, of which in large buildings there are usually two or three rows rising one behind the other.

In Romanesque churches there are eastern and western choirs, and in former times the term was given to chantries and subsidiary chapels, which were also called chancels. In the early Christian church the amboes where the gospels and epistles were read were placed one on either side of the choir and formed part of its enclosure, and this is the case in S. Clemente, S. Lorenzo and S. Maria in Cosmedin in Rome. In England the choir seems almost universally to have assembled at the eastern part of the church to recite the breviary services, whereas on the continent it was moved from one place to another according to convenience. In Spanish churches it occupies the nave of the church, and in the church of the Escorial in Spain was at the west end above the entrance vestibule. (R. P. S.)

CHOISEUL, CÉSAR, Duc DE (1602-1675), French marshal and diplomatist, generally known for the best part of his life as the marshal du Plessis-Praslin, came of the old French family of Choiseul, which arose in the valley of the Upper Marne in the 10th century and divided into many branches, three of the names of which, Hostel, Praslin and du Plessis, were borne, at one time or another, by the subject of this article. Entering the army at the age of fourteen as proprietary colonel of an infantry regiment, he shared in almost all the exploits of the French arms during the reign of Louis XIII. He took part in the siege of La Rochelle, assisted to defend the island of Ré against the attacks of the English under the duke of Buckingham, and accompanied the French forces to Italy in 1629. In 1630 he was appointed ambassador at the court of the duke of Savoy, and was engaged in diplomatic and administrative work in Italy until 1635, when war was declared between France and Spain. In the war that followed Plessis-Praslin distinguished himself in various battles and sieges in Italy, including the action called the "Route de Quiers" and the celebrated four-cornered operations round Turin. In 1640 he was made governor of Turin, and in 1642 lieutenant-general, and after further service in Italy he was made a marshal of France (1645) and appointed second in command in Catalonia. During the first War of the Fronde, which broke out in 1649, he assisted Condé in the brief siege of Paris; and in the second war, remaining loyal to the queen regent and the court party, he won his greatest triumph in defeating Turenne and the allied Spaniards and rebels at Rethel (or Blanc-Champ) in 1650. He then held high

office at the court of Louis XIV., became minister of state in 1652, and in November 1665 was created duc de Choiseul. He was concerned in some of the negotiations between Louis and Charles II. of England which led to the treaty of Dover, and died in Paris on the 23rd of December 1675.

CHOISEUL, ÉTIENNE FRANÇOIS, Duc DE (1719-1785), French statesman, was the eldest son of François Joseph de Choiseul, marquis de Stainville (1700-1770), and bore in early life the title of comte de Stainville. Born on the 28th of June 1719, he entered the army, and during the War of the Austrian Succession served in Bohemia in 1741 and in Italy, where he distinguished himself at the battle of Coni, in 1744. From 1745 until 1748 he was with the army in the Low Countries, being present at the sieges of Mons, Charleroi and Maestricht. He attained the rank of lieutenant-general, and in 1750 married Louise Honorine, daughter of Louis François Crozat, marquis du Châtel (d. 1750), who brought her husband a large fortune and proved a most devoted wife.

Choiseul gained the favour of Madame de Pompadour by procuring for her some letters which Louis XV. had written to his cousin Madame de Choiseul, with whom the king had formerly had an intrigue; and after a short time as *bailli* of the Vosges he was given the appointment of ambassador to Rome in 1753, where he was entrusted with the negotiations concerning the disturbances called forth by the bull *Unigenitus*. He acquitted himself skilfully in this task, and in 1757 his patroness obtained his transfer to Vienna, where he was instructed to cement the new alliance between France and Austria. His success at Vienna opened the way to a larger career, when in 1758 he supplanted Antoine Louis Rouillé (1689-1761) as minister for foreign affairs and so had the direction of French foreign policy during the Seven Years' War. At this time he was made a peer of France and created duc de Choiseul. Although from 1761 until 1766 his cousin César, duc de Choiseul-Praslin (1712-1785), was minister for foreign affairs, yet Choiseul continued to control the policy of France until 1770, and during this period held most of the other important offices of state. As the author of the "Family Compact" he sought to retrieve by an alliance with the Bourbon house of Spain the disastrous results of the alliance with Austria; but his action came too late. His vigorous policy in other departments of state was not, however, fruitless. Coming to power in the midst of the demoralization consequent upon the defeats of Rossbach and Crefeld, by boldness and energy he reformed and strengthened both army and navy, and although too late to prevent the loss of Canada and India, he developed French colonies in the Antilles and San Domingo, and added Corsica and Lorraine to the crown of France. His management of home affairs in general satisfied the *philosophes*. He allowed the *Encyclopédie* to be published, and brought about the banishment of the Jesuits and the temporary abolition of the order by Pope Clement IV.

Choiseul's fall was caused by his action towards the Jesuits, and by his support of their opponent La Chalotais, and of the provincial parlements. After the death of Madame de Pompadour in 1764, his enemies, led by Madame Du Barry and the chancellor Maupeou, were too strong for him, and in 1770 he was ordered to retire to his estate at Chanteloupe. The intrigues against him had, however, increased his popularity, which was already great, and during his retirement, which lasted until 1774, he lived in the greatest affluence and was visited by many eminent personages. Greatly to his disappointment Louis XVI. did not restore him to his former position, although the king recalled him to Paris in 1774, when he died on the 8th of May 1785, leaving behind him a huge accumulation of debt which was scrupulously discharged by his widow.

Choiseul possessed both ability and diligence, and though lacking in tenacity he showed foresight and liberality in his direction of affairs. In appearance he was a short, ill-featured man, with a ruddy countenance and a sturdy frame. His *Mémoires* were written during his exile from Paris, and are merely detached notes upon different questions. Horace Walpole, in his *Memoirs*, gives a very vivid description of the

duke's character, accuses him of exciting the war between Russia and Turkey in 1768 in order to be revenged upon the tsarina Catherine II., and says of his foreign policy, "he would project and determine the ruin of a country, but could not meditate a little mischief or a narrow benefit." "He dissipated the nation's wealth and his own; but did not repair the latter by plunder of the former," says the same writer, who in reference to Choiseul's private life asserts that "gallantry without delicacy was his constant pursuit." Choiseul's widow, a woman "in whom industrious malice could not find an imperfection," lived in retirement until her death on the 3rd of December 1808.

See *Mémoires du duc de Choiseul*, edited by F. Calmettes (Paris, 1904); P. Boutaric, *L'Ambassade de Choiseul à Vienne en 1757-1758* (Paris, 1872); Duc de Cars, *Mémoires* (Paris, 1890); F. J. de P., Cardinal de Bernis, *Mémoires et lettres* (Paris, 1878); Madame de Pompadour, *Correspondance* (Paris, 1878); *Revue historique*, tomes 82 and 87 (Paris, 1903-1905); Horace Walpole, *Memoirs of the Reign of George III.*, edited by G. F. R. Barker (London, 1894); G. Mangros, *Le duc et la duchesse de Choiseul* (Paris, 1903); and *La Disgrace du duc et de la duchesse de Choiseul* (Paris, 1903); E. Calmettes, *Choiseul et Voltaire* (Paris, 1902); A. Bourguet, *Études sur la politique étrangère du duc de Choiseul* (Paris, 1907); and *Le Duc de Choiseul et l'alliance espagnole* (Paris, 1906). See also the *Edinburgh Review* for July 1908.

CHOISEUL-STAINVILLE, CLAUDE ANTOINE GABRIEL, DUC DE (1760-1838), French soldier, was brought up at Chanteloup, under the care of his relative, Étienne François, duc de Choiseul, who was childless. The outbreak of the Revolution found him a colonel of dragoons, and throughout those troublous times he was distinguished for his devotion to the royal house. He took part in the attempt of Louis XVI. to escape from Paris on the 20th of June 1791; was arrested with the king, and imprisoned. Liberated in May 1792, he emigrated in October, and fought in the "army of Condé" against the republic. Captured in 1795, he was confined at Dunkirk; escaped, set sail for India, was wrecked on the French coast, and condemned to death by the decree of the Directory. Nevertheless, he was fortunate enough to escape once more. Napoleon allowed him to return to France in 1801, but he remained in private life until the fall of the Empire. At the Restoration he was called to the House of Peers by Louis XVIII. At the revolution of 1830 he was nominated a member of the provisional government; and he afterwards received from Louis Philippe the post of aide-de-camp to the king and governor of the Louvre. He died in Paris on the 1st of December 1838.

CHOISY, FRANÇOIS TIMOLÉON, ABBÉ DE (1644-1724), French author, was born in Paris on the 16th of August 1644, and died in Paris on the 2nd of October 1724. His father was attached to the household of the duke of Orleans, and his mother, who was on intimate terms with Anne of Austria, was regularly called upon to amuse Louis XIV. By a whim of his mother, the boy was dressed like a girl until he was eighteen, and, after appearing for a short time in man's costume, he resumed woman's dress on the advice—doubtless satirical—of Madame de La Fayette. He delighted in the most extravagant toilettes until he was publicly rebuked by the duc de Montausier, when he retired for some time to the provinces, using his disguise to assist his numerous intrigues. He had been made an abbé in his childhood, and poverty, induced by his extravagance, drove him to live on his benefice at Sainte-Seine in Burgundy, where he found among his neighbours a kindred spirit in Bussy-Rabutin. He visited Rome in the suite of the cardinal de Bouillon in 1676, and shortly afterwards a serious illness brought about a sudden and rather frivolous conversion to religion. In 1685 he accompanied the chevalier de Chaumont on a mission to Siam. He was ordained priest, and received various ecclesiastical preferments. He was admitted to the Academy in 1687, and wrote a number of historical and religious works, of which the most notable are the following:—*Quatre dialogues sur l'immortalité de l'âme*... (1684), written with the Abbé Dangeau and explaining his conversion; *Traduction de l'Imitation de Jésus-Christ* (1692); *Histoire de France sous les règnes de Saint Louis... de Charles V et Charles VI* (5 vols.,

1688-1695); and *Histoire de l'Église* (11 vols., 1703-1723). He is remembered, however, by his gossiping *Mémoires* (1737), which contain striking and accurate pictures of his time and remarkably exact portraits of his contemporaries, although he has otherwise small pretensions to historical accuracy.

The *Mémoires* passed through many editions, and were edited in 1888 by M. de Lescure. Some admirable letters of Choisy are included in the correspondence of Bussy-Rabutin. Choisy is said to have burnt some of his indiscreet revelations, but left a considerable quantity of unpublished MS. Part of this material, giving an account of his adventures as a woman, was surreptitiously used in an anonymous *Histoire de madame la comtesse de Barres* (Antwerp, 1735), and again with much editing in the *Vie de M. l'abbé de Choisy* (Lausanne and Geneva, 1742), ascribed by Paul Lacroix to Lenglet Dufresnoy; the text was finally edited (1870) by Lacroix as *Aventures de l'abbé de Choisy*. See also Sainte-Beuve, *Causeries du lundi*, vol. iii.

CHOLERA (from the Gr. *χολή*, bile, and *ῥέειν*, to flow), the name given to two distinct forms of disease, simple cholera and malignant cholera. Although essentially different both as to their causation and their pathological relationships, these two diseases may in individual cases present many symptoms of mutual resemblance.

SIMPLE CHOLERA (synonyms, *Cholera Europæa*, *British Cholera*, *Summer or Autumnal Cholera*) is the cholera of ancient medical writers, as is apparent from the accurate description of the disease given by Hippocrates, Celsus and Aretæus. Its occurrence in an epidemic form was noticed by various physicians in the 16th century, and an admirable account of the disease was subsequently given by Thomas Sydenham in 1669-1672. This disease is sometimes called *Cholera Nostras*, the word *nostras*, which is good Latin and used by Cicero, meaning "belonging to our country." The relations between it and Asiatic cholera (see below) are obscure. Clinically they may exactly resemble each other, and bacteriology has not been able to draw an absolute line between them. The real difference is epidemiological, cholera nostras having no epidemic significance.

The chief symptoms in well-marked cases are vomiting and purging occurring either together or alternately. The seizure is usually sudden and violent. The contents of the stomach are first ejected, and this is followed by severe retching and vomiting of thin fluid of bilious appearance and bitter taste. The diarrhoea which accompanies or succeeds the vomiting, and is likewise of bilious character, is attended with severe griping abdominal pain, while cramps affecting the legs or arms greatly intensify the suffering: The effect upon the system is rapid and alarming, a few hours of such an attack sufficing to reduce the strongest person to a state of extreme prostration. The surface of the body becomes cold, the pulse weak, the voice husky, and the whole symptoms may resemble in a striking manner those of malignant cholera, to be subsequently described. In unfavourable cases, particularly where the disorder is epidemic, death may result within forty-eight hours. Generally, however, the attack is arrested and recovery soon follows, although there may remain for a considerable time a degree of irritability of the alimentary canal, rendering necessary the utmost care in regard to diet.

Attacks of this kind are of frequent occurrence in summer and autumn in almost all countries. They appear specially liable to occur when cold and damp alternate with heat. Occasionally the disorder prevails so extensively as to constitute an epidemic. The exciting causes of an attack are in many cases errors in diet, particularly the use of unripe fruit and new vegetables, and the excessive drinking of cold liquids during perspiration. Outbreaks of this disorder in a household or community can sometimes be traced to the use of impure water, or to noxious emanations from the sewers.

In the treatment, vomiting should be encouraged so long as it shows the presence of undigested food, after which opiates ought to be administered. Small opium pills, or Dover's powder, or the aromatic powder of chalk with opium, are likely to be retained in the stomach, and will generally succeed in allaying the pain and diarrhoea, while ice and effervescing drinks serve

to quench the thirst and subdue the sickness. In aggravated cases where medicines are rejected, enemata of starch and laudanum, or the hypodermic injection of morphia, ought to be resorted to. Counter-irritation by mustard or turpentine over the abdomen is always of use, as is also friction with the hands where cramps are present. When sinking threatens, brandy and ammonia will be called for. During convalescence the food should be in the form of milk and farinaceous diet, or light soups, and all indigestible articles must be carefully avoided.

In the treatment of this disease as it affects young children (*Cholera Infantum*), most reliance is to be placed on the administration of chalk and the use of starch enemata. In their case opium in any form cannot be safely employed.

MALIGNANT CHOLERA (synonyms, *Asiatic Cholera*, *Indian Cholera*, *Epidemic Cholera*, *Algid Cholera*) is one of the most severe and fatal diseases. In describing the symptoms it is customary to divide them into three stages, but it must be noted that these do not always present themselves in so distinct a form as to be capable of separate recognition. The first or premonitory stage consists in the occurrence of diarrhoea. Frequently of mild and painless character, and coming on after some error in diet, this symptom is apt to be disregarded. The discharges from the bowels are similar to those of ordinary summer cholera, which the attack closely resembles. There is, however, at first the absence of vomiting. This diarrhoea generally lasts for two or three days, and then if it does not gradually subside either may pass into the more severe phenomena characteristic of the second stage of cholera, or on the other hand may itself prove fatal.

The second stage is termed the stage of collapse or the algide or asphyxial stage. As above mentioned, this is often preceded by the premonitory diarrhoea, but not infrequently the phenomena attendant upon this stage are the first to manifest themselves. They come on often suddenly in the night with diarrhoea of the most violent character, the matters discharged being of whey-like appearance, and commonly termed the "rice-water" evacuations. They contain large quantities of disintegrated epithelium from the mucous membrane of the intestines. The discharge, which is at first unattended with pain, is soon succeeded by copious vomiting of matters similar to those passed from the bowels, accompanied with severe pain at the pit of the stomach, and with intense thirst. The symptoms now advance with rapidity. Cramps of the legs, feet, and muscles of the abdomen come on and occasion great agony, while the signs of collapse make their appearance. The surface of the body becomes cold and assumes a blue or purple hue, the skin is dry, sodden and wrinkled, indicating the intense draining away of the fluids of the body, the features are pinched and the eyes deeply sunken, the pulse at the wrist is imperceptible, and the voice is reduced to a hoarse whisper (the *tox cholericæ*). There is complete suppression of the urine.

In this condition death often takes place in less than one day, but in epidemics cases are frequently observed where the collapse is so sudden and complete as to prove fatal in one or two hours even without any great amount of previous purging or vomiting. In most instances the mental faculties are comparatively unaffected, although in the later stages there is in general more or less apathy.

Reaction, however, may take place, and this constitutes the third stage. It consists in the arrest of the alarming symptoms characterizing the second stage, and the gradual but evident improvement in the patient's condition. The pulse returns, the surface assumes a natural hue, and the bodily heat is restored. Before long the vomiting ceases, and although diarrhoea may continue for a time, it is not of a very severe character and soon subsides, as do also the cramps. The urine may remain suppressed for some time, and on returning is often found to be albuminous. Even in this stage, however, the danger is not past, for relapses sometimes occur which speedily prove fatal, while again the reaction may be of imperfect character, and there may succeed an exhausting fever (the so-called typhoid stage of cholera) which may greatly retard recovery, and under which the patient

may sink at a period even as late as two or three weeks from the commencement of the illness.

Many other complications are apt to arise during the progress of convalescence from cholera, such as diphtheritic and local inflammatory affections, all of which are attended with grave danger.

When the attack of cholera is of milder character in all its stages than that above described, it has been named *Cholérine*, but the term is an arbitrary one and the disease is essentially cholera.

The bodies of persons dying of cholera are found to remain long warm, and the temperature may even rise after death. Peculiar muscular contractions have been observed to take place after death, so that the position of the limbs may become altered. The soft textures of the body are found to be dry and hard, and the muscles of a dark brown appearance. The blood is of dark colour and tarry consistence. The upper portion of the small intestines is generally found distended with the rice-water discharges, the mucous membrane is swollen, and there is a remarkable loss of its natural epithelium. The kidneys are usually in a state of acute congestion. This form of cholera belongs originally to Asia, more particularly to India, where, as well as in the Indian archipelago, epidemics are known to have occurred at various times for several centuries.

Much light has been thrown upon Asiatic cholera by Western experience; and the study of the disease by modern methods has resulted in important additions to our previous knowledge of its nature, causation, mode of dissemination and prevention.

The cause is a micro-organism identified by Koch in 1883 (see PARASITIC DISEASES). For some years it was called the "comma bacillus," from its supposed resemblance to be a vibrio or spirillum, not a bacillus. The discovery was received with much scepticism in some quarters, and the claim of Koch's vibrio to be the true cause of cholera was long disputed, but is now universally acknowledged. Few micro-organisms have been more elaborately investigated, but very little is known of its natural history, and its epidemiological behaviour is still surrounded by obscurity. At an important discussion on the subject, held at the International Hygienic Congress in 1894, Professor Gruber of Vienna declared that the deeper investigators went the more difficult the problem became, while M. Elie Metschnikoff of the Pasteur Institute made a similar admission. The difficulty lies chiefly in the variable characters assumed by the organism and the variable effects produced by it. The type, reached by cultivation through a few generations may differ so widely from the original in appearance and behaviour as to be hardly recognizable, while, on the other hand, of two organisms apparently indistinguishable one may be innocuous and the other give rise to the most violent cholera. This variability offers a possible explanation of the frequent failure to trace the origin of epidemic outbreaks in isolated places. It is commonly assumed that the micro-organism is of a specific character, and always introduced from without, when cholera appears in countries or places where it is not endemic. In some cases such introduction can be proved, and in others it can be inferred with a high degree of probability, but sometimes it is impossible to trace the origin to any possible channel of communication. A remarkable case of this kind occurred at the Nietleben lunatic asylum near Halle, in 1893, in the shape of a sudden, explosive and isolated outbreak of true Asiatic cholera. It was entirely confined to the institution, and the peculiar circumstances enabled a very exact investigation to be made. The facts led Professor Arndt, of Greifswald, to propound a novel and interesting theory. No cholera existed in the surrounding district and no introduction could be traced, but for several months in the previous autumn diarrhoea had prevailed in the asylum. The sewage from the establishment was disposed of on a farm, and the effluent passed into the river Saale above the intake of the water-supply for the asylum. Thus a circulation of morbid material through the persons of the inmates was established. Dr Arndt's theory was that by virtue of this circulation cholera was

gradually developed from previously existing intestinal disease of an allied but milder type. The outbreak occurred in winter, and coincided with the freezing of the filter-beds at the water-works. The theory is worth notice, because a similar relation between the drainage and the water-supply frequently exists in places severely attacked by cholera, and it has repeatedly been observed that the latter is preceded by the prevalence of a milder form of intestinal disease. The inference is not that cholera can be developed *de novo*, but that the type is unstable, and that a virulent form may be evolved under favourable conditions from another so mild as to be unrecognized, and consequently undetected in its origin or introduction. This is quite in keeping with the observed variability of the micro-organism, and with the trend of modern research with regard to the relations between other pathogenic germs and the multifarious gradations of type assumed by other zymotic diseases. The same thing has been suggested of diphtheria.

Cholera is endemic in the East over a wide area, ranging from Bombay to southern China, but its chief home is British India.

It principally affects the alluvial soil near the mouths of the great rivers, and more particularly the delta of the Ganges. Lower Bengal is pre-eminently the standing focus and centre of diffusion. In some years it is quiescent, though never absent; in others it becomes diffused, for reasons of which nothing is known, and its diffusive activity varies greatly from equally inscrutable causes. At irregular intervals this property becomes so heightened that the disease passes its natural boundaries and is carried east, north and west, it may be to Europe or beyond to the American continent. We must assume that the micro-organism, like those of other epidemic diseases, acquires greater vitality and toxic energy, or greater power of reproduction at some times than at others, but the conditions that govern this behaviour are quite unknown, though no problem has a more important bearing on public health. Bacteriology, as already intimated, has thrown no light upon it, nor has meteorology. Some results of modern research, indeed, tend to assign increasing importance to the relations between surface soil and certain micro-organisms, and suggest that changes in the level of the subsoil water, to which Professor Max von Pettenkoffer long ago drew attention, may be a dominant factor in determining the latency or activity of pathogenic germs. But this is largely a matter of conjecture, and, so far as cholera is concerned, the conditions which turn an endemic into an epidemic disease must be admitted to be still unknown.

On the other hand, the mode of dissemination is now well understood. Diffusion takes place along the lines of human intercourse. The poison is carried chiefly by infected persons moving from place to place; but soiled clothes, rags and other articles that have come into contact with persons suffering from the disease may be the means of conveyance to a distance. There is no reason to suppose that it is air-borne, or that atmospheric influences have anything to do with its spread, except in so far as meteorological conditions may be favourable to the growth and activity of the micro-organisms. Beyond all doubt, the great manufactory of the poison is the human body, and the discharges from it are the great source of contagion. They may infect the ground, the water, or the immediate surroundings of the patient, and so pass from hand to hand, the poison finding entrance into the bodies of the healthy by means of food and drink which have become contaminated in various ways. Flies which feed upon excreta and other foul matters may be carriers of contagion. Of all the means of local dissemination, contaminated water is by far the most important, because it affects the greatest number of people, and this is particularly the case in places which have a public water-supply. A single contaminated source may expose the entire population to danger. All severe outbreaks of an explosive character are due to this cause. It is also possible that the cholera poison multiplies rapidly in water under favourable conditions, and that a reservoir, for instance, may form a sort of forcing-bed. But it would be a mistake to regard cholera as purely a water-borne disease, even locally. It may infect the soil in localities which have a perfectly pure water-

supply, but have defective drainage or no drainage at all, and then it will be found more difficult to get rid of, though less formidable in its effects, than when the water alone is the source of mischief. In all these respects it has a great affinity to enteric fever. With regard to locality, no situation can be said to be free from attack if the disease is introduced and the sanitary conditions are bad; but, speaking generally, low-lying places on alluvial soil near rivers are more liable than those standing high or on a rocky foundation. Of meteorological conditions it can only be said with certainty that a high temperature favours the development of cholera, though a low one does not prevent it. In temperate climates the summer months, and particularly August and September, are the season of its greatest activity.

Cholera spreads westwards from India by two routes—(1) by sea to the shores of the Red Sea, Egypt and the Mediterranean; and (2) by land to northern India and Afghanistan, thence to Persia and central Asia, and so to Russia. In the great invasions of Europe during the 19th century it sometimes followed one route and sometimes the other. It was not till 1817 that the attention of European physicians was specially directed to the disease by the outbreak of a violent epidemic of cholera at Jessore in Bengal. This was followed by its rapid spread over a large portion of British India, where it caused immense destruction of life both among natives and Europeans. During the next three years cholera continued to rage all over India, as well as in Ceylon and others of the Indian islands. The disease now began to spread over a wider extent than hitherto, invading China on the east and Persia on the west. In 1823 it had extended into Asia Minor and Russia in Asia, and it continued to advance steadily though slowly westwards, while at the same time fresh epidemics were appearing at intervals in India. From this period up till 1830 no great extension of cholera took place, but in the latter year it reappeared in Persia and along the shores of the Caspian Sea, and thence entered Russia in Europe. Despite the strictest sanitary precautions, the disease spread rapidly through that whole empire, causing great mortality and exciting consternation everywhere. It ravaged the northern and central parts of Europe, and spread onwards to England, appearing in Sunderland in October 1831, and in London in January 1832, during which year it continued to prevail in most of the cities and large towns of Great Britain and Ireland. The disease subsequently extended into France, Spain and Italy, and crossing the Atlantic spread through North and Central America. It had previously prevailed in Arabia, Turkey, Egypt and the Nile district, and in 1835 it was general throughout North Africa. Up till 1837 cholera continued to break out in various parts of the continent of Europe, after which this epidemic disappeared, having thus within twenty years visited a large portion of the world.

About the year 1841 another great epidemic of cholera appeared in India and China, and soon began to extend in the direction traversed by the former, but involving a still wider area. It entered Europe again in 1847, and spread through Russia and Germany on to England, and thence to France, whence it passed to America, and subsequently appeared in the West Indies. This epidemic appears to have been even more deadly than the former, especially as regards Great Britain and France. A third great outbreak of cholera took place in the East in 1850, entering Europe in 1853. During the two succeeding years it prevailed extensively throughout the continent, and fell with severity on the armies engaged in the Crimean War. Although widely prevalent in Great Britain and Ireland it was less destructive than former epidemics. It was specially severe throughout both North and South America. A fourth epidemic visited Europe again in 1865-1866, but was on the whole less extensive and destructive than its predecessors.

By some writers the epidemic of 1853 is regarded as a recrudescence of that of 1847. The earlier ones followed the land route by way of Afghanistan and Persia, and took several years to reach Europe. That of 1865 travelled more rapidly, being carried from Bombay by sea to Mecca, from there to Suez and Alexandria, and then on to various Mediterranean ports. Within

Western diffusion.

the year it had not only spread extensively in Europe, but had reached the West Indies. In 1866 it invaded England and the United States, but during the following year it died down in the West. The subsequent history of cholera in Europe may be stated chronologically.

1869-1874.—This invasion was traced to the great gathering of pilgrims at Hardwar on the Upper Ganges in the month of April 1867. From there the returning pilgrims carried it to the Punjab, Kashmir and Afghanistan, whence it spread to Persia and the Caspian, but it did not reach Russia until 1869. During the next four years a number of outbreaks occurred in central Europe, and notably one at Munich in the winter of 1873. The irregular character of these epidemics suggests that they were rather survivals from the pandemic wave of 1867 than fresh importations, but there is no doubt that cholera was carried overland into Russia in the manner described.

1883-1887.—This visitation, again, came by the Mediterranean. In 1883 a severe outbreak occurred in Egypt, causing a mortality of above 25,000. Its origin remained unknown. During this epidemic Koch discovered the comma bacillus. The following year cholera appeared at Toulon. It was said to have been brought in a troopship from Saigon in Cochin-China, but it may have been connected with the Egyptian epidemic. A severe outbreak followed and reached Italy, nearly 8000 persons dying in Naples alone. In 1885 the south of France, Italy, Sicily and Spain all suffered, especially the last, where nearly 120,000 deaths occurred. Portugal escaped, and the authorities there attributed their good fortune to the institution of a military cordon, in which they have had implicit confidence ever since. In 1886 the same countries suffered again, and also Austria-Hungary. From Italy the disease was carried to South America, and even travelled as far as Chile, where it had previously been unknown. In 1887 it still lingered in the Mediterranean, causing great mortality in Messina especially. According to Dr A. J. Wall, this epidemic cost 250,000 lives in Europe and at least 50,000 in America. A particular interest attaches to it in the fact that a localized revival of the disease was caused in Spain in 1890 by the disturbance of the graves of some of the victims who had died of cholera four years previously.

1892-1895.—This great invasion reverted again to the old overland route, but the march of the disease was of unprecedented rapidity. Within less than five months it travelled from the North-West Provinces of India to St Petersburg, and probably to Hamburg, and thence in a few days to England and the United States. This speed, in such striking contrast to the slow advance of former occasions, was attributed, and no doubt rightly, to improved steam transit, and particularly the Transcaspian railway. The progress of the disease was traced from place to place, and almost from day to day, with great precision, showing how it moves along the chief highways and is obviously carried by man. The main facts are as follows:—Cholera was extensively and severely prevalent in India in 1891, causing 601,603 deaths, the highest mortality since 1877. In March 1892 it broke out at the Hardwar fair, a day or two before the pilgrims dispersed; on the 19th of April it was at Kabul, on the 1st of May at Herat, and on the 26th of May at Meshed. From Meshed it moved in three directions—due west to Teheran in Persia, north-east by the Transcaspian railway to Samarkand in Central Asia, and north-west by the same line in the opposite direction to Uzun-ada on the Caspian Sea. It reached Uzun-ada on the 6th of June; crossed to Baku, June 18th; Astrakhan, June 24th; then up the Volga to Nizhny-Novgorod, arriving at Moscow and St Petersburg early in August. The part played by steam transit is clear from the fact that the disease took no longer to travel all the way from Meshed to St Petersburg by rail and steamboat than to traverse the short distance from Meshed to Teheran by road. On the 16th of August cases began to occur in Hamburg; on the 19th of August a fireman was taken ill at Grangemouth in Scotland, where he had arrived the day before from Hamburg; and on the 31st of August a vessel reached New York from the same port with cholera on board. On the 8th of September the disease appeared in Galicia,

having moved somewhat slowly westwards across Russia into Poland, and on the 26th of September it was in Budapest. Holland and Servia were also attacked, while isolated cases were carried to Norway, Denmark and Italy. Meanwhile two entirely separate epidemics were in progress elsewhere. The first was confined to Arabia and the Somali coast of Africa, and was connected with the remains of an outbreak in Syria and Arabia in 1890-1891. The second arose mysteriously in France about the time when the overland invasion started from India. The first known case occurred in the prison at Nanterre, near Paris, on the 31st of March. Paris was affected in April, and Havre in July. The origin of this outbreak, which was of a much less violent character than that which came simultaneously by way of Russia, was never ascertained. Its activity was confined to France, particularly in the neighbourhood of Paris, together with Belgium and Holland, which was placed between two fires, but escaped with but little mortality. The number of persons killed by cholera in 1892, outside of India, was reckoned at 378,449, and the vast majority of those died within six months. The countries which suffered most severely were as follows:—European Russia, 151,626; Caucasus, 69,423; Central Asian Russia, 31,804; Siberia, 15,037—total for Russian empire, 267,890; Persia, 63,982; Somaliland, 10,000; Afghanistan, 7,000; Germany, 9563; France, 4550; Hungary, 1255; Belgium, 961. Curiously enough, the south of Europe, which had been the scene of the previous epidemic visitation, escaped. The disease was of the most virulent character. In European Russia the mortality was 45.8% of the cases, the highest rate ever known in that country; in Germany it was 51.3%; and in Austria-Hungary, 57.5%. Of all the localities attacked, the case of Hamburg was the most remarkable. The presence of cholera was first suspected on the 16th of August, when two cases occurred, but it was not officially declared until the 23rd of August. By that time the daily number of victims had already risen to some hundreds, while the experts and authorities were making up their minds whether they had cholera to deal with or not. Their decision eventually came too late and was superfluous, for by the 27th of August the people were being stricken down at the rate of 1000 a day. This rate was maintained for four days, after which the vehemence of the pestilence began to abate. It gradually declined, and ceased on the 14th of November. During those three months 16,956 persons were attacked and 8605 died, the majority within the space of a few weeks. The town, ordinarily one of the gayest places of business and pleasure on the continent, became a city of the dead. Thousands of persons fled, carrying the disease into all parts of Germany; the rest shut themselves indoors; the shops were closed, the trams ceased to run, the hotels and restaurants were deserted, and few vehicles or pedestrians were seen in the streets. At the cemetery, which lies about 10 m. from the town, some hundreds of men were engaged day and night digging long trenches to hold double rows of coffins, while the funerals formed an almost continuous procession along the roads; even so the victims could not be buried fast enough, and their bodies lay for days in sheds hastily run up as mortuaries. Hamburg had been attacked by cholera on fourteen previous occasions, beginning with 1831, but the mortality had never approached that of 1892; in the worst year, which was 1832, there were only 3687 cases and 1765 deaths. The disease was believed to have been introduced by Jewish emigrants passing through on their way from Russia, but the importation could not be traced. The Jews were segregated and kept under careful supervision from the middle of July onwards, and no recognized case occurred among them. The total number of places in Germany in which cholera appeared in 1892 was 269, but it took no serious hold anywhere save in Hamburg. The distribution was chiefly by the waterways, which seem to affect a larger number of places than the railways as carriers of cholera. In Paris 907 persons died, and in Havre 498. Between the 18th of August and the 21st of October 38 cases were imported into England and Scotland through eleven different ports, but the disease nowhere obtained a footing. Seven vessels brought 72 cases to the United States,

and 16 others occurred on shore, but there was no further dissemination.

During the winter of 1892-1893 cholera died down, but never wholly ceased in Russia, Germany, Austria-Hungary and France. With the return of warm weather it showed renewed activity, and prevailed extensively throughout Europe. The recorded mortality for the principal countries was as follows:—Russia (chiefly western provinces), 41,047; Austria-Hungary, 4669; France, 4000; Italy, 3036; Turkey, 1500; Germany, 298; Holland, 376; Belgium, 372; England, 139. Hardly any country escaped altogether; but Europe suffered less than Arabia, Mesopotamia and Persia. Cholera broke out at Mecca in June, and owing to the presence of an exceptionally large number of pilgrims caused an appalling mortality. The chief shereef estimated the mortality at 50,000. The pilgrims carried the disease to Asia Minor and Constantinople. In Persia also a recrudescence took place and proved enormously destructive. Dr Barry estimated the mortality at 70,000. At Hamburg, where new waterworks had been installed with sand filtration, only a few sporadic cases occurred until the autumn, when a sudden but limited rush took place, which was traced to a defect in the masonry permitting unfiltered Elbe water to pass into the mains. In England cholera obtained a footing on the Humber at Grimsby, and to a lesser extent at Hull, and isolated attacks occurred in some 50 different localities. Excluding a few ship-borne cases the registered number of attacks was 287, with 135 deaths, of which 9 took place in London. It is interesting to compare the mortality from cholera in England and Wales, and in London, for each year in which it has prevailed since registration began:—

Year.	England and Wales.		London.	
	Deaths.	Deaths per 10,000 living.	Deaths.	Deaths per 10,000 living.
{ 1848	1,908	1.1	652	2.9
{ 1849	53,293	30.3	14,137	61.8
{ 1853	4,419	2.4	883	3.5
{ 1854	20,097	10.9	10,738	42.8
{ 1865	1,297	0.6	196	0.6
{ 1866	14,378	6.8	5,596	18.4
{ 1893	135	0.05	9	0.002
{ 1894	nil	nil	nil	nil

In 1894 no deaths from cholera were recorded in England, but on the continent it still prevailed over a wide area. In Russia over 30,000 persons died of it, in Germany about 500, but the most violent outbreak was in Galicia, where upwards of 8000 deaths were registered. In 1895 it still lingered, chiefly in Russia and Galicia, but with greatly diminished activity. In that year Egypt, Morocco and Japan were attacked, the last severely. The disease then remained in abeyance until the severe epidemic in India in 1900.

The great invasion just described was fruitful in lessons for the prevention of cholera. It proved that the one real and sufficient protection lies in a standing condition of good sanitation backed by an efficient and vigilant sanitary administration. The experience of Great Britain was a remarkable piece of evidence, but that of Berlin was perhaps even more striking, for Berlin lay in the centre of four fires, in direct and frequent communication with Hamburg, Russia, France and Austria, and without the advantage of a sea frontier. Cholera was repeatedly brought into Berlin, but never obtained a footing, and its successful repression was accomplished without any irksome interference with traffic or the ordinary business of life. The general success of Great Britain and Germany in keeping cholera in check by ordinary sanitary means completed the conversion of all enlightened nations to the policy laid down so far back as 1865 by Sir John Simon, and advocated by Great Britain at a series of international congresses—the policy of abandoning quarantine, which Great Britain did in 1873, and trusting to sanitary measures with medical inspection of persons arriving from infected places. This principle was formally adopted at the international con-

ference held at Dresden in 1893, at which a convention was signed by the delegates of Germany, Austria, Belgium, France, Great Britain, Italy, Russia, Switzerland, Luxemburg, Montenegro and the Netherlands. Under this instrument the practice is broadly as follows, though the procedure varies a good deal in different countries:—Ships arriving from infected ports are inspected, and if healthy are not detained, but bilge-water and drinking-water are evacuated, and persons landing may be placed under medical supervision without detention; infected ships are detained only for purposes of disinfection; persons suffering from cholera are removed to hospital; other persons landing from an infected ship are placed under medical observation, which may mean detention for five days from the last case, or, as in Great Britain, supervision in their own homes, for which purpose they give their names and places of destination before landing. All goods are freed from restrictions, except rags and articles believed to be contaminated by cholera matters. By land, passengers from infected places are similarly inspected at the frontiers and their luggage “disinfected”—in all cases a pious ceremony of no practical value, involving a short but often a vexatious delay; only those found suffering from cholera can be detained. Each nation is pledged to notify the others of the existence within its own borders of a “foyer” of cholera, by which is meant a focus or centre of infection. The precise interpretation of the term is left to each government, and is treated in a rather elastic fashion by some, but it is generally understood to imply the occurrence of non-imported cases in such a manner as to point to the local presence of infection. The question of guarding Europe generally from the danger of diffusion by pilgrims through the Red Sea was settled at another conference held in Paris in 1894. The provisions agreed on included the inspection of pilgrims at ports of departure, detention of infected or suspected persons, and supervision of pilgrims and of pilgrims proceeding overland to Mecca.

The substitution of the procedure above described for the old measures of quarantine and other still more drastic interferences with traffic presupposes the existence of a sanitary service and fairly good sanitary conditions if cholera is to be effectually prevented. No doubt if sanitation were perfect in any place or country, cholera, along with many other diseases, might there be ignored, but sanitation is not perfect anywhere, and therefore it requires to be supplemented by a system of notification with prompt segregation of the sick and destruction of infective material. These things imply a regular organization, and it is to the public health service of Great Britain that the complete mastery of cholera has mainly been due in recent years, and particularly in 1893. Of sanitary conditions the most important is unquestionably the water-supply. So many irrefragable proofs of this fact were given during 1892-1893 that it is no longer necessary to refer to the time-honoured case of the Broad Street pump. At Samarkand three regiments were encamped side by side on a level plain close to a stream of water. The colonel of one regiment took extraordinary precautions, placing a guard over the river, and compelling his men to use boiled water even for washing. Not a single case of cholera occurred in that regiment, while the others, in which only ordinary precautions were taken, lost over 100 men. At Askabad the cholera had almost disappeared, when a banquet was given by the governor in honour of the tsar's name-day. Of the guests one-half died within twenty-four hours; a military band, which was present, lost 40 men out of 50; and one regiment lost half its men and 9 officers. Within forty-eight hours 1300 persons died out of a total population of about 13,000. The water supply came from a small stream, and just before the banquet a heavy rain-storm had occurred, which swept into the stream all surface refuse from an infected village higher up and some distance from the banks. But the classical example was Hamburg. The water-supply is obtained from the Elbe, which became infected by some means not ascertained. The drainage from the town also runs into the river, and the movement of the tide was sufficient to carry the sewage matter up above the water-intake. The water itself, which is no cleaner than that of the Thames

at London Bridge, underwent no purification whatever before distribution. It passed through a couple of ponds, supposed to act as settling tanks, but owing to the growth of the town and increased demand for water it was pumped through too rapidly to permit of any subsidence. Eels and other fish constantly found their way into the houses, while the mains were lined with vegetation and crustacea. The water-pipes of Hamburg had a peculiar and abundant fauna and flora of their own, and the water they delivered was commonly called *Fleischbrühe*, from its resemblance to thick soup. On the other hand, at Altona, which is continuous with Hamburg, the water was filtered through sand. In all other respects the conditions were identical, yet in Altona only 328 persons died, against 8605 in Hamburg. In some streets one side lies in Hamburg, the other in Altona, and cholera stopped at the dividing line, the Hamburg side being full of cases and the Altona side untouched. In the following year, when Hamburg had the new filtered supply, it enjoyed equal immunity, save for a short period when, as we have said, raw Elbe water accidentally entered the mains.

But water, though the most important condition, is not the only one affecting the incidence of cholera. The case of Grimsby furnished a striking lesson to the contrary. Here the disease obtained a decided hold, in spite of a pure water-supply, through the fouling of the soil by cesspits and defective drainage. At Havre also its prevalence was due to a similar cause. Further, it was conclusively proved at Grimsby that cholera can be spread by sewage-fed shell-fish. Several of the local outbreaks in England were traced to the ingestion of oysters obtained from the Grimsby beds. In short, it may be said that all insanitary conditions favour the prevalence of cholera in some degree. Preventive inoculation with an attenuated virus was introduced by W. M. W. Haffkine, and has been extensively used in India, with considerable appearance of success so far as the statistical evidence goes.

As already remarked, the latest manifestations of cholera show that it has lost none of its former virulence and fatality.

Treatment. The symptoms are now regarded as the effects of the toxic action of the poison formed by the micro-organisms upon the tissues and especially upon the nervous system. But this theory has not led to any effective treatment. Drugs in great variety were tried in the continental hospitals in 1892, but without any distinct success. The old controversy between the aperient and the astringent treatment reappeared. In Russia the former, which aims at evacuating the poison, was more generally adopted; in Germany the latter, which tries to conserve strength by stopping the flux, found more favour. Two methods of treatment were invariably found to give great relief, if not to prolong life and promote recovery—the hot bath and the injection of normal saline solution into the veins or the subcutaneous tissue. These two should always be tried in the cold and collapsed stages of cholera.

See *Local Government Board Reports, 1892-93-94-95*; Clemow, *The Cholera Epidemic of 1892 in the Russian Empire*; Wall, *Asiatic Cholera*; Notter, *Epidemiological Society's Transactions*, vol. xvii.; Emmerich and Gemünd, *München. med. Wochenschr.* (1904), pp. 1086-1157; Wherry, *Department of the Interior Bureau of Government Laboratories*, No. 19 (October 1904, Manila); Wherry and McDill, *Ibid.* No. 31 (May 1905, Manila).

CHOLET, a town of western France, capital of an arrondissement in the department of Maine-et-Loire, 41 m. S.E. of Nantes on the Ouest-État railway between that town and Poitiers. Pop. (1906) 16,554. Cholet stands on an eminence on the right bank of the Moine, which is crossed by a bridge of the 15th century. A public garden occupies the site of the old castle; the public buildings and churches, the finest of which is Notre-Dame, are modern. The public institutions include the sub-prefecture, a tribunal of first instance, a chamber of commerce, a board of trade-arbitrators, and a communal college. There are granite quarries in the vicinity of the town. The chief industry is the manufacture of linen and linen handkerchiefs, which is also carried on in the neighbouring communes on a large scale. Woollen and cotton fabrics are also produced, and bleaching and the manufacture of preserved foods are carried on. Cholet

is the most important centre in France for the sale of fat cattle, sheep and pigs, for which Paris is the chief market. Megalithic monuments are numerous in the neighbourhood. The town owes the rise of its prosperity to the settlement of weavers there by Edouard Colbert, count of Maulévrier, a brother of the great Colbert. It suffered severely in the War of La Vendée of 1793, insomuch that for years afterwards it was almost without inhabitants.

CHOLON ("great market"), a town of French Indo-China, the largest commercial centre of Cochin China, $3\frac{1}{2}$ m. S.W. of Saigon, with which it is united by railway, steam-tramway and canal. Cholon was founded by Chinese immigrants about 1780, and is situated on the Chinese arroyo at the junction of the Lo-Gom and a canal. Its waterways are frequented by innumerable boats and lined in some places with native dwellings built on piles, in others by quays and houses of French construction. Its population is almost entirely Asiatic, and has more than trebled since 1880. In that year it had only 45,000 inhabitants; in 1907 it numbered about 138,000. Of these, 42,000 were Chinese, 73,000 Annamese, and 155 French (exclusive of a garrison of 92); the remainder consisted of Cambodians and Asiatic foreigners. During the rice season the town is visited by a floating population of 21,000 persons. The Chinese are divided into congregations according to their place of origin. Cholon is administered by a municipal council, composed of French, Annamese and Chinese traders. An administrator of native affairs, nominated by the governor, fills the office of mayor. There are a fine municipal hospital and municipal schools for boys and girls. The principal thoroughfares are lighted by electric light. The rice trade, almost monopolized by the Chinese, is the leading industry, the rice being treated in large steam mills. Tanning, dyeing, copper-founding, glass, brick and pottery manufacture, stone working, timber-sawing and junk building are also included among the industries.

CHOLONES, a tribe of South American Indians living on the left bank of the Huallaga river in the Amazon valley. The name is that given them by the Spanish. They were first met by the Franciscans, who established mission villages among them in 1676. They are a wild race but mild-mannered, very superstitious, and pride themselves on their skill as doctors. Their chief weapon is the blow-pipe, in the use of which they are adepts.

CHOLULA, an ancient town of Mexico, in the state and on the plateau of Puebla, 8 m. by rail W. by N. of the city of that name, and 6912 ft. above sea-level. Pop. (1900, estimate) 9000. The Interoceanic railway passes through Cholula, but the city's commercial and industrial standing is overshadowed by that of its larger and more modern neighbour. At the time of the Spanish Conquest, Cholula—then known as Chololan—was a large and important town, consecrated to the worship of the god Quetzalcoatl, who had here one of the most imposing temples in Anahuac, built on the summit of a truncated pyramid, the largest of its kind in the world. This pyramid, constructed of sun-dried bricks and earth, 177 ft. high, and covering an area of nearly 45 acres, is the most conspicuous object in the town and is surmounted by a chapel dedicated to *Nuestra Señora de los Remedios*. A corner of the lower terrace of this great pyramid was cut through in the construction of the Puebla road, but nothing was discovered to explain its purpose, which was probably that of furnishing an imposing site for a temple. Nothing definite is known of its age and history, as the fanatical zeal of Cortez and his companions destroyed whatever historical data the temple may have contained. Cholula was visited by Cortez in 1519 during his eventful march inland to Montezuma's capital, Tenochtitlan, when he treacherously massacred its inhabitants and pillaged the city, pretending to distrust the hospitable inhabitants. Cortez estimated that the town then had 20,000 habitations, and its suburbs as many more, but this was undoubtedly a deliberate exaggeration. The Cholulans were of Nabuatl origin and were semi-independent, yielding only a nominal allegiance to Montezuma. They were a trading people, holding fairs, and exchanging their manufactures of textiles and pottery for other produce. The pyramid is believed

to have been built by a people occupying this region before the Cholutans.

CHOPIN, FREDERIC FRANÇOIS (1810-1849), Polish musical composer and pianist, was born at Zelazowa-Wola, near Warsaw, on the 22nd of February 1810 (not the 1st of March 1809). His father, of French origin, born at Nancy in 1770, had married a Polish lady, Justine Krzyzanowska. Frederic was their third child. His first musical education he received from Adalbert Ziwny, a Czech musician, who is said to have been a passionate admirer of J. S. Bach. He also received a good general education at one of the first colleges of Warsaw, where he was supported by Prince Antoine Radziwill, a generous protector of artistic talent and himself well known as the composer of music to Goethe's *Faust* and other works. His musical genius opened to Chopin the best circles of Polish society, at that time unrivalled in Europe for its ease of intercourse, the beauty and grace of its women, and its liberal appreciation of artistic gifts. These early impressions were of lasting influence on Chopin's development. While at college he received thorough instruction in the theory of his art from Joseph Elsner, a learned musician and director of the conservatoire at Warsaw. When in 1829 he left his native town for Vienna, where his *début* as a pianist took place, he was in all respects a perfectly formed and developed artist. There is in his compositions little of that gradual progress which, for instance, in Beethoven necessitates a classification of his works according to different periods. Chopin's individuality and his style were distinctly pronounced in that set of variations on "La ci darem" which excited the wondering enthusiasm of Robert Schumann. In 1831 he left Vienna with the intention of visiting London; but on his way to England he reached Paris and settled there for the rest of his life. Here again he soon became the favourite and musical hero of society. His connexion with Madame Dudevant, better known by her literary pseudonym of George Sand (*q.v.*), is an important feature of Chopin's life. When in 1839 his health began to fail, George Sand went with him to Majorca, and it was mainly owing to her tender care that the composer recovered his health for a time. Chopin declared that the destruction of his relations with Madame Dudevant in 1847 broke up his life. The association of these two artists has provoked a whole literature on the nature of their relations, of which the novelist's *Un Hiver à Majorque* was the beginning. The last ten years of Chopin's life were a continual struggle with the pulmonary disease to which he succumbed in Paris on the 17th of October 1849. The year before his death he visited England, where he was received with enthusiasm by his numerous admirers. Chopin died in the arms of his sister, who hastened from Poland to his death-bed. He was buried in the cemetery of Père Lachaise. A small monument was erected to the memory of the composer at Wasswan in 1880. Portraits and medallions of Chopin were executed by Ary Scheffer and Eugène Delacroix, and by the sculptors Bary and Clésinger.

A distinguished English amateur thus records his impressions of Chopin's style of pianoforte-playing compared with those of other masters. "His technical characteristics may be broadly indicated as negation of *bravura*, absolute perfection of finger-play, and of the *legalissimo* touch, on which no other pianist has ever so entirely leant, to the exclusion of that high relief and point which the modern German school, after the examples of Liszt and Thalberg, has so effectively developed. It is in these features that we must recognize that *Grundverschiedenheit* (fundamental difference) which according to Mendelssohn distinguished Chopin's playing from that of these masters, and in no less degree from the example and teaching of Moscheles. . . . Imagine a delicate man of extreme refinement of mien and manner, sitting at the piano and playing with no sway of the body and scarcely any movement of the arms, depending entirely upon his narrow, feminine hands and slender fingers. The wide arpeggios in the left hand, maintained in a continuous stream of tone by the strict legato and fine and constant use of the damper-pedal, formed an harmonious substructure for a wonderfully poetic cantabile. His delicate pianissimo, the ever-changing modifications of tone and time (*tempo rubato*) were of indescribable effect. Even in

energetic passages he scarcely ever exceeded an ordinary *mezzo-forte*. His playing as a whole was unique in its kind, and no traditions of it can remain, for there is no school of Chopin the pianist, for the obvious reason that he could never be regarded as a public player, and his best pupils were nearly all amateurs."

In looking through the list of his compositions, teeming with mazurkas, waltzes, polonaises, and other forms of national dance music, one could hardly suppose that here one of the most melancholy natures has revealed itself. This seeming paradox is solved by the type of Chopin's nationality, of which it has justly been said that its very dances are sadness intensified. But notwithstanding this strongly pronounced national type of his compositions, his music is always expressive of his individual feelings and sufferings to a degree rarely met with in the annals of the art. He is indeed the lyrical composer *par excellence* of the modern school, and the intensity of his expression finds its equal in literature only in the songs of Heinrich Heine, to whom Chopin has been justly compared. A sensation of such high-strung passion cannot be prolonged. Hence we see that the shorter forms of music, the *étude*, the nocturne, besides the national dances already alluded to, are chosen by Chopin in preference. Even when he treats the larger forms of the concerto or the sonata this concentrated, not to say pointed, character of Chopin's style becomes obvious. The more extended dimensions seem to encumber the freedom of his movements. The concerto for pianoforte with accompaniment of the orchestra in E may be instanced. Here the *adagio* takes the form of a romance, and in the final rondo the rhythm of a Polish dance becomes recognizable while the instrumentation throughout is meagre and wanting in colour. Chopin is out of his element, and even the beauty of his melodies and harmonies cannot wholly banish the impression of incongruity. Fortunately he himself knew the limits of his power, and with very few exceptions his works belong to that class of minor compositions of which he was an unrivalled master. Barring a collection of Polish songs, two concertos, and a very small number of concerted pieces of chamber music, almost all his works are written for the pianoforte solo; the symphony, the oratorio, the opera, he never attempted.

Chopin's works group themselves firstly into the period from Op. 1 to 22, which includes nearly all his attempts at large or classical forms, e.g. the works with orchestra, Op. 2 (variations on *La ci darem*), Opp. 11 and 14 (concertos), Op. 13 (Polish fantasia), Op. 14 (*Krakowiak*, a concerto-rondo in mazurka-rhythm), and Op. 22 (*Andante spianato* and *Polonaise*), besides the solo rondos Opp. 1, 5, 16, and the variations Op. 12 and the essays in chamber music Opp. 3, 8, 65. Meanwhile, however, the mature lyric style of his second period already began with Op. 6 (4 mazurkas), and though it is not confined to small forms, the larger mature works (beginning with the ballade Op. 23 and excepting only the sonata Op. 58 and the *Allegro de Concert* Op. 46) are as independent of tradition as the smallest. It is well to sift the posthumous works from those published under Chopin's direction, for the last three mazurkas are the only things he did not keep back as misrepresenting him. On these principles his mature works are summed up in the 42 mazurkas (Opp. 6, 7, 17, 24, 30, 33, 41, 50, 56, 59, 63, and the beautiful contribution to the collection *Notre temps*); 7 polonaises (Opp. 26, 40; 53, 61); 24 preludes (in all the major and minor keys) Op. 28, and the single larger prelude Op. 45; 27 *études* (12 in Op. 10, 12 in Op. 25, and 3 written for the *Méthode des méthodes*); 18 nocturnes (Opp. 9, 15, 27, 32, 37, 48, 55, 62); 4 ballades, in forms of Chopin's own invention (Opp. 23, 38, 47, 52); 4 scherzos (Opp. 20, 31, 39, 54); 8 waltzes (Opp. 18, 34, 42, 64); and several pieces of various description, notably the great fantasia Op. 49 and the *impromptu* Op. 29, 36, 51.

The posthumous works number 35 pieces, besides a small volume of songs a few of which are of great interest.

Franz Liszt wrote a charming sketch of Chopin's life and art (*F. Chopin*, par F. Liszt, Paris, 1851), and a very appreciative though somewhat eccentric analysis of his work appeared anonymously in 1842 (*An Essay on the Works of Frédéric Chopin*, London). The standard biography is the English work of Professor F. Niecks (*Novello*, 1888). See also W. H. Hadow, *Studies in Modern Music*, second series (1908). The editions of Chopin's works by his pupil Mikuli and by Klindworth are full of valuable elucidation as to methods of performance, but unfortunately they do not distinguish the commentary from the text. The critical edition published by Breitkopf and Härtel, with all its mistakes, is absolutely necessary for students who wish to know what Chopin wished to put into the hands of players of independent judgment.

CHOPSTICKS, the "pidgin-English" name for the pair of small tapering sticks used by the Chinese and Japanese in eating. "Chop" is pidgin-English for "quick," the Chinese word for the articles being *kwai-tsze*, meaning "the quick ones." "Chopsticks" are commonly made of wood, bone or ivory, somewhat longer and slightly thinner than a lead-pencil. Held between the thumb and fingers of the right hand, they are used as tongs to take up portions of the food, which is brought to table cut up into small and convenient pieces, or as means for sweeping the rice and small particles of food into the mouth from the bowl. Many rules of etiquette govern the proper conduct of the chopsticks; laying them across the bowl is a sign that the guest wishes to leave the table; they are not used during a time of mourning, when food is eaten with the fingers, and various methods of handling them form a secret code of signalling.

CHORAGUS (the Lat. form of Gr. *χοραγός* or *χορηγός*, leader of the chorus), the citizen chosen to undertake the expense of furnishing and instructing the chorus at the Dionysiac festivals at Athens (see LITURGY and FINANCE). The name is given to an assistant to the professor of music at the university of Oxford, whose office was founded, with that of the professor, in 1626 by Dr William Heather.

CHORALE (from the Lat. *choralis*, sc. *cantus*; the final *e* is added to show the Ger pronunciation *choräl*), a term in music used by English writers to indicate the hymn-tunes composed or adopted for use in church by the German reformers. German writers, however, apply the terms "Choral" and "Chorale-gesang," as Luther himself would apply them, to any solemn melody used in the church. It is thus the equivalent of *canto fermo*; and the German rhymed versions of the biblical and other ancient canticles, such as the Magnificat and the Te Deum, are set to curious corruptions of the corresponding Gregorian tunes, which adaptations the composers of classical German music called chorales with no more scruple than they applied the name to tunes of secular origin, German or foreign. The peculiarity of German chorale-music, however, is that its use, and consequently much of its invention, not only arose in connexion with the Reformation, by which the liturgy of the church became "understood of the people," but also that it belongs to a musical epoch in which symmetry of melody and rhythm was beginning to assume artistic importance. The growing sense of form shown by some of Luther's own tunes (e.g. *Vom Himmel hoch, da komm' ich her*) soon advanced, especially in the tunes of Crüger, beyond any that was shown by folk-music; and it provided an invaluable bulwark against the chaos that was threatening to swamp music on all sides at the beginning of the 17th century. By Bach's time all the polyphonic instrumental and vocal art-forms of the 18th century were mature; and though he loved to derive the design as well as the details of a large movement from the shape of the chorale tune on which it was based, he became quite independent of any aid from symmetry in the tune as raw material. The chorus of his cantata *Jesus nun sei gepreiset* is one of the most perfectly designed and quite the longest of movements ever based upon a chorale-tune treated phrase by phrase. Yet the tune is one of the most intractable in the world, though its most unpromising portion is the basis of the most impressive feature in Bach's design (the slow middle section in triple time).

The national character of the German chorale, and the recent great development of interest in folk-music, together with the unique importance of Bach's work, have combined to tempt writers on music to over-estimate the distinctness of the art-forms based upon the German chorale. There is really nothing in these art-forms which is not continuous with the universal practice of writing counterpoint on a *canto fermo*. And it should never be forgotten that, however fascinating may be the study of the relation between artistic forms and the spirit of the age, no art can successfully express more of the spirit of the age than its own technical resources will admit. Choral music in all ages has tended to consist largely of counterpoint on a *canto fermo* (see CONTRAPUNTAL FORMS). Where there are not many *canto fermos* in constant use in the church, composers

will be driven to use them rather unsystematically as special effects, and to rely for the most part on other artistic devices, though any use of melodies in long notes against quicker counterpoint will be aesthetically indistinguishable from counterpoint on a *canto fermo*. Thus Handel in his Italian and English works wrote no entire chorale movements, yet what is the passage in the "Hallelujah" chorus from "the kingdom of this world" to the end but a treatment of the second part of the chorale *Wachet auf*? How shall we describe the treatment of the words "And their cry came up unto the Lord" in the first chorus of *Israel in Egypt*, except as the treatment of a phrase of chorale or *canto fermo*? Again, to return to the 16th century, what are the hymns of Palestrina but figured chorales? In what way, except in the lack of symmetry in the Gregorian phrasing, do they differ from the contemporary setting by Orlando di Lasso, also a Roman Catholic, of the German chorale *Vater unser im Himmelreich*? In modern times the use of German chorales, as in Mendelssohn's oratorios and organ-sonatas, has had rather the aspect of a revival than of a development; though the technique and spirit of Brahms's posthumous organ chorale-pretudes is thoroughly modern and vital.

One of the most important, and practically the earliest collection of "Chorales" is that made by Luther and Johann Walther (1496-1570), the *Enchiridion*, published in 1524. Next in importance may place the Genevan Psalter (1st ed., Strassburg, 1542, final edition 1562), which is now conclusively proved to be the work of Bourgeois. From this Sternhold and Hopkins borrowed extensively (1562). The psalter of C. Goudimel (Paris, 1565) is another among many prominent collections showing the steps towards congregational singing, i.e. the restriction to "note-against-note" counterpoint (sc. plain harmony), and, in twelve cases, the assigning of the melody to the treble instead of to the tenor. The first hymn-book in which this latter step was acted on throughout is Osiander's *Geistliche Lieder* . . . also *gesetzt, dass ein christliche Gemein durchaus mitsingen kann* (1586). But many of the finest and most famous tunes are of much later origin than any such collections. Several (e.g. *Ich freue mich in dir*) cannot be traced before Bach, and were very probably composed by him. (D. F. T.)

CHORIAMBIC VERSE, or **CHORIAMBICS**, the name given to Greek or Latin lyrical poetry in which the sound of the choriamb predominates. The choriambus is a verse-foot consisting of a trochee united with and preceding an iambus, -o o-. The choriambi are never used alone, but are usually preceded by a spondee and followed by an iambus. The line so formed is called an asclepiad, traditionally because it was invented by the Aeolian poet Asclepiades of Samos. Choriambic verse was first used by the poets of the Greek islands, and Sappho, in particular, produced magnificent effects with it. The measure, as used by the early Greeks, is essentially lyrical and impassioned. Mingled with other metres, it was constantly serviceable in choral writing, to which it was believed to give a stormy and mysterious character. The Greater Asclepiad was a term used for a line in which the wild music was prolonged by the introduction of a supplementary choriambus. This was much employed by Sappho and by Alcaeus, as well as in Alexandrian times by Callimachus and Theocritus. Among the Latins, Horace, in imitation of Alcaeus, made constant use of choriambic verse. Metrical experts distinguish six varieties of it in his Odes. This is an example of his greater asclepiad (*Od. i. 11*):—

Tu ne | quaesieris | scire nefas | quem mihi, quem | tibi
Finem | Di dederint | Leuconoe; | nec Babylonios
Tentaris numeros. | Ut melius | quicquid erit, | pati!
Seu plures hiemes, | seu tribuit | Jupiter ultimam,
Quae nunc | oppositis | debilitat | pumicibus | mare
Tyrrhenum.

In later times of Rome, both Seneca and Prudentius wrote choriambic verse with a fair amount of success. Swinburne ever introduced it into English poetry:—

Love, what | ailed them to leave | life that was made | lovely, we
thought | with love?

What sweet | vision of sleep | lured thee away | down from the light
| above?

Such lines as these make a brave attempt to resuscitate the measured sound of the greater asclepiad. (E. G.)

CHORICIUS, of Gaza, Greek sophist and rhetorician, flourished in the time of Anastasius I. (A.D. 491-518). He was the pupil

of Procopius of Gaza, who must be distinguished from Procopius of Caesarea, the historian. A number of his declamations and descriptive treatises have been preserved. The declamations, which are in many cases accompanied by explanatory commentaries, chiefly consist of panegyrics, funeral orations and the stock themes of the rhetorical schools. The *Ἐπιθαλάμιοι* or wedding speeches, wishing prosperity to the bride and bridegroom, strike out a new line. Choricus was also the author of so-called *Ἐκφράσεις*, descriptions of works of art after the manner of Philostratus. The moral maxims, which were a constant feature of his writings, were largely drawn upon by Macarius Chrysocephalus, metropolitan of Philadelphia (middle of the 14th century), in his *Rodonia* (rose-garden), a voluminous collection of ethical sayings. The style of Choricus is praised by Photius as pure and elegant, but he is censured for lack of naturalness. A special feature of his style is the persistent avoidance of hiatus, peculiar to what is called the school of Gaza.

Editions by J. F. Boissonade (1846, supplemented by C. Graux in *Revue de philologie*, 1877) and R. Förster (1882-1894); see also C. Kirsten, "Quaestiones Choricianae in *Breslauer philologische Abhandlungen*, vii. (1894), and article by W. Schmid in Pauly-Wissowa's *Realencyclopädie*, iii. 2 (1899). On the Gaza school see K. Seitz, *Die Schule von Gaza* (Heidelberg, 1892).

CHORIN, AARON (1766-1844), Hungarian rabbi and pioneer of religious reform. He favoured the use of the organ and of prayers in the vernacular, and was instrumental in founding schools on modern lines. Chorin was thus regarded as a leader of the newer Judaism. He also interested himself in public affairs; and his son Francis was a Hungarian deputy.

See L. Löw, *Gesammelte Schriften*, ii. 251.

CHORIZONTES ("separators"), the name given to the Alexandrian critics who denied the single authorship of the *Iliad* and *Odyssey*, and held that the latter poem was the work of a later poet. The most important of them were the grammarians Xenon and Hellanicus; Aristarchus was their chief opponent (see HOMER).

CHORLEY, HENRY FOTHERGILL (1808-1872), English musical critic, one of an old Lancashire family, began in a merchant's office, but soon took to musical journalism. He began to write for the *Athenaeum* in 1830, and remained its musical critic for more than a generation; and he also became musical critic for *The Times*. In these positions he had much influence; he had strong views, and was a persistent opponent of innovation. In addition to musical criticism, he wrote voluminously on literature and art, besides novels, dramas and verse, and various librettos; and he published several books, including *Modern German Music* (1854), *Handel Studies* (1859), and *Thirty Years' Musical Recollections* (1862). He died in London on the 16th of February 1872.

See his *Autobiography, Memoir and Letters*, edited by H. G. Hewlett (1873).

CHORLEY, a market town and municipal borough in the Chorley parliamentary division of Lancashire, England, on the river Yarrow, 202 m. N.W. by W. from London and 22 m. N.W. from Manchester, on the Lancashire & Yorkshire and London & North-Western railways and the Leeds & Liverpool Canal. Pop. (1891) 23,087; (1901) 26,852. The church of St Lawrence is of Perpendicular and earlier date, largely restored; it contains fine woodwork and some interesting monuments. Cotton spinning and the manufacture of cotton and muslin are extensively carried on, and there are also iron and brass foundries and boiler factories. Railway-wagon building is an important industry. The district contains a number of coal-mines and stone-quarries. Close to the town is the beautiful Elizabethan mansion of Astley Hall, which is said to have sheltered Oliver Cromwell after the battle of Preston (1648). The corporation consists of a mayor, 6 aldermen and 24 councillors. Area, 3614 acres.

CHORLU, TCHORLAU or SCHORLAU, a town of European Turkey, in the vilayet of Adrianople; on the left bank of the Chorlu, a small left-hand tributary of the Ergene, 20 m. N.E. of

Rodosto. Pop. (1905) about 12,000, of whom one-half are Greeks, one-third Turks, and the remainder Armenians and Jews. Chorlu has a station on the Constantinople-Adrianople branch of the Oriental railways. It manufactures woollen cloth (*shayak*) and native carpets, and exports cereals, oil-cloth, carpets, cattle, poultry, fresh meat, game, fruits, wine, alcohol, hides and bones.

CHOROGRAPHY. (1) (From the Gr. *χώρα*, a tract of country, and *γράφειν*, to write), a description or delineation on a map of a district or tract of country; it is to be distinguished from "geography" and "topography," which treat of the earth as a whole and of particular places respectively. The word is common in old geographical treatises, but is now superseded by the wider use of "topography." (2) (From the Gr. *χορός*, dance), the art of dancing, or a system of notation to indicate the steps and movements in dancing.

CHÓRUM, the chief town of a sanjak of the Angora vilayet in Asia Minor, altitude 2300 ft., situated on the edge of a wide plain, almost equidistant from Amasia and Yuzgat. Pop. about 12,500, including a few Christians. Its importance is largely due to its situation on the great trade-route from Kaisariéh (Caesarea) by Yuzgat and Marzivan to Samsun on the Black Sea. It corresponds to the ancient *Euchaïta*, which lay 15 m. E. Euchaïti was attacked by the Huns A.D. 508, and became a bishopric at an early period and a centre of religious enthusiasm, as containing the tomb of the revered St Theodore, who slew a dragon in the vicinity and became one of the great warrior saints of the Greek Church. Something of the old enthusiasm seems to have passed to the inhabitants of Chórum, whom most travellers have found bigoted and fanatical Mahomedans (see J.G.C. Anderson, *Studia Pontica*, pp. 6 ff.).

CHORUS (Gr. *χορός*), properly a dance, and especially the sacred dance, accompanied by song, of ancient Greece at the festivals of the gods. The word *χορός* seems originally to have referred to a dance in an enclosure, and is therefore usually connected with the root appearing in Gr. *χόρος*, hedge, enclosure, Lat. *hortus*, garden, and in the Eng. "yard," "garden" and "garth." Of choral dances in ancient Greece other than those in honour of Dionysus we know of the Dance of the Crane at Delos, celebrating the escape of Theseus from the labyrinth, one telling of the struggle of Apollo and the Python at Delphi, and one in Crete recounting the saving of the new-born Zeus by the Curetes. In the chorus sung in honour of Dionysus the ancient Greek drama had its birth. From that of the winter festival, consisting of the *κῶμος* or band of revellers, chanting the "phallic songs," with ribald dialogue between the leader and his band, sprang "comedy," while from the dithyrambic chorus of the spring festival came "tragedy." For the history of the chorus in Greek drama, with the gradual subordination of the lyrical to the dramatic side in tragedy and its total disappearance in the middle and new comedy, see DRAMA: *Greek Drama*.

The chorus as a factor in drama survived only in the various imitations or revivals of the ancient Greek theatre in other languages. A chorus is found in Milton's *Samson Agonistes*. The Elizabethan dramatists applied the name to a single character employed for the recitation of prologues or epilogues. Apart from the uses of the term in drama, the word "chorus" has been employed chiefly in music. It is used of any organized body of singers, in opera, oratorio, cantata, &c., and, in the form "choir," of the trained body of singers of the musical portions of a religious service in a cathedral or church. As applied to musical compositions, a "chorus" is a composition written in parts, each to be sung by groups of voices in a large body of singers, and differs from "glee" (*q.v.*), where each part is for a single voice. The word is also used of that part of a song repeated at the close of each verse, in which the audience or a body of singers may join with the soloist.

In the early middle ages the name *chorus* was given to a primitive bagpipe without a drone. The instrument is best known by the Latin description contained in the apocryphal letter of St Jerome, *ad Dardanum*: "Chorus quoque simplex, pellis cum duabus cicutis areis, et per primam inspiratur per secundam

vocem emittit." Several illuminated MSS.¹ from the 9th to the 11th century give fanciful drawings, accompanied by descriptions in barbarous Latin, evidently meant to illustrate those described in the letter to Dardanus. The original MS., probably an illustrated transcript of this letter, which served as a copy for the others, was apparently produced at a time when the Roman bagpipe (*tibia uricularia*) had fallen into disuse in common with other musical instruments, and was unknown except to the few. The Latin description given above is correct and quite unmistakable to any one who knows the primitive form of bagpipe; the illustrations must therefore represent the effort of an artist to depict an unknown instrument from a description. Viridung, Luscinus and Praetorius seem to have had access to a MS. of the Dardanus letter now lost, and to have reproduced the drawings without understanding them. In a MS. of the 14th century at the British Museum,² containing a chronicle of the world's history to the death of King Edward I., the chorus is mentioned and described in similar words to those quoted above; in the margin is an elementary sketch of a primitive bagpipe with blowpipe and chanter with three holes, but no drone. Bagpipes with drones abound on sculptured monuments and in miniatures of that century. Gerbert gives illustrations of the fanciful chorus from the Dardanus letter and of two other instruments of later date; one of these represents a musician playing the *Platerspiel*, the other the bagpipe known as *chevette*, in which the whole skin of the animal (a kid or pig), with head and feet, has been used for the bag. Edward Buhle,³ in his admirable work on the musical instruments in the illuminated MSS. of the middle ages, points out that Gerbert,⁴ who gives the dates of his two MSS. as "6th and 9th centuries," has a singular method of reckoning the date of a MS.; he refers to the age of a MS. at the time of writing (18th century), not to the date at which it was produced. The MS. containing the two figures of musicians mentioned above, instead of being ascribed to the 6th century, was six centuries old when Gerbert wrote in 1774, and dates therefore from the 12th century. It is interesting to note that Giraldus Cambrensis⁵ mentions the chorus as one of the three instruments of Wales and Scotland, ascribing superior musical skill to the latter. Historians record that King James I. of Scotland was renowned for his skill as a performer on various musical instruments, one of which was the chorus.⁶ This bears out the traditional belief that the bagpipe had been a Scottish attribute from the earliest times. The word "chorus" occurs once or twice in French medieval poems with other instruments, but without indication as to the kind of instrument thus designated. The word was probably the French equivalent for the *Platerspiel*.

See also G. Kastner, *Dances des morts* (pp. 200 to 202, pl. xv., No. 103); and Dom Pedro Cerone, *El Moloepo y maestro* (Naples, 1613), p. 248. (K. S.)

CHOSE (Fr. for "thing"), a term used in English law in different senses. *Chose local* is a thing annexed to a place, as a mill. A *chose transitory* is that which is movable, and can be carried from place to place. But the use of the word "chose" in these senses is practically obsolete, and it is now used only in the phrases *chose in action* and *chose in possession*. A "chose in action," sometimes called a chose in suspense, in its more limited meaning, denotes the right of enforcing by legal pro-

¹ The MSS. are a psalterium, 9th century, Bibl. publique, Angers, fol. 13a; Boulogne *Psalterium glossatum* c. A.D. 1000, MS. No. 20, Bibl. publique. For reproduction of musical instruments see *Annales archéologiques*, tome iv. (1846), p. 38; Cotton MS., Tiberius C. vi., 10th to 11th century, fol. 16b, British Museum, illustrated in Strutt's *Horde Angel-cynnan*, vol. ii. pls. xx. and xxi.; MS. psalter of St Emmeran, now in Munich Staatsbibliothek, clm. 14523, fol. 51b, 10th century, illustrated by Gerbert, *De Cantu et Mus. Sacra*, tome ii. pl. xxxiii.; Paris, Bibl. Nat. Fonds Latin, 7211, 10th century, fol. 150 and 151a.

² Cotton MS., Nero D. ii. f. 15a, *Chronicon ab orbe condito ad obitum Regis Edwardi I.*, 1307.

³ *Die musikalischen Instrumente in den Miniaturen des frühen Mittelalters*, part i. "Die Blasinstrumente" (Leipzig, 1903), p. 7, note 1.

⁴ *Op. cit.* (1774), tome ii. pl. xxv. No. 13, pp. 130, 151, 152, and pl. xxxi. No. 12.

⁵ *Topographia Hiberniae*, cap. xi.

⁶ *Scotichronicon* (Fordun and Bower), xvi. 28; and Dalzell, *Musical Memoirs of Scotland*, p. 47, pls. x. and xi.

ceedings the payment of a debt, or the obtaining money by way of damages for breach of contract, or as a recompense for a wrong. Less accurately, the money itself which could be recovered is frequently termed a chose in action, as is also sometimes the document evidencing a title to a chose in action, such as a bond or a policy of insurance, though strictly it is only the right to recover the money which can be so termed. Choses in action were, before the Judicature Acts, either *legal* or *equitable*. Where the chose could be recovered only by an action at law, as a debt (whether arising from contract or tort), it was termed a legal chose in action; where the chose was recoverable only by a suit in equity, as a legacy or money held upon a trust, it was termed an equitable chose in action. Before the Judicature Act, a legal chose in action was not assignable, *i.e.* the assignee could not sue at law in his own name. To this rule there were two exceptions:—(1) the crown has always been able to assign choses in action that are certain, such as an ascertained debt, but not those that are uncertain; (2) assignments valid by operation of law, *e.g.* on marriage, death or bankruptcy. On the other hand, however, by the law merchant, which is part of the law of England, and which disregards the rules of common law, bills of exchange were freely assignable. The consequence was that, with these and certain statutory exceptions (*e.g.* actions on policies of insurance), an action on an assigned chose in action must have been brought at law in the name of the assignor, though the sum recovered belonged in equity to the assignee. All choses in action being in equity assignable, except those which are altogether incapable of being assigned, in equity the assignee might have sued in his own name, making the assignor a party as co-plaintiff or as defendant. The Judicature Acts made the distinction between legal and equitable choses in action of no importance. The Judicature Act of 1873, s. 25 (6), enacted that the legal right to a debt or other legal chose in action could be passed by absolute assignment in writing under the hand of the assignor.

"Chose in possession" is opposed to chose in action, and denotes not only the right to enjoy or possess a thing, but also the actual or constructive enjoyment of it. The possession may be absolute or qualified. It is absolute when the person is fully and completely the proprietor or owner of the thing; it is qualified when he "has not an exclusive right, or not a permanent right, but a right which may sometimes subsist and at other times not subsist," as in the case of animals *ferae naturae*. A chose in possession is freely transferable by delivery. Previously to the Married Women's Property Act 1882, a wife's choses in possession vested in her husband immediately on her marriage, while her choses in action did not belong to the husband until he had reduced them into possession, but this difference is now practically obsolete.

CHOSROES, in Middle and Modern Persian *Khosrau* ("with a good name"), a very common Persian name, borne by a famous king of the Iranian legend (Kai Khosrau); by a Parthian king, commonly called by the Greeks Osroes (*q.v.*); and by the following two Sassanid kings.

1. **CHOSROES I.**, "the Blessed" (*Anushirvan*), 531-579, the favourite son and successor of Kavadh I., and the most famous of the Sassanid kings. At the beginning of his reign he concluded an "eternal" peace with the emperor Justinian, who wanted to have his hands free for the conquest of Africa and Sicily. But his successes against the Vandals and Goths caused Chosroes to begin the war again in 540. He invaded Syria and carried the inhabitants of Antioch to his residence, where he built for them a new city near Ctesiphon under the name of Khosrau-Antioch or Chosro-Antioch. During the next years he fought successfully in Lazica or Lazistan (the ancient Colchis, *q.v.*), on the Black Sea, and in Mesopotamia. The Romans, though led by Belisarius, could do little against him. In 545 an armistice was concluded, but in Lazica the war went on till 556. At last, in 562, a peace was concluded for 50 years, in which the Persians left Lazistan to the Romans, and promised not to persecute the Christians, if they did not attempt to make proselytes among the Zoroastrians; on the other hand, the Romans had again to pay

subsidies to Persia. Meanwhile in the east the Hephthalites had been attacked by the Turks, who now appear for the first time in history. Chosroes united with them and conquered Bactria, while he left the country north of the Oxus to the Turks. Many other rebellious tribes were subjected. About 570 the dynasts of Yemen, who had been subdued by the Ethiopians of Axum, applied to Chosroes for help. He sent a fleet with a small army under Vahriz, who expelled the Ethiopians. From that time till the conquests of Mahomet, Yemen was dependent on Persia, and a Persian governor resided here. In 571 a new war with Rome broke out about Armenia, in which Chosroes conquered the fortress Dara on the Euphrates, invaded Syria and Cappadocia, and returned with large booty. During the negotiations with the emperor Tiberius Chosroes died in 579, and was succeeded by his son Hormizd IV.

Although Chosroes had in the last years of his father extirpated the heretical and communistic Persian sect of the Mazdakites (see KAVADH) and was a sincere adherent of Zoroastrian orthodoxy, he was not fanatical or prone to persecution. He tolerated every Christian confession. When one of his sons had rebelled about 550 and was taken prisoner, he did not execute him; nor did he punish the Christians who had supported him. He introduced a rational system of taxation, based upon a survey of landed possessions, which his father had begun, and tried in every way to increase the welfare and the revenues of his empire. In Babylonia he built or restored the canals. His army was in discipline decidedly superior to the Romans, and apparently was well paid. He was also interested in literature and philosophical discussions. Under his reign chess was introduced from India, and the famous book of Kalilah and Dimnah was translated. He thus became renowned as a wise prince. When Justinian in 529 closed the university of Athens, the last seat of paganism in the Roman empire, the last seven teachers of Neoplatonism emigrated to Persia. But they soon found out that neither Chosroes nor his state corresponded to the Platonic ideal, and Chosroes, in his treaty with Justinian, stipulated that they should return unmolested.

2. CHOSROES II., "the Victorious" (*Parvez*), son of Hormizd IV., grandson of Chosroes I., 590-628. He was raised to the throne by the magnates who had rebelled against Hormizd IV. in 590, and soon after his father was blinded and killed. But at the same time the general Bahram Chobin had proclaimed himself king, and Chosroes II. was not able to maintain himself. The war with the Romans, which had begun in 571, had not yet come to an end. Chosroes fled to Syria, and persuaded the emperor Maurice (*q.v.*) to send help. Many leading men and part of the troops acknowledged Chosroes, and in 591 he was brought back to Ctesiphon. Bahram Chobin was beaten and fled to the Turks, among whom he was murdered. Peace with Rome was then concluded. Maurice made no use of his advantage; he merely restored the former frontier and abolished the subsidies which had formerly been paid to the Persians. Chosroes II. was much inferior to his grandfather. He was haughty and cruel, rapacious and given to luxury; he was neither a general nor an administrator. At the beginning of his reign he favoured the Christians; but when in 602 Maurice had been murdered by Phocas, he began war with Rome to avenge his death. His armies plundered Syria and Asia Minor, and in 608 advanced to Chalcedon. In 613 and 614 Damascus and Jerusalem were taken by the general Shahrbaraz, and the Holy Cross was carried away in triumph. Soon after, even Egypt was conquered. The Romans could offer but little resistance, as they were torn by internal dissensions, and pressed by the Avars and Slavs. At last, in 622, the emperor Heraclius (who had succeeded Phocas in 610) was able to take the field. In 624 he advanced into northern Media, where he destroyed the great fire-temple of Gandzak (Gazaca); in 626 he fought in Lazistan (Colchis), while Shahrbaraz advanced to Chalcedon, and tried in vain, united with the Avars, to conquer Constantinople. In 627 Heraclius defeated the Persian army at Nineveh and advanced towards Ctesiphon. Chosroes fled from his favourite residence, Dastagerd (near Bagdad), without offering resistance, and as

his despotism and indolence had roused opposition everywhere, his eldest son, Kavadh II., whom he had imprisoned, was set free by some of the leading men and proclaimed king. Four days afterwards, Chosroes was murdered in his palace (February 628). Meanwhile, Heraclius returned in triumph to Constantinople, in 629 the Cross was given back to him and Egypt evacuated, while the Persian empire, from the apparent greatness which it had reached ten years ago, sank into hopeless anarchy.

See PERSIA: *Ancient History*. For the Roman wars see authorities quoted under MAURICE and HERACLIVS. (Ed. M.)

CHOTA (or CHUTIA) NAGPUR, a division of British India in Bengal, consisting of five British districts and two feudatory states. It is a hilly, forest-clad plateau, inhabited mostly by aboriginal races, between the basins of the Sone, the Ganges and the Mahanadi. The five British districts are Hazaribagh, Ranchi, Palamau, Manbhum and Singhbhum. The total area of the British districts is 27,101 sq. m. The population in 1901 was 4,900,429. The tributary states are noticed separately below. The Chota Nagpur plateau is an offshoot of the great Vindhyan range, and its mean elevation is upwards of 2000 ft. above the sea-level. In the W. it rises to 3600 ft., and to the E. and S. its lower steppe, from 800 to 1000 ft. in elevation, comprises a great portion of the Manbhum and Singhbhum districts. The whole is about 14,000 sq. m. in extent, and forms the source of the Barakhar, Damodar, Kasai, Subanrekha, Baitarani, Brahmani, Ib and other rivers. Sal forests abound. The principal jungle products are timber, various kinds of medicinal fruits and herbs, lac, tussur silk and *mahuá* flowers, which are used as food by the wild tribes and also distilled into a strong country liquor. Coal exists in large quantities, and is worked in the Jherria, Hazaribagh, Giridih and Gobindpur districts. The chief workings are at Jherria, which were started in 1893, and have developed into one of the largest coal-fields in India. Formerly gold was washed from the sands in the bed of the Subanrekha river, but the operations are now almost wholly abandoned. Iron-ores abound, together with good building stone. The indigenous inhabitants consist of non-Aryan tribes who were driven from the plains by the Hindus and took refuge in the mountain fastnesses of the Chota Nagpur plateau. The principal of them are Kols, Santals, Oraons, Dhangars, Mundas and Bhumij. These tribes were formerly turbulent, and a source of trouble to the Mahomedan governors of Bengal and Behar; but the introduction of British rule has secured peace and security, and the aboriginal races of Chota Nagpur are now peaceful and orderly subjects. The principal agricultural products are rice, Indian corn, pulses, oil-seeds and potatoes. A small quantity of tea is grown in Hazaribagh and Ranchi districts. Lac and tussur silk-cloth are largely manufactured. The climate of Chota Nagpur is dry and healthy. The Jherria extension branch of the East India railway runs to Katrasgarh, while the Bengal-Nagpur railway also serves the division.

The CHOTA NAGPUR STATES were formerly nine in number. But the five states of Chang Bhakar, Korea, Sirguja, Udaipur and Jashpur were transferred from Bengal to the Central Provinces in October 1905, and the two Uriya-speaking states of Gangpur and Bonai were attached to the Orissa Tributary States. There now remain, therefore, only the two states of Kharsawan and Saraikela. At the decline of the Mahratta power in the early part of the 19th century, the Chota Nagpur states came under British protection. Before the rise of the British power in India their chiefs exercised almost absolute sovereignty in their respective territories.

See F. B. Bradley-Birt, *Chota Nagpore* (1903).

CHOUANS (a Bas-Breton word signifying screech-owls), the name applied to smugglers and dealers in contraband salt, who rose in insurrection in the west of France at the time of the Revolution and joined the royalists of La Vendée. It has been suggested that the name arose from the cry they used when approaching their nocturnal rendezvous; but it is more probable that it was derived from a nickname applied to their leader Jean Cottereau (1767-1794). Originally a contraband manufacturer of salt, Cottereau along with his brothers had several times been

condemned and served sentence; but the Revolution, by destroying the inland customs, ruined his trade. On the 15th of August 1792, he led a band of peasants to prevent the departure of the volunteers of St Ouen, near Laval, and retired to the wood of Misdon, where they lived in huts and subterranean chambers. The Chouans then waged a guerrilla warfare against the republicans and, sustained by the royalists and from abroad, carried on their assassinations and brigandage with success. From Lower Maine the insurrection soon spread to Brittany, and throughout the west of France. In 1793 Cottureau came to Laval with some 500 men; the band grew rapidly and swelled into a considerable army, which assumed the name of La Petite Vendée. But after the decisive defeats at Le Mans and Savenay, Cottureau retired again to his old haunts in the wood of Misdon, and resumed his old course of guerrilla warfare. Misfortunes here increased upon him, until he fell into an ambushade and was mortally wounded. He died among his followers in February 1794. Cottureau's brothers also perished in the war, with the exception of René, who lived until 1846. Royalist authors have made of Cottureau a hero and martyr, titles to which his claim is not established. After the death of Cottureau, the chief leaders of the Chouans were Georges Cadoudal (*q.v.*) and a man who went by the name of Jambe d'Argent. For several months the Chouans continued their petty warfare, which was disgraced by many acts of ferocity and rapine; in August 1795 they dispersed; but they were guilty of several conspiracies up to 1815. (See also VENDÉE.)

See the articles in *La Révolution française*, vol. 29, *La Chouannerie dans la Manche*; vol. 32, *La Chouannerie dans l'Eure*; vol. 40, *La Chouannerie dans le Morbihan (1793-1794)*; Sarot, *Les Tribunaux répressifs ordinaires de la Manche en matière politique pendant la première Révolution* (Paris, 1881), 4 vols.; Th. de Closmadeux, *Quiberon (1795), Émigrés et Chouans, commissions militaires, interrogations et jugements* (Paris, 1898), the only authority on the celebrated affair of Quiberon; E. Daudet, *La Police et les Chouans dans le Consulat et l'Empire, 1800-1815* (Paris, 1895). Also the works of Ch. L. Chessin mentioned under VENDÉE.

CHRESMOGRAPHION (from Gr. *χρῆμα*, oracle, and *γράφειν*, to write), an architectural term sometimes given to the chamber between the pronaos and the cella in Greek temples where oracles were delivered.

CHRESTIEN, FLORENT (1541-1596), French satirist and Latin poet, the son of Guillaume Chrestien, an eminent French physician and writer on physiology, was born at Orleans on the 26th of January 1541. A pupil of Henri Estienne, the Hellenist, at an early age he was appointed tutor to Henry of Navarre, afterwards Henry IV., who made him his librarian. Brought up as a Calvinist, he became a convert to Catholicism. He was the author of many good translations from the Greek into Latin verse,—amongst others, of versions of the *Hero and Leander* attributed to Musaeus, and of many epigrams from the Anthology. In his translations into French, among which are remarked those of Buchanan's *Jephthé* (1567), and of Oppian *De Venatione* (1575), he is not so happy, being rather to be praised for fidelity to his original than for excellence of style. His principal claim to a place among memorable satirists is as one of the authors of the *Satyre Ménippée*, the famous pasquinade in the interest of his old pupil, Henry IV., in which the harangue put into the mouth of cardinal de Pelvé is usually attributed to him. He died on the 3rd of October 1596 at Vendôme.

CHRÉTIEN, or CRESTIEN, DETROYES, a native of Champagne, and the most famous of French medieval poets. Unfortunately we have few exact details as to his life, and opinion differs as to the precise dates to be assigned to his poems. We know that he wrote the *Chevalier de la Charrette* at the command of Marie, countess of Champagne (the daughter of Louis VII. and Eleanor, who married the count of Champagne in 1164), and *Le Conte del Graal* or *Perceval* for Philip, count of Flanders, who died of the plague before Acre in 1191. This prince was guardian to the young king, Philip Augustus, and held the regency from 1180 to 1182. As Chrétien refers to the story of the Grail as the best tale told *au cort roial*, it seems very probable that it was composed during the period of the count's regency. It was left unfinished, and added to at divers times by at least three writers, Wauchier

de Denain, Gerbert de Montreuil and Manessier. The second of these states definitely that Chrétien died before he could finish his poem. Probably the period of his literary activity lies between the dates 1150 and 1182, when his patron, Count Philip, fell into disgrace at court. The extant poems of Chrétien de Troyes, in their chronological order are, *Érec et Énide*, *Cligès*, *Le Chevalier de la Charrette* (or *Lancelot*), *Le Chevalier au Lion* (or *Yvain*), and *Le Conte del Graal* (*Perceval*), all dealing with Arthurian legend. Besides these he states in the opening lines of *Cligès* that he had composed a *Tristan* (of which so far no trace has been found), and had made certain translations from Ovid's *Ars Amatoria* and *Metamorphoses*. A portion of the last has been found by Gaston Paris included in the translation of Ovid made by Chrétien Legouais. There exists also a poem, *Guillaume d'Angleterre*, purporting to be by Chrétien, but the authorship is a matter of debate. Professor Foerster claims it as genuine, and includes it in his edition of the poems, but Gaston Paris never accepted it.

Chrétien's poems enjoyed widespread favour, and of the three most popular (*Érec*, *Yvain* and *Perceval*) there exist old Norse translations, while the two first were admirably rendered into German by Hartmann von Aue. There is an English translation of the *Yvain*, *Yvain and Gawain*, and there are Welsh versions of all three stories, though their exact relation to the French has not been determined. Chrétien's style is easy and graceful, such as might be expected from a court poet; he is analytical, but not dramatic; in depth of thought and power of characterization he is decidedly inferior to Wolfram von Eschenbach, and as a poet he is probably to be ranked below Thomas, the author of the *Tristan*, and the translator of Thomas, Gottfried von Strassburg. Much that has been claimed as characteristic of his work has been shown by M. Willmote to be merely reproductions of literary conceits employed by his predecessors; in the words of a recent writer, M. Bédier, "Chrétien semble moins avoir été un créateur épique qu'un habile arrangeur." The special interest of his poems lies in the problems surrounding their origin. So far as the MSS. are concerned they are the earliest Arthurian romances we possess. Did Chrétien invent the *genre*, or did he simply turn to account the work of earlier, and less favoured, poets? Round this point the battle still rages hotly, and though the extensive claims made by the enthusiastic editor of his works are gradually yielding to the force of critical investigation, it cannot be said that the question is in any way settled (see ARTHURIAN LEGEND).

Chrétien's poems, except the *Perceval*, have been critically edited by Professor Foerster (4 vols.). There is no easily available edition of the *Perceval*, which was printed from the Mons MS. by M. Potvin (6 vols., 1866-1871), but is difficult to procure. For *Yvain and Gawain* see the edition by Schleich (1887). The German versions are in *Deutsche Classiker des Mittelalters*, 1888 (*Iwein*), 1893 (*Erec*); the Welsh, in Lady Charlotte Guest's translation of the *Mabinogion* (Nutt, 1902); Scandinavian translations, ed. E. Kölbjerg (1872). For general criticism see Willmote, *L'Évolution du roman français aux environs de 1150* (1903); also *Legend of Sir Lancelot and Legend of Sir Perceval* (Grimm Library); and M. Borodine, *La Femme et l'amour au XII^e siècle, d'après les poèmes de Chrétien de Troyes* (1909).

CHRISM (through Lat. *chrisma*, from Gr. *χρίσμα*, an anointing substance, *χρίειν*, to anoint; through a Romanic form *creasma* comes the Fr. *crème*, and Eng. "cream"), a mixture of olive oil and balm, used for anointing in the Roman Catholic church in baptism, confirmation and ordination, and in the consecrating and blessing of altars, chalices, baptismal water, &c. The consecration of the "chrism" is performed by a bishop; and since the 5th century has taken place on Maundy Thursday. In the Orthodox Church the chrism contains, besides olive oil, many precious spices and perfumes, and is known as "muron" or "myron." The word is sometimes used loosely for the unmixed olive oil used in the sacrament of extreme unction. The "Chrism" or "chrysom," a variant of "chrism," lengthened through pronunciation, is a white cloth with which the head of a newly baptized child was covered to prevent the holy oil from being rubbed off. If the baby died within a month of its baptism, it was shrouded in its chrysom; otherwise the cloth or its value was given to the church as an offering by the mother at her churching. Children dying within the month were called

"chrisom-children" or "chrisoms," and up to 1726 such entries occur in bills of mortality. The word was also used generally for a very young and innocent child, thus Shakespeare, *Henry V.*, ii. 3, says of Falstaff: "A' made a finer end and went away an it had been any Chrisom Child."

CHRIST (Gr. *Χριστός*, Anointed), the official title given in the New Testament to Jesus of Nazareth, equivalent to the Hebrew *Messiah*. See **JESUS CHRIST**; **MESSIAH**; **CHRISTIANITY**.

CHRIST, WILHELM VON (1831-1906), German classical scholar, was born in Geisenheim in Hesse-Nassau on the 2nd of August 1831. From 1854 till 1860 he taught in the Maximilians-gymnasium at Munich, and in 1861 was appointed professor of classical philology in the university. His most important works are his *Geschichte der griechischen Literatur* (5th ed., 1908 f.), a history of Greek literature down to the time of Justinian, one of the best works on the subject; *Metrik der Griechen und Römer* (1879); editions of Pindar (1887); of the *Poëtica* (1878) and *Metaphysica* (1895) of Aristotle; *Iliad* (1884). His contributions to the *Sitzungsberichte* and *Abhandlungen* of the Bavarian Academy of Sciences are particularly valuable.

See O. Crusius, *Gedächtnisrede* (Munich, 1907).

CHRISTADELPHIANS (*Χριστοῦ ἀδελφοί*, "brothers of Christ"), sometimes also called Thomasites, a community founded in 1848 by John Thomas (1805-1871), who, after studying medicine in London, migrated to Brooklyn, N.Y., U.S.A. There he at first joined the "Campbellites," but afterwards struck out independently, preaching largely upon the application of Hebrew prophecy and of the Book of Revelation to current and future events. Both in America and in Great Britain he gathered a number of adherents, and formed a community which has extended to several English-speaking countries. It consists of exclusive "ecclesias," with neither ministry nor organization. The members meet on Sundays to "break bread" and discuss the Bible. Their theology is strongly millenarian, centering in the hope of a world-wide theocracy with its seat at Jerusalem. Holding a doctrine of "conditional immortality," they believe that they alone have the true exegesis of Scripture, and that the "faith of Christendom" is "compounded of the fables predicted by Paul." No statistics of the community are published. It probably numbers from two to three thousand members. A monthly magazine, *The Christadelphian*, is published in Birmingham.

See R. Roberts, *Dr Thomas, his Life and Work* (1884).

CHRISTCHURCH, a municipal and parliamentary borough of Hampshire, England, at the confluence of the rivers Avon and Stour, 1½ m. from the sea, and 104 m. S.W. by W. from London by the London & South Western railway. Pop. (1901) 4204. It is famous for its magnificent priory church of the Holy Trinity. The church is cruciform, lacking a central tower, but having a Perpendicular tower at the west end. The nave and transepts are principally Norman, and very fine; the choir is Perpendicular. Early English additions appear in the nave, clerestory and elsewhere, and the rood-screen is of ornate Decorated workmanship. Other noteworthy features are the Norman turret at the north-east angle of the north transept, covered with arcading and other ornament, the beautiful reredos, similar to that in Winchester cathedral, and several interesting monuments, among which is one to the poet Shelley. Only fragments remain of the old castle, but an interesting ruin adjoins it known as the Norman House, apparently dating from the later part of the 12th century. Hosiery, and chains for clocks and watches are manufactured, and the salmon fishery is valuable. There is a small harbour, but it is dry at low water. The parliamentary borough, returning one member, includes the town of Bournemouth. The municipal borough is under a mayor, 4 aldermen and 12 councillors. Area, 832 acres.

Christchurch is mentioned in Saxon documents under the name of Tweotneam or Tweonaeteam, which long survived in the form Christchurch Twineham. In 901 it was seized by Aethelwald, but was recaptured by Edward the Elder. In the Domesday Survey, under the name of Thuinam, it appears as a royal manor, comprising a mill and part of the king's forest; its value since the time of Edward the Confessor had decreased

by almost one-half. Henry I. granted Christchurch to Richard de Redvers, who erected the castle. The first charter was granted by Baldwin earl of Exeter in the 12th century; it exempted the burgesses from certain tolls and customs, including the tolls on salt within the borough, and the custody of thieves. The 2nd Earl Baldwin granted to the burgesses the tolls of the fair at St Faith and common of pasture in certain meads. The above charters were confirmed by Edward II., Henry VII. and Elizabeth. The Holy Trinity fair is mentioned in 1226. Christchurch was governed by a bailiff in the 13th century, and was not incorporated till 1670, when the government was vested in a mayor and 24 capital burgesses, but this charter was shortly abandoned. The borough was summoned to send representatives to parliament in 1307 and 1308, but no returns are registered until 1572, from which date it was represented by two members until the Reform Act of 1832 reduced the number to one. The secular canons of the church of Holy Trinity held valuable possessions in Hampshire at the time of Edward the Confessor, including a portion of Christchurch, and in 1150 the establishment was constituted a priory of regular canons of St Augustine. Baldwin de Redvers confirmed the canons in their right to the first salmon caught every year and the tolls of Trinity fair. The priory, which attained to such fame that its name of Christchurch finally replaced the older name of Twineham, was dissolved in 1539.

See *Victoria County History—Hampshire*; Benjamin Ferrey, *Antiquities of the Priory of Christchurch*, 2nd edition, revised by J. Britton (London, 1841).

CHRISTCHURCH, a city near the east coast of South Island, New Zealand, to the north of Banks Peninsula, in Selwyn county, the capital of the provincial district of Canterbury and the seat of a bishop. Pop. (1906) 49,928; including suburbs, 67,878. It stands upon the great Canterbury plain, which here is a dead level, though the monotony of the site has been much relieved by extensive plantations of English and Australian trees. A background is supplied by the distant mountains to the west, and by the nearer hills to the south. The small river Avon winds through the city, pleasantly bordered by terraces and gardens. The wide streets cross one another for the most part at right angles. The predominance of stone and brick as building materials, the dominating cathedral spire, and the well-planted parks, avenues and private gardens, recall the aspect of an English residential town. Christchurch is mainly dependent on the rich agricultural district which surrounds it, the plain being mainly devoted to cereals and grazing. Wool is extensively worked, and meat is frozen for export. Railways connect with Culverden to the north and with Dunedin and the south coast, with many branches through the agricultural districts; also with Lyttelton, the port of Christchurch, 8 m. S.E. There are tramways in the city, and to New Brighton, a seaside suburb, and other residential quarters. The principal public buildings are the government buildings and the museum, with its fine collection of remains of the extinct bird, moa. The cathedral is the best in New Zealand, built from designs of Sir G. Gilbert Scott in Early English style, with a tower and spire 240 ft. high. Among educational foundations are Canterbury College (for classics, science, engineering, &c.), Christ's College (mainly theological) and grammar school, and a school of art. There is a Roman Catholic pro-cathedral attached to a convent of the Sacred Heart. A large extent of open ground, to the west of the town, finely planted, and traversed by the river, comprises Hagley Park, recreation grounds, the Government Domain and the grounds of the Acclimatization Society, with fish-ponds and a small zoological garden. The foundation of Christchurch is connected with the so-called "Canterbury Pilgrims," who settled in this district in 1850. Lyttelton was the original settlement, but Christchurch came into existence in 1851, and is thus the latest of the settlements of the colony. It became a municipality in 1862. In 1903 several populous suburban boroughs were amalgamated with the city.

CHRISTIAN II. (1481-1559), king of Denmark, Norway and Sweden, son of John (Hans) and Christina of Saxony, was

born at Nyborg castle in 1481, and succeeded his father as king of Denmark and Norway in 1513. As viceroy of Norway (1506-1512) he had already displayed a singular capacity for ruling under exceptionally difficult circumstances. Patriotism, insight, courage, statesmanship, energy,—these great qualities were indisputably his; but unfortunately they were vitiated by obstinacy, suspicion and a sulky craftiness, beneath which simmered a very volcano of revengeful cruelty. Another peculiarity, more fatal to him in that aristocratic age than any other, was his fondness for the common people, which was increased by his passion for a pretty Dutch girl, named Dyveke, who became his mistress in 1507 or 1509.

Christian's succession to the throne was confirmed at the *Herredag*, or assembly of notables from the three northern kingdoms, which met at Copenhagen in 1513. The nobles and clergy of all three kingdoms regarded with grave misgivings a ruler who had already shown in Norway that he was not afraid of enforcing his authority to the uttermost. The *Rigsraads* of Denmark and Norway insisted, in the *haandfaestning* or charter extorted from the king, that the crowns of both kingdoms were elective and not hereditary, providing explicitly against any transgression of the charter by the king, and expressly reserving to themselves a free choice of Christian's successor after his death. But the Swedish delegates could not be prevailed upon to accept Christian as king at all. "We have," they said, "the choice between peace at home and strife here, or peace here and civil war at home, and we prefer the former." A decision as to the Swedish succession was therefore postponed. On the 12th of August 1515 Christian married Isabella of Burgundy, the grand-daughter of the emperor Maximilian. But he would not give up his liaison with Dyveke, and it was only the death of the unfortunate girl in 1517, under suspicious circumstances, that prevented serious complications with the emperor Charles V. Christian revenged himself by executing the magnate Torben Oxe, who, on very creditable evidence, was supposed to have been Dyveke's murderer, despite the strenuous opposition of Oxe's fellow-peers; and henceforth the king lost no opportunity of depressing the nobility and raising plebeians to power. His chief counsellor was Dyveke's mother Sigbrit, a born administrator and a commercial genius of the first order. Christian first appointed her controller of the Sound tolls, and ultimately committed to her the whole charge of the finances. A *bourgeois* herself, it was Sigbrit's constant policy to elevate and extend the influence of the middle classes. She soon became the soul of a middle-class inner council, which competed with *Rigsraad* itself. The patricians naturally resented their supersession and nearly every unpopular measure was attributed to the influence of "the foul-mouthed Dutch sorceress who hath bewitched the king."

Meanwhile Christian was preparing for the inevitable war with Sweden, where the patriotic party, headed by the freely elected governor Sten Sture the younger, stood face to face with the philo-Danish party under Archbishop Gustavus Trolle. Christian, who had already taken measures to isolate Sweden politically, hastened to the relief of the archbishop, who was beleaguered in his fortress of Ståke, but was defeated by Sture and his peasant levies at Vedla and forced to return to Denmark. A second attempt to subdue Sweden in 1518 was also frustrated by Sture's victory at Bränkyrka. A third attempt made in 1520 with a large army of French, German and Scottish mercenaries proved successful. Sture was mortally wounded at the battle of Börgerund, on the 19th of January, and the Danish army, unopposed, was approaching Upsala, where the members of the Swedish *Riksråd* had already assembled. The senators consented to render homage to Christian on condition that he gave a full indemnity for the past and a guarantee that Sweden should be ruled according to Swedish laws and custom; and a convention to this effect was confirmed by the king and the Danish *Rigsraad* on the 31st of March. But Sture's widow, Dame Christina Gyllenstjerna, still held out stoutly at Stockholm, and the peasantry of central Sweden, stimulated by her patriotism, flew to arms, defeated the Danish invaders at Balundsås (March

19th), and were only with the utmost difficulty finally defeated at the bloody battle of Upsala (Good Friday, April 6th). In May the Danish fleet arrived, and Stockholm was invested by land and sea; but Dame Christina resisted valiantly for four months longer, and took care, when she surrendered on the 7th of September, to exact beforehand an amnesty of the most explicit and absolute character. On the 1st of November the representatives of the nation swore fealty to Christian as hereditary king of Sweden, though the law of the land distinctly provided that the Swedish crown should be elective. On the 4th of November he was anointed by Gustavus Trolle in Stockholm cathedral, and took the usual oath to rule the realm through native-born Swedes alone, according to prescription. The next three days were given up to banqueting, but on the 7th of November "an entertainment of another sort began." On the evening of that day Christian summoned his captains to a private conference at the palace, the result of which was quickly apparent, for at dusk a band of Danish soldiers, with lanterns and torches, broke into the great hall and carried off several carefully selected persons. By 10 o'clock the same evening the remainder of the king's guests were safely under lock and key. All these persons had previously been marked down on Archbishop Trolle's proscription list. On the following day a council, presided over by Trolle, solemnly pronounced judgment of death on the proscribed, as manifest heretics. At 12 o'clock that night the patriotic bishops of Skara and Strängnäs were led out into the great square and beheaded. Fourteen noblemen, three burgomasters, fourteen town-councillors and about twenty common citizens of Stockholm were then drowned or decapitated. The executions continued throughout the following day; in all, about eighty-two people are said to have been thus murdered. Moreover, Christian revenged himself upon the dead as well as upon the living, for Sten Sture's body was dug up and burnt, as well as the body of his little child. Dame Christina and many other noble Swedish ladies were sent prisoners to Denmark. It has well been said that the manner of this atrocious deed (the "Stockholm Massacre" as it is generally called) was even more detestable than the deed itself. Christian suppressed his political opponents under the pretence of defending an ecclesiastical system which in his heart he despised. Even when it became necessary to make excuses for his crime, we see the same double-mindedness. Thus, while in a proclamation to the Swedish people he represented the massacre as a measure necessary to avoid a papal interdict, in his apology to the pope for the decapitation of the innocent bishops he described it as an unauthorized act of vengeance on the part of his own people.

It was with his brain teeming with great designs that Christian II. returned to his native kingdom. That the welfare of his dominions was dear to him there can be no doubt. Inhuman as he could be in his wrath, in principle he was as much a humanist as any of his most enlightened contemporaries. But he would do things his own way; and deeply distrusting the Danish nobles with whom he shared his powers, he sought helpers from among the wealthy and practical middle classes of Flanders. In June 1521 he paid a sudden visit to the Low Countries, and remained there for some months. He visited most of the large cities, took into his service many Flemish artisans, and made the personal acquaintance of Quentin Matsys and Albrecht Dürer, the latter of whom painted his portrait. Christian also entertained Erasmus, with whom he discussed the Reformation, and let fall the characteristic expression: "Mild measures are of no use; the remedies that give the whole body a good shaking are the best and surest."

Never had King Christian seemed so powerful as on his return to Denmark on the 5th of September 1521, and with the confidence of strength he at once proceeded recklessly to inaugurate the most sweeping reforms. Soon after his return he issued his great *Landelove*, or Code of Laws. For the most part this is founded on Dutch models, and testifies in a high degree to the king's progressive aims. Provision was made for the better education of the lower, and the restriction of the political influence of the higher clergy; there were stern prohibitions against

wreckers and "the evil and unchristian practice of selling peasants as if they were brute beasts"; the old trade guilds were retained, but the rules of admittance thereto made easier, and trade combinations of the richer burghers, to the detriment of the smaller tradesmen, were sternly forbidden. Unfortunately these reforms, excellent in themselves, suggested the standpoint not of an elected ruler, but of a monarch by right divine. Some of them were even in direct contravention of the charter; and the old Scandinavian spirit of independence was deeply wounded by the preference given to the Dutch. Sweden too was now in open revolt; and both Norway and Denmark were taxed to the uttermost to raise an army for the subjection of the sister kingdom. Foreign complications were now superadded to these domestic troubles. With the laudable object of releasing Danish trade from the grinding yoke of the Hansa, and making Copenhagen the great emporium of the north, Christian had arbitrarily raised the Sound tolls and seized a number of Dutch ships which presumed to evade the tax. Thus his relations with the Netherlands were strained, while with Lübeck and her allies he was openly at war. Finally Jutland rose against him, renounced its allegiance and offered the Danish crown to Duke Frederick of Holstein (January 20th, 1523). So overwhelming did Christian's difficulties appear that he took ship to seek help abroad, and on May 1st landed at Veere in Zealand. Eight years later (October 24th, 1531) he attempted to recover his kingdoms, but a tempest scattered his fleet off the Norwegian coast, and on the 1st of July 1532, by the convention of Oslo, he surrendered to his rival, King Frederick, and for the next 27 years was kept in solitary confinement, first in the Blue Tower at Copenhagen and afterwards at the castle of Kabendborg. He died in January 1559.

See K. P. Arnoldson, *Nordens enhet och Kristian II.* (Stockholm, 1899); Paul Frederik Barlod, *Danmarks Historie fra 1319 til 1536* (Copenhagen, 1885); *Danmarks Riges Historie*, vol. 3 (Copenhagen, 1897-1905); Robert Nisbet Bain, *Scandinavia*, chap. 2 (Cambridge, 1905). (R. N. B.)

CHRISTIAN III. (1503-1559), king of Denmark and Norway, was the son of Frederick I. of Denmark and his first consort, Anne of Brandenburg. His earliest teacher, Wolfgang von Utenhof, who came straight from Wittenberg, and the Lutheran Holsteiner Johann Rantzau, who became his tutor, were both able and zealous reformers. In 1521 Christian travelled in Germany, and was present at the diet of Worms, where Luther's behaviour profoundly impressed him. On his return he found that his father had been elected king of Denmark in the place of Christian II., and the young prince's first public service was the reduction of Copenhagen, which stood firm for the fugitive Christian II. He made no secret of his Lutheran views, and his outspokenness brought him into collision, not only with the Catholic *Rigsraad*, but also with his cautious and temporizing father. At his own court at Schleswig he did his best to introduce the Reformation, despite the opposition of the bishops. Both as stadtholder of the Duchies in 1526, and as viceroy of Norway in 1529, he displayed considerable administrative ability, though here too his religious intolerance greatly provoked the Catholic party. There was even some talk of passing him over in the succession to the throne, in favour of his half-brother Hans, who had been brought up in the old religion. On his father's death Christian was proclaimed king at the local diet of Viborg, and took an active part in the "Grevens Fejde" or "Count's War."

The triumph of so fanatical a reformer as Christian brought about the fall of Catholicism, but the Catholics were still so strong in the council of state that Christian was forced to have recourse to a *coup d'état*, which he successfully accomplished by means of his German mercenaries (12th of August 1536), an absolutely inexcusable act of violence loudly blamed by Luther himself, and accompanied by the wholesale spoliation of the church. Christian's finances were certainly readjusted thereby, but the ultimate gainers by the confiscation were the nobles, and both education and morality suffered grievously in consequence. The circumstances under which Christian III. ascended the throne naturally exposed Denmark to the danger of foreign domination. It was with the help of the gentry of the duchies that Christian

had conquered Denmark. German and Holstein noblemen had led his armies and directed his diplomacy. Naturally, a mutual confidence between a king who had conquered his kingdom and a people who had stood in arms against him was not attainable immediately, and the first six years of Christian III.'s reign were marked by a contest between the Danish *Rigsraad* and the German counsellors, both of whom sought to rule "the pious king" exclusively. Though the Danish party won a signal victory at the outset, by obtaining the insertion in the charter of provisions stipulating that only native-born Danes should fill the highest dignities of the state, the king's German counsellors continued paramount during the earlier years of his reign. The ultimate triumph of the Danish party dates from 1539, the dangers threatening Christian III. from the emperor Charles V. and other kinsmen of the imprisoned Christian II. convincing him of the absolute necessity of removing the last trace of discontent in the land by leaning exclusively on Danish magnates and soldiers. The complete identification of the Danish king with the Danish people was accomplished at the *Herredag* of Copenhagen, 1542, when the nobility of Denmark voted Christian a twentieth part of all their property to pay off his heavy debt to the Holsteiners and Germans.

The pivot of the foreign policy of Christian III. was his alliance with the German Evangelical princes, as a counterpoise to the persistent hostility of Charles V., who was determined to support the hereditary claims of his nieces, the daughters of Christian II., to the Scandinavian kingdoms. War was actually declared against Charles V. in 1542, and, though the German Protestant princes proved faithless allies, the closing of the Sound against Dutch shipping proved such an effective weapon in King Christian's hand that the Netherlands compelled Charles V. to make peace with Denmark at the diet of Spire, the 23rd of May 1544. The foreign policy of Christian's later days was regulated by the peace of Spire. He carefully avoided all foreign complications; refused to participate in the Schmalkaldic war of 1546; mediated between the emperor and Saxony after the fall of Maurice of Saxony at the battle of Sievershausen in 1553, and contributed essentially to the conclusion of peace. King Christian III. died on New Year's Day 1559. Though not perhaps a great, he was, in the fullest sense of the word, a good ruler. A strong sense of duty, genuine piety, and a cautious but by no means pusillanimous common-sense coloured every action of his patient, laborious and eventful life. But the work he left behind him is the best proof of his statesmanship. He found Denmark in ruins; he left her stronger and wealthier than she had ever been before.

See *Danmarks Riges Historie*, vol. 3 (Copenhagen, 1897-1901); Huitfeldt, *King Christian III.'s Historie* (Copenhagen, 1595); Bain, *Scandinavia*, cap. iv. v. (Cambridge, 1905). (R. N. B.)

CHRISTIAN IV. (1577-1648), king of Denmark and Norway, the son of Frederick II., king of Denmark, and Sophia of Mecklenburg, was born at Fredriksborg castle in 1577, and succeeded to the throne on the death of his father (4th of April 1588), attaining his majority on the 17th of August 1596. On the 27th of November 1597 he married Anne Catherine, a daughter of Joachim Frederick, margrave of Brandenburg. The queen died fourteen years later, after bearing Christian six children. Four years after her death the king privately wedded a handsome young gentlewoman, Christina Munk, by whom he had twelve children,—a connexion which was to be disastrous to Denmark.

The young king's court was one of the most joyous and magnificent in Europe; yet he found time for work of the most various description, including a series of domestic reforms (see *DENMARK: History*). He also did very much for the national armaments. New fortresses were constructed under the direction of Dutch engineers. The Danish navy, which in 1596 consisted of but twenty-two vessels, in 1610 rose to sixty, some of them being built after Christian's own designs. The formation of a national army was more difficult. Christian had to depend mainly upon hired troops, supported by native levies recruited for the most part from the peasantry on the crown domains. His first experiment with his newly organized army was successful. In

the war with Sweden, generally known as the "Kalmar War," because its chief operation was the capture by the Danes of Kalmar, the eastern fortress of Sweden, Christian compelled Gustavus Adolphus to give way on all essential points (treaty of Knäred, 20th of January 1613). He now turned his attention to Germany. His object was twofold: first, to obtain the control of the great German rivers the Elbe and the Weser, as a means of securing his dominion of the northern seas; and secondly, to acquire the secularized German bishoprics of Bremen and Werden as appanages for his younger sons. He skilfully took advantage of the alarm of the German Protestants after the battle of White Hill in 1620, to secure the coadjutorship to the see of Bremen for his son Frederick (September 1621), a step followed in November by a similar arrangement as to Werden; while Hamburg by the compact of Steinburg (July 1621) was induced to acknowledge the Danish overlordship of Holstein. The growing ascendancy of the Catholics in North Germany in and after 1623 almost induced Christian, for purely political reasons, to intervene directly in the Thirty Years' War. For a time, however, he stayed his hand, but the urgent solicitations of the western powers, and, above all, his fear lest Gustavus Adolphus should supplant him as the champion of the Protestant cause, finally led him to plunge into war against the combined forces of the emperor and the League, without any adequate guarantees of co-operation from abroad. On the 9th of May 1625 Christian quitted Denmark for the front. He had at his disposal from 19,000 to 25,000 men, and at first gained some successes; but on the 27th of August 1626 he was utterly routed by Tilly at Lutter-am-Barenberge, and in the summer of 1627 both Tilly and Wallenstein, ravaging and burning, occupied the duchies and the whole peninsula of Jutland. In his extremity Christian now formed an alliance with Sweden (1st of January 1628), whereby Gustavus Adolphus pledged himself to assist Denmark with a fleet in case of need, and shortly afterwards a Swedo-Danish army and fleet compelled Wallenstein to raise the siege of Stralsund. Thus the possession of a superior sea-power enabled Denmark to tide over her worst difficulties, and in May 1629 Christian was able to conclude peace with the emperor at Lübeck, without any diminution of territory.

Christian IV. was now a broken man. His energy was temporarily paralysed by accumulated misfortunes. Not only his political hopes, but his domestic happiness had suffered shipwreck. In the course of 1628 he discovered a scandalous intrigue of his wife, Christina Munk, with one of his German officers; and when he put her away she endeavoured to cover up her own disgrace by conniving at an intrigue between Vibeke Kruse, one of her discharged maids, and the king. In January 1630 the rupture became final, and Christina retired to her estates in Jutland. Meanwhile Christian openly acknowledged Vibeke as his mistress, and she bore him a numerous family. Vibeke's children were of course the natural enemies of the children of Christina Munk, and the hatred of the two families was not without influence on the future history of Denmark. Between 1629 and 1643, however, Christian gained both in popularity and influence. During that period he obtained once more the control of the foreign policy of Denmark as well as of the Sound tolls, and towards the end of it he hoped to increase his power still further with the assistance of his sons-in-law, Korfits Ulfeld and Hannibal Sehested, who now came prominently forward.

Even at the lowest ebb of his fortunes Christian had never lost hope of retrieving them, and between 1629 and 1643 the European situation presented infinite possibilities to politicians with a taste for adventure. Unfortunately, with all his gifts, Christian was no statesman, and was incapable of a consistent policy. He would neither conciliate Sweden, henceforth his most dangerous enemy, nor guard himself against her by a definite system of counter-alliances. By mediating in favour of the emperor, after the death of Gustavus Adolphus in 1632, he tried to minimize the influence of Sweden in Germany, and did glean some minor advantages. But his whole Scandinavian policy was so irritating and vexatious that Swedish statesmen made up their minds that a war with Denmark was only a

question of time; and in the spring of 1643 it seemed to them that the time had come. They were now able, thanks to their conquests in the Thirty Years' War, to attack Denmark from the south as well as the east; the Dutch alliance promised to secure them at sea, and an attack upon Denmark would prevent her from utilizing the impending peace negotiations to the prejudice of Sweden. In May the Swedish *Riksråd* decided upon war; on the 12th of December the Swedish marshal Lennart Torstensson, advancing from Bohemia, crossed the northern frontier of Denmark; by the end of January 1644 the whole peninsula of Jutland was in his possession. This totally unexpected attack, conducted from first to last with consummate ability and lightning-like rapidity, had a paralysing effect upon Denmark. Fortunately, in the midst of almost universal helplessness and confusion, Christian IV. knew his duty and had the courage to do it. In his sixty-sixth year he once more displayed something of the magnificent energy of his triumphant youth. Night and day he laboured to levy armies and equip fleets. Fortunately too for him, the Swedish government delayed hostilities in Scania till February 1644, so that the Danes were able to make adequate defensive preparations and save the important fortress of Malmö. Torstensson, too, was unable to cross from Jutland to Fünen for want of a fleet, and the Dutch auxiliary fleet which came to his assistance was defeated between the islands of Sylt and Rönö on the west coast of Schleswig by the Danish admirals. Another attempt to transport Torstensson and his army to the Danish islands by a large Swedish fleet was frustrated by Christian IV. in person on the 1st of July 1644. On that day the two fleets encountered off Kolberge Heath, S.E. of Kiel Bay, and Christian displayed a heroism which endeared him ever after to the Danish nation and made his name famous in song and story. As he stood on the quarter-deck of the "Trinity" a cannon close by was exploded by a Swedish bullet, and splinters of wood and metal wounded the king in thirteen places, blinding one eye and flinging him to the deck. But he was instantly on his feet again, cried with a loud voice that it was well with him, and set every one an example of duty by remaining on deck till the fight was over. Darkness at last separated the contending fleets; and though the battle was a drawn one, the Danish fleet showed its superiority by blockading the Swedish ships in Kiel Bay. But the Swedish fleet escaped, and the annihilation of the Danish fleet by the combined navies of Sweden and Holland, after an obstinate fight between Fehmarn and Laaland at the end of September, exhausted the military resources of Denmark and compelled Christian to accept the mediation of France and the United Provinces; and peace was finally signed at Brömsebro on the 8th of February 1645.

The last years of the king were still further embittered by sordid differences with his sons-in-law, especially with the most ambitious of them, Korfits Ulfeld. On the 21st of February 1648, at his earnest request, he was carried in a litter from Fredriksborg to his beloved Copenhagen, where he died a week later. Christian IV. was a good linguist, speaking, besides his native tongue, German, Latin, French and Italian. Naturally cheerful and hospitable, he delighted in lively society; but he was also passionate, irritable and sensual. He had courage, a vivid sense of duty, an indefatigable love of work, and all the inquisitive zeal and inventive energy of a born reformer. Yet, though of the stuff of which great princes are made, he never attained to greatness. His own pleasure, whether it took the form of love or ambition, was always his first consideration. In the heyday of his youth his high spirits and passion for adventure enabled him to surmount every obstacle with *élan*. But in the decline of life he reaped the bitter fruits of his lack of self-control, and sank into the grave a weary and broken-hearted old man.

See *Life* (Dan.), by H. C. Bering Liisberg and A. L. Larsen (Copenhagen, 1890-1891); *Letters* (Dan.), ed. Carl Frederik Bricka and Julius Albert Fridericia (Copenhagen, 1878); *Danmarks Riges Historie*, vol. 4 (Copenhagen, 1897-1905); Robert Nisbet Bain, *Scandinavia*, cap. vii. (Cambridge, 1905). (R. N. B.)

CHRISTIAN V. (1646-1699), king of Denmark and Norway, the son of Frederick III. of Denmark and Sophia Amelia of

Brunswick-Lüneburg, was born on the 15th of April 1646 at Flensburg, and ascended the throne on the 9th of February 1670. He was a weak despot with an exaggerated opinion of his dignity and his prerogatives. Almost his first act on ascending the throne was publicly to insult his consort, the amiable Charlotte Amelia of Hesse-Cassel, by introducing into court, as his officially recognized mistress, Amelia Moth, a girl of sixteen, the daughter of his former tutor, whom he made countess of Samsø. His personal courage and extreme affability made him highly popular among the lower orders, but he showed himself quite incapable of taking advantage permanently of the revival of the national energy, and the extraordinary overflow of native middle-class talent, which were the immediate consequences of the revolution of 1660. Under the guidance of his great chancellor Griffenfeldt, Denmark seemed for a brief period to have a chance of regaining her former position as a great power. But in sacrificing Griffenfeldt to the clamour of his adversaries, Christian did serious injury to the monarchy. He frittered away the resources of the kingdom in the unremunerative Swedish war of 1675-79, and did nothing for internal progress in the twenty years of peace which followed. He died in a hunting accident on the 25th of August 1699.

See Peter Edvard Holm, *Danmarks indre Historie under Enevældens* (Copenhagen, 1881-1886); Adolf Ditleva Jørgensen, *Peter Griffenfeldt* (Copenhagen, 1893); Robert Nisbet Bain, *Scandinavia* cap. x., xi. (Cambridge, 1905).

CHRISTIAN VII. (1749-1808), king of Denmark and Norway, was the son of Frederick V., king of Denmark, and his first consort Louisa, daughter of George II. of Great Britain. He became king on his father's death on the 14th of January 1766. All the earlier accounts agree that he had a winning personality and considerable talent, but he was badly educated, systematically terrorized by a brutal governor and hopelessly debauched by corrupt pages, and grew up a semi-idiot. After his marriage in 1766 with Caroline Matilda (1751-1775), daughter of Frederick, prince of Wales, he abandoned himself to the worst excesses. He ultimately sank into a condition of mental stupor, and became the obedient slave of the upstart Struensee (*q.v.*). After the fall of Struensee (the warrant for whose arrest he signed with indifference), for the last six-and-twenty years of his reign, he was only nominally king. He died on the 13th of March 1808. In 1772 the king's marriage with Caroline Matilda, who had been seized and had confessed to criminal familiarity with Struensee, was dissolved, and the queen, retaining her title, passed her remaining days at Celle, where she died on the 11th of May 1775.

See E. S. F. Reverdil, *Struensee et la cour de Copenhague, 1760-1772* (Paris, 1858); *Danmarks Riges Historie*, vol. v. (Copenhagen, 1897-1905); and for Caroline Matilda, Sir F. C. L. Wraxall, *Life and Times of Queen Caroline Matilda* (1864), and W. H. Wilkins, *A Queen of Tears* (1904).

CHRISTIAN VIII. (1786-1848), king of Denmark and Norway, the eldest son of the crown prince Frederick and Sophia Frederica of Mecklenburg-Schwerin, was born on the 18th of September 1786 at Christiansborg castle. He inherited the talents of his highly gifted mother, and his amiability and handsome features made him very popular in Copenhagen. His unfortunate first marriage with his cousin Charlotte Frederica of Mecklenburg-Schwerin was dissolved in 1810. In May 1813 he was sent as stadtholder to Norway to promote the loyalty of the Northmen to the dynasty, which had been very rudely shaken by the disastrous results of Frederick VI.'s adhesion to the falling fortunes of Napoleon. He did all he could personally to strengthen the bonds between the Norwegians and the royal house of Denmark, and though his endeavours were opposed by the so-called Swedish party, which desired a dynastic union with Sweden, he placed himself at the head of the Norwegian party of independence, and was elected regent of Norway by an assembly of notables on the 16th of February 1814. This election was confirmed by a *Storting* held at Eidsvold on the 10th of April, and on the 17th of May Christian was elected king of Norway, despite the protests of the Swedish party. Christian next attempted to interest the great powers in his cause, but

without success. On being summoned by the commissioners of the allied powers at Copenhagen to bring about a union between Norway and Sweden in accordance with the terms of the treaty of Kiel, and then return to Denmark, he replied that, as a constitutional king, he could do nothing without the consent of the *Storting*, to the convocation of which a suspension of hostilities on the part of Sweden was the condition precedent. Sweden refusing Christian's conditions, a short campaign ensued, in which Christian was easily worsted by the superior skill and forces of the Swedish crown prince (Bernadotte). The brief war was finally concluded by the convention of Moss on the 14th of August 1814 (see *NORWAY: History*). Henceforth Christian's suspected democratic principles made him *persona ingratis* at all the reactionary European courts, his own court included, and he and his second wife, Caroline Amelia of Augustenburg, whom he married in 1815, lived in comparative retirement as the leaders of the literary and scientific society of Copenhagen. It was not till 1831 that old King Frederick gave him a seat in the council of state. On the 13th of December 1839 he ascended the Danish throne as Christian VIII. The Liberal party had high hopes of "the giver of constitutions," but he disappointed his admirers by steadily rejecting every Liberal project. Administrative reform was the only reform he would promise. He died of blood-poisoning on the 20th of January 1848.

See Just Matthias Thiele, *Christian den Ottende* (Copenhagen, 1848); Yngvar Nielsen, *Bidrag til Norges Historie* (Christiania, 1882-1886).

CHRISTIAN IX. (1818-1906), king of Denmark, was a younger son of William, duke of Schleswig-Holstein-Sonderburg-Glücksburg (d. 1831), a direct descendant of the Danish king Christian III. by his wife Louise, a daughter of Charles, prince of Hesse-Cassel (d. 1836), and grand-daughter of King Frederick V. Born at Gottorp on the 8th of April 1818, Christian entered the army, and alone among the members of his family served with the Danish troops in Schleswig during the insurrection of 1848; but he was a personage of little importance until about 1852, ten years after his marriage with Louise (1817-1898), daughter of William, prince of Hesse-Cassel (d. 1867), and cousin of King Frederick VII. At this time it became imperative that satisfactory provision should be made for the succession to the Danish throne. The reigning king, Frederick VII., was childless, and the representatives of the great powers met in London and settled the crown on Prince Christian and his wife (May 1852), an arrangement which became part of the law of Denmark in 1853. The "protocol king," as Christian was sometimes called, ascended the throne on Frederick's death in November 1863, and was at once faced by formidable difficulties. Reluctantly he assented to the policy which led to war with the combined power of Austria and Prussia, and to the separation of the duchies of Schleswig, Holstein and Lauenburg from Denmark (see *SCHLESWIG-HOLSTEIN QUESTION*). Within the narrowed limits of his kingdom Christian's difficulties were more protracted and hardly less serious. During almost the whole of his reign the Danes were engaged in a political struggle between the "Right" and the "Left," the party of order and the party of progress, the former being supported in general by the *Landsting*, and the latter by the *Folketing*. The king's sympathies lay with the more conservative section of his subjects, and for many years he was successful in preventing the Radicals from coming into office. The march of events, however, was too strong for him, and in 1901 he assented in a dignified manner to the formation of a "cabinet of the Left" (see *DENMARK: History*). In spite of these political disturbances Christian's popularity with his people grew steadily, and was enhanced by the patriarchal and unique position which in his later years he occupied in Europe. With his wife, often called "the aunt of all Europe," he was related to nearly all the European sovereigns. His eldest son Frederick had married a daughter of Charles XV. of Sweden; his second son George had been king of the Hellenes since 1863; and his youngest son Waldemar (b. 1858) was married to Marie d'Orléans, daughter of Robert, duc de Chartres. Of his three daughters, Alexandra married Edward VII. of Great Britain;

Dagmar (Marie), the tsar Alexander III.; and Thyra, Ernest Augustus, duke of Cumberland. One of his grandsons, Charles, became king of Norway as Haakon VII. in 1905, and another, Constantine, crown prince of Greece, married a sister of the German emperor William II. Christian was also the ruler of Iceland, where he was received with great enthusiasm when he visited the island in 1874. He died at Copenhagen on the 29th of January 1906, and was buried at Roskilde.

See Barfod, *Kong Kristian IX.'s Regerings-Dagbog* (Copenhagen, 1876); and *Hans Majestet Kong Kristian IX.* (Copenhagen, 1888).

CHRISTIAN, WILLIAM (1608–1663), Manx politician, a son of Ewan Christian, one of the Manx deemsters, was born on the 14th of April 1608, and was known as *Illiam Dhone*, or Brown William. In 1648 the lord of the Isle of Man, James Stanley, 7th earl of Derby, appointed Christian his receiver-general; and when in 1651 the earl crossed to England to fight for Charles II. he left him in command of the island militia. Derby was taken prisoner at the battle of Worcester, and his famous countess, Charlotte de la Tremouille, who was residing in Man, sought to obtain her husband's release by negotiating with the victorious parliamentarians for the surrender of the island. At once a revolt headed by Christian broke out, partly as a consequence of this step, partly owing to the discontent caused by some agrarian arrangements recently introduced by the earl. The rebels seized many of the forts; then Christian in his turn entered into negotiations with the parliamentarians; and probably owing to his connivance the island was soon in the power of Colonel Robert Duckenfield, who had brought the parliamentary fleet to Man in October 1651. The countess of Derby was compelled to surrender her two fortresses, Castle Rushen and Peel castle, while Christian remained receiver-general, becoming governor of the island in 1656. Two years later, however, he was accused of misappropriating some money; he fled to England, and in 1660 was arrested in London. Having undergone a year's imprisonment he returned to Man, hoping that his offence against the earl of Derby would be condoned under the Act of Indemnity of 1661; but, anxious to punish his conduct, Charles, the new earl of Derby, ordered his seizure; he refused to plead, and a packed House of Keys declared that in this case his life and property were at the mercy of the lord of the island. The deemsters then passed sentence, and in accordance therewith Christian was executed by shooting on the 2nd of January 1663. This arbitrary act angered Charles II. and his advisers; the deemsters and others were punished, and some reparation was made to Christian's family. Christian is chiefly celebrated through the Manx ballad *Baase Illiam Dhone*, which has been translated into English by George Borrow, and through the references to him in Sir Walter Scott's *Peveril of the Peak*.

See A. W. Moore, *History of the Isle of Man* (1900).

CHRISTIAN OF BRUNSWICK (1599–1626), bishop of Halberstadt and a general during the earlier part of the Thirty Years' War, a younger son of Henry Julius, duke of Brunswick-Wolfenbüttel, was born at Gröningen on the 20th of September 1599. Having succeeded his father as "bishop" of Halberstadt in 1616, he obtained some experience of warfare under Maurice, prince of Orange, in the Netherlands. Raising an army he entered the service of Frederick V., elector palatine of the Rhine, just after that prince had been driven from Bohemia; glorying in his chivalrous devotion to Frederick's wife Elizabeth, he attacked the lands of the elector of Mainz and the bishoprics of Westphalia. After some successes he was defeated by Tilly at Höchst in June 1622; then, dismissed from Frederick's service, he entered that of the United Provinces, losing an arm at the battle of Fleurus, a victory he did much to win. In 1623 he gathered an army and broke into lower Saxony, but was beaten by Tilly at Stadtlohn and driven back to the Netherlands. When in 1625 Christian IV., king of Denmark, entered the arena of the war, he took the field again in the Protestant interest, but after some successes he died at Wolfenbüttel on the 16th of June 1626. Christian, who loved to figure as "the friend of God, the enemy of the priests," is sometimes called "the mad bishop," and was a merciless, coarse, and blasphemous man.

CHRISTIAN CATHOLIC CHURCH, the name assumed by a religious organization founded at Zion City near Chicago, Illinois, U.S.A., in 1896, by John Alexander Dowie (*q.v.*). Its members added to the usual tenets of Christianity a special belief in faith-healing, and laid much stress on united consecration services and the threefold immersion of believers. To assist Dowie, assistant overseers were appointed, and the operations of the community included religious, educational and commercial departments. Small branches sprang up in other parts of the United States, Mexico, Canada, Europe and Australasia. At the end of 1901 there were nearly 12,000 baptized believers. After 1903 considerable dissension arose among Dowie's followers: he was deposed in 1906; and after his death (1907) the city gradually became a community of normal type.

CHRISTIAN CONNECTION, a denomination of Christians in North America formed by secession, under James O'Kelly (1735–1826), of members of the Methodist Episcopal Church in North Carolina in 1793. The movement resembled those under the Campbells and Stone in Kentucky in 1801–1804, and in Lyndon, Vermont, among the Baptists in 1800. The predisposing cause in each case was the desire to be free from the "bondage of creed." Some of O'Kelly's followers joined the Disciples of Christ (*q.v.*). Their form of church government is Congregational; they take the Bible as the sole rule of faith and practice, and while adopting immersion as the proper mode of baptism, freely welcome Christians of every sect to their communion. They number about 100,000 members, mainly in the states of Ohio, Indiana and Illinois. The original seceders in Virginia and North Carolina bore for a time the name "Republican Methodists," and then called themselves simply "Christians," a designation which with the pronunciation "Christ-yans" is still often applied to them. Their position is curiously akin to that outlined by William Chillingworth (*q.v.*) in his famous work *The Religion of Protestants* (1637–1638).

CHRISTIAN ENDEAVOUR SOCIETIES, organizations formed for the purpose of promoting spiritual life among young people. They date from 1881, in which year Dr Francis E. Clark (*q.v.*) formed a Young People's Society of Christian Endeavour in his (Congregational) church at Portland, Maine, U.S.A. The idea was taken up elsewhere in America and spread to other countries, till, under the presidency of Dr Clark, a huge number of affiliated societies came into operation throughout the world. They take as their motto "For Christ and the Church," and have done much, especially in the non-episcopal churches, to prepare young men and women for active services in the Church. The organization is international and interdenominational, a World's Christian Endeavour Union being formed in 1895. The members do not form a separate denomination, but remain attached to their respective churches, being grouped in voluntary district federations.

CHRISTIANIA (officially KRISTIANIA), the capital of Norway, forming a separate county (*amt*), and the seat of a bishopric (*stift*). Pop. (1901) 229,101. It lies on the south-eastern coast, at the head of Christiania Fjord, about 30 m. from the open waters of the Skagerrack, is 59° 54' N. (about the latitude of the southern extremity of the Shetland Islands) and 10° 45' E., mainly on the west bank of the small Aker river. The situation is very beautiful, pine-wooded hills rising sharply behind the city, while several islands stud the fjord. The town is mainly modern, having increased rapidly in and since the second half of the 19th century, when brick and stone largely superseded wood as the building material. It is the seat of government, of the supreme courts, of the parliament (*Storting*), and of a university. The harbour is of two parts, the Björvik, where the larger steamers lie, and the Pipervik, west of this. On the promontory intervening between these two inlets stands the old fortress of Akershus, occupied as an arsenal and prison, and having a pleasant promenade upon its ramparts. Until 1719 it was a royal palace. At the head of the Björvik the principal railway station (*Hovedbanegaard*) stands in the Jernbanetorv (railway square), and north-west from this runs the principal street, Karl-Johans-gade. In this street, passing the Vor Frelsers Kirke (Church of our Saviour), the Storthings-Bygning

(parliament-house, 1866) is seen, facing a handsome square planted with trees. Beyond this is the National theatre (1899), with colossal statues of the dramatists Ibsen and Björnson. It faces the Friderician University, housed in three buildings dating from 1853, but founded by Frederick VI. of Denmark in 1811, embracing the five faculties of theology, law, medicine, history and philology, mathematics and natural sciences. The equipment of the university is very complete: it has attached to it a large and valuable library, natural history, ethnological and numismatic collections, with one of Scandinavian antiquities; also botanical gardens and an observatory. The Karl-Johans-gade gives upon the beautiful Slotspark, a wooded elevation crowned with the royal palace (*slot*), a plain building completed in 1848. North of the university is the museum of art, containing a noteworthy collection of sculpture and paintings of ancient and modern foreign masters, and of native works. The historical museum adjoining this contains northern antiquities, including two viking's ships, excavated, in 1867 and 1880 respectively, from the burial-places of the viking chiefs who owned and, according to custom, were buried in them. Another noteworthy collection is that of industrial art. The Bank of Norway, the exchange, and the courts of law lie between the harbours. Other institutions are the Freemasons' Lodge, housed in one of the handsomest buildings in the city (1844), a conservatory of music, naval, military and art schools, Athenaeum, and the great Dampkjökken or kitchen (1858), where dinners are provided for the poor.

The suburbs of Christiania are attractive and rapidly growing. On the east side of the river Aker is that of Oslo, with the existing episcopal palace, and an old bishop's palace, in which James VI. of Scotland (I. of England) was betrothed to Princess Anne of Denmark (1589). In the environs of the city are the royal pleasure castle of Oscarshol (1847-1852), on the peninsula Bygdö (Ladugaard) to the west of the city, and the Norwegian national museum (1881), containing industrial and domestic exhibits from the various provinces. Close at hand is an interesting collection of old Norwegian buildings, brought here from all parts, and re-erected, including an example of the timber church of the 12th century (*Stavekirke*). A collection of ancient agricultural implements is also shown. On Hovedö (Head Island) in the fjord, immediately opposite to the Akershus, are the ruins of a Cistercian monastery, founded in 1147 by monks from Kirkstead in Lincolnshire, England, and burnt down in 1532. There are sanatoria and inns among the surrounding hills, on which beautiful gardens are laid out, such as Hans Haugen, Frogneraeter, Holmenkollen, where the famous *ski* (snow-shoe) races are held in February, and Voksenkollen. Electric tramways connect the city and suburbs, and local steamers run from the Pipervik to the neighbouring islands and fjord-side towns and villages.

Christiania has two railway stations, the Hovedbanegaard by the Björvik, and the Vestbanegaard by the Pipervik. From the first trains run south to Fredrikshald and Gothenburg, east to Charlottenberg and Stockholm, north to Hamar and Trondhjem, and Otta in Gudbrandsdal, and to Gjøvik and the Valdres district. From the west station start the lines to Drammen, Laurvik, Skien and Kongsberg (for the Telemark district). The eastward extension of the railway between Bergen and Vossevangen, undertaken in 1896, had as its ultimate object the connexion of Christiania and Bergen by rail. With these extensive land communications Christiania is at once the principal emporium of southern Norway, and a favourite centre of the extensive tourist traffic. Regular passenger steamers serve the port from Hull, Newcastle, Grangemouth and London, from Trondhjem, Bergen and the Norwegian coast towns, from Hamburg, Amsterdam, Antwerp, &c. Except for two large shipbuilding yards, one with a floating dock, the other with a dry dock, most of the manufactories are concentrated in the suburb of Sagene, on the north side of the city, deriving their motive power from the numerous falls of the river Aker. They embrace factories for cotton and woollen spinning and weaving, paper, flour, soap and oil, bricks and tiles, matches, nails (especially horse-shoe nails), margarine, foundries and engineering shops, wood-pulp, tobacco,

matches, linen, glass, sail-cloth, hardware, gunpowder, chemicals, with sawmills, breweries and distilleries. There is also a busy trade in the preparation of granite paving-stones, and in the storing and packing of ice. Imports greatly exceed exports, the annual values being about 7½ and 1½ millions sterling respectively. The former consist principally of grain and flour, cottons and woollens, coffee, iron (raw and manufactured), coal, bacon and salt meat, oils, sugar, machinery, flax, jute and hemp, paper-hangings, paints, colours, &c., wines and spirits, raw tobacco, copper, zinc, lead and tin, silk, molasses and other commodities. The principal exports are wood-pulp, timber, nails, paper, butter and margarine, matches, condensed milk, fish, leather and hides, ice, sealskins, &c. Of the imports, Great Britain supplies the greater part of the cotton and woollen yarn, the machinery (including ships), and the raw metals; the United States about one-half of the oils and fats, and a large proportion of the food-stuffs, and skins, feathers, &c. Of the exports, almost the whole of the timber goes to Great Britain, together with the larger portion of the paper and food-stuffs (butter, &c.). The harbour is ice-bound for three or four months in the winter, when ships lie at Dröbak, lower down the fjord; but ice-breakers are also used. Early in 1899 the municipality voted £47,000 for the construction of a pier, a harbour for fishing-boats, protected by a mole, and a quay, 345 ft. long, on the shore underneath the Akershus. These works signalized a great scheme of improvement, involving a general rearrangement of the entire harbour.

The present suburb of Oslo represents the original city, which was founded on this site under that name (or Opslo) by Harald Sigurdsson in 1048. By the close of the 14th century it was established as the chief city of Norway. Trade was long dominated by the powerful Hanseatic League, at least until the beginning of the 16th century. The town, built mainly of wood, was no less subject to fires than all Norwegian towns have always been, and after one of these King Christian IV. refounded the capital on the new site it now occupies, and gave his name to it in 1624. By the close of the century it was fortified, but this did not prevent Charles XII. from gaining possession of it in 1716.

See L. Daae, *Det gamle Christiania, 1624-1824* (Christiania, 1890); Y. Nielsen, *Christiania und Umgegend* (Christiania, 1894); G. Amnéus, *La Ville de Christiania . . . Résumé historique, &c.* (Christiania, 1900).

CHRISTIANITY, the religion which accepts Jesus Christ as Lord and Saviour, embracing all who profess and call themselves Christians, the term derived from his formal title (*χριστός*, *i.e.* the anointed). Within this broad characterization are found many varieties of cult, organization and creed (see **CHURCH HISTORY**). Christianity is classed by the students of the science of religion as a universal religion; it proclaims itself as intended for all men without distinction of race or caste, and as in possession of absolute truth. In fact, Christianity has been widely accepted by varied races in very different stages of culture, and it has maintained itself through a long succession of centuries in lands where the transformations in political structure, the revolutions in social conditions, and the changes in science and philosophy, have been numerous and extreme.

Beginning in Asia, Christianity extended itself rapidly throughout the Roman empire and beyond its borders among the barbarians. When the Empire in the 4th century adopted it, its cult, organization and teaching were carried throughout the western world. The influences and motives and processes which led to the result were many and varied, but ultimately in one way or another it became the religion of Europe and of the nations founded by the European races beyond the seas and in the northern part of Asia called Siberia. Beyond these bounds it has not greatly prospered. The explanation of the apparent bounding of Christianity by Europe and its offspring is not, however, to be found in any psychological peculiarity separating the European races from those of other continents, nor in any special characteristic of Christianity which fits it for European soil. For not only were its founder and his disciples Asiatics, and the original authoritative writings Semitic, but Asiatic tribes and nations coming into Europe have been readily converted.

Missions in Asia too have achieved sufficient success to prove that there exists no inherent obstacle either in the gospel or in the Asiatic mind. Moreover, Christianity was once represented in Asia by a powerful organization extending throughout Persia and central Asia into India (see PERSIA). *Mutatis mutandis*, the same applies to Africa also, and Christianity still survives in both continents in the Coptic, Abyssinian and Armenian Churches. The explanation is rather to be sought in the political condition of the early centuries of the Christian era, especially in the rise of Mahomedanism. This may be regarded indeed as a form of Christianity, for it is not more foreign perhaps to the prevailing type than are some sects which claim the name. It exerted a strong influence upon Europe, but its followers have been peculiarly unsusceptible to missionary labours, and even in Europe have retained the faith of the Prophet. In the limitations of the Roman empire and in the separation of East and West consequent upon its decline, Christianity, as a dominant religion, was confined for a thousand years to Europe, and even portions of this continent for centuries were in the hands of its great foe. The East appeared as the Mahomedan dominions, and beyond these the continents of Asia and Africa were so dimly discerned that little reciprocal influence was felt. Thus the development of the two great civilized portions of the race in Europe and Asia followed independent lines in religion as in all else; and Africa, excepting its northern border, was left untouched by the progress of enlightenment.

Not only is Christianity thus the religion of a wide variety of races but across the divisions there cut other lines. In its organization Christianity exists in three great divisions, Roman, Greek and Protestant, and in various ancient sects in the Orient. The Roman Catholic and Greek divisions of the Christian Church are homogeneous in organization, but in Protestantism certain denominations are national, established by differing governments, and others are independent of governmental aid, making a large number of differing denominations. Some of these divisions are mutually antagonistic, denying to each other the name of Christian and even the hope of salvation.

According to a second classification, Christianity may be placed among the "individual" religions, since it traces its origin, like Islam and Buddhism, to an individual as its founder. This beginning is not in the dimness of antiquity nor in a multitude of customs, beliefs, traditions, rites and personalities, as is the case with the so-called "natural" religions. It is not implied that in the formation of the "natural" religions individuals were not of great importance, nor, on the other hand, that in individual religions the founder formed his faith independently of the community of which he was a part; but only that as undoubted historic facts certain religions, in tracing their lines to individuals, thereby acquired a distinctive character, and retain the impress of their founder. Such religions begin as a reform or a protest or revolt. They proclaim either a new revelation, or the return to an ancient truth which has been forgotten or distorted. They demand repentance and change of heart, *i.e.* the renouncing of the ordinary faith of the community and the acceptance of a new gospel. Thus demanding an act of will on the part of individuals, they are classed once more as "ethical" religions. To be sure, the new is built upon the old—in part unconsciously—and the rejection of the faith of the past, however violent, is never thoroughgoing. In consequence the old affects the new in various ways. Thus in Buddhism the presuppositions which Buddha uncritically took over work out their logical results in the Mahāyāna, so that great sects calling themselves "Buddhist" affirm what the Master denied and deny what he taught. Christianity takes Judaism (see HEBREW RELIGION) for granted—rejects it in part as a merely preparatory stage, in part reinterprets it, and does not submit what it accepts to rigorous scrutiny. As a result the Old Testament (see BIBLE) remains not only as the larger part of the Christian canon, but, sometimes, in some churches, as obscuring its distinctive truth. Moreover, in the transference of Christianity from the Jewish to the Greek-Roman world again various elements were taken into it. More properly perhaps we might consider the Greek

and Roman civilization as the permanent element—so that the relationship to it was not different from the relationship to Judaism—in part it was denied, in part it was of purpose accepted, in still larger part unconsciously the Greek-Roman converts took over with them the presuppositions of their older world view—and thus formed the moulds into which the Christian truth was run. Here again, in some instances the pre-Christian elements so asserted themselves as to obscure the new and distinctive teaching.

Christianity, regarded objectively as one of the great religions of the world, owes its rise to Jesus of Nazareth, in ancient Galilee. (See JESUS CHRIST.) By reverent disciples his ancestry was traced to the royal family of David, and his birth is ascribed by the church to the miraculous act of God. His life was spent, until the beginning of his public ministry, in humble circumstances as the son of a carpenter and his wife, Joseph and Mary. Of Joseph we hear nothing after the boyhood of Jesus, who followed the same trade, supporting himself and perhaps his mother and younger brothers and sisters. Of this period we have only a few fragmentary anecdotes and a stray reference or two. At thirty years of age he appeared in public, and after a short period (we cannot determine how long, but possibly eighteen months) he was crucified, upon the accusation of his countrymen, by the Roman authorities. He was without technical education, but he had been carefully trained in the sacred books, as was usual with his people. Belonging neither to the aristocracy nor to the learned class, he was one of the common people yet separate from them—a separation not of race or caste or education, but of unique personality.

His career is understood only in the light of his relations to Judaism (see HEBREW RELIGION). This faith, in a peculiarly vivid fashion, illustrates the growth and development of religion, for its great teachers in the highest degree possessed what the Germans call God-consciousness. The Hebrew national literature centres in the thought of God. It is Yahweh who is all and in all, the father, the leader, the hope, the hero of his people. No other national literature is so continuously and so highly religious. Another factor gives it still greater interest for the student of religion,—in it the progress of religious thought can be traced, and the varying elements of the religious life seen in harmony and in conflict.

In the early period the Hebrew religion was of the ordinary Semitic type. In its ancient stories were remnants of primitive religion, of tabu, of anthropomorphic gods, of native forms of worship, of magic and divination, of local and tribal cults. Out of these developed, by the labours of the prophets, a religion of high spirituality and exalted ethical ideals. According to it God demands not ritual nor sacrifice nor offerings. He does not delight in prayers and praise, but he demands truth in the soul and bids man to walk humbly and deal righteously and mercifully with his brother (Micah vi. 6-8; Isa. i. 2-20). He requires kindness, forgiveness and loving sacrifice from all to all (Isa. lviii. 3-12). This conception of God revealed itself as so essential to the prophets that their intense national feeling was modified. God would not deliver Israel because it was his people, descended from Abraham, his chosen, but he would punish it even more severely than the other nations because it denied him by its sins (Amos iii. 1-2). Yet Israel would not be destroyed, for a spiritual remnant, loving and obeying God, would be saved and purified (Ezek. xxxvii.-xxxviii.). Thus Israel survived its misfortunes. When the national independence was destroyed, the prophetic teaching held the people together in the hope of a re-establishment of the Kingdom when all nations should be subject to it and blessed in its everlasting reign of righteousness and peace (Isa. xlix., lx.).

Some of the prophets associated the restoration of the Kingdom with the coming of the Messiah, the anointed one, who should re-establish the line of David (Isa. ix. 6 f., xi. 1 f.; Micah v. 2; Ezek. xxxiv. 23, xxxvii. 24; Zech. ix. 9; Ps. ii. 72). Others said nothing of such a one, but seemed to expect the regeneration of Israel through the labours, sufferings and triumphs of

Relation
with
Judaism.

the righteous remnant (Isa. liii., Ezek. xxxvi.-xxxvii.). By the strong emphasis upon righteousness, the tribal Lord of Israel was revealed as the universal God, of one relationship to all men. This monotheism was not primarily cosmological nor metaphysical, but ethical. The Jews showed little capacity for abstract reasoning and never pursued their inquiries to the discovery of ultimate principles. Thus they did not develop a systematic cosmology, nor formulate a system of metaphysics. Their religion was pre-eminently "theocratic"; God was thought of as King, enthroned in heaven and supreme. In the beginning as a tribal deity his powers were limited and he was involved in the fortunes of his people. But as the conception of Yahweh was deepened and broadened, and, especially after the development of ethical monotheism, not only was he believed to possess power sufficient to ensure the triumph of his chosen people, but to be the creator and ruler of all things in heaven and on earth, the God whom all peoples should worship and obey.

But the prophetic teaching was obscured in part, by the nationalism of the prophets themselves, who exalted Israel as at once God's instrument and the peculiar object of his love; and in part by the triumph of a legal-ritualistic sacrificial system. In the downfall of Jerusalem, the experiences of the exile in Babylon, and the return to Judaea, the nation was transformed into a church. Apart from the brief Maccabean period, the intense patriotism of the people centred in the ecclesiastical organization. As a result, cult and organization and code hardened, forming a shell which proved strong enough to resist all disintegrating tendencies. Inevitably the freedom, spirituality and universality of the prophetic teaching were obscured. In the 1st century A.D. the national and priestly elements controlled; doubtless many individuals still were faithful to the purer prophetic message, though also zealous for the system of ritual and sacrifice, but for the ruling majority ritualistic service was the chief thing, justice, purity and mercy being subordinate. Hence in their view all who did not participate in the national worship and conform to the national usages were outcasts. The triumph of Israel was to be accomplished by the miraculous power of a Messiah who should descend out of heaven. His coming was delayed, in part by the opposition of demons, in part by the failure of the people to obey the law. This law embraced both moral and ceremonial elements derived from varied sources, but in the apprehension of the people it was all alike regarded as of divine origin. It was to be obeyed without question and without inquiry as to its meaning, because established by God. It was contained in the Sacred Scriptures (see BIBLE: *Old Testament*), which had been revealed by God supernaturally, and its meaning was set forth by schools of learned men whose interpretations were authoritative. The conception of salvation was mingled with ideas derived from the East during and after the period of captivity. The priesthood held still the ancient ideas. Salvation was for the nation, and the individual was not necessarily participant in it. Life after death was disbelieved or held as the existence of shades. There could be no resurrection of the body and no immortality (in the Greek sense). With these beliefs were associated a certain worldliness and want of fervour. The more actively and aggressively religious party, on the other hand, adopted the belief in the resurrection of the body, and in the individual's participation in the Messiah's kingdom; all the pious would have their share in it, while the wicked would be outcast. But these doctrines were variously conceived. By some the Messianic kingdom was thought of as permanent, by others as intermediary, the external kingdom being transcendent. So too some thought of a literal resurrection of the body of flesh and blood, while others thought that it would be transformed. The rudiments of some of these ideas can be found in the prophets, but their development took place after the exile, and indeed for the most part after the conclusion of the writings accounted canonical. Thus too the belief in a kingdom of demons held a large place in the mind of the people, though the references to such evil beings are almost absent from the sacred writings of the Old Testament. Again it is to the East that we must look for the origin of these ideas.

Jesus completed the prophetic teachings. He employed the old phraseology and imagery, but he was conscious that he used them in a new sense, and that he preached a new gospel of great joy. Jesus was not a historian, a critic or a theologian. He used the words of common men in the sense in which common men understood them. He did not employ the Old Testament as now reconstructed by scholarship or judged by criticism, but in its simple and obvious and traditional sense. And his background is the intellectual and religious thinking of his time. The ideas of demons and of the future, of the Bible and many other traditional conceptions, are taken over without criticism. So the idea of God which he sets forth is not that of a theologian or a metaphysician, but that of the unlearned man which even the child could understand. Yet though thus speaking in untechnical language, he revolutionized his terms and filled them with new meaning. His emphasis is his own, and the traditional material affords merely the setting for his thought. He was not concerned with speculative questions about God, nor with abstract theories of his relationship to the soul and to the world. God's continual presence, his fatherly love, his transcendent righteousness, his mercy, his goodness, were the facts of immediate experience. Not in proofs by formal logic but in the reality of consciousness was the certainty of God. Thus religion was freed from all particular and national elements in the simplest way. For Jesus did not denounce these elements, nor argue against them, nor did he seek converts outside of Israel, but he set forth communion with God as the most certain fact of man's experience and as simple reality made it accessible to every one. Thus his teaching contains the note of universality—not in terms and proclamations but as plain matter of fact. His way for others to this reality is likewise plain and level to the comprehension of the unlearned and of children.

For him repentance is put first, for how vastly changed is the conception of the religious life! The intricacies of ritual and theology are ignored, and ancient laws which contradict the fundamental beliefs are unhesitatingly abrogated or denied. He seizes upon the most spiritual passages of the prophets, and revives and deepens them. He sums up his teaching in supreme love to God and a love for fellow-man like that we hold for ourselves (Mark xii. 29-31). This supreme love to God is a complete oneness with him in will, a will which is expressed in service to our fellow-men in the simplest and most natural relationship (Luke x. 25-37). Thus religion is ethical through and through, as God's inner nature, expressed in forgiveness, mercy, righteousness and truth, is not something transcendental, but belongs to the realm of daily life. We become children of God and he our Father in virtue of a moral likeness (Matt. v. 43-48), while of any metaphysical, or (so to speak) physical relationship to God Jesus says nothing. With this clearly understood, man is to live in implicit trust in the divine love, power, knowledge and forgiveness. Hence he attains salvation, being delivered from sin and fear and death, for the divine attributes are not ontological entities to be discussed and defined in the schools, but they are realities, entering into the practical daily life. Indeed they are to be repeated in us also, so that we are to forgive our brethren as we ask to be forgiven (Matt. vi. 12; Luke xi. 4).

As religion thus becomes thoroughly ethical, so is the notion of the Messianic kingdom transformed. Its essential characteristic is the doing of the Father's will on earth as in heaven. Jesus uses parable after parable to establish its meaning. It is a seed cast into the ground which grows and prospers (Matt. xiii. 31-32). It is a seed sown in good ground and bringing forth fruit, or in bad ground and fruitless (Luke viii. 5-8; Mark iv. 1-32). It is a pearl of great price for which a man should sell all that he possesses (Matt. xiii. 44-46). It is not come "with observation," so that men shall say "lo here and lo there" (Luke xvii. 20-21). It is not of this world, and does not possess the characteristics or the glory of the kingdom of the earth (Luke xxii. 24-26; Mark x. 13-16). It is already present among men (Luke xvii. 21). Together with these statements in our sources are still mingled fragments of the more ordinary cataclysmic, apocalyptic conceptions, which in spite of much

ingenious exegesis, cannot be brought into harmony with Christ's predominant teaching, but remain as foreign elements in the words of the Master, possibly brought back through his disciples, or, more probably, used by Jesus uncritically—a part of the current religious imagery in which he shared.

It is often declared that in these teachings there is nothing new, and indeed analogies can be found for many sayings; yet nowhere else do we gain so strong an impression of originality. The net result is not only new but revolutionary; so was it understood by the Pharisees.

They and Jesus spoke indeed the same words and appealed to the same authorities, but they rightly saw in him a revolutionist who threatened the existence of their most cherished hopes. The Messianic kingdom which they sought was opposed point by point to the kingdom of which he spoke, and their God and his Father—though called by the same sacred name—were different. Hence almost from the beginning of his public ministry they constantly opposed him, the conflict deepening into complete antagonism.

Jesus has already been termed unique, one of the common people yet separated from them, and this description applies to the breadth, depth and reality of his sympathy. In the meagre records of his life there is evidence that he deemed no form of suffering humanity foreign to himself. This was not a mere sentiment, nor was his sympathy superficial, for it constituted the essential characteristic of his personality—"He went about doing good." In him the will of the Father for the redemption of the race was incarnate. This led him into the society of those outcasts who were condemned and rejected by the respectable and righteous classes. In contemptuous condemnation he was called the friend of the outcasts (Matt. xi. 19; Mark ii. 16-17), and on his part he proclaimed that these sinners would enter into the Kingdom of Heaven before the self-righteous saints (Matt. xxi. 31). Even the most repulsive forms of disease and sin drew from him only loving aid, while he recognized in all other men who laboured for the welfare of their fellows the most intimate relationship to himself. These constituted his family, and these were they whom his Father will bless.

Jesus recognized his unique position; he could not be ignorant of his powers. Even the prophets had spoken in the name of God; they accepted neither book nor priesthood as authoritative, but uttered their truth as they were inspired to speak, and commanded men to listen and obey. As in Jesus the whole prophetic line culminates, so does its consciousness. Reverent toward the Holy Scriptures, he spoke not as their expositor but with a divine power which invests his words with immediate and full authority. The prophets use the formula, "Thus saith the Lord," but he goes beyond them and speaks in his own name, "Amen, I say unto you." He knew himself as greater than the prophets, indeed as him of whom the prophets spoke—the Messiah. Only through this self-consciousness can we explain his mission and the career of his disciples. The prophets up to John foretold the coming of the kingdom (Matt. xi. 11-13; Luke xvi. 16), but Jesus opened its doors and made possible entrance into it. Where he is there it is, and hence those who follow him are God's children, and those who refuse his message are left outside in darkness. He is to sit as enthroned, judge and king, and by him is men's future to be determined (Matt. xxv. 31 f.; Mark xiii. 26). Indeed it was his presence more than his teaching which created his church. Great as were his words, greater was his personality. His disciples misunderstood what he said, but they trusted and followed him. By him they felt themselves freed from sin and fear—and under the influence of a divine power.

Though his claims to authoritative pre-eminence thus took him out of the class of prophets and put him even above Elijah and Moses (Mark ix. 2-7; Luke vii. 28; Luke x. 23-24), and though naturally this self-assertion seemed blasphemous to those who did not accept him, yet as he had transformed the traditional notion of the kingdom, so did he the current thought of the Messiah. The pre-eminence was not to be of rank and glory but of service and

self-sacrifice. In his kingdom there can be no strife for precedence, since its King comes not to be ministered unto but to minister and to give his life in the service of others (Mark ix. 33 f., x. 42-45). The formal acknowledgment of the Messiah's worth and position matters little, for to call him Lord does not ensure entrance into his kingdom (Matt. vii. 21-23). It is those who fail to recognize the spirit of sympathy and self-sacrificing service as divine and blaspheme redeeming love, who are in danger of eternal sin (Mark iii. 28-29). All who do the will of the Father, *i.e.* who serve their fellows, are the brethren of Christ, even though they do not call him Lord (Mark iii. 31-35; Matt. vii. 21); and those are blessed who minister to the needy even though ignorant of any relation to himself (Matt. xxv. 37-40). Finally, membership in his own selected company, or a place in the chosen people, is not of prime importance (Mark ix. 38-40; Luke xiii. 24-30).

Jesus also refuses to conform to the current ideas as to the establishment of the kingdom. He wrought miracles, it is true, because of his divine sympathy and compassion, but he refused to show miraculous signs as a proof of his Messianic character (Mark viii. 12). The tradition of the people implied a sudden appearance of the Messiah, but Jesus made no claims to a supernatural origin and was content to be known as the son of Joseph and Mary (Mark vi. 3-4). His kingdom is not to be set up by wonders and miraculous powers, nor is it to be established by force (Matt. xxvi. 52). Such means would contradict its fundamental character, for as the kingdom of loving service it can be established only by loving service. And as God is love, he can be revealed not by prodigies of power but only by a love which is faithful unto death.

Even the disciples of Jesus could not grasp the simplicity and profundity of his message; still less could his opponents. When the crisis came, he alone remained unshaken in his faith. He was accused of blasphemy to the ecclesiastical authorities and of insurrection to the civil rulers. He was condemned and crucified. His followers were scattered every man to his own place as sheep without a shepherd. Of his work nothing remained, not a written word, nor more than the rudiments of an organization. The decisive event, which turned defeat into victory and re-established courage and faith, was the resurrection of Jesus from the dead and his reappearance to his disciples. Our sources will not permit the precise determination of the order or the nature of these appearances, but in any case from them arose the faith which was the basis of the Christian Church and the starting-point of its theology.

The death of Jesus as a criminal, and his resurrection, profoundly aroused the belief and hopes of the little group of Jews who were his followers. His person and mission assumed the first place in their affections and their thinking. He had been to them a prophet, mighty in word and deed, but he now becomes to them the Messiah, Christ. It is not his word but his person which assumes first place, and faith is acceptance of him—crucified and risen—as Messiah. Hence his followers early acquire the name Christians from the Greek form of the word. With this emphasis upon the Messiah the Jewish element would seem to be predominant, but as a matter of fact it was not so. The earlier group of disciples, it is true, did not appreciate the universality of the teaching of Jesus, and they continued zealous for the older forms, but St Paul through his prophetic consciousness grasped the fundamental fact and became Jesus' true interpreter. As a result Christianity was rejected by the Jews and became the conquering religion of the Roman empire. In this it underwent another modification of far-reaching consequence.

In our earliest sources—the epistles of St Paul—Christ is the pre-existent man from heaven, who had there existed in the form of God, and had come to earth by a voluntary act of self-humiliation. He is before and above all things. By him all things exist. In the Johannine writings he is the Son of God—the Logos who in the beginning was with God—of whom are all things—who lightens every man—and who was incarnate in Jesus. Here the cosmological element is

His originality.

His Messianic claims.

Christianity and Greek thought.

again made prominent though not yet supreme, and the metaphysical problems are so close at hand that their discussion is imperative. Even in Paul the term Messiah had lost its definite meaning and became almost a proper name. Among the Greek Christians this process was complete. Jesus is the "Son of God"; and the great problem of theology becomes explicit. Religion is in our emotions of reverence and dependence, and theology is the intellectual attempt to describe the object of worship. Doubtless the two do not exactly coincide, not only because accuracy is difficult or even impossible, but also because elements are admitted into the definition of God which are derived from various sources quite distinct from the religious experience. Like all concepts the meaning of religious terms is changed with a changing experience and a changing world-view. Transplanted into the Greek world-view, inevitably the Christian teaching was modified—indeed transformed. Questions which had never been asked came into the foreground, and the Jewish presuppositions tended to disappear. Especially were the Messianic hopes forgotten or transferred to a transcendent sphere beyond death. When the empire became Christian in the 4th century, the notion of a kingdom of Christ on earth to be introduced by a great struggle all but disappeared, remaining only as the faith of obscure groups. Immortality—the philosophical conception—took the place of the resurrection of the body. Nevertheless the latter continues because of its presence in the primary sources, but it is no longer a determining factor, since its presupposition—the Messianic kingdom on earth—has been obscured. As thus the background is changed from Jewish to Greek, so are the fundamental religious conceptions.

The Semitic peoples were essentially theocratic in their religion; they used the forms of the sensuous imagination in setting forth the realities of the unseen world. They were not given to metaphysical speculation, nor long insistent in their inquiries as to the meaning and origin of things. With the Greeks it was far otherwise. For them ideas and not images set forth fundamental reality, and their restless intellectual activity would be content with nothing else than the ultimate truth. Their speculation as to the nature of God had led them gradually to separate him by an infinite distance from all creation, and to feel keenly the opposition of the finite and the infinite, the perfect and the imperfect, the eternal and the temporal. To them, therefore, Christianity presented itself not primarily as the religion of a redemption through the indwelling power of a risen saviour, as with Paul, nor even as the solution of the problem how the sins of men could be forgiven, but as the reconciliation of the antinomy of the intellect, indicated above. The incarnation became the great truth: God is no longer separated by a measureless distance from the human race, but by his entering into humanity he redeems it and makes possible its ultimate unity with himself. Such lines of thought provoke discussion as to the relationship of Jesus to God the Father, and, at a later period, of the nature of the Holy Spirit who enters into and transforms believers.

Greek philosophy in the second century A.D. had sunk for the most part into scepticism and impotence; its original impulse had been lost, and no new intellectual power took its place; only in Alexandria was there a genuine effort made to solve the fundamental problems of God and the world. Plato had made God accessible to the highest knowledge as the transcendent idea, remote from the world. For Aristotle, too, God in his essence is far above the world and at most its first mover. The stoics, on the other hand, taught his immanence, while the eclectics sought truth by the mingling of the two ideas. They accomplished their purpose in various ways, by distinguishing between God and his power—or by the notion of a hierarchy of super-sensible beings, or in a doctrine which taught that the operations of nature are the movement of pure spirit; or by the use of the "Word" of "Wisdom," half personified as intermediate between God and the world. While these monotheistic, pantheistic doctrines were taught in the schools, the people were left to a debased polytheism and to new superstitions imported from the Orient; the philosophers themselves were by no means unaffected by the popular

beliefs. Mingled with all these were the ancient legends of gods and heroes, accepted as inspired scripture by the people, and by philosophers in part explained away by an allegorical exegesis and in part felt increasingly as a burden to the intelligence. In this period of degeneracy there were none the less an awakening to religious needs and a profound longing for a new revelation of truth, which should satisfy at once the intellect and the religious emotions.

Christianity came as supplying a new power; it freed philosophy from scepticism by giving a definite object to its efforts and a renewed confidence in its mission. Monotheism henceforth was to be the belief not of philosophers only but even of the ignorant, and in Jesus Christ the union of the divine and the human was effected. The Old Testament, allegorically explained, became the substitute for the outgrown mythology; intellectual activity revived; the new facts gained predominant influence in philosophy, and in turn were shaped according to its canons. In theology the fundamental problems of ontological philosophy were faced; the relationship of unity to multiplicity, of noumenon to phenomena, of God to man. The new element is the historical Jesus, at once the representative of humanity and of God. As in philosophy, so now in theology, the easiest solution of the problem was the denial of one of its factors: and successively these efforts were made, until a solution was found in the doctrine of the Trinity, which satisfied both terms of the equation and became the fundamental creed of the church. Its moulds of thought are those of Greek philosophy, and into these were run the Jewish teachings. We have thus a peculiar combination—the religious doctrines of the Bible, as culminating in the person of Jesus, run through the forms of an alien philosophy.

The Jewish sources furnished the terms Father, Messiah, Son and Spirit. Jesus seldom employed the last term, and St Paul's use of it is not altogether clear. Already in Jewish literature it had been all but personified (cf. *The doctrine of the Trinity.* the Wisdom of Solomon). Thus the material is Jewish, though already modified doubtless by Greek influence. But the problem is Greek. It is not primarily ethical nor even religious, but it is metaphysical. What is the ontological relationship between these three factors? The answer is given in the Nicene formula, which is characteristically Greek. By it we perceive how God, the infinite, the absolute, the eternal, is yet not separated from the finite, the temporal, the relative, but, through the incarnation, enters into humanity. We further see how this entering into humanity is not an isolated act but continues in all the children of God by the indwelling spirit. Thus, according to the canons of the ancient philosophy, justice is done to all the factors of our problem—God remains as Father, the infinitely remote and absolute source of all; as Son, the Word who is revealed to man and incarnate in him; as Spirit, who dwells even in our own souls and by his substance unites us to God.

While thus the Greek philosophy furnished the dialectic and the mould for the characteristic Christian teaching, the doctrine of the Trinity preserved religious values. By Jesus the disciples had been led to God, and he was the central fact of faith. After the resurrection he was the object of praise, and soon prayers were offered in his name and to him. Already to the apostle Paul he dominates the world and is above all created things, visible and invisible, so that he has the religious value of God. It is not God as abstract, infinite and eternal, as the far-away creator of the universe, or even as the ruler of the world, which Paul worships, but it is God revealed in Jesus Christ, the Father of Jesus Christ, the grace and mercy in Jesus Christ which deliver from evil. Metaphysics and speculative theories were valueless for Paul; he was conscious of a mighty power transforming his own life and filling him with joy, and that this power was identical with Jesus of Nazareth he knew. In all this Paul is the representative of that which is highest and best in early Christianity. Speculation and hyperspiritualization were ever tending to obscure this fundamental religious fact: in the interest of a higher doctrine of God his true presence in Jesus was denied, and by exaggeration of Paul's doctrine of "Christ in us" the significance of the historic Jesus was given up. The Johannine writings,

which presupposed the Pauline movement, are a protest against the hyperspiritualizing tendency. They insist that the Son of God has been incarnate in Jesus of Nazareth, and that our hands have handled and our eyes have seen the word of life. This same purpose, namely, to hold fast to the historic Jesus, triumphed in the doctrine of the Trinity; Jesus was not to be resolved into an aeon or into some mysterious *tertium quid*, neither God nor man, but to be recognized as very God who redeemed the soul. Through him men were to understand the Father and to understand themselves as God's children. Thus the doctrine of the Trinity satisfied at once the philosophic intelligence of scholars and the religious needs of Christians. Only thus can its adoption and ultimate acceptance be explained. Its doctrinal form is the philosophic statement of beliefs held by the common people, who had little interest in theology, but whose faith centred in Jesus. It marks the naturalization of Christianity in the Greek world for the common people who believed in Christ, and for the philosophers who justified the faith to reason.

The historic and religious values of the doctrine of the Trinity may be illustrated by way of contrast. The Mahāyāna systems are the union of Buddha's teaching with the forms of the Brahman philosophy. The historic Buddha—the man Gautama—is taught as only one of a limitless series of incarnations or (better) appearances. For his life on earth with his material body was only an appearance, a seeming, a phenomenon, and simultaneously with its activities the true Buddha existed unmoved and eternal. Thus the way was opened for other apparitional Buddhas, and different sects take different ones as the objects of faith and worship. Moreover, our true nature is also Buddha. The conscious life of all men is apparitional and illusive. Salvation is the comprehension of this fact, and in the apprehension of our essential oneness with the absolute. Hence the way of salvation is by knowledge. In the Mahāyāna gnosticism was triumphant, and the historic values of Gautama's teaching and personality are lost. The Mahāyāna illustrates in part what would have followed the triumph of gnosticism in Christianity, for not only would the historic value of the life and teaching of Jesus have been lost, but with it the significance of humanity.

It is apparent that such a doctrine as the Trinity is itself susceptible of many explanations, and minds differently constituted lay emphasis upon its different elements. Especially is this true as its Greek terminology was translated into Latin, and from Latin came into modern languages—the original meaning being obscured or disguised, and the original issues forgotten. For some the first thought of God, the infinite and ultimate reality lying beyond and behind all phenomena, predominates. With these the historic manifestation of Jesus becomes only a guide to lead us to that immediate apprehension of God which is the end of theology, and to that immediate union with God which is the end of religion. Such an end is accomplished either by means of pure thought or by a oneness of pure feeling, giving as results the theological or philosophical construction of the concept God, or a mystical ecstasy which is itself at once immediate, inexplicable and indescribable. On the other hand, minds of a different and more concrete character so emphasize the distinctions God, Son and Holy Spirit, that a tritheistic construction appears—three individuals in the one Godhead: these individuals appearing, as for example in the Father and the Son, even in opposition to each other. In general we may say then that the Trinity takes on four differing aspects in the Christian church: in its more common and easily apprehended form as three Gods, in its ecclesiastical form as a mystery which is above reason to be accepted by faith, in its philosophic form as the highest reason which solves the ultimate problems of the universe, and finally, as a mode by which the spirit through an emotional content enters into communion with God himself.

To some Christians the doctrine of the Trinity appeared inconsistent with the unity of God which is emphasized in the Scriptures. They therefore denied it, and accepted Jesus Christ, not as incarnate God, but as God's highest creature by whom all else was created, or as the perfect man who taught the true

doctrine of God. The first view in the early Church long contended with the orthodox doctrine, but finally disappeared, and the second doctrine in the modern Church was set forth as easily intelligible, but has remained only as the faith of sects relatively small in number.

Allied with the doctrine of God which seeks the solution of the ultimate problem of all philosophy, the doctrine of salvation has taken the most prominent place in the Christian faith: so prominent, indeed, that to a large portion of believers it has been the supreme doctrine, and the doctrine of the deity of Jesus has been valued only because of its necessity on the effect of the atonement. Jesus alone of the great founders of religion suffered an early and violent death, even the death of a criminal. It became therefore the immediate task of his followers to explain this fact. This explanation was the more urgent because under the influence of Jewish monotheism the rule of God was accepted as an undoubted presupposition, so that the death of Jesus must be in accordance with his will. The early Church naturally used the terms and phrases of the prophets. He died the death of a criminal, not for his sins, but for ours. Isaiah liii. was suggested at once and became the central explanation: Christ is the suffering servant who is numbered with the transgressors and who bears the sins of many.

Jesus faced this problem perhaps before the opening of his ministry, certainly from his break with the ecclesiastical authorities. As his violent death drew near, his words indicated how he preserved his deep faith unshaken while yet recognizing the seeming failure of his mission. He devotes himself more exclusively to the little body of his faithful friends and commits his mission to them. As his work is sealed by his death his body is broken and his blood is shed for them. Through this is to come the victory which is denied to his life, as the seed cast into the ground and dead brings forth fruit. Our hints are few of Jesus' teaching, but this much, at least, we cannot doubt unless we suppose that death took him unawares, or that his explanation of the impending fact took on some un-Jewish form; and further, that the earliest tradition misrepresents him. But these hypotheses do not commend themselves, and we accept the tradition that Jesus taught that his death was an atonement for others.

Beyond this the gospel does not go. Why vicarious suffering is needed, or why the God who is the loving Father does not simply forgive, as in the parable of the prodigal son, is not asked. For after all it is not theory which is central, but the fact of the death, and the reason assigned is simply "for others."

In St Paul we find the beginnings of explanation, indeed of two explanations, and in the Epistle to the Hebrews the whole sacrificial system is found to culminate in Christ, of whom all priests and sacrifices are symbols, so that they are abolished with the coming of the great reality.

In the Greek world further questions are raised and the thought of the death as a ransom is prominent. To whom was the ransom paid? For a thousand years the answer was "to the devil." He had gained control of man by man's sin, and Christ set man free. God then, who is love, delivers us from evil through Christ, who pays the penalty of our transgression to the enemy of God and man. There were other theories also, indeed the germs of all later theories existed even in the second century, but this one prevailed. The heretic Marcion taught a variant, namely, the existence of two Gods, one of the Old Testament of law, the other of the New Testament of grace. Christ, unjustly condemned by the God of law, is given as reparation for all men who put their trust in him. From Anselm's time (11th century A.D.) this theory of Marcion's is held as orthodox in substance but is made monotheistic in form. St Anselm denied that any penalty was due to the devil, and in terms of feudal honour restated the problem. The conflict here is in God himself, so to speak, between his immutable righteousness and his limitless grace. In the sacrifice of Jesus these are reconciled. This doctrine of St Anselm's attaches itself readily to texts of St Paul, for his teachings contain undeniably the vicarious propitiatory element.

These theories have to do with the being to whom the ransom is paid or the sacrifice offered. Another group of theories deals

The
doctrine
of the
cross

with the effect of the death of Christ upon the sinner. One of these is the so-called governmental theory, wherein the death of Christ is set forth as for the sake of good government, so that the forgiveness of sins shall not be thought a sign of laxity. Again, by other theologians the death of Jesus is extolled because of the moral influence it exerts, since Christ's devotion unto death incites a like devotion in us.

Excepting in relatively narrow circles these theories have been seriously studied only by professed theologians. That Christ died for us, and that we are saved by him, is indeed the living truth of the Church in all ages, and a false impression of the fact is given by dwelling upon theories as if they were central. At best they bear only the relationship of philosophy to life.

Another explanation, or (better) system of beliefs, has been far more influential in the Church. Belief in mysterious powers attached to food, feasts, ceremonial rites and sacred things is all but universal. Primitive man seldom connects sacrifice with notions of propitiation, indeed only in highly ethicized religions is the consciousness of sin or of guilt pre-eminent. Sacrifice was believed to exert an influence on the deity which is quasi-physical, and in sacrificial feasts God and worshipper are in mysterious union. Sometimes, indeed, such contact with deity is thought to be dangerous, and the rites indicate avoidance (*tabu*), and sometimes it is thought desirable.

So universal are such ideas that the problem in particular religions is not their origin but their form. In the Old Testament repeatedly they are found in conflict with the prophetic ideals. Sometimes the prophets denounce them, sometimes ignore them, sometimes attempt to reform and control them. Jesus ignores them, his emphasis being so strong upon the ethical and spiritual that the rest is passed by. In the early Church, still Jewish, the belief was in the coming of a mysterious power from God which produced ecstasy and worked wonders. St Paul also believes in this, but insists that it is subordinate to the peaceable fruits of righteousness. With the naturalization of the Church in the Gentile world ethical ideas became less prominent, and the sacramental system prevailed. By baptism and the Lord's Supper grace is given (*ex opere operato*), so that man is renewed and made capable of salvation. Already in the 2nd century baptism was described as a bath in which the health of the soul is restored, and the Lord's Supper as the potion of immortality. Similar notions present in the ethnic faiths take the Christian facts into their service, the belief of the multitude without essential change remaining vague and undefined. While the theologians discussed doctrine the people longed for mystery, as it satisfied their religious natures. By sacraments they felt themselves brought into the presence of God, and to sacraments they looked for aid. Many sacraments were adopted by portions of the Church, until at last the sacred number seven was agreed upon.

As the way of salvation was modified, so too was the idea of salvation: the dream of a Messianic kingdom on earth, with its corollary the resurrection of the physical body, faded away, especially after the Roman empire adopted Christianity. It was no longer the Jewish nation against the heathen empire, for the Jewish nation had ceased to be, and the empire and the Church were one. Salvation henceforth is not the descent of the New Jerusalem out of heaven, but the ascent of the saints to heaven; for the individual it is not the resurrection of the body but the immortality of the soul. So Jesus is no longer Christ or Messiah, but the Son of God. These terms again are variously interpreted: heaven is still thought of by many under the imagery of the book of Revelation, and by others it is conceived as a mystical union of the soul with God through the intelligence or of feelings. Yet the older conceptions still continue, Christianity not becoming purely and simply Greek. Again and again individuals and groups turn back to the Semitic cycle of hopes and ideas, while the reconciliation of the two systems, Jewish and Graeco-Roman, becomes the task of exegetes and theologians.

These hopes and theories of salvation, however, do not explain the power of Christianity. Jesus wearied himself with the healing of man's physical ailments, and he was remembered as the great

physician. Early Christian literature is filled with medical terms, applied (it is true) for the greater part to the cure of souls. The records of the Church are also filled with the efforts of Jesus' followers to heal the diseases and satisfy the wants of men. A vast activity animated the early Church: to heal the sick, to feed the hungry, to succour the diseased, to rescue the fallen, to visit the prisoners, to forgive the erring, to teach the ignorant, were ministries of salvation. A mighty power impelled men to deny themselves in the service of others, and to find in this service their own true life. None the less the first place is given to the salvation of the soul, since, created for an unending existence, it is of transcendent importance. While man is fallen and by nature vile, nevertheless his possibilities are so vast that in comparison the affairs of earth are insignificant. The word, "What shall it profit a man if he gain the whole world and lose his own soul?" comes to mean that the individual soul outvalues the whole world. With emphasis upon God as creator and ruler, and upon man as made in God's image, endowed with an unending existence, and subject to eternal torture if not redeemed, the concept of personality has been exalted at the expense of that of nature, and the future has been magnified at the expense of the present. Thus a future heaven is man's true home, and theology instead of philosophy or natural science is his proper study.

Indeed, intellectual interest centred in religion. Natural science was forsaken, except in so far as it ministered to theology. Because the Old Testament contained references to the origin and the objects of the universe, a certain amount of natural science was necessary, but it was only in this connexion that it had any value. By Augustine's time this process is complete. His writings contain most of the knowledge of his age, but it is strictly subordinate to his theological purpose. Hence, when the barbarians submerged southern Europe, theology alone survived. The Church entered upon a new task. In the beginning Christianity had been the teacher of religion to highly civilized peoples—now it became the civilizing agent to the barbarians, the teacher of better customs, the upholder of law and the source of knowledge. The learned men were monks and priests, the universities were Church institutions, and theology was the queen of the sciences.

The relation of cult to creed is still undetermined. Theoretically the first depends on the second, for its purpose is twofold: the excitation of worthy religious emotions and the attaining of our desires; and how shall these objects be attained unless we know him whom we worship and to whom we pray? But it is plausibly maintained that the reverse is true, namely, that theology rests on cult. In the beginnings of consciousness instinctive reactions precede definite thoughts, and even in mature life thoughts often follow acts instead of preceding them. Our religious consciousness is simply our ordinary consciousness obeying its laws. So un-purposed does cult grow up that it combines many elements of diverse origin, and is seldom precisely and wholly in accordance with the creed. No doubt the two interact, cult influencing creed and creed modifying cult—cult, perhaps, being most powerful in forming the actual religious faith of the multitude. Cult divides into two unequal parts, the stimulation of the religious emotions and the control of piety. In the Church service it came early to centre in the sacrament of the Eucharist (*q.v.*). In the earliest period the services were characterized by extreme freedom, and by manifestations of ecstasy which were believed to indicate the presence of the spirit of God; but as the years went by the original enthusiasm faded away, the cult became more and more controlled, until ultimately it was completely subject to the priesthood, and through the priesthood to the Church. In the Roman communion the structure of the sacred edifice, the positions and attitudes of the priest and the congregation, the order of service, emphasize the mystery and the divine efficacy of the sacrament. The worshipper feels himself in the immediate presence of God, and enters into physical relations with him. Participation in the mass also releases from guilt, as the Lamb of God offered up atones for sin and intercedes

*Theology
and
worship.*

*The con-
cepts of
salvation.*

with the Father in our behalf. Thus in this single act of devotion both objects of all cults are attained.

As the teaching and person of Jesus were fitted into the framework of the Greek philosophy, and the sacraments into the deeper and broader forms of popular belief, so was the organization shaped by the polity of the Roman empire. Jesus gathered his group of followers and committed to it his mission, and after his resurrection the necessities of the situation brought about the choice of quasi-officials. Later the familiar polity of the synagogue was loosely followed. A completer organization was retarded by two factors, the presence of the apostles and the inspiration of the prophets. But when the apostles died and the early enthusiasm disappeared, a stricter order arose. Practical difficulties called for the enforcement of discipline, and differences of opinion for authority in doctrine; and, finally, the sacramentarian system required a priesthood. In the 2nd century the conception of a Catholic Church was widely held and a loose embodiment was given it; after the conversion of the empire the organization took on the official forms of the empire. Later it was modified by the rise of the feudal system and the re-establishment of the modern European nationalities (see CHURCH HISTORY).

The polity of the Church was more than a formal organization; it touched the life of each believer. Very early, Christianity was conceived to be a new system of law, and faith was interpreted as obedience. Legalism was joined with sacramentarianism, doubling the power of the priest. Through him Church discipline was administered, a complete system of ecclesiastical penalties, *i.e.* penance, growing up. It culminated in the doctrine of purgatory, a place of discipline, of purifying suffering after death. The Roman genius for law strengthened and systematized this tendency.

The hierarchy which centres in the pope constitutes the Church of which the sacramental system is the inner life and penance is the sanction. It is thus a divine-human organization. It teaches that the divine-human Son of God established it, and returning to heaven committed to the apostles, especially to St Peter, his authority, which has descended in an unbroken line through the popes. This is the charter of the Church, and its acceptance is the first requisite for salvation; for the Church determines doctrine, exercises discipline and administers sacraments. Its authority is accompanied by the spirit of God, who guides it into truth and gives it miraculous power. Outside the Church there are only the "broken lights" of man's philosophy and the vain efforts of weak human nature after virtue.

Christianity in its complete Roman development is thus the coming of the supernatural into the natural. The universe falls into these orders, the second for the sake of the first, as nature is of and for God. Without him nature at its highest is like a beautiful statue, devoid of life; it is of secondary moment compared even to men, for while it passes away he continues for ever. He is dependent, therefore, not upon nature, but upon God's grace for salvation, and this comes through the Church. In the book of Revelation the New Jerusalem descending from heaven to the earth may be taken as a symbol of a continuing process: the human receives the divine, as the Virgin Mary received the Holy Spirit and brought forth Jesus, perfect man and perfect God. Thus the Church ever receives God and has a twofold nature; its sacraments through material and earthly elements impart a divine power; its teachings agree with the highest truths of philosophy and science, yet add to these the knowledge of mysteries which eye hath not seen, nor ear heard, neither hath it entered into the heart of man to conceive; it sanctifies human relationships, but the happiness of earth at purest and best is only a shadow of the divine bliss which belongs to the redeemed soul. Hence man should deny the world for the sake of the other world, and the title "religious" belongs distinctly to the monastic and priestly life. Theology is the queen of the sciences, and nothing should be taught in school or university which contradicts its conclusions. Moreover, nothing should be done by the state which interferes with the transcendent interest committed to the

Church. Thus the Church touches and controls all realms of life, and the cycle is complete. It began as separate from the world and proscribed by it; next it adapted itself to the learning, the customs and the polity of the world. Finally it asserted its mastery and assumed sovereign power over all. The Church in its completed form was the outcome of a long development; if the seed was Jewish the environment was Gentile. Into the full tree were gathered the effects, not only of the initial energy, but of the forces of earth, air, water and sun. The Roman Church expressed the beliefs and answered the needs of the people, and this explains in part both its forms and its power, its long continuance and wide supremacy.

The Church was never completely successful in unifying its organization. In part it shared the destiny of the Roman empire, and with it fell into two parts, East separating from West. Indeed the East never really acknowledged the Roman primacy nor shared in its development, and it still remains apart. With characteristic oriental conservatism it claims the title of "Orthodox," and retains the creed and organization of the early Church. In general its conception of the relation of the world to the super-world is identical with that of the Roman Church, though somewhat less defined, as its organization is less complete. It has remained in the second stage mentioned above; established, as in Russia, by the empire, it is dependent upon it and in alliance with it. In the Mahommedan dominions it has been recognized as a state within the state, and in these communities faith and patriotism are one.

The idea of the Roman Church was imperfectly embodied at the best; the divine gift was in earthen vessels. The world was never completely cast out; indeed the Church became the scene for ambition and the home of luxury and pleasure. It was entangled also in the political strife of the feudal ages and of the beginning of modern empires. Its control of the sciences embroiled it with its own philosophers and scholars, while saints and pure-minded ecclesiastics attempted, without success, its reform from within. Finally, through Luther, the explosion came, and western Christendom broke into two parts—Catholic and Protestant.

Protestantism in its primary principle is the return to primitive Christianity. The whole development which we have traced, culminating in the ecclesiastical-doctrinal system of the Roman Church, is regarded as a corruption, since foreign and even heathen elements have been brought in, so that the religion established by Christ is obscured or lost. For Protestants the Bible only now becomes the infallible, inspired authority in faith and morals. Interpretations by the Fathers or by the councils are to be taken only as aids to its understanding. With this principle is associated a second, the liberty of the individual; he reads the sacred Scriptures and interprets them for himself without the intervention of priests or church; and he enters by faith in Christ into communion with God, so that all believers are priests. Here may be noted a fundamental difference in the psychology of religion, since in the Roman Church the chief appeal is to the emotions, while in the Reformed it is to the intelligence. Yet this appeal to the intelligence is not rationalism: the latter makes reason the supreme authority, rejecting all which does not conform to it; the Bible is treated like any other book, to be accepted or rejected in part or in whole as it agrees with our canons of logic and our general science, while religion submits to the same process as do other departments of knowledge. But in Protestantism reason and the light of nature are in themselves as impotent as in the Roman Church. The Bible interpreted by man's unaided intelligence is as valueless as other writings, but it has a sacramental value when the Holy Spirit accompanies its teaching, and the power of God uses it and makes the soul capable of holiness. In all this the supernatural is as vividly realized as in the Roman Church; it is only its mediation which is different.

These principles are variously worked out in the different churches and variously expressed. In part because of historical circumstances, the divergence from the older systems is more marked in some Protestant churches than in others, yet on the

*The
Eastern
Church.*

*The
Reforma-
tion.*

*The
completed
doctrine
of the
Roman
Church.*

whole these two principles determine cult and in part organization. As in the Roman Church cult centres in the mass, so in the Reformed Church it centres in the sermon. The Holy Spirit, the determining factor in the religious life, uses the Bible as his means, and calls the intelligence into action. The clergyman is primarily the preacher, renewed by God's power and enlightened by the Spirit, so that he speaks with divine authority. The ancient Jewish prophetic office is revived, yet with a difference: the ancient prophets acknowledged no external authority, but the Protestant preacher is strictly subordinate to the Scriptures of which he is the interpreter. Beside the sermon the sacraments are observed as established by Christ—two in number, baptism and the Lord's Supper. But these do not exert a quasi-physical or magical influence, *ex opere operato*. Unless there be faith in the recipient, an understanding of the meaning of the sacrament and an acceptance of it, it is valueless or harmful. Prayer and praise also are effective only as the congregation intelligently join in them; hence they are not to be solely by a priest nor in a strange tongue, as the clergyman is simply the leader of the devotions of the people. In large portions of the Church also opportunity for the free expression of the religious experience of the laity is found.

The emphasis upon the believer and his freedom from all external authority do not result in a thoroughgoing individualism. Luther clearly held to the unity of all Christians, and Protestants are agreed in this. For them, as for the Roman Church, there is a belief in a catholic or all-embracing Church, but the unity is not that of an organization; Christians are one through an indwelling spirit; they hold the same faith, undergo the same experience and follow the same purpose. This inner life constitutes the oneness of believers and forms the true Church which is invisible. It expresses itself in outward forms, yet there are not two Churches visible and invisible, but only one. The spiritual experience of the individual utters itself in words, and desires association with others who know the same grace. There is formed a body of teaching in which all agree, and an organization in which the common experience finds expression and aid. While then membership in this organization is not primary, it assumes a higher and even a vital importance, since a true experience recognizes the common faith and the common fellowship. Were it to refuse assent to these, doubt would be thrown upon its own trustworthiness.

Historically these principles were only in part embodied, for the Reformation was involved in political strife. The Reformers turned to the government for aid and protection, and throughout Europe turmoil and war ensued. In consequence, in the Protestant nations the state assumed the ultimate authority over the Church. Moreover, in the early days of the Reformation the Catholic Church charged it with a lawless individualism, a charge which was seemingly made good by an extreme divergence in theological opinion and by riots in various parts of the Protestant world. The age was indeed one of ferment, so that the foundations of society and of religion seemed threatened. The Reformers turned to the state for protection against the Roman Church, and ultimately as a refuge from anarchy, and they also returned to the theology of the Fathers as their safeguard against heresy. Instead of the simplicity of Luther's earlier writings, a dogmatic theology was formed, and a Protestant ecclesiasticism established, indistinguishable from the Roman Church in principle. The main difference was in the attitude to the Roman allegiance and to the sacramentarian system. There was thus by no means a complete return to the Bible as the sole authority, but the Bible was taken as interpreted by the earlier creeds and as worked into a doctrinal system by the scholastic philosophy. Thus Protestantism also came to identify theology with the whole range of human knowledge, and in its official forms it was as hostile to the progress of science as was the Roman Church itself.

Many Protestants rebelled against this radical departure from the principles of the Reformation and of Biblical Christianity. To them it seemed the substitution of the authority of the Church for the authority of a living experience and of intellectual

adherence to theological propositions for faith. The freedom of the individual was denied when the state enforced religious conformity. Thus a struggle within Protestantism arose, with persecutions of Protestants by Protestants. Moreover, many failed to find the expression of their faith in the official creed or in the established organization, and Protestantism divided into many sects and denominations, founded upon special types of religious experience or upon particular points in doctrine or in cult. Thus Protestantism presents a wide diversity in comparison with the regularity of the Roman Church. This we should expect indeed from its insistence upon individual freedom; yet, notwithstanding certain notable exceptions, amid the diversity there is a substantial unity, a unity which in our day finds expression in common organizations for great practical ends, for example in the "Bible Societies," "Tract Societies," the "Young Men's Christian Associations," "Societies of Christian Endeavour," &c., which disregard denominational lines.

The coming of the northern peoples into the Roman world profoundly modified Christianity. It shared indeed in the dreariness and corruption of the times commonly called *Christ-* the "dark ages," but when at last a productive period *anity and* began the Church was the first to profit by it. Since *the moderna* all educated men were priests, it assimilated the new *world*. learning—the revived Aristotelianism—and continued its control of the universities. In the 13th century it was supreme, and Christianity was identified with world systems of knowledge and politics. Both were deemed alike divine in origin, and to question their validity was an offence against God. Christianity thus had passed through three stages in politics as in science. At first it was persecuted by the state, then established by it, and finally dominated over it; so its teaching was at first alien to philosophy and despised by it, next was accepted by it and given form and rights through it, and finally became queen of the sciences as theology and ruled over the whole world of human knowledge. But the triumph by its completeness ensured new conflicts; from the disorder of the middle ages arose states which ultimately asserted complete autonomy, and in like fashion new intellectual powers came forth which ultimately established the independence of the sciences.

In the broadest sense the underlying principle of the struggle is the reassertion of interest in the world. It is no longer merely the scene for the drama of the soul and God, nor is man independent of it, but man and nature constitute an organism, humanity being a part of the vaster whole. Man's place is not even central, as he appears a temporary inhabitant of a minor planet in one of the lesser stellar systems. Every science is involved, and theology has come into conflict with metaphysics, logic, astronomy, physics, chemistry, geology, zoology, biology, history and even economics and medicine. From the modern point of view this is unavoidable and even desirable, since "theology" here represents the science of the 13th century. As in the political world the states gained first the undisputed control of matters secular, rejecting even the proffered counsel of the Church, and then proceeded to establish their sovereignty over the Church itself, so was it in the empire of the mind. The rights gained for independent research were extended over the realm of religion also; the two indeed cannot remain separate, and man must subordinate knowledge to the authority of religion—or make science supreme, submitting religion to its scrutiny and judging it like other phenomena. Under this investigation Christianity does not appear altogether exceptional. Its early logic, ontology and cosmology, with many of its distinctive doctrines, are shown to be the natural offspring of the races and ages which gave them birth. Put into their historical environment they are freed from adverse criticism, and indeed valued as steps in the intellectual development of man's mind. Advanced seriously, however, as truths to-day, they are put aside as anachronisms not worthy of dispute. The Bible is studied like other works, its origins discovered and its place in comparative religion assigned. It does not appear as altogether unique, but it is put among the other sacred books. For the great religions of the world show similar cycles of development,

similar appropriations of prevalent science and philosophy, similar conservative insistence upon ancient truth, and similar claims to an exclusive authority.

With this interest is involved an attitude of mind toward the supernatural. As already pointed out, nature and super-nature were taken as physically and spatially distinct. The latter could descend upon the former and be imparted to it, neither subject to nature nor intelligible by reason. In science the process has been reversed; nature ascends, so to speak, into the region of the supernatural and subdues it to itself; the marvellous or miraculous is brought under the domain of natural law, the canons of physics extend over metaphysics, and religion takes its place as one element in the natural relationship of man to his environment. Hence the new world-view threatens the foundations of the ecclesiastical edifice. This revolution in the world-view is no longer the possession of philosophers and scholars, but the multitude accepts it in part. Education in general has rendered many familiar with the teachings of science, and, moreover, its practical benefits have given authority to its maxims and theories. The world's problem is not only therefore acute, but the demand for its solution is wider than ever before.

The Roman Catholic Church uncompromisingly reasserts its ancient propositions, political and theological. The cause is lost indeed in the political realm, where the Church is obliged to submit, but it protests and does not waive or modify its claims (see the Syllabus of 1864, paragraphs 19 ff., 27, 54 and 55). In the Greek and Protestant churches this situation cannot arise, as they make no claims to governmental sovereignty. In the intellectual domain the situation is more complex. Again the Roman Church unhesitatingly reaffirms the ancient principles in their extreme form (Syllabus, paragraphs 8-9-13; Decrees of the Vatican Council, chapter 4, note especially canon 4-2). The works of St Thomas Aquinas are recommended as the standard authority in theology (Encyc. of Leo XIII., *Aeterni Patris*, Aug. 4, 1879). In details also the conclusions of modern science are rejected, as for example the origin of man from lower species, and, in a different sphere, the conclusions of experts as to the origins of the Bible. Faith is defined as "assent upon authority," and the authority is the Church, which maintains its right to supremacy over the whole domain of science and philosophy.

The Greek Church remains untouched by the modern spirit, and the Protestant Churches also are bound officially to the scholastic philosophy of the 17th century; their confessions of faith still assert the formation of the world in six days, and require assent to propositions which can be true only if the old cosmology be correct. Officially then the Church identifies Christianity with the position outlined above, and hostile critics agree to this identification, rejecting the faith in the name of philosophic and scientific truth.

On the other hand there are not wanting individuals and even large bodies of Christians who are intent upon a reinterpretation.

Even in the official circles of the Church, not excepting the Roman Church, there are many scholars who find no difficulty in remaining Christian while accepting the modern scientific view of the world. This is possible to some because the situation in its sharp antithesis is not present to their minds: by making certain compromises on the one side and on the other, and by framing private interpretations of important dogmas, they can retain their faith in both and yet preserve their mental integrity. A large literature is produced, reconciling science and theology by softening and compromising and adapting; a procedure in accordance with general historical development, for men do not love sharp antagonisms, nor are they prepared to carry principles to their logical conclusions. By a fortunate power of mind they are able to believe as truths mutually inconsistent propositions.

Thus the crisis is in fact not so acute as it might seem. No great institution lives or dies by logic. Christianity rests on great religious needs which it meets and gratifies, so that its life (like all other lives) is in unrationalized emotions. Reason seeks ever to rationalize these, an attempt which seems to destroy yet really

fulfils. As thus the restless reason tests the emotions of the soul, criticizes the traditions to which they cling, rejects the ancient dogmas in which they have been defined, the Church slowly participates in the process: silently this position and that are forsaken, legends and beliefs once of prime importance are forgotten, or when forced into controversy many ways are found by which the old and the new are reconciled: the sharpness of distinctions can be rubbed off, expressions may be softened, definitions can be modified and half-way resting-places afforded, until the momentous transition has been made and the continuity of tradition is maintained. Finally, as the last step, even the official documents may be revised. Such a process in Christianity is everywhere in evidence, for even the Roman Church admits the modern astronomy. So too it accepts the changes in the world of politics with qualified approval. In the Syllabus of 1864 the separation of state and church was anathematized, yet in 1906 this separation in the United States was held up as an example to be followed by the French government. In the Protestant Churches the process is precisely similar. No great church has yet modified its articles of religion so as to admit, for example, that the Garden of Eden was not a definite place where Eve was tempted, yet the doctrine is contradicted with approval by individuals, and the results of modern science are accepted and taught without rebuke. In all this the Church shows its essential oneness with other organizations of society, the government, the family, which are at once deeply rooted in the past, and yet subject to the influences of the present. For Christianity is by no means wholly intellectual, nor chiefly so. It would be fully as true to facts to describe this religion as a vast scheme for the amelioration of the condition of humanity. In education, in care for the sick, the poor, the outcast, it has retained the spirit of its Lord. Though it has at times denied this spirit, been guilty of crimes, persecutions, wars and greed—still the Church has never quite forgotten him who went about doing good, nor freed itself from the contagion of his example. No age has been so responsive to the needs of man as our own; whatever doubts men have as to the doctrines or the cults there is an agreement wider than in the past in the good works whose inspiration is a divine love.

Yet the intellectual crisis cannot be ignored in the interest of the practical life. Men must rationalize the universe. On the one hand there are churchmen who attempt to repeat the historical process which has naturalized the Church in alien soils by appropriating the forces of the new environment, and who hold that the entire process is inspired and guided by the spirit of God. Hence Christianity is the absolute religion, because it does not preclude development but necessitates it, so that the Christianity that is to come shall not only retain all that is important in the Christianity of the past and present but shall assimilate new truth. On the other hand some seek the essential Christianity in a life beneath and separable from the historic forms. In part under the influence of the Hegelian philosophy, and in part because of the prevalent evolutionary scientific world-view, God is represented under the form of pure thought, and the world process as the unfolding of himself. Such truth can be apprehended by the multitude only in symbols which guide the will through the imagination, and through historic facts which are embodiment of ideas. The Trinity is the essential Christian doctrine, the historic facts of the Christian religion being the embodiment of religious ideas. The chief critical difficulty felt by this school is in identifying any concrete historic fact with the unchanging idea, that is, in making Jesus of Nazareth the incarnation of God. God is reinterpreted, and in place of an extra-mundane creator is an omnipresent life and power. The Christian attainment is nothing else than the thorough intellectual grasp of the absolute idea and the identification of our essential selves with God. With a less thorough-going intellectualism other scholars interpret Christianity in terms of current scientific phraseology. Christianity is dependent upon the understanding of the universe; hence it is the duty of believers to put it into the new setting, so that it adopts and adapts astronomy, geology, biology and

Theories of development.

psychology. With this accomplished, Christianity will resume its ancient place. Consciously and of purpose the attempt is made to do once more what has been done repeatedly before, to restate Christianity in the terms of current science.

From all these efforts to reconstruct systematic theology with its appropriations of philosophy and science, groups of Christians turn to the inner life and seek in its realities to find the confirmation of their faith. They also claim oneness with a long line of Christians, for in every age there have been men who have ignored the dogma and the ritual of the Church, and in contemplation and retirement have sought to know God immediately in their own experience. To them at best theology with its cosmology and its logic is only a shadow of shadows, for God reveals himself to the pure in heart, and it matters not what science may say of the material and fleeting world. This spirit manifests itself in wide circles in our day. The Gordian knot is cut, for philosophy and religion no longer touch each other but abide in separate realms.

In quite a different way a still more influential school seeks essential Christianity in the sphere of the ethical life. It also would disentangle religion from cosmology and formal philosophy. It studies the historic development of the Church, noting how element after element has been introduced into the simplicity of the gospel, and from all these it would turn back to the Bible itself. In a thorough-going fashion it would accomplish what Luther and the Reformation attempted. It regards even the earliest creeds as only more or less satisfactory attempts to translate the Christian facts into the current language of the heathen world. But the process does not stop with this rejection of the ancient and the scholastic theology. It recognizes the scientific results attained in the study of the Bible itself, and therefore it does not seek the entire Bible as its rule of truth. To it Jesus Christ, and he alone, is supreme, but this supremacy does not carry with it infallibility in the realm of cosmology or of history. In these too Jesus participated in the views of his own time; even his teaching of God and of the future life is not lacking in Jewish elements, yet none the less he is the essential element in Christianity, and to his life-purpose must all that claims to be Christianity be brought to be judged. To this school Christianity is the culmination of the ethical monotheism of the Old Testament, which finds its highest ideal in self-sacrificing love. Jesus Christ is the complete embodiment of this ideal, in life and in death. This ideal he sets before men under the traditional forms of the kingdom of God as the object to be attained, a kingdom which takes upon itself the forms of the family, and realizes itself in a new relationship of universal brotherhood. Such a religion appeals for its self-verification not to its agreement with cosmological conceptions, either ancient or modern, or with theories of philosophy, however true these may be, but to the moral sense of man. On the one hand, in its ethical development, it is nothing less than the outworking of that principle of Jesus Christ which led him not only to self-sacrificing labour but to the death upon the cross. On the other hand, it finds its religious solution in the trust in a power not ourselves which makes for the same righteousness which was incarnate in Jesus Christ.

Thus Christianity, as religion, is on the one hand the adoration of God, that is, of the highest and noblest, and this highest and noblest as conceived not under forms of power or knowledge but in the form of ethical self-devotion as embodied in Jesus Christ, and on the other hand it meets the requirements of all religion in its dependence, not indeed upon some absolute idea or omnipotent power, but in the belief that that which appeals to the soul as worthy of supreme worship is also that in which the soul may trust, and which shall deliver it from sin and fear and death. Such a conception of Christianity can recognize many embodiments in ritual, organization and dogma, but its test in all ages and in all lands is conformity to the purpose of the life of Christ. The Lord's Prayer in its oldest and simplest form is the expression of its faith, and Christ's separation of mankind on the right hand and on the left in accordance with their service or refusal of service to their fellow-men is its own judgment of the right

of any age or church to the name Christian. This school also represents historic Christianity, and maintains the continuity of its life through all the ages past with Christ himself. But this continuity is not then in theological systems or creeds, nor in sacraments and cult, nor in organization, but in the noble company of all who have lived in simple trust in God and love to humanity. It is this true Church of the spirit and purpose of Jesus which has been the supreme force for the uplifting of humanity.

Christianity has passed through too many changes, and it has found too many interpretations possible, to fear the time to come. Thoroughgoing reconstruction in every item of theology and in every detail of polity there may be, yet shall the Christian life go on—the life which finds its deepest utterance in the words of Christ, "Thou shalt love the Lord thy God with all thy heart and thy neighbour as thyself"; the life which expresses its profoundest faith in the words Christ taught it to pray, "Our Father"; the life which finds its highest rule of conduct in the words of its first and greatest interpreter, "Let this mind be in you which was also in Christ Jesus our Lord."

BIBLIOGRAPHY.—Detailed bibliographies accompany the separate articles on subjects connected with the Christian religion and Church. In the following list a selection is given of books on the wider and general subject:—

Extent and Growth.—D. Dorchester, *The Problem of Religious Progress* (revised ed., 1894); S. Gulick, *The Growth of the Kingdom of God* (1895); James S. Dennis, *Christian Missions and Social Progress* (1906).

Prophets of Israel.—Rudolf Smend, *Lehrbuch der alttestamentlichen Religionsgeschichte* (2nd ed., 1899); A. B. Davidson, *Old Testament Prophecy* (1903); Karl Budde, *Religion of Israel to the Exile* (1899); W. Robertson Smith, *The Prophets of Israel and their Place in History* (1899); A. F. Kirkpatrick, *Doctrine of the Prophets* (3rd ed., 1901); Beruk Duhm, *Die Theologie der Propheten* (1875).

Judaism.—Emil Schürer, *History of the Jewish People in the Time of Jesus Christ* (Eng. trans., Edinburgh, 1890); C. G. Montefiore, *Lectures on the Origin and Growth of Religion as illustrated by the Religion of the Ancient Hebrews* (2nd ed., 1893); W. Bousset, *Die Religion des Judentums im neutestamentlichen Zeitalter* (2nd ed., 1906).

The Life and Teaching of Jesus.—Hans Heinrich Wendt, *The Teaching of Jesus* (1892), 2 vols.; Oskar Holtzmann, *The Life of Jesus* (Eng. trans., 1904); Paul Wernle, *Beginnings of Christianity*, 2 vols. (1903-1904); T. Crawford Burkitt, *The Gospel History and its Transmission* (1906).

The Beginnings of Christianity.—Ernst von Dobschütz, *Christian Life in the Primitive Church* (Eng. trans., 1904); A. C. McGiffert, *The Apostolic Age* (1900); Carl Weizsäcker, *The Apostolic Age* (Eng. trans., 1897); Otto Pfeiderer, *Das Urchristentum* (1902).

The Expansion of Christianity.—Edwin Hatch, "The Influence of Greek Ideas and Usages upon the Christian Church," *The Hibbert Lectures, 1888* (1890); Adolf Harnack, *The Expansion of Christianity in the First Three Centuries* (Eng. trans., 1904); Sir W. M. Ramsay, *The Church in the Roman Empire* (1893).

The History of Church and of Dogma.—Adolf Harnack, *History of Dogma* (Eng. trans., 1895); Reinhold Seeberg, *Lehrbuch der Dogmengeschichte* (1895, 2 vols.); Philip Schaff, *The Creeds of Christendom* (3 vols., 1881, 3rd ed.).

The Roman Church.—Joseph Wilhelm and Thomas B. Scannell, *Manual of Catholic Theology* (1906); J. A. Moehler, *Symbolism* (trans. 1844); Thomas Aquinas, *The Summa* (Eng. trans., 1907); William Ward, *The Ideal of a Christian Church* (1844).

The Greek Church.—"The Creeds of the Greek and Russian Churches," in Schaff, *Creeds*, vol. ii. pp. 275-542; and J. Michalcesu, *Die Bekenntnisse und die wichtigsten Glaubenszeugnisse der griechisch-orientalischen Kirche* (Leipzig, 1904).

Protestantism.—John Calvin, *Institutio Religionis Christianae*, (1536; Eng. trans., 1816); Charles Hodge, *Systematic Theology* (3 vols., 1872); Ernst Troeltsch, *Die Absolutheit des Christentums und die Religionsgeschichte* (1902); *First Principles of the Reformation, or the Ninety-five Theses and the Three Primary Works*, trans. by Henry Wace and C. A. Buchheinz (1883).

Christianity in the Modern World.—Andrew D. White, *Conflict of Science with Theology* (2 vols., 1896); D. F. Strauss, *Der alle und der neue Glaube* (1872; Eng. trans., 1873); A. J. Balfour, *The Foundations of Belief* (1897); J. Ward, *Naturalism and Agnosticism* (1899).

Modern Adaptations of Christianity.—William Adams Brown, *Christian Theology in Outline* (1906); Augustus Sabatier, *Religions of Authority and the Religion of the Spirit* (1904); J. A. Zahm, *Evolution and Dogma* (1896); John Henry Newman, *An Essay on the Development of Christian Doctrine* (1845); Edward Caird, *The Evolution of Religion* (1893); Otto Pfeiderer, *Philosophy of Religion* (Eng. trans., 1888, especially volumes 3 and 4); Newman Smyth, *Old Faiths in New Lights* (1879), *Through Science to Faith* (1902); Henry Drummond, *The Ascent of Man* (1894); William Ralph Inge, *Christian Mysticism* (Bampton Lectures, 1894); Wilhelm Herrmann, *The Communion of the Christian with God* (1895); George William

Knox, *Direct and Fundamental Proofs of the Christian Religion* (1903); Albrecht Ritschl, *Die christliche Lehre von der Rechtfertigung und Versöhnung* (1900).

Modern Definitions of Christianity—Alfred Loisy, *The Gospel and the Church* (1904); Adolf Harnack, *What is Christianity?* (1901); William Adams Brown, *The Essence of Christianity* (1902); Ernest Troeltsch, *Das Wesen des Christentums*; J. Kaftan, *Das Wesen der christlichen Religion* (2nd ed., 1888); J. Caird, *The Fundamental Ideas of Christianity* (1899). (G. W. KN.)

CHRISTIANSAND (KRISTIANSAND), a fortified seaport of Norway, the chief town of a diocese (*stift*), on a fjord of the Skagerrack, 175 m. S.W. of Christiania by sea. Pop. (1900) 14,701. It stands on a square peninsula flanked by the western and eastern harbours and by the Otter river. The situation, with its wooded hills and neighbouring islands, is no less beautiful than that of other south-coast towns, but the substitution of brick for wood as building material after a fire in 1892 made against the picturesqueness of the town. There is a fine cathedral, rebuilt in Gothic style after a fire in 1880. Christiansand is an important fishing centre (salmon, mackerel, lobsters), and sawmills, wood-pulp factories, shipbuilding yards and mechanical workshops are the principal industrial works. The port is the largest on the south coast, and all the coast steamers, and those serving Christiania from London, Hull, Grangemouth, Hamburg, &c., touch here. The Saetersdal railway follows that valley north to Byglandsfjord (48 m.), whence a good road continues to Viken i Valle at the head of the valley. Flekkerö, a neighbouring island, is a favourite pleasure resort. The town was founded in 1641 by Christian IV., after whom it was named.

CHRISTIAN SCIENCE, a system of theosophic and therapeutic doctrine, which was originated in America about 1866 by Mrs Mary Baker Glover Eddy, and has in recent years obtained a number of adherents both in the United States and in European countries. Mrs. Eddy (1821–1910; *née* Baker) was born near Concord, New Hampshire; in 1843 she married Colonel G. W. Glover (d. 1844), in 1853 she married Daniel Patterson (divorced 1873), and in 1877 Dr Asa Gilbert Eddy (d. 1883). About the year 1867 she came forward as a healer by mind-cure. She based her teaching on the Bible, and on the principles that man's essential nature is spiritual, and that, the Spirit of God being Love and Good, moral and physical evil are contrary to that Spirit, and represent an absence of the True Spirit which was in Jesus Christ. There is but one Mind, one God, one Christ, and nothing real but Mind. Matter and sickness are subjective states of error, delusions which can be dispelled by the mental process of a true knowledge of God and Christ, or Christian science. Ordinary *medical* science—using drugs, &c.—is therefore irrelevant; spiritual treatment is the only cure of what is really mental error. Jesus himself healed by those means, which were therefore natural and not miraculous, and promised that those who believed should do curative works like his. In 1876 a Christian Scientist Association was organized. Mrs Eddy had published in the preceding year a book entitled *Science and Health, with Key to the Scriptures*, which has gone through countless editions and is the gospel of Christian Science. In 1879 she became the pastor of a "Church of Christ, Scientist," in Boston, and also founded there the "Massachusetts Metaphysical College" (1881; closed 1889) for the furtherance of her tenets. The first denominational chapel outside Boston was built at Oconto, Wisconsin, in 1886; and in 1894 (enlarged and reconstructed in 1906) a great memorial church was erected in Boston. Mrs Eddy's publications also include *Retrospection and Introspection* (1891), *Unity of Good and Unreality of Evil* (1887), *Rudimental Divine Science* (1891), *Christian Healing* (1886), &c. The progress of the cult of Christian Science has been remarkable, and by the beginning of the 20th century many hundreds of Christian Science churches had been established; and the new religion found many adherents also in England. A purely local and congregational form of government was adopted, but Christian Scientists naturally looked to the mother church in Boston, with Mrs Eddy as its guiding influence, as their centre. A monthly magazine, *The Christian Science Journal* (founded in 1883), and the weekly *Christian Science Sentinel* are published officially in Boston.

The profession of the paid Christian Science "healer" has been very prominent in recent years both in America and in England; and very remarkable successes have been claimed for the treatment. In some serious cases of death after illness, where a coroner's inquest has shown that the only medical attendance was that of a Christian Science "healer," the question of criminal responsibility has been prominently canvassed; but an indictment in England against a healer for manslaughter in 1906 resulted in an acquittal. The theosophic and the medical aspects of Christian Science may perhaps be distinguished; the latter at all events is open to grave abuse. But the modern reaction in medical practice against drugs, and the increased study of the subject of "suggestion," have done much to encourage a belief in faith-healing and in "psychotherapy" generally. In 1908, indeed, a separate movement (Emmanuel), inspired by the success of Christian Science, and also emanating from America, was started within the Anglican Communion, its object being to bring prayer to work on the curing of disease; and this movement obtained the approval of many leaders of the church in England.

An "authorized" *Life of Mrs Eddy*, by Sibyl Wilbur (1908), deals with the subject acceptably to her disciples. "Georgine Milmine's" *Life of M. B. G. Eddy, and History of Christian Science* (1909), though not so acceptable, is a judicious critical account. A detailed indictment against the whole system, by a competent English doctor (Stephen Paget), will be found in *The Faith and Works of Christian Science* (1909).

CHRISTIANSUND (KRISTIANSUND), a seaport on the west coast of Norway, in Romsdal *amt* (county), 259 m. N.E. by N. of Bergen, in the latitude of the Faeroe Islands. Pop. (1901) 11,982. It is built on four small islands, by which its harbour is enclosed. The chief exports are wood, cod, herrings and fish products, and butter to Great Britain. The town is served by the principal steamers between the south Norwegian ports, Hull, Hamburg, &c., and Trondhjem, and it is the chief port of the district of Nordmøre. Local steamers serve the neighbouring fjords, including the Sundalsfjord, from which at Sundalsören a driving road past the fine Dovrefjeld connects with the Gudbrandsdal route. Till 1742, when it received town privileges from Christian VI., Christiansund was called Lille-Fosen.

CHRISTIE, RICHARD COPLEY (1830–1901), English scholar and bibliophile, was born on the 22nd of July 1830 at Lenton in Nottinghamshire, the son of a millowner. He was educated at Lincoln College, Oxford, and was called to the bar at Lincoln's Inn in 1857, and in 1872 became chancellor of the diocese of Manchester. This he resigned in 1893. He held numerous appointments, notably the professorships of history (from 1854 to 1856) and of political economy (from 1855 to 1866) at Owens College, Manchester. He always took an active interest in this college, of which he was one of the governors; in 1893 he gave the Christie library building designed by Alfred Waterhouse, and in 1897 he devoted £50,000 of the funds at his disposal as a trustee of Sir Joseph Whitworth's estate for the building of Whitworth Hall, which completed the front quadrangle of the college. He was an enthusiastic book collector, and bequeathed to Owens College his library of about 75,000 volumes, rich in a very complete set of the books printed by Dolet, a wonderful series of Aldines, and of volumes printed by Sebastian Gryphius. His *Étienne Dolet, the Martyr of the Renaissance* (1880), is the most exhaustive work on the subject. He died at Ribsden on the 9th of January 1901.

CHRISTINA (1626–1689), queen of Sweden, daughter of Gustavus Adolphus and Maria Eleonora of Brandenburg, was born at Stockholm on the 8th of December 1626. Her father died when she was only six years old. She was educated, principally, by the learned Johannes Matthiae, in as masculine a way as possible, while the great Oxenstjerna himself instructed her in politics. Christina assumed the sceptre in her eighteenth year (Dec. 8, 1644). From the moment when she took her seat at the head of the council board she impressed her veteran counsellors with the conviction of her superior genius. Axel Oxenstjerna himself said of her, when she was only fifteen: "Her majesty is not like women-folk, but is stout-hearted and of a good understanding, so that, if she be not corrupted, we have

good hopes of her." Unfortunately her brilliant and commanding qualities were vitiated by an inordinate pride and egoism, which exhibited themselves in an utter contempt for public opinion, and a prodigality utterly regardless of the necessities of the state. She seemed to consider Swedish affairs as far too petty to occupy her full attention; while her unworthy treatment of the great chancellor was mainly due to her jealousy of his extraordinary reputation and to the uneasy conviction that, so long as he was alive, his influence must at least be equal to her own. Recognizing that he would be indispensable so long as the Thirty Years' War lasted, she used every effort to bring it to an end; and her impulsive interference seriously hampered the diplomacy of the chancellor, and materially reduced the ultimate gains of Sweden. The general peace congress was not opened till April 1645. The Swedish plenipotentiaries were Johan Oxenstjerna, the chancellor's son, and Adler Salvius. From the first the relations between them were strained. Young Oxenstjerna, haughty and violent, claimed, by right of birth and rank, to be *caput legationis*. The chancellor, at home, took his son's part, while Salvius was warmly supported by Christina, who privately assured him of her exclusive favour and encouraged him to hold his own. So acute did the quarrel become that there was a violent scene in full senate between the queen and the chancellor; and she urged Salvius to accelerate the negotiations, against the better judgment of the chancellor, who hoped to get more by holding out longer.

The longer Christina ruled, the more anxious for the future fate of her empire grew the men who had helped to build it up. Yet she gave fresh privileges to the towns; she encouraged trade and manufactures, especially the mining industries of the Dales; in 1649 she issued the first school ordinance for the whole kingdom; she encouraged foreign scholars to settle in Sweden; and native science and literature, under her liberal encouragement, flourished as they had never flourished before. In one respect, too, she showed herself wiser than her wisest counsellors. The senate and the estates, naturally anxious about the succession to the throne, had repeatedly urged her majesty to marry, and had indicated her cousin, Charles Gustavus, as her most befitting consort. Wearied of their importunities, yet revolting at the idea of submission to any member of the opposite sex, Christina settled the difficulty by appointing Charles her successor, and at the *Riksdag* of 1650 the Swedish crown was declared hereditary in Charles and his heirs male. In the summer of 1651 Christina was, with difficulty, persuaded to reconsider her resolution to abdicate, but three years later the nation had become convinced that her abdication was highly desirable, and the solemn act took place on the 6th of July 1654 at the castle of Upsala, in the presence of the estates and the great dignitaries of the realm. Many were the causes which predisposed her to what was, after all, anything but an act of self-renunciation. First of all she could not fail to remark the increasing discontent with her arbitrary and wasteful ways. Within ten years she had created 17 counts, 46 barons and 428 lesser nobles; and, to provide these new peers with adequate appanages, she had sold or mortgaged crown property representing an annual income of 1,200,000 rix-dollars. Signs are also not wanting that Christina was growing weary of the cares of government; while the importunity of the senate and *Riksdag* on the question of her marriage was a constant source of irritation. In retirement she could devote herself wholly to art and science, and the opportunity of astonishing the world by the unique spectacle of a great queen, in the prime of life, voluntarily resigning her crown, strongly appealed to her vivid imagination. Anyhow, it is certain that, towards the end of her reign, she behaved as if she were determined to do everything in her power to make herself as little missed as possible. From 1651 there was a notable change in her behaviour. She cast away every regard for the feelings and prejudices of her people. She ostentatiously exhibited her contempt for the Protestant religion. Her foreign policy was flighty to the verge of foolishness. She contemplated an alliance with Spain, a state quite outside the orbit of Sweden's influence, the first fruits of which were to have been an invasion of Portugal. She utterly neglected affairs in order to plunge into a

whirl of dissipation with her foreign favourites. The situation became impossible, and it was with an intense feeling of relief that the Swedes saw her depart, in masculine attire, under the name of Count Dohna. At Innsbruck she openly joined the Catholic Church, and was rechristened Alexandra. In 1656, and again in 1657, she visited France, on the second occasion ordering the assassination of her major-domo Monaldeschi, a crime still unexplained. Twice she returned to Sweden (1660 and 1667) in the vain hope of recovering the succession, finally settling in Rome, where she died on the 19th of April 1689, poor, neglected and forgotten.

See Francis William Bain, *Queen Christina of Sweden* (London, 1890); Robert Nisbet Bain, *Scandinavia* (Cambridge, 1905); *Christina de Suède et le Cardinal Azzolino* (Paris, 1899); Claretta Gaudenzio, *La Regina Christina de Svezia in Italia* (Turin, 1892); Hans Emil Friis, *Dronning Christina* (Copenhagen, 1896); C. N. D. Bildt, *Christina de Suède et le conclave de Clément X* (Paris, 1906); *Drottning Kristinas sista dagar* (Stockholm, 1897); and J. A. Taylor, *Christina of Sweden* (1909). (R. N. B.)

CHRISTINA [MARIA CHRISTINA HENRIETTA DÉSIÉE FÉLICITÉ RÉNIÈRE], for some years queen-regent of Spain (1858–), widow of Alphonso XII. and mother of Alphonso XIII., was born at Gross Seelowitz, in Austria, on the 21st of July 1858, being the daughter of the archduke Charles Ferdinand and the archduchess Elizabeth of Austria. She was brought up by her mother as a rigid Catholic, and great care was taken with her education. At eighteen she was appointed by the emperor Francis Joseph, abess of the House of Noble Ladies of Saint Theresa in Prague, where she made herself very popular and distinguished herself by her intellectual parts. It is said that at the court of Vienna the archduchess saw the young prince Alphonso of Spain when he was only a pretender in exile, before the restoration of the Bourbons. A few years later, when Alphonso XII. had lost his first wife and cousin, Queen Mercedes, daughter of the duc de Montpensier, his ministers, especially Señor Canovas, urged him to marry again. He told them that if he did so it would only be with the young Austrian archduchess Maria Christina. After some negotiations between the two courts and governments it was agreed that the archduchess Elizabeth and her daughter should meet Alphonso XII. at Arcachon, in the south of France, where a few days' personal acquaintance was sufficient to make both come to a decision. The duke of Bailen went officially to Vienna to get the emperor of Austria's authorization, and on the 14th of November 1879, in the throne-room of the Imperial palace, the archduchess solemnly abdicated all her rights of succession in Austria, in accordance with the law obliging all princesses of the imperial house to do so when they wed a foreign prince. On the 17th of November the archduchess and her mother, with a numerous suite, started for Spain, arriving at the royal castle of El Pardo, near Madrid, on the 24th of November. The wedding took place in the Atocha cathedral, on the 29th of November, in great state, and was followed by splendid festivities. Queen Christina bore her husband two daughters before he died in 1885—Dona Mercedes, born on the 11th of September 1880, and Dona Maria Theresa, born on the 12th of November 1882. During her husband's lifetime the young queen kept studiously apart from politics, so much so that her inexperience caused much anxiety in November 1885, when she was called upon to take the arduous duties of regent. During the long minority of the posthumous son of Alphonso XII., afterwards King Alphonso XIII., the Austrian queen-regent acted in a way that obliged even the adversaries of the throne and the dynasty to respect the mother and the woman. The people of Spain, and the ever-restless civil and military politicians, found that the gloved hand of their constitutional ruler was that of a strong-minded and tenacious regent, who often asserted herself in a way that surprised them much, but always, somehow, enforced obedience and respect. More could not be expected by a foreign ruler from a nation little prone to waste attachment or demonstrative loyalty upon anybody not Castilian born and bred.

CHRISTISON, SIR ROBERT, Bart. (1797–1882), Scottish toxicologist and physician, was born in Edinburgh on the 18th of July 1797. After graduating at the university of that city in 1819, he spent a short time in London, studying under John

Abernethy and Sir William Lawrence, and in Paris, where he learnt analytical chemistry from P. J. Robiquet and toxicology from M. J. B. Orfila. In 1822 he returned to Edinburgh as professor of medical jurisprudence, and set to work to organize the study of his subject on a sound basis. On poisons in particular he speedily became a high authority; his well-known treatise on them was published in 1829, and in the course of his inquiries he did not hesitate to try such daring experiments on himself as taking large doses of Calabar bean. His attainments in medical jurisprudence and toxicology procured him the appointment, in 1829, of medical officer to the crown in Scotland, and from that time till 1866 he was called as a witness in many celebrated criminal cases. In 1832 he gave up the chair of medical jurisprudence and accepted that of medicine and therapeutics, which he held till 1877; at the same time he became professor of clinical medicine, and continued in that capacity till 1855. His fame as a toxicologist and medical jurist, together with his work on the pathology of the kidneys and on fevers, secured him a large private practice, and he succeeded to a fair share of the honours that commonly attend the successful physician, being appointed physician to Queen Victoria in 1848 and receiving a baronetcy in 1871. Among the books which he published were a treatise on *Granular Degeneration of the Kidneys* (1839), and a *Commentary on the Pharmacopoeias of Great Britain* (1842). Sir Robert Christison, who retained remarkable physical vigour and activity down to extreme old age, died at Edinburgh on the 23rd of January 1882.

See the *Life* by his sons (1885-1886).

CHRISTMAS (*i.e.* the Mass of Christ), in the Christian Church, the festival of the nativity of Jesus Christ. The history of this feast coheres so closely with that of Epiphany (*q.v.*), that what follows must be read in connexion with the article under that heading.

The earliest body of gospel tradition, represented by Mark no less than by the primitive non-Marcian document embodied in the first and third gospels, begins, not with the birth and childhood of Jesus, but with his baptism; and this order of accretion of gospel matter is faithfully reflected in the time order of the invention of feasts. The great church adopted Christmas much later than Epiphany; and before the 5th century there was no general consensus of opinion as to when it should come in the calendar, whether on the 6th of January, or the 25th of March, or the 25th of December.

The earliest identification of the 25th of December with the birthday of Christ is in a passage, otherwise unknown and probably spurious, of Theophilus of Antioch (A.D. 171-183), preserved in Latin by the Magdeburg centuriators (i. 3, 118), to the effect that the Gauls contended that as they celebrated the birth of the Lord on the 25th of December, whatever day of the week it might be, so they ought to celebrate the Pascha on the 25th of March when the resurrection befell.

The next mention of the 25th of December is in Hippolytus' (*c.* 202) commentary on Daniel iv. 23. Jesus, he says, was born at Bethlehem on the 25th of December, a Wednesday, in the forty-second year of Augustus. This passage also is almost certainly interpolated. In any case he mentions no feast, nor was such a feast congruous with the orthodox ideas of that age. As late as 245 Origen, in his eighth homily on Leviticus, repudiates as sinful the very idea of keeping the birthday of Christ "as if he were a king Pharaoh." The first certain mention of Dec. 25 is in a Latin chronographer of A.D. 354, first published entire by Mommsen.¹ It runs thus in English: "Year 1 after Christ, in the consulate of Caesar and Paulus, the Lord Jesus Christ was born on the 25th of December, a Friday and 15th day of the new moon." Here again no festal celebration of the day is attested.

There were, however, many speculations in the 2nd century about the date of Christ's birth. Clement of Alexandria, towards its close, mentions several such, and condemns them as superstitions. Some chronologists, he says, alleged the birth to have

occurred in the twenty-eighth year of Augustus, on the 25th of Pachon, the Egyptian month, *i.e.* the 20th of May. These were probably the Basilidian gnostics. Others set it on the 24th or 25th of Pharmuthi, *i.e.* the 19th or 20th of April. Clement himself sets it on the 17th of November, 3 B.C. The author of a Latin tract, called the *De Pascha computus*, written in Africa in 243, sets it by private revelation, *ab ipso deo inspirati*, on the 28th of March. He argues that the world was created perfect, flowers in bloom, and trees in leaf, therefore in spring; also at the equinox, and when the moon just created was full. Now the moon and sun were created on a Wednesday. The 28th of March suits all these considerations. Christ, therefore, being the Sun of Righteousness, was born on the 28th of March. The same symbolical reasoning led Polycarp² (before 160) to set his birth on Sunday, when the world's creation began, but his baptism on Wednesday, for it was the analogue of the sun's creation. On such grounds certain Latins as early as 354 may have transferred the human birthday from the 6th of January to the 25th of December, which was then a Mithraic feast and is by the chronographer above referred to, but in another part of his compilation, termed *Natalis invicti solis*, or birthday of the unconquered Sun. Cyprian (*de orat. dom.* 35) calls Christ *Sol verus*, Ambrose *Sol novus noster* (Sermo vii. 13), and such rhetoric was widespread. The Syrians and Armenians, who clung to the 6th of January, accused the Romans of sun-worship and idolatry, contending with great probability that the feast of the 25th of December had been invented by disciples of Cerinthus and its lections by Artemon to commemorate the *natural* birth of Jesus. Chrysostom also testifies the 25th of December to have been from the beginning known in the West, from Thrace even as far as Gades. Ambrose, *On Virgins*, iii. ch. 1, writing to his sister, implies that as late as the papacy of Liberius 352-356, the Birth from the Virgin was feasted together with the Marriage of Cana and the Banquet of the 4000 (Luke ix. 13), which were never feasted on any other day but Jan. 6.

Chrysostom, in a sermon preached at Antioch on Dec. 20, 386 or 388, says that some held the feast of Dec. 25 to have been held in the West, from Thrace as far as Cadiz, from the beginning. It certainly originated in the West, but spread quickly eastwards. In 353-361 it was observed at the court of Constantius. Basil of Caesarea (died 379) adopted it. Honorius, emperor (395-423) in the West, informed his mother and brother Arcadius (395-408) in Byzantium of how the new feast was kept in Rome, separate from the 6th of January, with its own *troparia* and *sticharia*. They adopted it, and recommended it to Chrysostom, who had long been in favour of it. Epiphanius of Crete was won over to it, as were also the other three patriarchs, Theophilus of Alexandria, John of Jerusalem, Flavian of Antioch. This was under Pope Anastasius, 398-400. John or Wahan of Nice, in a letter printed by Combefis in his *Historia monothelitarum*, affords the above details. The new feast was communicated by Proclus, patriarch of Constantinople (434-446), to Sahak, Catholicos of Armenia, about 440. The letter was betrayed to the Persian king, who accused Sahak of Greek intrigues, and deposed him. However, the Armenians, at least those within the Byzantine pale, adopted it for about thirty years, but finally abandoned it together with the decrees of Chalcedon early in the 8th century. Many writers of the period 375-450, *e.g.* Epiphanius, Cassian, Asterius, Basil, Chrysostom and Jerome, contrast the new feast with that of the Baptism as that of the birth *after the flesh*, from which we infer that the latter was generally regarded as a birth according to the Spirit. Instructive as showing that the new feast travelled from West eastwards is the fact (noticed by Usener) that in 387 the new feast was reckoned according to the Julian calendar by writers of the province of Asia, who in referring to other feasts use the reckoning of their local calendars. As early as 400 in Rome an imperial rescript includes Christmas among the three feasts (the others are Easter and Epiphany) on which theatres must be closed. Epiphany and Christmas were not made judicial *non dies* until 534.

¹ In the *Abhandlungen der sächsischen Akademie der Wissenschaften* (1850). Note that in A.D. 1, Dec. 25 was a Sunday and not a Friday.

² In a fragment preserved by an Armenian writer, Ananias of Shirak.

For some years in the West (as late as 353 in Rome) the birth feast was appended to the baptismal feast on the 6th of January, and in Jerusalem it altogether supplanted it from about 360 to 440, when Bishop Juvenal introduced the feast of the 25th of December. The new feast was about the same time (440) finally established in Alexandria. The *quadragesima* of Epiphany (i.e. the feast of the presentation in the Temple, or *kupapantē*) continued to be celebrated in Jerusalem on the 14th of February, forty days after the 6th of January, until the reign of Justinian. In most other places it had long before been put back to the 2nd of February to suit the new Christmas. Armenian historians describe the riots, and display of armed force, without which Justinian was not able in Jerusalem to transfer this feast from the 14th to the 2nd of February.

The grounds on which the Church introduced so late as 350-440 a Christmas feast till then unknown, or, if known, precariously linked with the baptism, seem in the main to have been the following. (1) The transition from adult to infant baptism was proceeding rapidly in the East, and in the West was well-nigh completed. Its natural complement was a festal recognition of the fact that the divine element was present in Christ from the first, and was no new stage of spiritual promotion coeval only with the descent of the Spirit upon him at baptism. The general adoption of child baptism helped to extinguish the old view that the divine life in Jesus dated from his baptism, a view which led the Epiphany feast to be regarded as that of Jesus' spiritual rebirth. This aspect of the feast was therefore forgotten, and its importance in every way diminished by the new and rival feast of Christmas. (2) The 4th century witnessed a rapid diffusion of Marcionite, or, as it was now called, Manichaean propaganda, the chief tenet of which was that Jesus either was not born at all, was a mere phantasm, or anyhow did not take flesh of the Virgin Mary. Against this view the new Christmas was a protest, since it was peculiarly the feast of his birth in the flesh, or as a man, and is constantly spoken of as such by the fathers who witnessed its institution.

In Britain the 25th of December was a festival long before the conversion to Christianity, for Bede (*De temp. rat.* ch. 13) relates that "the ancient peoples of the Angli began the year on the 25th of December when we now celebrate the birthday of the Lord; and the very night which is now so holy to us, they called in their tongue *modranecht* (*mōdra niht*), that is, the mothers' night, by reason we suspect of the ceremonies which in that night-long vigil they performed." With his usual reticence about matters pagan or not orthodox, Bede abstains from recording who the mothers were and what the ceremonies. In 1644 the English puritans forbade any merriment or religious services by act of Parliament, on the ground that it was a heathen festival, and ordered it to be kept as a fast. Charles II. revived the feast, but the Scots adhered to the Puritan view.

Outside Teutonic countries Christmas presents are unknown. Their place is taken in Latin countries by the *strenae*, French *étrennes*, given on the 1st of January; this was in antiquity a great holiday, wherefore until late in the 4th century the Christians kept it as a day of fasting and gloom. The setting up in Latin churches of a Christmas *crèche* is said to have been originated by St Francis.

AUTHORITIES.—K. A. H. Kellner, *Heortologie* (Freiburg im Br., 1906), with Bibliography; Hospinianus, *De festis Christianorumum* (Genevae, 1574); Edw. Martène, *De Antiquis Ecclesiae Ritibus*, iii. 31 (Bassani, 1788); J. C. W. Augusti, *Christl. Archæologie*, vols. i. and v. (Leipzig, 1817-1831); A. J. Binterim, *Denkwürdigkeiten*, v. pt. i. p. 528 (Mainz, 1825, &c.); Ernst Friedrich Wernsdorf, *De originibus Solemnium Natalis Christi* (Wittenberg, 1757, and in J. E. Volbeding, *Thesaurus Commentationum*, Lipsiae, 1847); Anton. Bynaeus, *De Natali Jesu Christi* (Amsterdam, 1689); Hermann Usener, *Religionsgeschichtliche Untersuchungen* (Bonn, 1889); Nik. Nilles, S.J., *Kalendarium Manuale* (Innsbruck, 1896); L. Duchesne, *Origines du culte chrétien* (3^e éd., Paris, 1889). (F. C. C.)

CHRISTMAS ISLAND, a British possession under the government of the Straits Settlements, situated in the eastern part of the Indian Ocean (in 10° 25' S., 105° 42' E.), about 190 m. S. of Java. The island is a quadrilateral with hollowed sides, about 12 m. in greatest length and 9 in extreme breadth. It

is probably the only tropical island that had never been inhabited by man before the European settlement. When the first settlers arrived, in 1897, it was covered with a dense forest of great trees and luxuriant under-shrubbery. The settlement in Flying Fish Cove now numbers some 250 inhabitants, consisting of Europeans, Sikhs, Malays and Chinese, by whom roads have been cut and patches of cleared ground cultivated.

The island is the flat summit of a submarine mountain more than 15,000 ft high, the depth of the platform from which it rises being about 14,000 ft, and its height above the sea being upwards of 1000 ft. The submarine slopes are steep, and within 20 m of the shore the depth of the sea reaches 2400 fathoms. It consists of a central plateau descending to the water in three terraces, each with its "tread" and "rise." The shore terrace descends by a steep cliff to the sea, forming the "rise" of a submarine "tread" in the form of fringing reef which surrounds the island and is never uncovered, even at low water, except in Flying Fish Cove, where the only landing-place exists. The central plateau is a plain whose surface presents "rounded, flat-topped hills and low ridges and reefs of limestone," with narrow intervening valleys. On its northern aspect this plateau has a raised rim having all the appearances of being once the margin of an atoll. On these rounded hills occurs the deposit of phosphate of lime which gives the island its commercial value. The phosphatic deposit has doubtless been produced by the long-continued action of a thick bed of sea-fowl dung, which converted the carbonate of the underlying limestone into phosphate. The flat summit is formed by a succession of limestones—all deposited in shallow water—from the Eocene (or Oligocene) up to recent deposits in the above-mentioned atoll with islands on its reef. The geological sequence of events appears to have been the following:—After the deposition of the Eocene (or Oligocene) limestone—which reposes upon a floor of basalts and trachytes—basalts and basic tuffs were ejected, over which, during a period of very slow depression, orbitoidal limestones of Miocene age—which seem to make up the great mass of the island—were deposited; then elapsed a long period of rest, during which the atoll condition existed and the guano deposit was formed; from then down to the present time there has succeeded a series of sea-level subsidences, resulting in the formation of the terraces and the accumulation of the detritus now seen on the first inland cliff, the old submarine slope of the island. The occurrence of such a series of Tertiary deposits appears to be unknown elsewhere. The whole series was evidently deposited in shallow water on the summit of a submarine volcano standing in its present isolation, and round which the ocean floor has probably altered but a few hundred feet since the Eocene age. Thus although the rocks of the southern coast of Java in their general character and succession resemble those of Christmas Island, there lies between them an abysmal trough 18,000 ft. in depth, which renders it scarcely possible that they were deposited in a continuous area, for such an enormous depression of the sea-floor could hardly have occurred since Miocene times without involving also Christmas Island. One of the main purposes of the exploration was to obtain light on the question of the foundation of atolls.

The flora consists of 129 species of angiosperms; 1 *Cycas*, 22 ferns, and a few mosses, lichens and fungi, 17 of which are endemic, while a considerable number—not specifically distinct—form local varieties nearly all presenting Indo-Malayan affinities, as do the single *Cycas*, the ferns and the cryptogams. As to its fauna, the island contains 319 species of animals—54 only being vertebrates—145 of which are endemic. A very remarkable distributional fact in regard to them, and one not yet fully explained, is that a large number show affinity with species in the Austro-Malayan rather than in the Indo-Malayan, their nearer region. The ocean currents, the trade-winds blowing from the Australian mainland, and north-westerly storms from the Malayan islands, are no doubt responsible for the introduction of many, but not all, of these Malayan and Australasian species. The climate is healthy, the temperature varying from 75° to 84° F. The prevailing wind is the S.E. trade, which

blows the greater part of the year. The rainfall in the wet season is heavy, but not excessive, and during the dry season the ground is refreshed with occasional showers and heavy dews. Malarial fever is not prevalent, and it is interesting to note that there are no swamps or standing waters on the island.

It is not known when and by whom the island was discovered, but under the name of *Moni* it appears on a Dutch chart of 1666. It was first visited in 1688 by Dampier, who found it uninhabited. In 1886 Captain Maclear of H.M.S. "Flying Fish," having discovered an anchorage in a bay which he named Flying Fish Cove, landed a party and made a small but interesting collection of the flora and fauna. In the following year Captain Aldrich on H.M.S. "Egeria" visited it, accompanied by Mr J. J. Lister, F.R.S., who formed a larger biological and mineralogical collection. Among the rocks then obtained and submitted to Sir John Murray for examination there were detected specimens of nearly pure phosphate of lime, a discovery which eventually led, in June 1888, to the annexation of the island to the British crown. Soon afterwards a small settlement was established in Flying Fish Cove by Mr G. Clunies Ross, the owner of the Keeling Islands, which lie about 750 m. to the westward. In 1891 Mr Ross and Sir John Murray were granted a lease, but on the further discovery of phosphatic deposits they disposed of their rights in 1897 to a company. In the same year a thorough scientific exploration was made, at the cost of Sir John Murray, by Mr C. W. Andrews, of the British Museum.

See C. W. Andrews, *A Monograph of Christmas Island (Indian Ocean)*, (London, 1900).

CHRISTODORUS, of Coptos in Egypt, epic poet, flourished during the reign of Anastasius I. (A.D. 491-518). According to Suidas, he was the author of *Ἰάρπια*, accounts of the foundation of various cities; *Λυδίακὰ*, the mythical history of Lydia; *Ἰσαυρικά*, the conquest of Isauria by Anastasius; three books of epigrams; and many other works. In addition to two epigrams (*Anthol. Pal.* vii. 697, 698) we possess a description of eighty statues of gods, heroes and famous men and women in the gymnasium of Zeuxippus at Constantinople. This *ἐκφρασις*, consisting of 416 hexameters, forms the second book of the Palatine Anthology. The writer's chief models are Homer and Nonnus, whom he follows closely in the structure of his hexameters. Opinions are divided as to the merits of the work. Some critics regard it as of great importance for the history of art and a model of description; others consider it valueless, alike from the historical, mythological and archaeological points of view.

See F. Baumgarten, *De Christodoro poeta Thebano* (1881), and his article in Pauly-Wissowa's *Realencyclopädie*, iii. 2 (1899); W. Christ, *Geschichte der griechischen Litteratur* (1898).

CHRISTOPHER, SAINT (*Christophorus, Christoferus*), a saint honoured in the Roman Catholic (25th of July) and Orthodox Eastern (9th of May) Churches, the patron of ferrymen. Nothing that is authentic is known about him. He appears to have been originally a pagan and to have been born in Syria. He was baptized by Babylas, bishop of Antioch; preached with much success in Lycia; and was martyred about A.D. 250 during the persecution under the emperor Decius.¹ Round this small nucleus of possibility, however, a vast mass of legendary matter gradually collected. All accounts agree that he was of great stature and singularly handsome, and that this helped him not a little in his evangelistic work. But according to a story reproduced in the *New Unial Anthology* of Arcudius, and mentioned in Basil's *Monologue*, Christopher was originally a hideous man-eating ogre, with a dog's face, and only received his human semblance, with his Christian name, at baptism. Most of his astounding miracles are of the ordinary type. He thrusts his staff into the ground; whereupon it sprouts into a date palm, and thousands are converted. Courtesans sent to seduce him are turned by his mere aspect into Christians and martyrs. The Roman governor is confounded by his insensi-

¹ Or Dagnus—perhaps to be identified with Maximinus Daza, joint emperor (with Galerius) in the East 305-311, and sole emperor 311-313.

bility to the most refined and ingenious tortures. He is roasted over a slow fire and basted with boiling oil, but tells his tormentors that by the grace of Jesus Christ he feels nothing. When at last, in despair, they cut off his head, he had converted 48,000 people.

The more conspicuous of these legends are included in the Mozarabic *Breviary* and *Missal*, and are given in the thirty-third sermon of Peter Damien, but the best-known story is that which is given in the *Golden Legend* of Jacopus de Voragine. According to this, Christopher—or rather Reprobis, as he was then called—was a giant of vast stature who was in search of a man stronger than himself, whom he might serve. He left the service of the king of Canaan because the king feared the devil, and that of the devil because the devil feared the Cross. He was converted by a hermit; but as he had neither the gift of fasting nor that of prayer, he decided to devote himself to a work of charity, and set himself to carry wayfarers over a bridgeless river. One day a little child asked to be taken across, and Christopher took him on his shoulder. When half way over the stream he staggered under what seemed to him a crushing weight, but he reached the other side and then upbraided the child for placing him in peril. "Had I borne the whole world on my back," he said, "it could not have weighed heavier than thou!" "Marvel not!" the child replied, "for thou hast borne upon thy back the world and him who created it!" It was this story that gave Christopher his immense popularity throughout Western Christendom.

See Bolland, *Acta Sanct.* vi. 146; Guenebault, *Dict. iconographique des attributs des figures et des légendes des saints* (Paris, 1850); Smith and Wace, *Dict. of Christ. Biog.* (London, 1877, &c., 4 vols.); A. Sinemus, *Die Legende vom h. Christophorus* (Hanover, 1868); and other literature cited in Herzog-Hauck, *Realencyk.* iv. 60.

CHRISTOPHORUS, pope or anti-pope, elected in 903 against Leo V., whom he threw into prison. In January 904 he was treated in the same fashion by his competitor, Sergius III., who had him strangled.

CHRISTOPOULOS, ATHANASIOS (1772-1847), Greek poet, was born at Castoria in Macedonia. He studied at Buda and Padua, and became teacher of the children of the Vlach prince Mourousi. After the fall of that prince in 1811, Christopoulos was employed by Prince Caradja, who had been appointed hospodar of Moldavia and Walachia, in drawing up a code of laws for that country. On the removal of Caradja, he retired into private life and devoted himself to literature. He wrote drinking songs and love ditties which are very popular among the Greeks. He is also the author of a tragedy, of *Politika Parallela* (a comparison of various systems of government), of translations of Homer and Herodotus, and of some philological works on the connexion between ancient and modern Greek.

His *Hellenika Archaialogemata* (Athens, 1853) contains an account of his life.

CHRIST'S HOSPITAL (the "Blue-coat School"), a famous English educational and charitable foundation. It was originally one of three royal hospitals in the city of London, founded by Edward VI., who is said to have been inspired by a sermon of Bishop Ridley on charity. Christ's hospital was specially devoted to fatherless and motherless children. The buildings of the monastery of Grey Friars, Newgate Street, were appropriated to it; liberal public subscription added to the king's grant endowed it richly; and the mayor, commonalty and citizens of London were nominated its governors in its charter of 1553. At first Christ's hospital shared a common fund with the two other hospitals of the foundation (Bridewell and St Thomas's), but the three soon became independent. Not long after its opening Christ's was providing home and education (or, in the case of the very young, nursing) for 400 children. The popular name of the Blue-coat school is derived from the dress of the boys—originally (almost from the time of the foundation) a blue gown, with knee-breeches, yellow petticoat and stockings, neck-bands and a blue cap. The petticoat and cap were given up in the middle of the 19th century, and thereafter no head-covering was worn. The buildings on the Newgate Street site underwent reconstruction from time to time, and in 1902 were vacated by

the school, which was moved to extensive new buildings at Horsham. The London buildings were subsequently taken down. The school at Horsham is conducted on the ordinary lines of a public school, and can accommodate over 800 boys. It includes a preparatory school for boys, established in 1683 at Hertford, where the buildings have been greatly enlarged for the use of the girls' school on the same foundation. This was originally in Newgate Street, but was moved to Hertford in 1778. In the boys' school the two highest classes retain their ancient names of Grecians and Deputy Grecians. Children were formerly admitted to the schools only on presentation. Admission is now (1) by presentation of donation governors (*i.e.* the royal family, and contributors of £500 or more to the funds), of the council of almoners (which administers the endowments), or of certain of the city companies; (2) by competition, on the nomination of a donation governor (for boys only), or from public elementary schools in London, certain city parishes and certain endowed schools elsewhere. The main school is divided into two parts—the Latin school, corresponding to the classical side in other schools, and the mathematical school or modern side. Large pension charities are administered by the governing body, and part of the income of the hospital (about £60,000 annually) is devoted to apprenticing boys and girls, to leaving exhibitions from the school, &c.

CHRISTY, HENRY (1810–1865), English ethnologist, was born at Kingston-on-Thames on the 26th of July 1810. He entered his father's firm of hatters, in London, and later became a director of the London Joint-Stock Bank. In 1850 he started on a series of journeys, which interested him in ethnological studies. Encouraged by what he saw at the Great Exhibition of 1851, Christy devoted the rest of his life to perpetual travel and research, making extensive collections illustrating the early history of man, now in the British Museum. He travelled in Norway, Sweden, Denmark, Mexico, British Columbia and other countries; but in 1858 came the opportunity which brought him fame. It was in that year that the discoveries by Boucher de Perthes of flint-implements in France and England were first held to have clearly proved the great antiquity of man. Christy joined the Geological Society, and in company with his friend Edouard Lartet explored the caves in the valley of the Vézère, a tributary of the Dordogne in the south of France. To his task Christy devoted money and time ungrudgingly, and an account of the explorations appeared in *Comptes rendus* (Feb. 29th, 1864) and *Transactions of the Ethnological Society of London* (June 21st, 1864). He died, however, on the 4th of May 1865, of inflammation of the lungs supervening on a severe cold contracted during excavation work at La Palisse, leaving a half-finished book, entitled *Reliquiæ Aquitanicæ, being contributions to the Archaeology and Palæontology of Perigord and the adjacent provinces of Southern France*; this was issued in parts and completed at the expense of Christy's executors, first by Lartet and, after his death in 1870, by Professor Rupert Jones. By his will Christy bequeathed his magnificent archaeological collection to the nation. In 1884 it found a home in the British Museum. Christy took an earnest part in many philanthropic movements of his time, especially identifying himself with the efforts to relieve the sufferers from the Irish famine of 1847.

CHROMATIC (Gr. *χρωματικός*, coloured, from *χρῶμα*, colour), a term meaning "coloured," chiefly used in science, particularly in the expression "chromatic aberration" or "dispersion" (see **ABERRATION**). In Greek music *χρωματική μουσική* was one of three divisions—diatonic, chromatic and enharmonic—of the tetrachord. Like the Latin *color*, *χρῶμα* was often used of ornaments and embellishments, and particularly of the modification of the three *genera* of the tetrachord. The chromatic, being subject to three such modifications, was regarded as particularly "coloured." To the Greeks chromatic music was sweet and plaintive. From a supposed resemblance to the notes of the chromatic tetrachord, the term is applied to a succession of notes outside the diatonic scale, and marked by accidentals. A "chromatic scale" is thus a series of semi-tones, and is commonly written with sharps in ascending and flats descending. The most

correct method is to write such accidentals as do not involve a change of key.

CHROMITE, a member of the spinel group of minerals; an oxide of chromium and ferrous iron, FeCr_2O_4 . It is also known as chromic iron or as chrome-iron-ore, and is the chief commercial source of chromium and its compounds. It crystallizes in regular octahedra, but is usually found as grains or as granular to compact masses. In its iron-black colour with submetallic lustre and absence of cleavage it resembles magnetite (magnetic iron-ore) in appearance, but differs from this in being only slightly if at all magnetic and in the brown colour of its powder. The hardness is $5\frac{1}{2}$; specific gravity 4.5. The theoretical formula FeCr_2O_4 corresponds with chromic oxide (Cr_2O_3) 68%, and ferrous oxide 32%; the ferrous oxide is, however, usually partly replaced by magnesia, and the chromic oxide by alumina and ferric oxide, so that there may be a gradual passage to picotite or chromespinel. Much of the material mined as ore does not contain more than 40 to 50% of chromic oxide. In the form of isolated grains the mineral is a characteristic constituent of ultrabasic igneous rocks, namely the peridotites and the serpentines which have resulted from their alteration. It is also found under similar conditions in meteoric stones and irons. Often these rocks enclose large segregated masses of granular chromite. The earliest worked deposits were those in the serpentine of the Bare Hills near Baltimore, Maryland, U.S.A.; it was also formerly extensively mined in Lancaster county, Pennsylvania, and is now mined in California, as well as in Turkey, the Urals, Dun Mountain near Nelson in New Zealand, and Unst in the Shetlands.

Chrome-iron-ore is largely used in the preparation of chromium compounds for use as pigments (chrome-yellow, &c.) and in calico-printing; it is also used in the manufacture of chrome-steel. (L. J. S.)

CHROMIUM (symbol Cr. atomic weight 52.1), one of the metallic chemical elements, the name being derived from the fine colour (Gr. *χρῶμα*) of its compounds. It is a member of the sixth group in the periodic classification of the elements, being included in the natural family of elements containing molybdenum, tungsten and uranium. The element is not found in the free state in nature, nor to any large extent in combination, occurring chiefly as chrome-ironstone, $\text{Cr}_2\text{O}_3 \cdot \text{FeO}$, and occasionally being found as crocoisite, PbCrO_4 , chrome-ochre, Cr_2O_3 , and chrome-garnet, $\text{CaO} \cdot \text{Cr}_2\text{O}_3 \cdot 3\text{SiO}_2$, while it is also the cause of the colour in serpentine, chrome-mica and the emerald. It was first investigated in 1789 by L. N. Vauquelin and Macquart, and in 1797 by Vauquelin, who found that the lead in crocoisite was in combination with an acid, which he recognized as the oxide of a new metal.

The metal can be obtained by various processes. Thus Sainte Claire Deville prepared it as a very hard substance of steel-grey colour, capable of taking a high polish, by strong ignition of chromic oxide and sugar charcoal in a lime crucible. F. Wöhler reduced the sesquioxide by zinc, and obtained a shining green powder of specific gravity 6.81, which tarnished in air and dissolved in hydrochloric acid and warm dilute sulphuric acid, but was unacted upon by concentrated nitric acid. H. Moissan (*Comptes rendus*, 1893, 116, p. 349; 1894, 119, p. 185) reduces the sesquioxide with carbon, in an electric furnace; the product so obtained (which contains carbon) is then strongly heated with lime, whereby most of the carbon is removed as calcium carbide, and the remainder by heating the purified product in a crucible lined with the double oxide of calcium and chromium. An easier process is that of H. Goldschmidt (*Annalen*, 1898, 301, p. 19) in which the oxide is reduced by metallic aluminium; and if care is taken to have excess of the sesquioxide of chromium present, the metal is obtained quite free from aluminium. The metal as obtained in this process is lustrous and takes a polish, does not melt in the oxyhydrogen flame, but liquefies in the electric arc, and is not affected by air at ordinary temperatures. Chromium as prepared by the Goldschmidt process is in a passive condition as regards dilute sulphuric acid and dilute hydrochloric acid at ordinary temperatures; but by heating the metal with the acid it passes into the active condition, the same effect being produced by heating the inactive form with a solution of an alkaline halide.

W. Hittorf thinks that two allotropic forms of chromium exist (*Zeit. für phys. Chem.*, 1898, 25, p. 729; 1899, 30, p. 481; 1900, 34, p. 385), namely active and inactive chromium; while W. Ostwald (*ibid.*, 1900, 35, pp. 33, 204) has observed that on dissolving chromium in dilute acids, the rate of solution as measured by the evolution of gas is not continuous but periodic. It is largely made as ferro-chrome, an alloy containing about 60-70% of chromium, by reducing chromite in the electric furnace or by aluminium.

Chromium and its salts may be detected by the fact that they give a deep green bead when heated with borax, or that on fusion with sodium carbonate and nitre, a yellow mass of an alkaline chromate is obtained, which, on solution in water and acidification with acetic acid, gives a bright yellow precipitate on the addition of soluble lead salts. Sodium and potassium hydroxide solutions precipitate green chromium hydroxide from solutions of chromic salts; the precipitate is soluble in excess of the cold alkali, but is completely thrown down on boiling the solution. Chromic acid and its salts, the chromates and bichromates, can be detected by the violet coloration which they give on addition of hydrogen peroxide to their dilute acid solution, or by the fact that on distillation with concentrated sulphuric acid and an alkaline chloride, the red vapours of chromium oxychloride are produced. The yellow colour of normal chromates changes to red on the addition of an acid, but goes back again to yellow on making the solution alkaline. Normal chromates on the addition of silver nitrate give a red precipitate of silver chromate, easily soluble in ammonia, and with barium chloride a yellow precipitate of barium chromate, insoluble in acetic acid. Reducing agents, such as sulphurous acid and sulphuretted hydrogen, convert the chromates into chromic salts. Chromium in the form of its salts may be estimated quantitatively by precipitation from boiling solutions with a slight excess of ammonia, and boiling until the free ammonia is nearly all expelled. The precipitate obtained is filtered, well washed with hot water, dried and then ignited until the weight is constant. In the form of a chromate, it may be determined by precipitation, in acetic acid solution, with lead acetate; the lead chromate precipitate collected on a tared filter paper, well washed, dried at 100° C. and weighed; or the chromate may be reduced by means of sulphur dioxide to the condition of a chromic salt, the excess of sulphur dioxide expelled by boiling, and the estimation carried out as above.

The atomic weight of chromium has been determined by S. G. Rawson, by the conversion of pure ammonium bichromate into the trioxide (*Journal of Chem. Soc.*, 1899, 55, p. 213), the mean value obtained being 52.06; and also by C. Meinecke, who estimated the amount of silver, chromium and oxygen in silver chromate, the amount of oxygen in potassium bichromate, and the amount of oxygen and chromium in ammonium bichromate (*Ann.*, 1891, 261, p. 339), the mean value obtained being 51.99.

Chromium forms three series of compounds, namely the chromous salts corresponding to CrO, chromous oxide, chromic salts, corresponding to Cr₂O₃, chromium sesquioxide, and the chromates corresponding to CrO₃, chromium trioxide or chromic anhydride. Chromium sesquioxide is a basic oxide, although like alumina it acts as an acid-forming oxide towards strong bases, forming salts called chromites. Various other oxides of chromium, intermediate in composition between the sesquioxide and trioxide, have been described, namely chromium dioxide, Cr₂O₃·CrO₃, and the oxide CrO₂·2Cr₂O₃.

Chromous oxide, CrO, is unknown in the free state, but in the hydrated condition as CrO·H₂O or Cr(OH)₂ it may be prepared by precipitating chromous chloride by a solution of potassium hydroxide in air-free water. The precipitate so obtained is a brown amorphous solid which readily oxidizes on exposure, and is decomposed by heat with liberation of hydrogen and formation of the sesquioxide. The sesquioxide, Cr₂O₃, occurs native, and can be artificially obtained in several different ways, e.g., by igniting the corresponding hydroxide, or chromium trioxide, or ammonium bichromate, or by passing the vapours of chromium oxychloride through a red-hot tube, or by ignition of mercurous chromate. In the amorphous state it is a dull green, almost infusible powder, but as obtained from chromium oxychloride it is deposited in the form of dark green hexagonal crystals of specific gravity 5.2. After ignition it becomes almost insoluble in acids, and on fusion with silicates it colours them green; consequently it is used as a pigment for colouring glass

and china. By the fusion of potassium bichromate with boric acid, and extraction of the melt with water, a residue is left which possesses a fine green colour, and is used as a pigment under the name of Guignet's green. In composition it approximates to Cr₂O₃·H₂O, but it always contains more or less boron trioxide. Several forms of hydrated chromium sesquioxide are known; thus on precipitation of a chromic salt, free from alkali, by ammonia, a light blue precipitate is formed, which after drying over sulphuric acid, has the composition Cr₂O₃·7H₂O, and this after being heated to 200° C. in a current of hydrogen leaves a residue of composition CrO·OH or Cr₂O₃·H₂O which occurs naturally as chrome ochre. Other hydrated oxides such as Cr₂O₃·2H₂O have also been described. Chromium trioxide, CrO₃, is obtained by adding concentrated sulphuric acid to a cold saturated solution of potassium bichromate, when it separates in long red needles; the mother liquor is drained off and the crystals are washed with concentrated nitric acid, the excess of which is removed by means of a current of dry air. It is readily soluble in water, melts at 193° C., and is decomposed at a higher temperature into chromium sesquioxide and oxygen; it is a very powerful oxidizing agent, acting violently on alcohol, converting it into acetaldehyde, and in glacial acetic acid solution converting naphthalene and anthracene into the corresponding quinones. Heated with concentrated hydrochloric acid it liberates chlorine, and with sulphuric acid it liberates oxygen. Gaseous ammonia passed over the oxide reduces it to the sesquioxide with formation of nitrogen and water. Dissolved in hydrochloric acid at -20°, it yields with solutions of the alkaline chlorides compounds of the type MCl·CrOCl₂, pointing to pentavalent chromium. For salts of this acid-forming oxide and for perchromic acid see BICHROMATES.

The chromites may be looked upon as salts of chromium sesquioxide with other basic oxides, the most important being chromite (*q.v.*).

Chromous chloride, CrCl₂, is prepared by reducing chromic chloride in hydrogen; it forms white silky needles, which dissolve in water giving a deep blue solution, which rapidly absorbs oxygen, forming basic chromic salts, and acts as a very strong reducing agent. The bromide and iodide are formed in a similar manner by heating the metal in gaseous hydrobromic or hydriodic acids.

Chromous sulphate, CrSO₄·7H₂O, isomorphous with ferrous sulphate, results on dissolving the metal in dilute sulphuric acid or, better, by dissolving chromous acetate in dilute sulphuric acid, when it separates in blue crystals on cooling the solution. On pouring a solution of chromous chloride into a saturated solution of sodium acetate, a red crystalline precipitate of chromous acetate is produced; this is much more permanent in air than the other chromous salts and consequently can be used for their preparation. Chromic salts are of a blue or violet colour, and apparently the chloride and bromide exist in a green and violet form.

Chromic chloride, CrCl₃, is obtained in the anhydrous form by igniting a mixture of the sesquioxide and carbon in a current of dry chlorine; it forms violet laminae almost insoluble in water, but dissolves rapidly in presence of a trace of chromous chloride; this action has been regarded as a catalytic action, it being assumed that the insoluble chromic chloride is first reduced by the chromous chloride to the chromous condition and the original chromous chloride converted into soluble chromic chloride, the newly formed chromous chloride then reacting with the insoluble chromic chloride. Solutions of chromic chloride in presence of excess of acid are green in colour. According to A. Werner, four hydrated chromium chlorides exist, namely the green and violet salts, CrCl₃·6H₂O a hydrate, CrCl₃·10H₂O and one CrCl₃·4H₂O. The violet form gives a purple solution, and all its chlorine is precipitated by silver nitrate; the aqueous solution containing four ions, probably Cr(OH)₂⁺ and three chlorine ions. The green salt appears to dissociate in aqueous solution into two ions, namely CrCl₂(OH)₂⁺ and one chlorine ion, since practically only one-third of the chlorine is precipitated by silver nitrate solution at 0° C. Two of the six water molecules are easily removed in a desiccator, and the salt formed, CrCl₂·4H₂O, resembles the original salt in properties, only one-third of the chlorine being precipitated by silver nitrate. In accordance with his theory of the constitution of salts Werner formulates the hexahydrate as CrCl₂(OH)₂·4Cl·2H₂O.

Chromic bromide, CrBr₃, is prepared in the anhydrous form by the same method as the chloride, and resembles it in its properties. The iodide is unknown.

The fluoride, CrF₃, results on passing hydrofluoric acid over the heated chloride, and sublimes in needles. The hydrated fluoride, CrF₃·9H₂O, obtained by adding ammonium fluoride to cold chromic sulphate solution, is sparingly soluble in water, and is decomposed by heat.

Oxyhalogen derivatives of chromium are known, the oxychloride, CrO₂Cl₂, resulting on heating potassium bichromate and common salt with concentrated sulphuric acid. It distils over as a dark red liquid of boiling point 117° C., and is to be regarded as the acid chloride corresponding to chromic acid, CrO₂(OH)₂. It dissolves iodine and absorbs chlorine, and is decomposed by water with formation of chromic and hydrochloric acids; it takes fire in contact with sulphur, ammonia, alcohol, &c., and explodes in contact with phosphorus; it also acts as a powerful oxidizing agent. Heated in a closed tube at 180° C. it loses chlorine and leaves a black residue of trichromyl chloride, Cr₂O₃Cl₂, which deliquesces on exposure to air.

In the 13th and 14th centuries the number of chronicles written in the vulgar tongue continued to increase, at least in continental Europe, which far outpaced England in this respect. From the 15th century, with the revived study of Greek and Roman literature, the traditional form of chronicles, as well as of annals, tended to disappear and to be replaced by another and more scientific form, based on the models of antiquity—that of the historical composition combining skilful arrangement with elegance of literary style. The transition, however, was very gradual, and it was not until the 17th century that the traditional form became practically extinct.

See E. Bernheim, *Lehrbuch der historischen Methode* (4th ed., 1903); H. Bloch, "Geschichte der deutschen Geschichtsschreibung im Mittelalter" in the *Handbuch* of G. von Below and F. Meinecke (Munich, 1903 seq.); Max Jansen, "Historiographie und Quellen der deutschen Geschichte bis 1500," in Alois Meister's *Grundris* (Leipzig, 1906); and the Introduction (1904) to A. Molinier's *Les Sources de l'histoire de France*. (C. B.)*

CHRONICLES, BOOKS OF, two Old Testament books of the Bible. The name is derived from *Chronicon*, first suggested by Jerome as a rendering of the title which they bear in the Hebrew Canon, viz. *Events of the Times*. The full Hebrew title would be *Book of Events of the Times*, and this again appears to have been a designation commonly applied to special histories in the more definite shape—*Events of the Times of King David*, or the like (1 Chron. xxvii. 24; Esth. x. 2, &c.). The Greek translators divided the long book into two, and adopted the title *Παραλειπούμενα*, *Things omitted* [scil. in the other historical books].

The book of Chronicles begins with Adam and ends abruptly in the middle of Cyrus's decree of restoration, which reappears complete at the beginning of Ezra. A closer examination of those parts of *Ezra* and *Nehemiah* which are not extracted from earlier documents or original memoirs leads to the conclusion that *Chronicles-Ezra-Nehemiah* was originally one work, displaying throughout the peculiarities of language and thought of a single editor, who, however, cannot be Ezra himself as tradition would have it. Thus the fragmentary close of 2 Chronicles marks the disruption of a previously-existing continuity,—due, presumably, to the fact that in the gradual compilation of the Canon the necessity for incorporating in the Holy Writings an account of the establishment of the post-Exile theocracy was felt, before it was thought desirable to supplement *Samuel* and *Kings* by adding a second history of the period before the Exile. Hence *Chronicles* is the last book of the Hebrew Bible, following the book of *Ezra-Nehemiah*, which properly is nothing else than the sequel of *Chronicles*.

Of the authorship of *Chronicles* we know only what can be determined by internal evidence. The style of the language, and also the position of the book in the Jewish Canon, stamp the book as one of the latest in the Old Testament, but lead to no exact determination of the date.¹ In 1 Chron. xxix. 7, which refers to the time of David, a sum of money is reckoned by *darics*, which certainly implies that the author wrote after this Persian coin had been long current in Judaea. In 1 Chron. iii. 19 sqq. the descendants of Zerubbabel seem to be reckoned to six generations (the Septuagint reads it so as to give as many as eleven generations), and this agrees with the suggestion that Hattush (verse 22), who belongs to the fourth generation from Zerubbabel, was a contemporary of Ezra (Ezra viii. 2). Thus the compiler lived at least two generations after Ezra. With this it accords that in *Nehemiah* five generations of high priests are enumerated from Joshua (xii. 10 seq.), and that the last name is that of Jaddua, who, according to Josephus, was a contemporary of Alexander the Great (333 B.C.). That the compiler wrote after the fall of the Persian monarchy has been argued by Ewald and others from the use of the title king of Persia (2 Chron. xxxvi. 23), and from the reference made in Neh. xii. 22 to Darius III. (336-332 B.C.) A date some time after 332 B.C. is now accepted by most modern critics. See further **EZRA AND NEHEMIAH**.

What seems to be certain and important for a right estimate of

¹ See the lists in Driver, *Lit. of Old Test.* pp. 502 sqq.; and the exhaustive summary by Fr. Brown in *Hastings' Dict. Bible*, i. 289 sqq.

the book is that the writer lived a considerable time after Ezra, and stood entirely under the influence of the religious institutions of the new theocracy. This standpoint determined the nature of his interest in the early history of his people. The true importance of Hebrew history had always centred in the fact that this petty nation was the people of Yahweh, the spiritual God. The tragic interest which distinguishes the annals of Israel from the forgotten history of Moab or Damascus lies wholly in that long contest which finally vindicated the reality of spiritual things and the supremacy of Yahweh's purpose, in the political ruin of the nation which was the faithless depository of these sacred truths. After the return from the Exile it was impossible to write the history of Israel's fortunes otherwise than in a spirit of religious pragmatism. But within the limits of the religious conception of the plan and purpose of the Hebrew history more than one point of view might be taken up. The book of Kings looks upon the history in the spirit of the prophets—in that spirit which is still echoed by Zech. i. 5 seq., but which had become extinct before the Chronicler wrote. The New Jerusalem of Ezra was organized as a municipality and a church, not as a nation. The centre of religious life was no longer the living prophetic word but the ordinances of the Pentateuch and the liturgical service of the sanctuary. The religious vocation of Israel was no longer national but ecclesiastical or municipal, and the historical continuity of the nation was vividly realized only within the walls of Jerusalem and the courts of the Temple, in the solemn assembly and stately ceremonial of a feast day. These influences naturally operated most strongly on those who were officially attached to the sanctuary. To a Levite, even more than to other Jews, the history of Israel meant above all things the history of Jerusalem, of the Temple, and of the Temple ordinances. Now the writer of *Chronicles* betrays on every page his essentially Levitical habit of mind. It even seems possible from a close attention to his descriptions of sacred ordinances to conclude that his special interests are those of a common Levite rather than of a priest, and that of all Levitical functions he is most partial to those of the singers, a member of whose guild he may have been. From the standpoint of the post-exilic age, the older delineation of the history of Israel, especially in the books of *Samuel* and *Kings*, could not but appear to be deficient in some directions, while in other respects its narrative seemed superfluous or open to misunderstanding, as for example by recording, and that without condemnation, things inconsistent with the later post-exilic law. The history of the ordinances of worship holds a very small place in the older record. Jerusalem and the Temple have not that central place in the book of *Kings* which they occupied in the minds of the Jewish community after the Exile. Large sections of the old history are devoted to the religion and politics of the ten tribes, which are altogether unintelligible and uninteresting when measured by a strictly Levitical standard; and in general the whole problems and struggles of the prophetic period turn on points which had ceased to be cardinal in the life of the New Jerusalem, which was no longer called to decide between the claims of the Word of Yahweh and the exigencies of political affairs and social customs, and which could not comprehend that men absorbed in deeper spiritual contests had no leisure for the niceties of Levitical legislation. Thus there seemed to be room for a new history, which should confine itself to matters still interesting to the theocracy of Zion, keeping Jerusalem and the Temple in the foreground, and developing the divine pragmatism of the history, not so much with reference to the prophetic word as to the fixed legislation of the Pentateuch, so that the whole narrative might be made to teach that the glory of Israel lies in the observance of the divine law and ritual.

For the sake of systematic completeness the book begins with Adam, as is the custom with later Oriental writers. But there was nothing to add to the Pentateuch, and the period from Moses to David contained little that served the purpose. The early history is therefore contracted into a series of tribal and priestly genealogies, which were doubtless by no means the least interesting part of the work at a time when every

Character
of the
work.

Contents.

Israelite was concerned to prove the purity of his Hebrew descent (cp. Ezra ii. 59, 62). Commencing abruptly (after some Benjamite genealogies) with the death of Saul, the history becomes fuller and runs parallel with the books of Samuel and Kings. The limitations of the compiler's interest in past times appear in the omission, among other particulars, of David's reign in Hebron, of the disorders in his family and the revolt of Absalom, of the circumstances of Solomon's accession, and of many details as to the wisdom and splendour of that sovereign, as well as of his fall into idolatry. In the later history the ten tribes are quite neglected ("Yahweh is not with Israel," 2 Chron. xxv. 7), and political affairs in Judah receive attention, not in proportion to their intrinsic importance, but according as they serve to exemplify God's help to the obedient and His chastisement of the rebellious. That the compiler is always unwilling to speak of the misfortunes of good rulers is not necessarily to be ascribed to a deliberate suppression of truth, but shows that the book was throughout composed not in purely historical interests, but with a view to inculcating a single practical lesson. The more important additions to the older narrative consist partly of statistical lists (1 Chron. xii.), partly of full details on points connected with the history of the sanctuary and the great feasts or the archaeology of the Levitical ministry (1 Chron. xiii., xv., xvi., xxii.-xxix.; 2 Chron. xxix.-xxxii., &c.), and partly of narratives of victories and defeats, of sins and punishments, of obedience and its reward, which could be made to point a plain religious lesson in favour of faithful observance of the law (2 Chron. xiii., xiv. 9 sqq.; xx., xxi. 11 sqq., &c.). The minor variations of *Chronicles* from the books of Samuel and Kings are analogous in principle to the larger additions and omissions, so that the whole work has a consistent and well-marked character, presenting the history in quite a different perspective from that of the old narrative.

The chronicler makes frequent reference to earlier histories which he cites by a great variety of names. That the names

Sources. "Book of the Kings of Israel and Judah," "Book of the Kings of Judah and Israel," "Book of the Kings of Israel," and "Affairs of the Kings of Israel" (2 Chron. xxxiii. 18), refer to a single work is not disputed. Under one or other title this book is cited some ten times. Whether it is identical with the Midrash¹ of the book of Kings (2 Chron. xxiv. 27) is not certain. That the work so often cited is not the Biblical book of the same name is manifest from what is said of its contents. It must have been quite an extensive work, for among other things it contained genealogical statistics (1 Chron. ix. 1), and it incorporated certain older prophetic writings—in particular, the *debārim* ("words" or "history") of Jehu the son of Hanani (2 Chron. xx. 34) and possibly the vision of Isaiah (2 Chron. xxxii. 32). Where the chronicler does not cite this comprehensive work at the close of a king's reign he generally refers to some special authority which bears the name of a prophet or seer (2 Chron. ix. 29; xii. 15, &c.). But the book of the Kings and a special prophetic writing are not cited for the same reign. It is therefore probable that in other cases than those of Isaiah and Jehu the writings of, or rather, about the prophets which are cited in *Chronicles* were known only as parts of the great "book of the Kings." Even the genealogical lists may have been derived from that work (1 Chron. ix. 1), though for these other materials may have been accessible.

The two chief sources of the canonical book of Kings were entitled *Annals* ("events of the times") of the Kings of Israel and Judah respectively (see KINGS). That the lost source of the *Chronicles* was not independent of these works appears probable both from the nature of the case and from the close and often verbal parallelism between many sections of the two Biblical narratives. But while the canonical book of Kings refers to separate sources for the northern and southern kingdoms, the source of *Chronicles* was a history of the two kingdoms combined, and so, no doubt, was a more recent work which in great measure was doubtless based upon older annals. Yet it

contained also matter not derived from these works, for it is pretty clear from 2 Kings xxi. 17 that the *Annals of the Kings of Judah* gave no account of Manasseh's repentance, which, according to 2 Chron. xxxiii. 18, 19, was narrated in the great book of the Kings of Israel. It was the opinion of Bertheau, Keil and others, that the parallelisms of *Chronicles* with *Samuel* and *Kings* are sufficiently explained by the ultimate common source from which both narratives drew. But most critics hold that the chronicler also drew directly from the canonical books of Samuel and Kings as he apparently did from the Pentateuch. This opinion is not improbable, as the earlier books of the Old Testament cannot have been unknown in his age; and the critical analysis of the canonical book of Kings is advanced enough to enable us to say that in some of the parallel passages the chronicler uses words which were not written in the annals but by one of the compilers of *Kings* himself. In particular, *Chronicles* agrees with *Kings* in those short notes of the moral character of individual monarchs which can hardly be ascribed to an earlier hand than that of the redactor of the latter book.²

For the criticism of the book it is important to institute a careful comparison of *Chronicles* with the parallel narratives in *Samuel-Kings*.³ It is found that in the cases where *Chronicles* directly contradicts the earlier books there are few in which an impartial historical judgment will decide in favour of the later account, and in any point that touches difference of usage between its time and that of the old monarchy it is of no authority. The characteristic feature of the post-exilic age was the re-shaping of older tradition in the interest of parenetic and practical purposes, and for this object a certain freedom of literary form was always allowed to ancient historians. The typical speeches in *Chronicles* are of little value for the periods to which they relate, and where they are inconsistent with the evidence from earlier writings or contain inherent improbabilities are scarcely of historical worth. According to the ordinary laws of research, the book, being written at a time long posterior to the events it records, can have only a secondary value, although that is no reason why here and there valuable material should not have been preserved. But the general picture which it gives of life under the old monarchy cannot have the same value for us as the records of the book of Kings. On the other hand, it is of distinct value for the history of its time, and presents a clear picture of the spirit of the age. The "ecclesiastical chronicle of Jerusalem," as Reuss has aptly called it, represents the culminating point (as far as the O. T. Canon is concerned) of that theory of which examples recur in Judges, Samuel and Kings, and this treatment of history in accordance with religious or ethical doctrines finds its continuation in the didactic aims which characterize the later non-canonical writings (cf. JUBILEES; MIDRASH).

The most prominent examples of disagreement with earlier sources may be briefly noticed. Thus, it would appear that the book has confused Jehoiaakim and Jehoiachin (2 Chron. xxxvi. 5-8) and has statements which directly conflict with 2 Sam. xxi. 19 (1 Chron. xx. 5; see GOLIATH), and 1 Kings ix. 10 seq. (2 Chron. viii. 2); it has changed Hezekiah's submission (2 Kings xviii.) into a brave resistance (2 Chron. xxxii. 1-8) and ignored the humiliating payment of tribute by this king and by Joash (2 Kings xii. 18; 2 Chron. xxiv. 23 sqq.).⁴ That Satan, and not Yahweh incited

² The problem of the sources is one of considerable intricacy and cannot be discussed here; the introduction to the commentaries of Beninger and Kittel (see *Bibliography* below) should be consulted. The questions depend partly upon the view taken of the origin and structure of the book of Kings (*q.v.*) and partly upon the results of historical criticism.

³ "A careful comparison of *Chronicles* with *Samuel* and *Kings* is a striking object lesson in ancient historical composition. It is an almost indispensable introduction to the criticism of the Pentateuch and the older historical works" (W. H. Bennett, *Chronicles*, p. 20 seq.).

⁴ But xxxii. 1-8 may preserve a tradition of the account of the city's wonderful deliverance mentioned in *Kings* (see HEZEKIAH), and the details of the invasion of Judah in the time of Joash differ essentially from those in the earlier source. Even 2 Chron. viii. 2 cannot be regarded as a *deliberate* alteration since the writer does not appear to be quoting from 1 Kings ix. 10 sqq. (the two passages should be carefully compared), and his view of Solomon's greatness is already supported by allusions in the earlier but extremely composite sources in *Kings* (see SOLOMON).

¹ R.V. "commentary," properly, an edifying religious work, a didactic or homiletic exposition. A distinct tendency to Midrash is found even here and there in the earlier books.

David to number Israel (1 Chron. xxi.; 2 Sam. xxiv 1) accords with later theological development.

A particular tendency to arrange history according to a mechanical rule appears in the constant endeavour to show that recompense and retribution followed immediately on good or bad conduct, and especially on obedience or disobedience to prophetic advice. Thus, the invasion of Shishak (see *РЕНОВОАМ*) becomes a typical romance (2 Chron. xii.); the illness of Asa is preceded by a denunciation for relying upon Syria, and the chronology is changed to bring the fault near the punishment (2 Chron. xv. seq.). The ships which Jehoshaphat made were wrecked at Ezion-geber because he had allied himself with Ahaziah of Israel despite prophetic warning (2 Chron. xx. 35 sqq.; 1 Kings xxii. 48; cf. similarly the addition in 2 Chron. xix. 1-3), and the later writer supposes that the "Tarshish ships" (large vessels such as were used in trading with Spain—cf. "Indiamen") built in the Red Sea were intended for the Mediterranean trade (cf. 2 Chron. ix. 21 with 1 Kings x. 22). The Edomite revolt under Jehoram of Judah becomes the penalty for the king's apostasy (2 Chron. xxi. 10-20; 2 Kings viii. 22). Ahaziah was slain because of his friendship with Jehoram (2 Chron. xxii. 7). The Aramaean invasion in the time of Joash of Judah was a punishment for the murder of Jehoiada's son (2 Chron. xxiv.; 2 Kings xii.). Amaziah, after defeating Edom (2 Chron. xxv., esp. verses 19-21; see 2 Kings xiv. 10 seq.), worshipped strange gods, for which he was defeated by Joash of Israel, and subsequently met with his death (2 Chron. xxv. 27; 2 Kings xiv. 19). Uzziah's leprosy is attributed to a ritual fault (2 Chron. xxvi. 4 seq., 16 sqq.; cf. 2 Kings xv. 3-5; see *UZZIAH*). The defeat and death of the good king Josiah came through disobedience to the Divine will (2 Chron. xxxv. 21 seq.; see 2 Kings xxiii. 26 sqq.).

In addition to such supplementary information, another tendency of the chronicler is the alteration of narratives that do not agree with the later doctrines of the uniformity of religious institutions before and after the exile. Thus, the reformation of Josiah has been thrust back from his eighteenth to his twelfth year (when he was nineteen years old) apparently because it was felt that so good a king would not have tolerated the abuses of the land for so long a period,¹ but the result of this is to leave an interval of ten years between his conversion and the subsequent act of repentance (2 Chron. xxxiv. 3-6; 2 Kings xxii. seq.). References to Judæan idolatry are omitted (1 Kings xiv. 22-24; see 2 Chron. xii. 14; 2 Kings xviii. 4; 2 Chron. xxxi. 1) or abbreviated (2 Kings xxiii. 1-20; 2 Chron. xxxiv. 29-33); and if the earlier detailed accounts of Judæan heathenism were repulsive, so the tragic account of the fate of Jerusalem was a painful subject upon which the chronicler's age did not care to dwell (contrast 2 Kings xxiv. 8-xxv. with the brief 2 Chron. xxxvi. 9-21). At an age when the high places were regarded as idolatrous it was considered only natural that the good kings should not have tolerated them. So 2 Chron. xiv. 5, xvii. 6 (from unknown sources) contradict 1 Kings xv. 14, xxii. 43 (that Asa and Jehoshaphat did not demolish the high places), whereas xv. 16-18, xx. 31-34, are quoted from the book of Kings and give the older view. The example is an illustration of the simple methods of early compilers. Further, it is assumed that the high place at Gibeon was a legitimate sanctuary (2 Chron. i. 3-6; 1 Kings'iii. 2-4; 1 Chron. xxi. 28-30; 2 Sam. xxiv.); that the ark was borne not by priests (1 Kings viii. 3) but by Levites (2 Chron. v. 4), in accordance with post-exilic usage; and that the Levites, and not the foreign bodyguard of the temple, helped to place Joash on the throne (2 Chron. xxiii.).² Conversely 1 Chron. xv. 12 seq. explains xiii. 10 (2 Sam. vi. 7) on the view that Uzza was not a Levite, hence the catastrophe.

Throughout it is assumed that the Levitical organization had been in existence from the days of David, to whom its foundation is ascribed. In connexion with the installation of the ark considerable space is devoted to the arrangements for the maintenance of the temple-service, upon which the earlier books are silent, and elaborate notices of the part played by the Levites and singers give expression to a view of the history of the monarchy which the book of Kings does not share.³ Along with the exceptional interest taken in Levitical and priestly lists should be noticed the characteristic preference for genealogies. Particular prominence is given to the tribe and kings of Judah (1 Chron. ii.-iv.), and to the priests and Levites (1 Chron. vi., xv. sq., xxiii.-xxv.; with ix. 1-34 cf. Neh. xi.). The historical value of these lists is very unequal; a careful study of the names often proves the lateness of the source, although an appreciation of the principles of genealogies sometimes reveals important historical information; see *CALEB*, *GENEALOGY*, *JUDAH*. But the Levitical system as it appears in its most complete form in

¹ But that this was not the invention of the chronicler appears possible from Jer. xxv. 3. Similarly, Hezekiah's reforms are dated in his first year (2 Chron. xxx. 3), against all probability; see *HEZEKIAH* (end).

² 2 Chron. xxiii. is an excellent specimen of the redaction to which older narratives were submitted; cf. also 2 Chron. xxiv. 5 seq. (2 Kings xi. 4 seq.), xxxiv. 9-14 (2 Kings xxii.), xxxv. 1-19 (2 Kings xxiii. 21-23).

³ Passages in the books of Samuel and Kings which might appear to point to the contrary require careful examination; they prove to be glosses or interpolations, or are relatively late as a whole.

Chronicles is the result of the development of earlier schemes, of which some traces are still preserved in *Chronicles* itself and in *Ezra Nehemiah*. (See further *LEVITES*.)

The tendency of numbers to grow is one which must always be kept in view—cf. 1 Chron. xviii. 4, xix. 18 (2 Sam. viii. 4 [but see LXX.], x. 18), 1 Chron. xxi. 5, 25 (2 Sam. xxiv. 9, 24); consequently little importance can be attached to details which appear to be exaggerated (1 Chron. v. 21, xii., xxii. 14; 2 Chron. xiii. 3, 17), and are found to be quite in accordance with similar peculiarities elsewhere (Num. xxxi. 32 seq.; Judg. xx. 2, 21, 25).

But when allowance is made for all the above tendencies of the late post-exilic age, there remains a certain amount of additional matter in *Chronicles* which may have been derived from relatively old sources. These items are of purely political or personal nature and contain several details which taken by themselves have every appearance of genuineness. Where there can be no suspicion of such "tendency" as has been noticed above there is less ground for scepticism, and it must be remembered that the earlier books contain only a portion of the material to which the compilers had access. Hence it may well happen that the details which unfortunately cannot be checked were ultimately derived from sources as reputable as those in the books of Samuel, Kings, &c. As examples may be cited Rehoboam's buildings, &c. (2 Chron. xi. 5-12, 18 sqq.); Jeroboam's attack upon Abijah (2 Chron. xiii., cf. 1 Kings xv. 7); the invasion of Zerah in Asa's reign (2 Chron. xiv.; see *ASA*); Jehoshaphat's wars and judicial measures (2 Chron. xvii. xx.; see 1 Kings xxii. 45); Jehoram's family (2 Chron. xxi. 2-4); relations between Jehoiada and Joash (2 Chron. xxiv. 3, 15 sqq.); conflicts between Ephraim and Judah (2 Chron. xxv. 6-13); wars of Uzziah and Jotham (2 Chron. xxvi. seq.); events in the reign of Ahaz (2 Chron. xxviii. 8-15, 18 seq.); reforms of Hezekiah (2 Chron. xxix. sqq., cf. Jer. xxvi. 19); Manasseh's captivity, repentance and buildings (2 Chron. xxxiii. 10-20; see 2 Kings xxi. and *MANASSEH*); the death of Josiah (2 Chron. xxxv. 20-25). In addition to this reference may be made to such tantalizing statements as those in 1 Chron. ii. 23 (R.V.), iv. 39-41, v. 10, 18-22, vii. 21 seq., viii. 13, xii. 15, examples of the kind of tradition, national and private, upon which writers could draw. Although in their present form the additional *narratives* are in the chronicler's style, it is not necessary to deny an older traditional element which may have been preserved in sources now lost to us.⁴

BIBLIOGRAPHY.—Robertson Smith's article in the 9th ed. of the *Ency. Brit.* was modified by his later views in *Old Test. in the Jewish Church*², pp. 140-148. Recent literature is summarized by S. R. Driver in his revision of Smith's article in *Ency. Bib.* and in his *Lit. of Old Test.*, and by F. Brown in *Hastings' Dict. Bib.* (a very comprehensive article). Many parts of the book offer a very hard task to the expositor, especially the genealogies, where to other troubles are added the extreme corruption and many variations of the proper names in the versions; on these see the articles in the *Ency. Bib.* Valuable contributions to the exegesis of the book will be found in Wellhausen's *Prolegomena* (Eng. trans.), pp. 171-227; Benzinger in Marti's *Hand-Kommentar* (1901); Kittel in *Sacred Books of the Old Test.* (1895), *History of the Hebrews*, ii. 224 sqq. (1896), and in Nowack's *Hand-Kommentar* (1902). W. H. Bennett in *Expositor's Bible* (1894). W. E. Barnes in *Cambridge Bible* (1899), and Harvey-Jellie in the *Century Bible* (1906), are helpful. Among more recent investigations are those of Howorth, *Proc. Soc. of Bibl. Archaeol.* xvii. 267-278 (*Chronicles* a late translation from the Aramaic). (W. R. S.; S. A. C.)

CHRONOGRAPH from Gr. χρόνος, time, and γράφειν, to write). Instruments whereby periods of time are measured and recorded are commonly called chronographs, but it would be more correct to give the name to the records produced. Instruments such as "stop watches" (see *WATCH*), by means of which the time between events is shown on a dial, are also called chronographs; they were originally rightly called chronoscopes (σκοπεῖν, to see).

⁴ The view that the chronicler *invented* such narratives is inconceivable, and in the present stage of historical criticism is as unsound as an implicit reliance upon those sources in the earlier books, which in their turn are often long posterior to the events they record. Although Graf, in a critical and exhaustive study (*Geschichtlichen Bücher des A.T.*, Leipzig, 1866), concluded that the *Chronicles* have almost no value as a documentary source of the ancient history, he subsequently admitted in private correspondence with Bertheau that this statement was too strong (preface to *Bertheau's Commentary*, 2nd ed., 1873).

In the first experiments in ballistics by B. Robins, Count Rumford and Charles Hutton, the velocity of a projectile was found by means of the ballistic pendulum, in which the principle of momentum is applied in finding the velocity of a projectile (*Principles of Gunnery*, by Benjamin Robins, edited by Hutton, 1805, p. 84). It consisted of a pendulum of considerable weight, which was displaced from its position of rest by the impact of the bullet, the velocity of which was required. A modification of the ballistic pendulum was also employed by W. E. Metford (1824-1899) in his researches on different forms of rifling; the bob was made in the form of a long cylinder, weighing about 140 lb, suspended with its axis horizontal from four wires at each end, all moving points being provided with knife edges. The true length of suspension was deduced from observations of the time of a complete small oscillation. The head of the pendulum was furnished with a wooden block, which caught the fragments of bullets fired at it, and its displacement was recorded by a rod moved by the bob (*The Book of the Rifle*, by the Hon. T. F. Fremantle, p. 336). An improved ballistic pendulum in which the geometric method of suspension is introduced has been used by A. Mallock, to determine the resistance of the air to bullets having a velocity up to 4500 F/S. (*Proc. Roy. Soc.*, Nov. 1904). A ballistic pendulum, carried by a geometric suspension from five points, has also been employed by C. V. Boys in a research on the elasticity of golf balls, the displacement of the bob being recorded on a sheet of smoked glass.¹ For further information on the dynamics of the subject see *Text Book of Gunnery*, 1897, p. 101.

In nearly all forms of chronographs in which the ballistic pendulum method is not used, the beginning and end of a period of time is recorded by means of some kind of electrically controlled mechanism; and in order that small fractions of a second may be measured, tuning-forks are employed, giving any convenient number of vibrations per second, a light style or scribing point, usually of aluminium, being attached to one of the legs of the tuning-fork. A trace of the vibration is made on a surface blackened with the deposit from the smoke of a lamp. Glazed paper is often employed when the velocity of the surface is slow, but when a high velocity of smoked surface is necessary, smoked glass offers far the least resistance to the movement of the scribing points. If the surface be cylindrical, thin sheet mica attached to it, and smoked, gives excellent results, and offers but little resistance to all the scribing points employed. The period of vibration of tuning-forks is determined by direct or indirect comparison with the mean solar second, taken from a standard clock, the rate of which is known from transit observations ("Recherches sur les vibrations d'un diapason étalon," R. Koenig, *Wied. Ann.*, 1880). In the celebrated ballistic experiments of the Rev. F. Bashforth, the time markings were made electrically from a standard clock and fractions of a second were estimated by interpolation. Regnault (*Mémoires de l'acad. des sciences*, t. xxxvii.) employed both a standard clock and a tuning-fork in his determination of the velocity of sound. The effect of temperature on tuning-forks has been determined by

¹ The velocity of the projectile is found thus. Let V be the velocity of the bob, due to the impact of the projectile, v the velocity of the projectile, h the height through which the bob is raised vertically, then

$$h = \frac{V^2}{2g}, \text{ and } V = \sqrt{2gh}.$$

If W be the weight of the bob, and w the weight of the projectile, then

$$wv = (W+w)V, \text{ and } v = \left(\frac{W}{w} + 1\right) \sqrt{2gh}.$$

If l be the true length of suspension, and C the length of the chord of the arc of displacement of the bob after being struck, then

$$C^2 = 2hl, \text{ and } v = \left(\frac{W}{w} + 1\right) \sqrt{\frac{g}{l}} C.$$

Also if T be the time of a complete small oscillation of the pendulum,

$$\frac{2\pi}{T} = \sqrt{\frac{g}{l}},$$

so that $v = \left(\frac{W}{w} + 1\right) \frac{2\pi C}{T}$.

Lord Rayleigh and Professor H. McLeod (*Proc. Roy. Soc.*, 1880, 26, p. 162), who found the coefficient to be 0.00011 per degree C. between 9° C. and 27° C. The beginning and end of a time period is marked on a moving surface in many ways. Usually an electromagnetic stylus is employed, in which a scribing point suddenly moves when the electric circuit is broken by a projectile. Another method is to arrange the terminals of the secondary circuit of an induction coil, so that when the primary circuit is opened a small spark punctures or marks a moving surface (Helmholtz, *Phil. Mag.*, 1853, p. 6). A photographic plate or film, moving in a dark chamber, is also used to receive markings produced by a beam of light interrupted by a small screen attached to an electromagnetic stylus, or by the legs of a tuning-fork, or by the mercury column of a capillary electrometer. In certain researches on the explosive wave of gases the light given by the burning gases made the time trace on a rapidly moving photographic film (H. B. Dixon, *Phil. Trans.*, 1903, 200, p. 323). In physiological chronography the stylus is in many cases actuated directly by the piece of muscle to which it is attached; when the muscle is stimulated its contraction moves the stylus on the moving surface of the myograph (M. Foster, *Text Book of Physiology*, 1879, p. 39).

Gun Chronographs.—Probably the earliest forms of chronographs, not based on the ballistic pendulum method, are due to Colonel Grobert, 1804, and Colonel Dabooz, 1818, both officers of the French army. In the instrument by Grobert two large disks, attached to the same axle 13 ft. apart, were rapidly rotated; the shot pierced each disk, the angle between two holes giving the time of flight of the ball, when the angular velocity of the disks was known. In the instrument by Colonel Dabooz a cord passing over two light pulleys, one close to the gun, the other at a given distance from it, was stretched by a weight at the gun end and by a heavy screen at the other end. Behind this screen there was a fixed screen. The shot cut the cord and liberated the screen, which was perforated during its fall. The height of fall was measured by superposing the hole in the moving screen upon that in the fixed one. This gave the approximate time of flight of the shot over a given distance, and hence its velocity.

In the early form of chronoscope invented by Sir C. Wheatstone in 1840 the period of time was measured by means of a species of clock, driven by a weight; the dial pointer was started and stopped by the action of an electromagnet which moved a pawl engaging with a toothed wheel fixed on the axle to which the dial pointer was attached. The instrument applied to the determination of the velocity of shot is described thus by Wheatstone:—"A wooden ring embraced the mouth of the gun, and a wire connected the opposite sides of the ring. At a proper distance the target was erected, and so arranged that the least motion given to it would establish a permanent contact between two metal points. One of the extremities of the wire of the electromagnet (before mentioned) was attached to one pole of a small battery; to the other extremity of the electromagnet were attached two wires, one of which communicated with the contact piece of the target, and the other with one of the ends of the wire stretched across the mouth of the gun; from the other extremity of the voltaic battery two wires were taken one of which came to the contact piece of the target, and the other to the opposite extremity of the wire across the mouth of the gun. Before the firing of the gun a continuous circuit existed, including the gun wire; when the target was struck the second circuit was completed; but during the passage of the projectile both circuits were interrupted, and the duration of this interruption was indicated by the chronoscope."

Professor Joseph Henry (*Journal Franklin Inst.*, 1886) employed a cylinder driven by clockwork, making ten revolutions per second. The surface was divided into 100 equal parts, each equal to $\frac{1}{1000}$ second. The time marks were made by two galvanometer needles, when successive screens were broken by a shot. Henry also used an induction-coil spark to make the cylinder, the primary of the coil being in circuit with a battery and screen. This form of chronograph is in many respects similar to the instrument of Konstantinoff, which was constructed by L. F. C. Breguet and has been sometimes attributed to him (*Comptes rendus*, 1845). This chronograph consisted of a cylinder 1 metre in circumference and 0.36 metre long, driven by clockwork, the rotation being regulated by a governor provided with wings. A small carriage geared to the wheelwork traversed its length, carrying electromagnetic signals. The electric chronograph signal usually consists of a small armature (furnished with a style which marks a moving surface) moving in front of an electromagnet, the armature being suddenly pulled off the poles of the electromagnet by a spring when the circuit is broken (*Journal of Physiology*, ix. 408). The signals in Breguet's instrument were in a circuit, including the screens and batteries of a gun range. The measurement of time depended on the

Grobert
and
Dabooz.

Wheat-
stone.

Henry.

regularity of rotation of the cylinder, on which each mm. represented $\frac{1}{1000}$ second.

In the chronograph of A. J. A. Navez (1848) the time period is found by means of a pendulum held at a large angle from the vertical by an electromagnet, which is in circuit with a screen on the gun range. When the shot cuts this screen the circuit is broken and the pendulum liberated and set swinging. When the next screen on the range is broken by the shot, the position of the pendulum is recorded and the distance it has passed through measured on a divided arc. From this the time of traversing the space between the screens is deduced. By means of an instrument known as a disjuncter the instrumental time-loss or latency of the chronograph is determined.

Benton. In Benton's chronograph (1859) two pendulums are liberated, in the same manner as in the instrument of Navez, one on the cutting of the first screen, the other on the cutting of the second. The difference between the swings of the two pendulums gives the time period sought for. The disjuncter is also used in connexion with this instrument. In Vignotti's chronograph (1857) again a pendulum is employed, furnished with a metal point, which moves close to paper impregnated with ferrocyanide of potassium. The gun-range screens are included in the primary circuits of induction coils; when these circuits are broken a spark from the pointer marks the paper. From these marks the time of traverse of the shot between the screens is determined.

In the Bashforth chronograph a platform, arranged to descend slowly alongside of a vertical rotating cylinder, carries two markers,

Bashforth. controlled by electromagnets, which describe a double spiral on the prepared surface of the cylinder. One electromagnet is in circuit with a clock, and the marker actuated by it marks seconds on the cylinder; the circuit of the other is completed through a series of contact pieces attached to the screens through which the shot passes in succession. On the gun range, when the shot reaches the first screen, it breaks a weighted cotton thread, which keeps a flexible wire in contact with a conductor. When the thread is broken by a shot, the wire leaves the conductor and almost immediately establishes the circuit through the next screen, by engaging with a second contact, the time of the rupture being recorded on the cylinder by the second marker. The velocity with which the cylinder rotates is such that the distance between successive clock marks indicating seconds is about 18 in.; hence the marks corresponding with the severance of a thread can be allotted their value in fractions of seconds with great accuracy. The times when the shot passes successive screens being thus recorded on the spiral described by the second marker, and the distance between each screen being known, the velocity of the shot can be calculated.

The chronoscope invented by Sir Andrew Noble is so well adapted to the measurement of very small intervals of time that it is usually

Noble. employed to ascertain the velocity acquired by a shot at different parts of the bore in moving from a state of rest inside the gun. A series of "cutting plugs" is screwed into the sides of the gun at measured intervals, and in each is inserted a loop of wire which forms part of the primary circuit of an induction coil. On the passage of a shot this wire is severed by means of a small knife which projects into the bore and is actuated by the shot as it passes; the circuit being thus broken, a spark passes between the terminals of the secondary of the coil. There is a separate coil and circuit for each plug. The recording arrangement consists of a series of disks, one for each plug, mounted on one axle and rotating at a high angular velocity. The edges of these disks are covered with a coating of lamp-black, and the secondaries of the coils are caused to discharge against them, so that a minute spot burnt in the lamp-black of each disk indicates the moment of the cutting of the wire in the corresponding plug. Hence measurement of the distance between two successive spots gives the time occupied by the shot in moving over the portion of the bore between two successive plugs. By the aid of a vernier, readings are made to thousandths of an inch, and the peripheral velocity of the disks being 1100 in. a second, the machine indicates portions of time rather less than one-millionth of a second; it is, in fact, practically correct to hundred-thousandths of a second (*Phil. Trans.*, 1875, pt. i.).

In the Le Boulengé chronograph ("Chronograph le Boulengé," par M. Réger, Commission de Gâvre, Sept. 1880) two screens are

Le Boulengé. used. The wire of the first forms part of the circuit of an electromagnet which, so long as it is energized, supports a vertical rod called the "chronometer." Hence when the circuit is broken by the passage of a shot through the screen this rod drops. The wire of the second screen conveys a current through another electromagnet which supports a much shorter rod. This "registrar," as it is called, when released by the shot severing the wire of the second screen, falls on a disk which sets free a spring, and causes a horizontal knife to fly forward and nick a zinc tube with which the chronometer rod is sheathed. Hence the long rod will be falling for a certain time, while the shot is travelling between the two screens, before the short rod is released; and the longer the shot takes to travel this distance, the farther the long rod falls, and the higher up on it will be the nick made by the knife. A simple calculation connects the distance through which the rod falls with the time occupied by the shot in travelling over the distance between the screens, and thus its velocity ascertained. The nick made by the knife, if released while the chronometer rod is still suspended,

is the zero point. If both rods are released simultaneously, as is done by breaking both circuits at once by means of a "disjuncter," a certain time is consumed by the short rod in reaching the disk, setting free the spring and cutting a nick in the zinc; and during this time the long rod is falling into a recess in the stand deep enough to receive its full length. The instrument is so adjusted that the nick thus made is 4.435 in. above the zero point, corresponding to 0.15 sec.. This is the disjuncter reading, and requires to be frequently corrected during experiments. The instrument was modified and improved by Colonel H. C. Holden, F.R.S. For further information respecting formulæ relating to it see *Text Book of Gunnery* (1897).

The electric chronograph of the late H. S. S. Watkin consists of two long cylinders rotating on vertical axes, and between them a cylindrical weight, having a pointed head, is free to fall.

Watkin. The weight is furnished with an insulated wire which passes through it at right angles to its longest axis. When the weight falls the ends of the insulated wire move very close to the surfaces of the cylinders which form part of a secondary circuit of an induction coil, the primary circuit of which is opened when a screen is ruptured by a shot. A minute mark is made by the induced spark on the smoked paper with which the cylinders are covered. The time period between events is deduced from the space fallen through by the weight, and by means of a scale, graduated for a given distance between the screens, the velocity of a shot is at once found. It may be noted that the method of release is such that the falling weight is not subjected, after it has begun to fall, to a diminishing magnetic field, which would be the case if it were directly supported by an electromagnet. An iron rod when falling from an electromagnet, during a minute portion of its fall, is subject to a diminishing force acting in the opposite sense to that of gravity, whereby its time of fall is slightly changed.

Colonel Sebert (*Extraits du mémorial de l'artillerie de la marine*) devised a chronograph to indicate graphically the motion of recoil of a cannon when fired. A pillar fixed to the ground at the side of the gun-carriage supported a tuning-fork, the

Sebert. vibration of which was maintained electrically. The fork was provided with a tracing point attached to one of the prongs, and so adjusted that it drew its path on a polished sheet of smoke-blackened metal attached to the gun-carriage, which traversed past the tracing point when the gun ran back. The fork used made 500 complete vibrations per second. A central line was drawn through the curved path of the tracing point, and every entire vibration cut the straight line twice, the interval between each intersection equalling $\frac{1}{500}$ second. The diagram so produced gave the total time of the accelerated motion of recoil of the gun, the maximum velocity of recoil, and the rate of acceleration of recoil from the beginning to the end of the motion. By means of an instrument furnished with a microscope and micrometers, the length and amplitude, and the angle at which the curved line cut the central line, were measured. At each intersection (according to the inventor) the velocity could be deduced. The motion at any intersection being compounded of the greatest velocity of the fork, while passing through the midpoint of the vibration and the velocity of recoil, the tangent made by the curve with the straight line represents the ratio of the velocity of the fork to the velocity of recoil. If a be the amplitude of vibration, considered constant, v the velocity of the fork at the midpoint of its path, r the velocity of recoil, α the angle made by the tangent to the curve with the straight line at the point of intersection, and t the line of a complete vibration; then, $v = 2\pi a/t$; $r = v/\tan \alpha$.

F. Jervis-Smith's tram chronograph (*Patents*, 1894, 1897, 1903) was devised for measuring periods of time varying from about one-fourth to one twenty-thousandth part of a second (*Proc. Roy. Soc.*, 1889, 45, p. 452; *The Tram Chronograph*, by Jervis-Smith, F.R.S.). It consists of a metal girder

having a T-shaped end. This carries two parallel steel rails, the edges of which lie in the same vertical plane. The girder, which is slightly inclined to the horizontal plane, is geometrically supported, being carried at its end, and at the extremities of the T-piece, on a V-groove, trihedral hole and plane. A carriage or tram furnished with three grooved wheels runs on the rails, and a slightly smoked glass plate is attached to its vertical side. The tram in the original instrument was propelled by a falling weight, but in an improved form one or more spiral springs are employed. All time traces are made immediately after the propelling force has ceased to act. The tram is brought to rest by a gradually applied brake, consisting of two crossed leather bands stretched by two springs; a projection from the tram runs between the bands, and brings it to rest with but little lateral pressure. When, for certain physiological experiments, a low velocity of traverse is required, a heavy fly-wheel is mounted on the tram and geared to its wheels. A pillar also mounted geometrically, placed vertically in front of the carriage, carries the electromagnet style or signals and tuning-fork which can be brought into contact with the glass by means of a lever. Also styli are used which depend for their action on the displacement of one or more wires under tension or torsion carrying a current in a magnetic field, the condition being such that no magnetic lag due to iron armatures and cores exists. Two motions of a slide on the pillar, viz. of rotation and translation, allow a number of observations to be made. The traces are counted out on a sloping glass desk, and the time of flight of a projectile between two or more screens is found. When

very close readings are required, they are made by means of a traversing geometric micrometer microscope. When the distance between the screens is known, and also the time of flight, the mid-point velocity is found by applying Bashforth's formula. When the velocity of shot from a shot-gun has to be found, a thin wire stretched across the muzzle takes the place of the first screen, and a thin sheet of metal or cardboard carrying an electric contact, or a Branly coil, the conductivity of which is restored by means of an induced current, takes the place of the second screen. The electric firing circuit is provided with a safety key attached by a cord to the man who loads the gun and prepares the electric fuse. The firing circuit is closed by inserting the key in a switch at the rear of the gun, thus preventing him from getting into the line of fire when the gun is fired by the chronograph. The tram, when the instrument is adjusted, has a practically constant velocity of traverse.

The polarizing photo-chronograph, designed and used by A. C. Crehore and G. O. Squier at the United States Artillery School

(*Trans. Amer. Inst. Elec. Eng.* vol. 14, and *Journal United States Artillery*, 1895, 6, p. 271), depends for its indications upon the rotation of a beam of light by a magnetic field, produced by a solenoidal current which is opened and closed by the passage of the projectile. The general arrangement is as follows:—A beam of light from an electric lamp traverses a lens, then a Nicol prism, next a glass cylinder furnished with plane glass ends and coiled with insulated wire, then an analyser and two lenses, finally impinging on a photographic plate to which rotation is given by an electric motor, the plane of rotation being perpendicular to the direction of the beam of light. The same plate also records the shadow of a pierced projection attached to a tuning-fork, light from the electric lamp being diverted by a mirror for this purpose. The solenoid used to produce a magnetic field across the glass cylinder, which is filled with carbon bisulphide, is in circuit with a dynamo, resistances, and the screens on the gun range. It is a well-known phenomenon in physics that when, with the above-mentioned combination of polarizing Nicol prism and analyser, the light is shut off by rotating the analyser, it is instantly restored when the carbon bisulphide is placed in a magnetic field. This phenomenon is utilized in this instrument. The projectile, by cutting the wire screens, causes the magnetic field to cease and light to pass. By means of an automatic switch the projectile, after cutting a screen, restores the electric circuit, so that successive records are registered. After a record has been made it is read by means of a micrometer microscope, the angle moved through by the photographic disk is found, and hence the time period between two events. In the photo-chronograph described in *Untersuchungen über die Vibration des Gewehrslafets*, by C. Cranz and K. R. Koch (Munich, 1899), also note on the same, *Nature*, 61, p. 58, a sensitive plate moving in a straight line receives the record of the movement of the barrels of firearms when discharged. It was mainly used to determine the "angle of error of departure" in ballistics.

In a second chronograph by Watkin ("Chronographs and their Application to Gun Ballistics," *Proc. Roy. Inst.*, 1896), a metal drum, **Watkin.** divided on its edge so that when a vernier is used a minute of angle may be read, is rotated rapidly by a motor at a practically uniform speed. The points of a row of steel-pointed pins, screwed into a frame of ebonite, can be brought within $\frac{1}{16}$ in. of the surface of the drum. Each pin is a part of the secondary circuit of an induction coil, the space between the pins and the drum forming spark-gaps. The drum is rubbed over with a weak solution of paraffin wax in benzol, which causes the markings produced by the sparks to be well defined. The records are read by means of a fine hair stretched along the drum and just clear of it, the dots being located under the hair by means of a lens. The velocity of rotation is found by obtaining spark marks, due to the primary circuits of two induction coils being successively broken by a weight falling and breaking the two electric circuits of the coils in succession at a known distance apart. This chronograph has been used for finding the velocity of projectiles after leaving the gun, and also for finding the rate at which a shot traverses the bore. For the latter purpose the shot successively cuts insulated wires fixed in plugs screwed into the gun at known intervals; each wire forms a part of the primary of an induction coil, and as each is cut a dot is made on the rotating drum by the induced spark.

In the chronograph of Marcel Deprez, a cylinder for receiving records is driven at a high velocity, 4 to 5 metres per second surface velocity. The velocity is determined by means of an electrically-driven tuning-fork, the traces being read by means of a vernier gauge. A mercury speed indicator of the Ramsbottom type enables the rotation to be continuously controlled (*A. Favarger, L'Electricité et ses applications à la chronométrie*).

Astronomical Chronographs.—The astronomical chronograph is an instrument whereby an observer is enabled to register the time of transit of a star on a sheet of paper attached to a revolving cylinder. A metal cylinder covered with a sheet of paper is rotated by clockwork controlled by a conical pendulum, or by a centrifugal clock governor such as is used for driving a telescope. By means of a screw longer than the cylinder, mounted parallel with the axis of the cylinder and rotated by the clockwork, a carriage is made to traverse close to the paper. In some instruments this carriage is furnished with a metal point, and in others with a stylo-

graphic ink pen. The point or pen is made to touch the paper by an electromagnet, the electric current of which is closed by the observer at the transit instrument, and a mark is recorded on the revolving cylinder. The movement of the same point or pen is also controlled by a standard clock, so that at the end of each second a mark is made. The cylinder makes one revolution per minute, and the minute is indicated by the omission of the mark. In E. J. Dent's form (*Nature*, 23, p. 59) continuous observations can be recorded for 64 hours. The conical pendulum used to govern the rotation of the cylinder was the invention of Sir G. B. Airy. The lower end is geared to a metal plate which sweeps through an annular trough filled with glycerin and water. When the path of the pendulum exceeds a certain diameter it causes the plate to enter the liquid more deeply, its motion being thereby checked; also, when the pendulum moves in a smaller circle the plate is lifted out of the liquid and the resistance is diminished in the same proportion as the force. The compensatory action is considerable; doubling the driving power produces no perceptible difference in the time. To prevent the injury of the conical pendulum and the wheel work by any sudden check of the cylinder, a ratch-wheel connexion is placed between the cylinder and the train of wheel work; this enables the pendulum to run on until it gradually comes to rest. The pendulum, which weighs about 18 lb, is compensated, and makes one revolution in two seconds; it is suspended from a bracket by means of two flexible steel springs placed at right angles to one another.

The observatory of Washburn, University of Wisconsin, is furnished with a chronograph of the same type as that of Dent (*Annals Harvard Coll. Obs.* vol. i. pt. ii. p. 34), but in this instrument the rotation of the cylinder is controlled by a double conical pendulum governor of peculiar construction. When the balls fly out beyond a certain point, one of them engages with a hook attached to a brass cylinder which embraces the vertical axle loosely. When this mass is pulled aside the work done on it diminishes the speed of the governor. The pendulum ball usually strikes the hook from 60 to 70 times per minute. Governors on this principle were adopted by Alvan Clark for driving heliostats in the United States Transit of Venus Expedition, 1874.

In the astronomical chronograph designed by Sir Howard Grubb (*Proc. Inst. Mech. Eng.*, July 1886), the recording cylinders—two in number—are driven by a weight acting on a train of wheel **Grubb.** work controlled by an astronomical telescope governor.

The peculiar feature of this instrument is that the axle is geared to a shaft which communicates motion to the cylinders through a mechanism whereby the speed of rotation is constantly corrected by a standard clock. Should the rotation fall below the correct speed it is automatically accelerated, and if its speed of rotation rises above the correct one it is retarded. The accelerator and retarder are thrown into action by electromagnets, controlled by a "detector" mounted on the same shaft. The rather complicated mechanism employed to effect the correction is described and fully illustrated in the reference given. The cylinders are covered with paper, but all the markings are made with a stylographic pen. The marks indicating seconds are dots, but those made by the observer are short lines. When an observation is about to be made the observer first notes the hour and minute, and, by pressing a contact key attached to a flexible cord at the transit instrument, marks the paper with a letter in Morse telegraph characters, indicating the hour and minute; he then waits till a micrometer wire cuts a star and at the instant closes the circuit, so that the second and fraction of a second are registered on the chronograph paper. When a set of observations have been taken, the paper is removed from the cylinder, and the same results are obtained by applying a suitably divided rule to the marked paper, fractions of a second being estimated by applying a piece of glass ruled with eleven straight lines converging to a point. The ends of these lines on the base of the triangle so formed are equidistant on one edge of the glass, so that when the first and last lines are so placed as to coincide with the beginning and end of the markings of a second, that second is divided into ten equal parts. The base of the triangle is always kept parallel with the line of dots. The papers, after they have been examined and the results registered, are kept for reference.

In the astronomical chronograph of Hipp, used in determining longitudes, the movement of a recording cylinder is regulated by means of a toothed wheel, the last of a clockwork train, controlled by a vibrating metal tongue; this important **Hipp.** feature is described in detail in Favarger's work cited above.

Acoustic Chronographs.—In the chronograph devised by H. V. Regnault (*Acad. des Sc.*, 1868) to determine the velocity of sound propagated through a great length of pipe, a band of paper 27 mm. wide was continuously unrolled from a bobbin by means of an electromagnetic engine. In its passage over a pulley it passed over a smoky lamp flame, which covered it with a thin deposit of carbon. It next passed over a cylinder in contact with the style of a tuning-fork kept in vibration by electromagnets placed on either side of its prongs, the current being interrupted by the fork; it was also in contact with an electric signal controlled by a standard clock. Also an electromagnetic signal marked the beginning and end of a time period. Thus three markings were registered on the band, viz. the time of the pendulum, the vibrations of the fork, and the marking of the signal due to the opening and

closing of the current by electrical contacts attached to diaphragms on which the sound wave acted. The contacts consisted of minute hammers resting on metal points fixed to the centre of diaphragms which closed the end of the experimental pipes. The signal marked the instant at which a sound wave impinged on a diaphragm. The markings on the paper band gave the period of time between two events, and the number of vibrations of the tuning-fork per second was estimated by means of markings due to the clock. The sound wave was usually originated by firing a pistol into the pipe furnished with diaphragms and contact pieces.

In the chronographic use of the Morse telegraph instrument (Stewart and Gee, *Elementary Practical Phys.* p. 234) a circuit is arranged which includes a seconds' pendulum furnished with a fine platinum wire below the bob, which sweeps through a small mass of mercury forming a part of the circuit. There is a Morse key for closing the circuit. A fast-running Morse instrument and a battery are placed across this circuit as a shunt. A succession of dots is made on the paper ribbon by the circuit being closed by the pendulum, and the space between each adjacent dot indicates a period of one second's duration. Also, when the key is depressed, a mark is made on the paper. To measure a period of time, the key is depressed at the beginning and end of the period, causing two dots to be made on the ribbon; the interval between these, when measured by the intervals due to the pendulum, gives the length of the period in seconds, and also in fractions of a second, when the seconds' interval is subdivided into convenient equal parts. This apparatus has been used in determination of the velocity of sound. In the break-circuit arrangement of pendulum key and Morse instrument the markings appear as breaks in a line which would otherwise be continuous. This combination was employed by Professors W. E. Ayrton and J. Perry in their determination of the acceleration of gravity at Tokio, 1877-1878 (*Proc. Phys. Soc. Lond.* 3, p. 268).

In the tuning-fork electro-chronograph attributed to Hipp a metal cylinder covered with smoked glazed paper is rotated uniformly by clockwork, a tuning-fork armed with a metallic style being so adjusted that it makes a clear fine line on the smoked paper. The tuning-fork is placed in the secondary circuit of an induction coil, so that when the primary circuit is broken an induced spark removes a speck of black from the paper and leaves a mark. The time period is deduced by counting the number of vibrations and fractions of vibration of the tuning-fork as recorded by a sinuous line on the cylinder. In later forms of this instrument the cylinder advances as it rotates, and a spiral line is traced. To obtain good results the spark must be very small, for when large it often leaps laterally from the end of the style, and does not give the true position of the style when the circuit is broken. The same arrangement of tuning-fork and revolving cylinder, with the addition of a standard clock, has been used by A. M. Mayer (*Trans. Nat. Acad. Sci. U.S.A.* vol. iii.) and others for calibrating tuning-forks, and comparing their vibrations directly with the beats of the pendulum of a standard clock the rate of which is known. The pendulum marks and breaks the primary circuit by carrying a small platinum wire through a small mercury meniscus. Better and apparently certain contacts can be obtained from platinum contact-pieces, brought together above the pendulum by means of a toothed wheel on the scape-wheel arbor. Sparking at the contact points is greatly reduced by placing a couple of lead plates in dilute sulphuric acid as a shunt across the battery circuit.

For Physiological Purposes.—A. Fick's pendulum myograph or muscle-trace recorder is described in *Verhandlungen der naturforsch. Ges. in Zürich*, 1862, S. 307, and in *Text-book of Physiology*, M. Foster, pp. 42, 43. It was used to obtain a record of the contraction of a muscle when stimulated. In many respects the instrument is similar to the electro-ballistic chronograph of Navez. A long pendulum, consisting of a braced metal frame, carries at its lower end a sheet of smoked glass. The pendulum swings about an axis supported by a wall bracket. Previous to an experiment, the pendulum is held on one side of its lowest position by a spring catch; when this is depressed it is free to swing. At the end of its swing it engages with another spring catch. In front of the moving glass plate a tuning-fork is fixed, also a lever actuated by the muscle to be electrically stimulated. When the pendulum swings through its arc, it knocks over the contact key in the primary circuit of an induction coil, the secondary of which is in connexion with the muscle. The smoked plate receives the traces of the style of the tuning-fork and of the lever attached to the muscle, and also the trace of an electromagnetic signal which marks the instant at which the primary circuit is broken. After the traces are made, they are ruled through with radial lines, cutting the three traces, and the time intervals between different parts of the muscle curve are measured in terms of the period of vibration of the tuning-fork, as in other chronographs in which the tuning-fork is employed.

In the spring myograph of E. Du Bois Reymond (Munk's *Physiologie des Menschen*, p. 398) a smoked glass plate attached to a metal rod is shot by a spiral spring along two guides with a velocity which is not uniform. The traces of a style moved by the muscle under examination, and of a tuning-fork, are recorded on the glass plate, the shooter during its traverse knocking over one or more electric keys, which break the primary circuit of an induction coil, the induced current stimulating the muscle.

In the photo-electric chronograph devised by G. J. Burch, F.R.S. (*Journ. of Physiology*, 13, p. 125; *Electrician*, 37, p. 436), the rapid movements of the column of mercury in a capillary electrometer used in physiological research are recorded on a sensitive plate moving at a uniform angular velocity. The trace of the vibrating prongs of a tuning-fork of known period is also recorded on the plate, the light used being that of the electric arc. The images of the meniscus of the mercury column and of the moving fork are focused on the plate by a lens. Excellent results have been obtained with this instrument.

An important development of a branch of chronography is due to E. J. Marey (*Comptes rendus*, 7, acad. 1882, and *Le Mouvement*, par E. J. Marey, Paris, 1894), who employed a photographic plate for receiving successive pictures of moving objects, at definite times, when investigating the movements of animals, birds, fishes, insects, and also microscopic objects such as vorticellae. The instrument in one of its forms consisted of a camera and lens. In front of the sensitive plate and close to it a disk, pierced with radial slits, revolved at a given angular velocity, and each time a slit passed by the plate was exposed. But since, in the time of passage of the space between the slits, the object had moved by a certain amount across the field of view, a fresh impression was produced at each exposure. The object, well illuminated by sunlight, moved in front of a black background. Since the angular velocity of the disk was known, and the number of slits, the time between the successive positions of the object was also known.

Marey (*La Méthode graphique*, pp. 133, 142, 156), by means of pneumatic signals and a rotating cylinder covered with smoked glazed paper, measured the time of the movements of the limbs of animals. The instrument consists of a recording cylinder rotated at a uniform angular velocity by clockwork controlled by a fan governor, and pneumatic signal, constructed thus. One end of a closed shallow cylinder, about 1 cm. dia., is furnished with a stretched rubber membrane. A light lever, moving about an axis near the edge of the cylinder, is attached to the centre of the membrane by a short rod, its free end moving as the membrane is distended. The cylinder is connected by a flexible tube with a similar cylinder and membrane, but without a lever, which is attached to that part of the body of the animal the movement of which is under investigation. The system is full of air, so that when the membrane attached to the animal is compressed, the membrane which moves the lever is distended and the lever moved. Its end, which carries a scribing point, marks the smoked paper on the rotating cylinder. The pneumatic signal is called by Marey "tamboeur à levier."

References to Chronographic Methods.—(1) Chronographs used in Physiology: Helmholtz, "On Methods of measuring very small Portions of Time," *Phil. Mag.* (1853), 6; Id., *Verhandlungen der physikalisch-medizinischen Gesellschaft in Würzburg* (1872); Harless, "Das Atwood'sche Myographion," *Abhandlungen der k. bayerischen Akademie der Wissenschaften* (1862); Id., *Fall-Myographion aufgestellt in der Wiener Weltausstellung in der Abteilung für das Unterrichtswezen von Ungarn* (Budapest, 1873); Hensen, "Myographion mit vibratorischer Bewegung," *Arbeiten aus dem Kieler physiol. Institut*, (1868); Bricke, *Sitzungsber. d. Wien. Acad.* (1877); Hüger, "Myographion ohne Bewegung," *Untersuchungen über die Physiologie des Electrotomus* (1859); Pouillet, *Compt. rend.* (1844); I. Munk, *Physiologie des Menschen* (for Hüger's cylinder governed by conical pendulum); J. G. M. Kendrick, *Life in Motion* (1892) (for early form of cylinder chronograph by Thomas Young); Stirling, *Outlines of Practical Physiology* (for reaction-time chronographs of F. Galton and Exner). (2) Chronographs used in gun work and for other purposes: Sabine, *Phil. Mag.* (1876); Moisson, *Notice sur la chronographie système Schultz* (Paris, 1875); Paul la Cour, *La Roue phonique* (Copenhagen, 1873); Mach, "Collected Papers on Chronographs," *Nature*, 42, p. 250; C. V. Boys, "Bullets photographed in Flight," *Nature*, 47, p. 413; Pneumatic Tube Co., Paris, "Chronograph," *Nature*, 9, p. 105; G. C. Foster, "Laboratory Chronograph," *Nature*, 13, p. 139; E. S. Holden, "Astronomical Chronograph," *Nature*, 26, p. 368; D'Arsonval, *La Lumière électrique* (1887); Dunn, "The Photo-retardograph," *Journal United States Artillery*, 3, p. 29; E. J. Marey, *La Méthode graphique* (for Deprez accélérographe); Werner Siemens, "Electric Spark Chronograph," *Wied. Ann.* (1845), 66. (F. J. J.-S.)

CHRONOLOGY (Gr. *χρονολογία*, computation of time. *χρόνος*), the science which treats of time, its object being to arrange and exhibit the various events which have occurred in the history of the world in the order of their succession, and to ascertain the intervals of time between them. The term "chronology" is also used of the order in time itself, as adopted, and of the system by which the order is fixed.

The preservation of any record, however rude, of the lapse of time implies some knowledge of the celestial motions, by which alone time can be accurately measured, and some advancement in the arts of civilized life, which could be attained only by the accumulated experience of many generations (see TIME). Before

the invention of letters the memory of past transactions could not be preserved beyond a few years with any tolerable degree of accuracy. Events which greatly affected the physical condition of the human race, or were of a nature to make a deep impression on the minds of the rude inhabitants of the earth, might be vaguely transmitted through several ages by traditional narrative; but intervals of time, expressed by abstract numbers, and these constantly varying besides, would soon escape the memory. The invention of the art of writing afforded the means of substituting precise and permanent records for vague and evanescent tradition; but in the infancy of the world, mankind had learned neither to estimate accurately the duration of time, nor to refer passing events to any fixed epoch.

For these reasons the attempt at an accurate chronology of the early ages of the world is only of recent origin. After political relations began to be established, the necessity of preserving a register of passing seasons and years would soon be felt, and the practice of recording important transactions must have grown up as a necessary consequence of social life. But of these deliberate early records a very small portion only has escaped the ravages of time and barbarism.

The earliest written annals of the Greeks, Etruscans and Romans are irretrievably lost. The traditions of the Druids wished with them. A Chinese emperor has the credit of burning "the books" extant in his day (about 220 B.C.), and of burying alive the scholars who were acquainted with them. And a Spanish adventurer destroyed the picture records which were found in the *pueblo* of Montezuma.

Of the more formal historical writings in which the first ineffectual attempts were made in the direction of systematic chronology we have no knowledge at first-hand. Of Hellanicus, the Greek logographer, who appears to have lived through the greater part of the 5th century B.C., and who drew up a chronological list of the priestesses of Here at Argos; of Ephorus, who lived in the 4th century B.C., and is distinguished as the first Greek who attempted the composition of a universal history; and of Timaeus, who in the following century wrote an elaborate history of Sicily, in which he set the example of using the Olympiads as the basis of chronology, the works have perished and our meagre knowledge of their contents is derived only from fragmentary citations in later writers. The same fate has befallen the works of Berossus and Manetho, Eratosthenes and Apollodorus. Berossus, a priest of Belus living at Babylon in the 3rd century B.C., added to his historical account of Babylonia a chronological list of its kings, which he claimed to have compiled from genuine archives preserved in the temple. Manetho, likewise a priest, living at Sebennytus in Lower Egypt in the 3rd century B.C., wrote in Greek a history of Egypt, with an account of its thirty dynasties of sovereigns, which he professed to have drawn from genuine archives in the keeping of the priests. Of these works fragments only, more or less copious and accurate, have been preserved. Eratosthenes, who in the latter half of the 2nd century B.C. was keeper of the famous Alexandrian library, not only made himself a great name by his important work on geography, but by his treatise entitled *Chronographia*, one of the first attempts to establish an exact scheme of general chronology, earned for himself the title of "father of chronology." His method of procedure, however, was usually conjectural; and guess-work, however careful, acute and plausible, is still guess-work and not testimony. Apollodorus, an Athenian who flourished in the middle of the 2nd century B.C., wrote a metrical chronicle of events, ranging from the supposed period of the fall of Troy to his own day. These writers were followed by other investigators and systematizers in the same field, but their works are lost. Of the principal later writers whose works are extant, and to whom we owe what little knowledge we possess of the labours of their predecessors, mention will be made hereafter.

The absence or incompleteness of authentic records, however, is not the only source of obscurity and confusion in the chronology of remote ages. There can be no exact computation of time or

placing of events without a fixed point or epoch from which the reckoning takes its start. It was long before this was apprehended. When it began to be seen, various epochs were selected by various writers; and at first each small separate community had its own epoch and method of time-reckoning. Thus in one city the reckoning was by succession of kings, in another by archons or annual magistrates, in a third by succession of priests. It seems now surprising that vague counting by generations should so long have prevailed and satisfied the wants of inquiring men, and that so simple, precise and seemingly obvious a plan as counting by years, the largest natural division of time, did not occur to any investigator before Eratosthenes.

Precision, which was at first unattainable for want of an epoch, was afterwards no less unattainable from the multiplicity, and sometimes the variation, of epochs. But by a natural process the mischief was gradually and partially remedied. The extension of intercourse between the various small groups or societies of men, and still more their union in larger groups, made a common epoch necessary, and led to the adoption of such a starting point by each larger group. These leading epochs continued in use for many centuries. The task of the chronologer was thus simplified and reduced to a study and comparison of dates in a few leading systems.

The most important of these systems in what we call ancient times were the Babylonian, the Greek and the Roman. The Jews had no general era, properly so called. In the history of Babylonia, the fixed point from which time was reckoned was the era of Nabonassar, 747 B.C. Among the Greeks the reckoning was by Olympiads, the point of departure being the year in which Coroebus was victor in the Olympic Games, 776 B.C. The Roman chronology started from the foundation of the city, the year of which, however, was variously given by different authors. The most generally adopted was that assigned by Varro, 753 B.C. It is noteworthy how nearly these three great epochs approach each other,—all lying near the middle of the 8th century B.C. But it is to be remembered that the beginning of an era and its adoption and use as such are not the same thing, nor are they necessarily synchronous. Of the three ancient eras above spoken of, the earliest is that of the Olympiads, next that of the foundation of Rome, and the latest the era of Nabonassar. But in order of adoption and actual usage the last is first. It is believed to have been in use from the year of its origin. It is not known when the Romans began to use their era. The Olympiads were not in current use till about the middle of the 3rd century B.C., when Timaeus, as already mentioned, set the example of reckoning by them.

Even after the adoption in Europe of the Christian era, a great variety of methods of dating—national, provincial and ecclesiastical—grew up and prevailed for a long time in different countries, thus renewing in modern times the difficulties experienced in ancient times from diversities of reckoning. An acquaintance with these various methods is indispensable to the student of the charters, chronicles and legal instruments of the middle ages.

In reckoning years from any fixed epoch in constant succession, the number denoting the years is necessarily always on the increase. But rude nations and illiterate people seldom attach any definite idea to large numbers. Hence it has been a practice, very extensively followed, to employ cycles or periods, consisting of a moderate number of years, and to distinguish and reckon the years by their number in the cycle. The Chinese and other nations of Asia reckon, not only the years, but also the months and days, by cycles of sixty. The Saros of the Chaldaeans, the Olympiad of the Greeks, and the Roman Indiction are instances of this mode of reckoning time. Several cycles were formerly known in Europe; but most of them were invented for the purpose of adjusting the solar and lunar divisions of time, and were rather employed in the regulation of the calendar than as chronological eras. They are frequently, however, of very great use in fixing dates that have been otherwise imperfectly expressed, and consequently form important elements of chronology.

(W. L. R. C.)

Modern Results of Archaeological Research.

When Queen Victoria came to the English throne, 4004 B.C. was still accepted, in all sobriety, as the date of the creation of the world. Perhaps no single statement could more vividly emphasize the change in the point of view from which scholars regard the chronology of ancient history than the citation of this indisputable fact. To-day, though Bibles are still printed with the year 4004 B.C. in the margin of the first chapter of Genesis, no scholar would pretend to regard this reference seriously. On the contrary, the scholarship of to-day regards the fifth millennium B.C. as well within the historical period for such nations as the Egyptians and the Babylonians. It has come to be fully accepted that when we use such a phrase as "the age of the world" we are dealing with a period that must be measured not in thousands but in millions of years; and that to the age of man must be allotted a period some hundreds of times as great as the five thousand and odd years allowed by the old chronologists. This changed point of view, needless to say, has not been reached without ardent and even bitter controversy. Yet the transformation is unequivocal; and the revised conception no longer seems to connote the theological implications that were at first ascribed to it. It has now become obvious that the data afforded by the Hebrew writings should never have been regarded as sufficiently accurate for the purpose of exact historical computations: that, in short, no historian working along modern scientific lines could well have made the mistake of supposing that the genealogical lists of the Pentateuch afforded an adequate chronology of world-history. But it should not be forgotten that to many generations of close scholarship these genealogical lists seemed to convey such knowledge in the most precise terms, and that at so recent a date as, for example, the year in which Queen Victoria came to the throne, it was nothing less than a rank heresy to question the historical accuracy and finality of chronologies which had no other source or foundation.

This changed point of view regarding the chronology of history may without hesitation be ascribed to the influence of evidence obtained in a single field of inquiry, the field, namely, of archaeology. No doubt the evidence as to the age of the earth and as to the antiquity of man was gathered by a class of workers not formally included in the ranks of the archaeologist: workers commonly spoken of as palaeontologists, anthropologists, ethnologists and the like. But the distinction scarcely covers a real difference. The scope of the archaeologist's studies must include every department of the ancient history of man as preserved in antiquities of whatever character, be they tumuli along the Baltic, fossil skulls and graven bones from the caves of France, the flint implements, pottery, and mummies of Egypt, tablets and bas-reliefs from Mesopotamia, coins and sculptures of Greece and Rome, or inscriptions, waxen tablets, parchment rolls, and papyri of a relatively late period of classical antiquity. If at one time the monuments of Greece and Rome claimed the almost undisputed attention of the archaeologist, that time has long since passed. For the most important historical records that have come to us in recent decades we have to thank the Orientalist, though the classical explorer has been by no means idle. It will be sufficient here to point out in general terms the import of the message of archaeological discovery in the Victorian Era in its bearings upon the great problems of world-history.

A start was made through the efforts of the palaeontologists and geologists, with only indirect or incidental aid from the archaeologists. The new movement began actively with James Hutton in the later years of the 18th century, and was forwarded by the studies of William Smith in England and of Cuvier in France; but the really efficient champion of the conception that the earth is very old was Sir Charles Lyell, who published the first edition of his epoch-making *Principles of Geology* only a few years before Queen Victoria came to the throne. Lyell demonstrated to the satisfaction, or—perhaps it should rather be said—to the dissatisfaction, of his contemporaries that the story of the geological ages as recorded in the strata of the earth becomes intelligible

only when vast stretches of time are presupposed. Of course the demonstration was not accepted at once. On the contrary, the champions of the tradition that the earth was less than six thousand years old held their ground most tenaciously, and the earlier years of the Victorian era were years of bitter controversy. The result of the contest was never in doubt, however, for the geological evidence, once it had been gathered, was unequivocal; and by about the middle of the century it was pretty generally admitted that the age of the earth must be measured by an utterly different standard from that hitherto in vogue. This concession, however, by no means implied a like change of view regarding the age of man. A fresh volume of evidence required to be gathered, and a new controversy to be waged, before the old data for the creation of man could be abandoned. Lyell again was in the forefront of the progressive movement, and his work on *The Antiquity of Man*, published in 1863, gave currency for the first time to the new opinions. The evidence upon which these opinions were based had been gathered by such anthropologists as Schmerling, Boucher de Perthes and others, and it had to do chiefly with the finding of implements of human construction associated with the remains of extinct animals in the beds of caves, and with the recovery of similar antiquities from alluvial deposits the great age of which was demonstrated by their depth. Every item of the evidence was naturally subjected to the closest scrutiny, but at last the conservatives were forced reluctantly to confess themselves beaten. Their traditional arguments were powerless before the array of data marshalled by the new science of prehistoric archaeology. Looking back even at the short remove of a single generation, it is difficult to appreciate how revolutionary was the conception of the antiquity of man thus inculcated. It rudely shocked the traditional attitude of scholarship towards the history of our race. It disturbed the most cherished traditions and the most sacred themes. It seemed to threaten the very foundations of religion itself. Yet the present generation accepts the antiquity of man as a mere matter of fact. Here, as so often elsewhere, the heresy of an elder day has come to seem almost an axiomatic truth.

If we go back in imagination to the beginning of the Victorian era and ask what was then known of the history of Ancient Egypt, Mesopotamia and Asia Minor, we find ourselves confronted with a startling paucity of knowledge. The key to the mysteries of Egyptian history had indeed been found, thanks to the recent efforts of Thomas Young and Champollion, but the deciphering of inscriptions had not yet progressed far enough to give more than a vague inkling of what was to follow. It remained, then, virtually true, as it had been for two thousand years, that for all that we could learn of the history of the Old Orient in pre-classical days, we must go solely to the pages of the Bible and to a few classical authors, notably Herodotus and Diodorus. A comparatively few pages summed up, in language often vague and mystical, all that the modern world had been permitted to remember of the history of the greatest nations of antiquity. To these nations the classical writers had ascribed a traditional importance, the glamour of which still lighted their names, albeit revealing them in the vague twilight of tradition rather than in the clear light of history. It would have been a bold, not to say a reckless, dreamer who dared predict that any future researches could restore to us the lost knowledge that had been forgotten for more than two millenniums. Yet the Victorian era was scarcely ushered in before the work of rehabilitation began, which was to lead to the most astounding discoveries and to an altogether unprecedented extension of historical knowledge. Early in the 'forties the Frenchman Botta, quickly followed by Sir Henry Layard, began making excavations on the site of ancient Nineveh, the name and fame of which were a tradition having scarcely more than mythical status. The spade of the discoverer soon showed that all the fabled glories of the ancient Assyrian capital were founded on realities, and evidence was afforded of a state of civilization and culture such as few men supposed to have existed on the earth before the Golden Age of Greece. Not merely were artistic sculptures and bas-reliefs

Chronology of ancient history.

found that demonstrated a high development of artistic genius, but great libraries were soon revealed,—books consisting of bricks of various sizes, or of cylinders of the same material, inscribed while in the state of clay with curious characters which became indelible when baking transformed the clay into brick. No one was able to guess, even in the vaguest way, the exact interpretation of these odd characters; but, on the other hand, no one could doubt that they constituted a system of writing, and that the piles of inscribed tablets were veritable books. There were numerous sceptics, however, who did not hesitate to assert that the import of the message so obviously locked in these curious inscriptions must for ever remain an absolute mystery. Here, it was said, were inscriptions written in an unknown character and in a language that for at least two thousand years had been absolutely forgotten. In such circumstances nothing less than a miracle could enable human ingenuity to fathom the secret. Yet the feat pronounced impossible by mid-century scepticism was accomplished by contemporary scholarship, amidst the clamour of opposition and incredulity. Its success contains at once a warning to those doubters who are always crying out that we have reached the limitations of knowledge, and an encouragement and stimulus to would-be explorers of new intellectual realms.

In a few words the manner of the discovery was this. It appears at a glance that the Assyrian written character consists of groups of horizontal, vertical or oblique strokes. The characters thus composed, though so simple as to their basal unit, are appallingly complex in their elaboration. The Assyrians with all their culture, never attained the stage of analysis which demonstrates that only a few fundamental sounds are involved in human speech, and hence that it is possible to express all the niceties of utterance with an alphabet of little more than a score of letters. Halting just short of this analysis, the Assyrian ascribed syllabic values to the characters of his script, and hence, instead of finding twenty odd characters sufficient, he required about five hundred. There was a further complication in that each one of these characters had at least two different phonetic values; and there were other intricacies of usage which, had they been foreknown by inquirers in the middle of the 19th century, might well have made the problem of decipherment seem an utterly hopeless one. Fortunately it chanced that another people, the Persians, had adopted the Assyrian wedge-shaped stroke as the foundation of a written character, but making that analysis of which the Assyrians had fallen short, had borrowed only so many characters as were necessary to represent the alphabetical sounds. This made the problem of deciphering Persian inscriptions a relatively easy one. In point of fact this problem had been partially solved in the early days of the 19th century, thanks to the sagacious guesses of the German philologist Grotefend. Working with some inscriptions from Persepolis which were found to contain references to Darius and Xerxes, Grotefend had established the phonetic values of certain of the Persian characters, and his successors were perfecting the discovery just about the time when the new Assyrian finds were made. It chanced that there existed on the polished surface of a cliff at Behistun in western Persia a tri-lingual inscription which, according to Diodorus, had been made by Queen Semiramis of Nineveh, but which, as is now known, was really the work of King Darius. One of the languages of this inscription was Persian; another, as it now appeared, was Assyrian, the language of the newly discovered books from the libraries of Nineveh. There was reason to suppose that the inscriptions were identical in meaning; and fortunately it proved, when the inscriptions were made accessible to investigation through the efforts of Sir Henry Rawlinson, that the Persian inscription contained a large number of proper names. It was well known that proper names are usually transcribed from one language into another with a tolerably close retention of their original sounds. For example, the Greek names *Ptolemaios* and *Kleopatra* became a part of the Egyptian language and appeared regularly in Egyptian inscriptions after Alexander's general became king of Egypt. Similarly, the Greek names

Kyros, *Dareios* and *Xerxes* were as close an imitation as practicable of the native names of these Persian monarchs. Assuming, then, that the proper names found in the Persian portion of the Behistun inscription occurred also in the Assyrian portion, retaining virtually the same sound in each, a clue to the phonetic values of a large number of the Assyrian characters was obviously at hand. Phonetic values known, Assyrian was found to be a Semitic language cognate to Hebrew.

These clues were followed up by a considerable number of investigators, with Sir Henry Rawlinson in the van. Thanks to their efforts, the new science of Assyriology came into being, and before long the message of the Assyrian books had ceased to be an enigma. Of course this work was not accomplished in a day or in a year, but, considering the difficulties to be overcome, it was carried forward with marvellous expedition. In 1857 the new scholarship was put to a famous test, in which the challenge thrown down by Sir George Cornewall Lewis and Ernest Renan was met by Rawlinson, Hincks, Oppert and Fox Talbot in a conclusive manner. The sceptics had declared that the new science of Assyriology was itself a myth: that the investigators, self-deceived, had in reality only invented a language and read into the Assyrian inscriptions something utterly alien to the minds of the Assyrians themselves. But when a committee of the Royal Asiatic Society, with George Grote at its head, decided that the translations of an Assyrian text made independently by the scholars just named were at once perfectly intelligible and closely in accord with one another, scepticism was silenced, and the new science was admitted to have made good its claims.

Naturally the early investigators did not fathom all the niceties of the language, and the work of grammatical investigation has gone on continuously under the auspices of a constantly growing band of workers. Doubtless much still remains to be done; but the essential thing, from the present standpoint, is that a sufficient knowledge of the Assyrian language has been acquired to ensure trustworthy translations of the cuneiform texts. Meanwhile, the material found by Botta and Layard, and other successors, in the ruins of Nineveh, has been constantly augmented through the efforts of companies of other investigators, and not merely Assyrian, but much earlier Babylonian and Chaldaean texts in the greatest profusion have been brought to the various museums of Europe and America. The study of these different inscriptions has utterly revolutionized our knowledge of Oriental history. Many of the documents are strictly historical in their character, giving full and accurate contemporary accounts of events that occurred some thousands of years ago. Exact dates are fixed for long series of events that previously were quite unknown. Monarchs whose very names had been forgotten are restored to history, and the records of their deeds inscribed under their very eyes are before us,—contemporary documents such as neither Greece nor Rome could boast, nor any other nation, with the single exception of Egypt, until strictly modern times. There are, no doubt, gaps in the record; there are long periods for which the chronology is still uncertain. Naturally there is an increasing vagueness as one recedes farther into the past, and for the earlier history of Chaldaea there is great uncertainty. Nevertheless, the Assyriologist speaks with a good deal of confidence of dates as remote as 3800 B.C., the time ascribed to King Sargon, who was once regarded as a mythical person, but is now known to have been an actual monarch. Indeed, there are tablets in the British Museum labelled 4500 B.C.; and later researches, particularly those of the expedition of the University of Pennsylvania at Nippur, have brought us evidence which, interpreted with the aid of estimates as to the average rate of accumulation of dust deposits, leads to the inference that a high state of civilization had been attained in Mesopotamia at least 9000 years ago.

While the Assyriologists have been making these astonishing revelations, the Egyptologists have not been behindhand. Such scholars as Lepsius, Brugsch, de Rougé, Lenormant, Birch, Mariette, Maspero and Erman have perfected the studies of Young and Champollion; while at the same time these and a considerable company of other explorers, most notable of whom

are Gardner Wilkinson and Professor Flinders Petrie, have brought to light a vast accumulation of new material, much of which has the highest importance from the standpoint of the historian. Lists of kings found on the temple wall at Abydos, in the fragments of the Turin papyrus and elsewhere, have cleared up many doubtful points in the lists of Manetho, and at the same time, as Professor Petrie has pointed out, have proved to us how true a historian that much-discussed writer was. Manetho, it will be recalled, was the Egyptian who wrote the history of Egypt in Greek in the time of the Ptolemies. His work in the original unfortunately perished, and all that we know of it we learn through excerpts made by a few later classical writers. These fragments have until recently, however, given us our only clue to the earlier periods of Egyptian history. Until corroboration was found in the Egyptian inscriptions themselves, not only were Manetho's lists in doubt, but scepticism had been carried to the point of denying that Manetho himself had ever existed. This is only one of many cases where the investigations of the archaeologist have proved not iconoclastic but reconstructive, tending to restore confidence in classical traditions which the scientific historians of the age of Niebuhr and George Cornwall Lewis regarded with scepticism.

As to the exact dates of early Egyptian history there is rather more of vagueness than for the corresponding periods of Mesopotamia. Indeed, approximate accuracy is not attained until we are within sixteen hundred years of our own era; but the sequence of events of a period preceding this by two thousand years is well established, and the recent discoveries of Professor Petrie carry back the record to a period which cannot well be less than five thousand, perhaps not less than six thousand years B.C. Both from Egypt and Mesopotamia, then, the records of the archaeologist have brought us evidence of the existence of a highly developed civilization for a period exceeding by hundreds, perhaps by thousands, of years the term which had hitherto been considered the full period of man's existence.

We may note at once how these new figures disturb the historical balance. If our forerunners of eight or nine thousand years ago were in a noonday glare of civilization, where shall we look for the much-talked-of "dawnings of history"? By this new standard the Romans seem our contemporaries in latter-day civilization; the "Golden Age" of Greece is but of yesterday; the pyramid-builders are only relatively remote. The men who built the temple of Bel at Nippur, in the year (say) 5000 B.C., must have felt themselves at a pinnacle of civilization and culture. As Professor Mahaffy has suggested, the era of the Pyramids may have been the veritable autumn of civilization. Where, then, must we look for its springtime? The answer to that question must come, if it come at all, from what we now speak of as prehistoric archaeology; the monuments from Memphis and Nippur and Nineveh, covering a mere ten thousand years or so, are the records of recent history.

The efforts of the students of Oriental archaeology have been constantly stimulated by the fact that their studies brought them more or less within the field of Bible history. A fair proportion of the workers who have delved so enthusiastically in the fields of Egyptian and Assyrian exploration would never have taken up the work at all but for the hope that their investigations might substantiate the Hebrew records. For a long time this hope proved illusory, and in the case of Egyptian archaeology the results have proved disappointing even up to the very present. Considering the important part played by the Egyptian sojourn of the Hebrews, as narrated in the Scriptures, it was certainly not an over-enthusiastic prediction that the Egyptian monuments when fully investigated would divulge important references to Joseph, to Moses, and to the all-important incidents of the Exodus; but half a century of expectant attention in this direction has led only to disappointment. It would be rash, considering the buried treasures that may yet await the future explorer, to assert that such records as those in question can never come to light. But, considering the fulness of the contemporary Egyptian records of the XIXth dynasty that are already known, it becomes

increasingly doubtful whether the Hebrews in Egypt played so important a part in history, when viewed from the Egyptian standpoint, as their own records had seemed to imply. As the forgotten history of Oriental antiquity has been restored to us, it has come to be understood that, politically speaking, the Hebrews were a relatively insignificant people, whose chief importance from the standpoint of material history was derived from the geographical accident that made them a sort of buffer between the greater nations about them. Only once, and for a brief period, in the reigns of David and Solomon did the Hebrews rise to anything like an equal plane of political importance with their immediate neighbours. What gave them a seeming importance in the eyes of posterity was the fact that the true history of the Egyptians, Mesopotamians, Arabians and Hittites had been well-nigh forgotten. The various literatures of these nations were locked from view for more than two thousand years, while the literature of Israel had not merely been preserved, but had come to be regarded as inspired and sacred among all the cultured nations of the Western world. Now that the lost literatures have been restored to us, the status of the Hebrew writings could not fail to be disturbed. Their very isolation had in some measure accounted for their seeming importance.

All true historical perspective is based upon comparison, and where only a single account has been preserved of any event or of any period of history, it is extremely difficult to judge that account with historical accuracy. An illustration of this truth is furnished in profane history by the account which Thucydides has given us of the Peloponnesian War. For most of the period in question Thucydides is the only source; and despite the inherent merits of a great writer, it can hardly be doubted that the tribute of almost unqualified praise that successive generations of scholars have paid to Thucydides must have been in some measure qualified if, for example, a Spartan account of the Peloponnesian War had been preserved to us. Professor Mahaffy has pointed out that many other events in Greek history are viewed by us in somewhat perverted perspective because the great writers of Greece were Athenians rather than Spartans or Thebans. Even in so important a matter as the great conflict between Persia and Greece it has been suggested more than once that we should be able to gain a much truer view were Persian as well as Greek accounts accessible.

Not many years ago it would have been accounted a heresy to suggest that the historical books of the Old Testament had conveyed to our minds estimates of Oriental history that suffered from this same defect; but to-day no one who is competent to speak with authority pretends to doubt that such is really the fact. Even conservative students of the Bible urge that its historical passages must be viewed precisely in the light of any other historical writings of antiquity; and the fact that the oldest Hebrew manuscript dates only from the 8th century A.D., and therefore of necessity brings to us the message of antiquity through the fallible medium of many generations of copyists, is far more clearly kept in mind than it formerly was. Every belief of mankind is in the last analysis amenable to reason, and finds its origin in evidence that can appeal to the arbitrament of common sense. This evidence may in certain cases consist chiefly of the fact that generations of our predecessors have taken a certain view regarding a certain question; indeed most of our cherished beliefs have this foundation. But when such is the case, mankind has never failed in the long run to vindicate its claim to rationality by showing a readiness to give up the old belief whenever tangible evidence of its fallaciousness was forthcoming. The case of the historical books of the Old Testament furnishes no exception. These had been sacred to almost a hundred generations of men, and it was difficult for the eye of faith to see them as other than absolutely infallible documents. Yet the very eagerness with which the champions of the Hebrew records searched for archaeological proofs of their validity was a tacit confession that even the most unwavering faith was not beyond the reach of external evidence. True, the believer sought corroboration with full faith that he would find it; but the very

Archae-
ology and
Bible
History.

fact that he could think such external corroboration valuable implied, however little he may have realized it, the subconscious concession that he must accept external evidence at its full value, even should it prove contradictory. If, then, an Egyptian inscription of the XIXth dynasty had come to hand in which the names of Joseph and Moses, and the deeds of the Israelites as a subject people who finally escaped from bondage by crossing the Red Sea, were recorded in hieroglyphic characters, such a monument would have been hailed with enthusiastic delight by every champion of the Pentateuch, and a wave of supreme satisfaction would have passed over all Christendom. It is not too much, then, to say that failure to find such a monument has caused deep disappointment to Bible scholars everywhere. It does not follow that faith in the Bible record is shaken, although in some quarters there has been a pronounced tendency to regard the history of the Egyptian sojourn as mythical; yet it cannot be denied that Egyptian records, corroborating at least some phases of the Bible story, would have been a most welcome addition to our knowledge. Some recent finds have, indeed, seemed to make inferential reference to the Hebrews, and the marvellous collection of letters of the XVIIIth dynasty found at Tel el-Amarna—letters to which we shall refer later—have the utmost importance as proving a possible early date for the Mosaic accounts. But such inferences as these are but a vague return for the labour expended, and an almost cruelly inadequate response to seemingly well-founded expectations.

When we turn to the field of Babylonian and Assyrian archaeology, however, the case is very different. Here we have documents in abundance that deal specifically with events more or less referred to in the Bible. The records of kings whose names hitherto were known to us only through Bible references have been found in the ruins of Nineveh and Babylon, and personages hitherto but shadowy now step forth as clearly into the light of history as an Alexander or a Caesar. Moreover, the newly discovered treasures deal with the beliefs of the people as well as with their history proper. The story of the books now spoken of as the "Creation" and "Deluge" tablets of the Assyrians, in the British Museum, which were discovered in the ruins of Nineveh by Layard and by George Smith, has been familiar to every one for a good many years. The acute interest which they excited when George Smith deciphered their contents in 1872 has to some extent abated, but this is only because scholars are now pretty generally agreed as to their bearing on the corresponding parts of Genesis. The particular tablets in question date only from about the 7th century B.C., but it is agreed among Assyriologists that they are copies of older texts current in Babylonia for many centuries before, and it is obvious that the compilers of Genesis had access to the Babylonian stories. In a word, the Hebrew Genesis shows unequivocal evidence of Babylonian origin, but, in the words of Professor Sayce, it is but "a paraphrase and not a translation." However disconcerting such a revelation as this would have been to the theologians of an elder day, the Bible scholars of our own generation are able to regard it with entire composure.

From the standpoint of the historian even greater interest attaches to the records of the Assyrian and Babylonian kings when compared with the historical books of the Old Testament. For some centuries the inhabitants of Palestine were subject to periodical attacks from the warlike inhabitants of Mesopotamia, as even the most casual reader of the Bible is aware. When it became known that the accounts of these invasions formed a part of the records preserved in the Assyrian libraries, historian and theologian alike waited with breathless interest for the exact revelations in store; and this time expectation was not disappointed. As, one after another, the various tablets and cylinders and annalistic tablets have been translated, it has become increasingly clear that here are almost inexhaustible fountains of knowledge, and that sooner or later it may be possible to check the Hebrew accounts of the most important periods of their history with contemporaneous accounts written from another point of view. It is true that the cases are not very numerous where precisely the same event is described from

opposite points of view, but, speaking in general terms rather than of specific incidents, we are already able to subject considerable portions of history to this test. The records of Shalmaneser II., Tiglath-Pileser III. and Sennacherib, kings of Assyria, of Nebuchadrezzar, king of Babylon, and of Cyrus, king of Persia, all contain direct references to Hebrew history. An obelisk of Jehu of Samaria, and graphically depicts the Hebrew captives. Tiglath-Pileser III., a usurper who came to the throne of Assyria in 745 B.C., and whose earlier name of Pul proved a source of confusion to the later Hebrew writers, left records that have served to clear up the puzzling chronology of a considerable period of the history of Samaria. Most interesting of all, perhaps, are the annals of Sennacherib, the destruction of whose hosts by the angel of God is so strikingly depicted in the Book of Kings. The court historian of Sennacherib naturally does not dwell upon this event, but he does tell of an invasion and conquest of Palestine. The Hebrew account of the death of Sennacherib is corroborated by a Babylonian inscription. Here, however, there is an interesting qualification. The account in the Book of Kings is so phrased that one might naturally infer from it that Sennacherib was assassinated by his sons immediately after his return from the disastrous campaign in Palestine; but in point of fact, as it now appears, the Assyrian king survived that campaign by twenty years. One cannot avoid the suspicion that in this instance the Hebrew chronicler purposely phrased his account to convey the impression that Sennacherib's tragic end was but the slightly delayed culmination of the punishment inflicted for his attack upon the "chosen people." On the other hand, the ambiguity may be quite unintentional, for the Hebrew writers were notoriously lacking in the true historical sense, which shows itself in a full appreciation of the value of chronology.

One of the most striking instances of the way in which mistakes of chronology may lead to the perversion of historical records is shown in the Book of Daniel in connexion with the familiar account of the capture of Babylon by Cyrus. Within the past generation records of Cyrus have been brought to light, as well as records of the conquered Babylonian king himself, which show that the Hebrew writers of the later day had a peculiarly befogged impression of a great historical event—their misconception being shared, it may be added, by the Greek historian Herodotus. When the annalistic tablet of Cyrus was translated, it was made to appear, to the consternation of Bible scholars, that the city of Babylon had capitulated to the Persian—or more properly to the Elamite conqueror without a struggle. It appeared, further, that the king ruling in Babylon at the time of the capitulation was named not Belshazzar, but Nabonidos. This king, as appears from his own records, had a son named Belshazzar, who commanded Babylonian armies in outlying provinces, but who never came to the throne. Nothing could well be more disconcerting than such a revelation as this. It is held, however, that the startling discrepancies are not so difficult to explain as may appear at first sight. The explanation is found, so the Assyriologist assures us, in the fact that both Hebrew and Greek historians, writing at a considerable interval after the events, and apparently lacking authentic sources, confused the peaceful occupation of Babylon by Cyrus with its siege and capture by a successor to that monarch, Darius Hystaspes. As to the confusion of Babylonian names—in which, by the way, the Hebrew and Greek authors do not agree—it is explained that the general, Belshazzar, was perhaps more directly known in Palestine than his father the king. But the vagueness of the Hebrew knowledge is further shown by the fact that Belshazzar, alleged king, is announced as the son of Nebuchadrezzar (misspelled Nebuchadrezzar in the Hebrew writings), while the three kings that reigned after Nebuchadrezzar, and before Nabonidos usurped the throne, are quite overlooked.

Our present concern with the archaeological evidence thus briefly outlined, and with much more of the kind, may be summed up in the question: What in general terms is the inference to be drawn by the world-historian from the Assyrian records in their bearings upon the Hebrew writings? At first sight this

might seem an extremely difficult question to answer. Indeed, to answer it to the satisfaction of all concerned might well be pronounced impossible. Yet it would seem as if a candid and impartial historian could not well be greatly in doubt in the matter. On the one hand, the general agreement everywhere between the Hebrew accounts and contemporaneous records from Mesopotamia proves beyond cavil that, broadly speaking, the Bible accounts are historically true, and were written by persons who in the main had access to contemporaneous documents. On the other hand, the discrepancies as to details, the confusion as to exact chronology, the manifest prejudice and partizanship, and the obvious limitations of knowledge make it clear that the writers partook in full measure of the shortcomings of other historians, and that their work must be adjudged by ordinary historical standards. As much as this is perhaps conceded by most, if not all, schools of Bible criticism of to-day. Professor Sayce, one of the most distinguished of modern Assyriologists, writing as an opponent of the purely destructive "Higher Criticism," demands no more than that the Book of Genesis "shall take rank by the side of the other monuments of the past as the record of events which have actually happened and been handed on by credible men"; that it shall, in short, be admitted to be "a collection of ancient documents which have all the value of contemporaneous testimony," but which being in themselves "wrecks of vast literatures which extended over the Oriental world from a remote epoch," cannot be understood aright "except in the light of the contemporaneous literature of which they form a portion." From the point of view implied by such words as these, it is only necessary to recall the mental attitude of our grandfathers to appreciate in some measure the revolution in thought that has been wrought in this field within the last half-century, largely through the instrumentality of Oriental archaeology.

We have seen that the general trend of Oriental archaeology has been reconstructive rather than iconoclastic. Equally true is this of recent classical archaeology. Here no such revolution has been effected as that which virtually created anew the history of Oriental antiquity; yet the bearings of the new knowledge are similar in kind if different in degree. The world had never quite forgotten the history of the primitive Greeks as it had forgotten the Mesopotamians, the Himyaritic nations and the Hittites; but it remembered their deeds only in the form of poetical myths and traditions. These traditions, finding their clearest delineation in the lines of Homer, had been subjected to the analysis of the critical historians of the early decades of the 19th century, and their authenticity had come to be more than doubted. The philological analysis of Wolf and his successors had raised doubts as to the very existence of Homer, and at one time the main current of scholarly opinion had set strongly in the direction of the belief that the *Iliad* and the *Odyssey* were in reality but latter-day collections of divers recitals that had been handed down by word of mouth from one generation to another of bards through ages of illiteracy. It was strenuously contended that the case could not well be otherwise, inasmuch as the art of writing must have been quite unknown in Greece until after the alleged age of the traditional Homer, whose date had been variously estimated at from 1000 to 800 B.C. by less sceptical generations. It had come to be a current belief that the *Iliad* was first committed to writing in the age of Peisistratus. A prominent controversialist, F. A. Paley, even went so far as to doubt whether a single written copy of the *Iliad* existed in Greece at the time of the Peloponnesian War. The doubts thus cast upon the age when the Homeric poems first assumed the fixed form of writing were closely associated with the universal scepticism as to the historical accuracy of any traditions whatever regarding the early history of Greece. Cautious historians had come to regard the so-called "Heroic Age" as a prehistoric period regarding which nothing definite was known, or in all probability could be known. It was ably argued by Sir George Cornewall Lewis, in connexion with his inquiries into early Roman history, that a verbal tradition is not transmitted from one

generation to another in anything like an authentic form for a longer period than about a century. If, then, the art of writing was unknown in Greece before, let us say, the 6th century B.C., it would be useless to expect that any events of Grecian history prior to about the 7th century B.C. could have been transmitted to posterity with any degree of historical accuracy.

Notwithstanding the allurements of the subject, such conservative historians as Grote were disposed to regard the problems of early Grecian history as inscrutable, and to content themselves with the recital of traditions without attempting to establish their relationship with actual facts. It remained for the more robust faith of a Schliemann to show that such scepticism was all too faint-hearted, by proving that at such sites as Tiryns, Mycenae and Hissarlik evidences of a very early period of Greek civilization awaited the spade of the excavator. Thanks to the enthusiasm of Schliemann and his successors, we can now substitute for the mythical "Age of Heroes" a historical "Mycenaean Age" of Greece, and give tangible proof of its relatively high state of civilization. Schliemann may or may not have been correct in identifying one of the seven cities that he unearthed at Hissarlik as the fabled Troy itself, but at least his efforts sufficed to give verisimilitude to the Homeric story. With the lessons of recent Oriental archaeology in mind, few will be sceptical enough to doubt that some such contest as that described in the *Iliad* actually occurred. And now, thanks to the efforts of a large company of workers, notably Dr Arthur Evans and his associates in Cretan exploration, we are coming to speak with some confidence not merely of a Mycenaean but of a pre-Mycenaean Age.

As yet we see these periods somewhat darkly. The illuminative witness of written records is in the main denied us here. Some most archaic inscriptions have been indeed found by the explorers in Crete, but these for the present serve scarcely any other purpose than to prove the antiquity of the art of writing among a people who were closely in touch with the inhabitants of Hellas proper. Most unfortunately for posterity, the Greeks wrote mainly on perishable materials, and hence the chief records even of their later civilization have vanished. The only fragments of Greek manuscripts antedating the Christian era that have been preserved to us have been found in Egypt, where a hospitable climate granted them a term of existence not to be hoped for elsewhere. No fragment of these papyri, indeed, carries us further back than the age of the Ptolemies; but the Greek inscriptions on the statues of Rameses II. at Abu-Simbel, in Nubia, give conclusive proof that the art of writing was widely disseminated among the Greeks at least three centuries before the age of Alexander. This carries us back towards the traditional age of Homer.

The Cretan inscriptions belong to a far older epoch, and are written in two non-Grecian scripts of undetermined affinities. Here, then, is direct evidence that the Aegean peoples of the Mycenaean Age knew how to write, and it is no longer necessary to assume that the verses of the *Iliad* were dependent on mere verbal transmission for any such period as has been supposed.

But even were direct evidence of the knowledge of the art of writing in Greece of the early day altogether lacking, none but the hardiest sceptic could doubt, in the light of recent archaeological discoveries elsewhere, that the inhabitants of ancient Hellas of the "Homeric Age" must have shared with their contemporaries the capacity to record their thought in written words. We have seen that Oriental archaeology has in recent generations revolutionized our conceptions of the antiquity of civilization. We have seen that written documents have been preserved in Mesopotamia to which such a date as 4500 B.C. may be ascribed with a good deal of confidence; and that from the third millennium B.C. a flood of contemporary literary records comes to us both from Egypt and Mesopotamia. But until recently it had been supposed that Hellas was shut out entirely from this Oriental culture. Historians have found it hard to dispel the idea that civilization in Greece was a very late development, and that the culture of the age of Solon sprang, in fact, suddenly into existence, as it seems to do in the records of the

historian. But the excavations that have given us a knowledge of the Mycenaean Age have proved conclusively, not alone that civilization existed in Greece in an early day, but that this civilization was closely linked with the civilization of Egypt. Not only have antiquities been found in Crete that point to Egyptian inspiration, but quite recently Professor Petrie has found at Tel el-Amarna Mycenaean pottery. The latter find has a peculiar significance, since the date of the Tel el-Amarna collection is definitely fixed between the years 1400 and 1370 B.C.

It is demonstrated, then, that as early as the beginning of the 14th century B.C. the Mycenaean civilization was in touch with the ancient civilization of Egypt. One must not infer from this, however, that the two civilizations met on anything like an equality. Indeed, in the wonderful Tel-el-Amarna collection there is a suggestive absence of literary documents from the Aegean that demands a word of notice. The Tel el-Amarna collection, it will be recalled, consists of the royal archives of King Amenophis IV. of the XVIIIth Egyptian dynasty, who in the latter years of his reign chose to be known as Akhenaton, "the glory of the solar disk." This monarch had retired from Thebes and established his court on the site now known as Tel el-Amarna, where he founded the city which existed only during the brief period of thirty years ending with the death of the monarch about 1370 B.C. The date of the documents found in the royal library is, therefore, fixed within very narrow limits. The documents in question consist chiefly of letters, and constitute one of the most important of archaeological finds. These letters came to the king from almost every part of western Asia, including Palestine and Phoenicia, Babylonia and Asia Minor. Strangely enough, all the letters are written in the Babylonian character, and most of them are in the Babylonian language. They afford, therefore, most striking evidence of a widespread diffusion of Babylonian culture. Incidentally they prove, to the utter confusion of a certain school of Bible critics, that the art of writing was familiarly known in Canaan, and that Egypt and western Asia were in full literary connexion with one another, long before the time of the Exodus. Hence all the elaborate arguments based on the supposition that Moses probably could not write fall to the ground. On the other hand, the absence of letters from Mycenae among the tablets of Tel el-Amarna must be regarded as at least suggestive. Seemingly the widespread Babylonian culture had not reached the Aegean peoples; yet these peoples cannot have been wholly ignorant of things with which commercial intercourse brought them in contact. The point is of no very great significance, however, since no one has pretended that the Western civilization compared with the Eastern in point of antiquity; and in any event, no amount of negative evidence weighs a grain in the balance against the positive evidence of the Cretan inscriptions.

The researches of the archaeologist are, in short, tending to reconstruct the primitive classical history; and here, as in the Orient, it is evident that historians of the earlier day were constantly blinded by a misconception as to the antiquity of civilization. Such a fruitage as that of Greek culture of the age of Pericles does not come to maturity without a long period of preparation. Here, as elsewhere, the laws of evolution hold, permitting no sudden stupendous leaps. But it required the arduous labours of the archaeologist to prove a proposition that, once proven, seems self-evident.

(H. S. W.)

Eras and Periods.

In the article *Calendar (q.v.)*, that part of chronology is treated which relates to the measurement of time, and the principal methods are explained that have been employed, or are still in use, for adjusting the lunar months of the solar year, as well as the intercalations necessary for regulating the civil year according to the celestial motions. But it is necessary to notice here the different *Eras* and *Periods* that have been employed by historians, and by the different nations of the world, in recording the succession of time and events, to fix the epochs at which the eras respectively commenced, to ascertain the form and the initial day of the year made use of, and to establish their correspondence

with the years of the Christian era. These elements will enable us to convert, by a simple arithmetical operation, any historical date, of which the chronological characters are given according to any era whatever, into the corresponding date in the Christian era.

Julian Period.—Although the Julian period (the invention of Joseph Scaliger, in 1582) is not, properly speaking, a chronological era, yet, on account of its affording considerable facilities in the comparison of different eras with one another, and in marking without ambiguity the years before Christ, it is very generally employed by chronologers. It consists of 7980 Julian years; and the first year of the Christian era corresponded with the year 4714 of the Julian period.

Olympiads.—The Olympic games, so famous in Greek history, were celebrated once every four years, between the new and full moon first following the summer solstice, on the small plain named Olympia in Elis, which was bounded on one side by the river Alpheus, on another by the small tributary stream the Cladeus, and on the other two sides by mountains. The games lasted five days. Their origin, lost in the dimness of remote antiquity, was invested by priestly legends with a sacred character. They were said to have been instituted by the Idæan Heracles, to commemorate his victory over his four brothers in a foot-race. According to a tradition, possibly more authentic, they were re-established by Iphitus, king of Elis, in concert with the Spartan Lycurgus and Cleosthenes of Pisa. The practice was long afterwards adopted of designating the Olympiad, or period of four years, by the name of the victor in the contests of the stadium, and of inscribing his name in the gymnasium of Olympia. The first who received this honour was Coroebus. The games in which Coroebus was victor, and which form the principal epoch of Greek history, were celebrated about the time of the summer solstice 776 years before the common era of the Incarnation, in the 3938th year of the Julian period, and twenty-three years, according to the account of Varro, before the foundation of Rome.

Before the introduction of the Metonic cycle, the Olympic year began sometimes with the full moon which followed, at other times with that which preceded the summer solstice, because the year sometimes contained 384 days instead of 354. But subsequently to its adoption, the year always commenced with the eleventh day of the moon which followed the solstice. In order to avoid troublesome computations, which it would be necessary to recommence for every year, and of which the results differ only by a few days, chronologers generally regard the 1st of July as the commencement of the Olympic year. Some authors, however, among whom are Eusebius, Jerome and the historian Socrates, place its commencement at the 1st of September; these, however, appear to have confounded the Olympic year with the civil year of the Greeks, or the era of the Seleucidae.

It is material to observe, that as the Olympic years and periods begin with the 1st of July, the first six months of a year of our era correspond to one Olympic year, and the last six months to another. Thus, when it is said that the first year of the Incarnation corresponds to the first of the 195th Olympiad, we are to understand that it is only with respect to the last six months of that year that the correspondence takes place. The first six months belonged to the fourth year of the 194th Olympiad. In referring dates expressed by Olympiads to our era, or the contrary, we must therefore distinguish two cases.

1st. When the event in question happened between the 1st of January and the 1st of the following July, the sum of the Olympic year and of the year before Christ is always equal to 776. The year of the era, therefore, will be found by subtracting the number of the Olympic year from 776. For example, Varro refers the foundation of Rome to the 21st of April of the third year of the sixth Olympiad, and it is required to find the year before our era. Since five Olympic periods have elapsed, the third year of the sixth Olympiad is $5 \times 4 + 3 = 23$; therefore, subtracting 23 from 776, we have 753, which is the year before Christ to which the foundation of Rome is referred by Varro.

2nd. When the event took place between the summer solstice and the 1st of January following, the sum of the Olympic year and of the year before Christ is equal to 777. The difference, therefore, between 777 and the year in one of the dates will give the year in the other date. Thus, the moon was eclipsed on the 27th of August, a little before midnight, in the year 413 before our era; and it is required

to find the corresponding year in the Olympic era. Subtract 413 from 777, the remainder is 364; and 364 divided by four gives 91 without a remainder; consequently the eclipse happened in the fourth year of the ninety-first Olympiad, which is the date to which it is referred by Thucydides.

If the year is after Christ, and the event took place in one of the first six months of the Olympic year, that is to say, between July and January, we must subtract 776 from the number of the Olympic year to find the corresponding year of our era; but if it took place in one of the last six months of the Olympic year, or between January and July, we must deduct 777. The computation by Olympiads seldom occurs in historical records after the middle of the 5th century of our era.

The names of the months were different in the different Grecian states. The Attic months, of which we possess the most certain knowledge, were named as follows:—

Hecatombaeon.	Gamelion.
Metageitnion.	Anthesterion.
Boëdromiön.	Elaphebolion.
Pyanepsion.	Munychion.
Maemacterion.	Thargelion.
Poseideon.	Scirophorion.

Era of the Foundation of Rome.—After the Olympiads, the era most frequently met with in ancient history is that of the foundation of Rome, which is the chronological epoch adopted by all the Roman historians. There are various opinions respecting the year of the foundation of Rome. (1) Fabius Pictor places it in the latter half of the first year of the eighth Olympiad, which corresponds with the 3967th of the Julian period, and with the year 747 B.C. (2) Polybius places it in the second year of the seventh Olympiad, corresponding with 3964 of the Julian period, and 750 B.C. (3) M. Porcius Cato places it in the first year of the seventh Olympiad, that is, in 3963 of the Julian period, and 751 B.C. (4) Verrius Flaccus places it in the fourth year of the sixth Olympiad, that is, in the year 3962 of the Julian period, and 752 B.C. (5) Terentius Varro places it in the third year of the sixth Olympiad, that is, in the year 3961 of the Julian period, and 753 B.C. A knowledge of these different computations is necessary, in order to reconcile the Roman historians with one another, and even any one writer with himself. Livy in general adheres to the epoch of Cato, though he sometimes follows that of Fabius Pictor. Cicero follows the account of Varro, which is also in general adopted by Pliny. Dionysius of Halicarnassus follows Cato. Modern chronologers for the most part adopt the account of Varro, which is supported by a passage in Censorinus, where it is stated that the 991st year of Rome commenced with the festival of the Palilia, in the consulship of Ulpian and Pontianus. Now this consulship corresponded with the 238th year of our era; therefore, deducting 238 from 991, we have 753 to denote the year before Christ. The Palilia commenced on the 21st of April; and all the accounts agree in regarding that day as the epoch of the foundation of Rome.

The Romans employed two sorts of years, the civil year, which was used in the transaction of public and private affairs, and the consular year, according to which the annals of their history have been composed. The civil year commenced with the calends of January, but this did not hold a fixed place in the solar year till the time of Julius Caesar (see CALENDAR). The installation of the consuls regulated the commencement of the consular year. The initial day of the consulate was never fixed, at least before the 7th century of Rome, but varied with the different accidents which in times of political commotion so frequently occurred to accelerate or retard the elections. Hence it happens that a consular year, generally speaking, comprehends a part not only of two Julian years, but also of two civil years. The consulate is the date employed by the Latin historians generally, and by many of the Greeks, down to the 6th century of our era.

In the era of Rome the commencement of the year is placed at the 21st of April; an event therefore which happened in the months of January, February, March, or during the first twenty days of April, in the year (for example) 500 of Rome, belongs to the civil year 501. Before the time of the Decemvirs, however, February was the last month of the year. Many authors confound the year of Rome with the civil year, supposing them both to begin on the 1st of January. Others again confound both the year of Rome and the civil year with the Julian year, which in fact became the civil year after the regulation of the calendar by Julius Caesar. Through a like want of attention, many writers also, particularly among the moderns, have confounded the Julian and Olympic years, by making an entire Julian year correspond to an entire Olympic year, as if both had commenced at the same epoch. Much attention to these particulars is required in the comparison of ancient dates.

The Christian Era.—The Christian or vulgar era, called also the era of the Incarnation, is now almost universally employed in Christian countries, and is even used by some Eastern nations. Its epoch or beginning is the 1st of January in the fourth year of the 194th Olympiad, the 753rd from the foundation of Rome, and the 4714th of the Julian period. This epoch was introduced in Italy in the 6th century, by Dionysius the Little, a Roman abbot, and began to be used in Gaul in the 8th, though it was not generally followed in that country till a century later. From extant charters it is known to have been in use in England before the close of the 8th century. Before its adoption the usual practice in Latin countries was to distinguish the years by their number in the cycle of Indiction.

In the Christian era the years are simply distinguished by the cardinal numbers; those before Christ being marked B.C. (Before Christ), or A.C. (Ante Christum), and those after Christ A.D. (Anno Domini). This method of reckoning time is more convenient than those which employ cycles or periods of any length whatever; but it still fails to satisfy in the simplest manner possible all the conditions that are necessary for registering the succession of events. For, since the commencement of the era is placed at an intermediate period of history, we are compelled to resort to a double manner of reckoning, backward as well as forward. Some ambiguity is also occasioned by the want of uniformity in the method of numbering the preceding years. Astronomers denote the year which preceded the first of our era by 0, and the year previous to that by 1 B.C.; but chronologers, in conformity with common notions, call the year preceding the era 1 B.C., the previous year 2 B.C., and so on. By reckoning in this manner, there is an interruption in the regular succession of the numbers; and in the years preceding the era, the leap years, instead of falling on the fourth, eighth, twelfth, &c., fall, or ought to fall, on the first, fifth, ninth, &c.

In the chronicles of the middle ages much uncertainty frequently arises respecting dates on account of the different epochs assumed for the beginning of the Christian year. Dionysius, the author of the era, adopted the day of the Annunciation, or the 25th of March, which preceded the birth of Christ by nine months, as the commencement of the first year of the era. This epoch therefore precedes that of the vulgar era by nine months and seven days. This manner of dating was followed in some of the Italian states, and continued to be used at Pisa even down to the year 1745. It was also adopted in some of the Papal bulls; and there are proofs of its having been employed in France about the middle of the 11th century. Some chroniclers, who adhere to the day of the Annunciation as the commencement of the year, reckon from the 25th of March following our epoch, as the Florentines in the 10th century. Gregory of Tours, and some writers of the 6th and 7th centuries, make the year begin sometimes with the 1st of March, and sometimes with the 1st of January. In France, under the third race of kings, it was usual to begin the year with Easter; and this practice continued at least till the middle of the 16th century, for an edict was issued by Charles IX. in the month of January 1663, ordaining that the beginning of the year should thenceforth be considered as taking place on the 1st of January. An instance is given, in *L'Art de vérifier les dates*, of a date in which the year is reckoned from the 18th of March; but it is probable that this refers to the astronomical year, and that the 18th of March was taken for the day of the vernal equinox. In Germany, about the 11th century, it was usual to begin the year at Christmas; and this practice also prevailed at Milan, Rome and other Italian cities, in the 13th, 14th and 15th centuries.

In England, the practice of placing the beginning of the year at Christmas was introduced in the 7th century, and traces of it are found even in the 13th. Gervase of Canterbury, who lived in the 13th century, mentions that almost all writers of his country agreed in regarding Christmas day as the first of the year, because it forms, as it were, the term at which the sun finishes and recommences his annual course. In the 12th century, however, the custom of beginning the civil year with the day of the Annunciation, or the 25th of March, began to prevail, and

continued to be generally followed from that time till the reformation of the calendar in 1752. The historical year has always been reckoned by English authors to begin with the 1st of January. The liturgic year of the Church of England commences with the first Sunday of Advent.

A knowledge of the different epochs which have been chosen for the commencement of the year in different countries is indispensably necessary to the right interpretation of ancient chronicles, charters and other documents in which the dates often appear contradictory. We may cite an example or two. It is well known that Charles the Great was crowned emperor at Rome on Christmas day in the year 800, and that he died in the year 814, according to our present manner of reckoning. But in the annals of Metz and Moissac, the coronation is stated to have taken place in the year 801, and his death in 813. In the first case the annalist supposes the year to begin with Christmas, and accordingly reckons the 25th of December and all the following days of that month to belong to 801, whereas in the common reckoning they would be referred to the year 800. In the second case the year has been supposed to begin with the 25th of March, or perhaps with Easter; consequently the first three months of the year 814, reckoning from the 1st of January, would be referred to the end of the year 813. The English Revolution is popularly called the Revolution of 1688. Had the year then begun, as it now does, with the 1st of January, it would have been the revolution of 1689, William and Mary being received as king and queen in February in the year 1689; but at that time the year was considered in England as beginning on the 25th of March. Another circumstance to which it is often necessary to pay attention in the comparison of dates, is the alteration of style which took place on the adoption of the Gregorian Calendar (see CALENDAR).

Era of the Creation of the World.—As the Greek and Roman methods of computing time were connected with certain pagan rites and observances which the Christians held in abhorrence, the latter began at an early period to imitate the Jews in reckoning their years from the supposed period of the creation of the world. Various computations were made at different times, from Biblical sources, as to the age of the world; and Des Vignoles, in the preface to his *Chronology of Sacred History*, asserts that he collected upwards of two hundred different calculations, the shortest of which reckons only 3483 years between the creation of the world and the commencement of the vulgar era and the longest 6984. The so-called era of the creation of the world is therefore a purely conventional and arbitrary epoch; practically, it means the year 4004 B.C.,—this being the date which, under the sanction of Archbishop Usher's opinion, won its way, among its hundreds of competitors, into general acceptance.

Jewish Year and Eras.—Before the departure of the Israelites from Egypt their year commenced at the autumnal equinox; but in order to solemnize the memory of their deliverance, the month of *Nisan* or *Abib*, in which that event took place, and which falls about the time of the vernal equinox, was afterwards regarded as the beginning of the ecclesiastical or legal year. In civil affairs, and in the regulation of the jubilees and sabbatical years, the Jews still adhere to the ancient year, which begins with the month *Tisri*, about the time of the autumnal equinox.

After their dispersion the Jews were constrained to have recourse to the astronomical rules and cycles of the more enlightened heathen, in order that their religious festivals might be observed on the same days in all the countries through which they were scattered. For this purpose they adopted a cycle of eighty-four years, which is mentioned by several of the ancient fathers of the church, and which the early Christians borrowed from them for the regulation of Easter. This cycle seems to be neither more nor less than the Calippic period of seventy-six years, with the addition of a Greek octaeteris, or period of eight years, in order to disguise its true source, and give it an appearance of originality. In fact, the period of Calippus containing 27,759 days, and the octaeteris 2922 days, the sum, which is 30,681, is exactly the number of days in eighty-four Julian years. But the addition was very far from being an improvement on the

work of Calippus; for instead of a difference of only five hours and fifty-three minutes between the places of the sun and moon, which was the whole error of the Calippic period, this difference, in the period of eighty-four years, amounted to one day, six hours and forty-one minutes. Buccherius places the beginning of this cycle in the year 162 B.C.; Prideaux in the year 291 B.C. According to the account of Prideaux, the fifth cycle must have begun in the year 46 of our era; and it was in this year, according to St Prosperus, that the Christians began to employ the Jewish cycle of eighty-four years, which they followed, though not uniformly, for the regulation of Easter, till the time of the Council of Nice.

Soon after the Nicene council, the Jews, in imitation of the Christians, abandoned the cycle of eighty-four years, and adopted that of Meton, by which their lunisolar year is regulated at the present day. This improvement was first proposed by Rabbi Samuel, rector of the Jewish school of Sora in Mesopotamia, and was finally accomplished in the year 360 of our era by Rabbi Hillel, who introduced that form of the year which the Jews at present follow, and which, they say, is to endure till the coming of the Messiah.

Till the 15th century the Jews usually followed the era of the Seleucidae or of Contracts. Since that time they have generally employed a mundane era, and dated from the creation of the world, which, according to their computation, took place 3760 years and about three months before the beginning of our era. No rule can be given for determining with certainty the day on which any given Jewish year begins without entering into the minutiae of their irregular and complicated calendar.

Era of Constantinople.—This era, which is still used in the Greek Church, and was followed by the Russians till the time of Peter the Great, dates from the creation of the world. The Incarnation falls in the year 5509, and corresponds, as in our era, with the fourth year of the 194th Olympiad. The civil year commences with the 1st of September; the ecclesiastical year sometimes with the 21st of March, sometimes with the 1st of April. It is not certain whether the year was considered at Constantinople as beginning with September before the separation of the Eastern and Western empires.

At the commencement of our era there had elapsed 5508 years and four months of the era of Constantinople. Hence the first eight months of the Christian year 1 coincide with the Constantinopolitan year 5509, while the last four months belong to the year 5510. In order, therefore, to find the year of Christ corresponding to any given year in the era of Constantinople, we have the following rule: If the event took place between the 1st of January and the end of August subtract 5508 from the given year; but if it happened between the 1st of September and the end of the year, subtract 5509.

Era of Alexandria.—The chronological computation of Julius Africanus was adopted by the Christians of Alexandria, who accordingly reckoned 5500 years from the creation of Adam to the birth of Christ. But in reducing Alexandrian dates to the common era it must be observed that Julius Africanus placed the epoch of the Incarnation three years earlier than it is placed in the usual reckoning, so that the initial day of the Christian era fell in the year 5503 of the Alexandrian era. This correspondence, however, continued only from the introduction of the era till the accession of Diocletian, when an alteration was made by dropping ten years in the Alexandrian account. Diocletian ascended the imperial throne in the year of Christ 284. According to the Alexandrian computation, this was the year 5787 of the world, and 287 of the Incarnation; but on this occasion ten years were omitted, and that year was thenceforth called the year 5777 of the world, and 277 of the Incarnation. There are, consequently, two distinct eras of Alexandria, the one being used before and the other after the accession of Diocletian. It is not known for what reason the alteration was made; but it is conjectured that it was for the purpose of causing a new revolution of the cycle of nineteen years (which was introduced into the ecclesiastical computation about this time by Anatolius, bishop of Hierapolis) to begin with the first year of the reign of Diocletian. In fact, 5777 being divided by 19 leaves 1 for the year of the cycle. The Alexandrian

era continued to be followed by the Copts in the 15th century, and is said to be still used in Abyssinia.

Dates expressed according to this era are reduced to the common era by subtracting 5502, up to the Alexandrian year 5786 inclusive, and after that year by subtracting 5492; but if the date belongs to one of the four last months of the Christian year, we must subtract 5503 till the year 5786, and 5493 after that year.

Mundane Era of Antioch.—The chronological reckoning of Julius Africanus formed also the basis of the era of Antioch, which was adopted by the Christians of Syria, at the instance of Panodorus, an Egyptian monk, who flourished about the beginning of the 4th century. Panodorus struck off ten years from the account of Julius Africanus with regard to the years of the world, and he placed the Incarnation three years later, referring it to the fourth year of the 194th Olympiad, as in the common era. Hence the era of Antioch differed from the original era of Alexandria by ten years; but after the alteration of the latter at the accession of Diocletian, the two eras coincided. In reckoning from the Incarnation, however, there is a difference of seven years, that epoch being placed, in the reformed era of Alexandria, seven years later than in the mundane era of Antioch or in the Christian era.

As the Syrian year began in autumn, the year of Christ corresponding to any year in the mundane era of Antioch is found by subtracting 5492 or 5493 according as the event falls between January and September or from September to January.

Era of Nabonassar.—This era is famous in astronomy, having been generally followed by Hipparchus and Ptolemy. It is believed to have been in use from the very time of its origin; for the observations of eclipses which were collected in Chaldaea by Callisthenes, the general of Alexander, and transmitted by him to Aristotle, were for the greater part referred to the beginning of the reign of Nabonassar, founder of the kingdom of the Babylonians. It is the basis of the famous Canon of kings, also called Mathematical Canon, preserved to us in the works of Ptolemy, which, before the astonishing discoveries at Nineveh, was the sole authentic monument of Assyrian and Babylonian history known to us. The epoch from which it is reckoned is precisely determined by numerous celestial phenomena recorded by Ptolemy, and corresponds to Wednesday at mid-day, the 26th of February of the year 747 before Christ. The year was in all respects the same as the ancient Egyptian year. On account of the difference in the length of the Julian and Babylonian years, the conversion of dates according to the era of Nabonassar into years before Christ is attended with considerable trouble. The surest way is to follow a comparative table. Frequently the year cannot be fixed with certainty, unless we know also the month and the day.

The Greeks of Alexandria formerly employed the era of Nabonassar, with a year of 365 days; but soon after the reformation of the calendar of Julius Caesar, they adopted, like other Roman provincials, the Julian intercalation. At this time the first of Thoth had receded to the 29th of August. In the year 136 of our era, the first of Thoth in the ancient Egyptian year corresponded with the 20th of July, between which and the 29th of August there are forty days. The adoption of the Julian year must therefore have taken place about 160 years before the year 136 of our era (the difference between the Egyptian and Julian years being one day in four years), that is to say, about the year 25 B.C. In fact, the first of Thoth corresponded with the 29th of August in the Julian calendar, in the years 25, 24, 23 and 22 B.C.

Era of the Seleucidae, or Macedonian Era.—The era of the Seleucidae dates from the time of the occupation of Babylon by Seleucus Nicator, 311 years before Christ, in the year of Rome 442, and twelve years after the death of Alexander the Great. It was adopted not only in the monarchy of the Seleucidae but in general in all the Greek countries bordering on the Levant, was followed by the Jews till the 15th century, and is said to be used by some Arabians even at the present day. By the Jews it was called the *Era of Contracts*, because the Syrian

governors compelled them to make use of it in civil contracts; the writers of the books of Maccabees call it the *Era of Kings*. But notwithstanding its general prevalence in the East for many centuries, authors using it differ much with regard to their manner of expressing dates, in consequence of the different epochs adopted for the beginning of the year. Among the Syrian Greeks the year began with the month Elul, which corresponds to our September. The Nestorians and Jacobites at the present day suppose it to begin with the following month, or October. The author of the first book of Maccabees makes the era commence with the month Nisan, or April; and the author of the second book with the first Tishrin, or October. Albategni, a celebrated Arabian astronomer, dates from the 1st of October. Some of the Arabian writers, as Alfergani, date from the 1st of September. At Tyre the year was counted from the 19th of our October, at Gaza from the 28th of the same month, and at Damascus from the vernal equinox. These discrepancies render it extremely difficult to determine the exact correspondence of Macedonian dates with those of other eras; and the difficulty is rendered still greater by the want of uniformity in respect of the length of the year. Some authors who follow the Macedonian era, use the Egyptian or vague year of 365 days; Albategni adopts the Julian year of 365½ days.

According to the computation most generally followed, the year 312 of the era of the Seleucidae began on the 1st of September in the Julian year preceding the first of our era. Hence, to reduce a Macedonian date to the common era, subtract 311 years and four months.

The names of the Syrian and Macedonian months, and their correspondence with the Roman months, are as follows:—

Syrian.	Macedonian.	English.
Elul.	Gorpiaeus.	September.
Tishrin I.	Hyperberetaeus.	October.
Tishrin II.	Dius.	November.
Canun I.	Apellaeus.	December.
Canun II.	Audynacus.	January.
Sabat.	Peritius.	February.
Adar.	Dystrus.	March.
Nisan.	Xanthicus.	April.
Ayar.	Artemisius.	May.
Haziran.	Daesius.	June.
Tamus.	Panemus.	July.
Ab.	Loüs.	August.

Era of Alexander.—Some of the Greek historians have assumed as a chronological epoch the death of Alexander the Great, in the year 325 B.C. The form of the year is the same as in the preceding era. This era has not been much followed; but it requires to be noticed in order that it may not be confounded with the era of the Seleucidae.

Era of Tyre.—The era of Tyre is reckoned from the 19th of October, or the beginning of the Macedonian month Hyperberetaeus, in the year 126 B.C. In order, therefore, to reduce it to the common era, subtract 125; and when the date is B.C., subtract it from 126. Dates expressed according to this era occur only on a few medals, and in the acts of certain councils.

Caesarean Era of Antioch.—This era was established to commemorate the victory obtained by Julius Caesar on the plains of Pharsalia, on the 9th of August in the year 48 B.C., and the 706th of Rome. The Syrians computed it from their month Tishrin I.; but the Greeks threw it back to the month Gorpiaeus of the preceding year. Hence there is a difference of eleven months between the epochs assumed by the Syrians and the Greeks. According to the computation of the Greeks, the 49th year of the Caesarean era began in the autumn of the year preceding the commencement of the Christian era; and, according to the Syrians, the 49th year began in the autumn of the first year of the Incarnation. It is followed by Evagrius in his *Ecclesiastical History*.

Julian Era.—The Julian era begins with the 1st of January, forty-five years B.C. It was designed to commemorate the reformation of the Roman calendar by Julius Caesar.

Era of Spain, or of the Caesars.—The conquest of Spain by Augustus, which was completed in the thirty-ninth year B.C., gave rise to this era, which began with the first day of the following

year, and was long used in Spain and Portugal, and generally in all the Roman provinces subdued by the Visigoths, both in Africa and the South of France. Several of the councils of Carthage, and also that of Arles, are dated according to this era. After the 9th century it became usual to join with it in public acts the year of the Incarnation. It was followed in Catalonia till the year 1180, in the kingdom of Aragon till 1350, in Valencia till 1358, and in Castile till 1382. In Portugal it is said to have been in use so late as the year 1415, or 1422, though it would seem that after the establishment of the Portuguese monarchy, no other era was used in the public acts of that country than that of the Incarnation. As the era of Spain began with the 1st of January, and the months and days of the year are those of the Julian calendar, any date is reduced to the common era by subtracting thirty-eight from the number of the year.

Era of Actium, and Era of Augustus.—This era was established to commemorate the battle of Actium, which was fought on the 3rd of September, in the year 31 B.C., and in the 15th of the Julian era. By the Romans the era of Actium was considered as beginning on the 1st of January of the 16th of the Julian era, which is the 30th B.C. The Egyptians, who used this era till the time of Diocletian, dated its commencement from the beginning of their month Thoth, or the 29th of August; and the Eastern Greeks from the 2nd of September. By the latter it was also called the era of Antioch, and it continued to be used till the 9th century. It must not be confounded with the Caesarean era of Antioch, which began seventeen years earlier. Many of the medals struck by the city of Antioch in honour of Augustus are dated according to this era.

Besides the era of Actium, there was also an Augustan era, which began four years later, or 27 B.C., the year in which Augustus prevailed on the senate and people of Rome to decree him the title of Augustus, and to confirm him in the supreme power of the empire.

Era of Diocletian, or Era of Martyrs.—It has been already stated that the Alexandrians, at the accession of the emperor Diocletian, made an alteration in their mundane era, by striking off ten years from their reckoning. At the same time they established a new era, which is still followed by the Abyssinians and Copts. It begins with the 29th of August (the first day of the Egyptian year) of the year 284 of our era, which was the first of the reign of Diocletian. The denomination of *Era of Martyrs*, subsequently given to it in commemoration of the persecution of the Christians, would seem to imply that its commencement ought to be referred to the year 303 of our era, for it was in that year that Diocletian issued his famous edict; but the practice of dating from the accession of Diocletian has prevailed. The ancient Egyptian year consisted of 365 days; but after the introduction of the Julian calendar, the astronomers of Alexandria adopted an intercalary year, and added six additional days instead of five to the end of the last month of every fourth year. The year thus became exactly similar to the Julian year. The Egyptian intercalary year, however, does not correspond to the Julian leap year, but is the year immediately preceding; and the intercalation takes place at the end of the year, or on the 29th of August. Hence the first three years of the Egyptian intercalary period begin on the 29th of our August, and the fourth begins on the 30th of that month. Before the end of that year the Julian intercalation takes place, and the beginning of the following Egyptian year is restored to the 29th of August. Hence to reduce a date according to this era to our own reckoning, it is necessary, for common years, to add 283 years and 240 days; but if the date belongs to the first three months of the year following the intercalation, or, which is the same thing, if in the third year of the Julian cycle it falls between the 30th of August and the end of the year, we must add 283 years and 241 days. The Ethiopians do not reckon the years from the beginning of the era in a consecutive series, but employ a period of 532 years, after the expiration of which they again begin with 1. This is the Dionysian or Great Paschal Period, and is formed by the multiplication of the numbers 28 and 19, that is, of the solar and lunar cycles, into each other.

The following are the names of the Ethiopian or Abyssinian months, with the days on which they begin in the Julian calendar, or old style:—

Mascaram . . .	29th August.	Magabit . . .	25th February.
Tikmith . . .	28th September.	Miazia . . .	27th March.
Hadar . . .	28th October.	Gimbot . . .	26th April.
Tacsam . . .	27th November.	Sene . . .	26th May.
Tir . . .	27th December.	Hamle . . .	25th June.
Yacatit . . .	26th January.	Nahasse . . .	25th July.

The additional or epagomenal days begin on the 24th of August. In intercalary years the first seven months commence one day later. The Egyptian months, followed by the modern Copts, agree with the above in every respect excepting the names.

Indiction.—The cycle of Indiction was very generally followed in the Roman empire for some centuries before the adoption of the Christian era. Three Indictions may be distinguished; but they differ only in regard to the commencement of the year.

1. The *Constantinopolitan Indiction*, like the Greek year, commenced with the month of September. This was followed in the Eastern empire, and in some instances also in France.

2. The *Imperial or Constantinian Indiction* is so called because its establishment is attributed to Constantine. This was also called the *Caesarean Indiction*. It begins on the 24th of September. It is not infrequently met with in the ancient chronicles of France and England.

3. The *Roman or Pontifical Indiction* began on the 25th of December or 1st of January, according as the Christian year was held to begin on the one or other of these days. It is often employed in papal bulls, especially after the time of Gregory VII., and traces of its use are found in early French authors.

Era of the Armenians.—The epoch of the Armenian era is that of the council of Tiben, in which the Armenians consummated their schism from the Greek Church by condemning the acts of the council of Chalcedon; and it corresponds to Tuesday, the 9th of July of the year 552 of the Incarnation. In their civil affairs the Armenians follow the ancient vague year of the Egyptians; but their ecclesiastical year, which begins on the 11th of August, is regulated in the same manner as the Julian year, every fourth year consisting of 366 days, so that Easter and the other festivals are retained at the same place in the seasons as well as in the civil year. The Armenians also make use of the mundane era of Constantinople, and sometimes conjoin both methods of computation in the same documents. In their correspondence and transactions with Europeans, they generally follow the era of the Incarnation, and adopt the Julian year.

To reduce the civil dates of the Armenians to the Christian era, proceed as follows. Since the epoch is the 9th of July, there were 176 days from the beginning of the Armenian era to the end of the year 552 of our era; and since 552 was a leap year, the year 553 began a Julian intercalary period. Multiply, therefore, the number of Armenian years elapsed by 365; add the number of days from the commencement of the current year to the given date; subtract 176 from the sum, and the remainder will be the number of days from the 1st of January 553 to the given date. This number of days being reduced to Julian years, add the result to 552, and the sum gives the day in the Julian year, or old style.

In the ecclesiastical reckoning the year begins on the 11th of August. To reduce a date expressed in this reckoning to the Julian date, add 551 years, and the days elapsed from the 1st of January to the 10th of August, both inclusive, of the year 552—that is to say (since 552 is a leap year), 223 days. In leap years one day must be subtracted if the date falls between the 1st of March and 10th of August.

The following are the Armenian ecclesiastical months with their correspondence with those of the Julian calendar:—

1. Navazardi begins	11th August.
2. Hori	10th September.
3. Sahmi	10th October.
4. Dre Thari	9th November.
5. Kagoths	9th December.
6. Aracz	8th January.
7. Malegi	7th February.
8. Arcki	9th March.
9. Angi	8th April.

- 10. Mariri 8th May.
- 11. Marcacz 7th June.
- 12. Herodiez 7th July.

To complete the year five complementary days are added in common years, and six in leap years.

The Mahomedan Era, or Era of the Hegira.—The era in use among the Turks, Arabs and other Mahomedan nations is that of the *Hegira* or *Hejra*, the flight of the prophet from Mecca to Medina, 622 A.D. Its commencement, however, does not, as is sometimes stated, coincide with the very day of the flight, but precedes it by sixty-eight days. The prophet, after leaving Mecca, to escape the pursuit of his enemies, the Koreishites, hid himself with his friend Abubekr in a cave near Mecca, and there lay for three days. The departure from the cave and setting out on the way to Medina is assigned to the ninth day of the third month, Rabia I.—corresponding to the 22nd of September of the year 622 A.D. The era begins from the first day of the month of Muharram preceding the flight, or first day of that Arabian year which coincides with Friday, July 16, 622 A.D. It is necessary to remember that by astronomers and by some historians the era is assigned to the preceding day, July 15. It is stated by D'Herbelot that the era of the Hegira was instituted by Omar, the second caliph, in imitation of the Christian era of the martyrs.

Era of Yazdegerd, or Persian or Jelalacan Era.—This era begins with the elevation of Yazdegerd III. to the throne of Persia, on the 16th of June in the year of our era 632. Till the year 1079 the Persian year resembled that of the ancient Egyptians, consisting of 365 days without intercalation; but at that time the Persian calendar was reformed by Jelal ud-Din Malik Shah, sultan of Khorasan, and a method of intercalation adopted which, though less convenient, is considerably more accurate than the Julian. The intercalary period is 33 years,—one day being added to the common year seven times successively at the end of four years, and the eighth intercalation being deferred till the end of the fifth year. This era was at one period universally adopted in Persia, and it still continues to be followed by the Parsees of India. The months consist of thirty days each, and each day is distinguished by a different name. According to Alfergani, the names of the Persian months are as follows:—

Afrudin-meh.	Merded-meh.	Adar-meh.
Ardisascht-meh.	Schaharir-meh.	Di-meh.
Cardi-meh.	Mahar-meh.	Behen-men.
Tir-meh.	Aben-meh.	Affirer-meh.

The five additional days (in intercalary years six) are named *Musteraca*.

As it does not appear that the above-mentioned rule of intercalation was ever regularly followed, it is impossible to assign exactly the days on which the different years begin. In some provinces of India the Parsees begin the year with September, in others they begin it with October. We have stated that the era began with the 16th June 632. But the vague year, which was followed till 1079, anticipated the Julian year by one day every four years. In 447 years the anticipation would amount to about 112 days, and the beginning of the year would in consequence be thrown back to near the beginning of the Julian year 632. To the year of the Persian era, therefore, add 631, and the sum will be the year of our era in which the Persian year begins.

Chinese Chronology.—From the time of the emperor Yao, upwards of 2000 years B.C., the Chinese had two different years,—a civil year, which was regulated by the moon, and an astronomical year, which was solar. The civil year consisted in general of twelve months or lunations, but occasionally a thirteenth was added in order to preserve its correspondence with the solar year. Even at that early period the solar or astronomical year consisted of 365½ days, like our Julian year; and it was arranged in the same manner, a day being intercalated every fourth year.

According to the missionary Gaubil, the Chinese divided the day into 100 *ke*, each *ke* into 100 minutes, and each minute into 100 seconds. This practice continued to prevail till the 17th century, when, at the instance of the Jesuit Schall, president of the tribunal of mathematics, they adopted the European method

of dividing the day into twenty-four hours, each hour into sixty minutes, and each minute into sixty seconds. The civil day begins at midnight and ends at the midnight following.

Since the accession of the emperors of the Han dynasty, 206 B.C., the civil year of the Chinese has begun with the first day of that moon in the course of which the sun enters into the sign of the zodiac which corresponds with our sign Pisces. From the same period also they have employed, in the adjustment of their solar and lunar years, a period of nineteen years, twelve of which are common, containing twelve lunations each, and the remaining seven intercalary, containing thirteen lunations. It is not, however, precisely known how they distributed their months of thirty and twenty-nine days, or, as they termed them, great and small moons. This, with other matters appertaining to the calendar, was probably left to be regulated from time to time by the mathematical tribunal.

The Chinese divide the time of a complete revolution of the sun with regard to the solstitial points into twelve equal portions, each corresponding to thirty days, ten hours, thirty minutes. Each of these periods, which is denominated a *tsë*, is subdivided into two equal portions called *chung-ki* and *tsic-ki*, the *chung-ki* denoting the first half of the *tsë*, and the *tsic-ki* the latter half. Though the *tsë* are thus strictly portions of solar time, yet what is remarkable, though not peculiar to China, they give their name to the lunar months, each month or lunation having the name of the *chung-ki* or sign at which the sun arrives during that month. As the *tsë* is longer than a synodic revolution of the moon, the sun cannot arrive twice at a *chung-ki* during the same lunation; and as there are only twelve *tsë*, the year can contain only twelve months having different names. It must happen sometimes that in the course of a lunation the sun enters into no new sign; in this case the month is intercalary, and is called by the same name as the preceding month.

For chronological purposes, the Chinese, in common with some other nations of the east of Asia, employ cycles of sixty, by means of which they reckon their days, moons and years. The days are distributed in the calendar into cycles of sixty, in the same manner as ours are distributed into weeks, or cycles of seven. Each day of the cycle has a particular name, and as it is a usual practice, in mentioning dates, to give the name of the day along with that of the moon and the year, this arrangement affords great facilities in verifying the epochs of Chinese chronology. The order of the days in the cycle is never interrupted by any intercalation that may be necessary for adjusting the months or years. The moons of the civil year are also distinguished by their place in the cycle of sixty; and as the intercalary moons are not reckoned, for the reason before stated, namely, that during one of these lunations the sun enters into no new sign, there are only twelve regular moons in a year, so that the cycle is renewed every five years. Thus the first moon of the year 1873 being the first of a new cycle, the first moon of every sixth year, reckoned backwards or forwards from that date, as 1868, 1863, &c., or 1877, 1882, &c., also begins a new lunar cycle of sixty moons. In regard to the years, the arrangement is exactly the same. Each has a distinct number or name which marks its place in the cycle, and as this is generally given in referring to dates, along with the other chronological characters of the year, the ambiguity which arises from following a fluctuating or uncertain epoch is entirely obviated.

The cycle of sixty is formed of two subordinate cycles or series of characters, one of ten and the other of twelve, which are joined together so as to afford sixty different combinations. The names of the characters in the cycle of ten, which are called *celestial* signs, are :

1. Keä; 2. Yih; 3. Ping; 4. Ting; 5. Woo;
6. Ke; 7. Käng; 8. Sin; 9. Jin; 10. Kwei;

and in the series of 12, denominated *terrestrial* signs,

1. Tsze; 2. Chow; 3. Yin; 4. Maou; 5. Shin; 6. Sze;
7. Woo; 8. We; 9. Shin; 10. Yew; 11. Seüh; 12. Hae.

The name of the first year, or of the first day, in the sexagenary cycle is formed by combining the first words in each of the above series; the second is formed by combining the second of each series, and so on to the tenth. For the next year the first word of the first series is combined with the eleventh of the second, then the second of the first series with the twelfth of the second, after this the third of the first series with the first of the second, and so on till the sixtieth combination, when the last of the first series concurs with the last of the second. Thus Keä-tsze is the name of the first year, Yih-Chow that of the second, Keä-seüh that of the eleventh, Yih-hae that of the twelfth, Ping-tsze that of the thirteenth, and so on. The order of proceeding is obvious.

In the Chinese history translated into the Tatar dialect by order of the emperor K'ang-hi, who died in 1721, the characters of the cycle begin to appear at the year 2357 B.C. From this it has been inferred

that the Chinese empire was established previous to that epoch; but it is obviously so easy to extend the cycles backwards indefinitely, that the inference can have very little weight. The characters given to that year 2357 B.C. are Kea-shin, which denote the 41st of the cycle. We must, therefore, suppose the cycle to have begun 2397 B.C., or forty years before the reign of Yao. This is the epoch assumed by the authors of *L'Art de vérifier les dates*. The mathematical tribunal has, however, from time immemorial counted the first year of the first cycle from the eighty-first of Yao, that is to say, from the year 2277 B.C.

Since the year 163 B.C. the Chinese writers have adopted the practice of dating the year from the accession of the reigning emperor. An emperor, on succeeding to the throne, gives a name to the years of his reign. He ordains, for example, that they shall be called Ta-te. In consequence of this edict, the following year is called the first of Ta-te, and the succeeding years the second, third, fourth, &c., of Ta-te, and so on, till it pleases the same emperor or his successor to ordain that the years shall be called by some other appellation. The periods thus formed are called by the Chinese Nien-hao. According to this method of dating the years a new era commences with every reign; and the year corresponding to a Chinese date can only be found when we have before us a catalogue of the Nien-hao, with their relation to the years of our era.

For *Hindu Chronology*, see the article under that heading.

BIBLIOGRAPHY.—In addition to the early Greek writings already named, there are the forty books (some fifteen only extant in their entirety) of universal history compiled (about 8 B.C.) by Diodorus Siculus, and arranged in the form of annals; the *Pentabiblos* of Julius Africanus (about 220-230 A.D.); the treatise of Censorinus entitled *De die natali*, written 238 A.D.; the *Chronicon*, in two books, of Eusebius Pamphili, bishop of Caesarea (about 325 A.D.), distinguished as the first book of a purely chronological character which has come down to us; and three important works forming parts of the *Corpus Scriptorum Historiae Byzantinae*, namely, the *Chronographia* of Georgius Syncellus (800 A.D.), the *Chronographia* of Johannes Malalas (9th century), and the *Chronicon Paschale*.

Among works on Chronology, the following, which are arranged in the order of their publication, have an historical interest, as leading up to the epoch of modern research:—

1583. *De Emendatione Temporum*, by Joseph Scaliger, in which were laid the foundations of chronological science.

1603. *Opus Chronologicum*, by Sethus Calvisius.

1627. *De Doctrina Temporum*, by Petavius (Denis Petau), with its continuation published in 1630, and an abridgment entitled *Rationarium Temporum*, in 1633-1634.

1650. *Annales Veleris et Novi Testamenti*, by Archbishop Ussher, whose dates have by some means gained a place in the authorized version of the Bible.

1651. *Regia Epitome Historiae Sacrae et Profanae*, by Philippe Labbe, of which a French version was also published.

1669. *Institutionum Chronologicarum libri duo*, by Bishop Beveridge.

1672. *Chronicus Canon Aegyptiacus, Ebraicus, et Graecus*, by Sir John Marsham.

1687. *L'Antiquité des temps rétablie et défendue*, by Paul Pezron, with its *Défense*, 1691.

1701. *De Veteribus Graecorum Romanorumque Cyclis*, by Henry Dodwell.

1728. *The Chronology of Ancient Kingdoms amended*, by Sir Isaac Newton, remarkable as an attempt to construct a system on new bases, independent of the Greek chronologers.

1738. *Chronologie de l'histoire sainte*, by Alphonse des Vignolles.

1744. *Tablettes chronologiques de l'histoire universelle*, by N. Lenglet-Dufresnoy.

1750. The first edition in one vol. 4to of *L'Art de vérifier les dates*, which in its third edition (1818-1831) appeared in 38 vols. 8vo, a colossal monument of the learning and labours of various members of the Benedictine Congregation of Saint-Maur.

1752. *Chronological Antiquities*, by John Jackson.

1754. *Chronology and History of the World*, by John Blair; new edition, much enlarged (1857).

1784. *A System of Chronology*, by Playfair.

1799. *Handbuch der Geschichte der Staaten des Alterthums*, by A. H. L. Heeren.

1803. *Handbuch der alten Geschichte, Geographie, und Chronologie*, by G. G. Bredow, with his *Historische Tabellen*.

1809-1814. *New Analysis of Chronology*, by William Hales.

1819. *Annales Veterum Regnorum*, by C. G. Zumpt.

1821. *Tableaux historiques, chronologiques, et géographiques*, by Buret de Longchamps.

1824-1834. *Fasti Hellenici*, and 1845-1850, *Fasti Romani*, by H. Fynes Clinton. Epitomes of these elaborate works were published, 1851-1853.

1825-1826. *Handbuch der mathematischen und technischen Chronologie*, by Christian Ludwig Ideler; and his *Lehrbuch der Chronologie*, (1831).

1833. *The Chronology of History*, by Sir Harris Nicolas.

1852. *Fasti Temporis Catholici*, by Edward Greswell; and by the same author (1854), *Origines Kalendariae Italicae*; and 1862, *Origines Kalendariae Hellenicae*.

More modern works are the *Encyclopaedia of Chronology*, by B. B. Woodward and W. L. R. Cates (1872); and J. C. Macdonald's *Chronologies and Calendars* (1897). But see the separate historical articles in this work. (W. L. R. C.)

CHRUDIM, a town of Bohemia, Austria, 74 m. E.S.E. of Prague by rail Pop (1900) 13,017; mostly Czech. It has an important horse market, besides manufactures of sugar, spirits, beer, soda-water and agricultural machinery. There are also steam corn-mills and saw-mills. Chrudim is mentioned as the castle of a *gaugraf* as early as 903. The new town was founded by Ottokar II, who settled many Germans in it and gave it many privileges. After 1421 Chrudim was held by the Hussites, and though Ferdinand I. confiscated most of the town property, it prospered greatly till the outbreak of the Thirty Years' War. In 1625 the greater part of its Hussite inhabitants left the town, which suffered much later on from the Swedes. Chrudim was the birthplace of Joseph Ressel (1793-1857), honoured in Austria as the inventor of the screw propeller.

CHRYSANTHEMUM¹ (*Chrysanthemum sinense*, nat. ord. Compositae), one of the most popular of autumn flowers. It is a native of China, whence it was introduced to Europe. The first chrysanthemum in England was grown at Kew in 1790, whither it had been sent by Mr Cels, a French gardener. It was not, however, till 1825 that the first chrysanthemum exhibition took place in England. The small-flowered pompons, and the grotesque-flowered Japanese sorts, are of comparatively recent date, the former having originated from the Chusan daisy, a variety introduced by Mr Fortune in 1846, and the latter having also been introduced by the same traveller about 1862. The Japanese kinds are unquestionably the most popular for decorative purposes as well as for exhibition. They afford a wide choice in colour, form, habit and times of flowering. The incurved Chinese kinds are severely neat-looking flowers in many shades of colour. The anemone-flowered kinds have long outer or ray petals, the interior or disk petals being short and tubular. These are to be had in many pleasing colours. The pompon kinds are small flowered, the petals being short. The plants are mostly dwarf in habit. In the single varieties the outer or ray florets alone are large and attractively coloured.

Plants for the Border.—As a border plant out of doors the chrysanthemum is of the easiest culture. It is an exceptionally good town plant. By a judicious selection of varieties, flowers may be produced in abundance and in considerable variety from August to the end of November, and in favourable seasons well on towards Christmas. Since 1890 when the English market was flooded with French raised varieties of exceptional merit, the border chrysanthemum has taken first place among hardy autumn flowering plants. Most of the varieties then introduced have been superseded by many excellent kinds raised in Britain.

Propagation.—The old English method of dividing the plants in March or early April may be followed where better means of propagation are not practicable. Many of the best border varieties are shy in producing new growths (suckers) from the rootstock, and are in consequence not amenable to this method. It is better to raise the plants from cuttings. This may be begun in January for the early flowering sorts, the late kinds being propagated during February and March. They will root quite well in a cold frame, if protected during frosty weather by litter or other similar material. If the frame can be heated at will so as to maintain a fairly even temperature of from 40° to 50° Fah., roots will be made more quickly and with more certainty. A still better method is to improvise a frame near the glass in a greenhouse, where the temperature is not raised above 50° by artificial heat. This has the advantage of being accessible in all weathers. The bottom of the frame is covered with sifted coal ashes or coco-nut fibre, on which the shallow boxes or pots used in propagating are placed. These are well drained with broken crocks, the bottoms of the boxes being drilled to allow water to pass out quickly. The soil should consist of about equal parts of fibrous loam and leaf-mould, half a part of coarse silver-sand, and about a quart of vegetable ash from the garden refuse heap to each bushel of the compost. The whole should be passed through a quarter inch sieve and thoroughly mixed. The coarse leaf-mould, &c., from the sieve should be spread thinly over the drainage, and the boxes or pots filled almost to the rims with the compost, and

¹ The Gr. χρυσάνθεμον (χρυσός, gold, and ἄνθεμον, flower) was the herbalists' name for *C. segetum*, the "corn marigold," with its yellow bloom, and was transferred by Linnaeus to the genus, being commonly restricted now to the species *C. sinense*.

covered, if possible, with a thin layer of silver-sand. It should be pressed firmly, watered with a fine rose, and allowed to drain for an hour. The cuttings should then be dibbled into the boxes in rows, just clear, the soil being gently pressed around each. Short stout shoots which arise directly from the rootstock make the best cuttings. In their absence cuttings from the stems are used. The ideal length for a cutting is about 2½ in. Cut the stem squarely with a sharp knife just below a joint, and remove the lower leaves. Insert as soon as possible and water with a fine rose to settle the soil around them. The soil is not allowed to become dry. The cuttings should be looked over daily, decayed leaves removed, and surplus moisture, condensed on the glass, wiped away. Ventilate gradually as rooting takes place, and, when well rooted, transfer singly into pots about 3 in. in diameter, using as compost a mixture of two parts loam, one part leaf-mould, half a part coarse silver-sand, and a gallon of vegetable ash to every bushel of the compost. Return to the frames and keep close for a few days to allow the little plants to recover from the check occasioned by the potting. Ventilation should be gradually increased until the plants are able to bear full exposure during favourable weather, without showing signs of distress by flagging. They should be carefully protected at all times from cold cutting winds. In April, should the weather be favourable, the plants may be transferred to the borders, especially should the positions happen to be sheltered. If this is not practicable, another shift will be necessary, this time into pots about 5 in. in diameter. The soil should be similar to that advised for the previous potting, enriched with half a part of horse manure that has been thoroughly sweetened by exposure. Plant out during May. All borders intended for chrysanthemums should be well dug and manured. The strong growing kinds should be planted about 3 ft. apart, the smaller kinds being allowed a little less room.

In the summer, water in dry weather, syringe in the evenings whenever practicable, and keep the borders free from weeds by surface hoeings; stake and tie the plants as required, and pinch out the tips of the shoots until they have become sufficiently bushy by frequent branching. Pinching should not be practised later than the end of June.

Pot Plants for Decoration.—A list of a few of the thousands of varieties suitable for this purpose would be out of place here; new varieties are being constantly introduced, for these the reader is referred to trade catalogues.

The most important considerations for the beginner are (a) the choice of colours; (b) the types of flowers; (c) the height and habits of the varieties. Generally speaking, very tall varieties and those of weak growth and delicate constitutions should be avoided. The majority of the varieties listed for exhibition purposes are also suitable for decoration, especially the Japanese kinds. Propagation and early culture are substantially as for border plants.

As soon as the 5-in. pots are filled with roots, no time should be lost in giving them the final shift. Eight-in. pots are large enough for the general stock, but very strong growers may be given a larger size. The soil, prepared a fortnight in advance, should consist of four parts fibrous loam, one part leaf-mould, one part horse manure prepared as advised above, half a part coarse silver-sand, half a part of vegetable ash, and a quart of bone-meal or a sprinkling of basic slag to every bushel of the mixture. Mix thoroughly and turn over at intervals of three or four days. Pot firmly, working the soil well around the roots with a lath. The main stake for the support of the plant should now be given; other and smaller stakes may later be necessary when the plants are grown in a bushy form, but their number should not be overdone. The stakes should be as few as possible consistent with the safety of the shoots, which should be looped up loosely and neatly. The plants should be placed in their summer quarters directly after potting. Stand them in rows in a sunny situation, the pots clear of one another, sufficient room being allowed between the rows for the cultivator to move freely among them. The main stakes are tied to rough trellis made by straining wire in two rows about 2 ft. apart between upright poles driven into the ground. Coarse coal ashes or coke breeze are the best materials to stand the pots on, there being little risk of worms working through into the pots. The plants, which are required to produce as many flowers as possible, should have their tips pinched out at frequent intervals, from the end of March or beginning of April to the last week in June, for the main season kinds; and about the middle of July for the later kinds.

Towards the end of July the plants will need feeding at the roots with weak liquid manure, varied occasionally by a very slight dusting of soluble chemical manure such as guano. The soil should be moderately moist when manure is given. In order that the flowers may be of good form, all lateral flower buds should be removed as soon as they are large enough to handle, leaving only the bud terminating each shoot. Towards the end of September—earlier should the weather prove wet and cold—remove the plants to well-ventilated greenhouses where they are intended to flower. Feeding should be continued until the flowers are nearly half open, when it may be gradually reduced. The large mop-headed blooms seen at exhibitions in November are grown in the way described, but only one or two shoots are allowed to develop on a plant, each shoot eventually having only one bloom.

The chrysanthemum is subject to the attack of black aphid and

green-fly. These pests may be destroyed, out of doors, by syringing with quassa and soft soap solutions, by dusting the affected parts with tobacco-powder, and indoors also by fumigating. Mildew generally appears after the plants are housed. It may be destroyed by dusting the leaves attacked with sublimed sulphur. Rust is a fungoid disease of recent years. It is best checked by syringing the plants with liver of sulphur (1 oz. to 3 gallons of water) occasionally, a few weeks before taking the plants into the greenhouse. Earwigs and slugs must be trapped and destroyed.

Flowers for Exhibition.—Flowers of exhibition standard must be as broad and as deep as the various varieties are capable of producing; they must be irrefragable in colour. They must also exhibit the form peculiar to the variety when at its best, very few kinds being precisely alike in this respect. New varieties are introduced in large numbers annually, some of which supplant the older kinds. The cultivator must therefore study the peculiarities of several new kinds each year if he would be a successful exhibitor.

For lists of varieties, &c. see the catalogues of chrysanthemum growers, the gardening Press, and the excellent cultural pamphlets which are published from time to time.

CHRYSANTHIUS, a Greek philosopher of the 4th century A.D., of the school of Iamblichus. He was one of the favourite pupils of Aedesius, and devoted himself mainly to the mystical side of Neoplatonism (*q.v.*). The emperor Julian (*q.v.*) went to him by the advice of Aedesius, and subsequently invited him to come to court, and assist in the projected resuscitation of Hellenism. But Chrysanthius declined on the strength of unfavourable omens, as he said, but probably because he realized that the scheme was unlikely to bear fruit. For the same reason he abstained from drastic religious reforms in his capacity as high-priest of Lydia. As a result of his moderation, he remained high-priest till his death, venerated alike by Christians and pagans. His wife Melite, who was associated with him in the priestly office, was a kinswoman of Eunapius the biographer.

CHRYSELEPHANTINE (Gr. χρυσός, gold, and ἑλέφας, ivory), the architectural term given to statues which were built up on a wooden core, with ivory representing the flesh and gold the drapery. The two most celebrated examples are those by Pheidias of the statue of Athena in the Parthenon and of Zeus in the temple at Olympia.

CHRYSENE C₁₈H₁₂, a hydrocarbon occurring in the high boiling fraction of the coal tar distillate. It is produced in small quantity in the distillation of amber, on passing the vapour of phenyl-naphthyl-methane through a red-hot tube, on heating indene, or by passing the mixed vapours of coumarone and naphthalene through a red-hot tube. It crystallizes in plates or octahedra (from benzene), which exhibit a violet fluorescence, and melt at 250° C. Chromic acid in glacial acetic acid solution oxidizes it to chrysoquinone C₁₈H₁₀O₂, which when distilled with lead oxide gives chrysoketone C₁₇H₁₀O. When chrysene is fused with alkalis, chrysenic acid, C₁₇H₁₂O₃, is produced, which on heating gives β-phenyl-naphthalene. On heating chrysene with hydriodic acid and red phosphorus to 260° C., the hydro-derivatives C₁₈H₂₈ and C₁₈H₃₀ are produced. It gives characteristic addition products with picric acid and dinitroanthraquinone. Impure chrysene is of a yellow colour; hence its name (χρῆσος, golden yellow).

CHRYSIPPUS (c. 280–206 B.C.), Greek philosopher, the third great leader of the Stoics. A native of Soli in Cilicia (Diog. Laert. vii. 179), he was robbed of his property and came to Athens, where he studied possibly under Zeno, certainly under Cleanthes. It is said also that he became a pupil of Arcesilaus and Lacydes, heads of the Middle Academy. This impartiality in his early studies is the key of his philosophic work, the dominant characteristic of which is comprehensiveness rather than originality. He took the doctrines of Zeno and Cleanthes and crystallized them into a definite system; he further defended them against the attacks of the Academy. His polemic skill earned for him the title of the "Column of the Portico." Diogenes Laertius says, "If the gods use dialectic, they can use none other than that of Chrysippus"; εἰ μὴ γὰρ ἦν Χρῆσιππος, οὐκ ἂν ἦν Στωά ("Without Chrysippus, there had been no Porch") He excelled in logic, the theory of knowledge, ethics and physics. His relations with Cleanthes, contemporaneously criticized by Antipater, are considered under STOICS.

He is said to have composed seven hundred and fifty treatises, fragments alone of which survive. Their style, we are told, was unpolished and arid in the extreme, while the argument was lucid and impartial.

See G. H. Hagedorn, *Moralia Chrysippea* (1685), *Ethica Chrysippi* (1715); J. F. Richter, *De Chrysippo Stoico fastuoso* (1738); F. Bagnet, *De Chrysippi vita doctrina et reliquiis* (1822); C. Petersen, *Philosophiæ Chrysippiæ fundamenta* (1827); A. Gercke, "Chrysippea" in *Janrbücher für Philologie*, suppl. vol. xiv. (1885); R. Nicolai, *De logicis Chrysippi libris* (1859); Christos Aronis, *Χρυσίππος γραμματικός* (1885); R. Hirzel, *Untersuchungen zu Ciceros philosophischen Schriften*, ii. (1882); L. Stein, *Die Psychologie der Stoa* (1886); A. B. Krische, *Forschungen auf dem Gebiete der alten Philosophie* (1840); J. E. Sandys, *Hist. Class. Schol.* i. 149.

CHRYSOBERYL, a yellow or green gem-stone, remarkable for its hardness, being exceeded in this respect only by the diamond and corundum. The name suggests that it was formerly regarded as a golden variety of beryl; and it is notable that though differing widely from beryl it yet bears some relationship to it inasmuch as it contains the element beryllium. In chrysoberyl, however, the beryllium exists as an aluminate, having the formula BeAl_2O_4 , or $\text{BeO} \cdot \text{Al}_2\text{O}_3$. The analysis of a specimen of Brazilian chrysoberyl gave alumina 78.10, beryllia 17.94, and ferric oxide 4.88%. The typical yellow colour of the stone inclines in many cases to pale green, occasionally passing into shades of dark green and brown. The iron usually present in the mineral seems responsible for the green colour. Chrysoberyl is often mistaken by its colour for chrysolite (*q.v.*), and has indeed been termed Oriental chrysolite. In its crystalline forms it bears some relationship to chrysolite, both crystallizing in the orthorhombic system, but it is a much harder and a denser mineral. As the two stones are apt to be confounded, it may be convenient to contrast their chief characters:—

	Chrysoberyl.	Chrysolite.
Hardness	8.5	6.5 to 7
Specific Gravity	3.65 to 3.75	3.34 to 3.37
Chemical Composition	BeAl_2O_4 .	Mg_2SiO_4 .

Chrysoberyl is not infrequently cloudy, opalescent and chatoyant, and is then known as "cymophane" (Gr. *κῦμα*, a "cloud"). The cloudiness is referable to the presence of multitudes of microscopic cavities. Some of the cymophane, when cut with a convex surface, forms the most valuable kind of cat's-eye (see CAT'S-EYE). A remarkable dichroic variety of chrysoberyl is known as alexandrite (*q.v.*).

Most chrysoberyl comes from Brazil, chiefly from the district of Minas Novas in the state of Minas Geraes, where it occurs as small water-worn pebbles. The cymophane is mostly from the gem-gravels of Ceylon. Chrysoberyl is known as a constituent of certain kinds of granite, pegmatite and gneiss. In the United States it occurs at Haddam, Conn.; Greenfield Centre, near Saratoga Springs, N.Y.; and in Manhattan island. It is known also in the province of Quebec, Canada, and has been found near Gwelo in Rhodesia. (F. W. R.*)

CHRYSOCOLLA, a hydrous copper silicate occurring as a decomposition product of copper ores. It is never found as crystals, but always as encrusting and botryoidal masses with a microcrystalline structure. It is green or bluish-green in colour, and often has the appearance of opal or enamel, being translucent and having a conchoidal fracture with vitreous lustre; sometimes it is earthy in texture. Not being a definite crystallized substance, it varies widely in chemical composition, the copper oxide (CuO), for example, varying in different analyses from 17 to 67%; the formula is usually given as $\text{CuSiO}_3 + 2\text{H}_2\text{O}$. The hardness (2-4) and specific gravity (2.0-2.8) are also variable. It has recently been suggested that the material may really be a mixture of more than one hydrous copper silicate, since differences in the microcrystalline structure of the different concentric layers of which the masses are built up may be detected. Various impurities (silica, &c.) are also commonly present, and several varieties have been distinguished by special names: thus dillenburgite, from Dillenburg in Nassau, contains copper carbonate; demidoffite and cyanochalcite contain copper phosphate; and pilarite contains alumina (perhaps as allophane). The mineral occurs in the upper parts of veins of copper ores,

and has resulted from their alteration by the action of waters containing silica in solution. Pseudomorphs of chrysocola after various copper minerals (*e.g.* cuprite) are not uncommon. It is found in most copper mines.

The name chrysocola (from *χρυσός*, gold, and *κόλλα*, glue) was applied by Theophrastus and other ancient writers to materials used in soldering gold, one of which, from the island of Cyprus, may have been identical with the mineral now known by this name. Borax, which is used for this purpose, has also been called chrysocola.

A mineral known as pitchy copper-ore (Ger. *Kupferpecherz*), and of some importance as an ore of copper, is usually classed as a variety of chrysocola containing much admixed limonite. It is dark brown to black in colour, with a dull to glassy or resinous lustre, and resembles pitch in appearance. In thin sections it is translucent and optically isotropic, and recent examinations seem to prove that it is a homogeneous mineral and not a mechanical mixture of chrysocola and limonite. (L. J. S.)

CHRYSOOLITE, a transparent variety of olivine, used as a gem-stone and often called peridot. The name chrysolite, meaning "golden stone" (*χρυσός* and *λίθος*), has been applied to various yellowish gems, notably to topaz, to some kinds of beryl and to chrysoberyl. The true chrysolite of the modern mineralogist is a magnesium silicate, referable to the species olivine. It is appropriate to call the lighter coloured stones inclining to yellow chrysolite, and the darker green stones peridot. Certain kinds of topaz, from the Schneckenstein in Saxony, are known as Saxon chrysolite; while moldavite, a substance much like a green obsidian, is sometimes called water chrysolite or pseudo-chrysolite.

See CHRYSOBERYL; OLIVINE; PERIDOT.

CHRYSOLOGAS, MANUEL [OF EMMANUEL] (c. 1355-1415), one of the pioneers in spreading Greek literature in the West, was born at Constantinople of a distinguished family, which had removed with Constantine the Great to Byzantium. He was a pupil of Gemistus (*q.v.*). In 1393 he was sent to Italy by the emperor Manuel Palaeologus to implore the aid of the Christian princes against the Turks. He returned to Constantinople, but at the invitation of the magistrates of Florence he became about 1395 professor of the Greek language in that city, where he taught three years. He became famous as a translator of Homer and Plato. Having visited Milan and Pavia, and resided for several years at Venice, he went to Rome upon the invitation of Bruni Leonardo, who had been his pupil, and was then secretary to Gregory XII. In 1408 he was sent to Paris on an important mission from the emperor Manuel Palaeologus. In 1413 he went to Germany on an embassy to the emperor Sigismund, the object of which was to fix a place for the assembling of a general council. It was decided that the meeting should take place at Constance; and Chrysoloras was on his way thither, having been chosen to represent the Greek Church, when he died suddenly on the 15th of April 1415. Only two of his works have been printed, his *Erotemata* (published at Venice in 1484), which was the first Greek grammar in use in the West, and *Epistolæ III. de comparatione veteris et novæ Romæ*.

JOHN CHRYSOLOGAS, a relative of the above (variously described as his nephew, brother or son), who, like him, had studied and taught at Constantinople, and had then gone to Italy, shared Manuel's reputation as one of those who spread the influence of Greek letters in the West. His daughter married Filelfo (*q.v.*).

CHRYSOPTASE (Gr. *χρυσός*, gold, and *πράσινον*, leek), a name applied by modern mineralogists to an apple-green variety of chalcidony or hornstone, used as an ornamental stone. The colour is due to the presence of nickel, probably in the form of a hydrous silicate. By exposure to a moderate heat, or to strong light, the chrysoptase becomes paler, or even colourless, but it may regain its colour by absorption of moisture. Chrysoptase is a mineral of rather limited distribution. Most of it comes from the neighbourhood of Frankenstein in Silesia, where it occurs in association with altered serpentine. It is found to a limited extent at Revdinsk, near Ekaterinburg, in the Urals; and it occurs also in India. It is known, too, at several localities

in North America, notably at Nickel Mount, Douglas county, Oregon, where it occurs in nickeliferous serpentine.

The chrysoprase of the moderns is certainly not the *chrysoprasius* of Pliny, or the χρυσόπρασος of Greek writers. The ancient stone was not improbably our chrysoberyl, and it is doubtful whether the modern chrysoprase was known until a comparatively late period. The chrysoprase of Kosemütz, near Frankenstein in Silesia, was discovered in 1740, and used by Frederick the Great in the decoration of the palace of Sans Souci at Potsdam. But at a much earlier date the Silesian chrysoprase was used for mural decoration at the Wenzel chapel at Prague. Chrysoprase was a favourite stone in England at the beginning of the 19th century, being set round with small brilliants and used for brooches and rings. At the present time it is said to be regarded by some as a "lucky stone." Much commercial chrysoprase is chalcedony artificially stained by impregnation with a green salt of nickel. (F. W. R.*)

CHRYSOStOM. St John Chrysostom (Χρυσόστομος, golden-mouthed), the most famous of the Greek Fathers, was born of a noble family at Antioch, the capital of Syria, about A.D. 345 or 347. At the school of Libanius the sophist he gave early indications of his mental powers, and would have been the successor of his heathen master, had he not been stolen away, to use the expression of his teacher, to a life of piety (like Augustine, Gregory of Nazianzus, and Theodoret) by the influence of his pious mother Anthusa. After his baptism (about 370) by Meletius, the bishop of Antioch, he gave up all his forensic prospects, and buried himself in an adjacent desert, where for nearly ten years he spent a life of ascetic self-denial and theological study, to which he was introduced by Diodorus, bishop of Tarsus, a famous scholar of the Antiochene type. Illness, however, compelled him to return to the world; and the authority of Meletius gained his services to the church. He was ordained deacon in his thirty-fifth year (381), and afterwards presbyter (386) at Antioch. On the death of Nectarius he was appointed archbishop of Constantinople by Eutropius, the favourite minister of the emperor Arcadius. He had, ten years before this, only escaped promotion to the episcopate by a very questionable stratagem—which, however, he defends in his instructive and eloquent treatise *De Sacerdotio*. As a presbyter, he won high reputation by his preaching at Antioch, more especially by his homilies on *The Statues*, a course of sermons delivered when the citizens were justly alarmed at the prospect of severe measures being taken against them by the emperor Theodosius, whose statues had been demolished in a riot.

On the archiepiscopal throne Chrysostom still persevered in the practice of monastic simplicity. The ample revenues which his predecessors had consumed in pomp and luxury he diligently applied to the establishment of hospitals; and the multitudes who were supported by his charity preferred the eloquent discourses of their benefactor to the amusements of the theatre or of the circus. His homilies, which are still preserved, furnish ample apology for the partiality of the people, exhibiting the free command of a pure and copious vocabulary, an inexhaustible fund of metaphors and similitudes, giving variety and grace to the most familiar topics, with an almost dramatic exposure of the folly and turpitude of vice, and a deep moral earnestness. His zeal as a bishop and eloquence as a preacher, however, gained him enemies both in the church and at the court. The ecclesiastics who were parted at his command from the lay-sisters (whom they kept ostensibly as servants), the thirteen bishops whom he deposed for simony and licentiousness at a single visitation, the idle monks who thronged the avenues to the court and found themselves the public object of his scorn—all conspired against the powerful author of their wrongs. Their resentment was inflamed by a powerful party, embracing the magistrates, the ministers, the favourite eunuchs, the ladies of the court, and Eudoxia the empress herself, against whom the preacher thundered daily from the pulpit of St Sophia. A favourable pretext for gratifying their revenge was discovered in the shelter which Chrysostom had given to four Nitrian monks, known as the tall brothers, who had come to Constantinople on

being excommunicated by their bishop, Theophilus of Alexandria, a man who had long circulated in the East the charge of Origenism against Chrysostom. By Theophilus's instrumentality a synod was called to try or rather to condemn the archbishop; but fearing the violence of the mob in the metropolis, who idolized him for the fearlessness with which he exposed the vices of their superiors, it held its sessions at the imperial estate named "The Oak" (*Synodus ad quercum*), near Chalcedon, where Rufinus had erected a stately church and monastery. A bishop and a deacon were sent to accuse the archbishop, and presented to him a list of charges, in which pride, inhospitality and Origenism were brought forward to procure the votes of those who hated him for his austerity, or were prejudiced against him as a suspected heretic. Four successive summonses were signified to Chrysostom, but he indignantly refused to appear until four of his notorious enemies were removed from the council. Without entering into any examination of the charges brought before them, the synod condemned him on the ground of contumacy, and, hinting that his audacity merited the punishment of treason, called on the emperor to ratify and enforce their decision. He was immediately arrested and hurried to Nicaea in Bithynia.

As soon as the news of his banishment spread through the city, the astonishment of the people was quickly exchanged for a spirit of irresistible fury, which was increased by the occurrence of an earthquake. In crowds they besieged the palace, and had already begun to take vengeance on the foreign monks and sailors who had come from Chalcedon to the metropolis, when, at the entreaty of Eudoxia, the emperor consented to his recall. His return was graced with all the pomp of a triumphal entry, but in two months after he was again in exile. His fiery zeal could not blind him to the vices of the court, and heedless of personal danger he thundered against the profane honours that were addressed almost within the precincts of St Sophia to the statue of the empress. The haughty spirit of Eudoxia was inflamed by the report of a discourse commencing with the words—"Herodias is again furious; Herodias again dances; she once more demands the head of John"; and though the report was false, it sealed the doom of the archbishop. A new council was summoned, more numerous and more subservient to the wishes of Theophilus; and troops of barbarians were quartered in the city to overawe the people. Without examining it, the council confirmed the former sentence, and, in accordance with canon 12 of the Synod of Antioch (341), pronounced his deposition for having resumed his functions without their permission.

He was hurried away to the desolate town of Cucusus (Cocysus), among the ridges of Mount Taurus, with a secret hope, perhaps, that he might be a victim to the Isaurians on the march, or to the more implacable fury of the monks. He arrived at his destination in safety; and the sympathies of the people, which had roused them to fire the cathedral and senate-house on the day of his exile, followed him to his obscure retreat. His influence also became more powerfully felt in the metropolis than before. In his solitude he had ample leisure for forming schemes of missionary enterprise among Persians and Goths, and by his correspondence with the different churches he at once baffled his enemies and gave greater energy to his friends. This roused the emperor to visit him with a severer punishment, though Innocent I. of Rome and the emperor Honorius recognized his orthodoxy and besought his return. An order was despatched for his removal to the extreme desert of Pityus; and his guards so faithfully obeyed their instructions that, before he reached the sea-coast of the Euxine, he expired at Comana in Pontus, in the year 407. His exile gave rise to a schism in the church, and the Johannists (as they were called) did not return to communion with the archbishop of Constantinople till the relics of the saint were, 30 years after, brought back to the Eastern metropolis with great pomp and the emperor publicly implored forgiveness from Heaven for the guilt of his ancestors. The festival of St Chrysostom is kept in the Greek Church on the 13th of November, and in the Latin Church on the 27th of January.

In his general teaching Chrysostom elevates the ascetic

element in religion, and in his homilies he inculcates the need of personal acquaintance with the Scriptures, and denounces ignorance of them as the source of all heresy. If on one or two points, as, for instance, the invocation of saints, some germs of subsequent Roman teaching may be discovered, there is a want of anything like the doctrine of indulgences or of compulsory private confession. Moreover, in writing to Innocent, bishop of Rome, he addresses him as a brother metropolitan, and sends the same letter to Venerius, bishop of Milan, and Chromatius, bishop of Aquileia. His correspondence breathes a most Christian spirit, especially in its tone of charity towards his persecutors. In exegesis he is a pure Antiochene, basing his expositions upon thorough grammatical study, and proceeding from a knowledge of the original circumstances of composition to a forceful and practical application to the needs of his day and of all time. With his exegetical skill (he was inferior in pure dogma to Theodore of Mopsuestia) he united a wide sympathy and a marvellous power of oratory.

The voluminous works of Chrysostom fall into three groups. To the days of his early desert life is probably to be assigned the treatise *On Priesthood*, a book full of wise counsel. To the years of his presbyterate and episcopate belong the great mass of homilies and commentaries, among which those *On the Statues*, and on *Matthew*, *Romans* and *Corinthians*, stand out pre-eminently. His letters belong to the last years, the time of exile, and with his other works are valuable sources for the history of his time.

The manuscripts are very numerous, and many of them are of great antiquity, as are the Syriac and other translations. The best edition is that of Bernard de Montfaucon in 13 vols. fol. (1718-1738), reproduced with some improvements by Migne (*Patrol. Graec.* xlvii.-lxiv.); but this edition is greatly indebted to the one issued more than a century earlier (1612) by Sir Henry Savile, provost of Eton College, from a press established at Eton by himself, which Hallam (*Lit. of Europe*, iii. 10, 11) calls "the first work of learning, on a great scale, published in England." F. Field admirably edited *S. Matthew* (Cambridge, 1839) and *Epistles of S. Paul* (Oxford, 1849-1855). J. A. Bengel's edition of *De Sacerdotio* (1725) has been often reprinted (e.g. Leipzig, 1887).

As authorities for the life, the most valuable are the ecclesiastical histories of Socrates, Sozomen and Theodoret; and amongst the moderns, Erasmus, Cave, Lardner and Tillemont, with the church history of Neander, and his monograph on the *Life and Times of Chrysostom*, translated by J. C. Stapleton. More recent are the lives by W. R. W. Stephens (London, 1871), R. W. Bush (London, 1885) and A. Peuch (Paris, 1891). F. W. Farrar's romance *Gathering Clouds* gives a good picture of the man and his times. For monographs on special points such as Chrysostom's theological position and his preaching, see the very full bibliography in E. Preuschen's article in Herzog-Hauck's *Realencyk.* iv.; also A. Harnack, *Hist. of Dogma*, iii. and iv. Some of the commentaries and homilies are translated in the Oxford Library of the Fathers.

CHUB (*Leuciscus cephalus*), a fish of the Cyprinid family, belonging to the same genus as the roach and dace. It is one of the largest of its family, attaining a length of 2 ft. and a weight of 5 to 7 lb. It does not avoid running waters, and is fond of insects, taking the fly readily, but its flesh, like that of the other *Leucisci*, is tasteless and full of bones. It is common in Great Britain and the continent of Europe. In America the name of "chub" is given to some other members of the family, and commonly to the horned dace (*Semnotilus atromaculatus*); well-known varieties are the river chub (*Hybopsis kentuckiensis*) and Columbia river chub (*Mylochilus caurinus*).

CHUBB, CHARLES (d. 1845), English locksmith, started a hardware business at Winchester, subsequently removing to Portsea. Here he improved on the "detector" lock (*q.v.*), originally patented in 1818 by his brother, Jeremiah Chubb. He soon moved to London and then to Wolverhampton, where he employed two hundred hands. In 1835 he patented a process intended to render safes (*q.v.*) burglar-proof and fireproof, and subsequently established a large safe-factory in London. He died on the 16th of May 1845, and was succeeded in the business by his son, John Chubb (1816-1872), who patented various improvements in the products of the firm and largely increased its output. The factories were combined under one roof in a model plant, and the business grew to enormous proportions:

After John Chubb's death the business was converted into a limited company under the management of his three sons.

CHUBB, THOMAS (1679-1746), English deist, the son of a maltster, was born at East Harnham, near Salisbury, on the 29th of September 1679. The death of his father (1688) cut short his education, and in 1694 he was apprenticed to a glove-maker in Salisbury, but subsequently entered the employment of a tallow-chandler. He picked up a fair knowledge of mathematics and geography, but theology was his favourite study. His habit of committing his thoughts to writing gave him a clear and fluent style. He made his first appearance as an author in the Arian controversy. A dispute having arisen about Whiston's argument in favour of the supremacy of the one God and Father, he wrote an essay, *The Supremacy of the Father Asserted*, which Whiston pronounced worthy of publication, and it was printed in 1715. A number of tracts followed, which were collected in 1730. For several years Chubb lived in the house of Sir Joseph Jekyll, master of the rolls, in what capacity it is not known; there are stories of his having waited at table as a servant out of livery. His love of independence drew him back to Salisbury, where by the kindness of friends he was enabled to devote the rest of his days to his studies. He died on the 8th of February 1746. Chubb is interesting mainly as showing that the rationalism of the intellectual classes had taken considerable hold upon the popular mind. Though he acquired little renown in England he was regarded by Voltaire and others as among the most logical of the deist school (see *DEISM*). His principal works are *A Discourse Concerning Reason* (1731), *The True Gospel of Jesus Christ* (1739), and *Posthumous Works*, 2 vols. (1748), the last containing "The Author's Farewell to his Readers."

CHUBUT, a territory of the southern Argentine Republic, part of what was formerly called Patagonia, bounded N. by Rio Negro, S. by Santa Cruz, E. by the Atlantic and W. by Chile. Pop. (1805) 3748; (1904, estimate) 9060; area, 93,427 sq. m. Except for the valleys in the Andean foothills, which are fertile and well forested, and the land along the banks of the Chubut river, which flows entirely across the territory from the Andes to the Atlantic, the country is a barren waste, covered with pebbles and scanty clumps of dwarfed vegetation, with occasional shallow saline lakes. The larger rivers are the Chubut and the Senguerr, the latter flowing into Lake Colhuapi. There are a number of large lakes among the Andean foothills, the best known of which are Fontana, La Plata and General Paz, and, in the interior, Colhuapi or Colhué and Musters, the latter named after the English naval officer who traversed Patagonia in 1870. Petroleum was found at Comodoro Rivadavia, in the S. part of the territory, toward the close of 1907, at a depth of 1768 ft. Chubut is known chiefly by the Welsh colony near the mouth of the Chubut river. The chief town of the Welsh, Rawson, is the capital of the territory, and Port Madryn on Bahia Nueva is its best port. Other colonies have been founded in the fertile valleys of the Andean foothills, but their growth is greatly impeded by lack of transportation facilities. (See further *PATAGONIA*.)

CHUDE, a tribal name used in both a special and a general sense. (1) It was the name given by the Russians to certain Esthonian tribes with whom they came in contact as they spread gradually over their present empire. It would seem that the northern Chudes are the Vepsas, of whom about 21,000 are said to live near Lake Onega and in the northern parts of the government of Novgorod, and that the southern Chudes are the Votes who occupy about thirty parishes in north-west Ingria. (2) As the Russians advanced eastwards they extended the name to various tribes whom they considered to be like the Esthonians, and in popular use it has come to be applied to any ancient non-Russian people in Siberia, at least as far east as the Altai. In particular, ancient mines, tumuli and the metal work often found in them are commonly known as Chudish. Some investigators have used the word in a more restricted sense of Permian antiquities and their builders, but it seems to be a popular expression not corresponding to any historical or scientific division of mankind.

CHUGUYEV, a town of Russia, in the government of Kharkov, 25 m. E.S.E. of the town of Kharkov, on the right bank of the northern Donets. It is a place of some strategic importance, and had in 1897 a population of 11,877

CHUKCHI, **CHANKTUS** ("Men") or **TUSKI** ("Brothers" or "Confederates"), a Mongoloid people inhabiting the northeasternmost portion of Siberia on the shores of the Arctic Ocean and Bering Sea. They are settled in small groups along the Arctic coast between the Bering Straits and the Kolyma river, or wander as far inland as the Anadyr basin. Though their territory embraces some 300,000 odd sq. m., the most trustworthy estimates put their numbers at but a few thousands. They were first carefully studied by the members of the Nordenskjöld expedition (1878-79), who describe them as tall, lean, with somewhat irregular features—hence de Quatrefages classes them as "Allophylian Whites." The accounts of their physical characteristics are somewhat confused owing to the presence of the true Eskimo in the Chukchi domain. The typical Chukchi is round-headed, and thus distinct from the long-headed Eskimo, with broad, flat features and high cheek-bones. The nose is often so buried between the puffed cheeks that a ruler might be laid across the face without touching it. The lips are thick, and the brow low. The hair is coarse, lank and black. The general muscular development is good, though usually the body is stunted. It has been suggested that they emigrated from the south, possibly from the Amur basin. In their arctic homes they long carried on war with the Ongkilon (Ang-kali) aborigines, gradually merging with the survivors and also mixing both with the Kùsmen Koryaks (*q.v.*) and the Chuklukmuit Eskimo settled on the Asiatic side of Bering Strait. Their racial characteristics make them an ethnological link between the Mongols of central Asia and the Indians of America. Some authorities affiliate them to the Eskimo because they are believed to speak an Eskimo dialect. But this is merely a trade jargon, a hotchpotch of Eskimo, Chukchi, Koryak, English and even Hawaiian. The true Chukchi language, of which Nordenskjöld collected a thousand words, is distinct from Eskimo and akin to Koryak, and Nordenskjöld sums the problem up with the remark—"this race settled on the primeval route between the Old and New World bears an unmistakable stamp of the Mongols of Asia and the Eskimo and Indians of America."

The Chukchi are divided into the "Fishing Chukchi," who have settled homes on the coast, and the "Reindeer Chukchi," who are nomads. The latter breed reindeer (herds of more than 10,000 are not uncommon), live on the flesh and milk, and are generally fairly prosperous; while the fishing folk are very poor, begging from their richer kinsfolk hides to make tents and clothes. The Chukchi were formerly warlike and vigorously resisted the Russians, but to-day they are the most peaceable of folks, amiable in their manners, affectionate in family life and good-humoured. But this gentleness does not prevent them from killing off the old and infirm. They believe in a future life, but only for those who die a violent death. Thus it is regarded as an act of filial piety for a son to kill his parent or a nephew his uncle. This tribal custom is known as *kamitok*; and of it Mr Harry de Windt writes (*Through the Gold Fields of Alaska to Bering Strait*, 1898), "The doomed one takes a lively interest in the proceedings, and often assists in the preparation for his own death. The execution is always preceded by a feast, where seal and walrus meat are greedily devoured, and whisky consumed till all are intoxicated. A spontaneous burst of singing and the muffled roll of walrus-hide drums then herald the fatal moment. At a given signal a ring is formed by the relations and friends, the entire settlement looking on from the background. The executioner (usually the victim's son or brother) then steps forward, and placing his right foot behind the back of the condemned, slowly strangles him to death with a walrus thong. A *kamitok* took place during the latter part of our stay." The Chukchi are nominally Christians, but sacrifice animals to the spirits of the rivers and mountains, and also practise Shamanism. In personal habits the people are indescribably filthy. They are polygamous, but the women are treated kindly. The children are specially

petted, and are so wrapped up to protect them from the cold that they have been described as resembling huge balls crossed by a bar, their arms having to remain outstretched owing to the bulk of their wrappings. Chukchi women are often tattooed with two black-blue convex lines running from the eye to the chin. Since their adoption of Christianity the men sometimes have a Latin cross tattooed on their chins. The Chukchi burn their dead or expose them on platforms to be devoured by ravens.

See Harry de Windt, *Through the Gold Fields of Alaska to Bering Strait* (1898); Dittmar, "Über die Koriaken u. ihnen nahe verwandten Tchouktchen," in *Bul. Acad. Sc.* (St Petersburg), xii. p. 99; Hooper, *Ten Months among the Tents of the Tuski*; W. H. Dall, *Contributions to North American Ethnology*, vol. i. (1877).

CHULALONGKORN, **PHRA PARAMINDR MAHA** (1853-1910), king of Siam, eldest son of King Maha Mongkut, was born on the 21st of September 1853. His full signature, used in all important state documents, consists of twenty-seven names, but it is by the first four that he is usually known. Educated in his childhood by English teachers, he acquired a good knowledge of the English language and of Western culture. But his surroundings were purely oriental, and his boyhood was spent, according to custom, in a Buddhist monastery. He succeeded to the throne on the death of his father, 1st October 1868, and was crowned on the 11th of November following, a ceremony marked by the innovation of permitting the presence of Europeans. Until his majority in 1873 the government was carried on by a regent, the young king retiring to a Buddhist monastery, and later making a tour through India and the Dutch East Indies, an undertaking until then without precedent among the potentates of eastern Asia. He had no sooner taken the reins of power than he gave evidence of his recognition of the importance of modern culture by abolishing slavery in Siam. He simplified court etiquette, no longer demanding, for example, that his subjects should approach him on hands and knees. Still more important, in view of the numerous races and creeds included among his subjects, was the proclamation of liberty of conscience. This was followed by the erection of schools and hospitals, the construction of roads and railways, and the further development of the army and fleet which his father had initiated. To him Siam is indebted for its standard coinage, its postal and telegraph service, and for the policing, sanitation and electric-lighting of Bangkok. Several of his sons, including the crown prince, were educated in England, and in the summer of 1897 he himself visited England, arriving at Portsmouth in his yacht on the 29th of July. On the 4th of August he was received by Queen Victoria at Osborne. After a tour in Great Britain he proceeded to Berlin, Brussels, and the Hague and Paris. (See also **SIAM**.)

CHUMBI VALLEY, a valley connecting Tibet (*q.v.*) with the frontier of British India. Lying on the southern slopes of the Himalayas at an altitude of about 9500 ft. above the sea, the valley is wedged in between Bhutan and Sikkim, and does not belong geographically but only politically to Tibet. This was the route by which the British mission of 1904 advanced. Before the date of that expedition the valley had acquired a reputation for beauty and fertility, which was subsequently found to be only comparative in relation to the barrenness of the rest of the Tibetan frontier. The summer months, though not hot, are relaxing and enervating.

CHUNAR, or **CHUNARGHUR**, a town and ancient fortress of India, in the district of Mirzapur, in the United Provinces, situated on the south bank of the Ganges. Pop. (1901) 9926. The fort occupies a conspicuous site on the summit of an abrupt rock which commands the river. It was at one time a place of great strength, and still contains a magazine, and is fortified with batteries. In the old citadel on the height, the remains of a Hindu palace with some interesting carvings indicate the former importance of the place. The town, which consists of one or two straggling streets, contains a handsome English church. Chunar is first mentioned in the 16th century, when in possession of Sing Joanpore. In 1530 it became the residence of Shere Shah the Afghan, and forty-five years later was recovered by the emperor Akbar after sustaining a siege of six months. It fell into the

hands of the English under General Carnac in 1763 after a prolonged resistance which caused considerable loss to the assailants. A treaty with the nawab of Oudh was signed here by Warren Hastings on behalf of the East India Company in September 1781.

CHUNCHO, a tribe of South American Indians, living in the forests east of Cuzco, central Peru. They are a fierce and savage people who have preserved their independence. They are said to be akin to their neighbours the Antis. They dwell in communal houses, and live chiefly by hunting. Chuncho has also been used to describe one of three aboriginal stocks of Peru, the others being Quichua and Aymara.

CH'UNGK'ING, a city in the province of Szech'uen, China, on the left bank of the Yangtze; at its point of junction with the Kialing, in 29° 33' N., and 107° 2' E. It is surrounded by a crenelated stone wall, which is 5 m. in circumference and is pierced by nine gates. It is the commercial centre for the trade, not only of Szech'uen, but of all south-western China. The one highway between Szech'uen and the eastern provinces is the Yangtze river route, as owing to the mountainous nature of the intervening country land transit is almost impracticable. The import trade brought up by large junks from Ich'ang, and consisting of cotton cloth, yarn, metals and foreign manufactures, centres here, and is distributed by a class of smaller vessels up the various rivers of the provinces. Native produce, such as yellow silk, white wax, hides, rhubarb, musk and opium, is here collected and repacked for conveyance to Hankow, Shanghai or other parts of the empire. The city was opened to foreign trade by convention with the British government in 1891, with the proviso, however, that foreign steamers should not be at liberty to trade there until Chinese-owned steamers had succeeded in ascending the river. This restriction was abolished by the Japanese treaty of 1895, which declared Ch'ungk'ing open on the same terms as other ports. After that date the problem of steam navigation on the section of the river between Ich'ang and Ch'ungk'ing occupied attention. By 1907 a small steamer had been navigated up the rapids, but it remained a question how far steam navigation could be made a practical success. The trade was carried on by native craft, hauled up against the strength of the current in the worst places by a line of trackers on the bank. The great rise in the river during the summer months, at Ch'ungk'ing ordinarily 70 ft. and occasionally as much as 96 ft., added to the difficulties. The population of Ch'ungk'ing, including the city of Kiangpei on the opposite bank of the Kialing river, is about 300,000. The foreign residents are very few. In 1898 the value of the trade passing through the maritime customs was £2,614,000, and in 1904 £4,214,568, of which imports counted for £2,644,777 and exports for £1,569,791.

CHUPATTY, an Anglo-Indian term for an unleavened cake of bread. The word represents the Hindustani *chapati*, and is applied to the usual form of native bread, the staple food of upper India. The chupatty is generally made of coarse wheat flour, patted flat with the hand, and baked upon a griddle. In the troubled times that preceded the mutiny of 1857 chupatties were circulated from village to village throughout India, apparently as a token of discontent.

CHUPRIYA (sometimes written *Tiupriia*; Croatian *Cuprija*), the capital of the Morava department of Serbia, on the railway from Belgrade to Nish, and on the right bank of the Morava, which is navigable up to this point by small sailing-vessels. Pop. (1900) about 6000. Some of the finest Serbian cattle are bred in the neighbouring lowlands, and the town has a considerable trade in plums and other farm-produce. A light railway, leading to several important collieries, runs for 13 m. through the beech-forests and mountains on the east. Cloth is woven at Parachin, 5 m. S.; and Yagodina, 8 m. W. by N., is an important market town. Among the foothills of the Golubinye Range, 7 m. E.N.E., is the 14th-century Ravanitsa monastery, with a ruined fort and an old church—their walls and frescoes pitted by Turkish bullets. There is a legend that here the Servian tsar Lazar (1374-1389) was visited by an angel, who bade him choose between an earthly and a heavenly crown. In

accordance with his choice, Lazar fell fighting at Kossovo, and was buried at Ravanitsa; his body being afterwards transferred, through fear of the Turks, to another Ravanitsa, in eastern Slavonia. His crucifix is treasured among the monastic archives, which also contain a charter signed by Peter the Great of Russia (1672-1725). Manasia (*Manasiya*), the still more celebrated foundation of Stephen, the son and successor of Lazar, lies 12 m. N. of Ravanitsa. Built in a cleft among the hills which line the river Resava, an affluent of the Morava, this monastery is enclosed in a fortress, whose square towers, and curtain without loopholes or battlements, remain largely intact. Within the curtain stand the monastic buildings, a large garden and a cruciform chapel, with many curious old stone carvings, half hidden beneath whitewash. Numerous gifts from the Russian court, such as gospels lettered in gold and silver relief, or jewelled crucifixes, are preserved on the spot; but the valuable library was removed, in the 15th century, to Mount Athos.

CHUQUISACA, a department of S.E. Bolivia, bounded N. by Cochabamba and Santa Cruz, E. by Santa Cruz and Brazil, S. by Tarija, and W. by Potosi. It lies partly upon the eastern plateau of Bolivia and partly upon the great plains of the upper La Plata basin; area, 26,418 sq. m. The Pilcomayo, a large tributary of the Paraguay, crosses N.W. to S.E. the western part of the department. The climate of the lowlands is hot, humid and unhealthy, but that of the plateau is salubrious, though subject to greater extremes in temperature and rainfall. The seasons are sharply divided into wet and dry, the eastern plains becoming great lagoons during the wet season, and parched deserts during the dry. The mineral resources are important, but are less developed than those of Potosi and Oruro. Grazing is the principal industry of the plains, and cattle, sheep, goats and llamas are raised and cereals grown in the fertile valleys of the plateau. Three rough highways connect the department with its neighbours on the N. and W., and pack animals are the common means of transporting merchandise. The population was estimated at 204,434 in 1900, and is largely composed of Indians and *mestizos*. The plateau Indians are generally Aymaras, but on the eastern plains there are considerable settlements of partly civilized Chiriguano, of Guarani origin. The department is divided into four provinces, the greater part of the lowlands being unsettled and without effective political organization. Its principal towns are Sucre, Camargo, Padilla and Yotala.

CHURCH, FREDERICK EDWIN (1826-1900), American landscape painter, was born at Hartford, Connecticut, on the 4th of May 1826. He was a pupil of Thomas Cole at Catskill, New York, where his first pictures were painted. Developing unusual technical dexterity, Church from the beginning sought for his themes such marvels of nature as Niagara Falls, the Andes, and tropical forests—he visited South America in 1853 and 1857,—volcanoes in eruption, and icebergs, the beauties of which he portrayed with great skill in the management of light, colour, and the phenomena of rainbow, mist and sunset, rendering these plausible and effective. In their time these paintings awoke the wildest admiration and sold for extravagant prices, collectors in the United States and in Europe eagerly seeking them, though their vogue has now passed away. In 1849 Church was made a member of the National Academy of Design. His "Great Fall at Niagara" (1857) is in the Corcoran Art Gallery, Washington, D.C., and a large "Twilight" is in the Walters Gallery, Baltimore, Maryland. Among his other canvases are "Andes of Ecuador" (1855), "Heart of the Andes" (1859), "Cotopaxi" (1862), "Jerusalem" (1870), and "Morning in the Tropics" (1877). He died on the 7th of April 1900, at his house on the Hudson river above New York City, where he had lived and worked for many years. He was the most prominent member of the so-called "Hudson River School" of American artists.

CHURCH, GEORGE EARL (1835-1910), American geographer, was born in New Bedford, Massachusetts, on the 7th of December 1835. He was educated as a civil engineer, and was early engaged on the Hoosac Tunnel. In 1858 he joined an exploring expedition to South America. During the American Civil War he

served (1862-1865) in the Army of the Potomac, rising to the command of a brigade and the rank of colonel; and in 1866-1867 he was war correspondent of the *New York Herald* in Mexico. He explored the Amazon (1868-1879), and gradually became the leading authority on that region of South America, being appointed United States commissioner to report on Ecuador in 1880, and visiting Costa Rica in 1895 to report on its debt and railways. He wrote extensively on South and Central American geography, and became a vice-president of the Royal Geographical Society (London), and in 1898 president of the geographical section of the British Association.

CHURCH, SIR RICHARD (1784-1873), British military officer and general in the Greek army, was the son of a Quaker, Matthew Church of Cork. He was born in 1784, and at the age of sixteen ran away from home and enlisted in the army. For this violation of its principles he was disowned by the Society of Friends, but his father bought him a commission, dated the 3rd of July 1800, in the 13th (Somersetshire) Light Infantry. He served in the demonstration against Ferrol, and in the expedition to Egypt under Sir Ralph Abercromby in 1801. After the expulsion of the French from Egypt he returned home, but came back to the Mediterranean in 1805 among the troops sent to defend the island of Sicily. He accompanied the expedition which landed in Calabria, and fought a successful battle against the French at Maida on the 6th of July 1806. Church was present on this occasion as captain of a recently raised company of Corsican Rangers. His zeal attracted the notice of his superiors, and he had begun to show his capacity for managing and drilling foreign levies. His Corsicans formed part of the garrison of Capri from October 1806 till the island was taken by an expedition directed against it by Murat, in September 1808, at the very beginning of his reign as king of Naples. Church, who had distinguished himself in the defence, returned to Malta after the capitulation.

In the summer of 1809 he sailed with the expedition sent to occupy the Ionian Islands. Here he increased the reputation he had already gained by forming a Greek regiment in English pay. It included many of the men who were afterwards among the leaders of the Greeks in the War of Independence. Church commanded this regiment at the taking of Santa Maura, on which occasion his left arm was shattered by a bullet. During his slow recovery he travelled in northern Greece, and Macedonia, and to Constantinople. In the years of the fall of Napoleon (1813 and 1814) he was present as English military representative with the Austrian troops until the campaign which terminated in the expulsion of Murat from Naples. He drew up a report on the Ionian Islands for the congress of Vienna, in which he argued in support, not only of the retention of the islands under the British flag, but of the permanent occupation by Great Britain of Parga and of other formerly Venetian coast towns on the mainland, then in the possession of Ali Pasha of Iannina. The peace and the disbanding of his Greek regiment left him without employment, though his reputation was high at the war office, and his services were recognized by the grant of a companionship of the Bath. In 1817 he entered the service of King Ferdinand of Naples as lieutenant-general, with a commission to suppress the brigandage then rampant in Apulia. Ample powers were given him, and he attained a full measure of success. In 1820 he was appointed governor of Palermo and commander-in-chief of the troops in Sicily. The revolution which broke out in that year led to the termination of his services in Naples. He escaped from violence in Sicily with some difficulty. At Naples he was imprisoned and put on his trial by the government, but was acquitted and released in January 1821; and King George IV. conferred on him a knight commandership of the Hanoverian order.

The rising of the Greeks against the Turks, which began at this time, had his full sympathy from the first. But for some years he had to act only as the friend of the insurgents in England. In 1827 he took the honourable but unfortunate step of accepting the commandership-in-chief of the Greek army. At the point of anarchy and indiscipline to which they had now fallen, the Greeks could no longer form an efficient army, and could look for salvation only to foreign intervention. Sir Richard Church, who

landed in March, was sworn "archistrategos" on the 15th of April 1827. But he could not secure loyal co-operation or obedience. The rout of his army in an attempt to relieve the acropolis of Athens, then besieged by the Turks, proved that it was incapable of conducting regular operations. The acropolis capitulated, and Sir Richard turned to partisan warfare in western Greece. Here his activity had beneficial results, for it led to a rectification in 1832, in a sense favourable to Greece, of the frontier drawn by the powers in 1830 (see his *Observations on an Eligible Line of Frontier for Greece*, London, 1830). Church had, however, surrendered his commission, as a protest against the unfriendly government of Capo d'Istria, on the 25th of August 1829. He lived for the rest of his life in Greece, was created general of the army in 1854, and died at Athens on the 30th of March 1873. Sir Richard Church married in 1826 Elizabeth Augusta Wilmot-Horton, who survived him till 1878.

See *Sir Richard Church*, by Stanley Lane Poole (London, 1890); *Sir Richard Church in Italy and Greece*, by E. M. Church (Edinburgh, 1895), based on family papers (an Italian version, *Brigantaggio e società segrete nelle Puglie, 1817-1828*, executed under the direction of Carlo Lacaita, appeared at Florence in 1899). The MS. Correspondence and Papers of Sir Richard Church, in 29 vols., now in the British Museum (Add. MSS. 36543-36571), contain invaluable material for the history of the War of Greek Independence, including a narrative of the war during Church's tenure of the command, which corrects many errors in the published accounts and successfully vindicates Church's reputation against the strictures of Finlay, Mendelssohn-Bartholdy, and other historians of the war (see *Cam. Mod. Hist.* x. p. 804). (D. H.)

CHURCH, RICHARD WILLIAM (1815-1890), English divine, son of John Dearman Church, brother of Sir Richard Church (*q.v.*), a merchant, was born at Lisbon on the 25th of April 1815, his early years being mostly spent at Florence. After his father's death in 1828 he was sent to a school of a pronounced evangelical type at Redlands, Bristol, and went in 1833 to Wadham College, Oxford, then an evangelical college. He took first-class honours in 1836, and in 1838 was elected fellow of Oriel. One of his contemporaries, Richard Mitchell, commenting on this election, said: "There is such a moral beauty about Church that they could not help taking him." He was appointed tutor of Oriel in 1839, and was ordained the same year. He was an intimate friend of J. H. Newman at this period, and closely allied to the Tractarian party. In 1841 No. 90 of *Tracts for the Times* appeared, and Church resigned his tutorship. In 1844-1845 he was junior proctor, and in that capacity, in concert with his senior colleague, vetoed a proposal to censure Tract 90 publicly. In 1846 Church, with others, started *The Guardian* newspaper, and he was an early contributor to *The Saturday Review*. In 1850 he became engaged to Miss H. F. Bennett, of a Somersetshire family, a niece of George Moberly, bishop of Salisbury. After again holding the tutorship of Oriel, he accepted in 1852 the small living of Whatley in Somersetshire, near Frome, and was married in the following year. He was a diligent parish priest and a serious student, and contributed largely to current literature. In 1869 he refused a canonry at Worcester, but in 1871 he accepted, most reluctantly (calling it "a sacrifice *en pure perte*"), the deanery of St Paul's, to which he was nominated by W. E. Gladstone.

His task as dean was a complicated one. It was (1) the restoration of the cathedral; (2) the adjustment of the question of the cathedral revenues with the Ecclesiastical Commissioners; (3) the reorganization of a conservative cathedral staff with anomalous vested rights. He described the intention of his appointment to be "that St Paul's should waken up from its long slumber." The first year that he spent at St Paul's was, writes one of his friends, one of "misery" for a man who loved study and quiet and the country, and hated official pomp and financial business and ceremonious appearances. But he performed his difficult and uncongenial task with almost incredible success, and is said never to have made an enemy or a mistake. The dean was distinguished for uniting in a singular degree the virtues of austerity and sympathy. He was pre-eminently endowed with the faculty of judgment, characterized by Canon Scott Holland as the gift of "high and fine and sane

and robust decision." Though of unimpressive stature, he had a strong magnetic influence over all brought into contact with him, and though of a naturally gentle temperament, he never hesitated to express censure if he was convinced it was deserved. In the pulpit the voice of the dean was deliberately monotonous, and he employed no adventitious gesture. He may be described as a High Churchman, but of an essentially rational type, and with an enthusiasm for religious liberty that made it impossible for him to sympathize with any unbalanced or inconsiderate demands for deference to authority. He said of the Church of England that there was "no more glorious church in Christendom than this inconsistent English Church." The dean often meditated resigning his office, though his reputation as an ecclesiastical statesman stood so high that he was regarded in 1882 as a possible successor to Archbishop Tait. But his health and mode of life made it out of the question. In 1888 his only son died; his own health declined, and he appeared for the last time in public at the funeral of Canon Liddon in 1890, dying on 9th December 1890, at Dover. He was buried at Whatley.

The dean's chief published works are a *Life of St Anselm* (1870), the lives of *Spenser* (1879) and *Bacon* (1884) in Macmillan's "Men of Letters" series, an *Essay on Dante* (1878), *The Oxford Movement* (1891), together with many other volumes of essays and sermons. A collection of his journalistic articles was published in 1897 as *Occasional Papers*. In these writings he exhibits a great grasp of principles, an accurate mastery of detail, and the same fusion of intelligent sympathy and dispassionate judgment that appeared in his handling of business. His style is lucid, and has the charm of austerity. He stated that he had never studied style *per se*, but that he had acquired it by the exercise of translation from classical languages; that he watched against the temptation of using unreal and fine words; that he employed care in his choice of verbs rather than in his use of adjectives; and that he fought against self-indulgence in writing just as he did in daily life. His sermons have the same quality of self-restraint. His private letters are fresh and simple, and contain many unaffected epigrams; in writing of religious subjects he resolutely avoided dogmatism without ever sacrificing precision. The dean was a man of genius, whose moral stainlessness and instinctive fire were indicated rather than revealed by his writings.

See *Life and Letters of Dean Church*, by his daughter, M. C. Church (1895); memoir by H. C. Beeching in *Dict. Nat. Biog.*; and D. C. Lathbury; *Dean Church* (1907). (A. C. BE.)

CHURCH (according to most authorities derived from the Gr. *κυριακὸν* [δῶμα], "the Lord's [house]," and common to many Teutonic, Slavonic and other languages under various forms—Scottish *kirk*, Ger. *Kirche*, Swed. *kirka*, Dan. *kirke*, Russ. *tserkov*, Bulg. *cerkova*, Czech *cirkev*, Finn. *kirkko*, &c.), a word originally applied to the building used for Christian worship, and subsequently extended to the Christian community (*ecclesia*) itself. Similarly the Greek word *ecclesia* (ἐκκλησία), "assembly," was very early transferred from the community to the building, and is used in both senses, especially in the modern Romance and Celtic languages (e.g. Fr. *église*, Welsh *eglwys*, &c.).

(1) *Church Architecture*.—From the strictly architectural point of view the subject of church building, including the development of the various styles and the essential features of the construction and arrangement of churches, is dealt with elsewhere (see ARCHITECTURE; ABBEY; BASILICA). It is, however, impossible to understand the development of church architecture without realizing its intimate connexion with that of the doctrine, organization and ritual of the Christian Church as a religious community, and a brief sketch of this connexion may be given here by way of introduction to the more technical treatment of the subject. In general it may be said of church architecture, more truly than of any other, that artistically it is "frozen music." It is true that at all times churches have been put to secular uses; in periods of unrest, as among the Nestorian Christians now, they were sometimes built to serve at need as fortresses; their towers were used for beacons, their naves for meetings on secular affairs. But as a rule, and especially in the

great periods of church architecture, their builders were untrammelled by any utilitarian considerations; they built for the glory of God, for their own glory perhaps, in honour of the saints; and their work, where it survives, is (as it were) a petrification of their beliefs and ideals. This is, of course, more true of the middle ages than of the times that preceded and followed them; the Church under the Roman empire hardly as yet realized the possibilities of "sermons in stones," and took over, with little change, the model of the secular and religious buildings of pagan Rome; the Renaissance, essentially a neo-pagan movement, introduced disturbing factors from outside, and, though developing a style very characteristic of the age that produced it, started that archaeological movement which has tended in modern times to substitute mere imitations of old models for any attempt to express in church architecture the religious spirit of the age.

The earliest type of Christian Church, out of which the others developed, was the basilica. The Church, emerging in the 4th century into imperial favour, and established as part of the organization of the Roman empire, simply adopted that type of secular official building which she found convenient for her purposes. The clergy, now Roman officials, vested in the robes of the civil dignitaries (see VESTMENTS), took their seats in the apse of the basilica where the magistrates were wont to sit in front of them the holy table, facing the congregation. The *cancelli*, the lattice or bar, which in the civil tribunal had divided the court from the litigants and the public, now served to separate clergy and laity. This arrangement still survives in some of the ancient churches of Rome; it has been revived in many Protestant places of worship. It symbolized principally an official distinction; but with the theocratizing of the empire in the East and its decay in the West the accentuation of the mystic powers of the clergy led to a more complete separation from the laity, a tendency which left its mark on the arrangements of the churches. In the East the *cancelli*, under the influence possibly of the ritual of the Jewish temple, developed into the *iconostasis*, the screen of holy pictures, behind the closed doors of which the supreme act of the eucharistic mystery is hidden from the lay people. In the West the high altar was moved to the east end (the *presbyterium*) with a space before it for the assisting deacons and subdeacons (the chancel proper) railed off as a spot peculiarly holy (now usually called the sanctuary); between this and the nave, where the laity were, was the choir, with seats for the clergy on either side. The whole of this space (sanctuary and choir) came to be known as the "chancel." This was divided from the nave, sometimes by an arch forming part of the structure of the building, sometimes by a screen, or by steps, sometimes by all three (see CHANCEL). The division of churches into chancel and nave, the outcome of the sacramental and sacerdotal spirit of the Catholic Church, may be taken as generally typical of church construction in the medieval West, though there were exceptions, e.g. the round churches of the Templars. There were, however, further changes, the result partly of doctrinal developments, partly of that passion for symbolism which by the 13th century had completed the evolution of the Catholic ritual. Transepts were added, to give to the ground-plan of the building the figure of the cross. The insistence on the unique efficacy of the sacrifice of the altar led to the multiplication of masses, and so of altars, which were placed in the transepts or aisles or in chapels, dedicated to the saints whose relics they enshrined. The chief of these subsidiary chapels, that of the Blessed Virgin (or Lady chapel), behind the high altar, was often of large size. Finally, for the convenience of processions, the nave and chancel aisles were carried round behind the high altar as ambulatories.

The Romanesque churches, still reminiscent of antique models, had preserved all the simplicity of the ancient basilicas with much more than their grandeur; but the taste for religious symbolism which culminated in the 13th century, and the imaginative genius of the northern peoples, transformed them into the marvellous dreams in stone of the "Gothic" period. Churches now became, in form and decoration, epitomes of the Christian scheme of salvation as the middle ages understood it.

In the plan of the buildings and their decoration everything still remained subordinate to the high altar; but though on this and its surroundings ornament was most lavishly expended, the churches—wherever wealth permitted—were covered within and without with sculpture or painting: scenes from the Old and New Testaments, from the lives of saints, even from every-day life; figures of the Almighty, of Christ, of the Virgin Mother, of apostles, saints, confessors; pictures of the joys of heaven and the torments of hell; and outside, grimacing from every angle, demons and goblins, amusing enough to us but terrible to the age that set them there, visible embodiments of the evil spirits driven from within the sacred building by the efficacy of the holy rites.

In considering the origins of medieval churches, moreover, it must be borne in mind that as a general rule their builders were not actuated by the motives usual in modern times, at least among Protestants. The size of churches was not determined by the needs of population but by the piety and wealth of the founders; and the same applies to their number. Often they were founded as acts of propitiation of the Almighty or of the saints, and the greater their size and splendour the more effective they were held to be for their purpose. Local rivalry, too, played a large part, one wealthy abbey building "against" another, much in the same way as modern business houses endeavour to outshine each other in the magnificence of their buildings. Of all the mixed motives that went to the evolution of church architecture in the middle ages, this rivalry in ostentation was probably the most fertile in the creation of new forms. A volume might be written on the economic effects of this locking up of vast capital in unproductive buildings. In Catholic countries (notably in Ireland) great churches are still built out of the savings of a poverty-stricken peasantry; and from this point of view the destruction of churches in the 16th century was probably a benefit to the world. This, however, is a consideration altogether alien to the Christian spirit, the aspiration of which is to lay up treasures not on earth but in heaven.

The Reformation was a fateful epoch in the history of church architecture. The substitution of the Bible for the Mass destroyed the *raison d'être* of churches as the middle ages had made them. Pictures and stories, carved or painted, seemed no longer necessary now that the open Bible was in the hands of the common people; they had been too often prostituted, moreover, to idolatrous uses,—and "idolatry" was the worst of blasphemies to the re-discoverers of the Old Testament. Save in some parts of Germany, where the influence of Luther saved the churches from wreck, an iconoclastic wave spread over the greater part of Western Europe, wherever the "new religion" prevailed; everywhere churches were cleared of images and reduced to the state of those described by William Harrison in his *Description of England* (1570), only the "pictures in glass" being suffered in some cases to survive for a while "by reason of the extreme cost of replacing them." The structures of the churches, however, remained; and these, even in countries which departed furthest from the Catholic system, served in some measure to keep its tradition alive. Protestantism has, indeed, produced a distinctive church architecture, *i.e.* the conventicle type, favoured more especially by the so-called "Free Churches." Its distinctive features are pulpit and auditorium, and it is symbolical of the complete equality of ministers and congregation. In general, however, Protestant builders have been content to preserve or to adapt the traditional models. It would be interesting in this connexion to trace the reverse effect of church architecture upon church doctrine. In England, for instance, the chancels were for the most part disused after the Reformation (see Harrison, *op. cit.*), but presently they came into use again, and on the Catholic revival in the Church of England in the 19th century it is certain that the medieval churches exercised an influence by giving a sense of fitness, which might otherwise have been lacking, to the restoration of medieval ritual. A similar tendency has of late years been displayed in the Established Church of Scotland.

Churches, as the outcome of the organization of the Catholic Church, are divided into classes as "cathedral," "conventual"

and "collegiate," "parochial" and "district" churches. It must be noted, however, that the term cathedral (*q.v.*), ecclesiastically applicable to any church which happens to be a bishop's see, architecturally connotes a certain size and dignity, and is sometimes applied to churches which have never been, or have long ceased to be, bishop's seats. (W. A. P.)

(2) *The Religious Community*.—In the sense of Christian community (*ecclesia*) the word "Church" is applied in a narrow sense to any one of the numerous separate organizations into which Christendom is divided (*e.g.* Roman Catholic Church, Orthodox Eastern Church, Church of England, Evangelical [Lutheran] Church)—these are dealt with under their several headings—and in a comprehensive sense (with which we are now concerned) to the general body of all those "who profess and call themselves Christians." Religion, according to the old definition, is the bond which binds the soul of man to God.¹ It begins as the relation of a tribe to its God. Personal religious conviction grows out of the tribal (corporate) religious bond. But the social instinct is strong. Men owning the same religious convictions will naturally draw together into some sort of association. Using the word religion to cover all the imperfect ways in which men have felt after God, we note that in every case men have found the need alike of a teacher and of fellowship. Thus the idea of a church as "the pillar and ground of the truth" (1 Tim. iii. 15) corresponds to some of the primary needs of man. Even at Stonehenge, the oldest relic of prehistoric religion in England, where we picture in imagination the worship of the rising sun, nature worship degraded to a horrible depth by human sacrifice, we find struggling for expression the idea of a corporate religious life. From all the lower levels where superstition and cruelty reign, from the depths of fear inspired by fetishism, we look on to the higher level of Judaism as the progressive religion of the old world. This does not mean that we shut our eyes to the ideals of Greek philosophers, with whom morality was constantly outgrowing religion. "The vision of an ideal state which the master-mind of Plato contemplated, but thought too good ever to become true in actual realization, is full of aspirations which the Christian Church claims to satisfy. The problems of the relations of the life of the State and the life of the individual, which Aristotle ever suggests and never solves, are problems with which the Christian Church has at least attempted to deal."²

From the beginning of the history of the Jewish race the idea that the world is a kingdom under the rule of God began to find expression. The conception of Israel as "a kingdom of priests and a holy nation" (Exod. xix. 6) bore witness to it. The idea of kingship from the first was that of a ruler representing God. As time went on and even the dynasty of David failed in the persons of unworthy representatives to maintain this ideal, both psalmists and prophets taught the people to look beyond the earthly kingdom to the spiritual kingdom of which it was a type. But even Isaiah tended to think of the spiritual life and worship of the nation as a department of political organization only, controlled by the king and his princes. It was reserved for Jeremiah, in the darkest days of his life, to build up the ideal of a spiritual society which should weld Israel together, to proclaim a new covenant (xxxii. 31-34) which Jehovah would make with Israel when representatives of the previously exiled ten tribes should return with the exiles of Judah. This prophecy is instinct with the growing sense of the personal responsibility of individual men brought into communion with God. The religion of Israel from this time of the captivity ceased to be a merely national religion connected with particular forms of sacrifice in a particular land. The synagogues which traced their origin to the time of Ezekiel, when the sacrificial cultus was impossible, extended this ideal yet further. During the centuries preceding the birth of Christ there grew up an apocalyptic literature which regarded as a primary truth the conception of a

¹ Lactantius, *Inst. Div.* iv. 28 "Vinculo pietatis obstricti, Deo religati sumus unde ipsa religio nomen accepit." The etymology may be wrong, but this is the popular sense of the word.

² Darwell Stone, *The Christian Church*, p. 18.

kingdom of righteousness ruled over by a present God. The preaching of John the Baptist was thus in sympathy with the ideals of his generation, though the sternness of the repentance which he set forth as the necessary preparation for entrance into the new kingdom of heaven, which was to be made visible on earth, was not less repugnant to the men of his day than of later times. Christ's own teaching and that of his disciples began with the proclamation of the kingdom of God (or of heaven) (Luke iv. 43, viii. 1, ix. 2; Matt. x. 7). That he intended it to find outward expression in a visible society appears from the careful way in which he trained the apostles to become leaders hereafter, crowning that work by the institution of the sacraments of baptism and the Eucharist. "It was not from accident or for convenience that Christ formed a society."¹ His parables even more than his sermons reveal the principles of his endeavour. But he seldom used the word *ecclesia*, church, which became the universal designation of his society.

All the more emphatic is Christ's use of the term *ecclesia* upon the distinct advance in faith made by the apostles when St Peter as their spokesman confessed him to be "the Christ, the Son of the living God" (Matt. xvi. 16). Instantly came the reply, "I say unto thee, that thou art *Petros* (rockman), and on this *Petra* (rock) I will build my *ecclesia* (church); and the gates of Hades shall not prevail against it." On the rock of a human character, ennobled by faith in his divine Sonship, he could raise the church of the future, which should be at the same time continuous with the old, new in spiritual power, one in worship and in work.

To the Jew the word *ecclesia* as used in the Septuagint suggested the assembly of the congregation of Israel. To a Greek it suggested the assembly of freeborn citizens in a city state. Without ceasing to be the congregation of Jehovah, it would claim for itself all the hopes of an ideal state over which Greek philosophers had sighed in vain.

Opinions differ upon the question whether the apostles were chosen as representatives of the *ecclesia* to be founded (Hort) or as men fitted to become its duly authorized teachers and leaders from the beginning (Stone). But as Mr Stone well puts it, "It would not be a necessary inference [from Dr Hort's opinion] that there ought to be no ministry in the Christian Church."²

At first the church was limited to the Christian believers in the city of Jerusalem, then by persecution their company was broken up, and, since those who were scattered went everywhere preaching the word, the conception was enlarged to include all "of the way" (Acts ix. 2) in the Holy Land. A new epoch began from the return of St Paul and St Barnabas to Antioch after their first missionary journey, when they called together the church and narrated their experiences, and told how "God had opened to the Gentiles the door of faith" (Acts xiv. 27). Hitherto the term Church had been "ideally conterminous" with the Jewish Church. Now it was to contain members who had never in any sense belonged to the Jewish Church. Thus the way was opened for new developments and for illimitable extension. St Paul, in his address to the elders at Ephesus (Acts xx. 28), adapted the words of Ps. lxxiv. 2, "Remember thy congregation, which thou hast purchased of old," claiming for the Christian *ecclesia* the title of God's ancient *ecclesia*. But he never, however fiercely opposed by Judaizers, set a new *ecclesia* of Christ in opposition to the old. We wait, however, for the Epistles of his captivity at Rome to find the full meaning of the idea of the church dawning upon his imagination. "Here at least, for the first time in the Acts and Epistles, we have the *ecclesia* spoken of in the sense of the one universal *ecclesia*, and it comes more from the theological than from the historical side; *i.e.* less from the actual circumstances of the actual Christian communities than from a development of thoughts respecting the place and office of the Son of God: his headship was felt to involve the unity of all those who were united to him."³ Similar development of the idea of the one *ecclesia* as including all members of all local

ecclesiae does not lead St Paul to regard membership of the universal church as invisible.

But the mere history of the word *ecclesia* does not exhaust the subject. We must take into account not only the idea of the visible *actual* church, but also the ideal pictured by St Paul in the metaphors of the Body (Rom. xiii. 5), the Temple (1 Cor. iii. 10-15) and the Bride of Christ (2 Cor. xi. 2). The actual church is always falling short of its profession; but its successive reformations witness to the strength of its longing after the beauty of holiness.

Membership in the actual church is acquired through baptism "in the name of the Father and of the Son and of the Holy Ghost" (Matt. xxviii. 19). The references in the New Testament to baptism "in the name of Jesus" (or the Lord Jesus) (Acts ii. 38, viii. 16, x. 48, xix. 5; Rom. vi. 3; Gal. iii. 27), which are by some critics taken to refer to a primitive Christological baptismal formula, seem to refer to the confession made by the baptized, or to the new relationship into which they are brought as "members of Christ."⁴ Candidates for baptism were exhorted to prepare for it by repentance and faith (Acts ii. 38). The laying on of hands (Heb. vi. 2), in the rite called in later times confirmation, followed baptism (Acts viii. 17). In the modern Greek Church it is administered by priests with oil which has been consecrated by the bishop, in the Roman Church by the bishop himself. Such use of the chrism can be traced from the 2nd century. The Anglican Church retains only the Biblical symbolism of "the blessing of the hand." Presbyterians and other Protestant churches have abandoned the use, except the Lutherans. We need not here trace the history of Christian worship, in daily services (Acts ii. 46), or on the Lord's Day (Acts xx. 7), meeting for the Lord's Supper (1 Cor. xi. 17-34), or for mutual edification in prayer, praise and prophecy (1 Cor. xiv.). These things represent the ideal of Christendom. In the words of an eminent Roman Catholic scholar, Monsignor Duchesne, "Faith unites, theology often separates." It must be our task to summarize the leading ideas of the church in which all Christians are agreed.

(a) The first is certainly fellowship with Christ and with the brethren. The early Christians earnestly believed that their life was "hidden with Christ in God" (Col. iii. 3), and found in their union with Christ the lasting and strongest motive of love to the brethren. Such fellowship is attributed by St Paul pre-eminently to the work of the Holy Spirit (2 Cor. xiii. 14). Its strength is shown in England in the growing readiness of the different religious bodies to co-operate in movements for the purifying of public morality and for the better observance of Sunday.

(b) The second is unity. We have seen how St. Paul was led on to grasp the conception of one church universal manifested in all the local churches. Its unity is not purely accidental in that individuals have been forced to act together under pressure of chance circumstances. Nor is the ideal of unity adopted simply because experience teaches that "union is strength." Nor is it even based on the philosophical conception of the incompleteness of the individual life. As Dr Sanday finely says, "If the church is in something more than mere metaphor the Body of Christ, if there is circulating through it a continual flow and return of spiritual forces, derived directly from him, if the Spirit which animates the Body is one, then the Body itself also must be in essence one. It has its centre not on earth but in heavenly places, where Christ sitteth at the right hand of God."⁵

(c) Thirdly, there is no question that the Lord intended the one fellowship of his saints to be a *visible fellowship*. The idea of an invisible church has only commended itself in dark hours when men despaired of unity even as an ideal. The view of Zwingli and Calvin in the 16th century was not by any means acceptable to other reformers. Luther distinguished between the Spiritual Church, which he identified with the Communion of Saints, and the Corporeal Church, the outward marks of which are Baptism, Sacrament and Gospel. But he regarded them

⁴ For a full defence of the authenticity of Matt. xxviii. 19, see Riggensbach, *Der trinitarische Taufbefehl* (Gütersloh, 1903):

⁵ *The Conception of Priesthood*, p. 13.

¹ *Ecce Homo*, ed. 5, p. 87. Cf. the interesting comparison between Socrates and Christ.

² *Op. cit.* p. 262.

³ Hort, *The Christian Ecclesia*, p. 148.

as different aspects of the same church, and Melancthon was even more explicit.¹ As the saint purified in heaven is he who struggled with his sins on earth, so is the church triumphant one with the church militant. In Dr Lindsay's words, "it is one of the privileges of faith, when strengthened by hope and by love, to see the glorious ideal in the somewhat poor material reality. It was thus that St Paul saw the universal Church of Christ made visible in the Christian community of Corinth."²

But it is at this point that we come to the dividing line which has been drawn by different conceptions of catholicity. Dr Lindsay goes on to argue that all insistence on the principle of historical continuity, whether urged by members of the Anglican or the Roman Catholic Church, as upholders of episcopacy, is a deliberate return to the principle of Judaism, which declared that no one who was outside the circle of the "circumcised," no matter how strong his faith nor how the fruits of the Spirit were manifest in his life and deeds, could plead "the security of the Divine Covenant." Without entering into controversy it must suffice to point out that, from the point of view of all episcopal churches, the ministry of the bishops succeeding the ministry of the apostles, however it came to pass, was for fifteen centuries accepted as the pledge of unity. This principle, however, of continuity in ministry, belongs to a different department of Christian thought from the sacrament of baptism, which really corresponds to the Jewish rites of admission to the covenant. And it has been an established principle of the undivided church since the 3rd century, the bishop of Rome in this case upholding against St Cyprian the view which subsequent generations have ratified as Catholic truth, that baptism by whomsoever administered is valid if water is used with the right words. From this point, alas, divergence begins.

(d) The fourth element is authority. Probably all Christians can agree in the statement that the Christian democracy is also a theocracy, that Christ is the source of all authority. There are three passages in the Gospel which claim notice: (i.) the promise to St Peter (Matt. xvi. 18 f), as spokesman for the apostles, of the key of the household of God, of power to admit and exclude; (ii.) the promise (Matt. xviii. 15-20) probably given to the Twelve, regarding offences against the peace of the society, advocating exclusion only when brotherly appeals had failed; (iii.) the commission of the whole *ecclesia* or of the Christian ministry (John xx. 22, 23). Again the root difference between the Presbyterian and Episcopalian conceptions of the church comes to light. Is the authority of the church manifested in the decisions which a local church arrives at by a majority of votes, or in the decisions of apostles and prophets after taking counsel, of the episcopate in later times, ratified by common consent of Christendom? As has been well said, "the church is primarily a witness—the strength of its authority lies in the many sides from which the witness comes." It witnesses to the Divine Life of Christ as a power of the present and of the future as of the past, ministered in the Word and sacraments.

(e) The church is a sacerdotal society. St Paul delighted to represent it as the "ideal Israel," and St John echoes the thought in the words of praise (Rev. i. 5, 6), "Unto him that hath loved us . . . and made us to be a kingdom, and priests unto his God and Father." This idea of the priesthood of the whole church has three elements—the divine element, the human element and self-sacrifice. The promise that Christians should be temples of the living God has been fulfilled. As Dr Milligan has said very well, "It is not only in things to which we commonly confine the word miracle that the Divine appears. It may appear not less in the whole tone and spirit of the Church's life, in the varied Christian virtues of her members, in the general character of their Christian work, and in the grace received by them in the Christian sacraments. When that life is exhibited, as it ought to be, in its distinctively heavenly character, it bears witness to the presence of a power in Christian men which no mere recollection of a past example, however heroic or beautiful,

can supply. The difficulties of exhibiting and maintaining it are probably far greater now than they were in the apostolic age; and as nothing but a present divine support can enable us to overcome these, so, when they are overcome, a testimony is given to the fact that God is with us."³

But this life is to be a human life still, to be in touch with all that is noble and of good report in art and literature, keenly interested in all the discoveries of science, active in all movements of social progress. It cannot, however, be denied that to live such a life, divine in its powers and human in its sympathies, demands daily and hourly self-sacrifice. As the author of the *Imitation of Christ* put it long ago, "There is no living in love without pain." The thought of self-sacrifice has been emphasized from the earliest times in the liturgies. By a true instinct the early Christian writers called widows and orphans the altar of God on which the sacrifices of almsgiving are offered up.⁴ Such works of charity, however, represent only one of the channels by which self-sacrifice is ministered, to which all prayers and thanksgiving and instruction of psalms, prophecy and preaching contribute. Thus in the Eucharist the offering of the church is made one with the offering of the Great High Priest.⁵

All this represents an ideal. It suggests in a modern form the perpetual paradox of the Christian life: we are what we are to be. The church is the divine society in which all other religious associations are eventually to find their home. The prayer, "Thy kingdom come," embraces all spiritual forces which make for righteousness. They were acknowledged in Christ's words, "He that is not against you is for you" (Luke ix. 50). But the divisions of Christendom testify to the harm done by undue insistence on the claims of the individual to gain scope to extend the kingdom in his own way. As in a choir all the resources of an individual voice are used to strengthen the general effect, so must the individual lose his life that he may find it, witnessing by his share in the common service of the church to the ultimate unity of knowledge and harmony of truth.

For the various conceptions of the church as an organized body see CHURCH HISTORY, sec. 3, and the articles on the various churches. (A. E. B.)

CHURCH ARMY, an English religious organization, founded in 1882 by the Rev. Wilson Carlile (afterwards prebendary of St Paul's), who banded together in an orderly army of "soldiers" and "officers" a few working men and women, whom he and others trained to act as "Church of England evangelists" among the outcasts and criminals of the Westminster slums. Previous experience had convinced him that the moral condition of the lowest classes of the people called for new and aggressive action on the part of the Church, and that this work was most effectively done by laymen and women of the same class as those whom it was desired to touch. "Evangelistic zeal with Church order" is the principle of the Church Army, and it is essentially a working men's and women's mission to working people. As the work grew, a training institution for evangelists was started in Oxford, but soon moved (1886) to London, where, in Bryanston Street near the Marble Arch, the headquarters of the army are now established. Working men are trained as evangelists, and working women as mission sisters, and are supplied to the clergy. The men evangelists have to pass an examination by the archdeacon of Middlesex, and are then (since 1896) admitted by the bishop of London as "lay evangelists in the Church"; the mission sisters must likewise pass an examination by the diocesan inspector of schools. All Church Army workers (of whom there are over 1800 of one kind and another) are entirely under the control of the incumbent of the parish to which they are sent. They never go to a parish unless invited, nor stay when asked to go by the parish priest. Officers and sisters are paid a limited sum for their services either by the vicar or by voluntary local contributions. Church Army mission and colportage vans circulate throughout the country parishes, if desired, with

³ *The Ascension*, p. 254.

⁴ Polycarp, *Phil.* 4; cf. Tertullian, *Ad Uxor.* i. 7.

⁵ This teaching is not confined to Episcopalian writers. It has been finely expressed from the Presbyterian standpoint by Dr Milligan, *op. cit.* p. 265 ff.; cf. Lindsay, p. 37.

¹ *The Conception of Priesthood*, p. 29.

² Lindsay, *The Church and the Ministry in the Early Centuries*, p. 17.

itinerant evangelists, who hold simple missions, without charge, and distribute literature. Each van missionary has a clerical "adviser." Missions are also held in prisons and workhouses, at the invitation of the authorities. In 1888 (before the similar work of the Salvation Army was inaugurated) the Church Army established labour homes in London and elsewhere, with the object of giving a "fresh start in life" to the outcast and destitute. These homes deal with the outcast and destitute in a plain, straightforward way. They demand that the persons should show a desire for amendment; they subject them to firm discipline, and give them hard work; they give them decent clothes, and strive to win them to a Christian life. The inmates earn their board and lodging by piece-work, for which they are paid at the current trade rates, while by a gradually lessening scale of work and pay they are stimulated to obtain situations for themselves and given time to seek for them. There are about 120 homes in London and the provinces, and 56% of the inmates are found to make these the successful beginning of an honest self-supporting life. The Church Army has lodging homes, employment bureaus, cheap food depots, old clothes department, dispensary and a number of other social works. Every winter employment is found for a great number of the unemployed in special depots, among them being the King's Labour Tents and the Queen's Labour Relief Depots. There is also an extensive emigration system, under which many hundreds (3000 in 1906) of carefully tested men and families, of good character, chiefly of the unemployed class, are placed in permanent employment in Canada through the agency of the local clergy. The whole of the work is done in loyal subordination to the diocesan and parochial organization of the Church of England.

See Edgar Rowans, *Wilson Carlile and the Church Army*.

CHURCH CONGRESS, an annual meeting of members of the Church of England, lay and clerical, to discuss matters religious, moral or social, in which the church is interested. It has no legislative authority, and there is no voting on the questions discussed. The first congress was held in 1861 in the hall of King's College, Cambridge, and was the outcome of the revival of convocation in 1852. The congress is under the presidency of the bishop in whose diocese it happens to be held. Recent places of meeting are Brighton (1901), Northampton (1902), Bristol (1903), Liverpool (1904), Weymouth (1905), Barrow-in-Furness (1906), Great Yarmouth (1907), Manchester (1908), Swansea (1909). The meetings of the congress have been mainly remarkable as illustrating the wide divergences of opinion and practice in the Church of England, no less than the broad spirit of tolerance which has made this possible and honourably differentiates these meetings from so many ecclesiastical assemblies of the past. The congress of 1908 was especially distinguished, not only for the expression of diametrically opposed views on such questions as the sacrifice of the mass or the "higher criticism," but for the very large proportion of time given to the discussion of the attitude of the Church towards Socialism and kindred subjects.

CHURCH HISTORY. The sketch given below of the evolution of the Christian Church (see **CHURCH**) may well be prefaced by a summary of the history of the great Church historians, concerning whom fuller details are given in separate articles. Hegesippus wrote in the 2nd century a collection of memoirs containing accounts of the early days of the church, only fragments of which are extant. The first real church history was written by Eusebius of Caesarea in the early part of the 4th century. His work was continued in the 5th century by Philostorgius, Socrates, Sozomen and Theodoret, and in later centuries by Theodorus Lector, Evagrius, Theophanes and others. In the 14th century Nicephorus Callisti undertook a complete church history which covers in its extant form the first six centuries. In the West Eusebius' *History* was translated into Latin by Rufinus, and continued down to the end of the 4th century. Augustine's *City of God*, published in 426, was an apologetic, not an historical work, but it had great influence in our field, for in it he undertook to answer the common heathen accusation that the growing misfortunes of the empire were due to the prevalence of Christianity and the forsaking of the gods of

Rome. It was to sustain Augustine's thesis that Orosius produced in 417 his *Historiarum libri septem*, which remained the standard text-book on world history during the middle ages. About the same time Sulpicius Severus wrote his *Historia Sacra*, covering both biblical and Christian history. In the 6th century Cassiodorus had a translation made of the histories of Socrates, Sozomen and Theodoret, which were woven into one continuous narrative and brought down to 518. The work was known as the *Historia Ecclesiastica Tripartita*, and constituted during the middle ages the principal text-book of church history in the West. Before writing his history Eusebius produced a world chronicle which was based upon a similar work by Julius Africanus and is now extant only in part. It was continued by Jerome, and became the basis of the model for many similar works of the 5th and following centuries by Prosper, Idatius, Marcellinus Comes, Victor Tununensis and others. Local histories containing more or less ecclesiastical material were written in the 6th and following centuries by Jordanes (*History of the Goths*), Gregory of Tours (*History of the Franks*), Isidore of Seville (*History of the Goths, Vandals and Suevi*), Bede (*Ecclesiastical History of England*), Paulus Diaconus (*History of the Lombards*), and others. Of the many historians of the middle ages, besides the authors of biographies, chronicles, cloister annals, &c., may be mentioned Haymo, Anastasius, Adam of Bremen, Ordericus Vitalis, Honorius of Autun, Otto of Freising, Vincent of Beauvais and Antoninus of Florence.

The Protestant reformation resulted in a new development of historical writing. Polemic interest led a number of Lutheran scholars of the 16th century to publish the *Magdeburg Centuries* (1559 ff.), in which they undertook to show the primitive character of the Protestant faith in contrast with the alleged corruptions of Roman Catholicism. In this design they were followed by many other writers. The opposite thesis was maintained by Baronius (*Annales Ecclesiastici*, 1588 ff.), whose work was continued by a number of Roman Catholic scholars. Other notable Roman Catholic historians of the 17th and 18th centuries were Natalis Alexander, Bossuet, Tillemont, Fleury, Dupin and Ceillier.

Church history began to be written in a genuinely scientific spirit only in the 18th century under the leadership of Mosheim, who is commonly called the father of modern church history. With wide learning and keen critical insight he wrote a number of historical works of which the most important is his *Institutiones Hist. Eccles.* (1755; best English trans. by Murdock). He was followed by many disciples, among them Schroeckh (*Christliche Kirchengeschichte*, 1772 ff. in 45 vols.). Other notable names of the 18th century are Semler, Spittler, Henke and Planck.

The new historical spirit of the 19th century did much for church history. Among the greatest works produced were those of J. C. L. Gieseler (*Lehrbuch der Kirchengeschichte*, 1824 ff., best Eng. tr. revised and edited by H. B. Smith), exceedingly objective in character and still valuable, particularly on account of its copious citations from the sources; Neander (*Allgemeine Geschichte der christlichen Religion und Kirche*, 1825 ff., Eng. tr. by Torrey), who wrote in a sympathetic spirit and with special stress upon the religious side of the subject, and has been followed by many disciples, for instance, Hagenbach, Schaff and Herzog; and Baur (*Das Christenthum und die christliche Kirche*, 1853 ff.), the most brilliant of all, whose many historical works were dominated by the principles of the Hegelian philosophy and evinced both the merits and defects of that school. Baur has had tremendous influence, even though many of his positions have been generally discredited. The problems particularly of the primitive history were first brought into clear light by him, and all subsequent work upon the subject must acknowledge its indebtedness to him.

A new era was opened by the publication in 1857 of the second edition of Ritschl's *Entstehung der altkatholischen Kirche*, in which he broke away from the Tübingen school and introduced new points of view that have revolutionized the interpretation of the early church. Of recent works the most important are the *Kirchengeschichte* of Carl Müller (1892 ff.) and that of W. Möller (1889 ff., second edition by von Schubert, 1898 ff.,

greatly enlarged and improved), the translation of the latter (1892 ff.) being the most useful text-book in English. Of modern Roman Catholic works may be mentioned those by J. A. Möhler, T. B. Alzog, F. X. Kraus. Cardinal Joseph von Hergenröther and C. J. von Hefele (edited by Knöpfler.)

In addition to these general works on church history should be named the histories of doctrine by Harnack, Loofs, Seeberg and Fisher; and on the early Church the works on the apostolic age by Weizsäcker (1886, English translation 1894), McGiffert (1897), and Bartlet (1899); Renan's *Histoire des origines du christianisme* (1867 ff., in 7 vols., translated in part); Pfeiderer's *Urchristenthum* (1887); S. Cheetham's *History of the Christian Church during the first Six Centuries* (1894); Wernle's *Anfänge unserer Religion* (1901; Eng. tr. 1902 ff.); Rainy's *Ancient Catholic Church* (1902); Knopf's *Nachapostolisches Zeitalter* (1905); Duchesne's *Histoire ancienne de l'Église* (vol. i., 1906). (A. C. McG.)

In the following account of the historical evolution of the Church, the subject will be treated in three sections:—
History of the Christian Church. (A) The ancient Church to the beginning of the pontificate of Gregory the Great (A.D. 590); (B) The Church in the middle ages; (C) The modern Church.

A. THE ANCIENT CHURCH

1. *Origin and Growth.*—The crucifixion of Jesus Christ resulted in the scattering of his followers, but within a short time they became convinced that he had risen from the dead, and would soon return to set up the expected Messianic kingdom, and so to accomplish the true work of the Messiah (cf. Acts i. 6 ff.). They were thus enabled to retain the belief in his Messiahship which his death had threatened to destroy permanently. This belief laid upon them the responsibility of bringing as many of their countrymen as possible to recognize him as Messiah, and to prepare themselves by repentance and righteousness for the coming kingdom (cf. Acts ii. 21, 38, iii. 19 sq.). It was with the sense of this responsibility that they gathered again in Jerusalem, the political and religious metropolis of Judaism. In Jerusalem the new movement had its centre, and the church established there is rightly known as the mother church of Christendom. The life of the early Jewish disciples, so far as we are able to judge from our meagre sources, was very much the same as that of their fellows. They continued faithful to the established synagogue and temple worship (cf. Acts iii. 1), and did not think of founding a new sect, or of separating from the household of Israel (cf. Acts x. 14, xv. 5, xxi. 21 sq.). There is no evidence that their religious or ethical ideals differed in any marked degree from those of the more serious-minded among their countrymen, for the emphasis which they laid upon the need of righteousness was not at all uncommon. In their belief, however, in the Messiahship of Jesus, and their consequent assurance of the speedy establishment by him of the Messianic kingdom, they stood alone. The first need of the hour, therefore, was to show that Jesus was the promised Messiah in spite of his crucifixion, a need that was met chiefly by testimony to the resurrection, which became the burden of the message of the early disciples to their fellow-countrymen (cf. Acts ii. 24 ff., iii. 15 ff., v. 31). It was this need which led also to the development of Messianic prophecy and the ultimate interpretation of the Jewish Bible as a Christian book (see BIBLE). The second need of the hour was to bring the nation to repentance and righteousness in order that the kingdom might come (cf. Acts iii. 19). The specific gospel of Jesus, the gospel of divine fatherhood and human brotherhood, received no attention in the earliest days, so far as our sources enable us to judge.

Meanwhile the new movement spread quite naturally beyond the confines of Palestine and found adherents among the Jews of the dispersion, and at an early day among the Gentiles as well. Many of the latter had already come under the influence of Judaism, and were more or less completely in sympathy with Jewish religious principles. Among the Christians who did most to spread the gospel in the Gentile world was the apostle Paul, whose conversion was the greatest event in the history of the early

Church. In his hands Christianity became a new religion, fitted to meet the needs of all the world, and freed entirely of the local and national meaning which had hitherto attached to it. According to the early disciples Jesus was the Jewish Messiah, and had significance only in relation to the expected Messianic kingdom. To establish that kingdom was his one great aim. For the Gentiles he had no message except as they might become members of the family of Israel, assuming the responsibilities and enjoying the privileges of proselytes. But Paul saw in Jesus much more than the Jewish Messiah. He saw in Christ the divine Spirit, who had come down from heaven to transform the lives of men, all of whom are sinners. Thus Jesus had the same significance for one man as for another, and Christianity was meant as much for Gentiles as for Jews. The kingdom of which the early disciples were talking was interpreted by Paul as righteousness and peace and joy in the Holy Ghost (Rom. xiv. 17), a new principle of living, not a Jewish state. But Paul taught also, on the basis of a religious experience and of a distinct theory of redemption (see McGiffert's *Apostolic Age*, ch. iii.), that the Christian is freed from the obligation to observe the Jewish law. He thus did away with the fundamental distinction between Jews and Gentiles. The transformed spiritual life of the believer expresses itself not in the observance of the Jewish law, but in love, purity and peace. This precipitated a very serious conflict, of which we learn something from the Epistle to the Galatians and the Book of Acts (xv. and xxii.). Other fundamental principles of Paul's failed of comprehension and acceptance, but the belief finally prevailed that the observance of Jewish law and custom was unnecessary, and that in the Christian Church there is no distinction between the circumcised and the uncircumcised. Those Jewish Christians who refused to go with the rest of the Church in this matter lived their separate life, and were regarded as an heretical sect known as the Ebionites.

It was Christianity in its universal form which won its great victories, and finally became permanently established in the Roman world. The appeal which it made to that world was many-sided. It was a time of moral reformation, when men were awaking to the need of better and purer living. To all who felt this need Christianity offered high moral ideals, and a tremendous moral enthusiasm, in its devotion to a beloved leader, in its emphasis upon the ethical possibilities of the meanest, and in its faith in a future life of blessedness for the righteous. It was a time of great religious interest, when old cults were being revived and new ones were finding acceptance on all sides. Christianity, with its one God, and its promise of redemption and a blessed immortality based upon divine revelation, met as no other contemporary faith did the awakening religious needs. It was a time also of great social unrest. With its principle of Christian brotherhood, its emphasis upon the equality of all believers in the sight of God, and its preaching of a new social order to be set up at the return of Christ, it appealed strongly to multitudes, particularly of the poorer classes. That it won a permanent success, and finally took possession of the Roman world, was due to its combination of appeals. No one thing about it commended it to all, and to no one thing alone did it owe its victory, but to the fact that it met a greater variety of needs and met them more satisfactorily than any other movement of the age. Contributing also to the growth of the Church was the zeal of its converts, the great majority of whom regarded themselves as missionaries and did what they could to extend the new faith. Christianity was essentially a proselytizing religion, not content to appeal simply to one class or race of people, and to be one among many faiths, but believing in the falsity or insufficiency of all others and eager to convert the whole world. Moreover, the feeling of unity which bound Christians everywhere together and made of them one compact whole, and which found expression before many generations had passed in a strong organization, did much for the spread of the Church. Identifying himself with the Christian circle from the 2nd century on, a man became a member of a society existing in all quarters of the empire, every part conscious of its oneness with the larger whole and all compactly organized to do the common work. The growth of the Church during the

earlier centuries was chiefly in the middle and lower classes, but it was not solely there. No large number of the aristocracy were reached, but in learned and philosophical circles many were won, attracted both by Christianity's evident ethical power and by its philosophical character (cf. the Apologists of the 2nd century). That it could seem at once a simple way of living for the common man and a profound philosophy of the universe for the speculative thinker meant much for its success.¹

But it did not win its victory without a struggle. Superstition, misunderstanding and hatred caused the Christians trouble for many generations, and governmental repression they had to suffer occasionally, as a result of popular disturbances. No systematic effort was made by the imperial authorities to put an end to the movement until the reign of Decius (250-251), whose policy of suppression was followed by Diocletian (303 ff.) and continued for some years after his abdication. In spite of all opposition the Church steadily grew, until in 311 the emperor Galerius upon his death-bed granted toleration (see Eusebius, *H.E.* x.4, and Lactantius, *De mortibus persecutorum*, 34), and in 313 the emperors Constantine and Licinius published the edict of Milan, proclaiming the principle of complete religious liberty, and making Christianity a legal religion in the full sense (see Eusebius x. 5, and Lactantius 48. Seeck, *Zeitschrift für Kirchengeschichte*, xii. 381 sq., has attempted to show that the edict of Milan had no significance, but without success).

Constantine, recognizing the growing strength of the Church and wishing to enlist the loyal support of the Christians, treated them with increasing favour, and finally was baptized upon his death-bed (337). Under his successors, except during the brief reign of Julian (361-363), when the effort was made to reinstate paganism in its former place of supremacy, the Church received growing support, until, under Theodosius the Great (379-395), orthodox Christianity, which stood upon the platform adopted at Nicaea in 325, was finally established as the sole official religion of the state, and heathen worship was put under the ban. The union between Church and State thus constituted continued unbroken in the East throughout the middle ages. The division of the Empire resulted finally in the division of the Church, which was practically complete by the end of the 6th century, but was made official and final only in 1054, and the Eastern and Western halves, the Greek Catholic and the Roman Catholic Churches, went each its separate way. (See Theodosian Code, book 16, for the various imperial edicts relating to the Church, and for fuller particulars touching the relation between Church and Empire see the articles CONSTANTINE; GRATIAN; THEODOSIUS; JUSTINIAN.)

For a long time after the establishment of Christianity as the state religion, paganism continued strong, especially in the country districts, and in some parts of the world had more adherents than Christianity, but at length the latter became, at any rate nominally, the faith of the whole Roman world. Meanwhile already before the beginning of the 3rd century it went beyond the confines of the Empire in Asia, and by the end of our period was strong in Armenia, Persia, Arabia and even farther east. It reached the barbarians on the northern and western borders at an early day, and the Goths were already Christians of the Arian type before the great migrations of the 4th century began. Other barbarians became Christian, some in their own homes beyond the confines of the Empire, some within the Empire itself, so that when the hegemony of the West passed from the Romans to the barbarians the Church lived on. Thenceforth for centuries it was not only the chief religious, but also the chief civilizing, force at work in the occident. Losing with the dissolution of the Western Empire its position as the state church, it became itself a new empire, the heir of the glory and dignity of Rome, and the greatest influence making for the peace and unity of the western world.

2. *The Christian Life.*—The most notable thing about the life of

¹ Upon the spread of the Church during the early centuries see especially Harnack's *Mission und Ausbreitung des Christentums in den ersten drei Jahrhunderten*. An interesting parallel to the spread of Christianity in the Roman empire is afforded by the contemporary Mithraism. See Cumont's *Les Mystères de Mithra* (1900), Eng. tr. *The Mysteries of Mithra* (1903).

the early Christians was their vivid sense of being a people of God, called and set apart. The Christian Church in their thought was a divine, not a human, institution. It was founded and controlled by God, and even the world was created for its sake (cf. the *Shepherd of Hermas*, Vis. ii. 4, and 2 Clement 14). This conception, which came over from Judaism, controlled all the life of the early Christians both individual and social. They regarded themselves as separate from the rest of the world and bound together by peculiar ties. Their citizenship was in heaven, not on earth (cf. Phil. iii. 20, and the epistle to Diognetus, c. 5), and the principles and laws by which they strove to govern themselves were from above. The present world was but temporary, and their true life was in the future. Christ was soon to return, and the employments and labours and pleasures of this age were of small concern. Some went so far as to give up their accustomed vocations, and with such Paul had to expostulate in his epistles to the Thessalonians. A more or less ascetic mode of life was also natural under the circumstances. Not necessarily that the present world was evil, but that it was temporary and of small worth, and that a Christian's heart should be set on higher things. The belief that the Church was a supernatural institution found expression in the Jewish notion of the presence and power of the Holy Spirit. It was believed among the Jews that the Messianic age would be the age of the Spirit in a marked degree, and this belief passed over into the Christian Church and controlled its thought and life for some generations. The Holy Spirit was supposed to be manifest in various striking ways, in prophecy, speaking with tongues and miracle working. In this idea Paul also shared, but he carried the matter farther than most of his contemporaries and saw in the Spirit the abiding power and ground of the Christian life. Not simply in extraordinary phenomena, but also in the everyday life of Christians, the Holy Spirit was present, and all the Christian graces were the fruits (cf. Gal. v. 22). A result of this belief was to give their lives a peculiarly enthusiastic or inspirational character. Theirs were not the everyday experiences of ordinary men, but of men lifted out of themselves and transported into a higher sphere. With the passing of time the early enthusiasm waned, the expectation of the immediate return of Christ was widely given up, the conviction of the Spirit's presence became less vivid, and the conflict with heresy in the 2nd century led to the substitution of official control for the original freedom (see below). The late 2nd century movement known as Montanism was in essence a revolt against this growing secularization of the Church, but the movement failed, and the development against which it protested was only hastened. The Church as an institution now looked forward to a long life upon earth and adjusted itself to the new situation, taking on largely the forms and customs of the world in which it lived. This did not mean that the Church ceased to regard itself as a supernatural institution, but only that its supernatural character was shown in a different way. A Christian was still dependent upon divine aid for salvation, and his life was still supernatural at least in theory. Indeed, the early conviction of the essential difference between the life of this world and that of the next lived on, and, as the Church became increasingly a world-institution, found vent in monasticism, which was simply the effort to put into more consistent practice the other-worldly life, and to make more thoroughgoing work of the saving of one's soul. Contributing to the same result was the emphasis upon the necessity of personal purity or holiness, which Paul's contrast between flesh and spirit had promoted, and which early took the supreme place given by Christ to love and service. The growing difficulty of realizing the ascetic ideal in the midst of the world, and within the world-church, inevitably drove multitudes of those who took their religion seriously to retire from society and to seek salvation and the higher life, either in solitude, or in company with kindred spirits.

There were Christian monks as early as the 3rd century, and before the end of the 4th monasticism (*q.v.*) was an established institution both in East and West. The monks and nuns were looked upon as the most consistent Christians, and were honoured accordingly. Those who did not adopt the monastic life

endeavoured on a lower plane and in a less perfect way to realize the common ideal, and by means of penance to atone for the deficiencies in their performance. The existence of monasticism made it possible at once to hold up a high moral standard before the world and to permit the ordinary Christian to be content with something lower. With the growth of clerical sacerdotalism the higher standard was demanded also of the clergy, and the principle came to be generally recognized that they should live the monastic life so far as was consistent with their active duties in the world. The chief manifestation of this was clerical celibacy, which had become widespread already in the 4th century. Among the laity, on the other hand, the ideal of holiness found realization in the observance of the ordinary principles of morality recognized by the world at large, in attendance upon the means of grace provided by the Church, in fasting at stated intervals, in eschewing various popular employments and amusements, and in almsgiving and prayer. Christ's principle of love was widely interpreted to mean chiefly love for the Christian brotherhood, and within that circle the virtues of hospitality, charity and helpfulness were widely exercised; and if the salvation of his own soul was regarded as the most important affair of every man, the service of the brethren was recognized as an imperative Christian duty. The fulfilling of that duty was one of the most beautiful features of the life of the early Church, and it did perhaps more than anything else to make the Christian circle attractive.

3. *Worship*.—The primitive belief in the immediate presence of the Spirit affected the religious services of the Church. They were regarded in early days as occasions for the free exercise of spiritual gifts. As a consequence the completest liberty was accorded to all Christians to take such part as they chose, it being assumed that they did so only under the Spirit's prompting. But the result of this freedom was confusion and discord, as is indicated by Paul's First Epistle to the Corinthians (see chapters xi., xiv.). This led to the erection of safeguards, which should prevent the continuance of the unseemly conditions (on Paul's action in the matter, see McGiffert's *Apostolic Age*, p. 523). Particular Christians were designated to take charge of the services, and orders of worship were framed out of which grew ultimately elaborate liturgies (see LITURGY). The Lord's Supper first took on a more stereotyped character, and prayers to be used in connexion with it are found already in the *Didachē* (chapters ix. and x.). The development cannot here be traced in detail. It may simply be said that the general tendency was on the one hand toward the elaboration and growing magnificence of the services, especially after the Church had become a state institution and had taken the place of the older pagan cults, and on the other hand toward the increasing solemnity and mystery of certain parts, particularly the eucharist, the sacred character of which was such as to make it sacrilegious to admit to it the unholy, that is, outsiders or Christians under discipline (cf. *Didachē*, ix.). It was, in fact, from the Lord's table that offending disciples were first excluded. Out of this grew up in the 3rd or 4th century what is known as the *arcani disciplina*, or secret discipline of the Church, involving the concealment from the uninitiated and unholy of the more sacred parts of the Christian cult, such as baptism and the eucharist, with their various accompaniments, including the Creed and the Lord's Prayer. The same interest led to the division of the services into two general parts, which became known ultimately as the *missa catechumenorum* and the *missa fidelium*,—that is, the more public service of prayer, praise and preaching open to all, including the catechumens or candidates for Church membership, and the private service for the administration of the eucharist, open only to full members of the Church in good and regular standing. Meanwhile, as the general service tended to grow more elaborate, the *missa fidelium* tended to take on the character of the current Greek mysteries (see EUCHARIST; Hatch, *Influence of Greek Ideas and Usages upon the Christian Church*, 1890; Anrich, *Das antike Mysterienwesen in seinem Einfluss auf das Christentum*, 1894; Wobbermin, *Religionsgeschichtliche Studien zur Frage der Beeinflussung des Urchristentums durch*

das antike Mysterienwesen, 1896). Many of the terms in common use in them were employed in connexion with the Christian rites, and many of the conceptions, particularly that of sharing in immortality by communion with deity, became an essential part of Christian doctrine. Thus the early idea of the services, as occasions for mutual edification through the interchange of spiritual gifts, gave way in course of time to the theory that they consisted of sacred and mysterious rites by means of which communion with God is promoted. The emphasis accordingly came to be laid increasingly upon the formal side of worship, and a value was given to the ceremonies as such, and their proper and correct performance by duly qualified persons, *i.e.* ordained priests, was made the all-important thing.

4. *The Church and the Sacraments*.—According to Paul, man is flesh and so subject to death. Only as he becomes a spiritual being through mystical union with Christ can he escape death and enjoy eternal life in the spiritual realm. In the Epistle to the Ephesians the Christian Church is spoken of as the body of Christ (iv. 12 ff., v. 30); and Ignatius, bishop of Antioch, early in the 2nd century, combined the two ideas of union with Christ, as the necessary condition of salvation, and of the Church as the body of Christ, teaching that no one could be saved unless he were a member of the Church (cf. his Epistle to the Ephesians 4, 5, 15; Trall. 7; Phil. 3, 8; Smyr. 8; Magn. 2, 7). Traces of the same idea are found in Irenaeus (cf. *Adv. Haer.* iii. 24, 1, iv. 26, 2), but it is first clearly set forth by Cyprian, and receives from him its classical expression in the famous sentence "Salus extra ecclesiam non est" (Ep. 73, 21; cf. also Ep. 4, 4; 74, 7; and *De unitate ecclesiae*, 6: "habere non potest Deum patrem qui ecclesiam non habet matrem"). The Church thus became the sole ark of salvation, outside of which no one could be saved.

Intimately connected with the idea of the Church as an ark of salvation are the sacraments or means of grace. Already as early as the 2nd century the rite of baptism had come to be thought of as the sacrament of regeneration, by means of which a new divine nature is born within a man (cf. Irenaeus, *Adv. Haer.* i. 21, 1, iii. 17, 1; and his newly discovered *Demonstration of the Apostolic Teaching*, chap. 3), and the eucharist as the sacrament of the body and blood of Christ, feeding upon which one is endowed with immortality (cf. Irenaeus, *Adv. Haer.* iv. 18, 5, v. 2, 2). In the early days the Church was thought of as a community of saints, all of whose members were holy, and as a consequence discipline was strict, and offenders excluded from the Church were commonly not readmitted to membership but left to the mercy of God. The idea thus became general that baptism, which had been almost from the beginning the rite of entrance into the Church, and which was regarded as securing the forgiveness of all pre-baptismal sins, should be given but once to any individual. Meanwhile, however, discipline grew less strict (cf. the *Shepherd of Hermas*, Vis. v. 3; M. iv. 7; Sim. viii. 6, ix. 19, 26, &c.); until finally, under the influence of the idea of the Church as the sole ark of salvation, it became the custom to readmit all penitent offenders on condition that they did adequate penance. Thus there grew up the sacrament of penance, which secured for those already baptized the forgiveness of post-baptismal sins. This sacrament, unlike baptism, might be continually repeated (see PENANCE). In connexion with the sacraments grew up also the theory of clerical sacerdotalism. Ignatius had denied the validity of a eucharist administered independently of the bishop, and the principle finally established itself that the sacraments, with an exception in cases of emergency in favour of baptism, could be performed only by men regularly ordained and so endowed with the requisite divine grace for their due administration (cf. Tertullian, *De Exhort. cast.* 7; *De Bapt.* 7, 17; *De Praescriptione Haer.* 41; and Cyprian, *Ep.* 67). For the later influence of the Donatist controversy upon the sacramental development see DONATISTS). Thus the clergy as distinguished from the laity became true priests, and the latter were made wholly dependent upon the former for sacramental grace, without which there is ordinarily no salvation (see ORDER, HOLY).

5. *Christian Doctrine*.—Two tendencies appeared in the thought

of the primitive Church, the one to regard Christianity as a law given by God for the government of men's lives, with the promise of a blessed immortality as a reward for its observance; the other to view it as a means by which the corrupt and mortal nature of man is transformed, so that he becomes a spiritual and holy being. The latter tendency appeared first in Paul, afterwards in the Gospel and First Epistle of John, in Ignatius of Antioch and in the Gnostics. The former found expression in most of our New Testament writings, in all of the apostolic fathers except Ignatius, and in the Apologists of the 2nd century. The two tendencies were not always mutually exclusive, but the one or the other was predominant in every case. Towards the end of the 2nd century they were combined by Irenaeus, bishop of Lyons. To him salvation bears a double aspect, involving both release from the control of the devil and the transformation of man's nature by the indwelling of the Divine. Only he is saved who on the one hand is forgiven at baptism and so released from the power of Satan, and then goes on to live in obedience to the divine law; and on the other hand receives in baptism the germ of a new spiritual nature and is progressively transformed by feeding upon the body and blood of the divine Christ in the eucharist. This double conception of salvation and of the means thereto was handed down to the Church of subsequent generations and became fundamental in its thought. Christianity is at once a revealed law which a man must keep, and by keeping which he earns salvation, and a supernatural power whereby his nature is transformed and the divine quality of immortality imparted to it. From both points of view Christianity is a supernatural system without which salvation is impossible, and in the Christian Church it is preserved and mediated to the world.

The twofold conception referred to had its influence also upon thought about Christ. The effect of the legal view of Christianity was to make Christ an agent of God in the revelation of the divine will and truth, and so a subordinate being between God and the world, the Logos of current Greek thought. The effect of the mystical conception was to identify Christ with God in order that by his incarnation the divine nature might be brought into union with humanity and the latter be transformed. In this case too a combination was effected, the idea of Christ as the incarnation of the Logos or Son of God being retained and yet his deity being preserved by the assertion of the deity of the Logos. The recognition of Christ as the incarnation of the Logos was practically universal before the close of the 3rd century, but his deity was still widely denied, and the Arian controversy which distracted the Church of the 4th century concerned the latter question. At the council of Nicaea in 325 the deity of Christ received official sanction and was given formulation in the original Nicene Creed. Controversy continued for some time, but finally the Nicene decision was recognized both in East and West as the only orthodox faith. The deity of the Son was believed to carry with it that of the Spirit, who was associated with Father and Son in the baptismal formula and in the current symbols, and so the victory of the Nicene Christology meant the recognition of the doctrine of the Trinity as a part of the orthodox faith (see especially the writings of the Cappadocian fathers of the late 4th century, Gregory of Nyssa, Basil and Gregory Nazianzen).

The assertion of the deity of the Son incarnate in Christ raised another problem which constituted the subject of dispute in the Christological controversies of the 4th and following centuries. What is the relation of the divine and human natures in Christ? At the council of Chalcedon in 451 it was declared that in the person of Christ are united two complete natures, divine and human, which retain after the union all their properties unchanged. This was supplemented at the third council of Constantinople in 680 by the statement that each of the natures contains a will, so that Christ possesses two wills. The Western Church accepted the decisions of Nicaea, Chalcedon and Constantinople, and so the doctrines of the Trinity and of the two natures in Christ were handed down as orthodox dogma in West as well as East.

Meanwhile in the Western Church the subject of sin and grace, and the relation of divine and human activity in salvation, received especial attention; and finally, at the second council of Orange in 529, after both Pelagianism and semi-Pelagianism had been repudiated, a moderate form of Augustinianism was adopted, involving the theory that every man as a result of the fall is in such a condition that he can take no steps in the direction of salvation until he has been renewed by the divine grace given in baptism, and that he cannot continue in the good thus begun except by the constant assistance of that grace, which is mediated only by the Catholic Church. This decision was confirmed by Pope Boniface II., and became the accepted doctrine in the Western Church of the middle ages. In the East, Augustine's predestinationism had little influence, but East and West were one in their belief that human nature had been corrupted by the fall, and that salvation therefore is possible only to one who has received divine grace through the sacraments. Agreeing as they did in this fundamental theory, all differences were of minor concern.

In general it may be said that the traditional theology of the Church took its material from various sources—Hebrew, Christian, Oriental, Greek and Roman. The forms in which it found expression were principally those of Greek philosophy on the one hand and of Roman law on the other (see CHRISTIANITY).

6. *Organization.*—The origin and early development of ecclesiastical organization are involved in obscurity. Owing to the once prevalent desire of the adherents of one or another polity to find support in primitive precept or practice, the question has assumed a prominence out of proportion to its real importance, and the few and scattered references in early Christian writings have been made the basis for various elaborate theories.

In the earliest days the Church was regarded as a divine institution, ruled not by men but by the Holy Spirit. At the same time it was believed that the Spirit imparted different gifts to different believers, and each gift fitted its recipient for the performance of some service, being intended not for his own good but for the good of his brethren (cf. 1 Cor. xii.; Eph. iv. 11). The chief of these was the gift of teaching, that is, of understanding and interpreting to others the will and truth of God. Those who were endowed more largely than their fellows with this gift were commonly known as apostles, prophets and teachers (cf. Acts xiii. 1; 1 Cor. xii. 28; Eph. ii. 20, iii. 5, iv. 11; *Didachē*, xi.). The apostles were travelling missionaries or evangelists. There were many of them in the primitive Church, and only gradually did the term come to be applied exclusively to the twelve and Paul. There is no sign that the apostles, whether the twelve or others, held any official position in the Church. That they had a large measure of authority of course goes without saying, but it depended always upon their brethren's recognition of their possession of the divine gift of apostleship, and the right of Churches or individuals to test their claims and to refuse to listen to them if they did not vindicate their divine call was everywhere recognized. Witness, for instance, Paul's reference to false apostles in 2 Cor. xi. 13, and his efforts to establish his own apostolic character to the satisfaction of the Corinthians and Galatians (1 Cor. ix. 1 ff.; 2 Cor. x. 13; Gal. i. 8 ff.); witness the reference in Rev. ii. 2 to the fact that the Church at Ephesus had tried certain men who claimed to be apostles and had found them false, and also the directions given in the *Didachē* for testing the character of those who travelled about as apostles. The passage in the *Didachē* is especially significant: "Concerning the apostles and prophets, so do ye according to the ordinance of the gospel. Let every apostle when he cometh to you be received as the Lord. But he shall not abide more than a single day, or if there be need a second likewise. But if he abide three days he is a false prophet. And when the apostle departeth let him receive nothing save bread until he findeth shelter. But if he ask money he is a false prophet" (ch. xi.). It is clear that a man who is to be treated in this way by the congregation is not an official ruler over it.

Between the apostles, prophets and teachers no hard-and-fast lines can be drawn. The apostles were commonly missionary

prophets, called permanently or temporarily to the special work of evangelization (cf. Acts xiii. 1; *Did.* xi.), while the teachers seem to have been distinguished both from apostles and prophets by the fact that their spiritual endowment was less strikingly supernatural. The indefiniteness of the boundaries between the three classes, and the free interchange of names, show how far they were from being definite offices or orders within the Church. Apostleship, prophecy and teaching were only functions, whose frequent or regular exercise by one or another, under the inspiration of the Spirit, led his brethren to call him an apostle, prophet or teacher.

But at an early day we find regular officers in this and that local Church, and early in the 2nd century the three permanent offices of bishop, presbyter and deacon existed at any rate in Asia Minor (cf. the Epistles of Ignatius of Antioch). Their rise was due principally to the necessity of administering the charities of the Church, putting an end to disorder and confusion in the religious services, and disciplining offenders. It was naturally to the apostles, prophets and teachers, its most spiritual men, that the Church looked first for direction and control in all these matters. But such men were not always at hand, or sometimes they were absorbed in other duties. Thus the need of substitutes began to be felt here and there, and as a consequence regular offices within the local Churches gradually made their appearance, sometimes simply recognized as charged with responsibilities which they had already voluntarily assumed (cf. 1 Cor. xvi. 15), sometimes appointed by an apostle or prophet or other specially inspired man (cf. Acts xiv. 23; Titus i. 5; 1 Clement 44), sometimes formally chosen by the congregation itself (cf. Acts vi., *Did.* xi.). These men naturally acquired more and more as time passed the control and leadership of the Church in all its activities, and out of what was in the beginning more or less informal and temporary grew fixed and permanent offices, the incumbents of which were recognized as having a right to rule over the Church, a right which once given could not lawfully be taken away unless they were unfaithful to their trust. Not continued endowment by the Spirit, but the possession of an ecclesiastical office now became the basis of authority. The earliest expression of this genuinely official principle is found in Clement's Epistle to the Corinthians, ch. xlv. Upon these officers devolved ultimately not only the disciplinary, financial and liturgical duties referred to, but also the still higher function of instructing their fellow-Christians in God's will and truth, and so they became the substitutes of the apostles, prophets and teachers in all respects (cf. 1 Tim. iii. 2, v. 17; Titus i. 9; *Did.* 15; 1 Clement 44; Justin's first *Apology*, 67).

Whether in the earliest days there was a single officer at the head of a congregation, or a plurality of officers of equal authority, it is impossible to say with assurance. The few references which we have look in the latter direction (cf., for instance, Acts vi.; Phil. i. 1; 1 Clement 42, 44; *Did.* 14), but we are not justified in asserting that they represent the universal custom. The earliest distinct evidence of the organization of Churches under a single head is found in the Epistles of Ignatius of Antioch, which date from the latter part of the reign of Trajan (c. 116). Ignatius bears witness to the presence in various Churches of Asia Minor of a single bishop in control, with whom are associated as his subordinates a number of elders and deacons. This form of organization ultimately became universal, and already before the end of the 2nd century it was established in all the parts of Christendom with which we are acquainted, though in Egypt it seems to have been the exception rather than the rule, and even as late as the middle of the 3rd century many churches there were governed by a plurality of officers instead of by a single head (see Harnack, *Mission und Ausbreitung des Christenthums*, pp. 337 seq.). Where there were one bishop and a number of presbyters and deacons in a church, the presbyters constituted the bishop's council, and the deacons his assistants in the management of the finances and charities and in the conduct of the services. (Upon the minor orders which arose in the 3rd and following centuries, and became ultimately a training school for the higher clergy, see Harnack, *Texte und*

Untersuchungen, ii. 5; English translation under the title of *Sources of the Apostolic Canons*, 1895.)

Meanwhile the rise and rapid spread of Gnosticism produced a great crisis in the Church of the 2nd century, and profoundly affected the ecclesiastical organization. The views of the Gnostics, and of Marcion as well, seemed to the majority of Christians destructive of the gospel, and it was widely felt that they were too dangerous to be tolerated. The original dependence upon the Spirit for light and guidance was inadequate. The men in question claimed to be Christians and to enjoy divine illumination as truly as anybody, and so other safeguards appeared necessary. It was in the effort to find such safeguards that steps were taken which finally resulted in the institution known as the Catholic Church. The first of these steps was the recognition of the teaching of the apostles (that is, of the twelve and Paul) as the exclusive standard of Christian truth. This found expression in the formulation of an apostolic scripture canon, our New Testament, and of an apostolic rule of faith, of which the old Roman symbol, the original of our present Apostles' Creed, is one of the earliest examples. Over against the claims of the Gnostics that they had apostolic authority, either oral or written, for their preaching, were set these two standards, by which alone the apostolic character of any doctrine was to be tested (cf. Irenaeus, *Adv. Haer.* i. 10, iii. 3, 4; and Tertullian, *De Prescriptione Haer. passim*). But these standards proved inadequate to the emergency, for it was possible, especially by the use of the allegorical method, to interpret them in more than one way, and their apostolic origin and authority were not everywhere admitted. In view of this difficulty, it was claimed that the apostles had appointed the bishops as their successors, and that the latter were in possession of special divine grace enabling them to transmit and to interpret without error the teaching of the apostles committed to them. This is the famous theory known as "apostolic succession." The idea of the apostolic appointment of church officers is as old as Clement of Rome (see 1 Clement 44), but the use of the theory to guarantee the apostolic character of episcopal teaching was due to the exigencies of the Gnostic conflict. Irenaeus (*Adv. Haer.* iii. 3 ff., iv. 26, iv. 33, v. 20), Tertullian (*De prescriptione*, 32), and Hippolytus (*Philosophumena*, bk. i., preface) are our earliest witnesses to it, and Cyprian sets it forth clearly in his epistles (e.g. *Ep.* 33, 43, 59, 66, 69). The Church was thus in possession not only of authoritative apostolic doctrine, but also of a permanent apostolic office, to which alone belonged the right to determine what that doctrine is. The combination of this idea with that of clerical sacerdotalism completed the Catholic theory of the Church and the clergy. Saving grace is recognized as apostolic grace, and the bishops as successors of the apostles become its sole transmitters. Bishops are therefore necessary to the very being of the Church, which without them is without the saving grace for the giving of which the Church exists (cf. Cyprian, *Ep.* 33, "ecclesia super episcopos constituitur"; 66, "ecclesia in episcopo"; also *Ep.* 59, and *De unitate eccles.* 17).

These bishops were originally not diocesan but congregational, that is, each church, however small, had its own bishop. This is the organization testified to by Ignatius, and Cyprian's insistence upon the bishop as necessary to the very existence of the Church seems to imply the same thing. Congregational episcopacy was the rule for a number of generations. But after the middle of the 3rd century diocesan episcopacy began to make its appearance here and there, and became common in the 4th century under the influence of the general tendency toward centralization, the increasing power of city bishops, and the growing dignity of the episcopate (cf. canon 6 of the council of Sardica, and canon 57 of the council of Laodicea; and see Harnack, *Mission und Ausbreitung*, pp. 319 seq.). This enlargement of the bishop's parish and multiplication of the churches under his care led to a change in the functions of the presbyterate. So long as each church had its own bishop the presbyters constituted simply his council, but with the growth of diocesan episcopacy it became the custom to put each congregation under the care of a particular presbyter, who performed within it most of the pastoral duties

formerly discharged by the bishop himself. The presbyters, however, were not independent officers. They were only representatives of the bishop, and the churches over which they were set were all a part of his parish, so that the Cyprianic principle, that the bishop is necessary to the very being of the Church, held good of diocesan as well as of congregational episcopacy. The bishop alone possessed the right to ordain; through him alone could be derived the requisite clerical grace; and so the clergy like the laity were completely dependent upon him.

The growth of the diocesan principle promoted the unity of the churches gathered under a common head. But unity was carried much further than this, and finally resulted in at least a nominal consolidation of all the churches of Christendom into one whole. The belief in the unity of the entire Church had existed from the beginning. Though made up of widely scattered congregations, it was thought of as one body of Christ, one people of God. This ideal unity found expression in many ways. Intercommunication between the various Christian communities was very active. Christians upon a journey were always sure of a warm welcome and hospitable entertainment from their fellow-disciples. Messengers and letters were sent freely from one church to another. Missionaries and evangelists went continually from place to place. Documents of various kinds, including gospels and apostolic epistles, circulated widely. Thus in various ways the feeling of unity found expression, and the development of widely separated parts of Christendom conformed more or less closely to a common type. It was due to agencies such as these that the scattered churches did not go each its own way and become ultimately separate and diverse institutions. But this general unity became official, and expressed itself in organization, only with the rise of the conciliar and metropolitan systems. Already before the end of the 2nd century local synods were held in Asia Minor to deal with Montanism, and in the 3rd century provincial synods became common, and by the council of Nicaea (canon 5) it was decreed that they should be held twice every year in every province. Larger synods representing the churches of a number of contiguous provinces also met frequently; for instance, in the early 4th century at Elvira, Ancyra, Neo-Caesarea and Arles, the last representing the entire Western world. Such gatherings were especially common during the great doctrinal controversies of the 4th century. In 325 the first general or ecumenical council, representing theoretically the entire Christian Church, was held at Nicaea. Other councils of the first period now recognized as ecumenical by the Church both East and West are Constantinople I. (381), Ephesus (431), Chalcedon (451), Constantinople II. (553). All these were called by the emperor, and to their decisions he gave the force of law. Thus the character of the Church as a state institution voiced itself in them. (See COUNCIL.)

The theory referred to above, that the bishops are successors of the apostles, and as such the authoritative conservators and interpreters of apostolic truth, involves of course the solidarity of the episcopate, and the assumption that all bishops are in complete harmony and bear witness to the same body of doctrine. This assumption, however, was not always sustained by the facts. Serious disagreements even on important matters developed frequently. As a result the ecumenical council came into existence especially for the purpose of settling disputed questions of doctrine, and giving to the collective episcopate the opportunity to express its voice in a final and official way. At the council of Nicaea, and at the ecumenical councils which followed, the idea of an infallible episcopate giving authoritative and permanent utterance to apostolic and therefore divine truth, found clear expression, and has been handed down as a part of the faith of the Catholic Church both East and West. The infallibility of the episcopate guarantees the infallibility of a general council in which not the laity and not the clergy in general, but the bishops as successors of the apostles, speak officially and collectively.

Another organized expression of the unity of the Church was found in the metropolitan system, or the grouping of the churches of a province under a single head, who was usually the bishop of

the capital city, and was known as the metropolitan bishop. The Church thus followed in its organization the political divisions of the Empire (cf. for instance canon 12 of the council of Chalcedon, which forbids more than one metropolitan see in a province; also canon 17 of the same council: "And if any city has been or shall hereafter be newly erected by imperial authority, let the arrangement of ecclesiastical parishes follow the political and municipal forms"). These metropolitan bishops were common in the East before the end of the 3rd century, and the general existence of the organization was taken for granted by the council of Nicaea (see canons 4, 6, 7). In the West, on the other hand, the development was much slower.

Meanwhile the tendency which gave rise to the metropolitan system resulted in the grouping together of the churches of a number of contiguous provinces under the headship of the bishop of the most important city of the district, as, for instance, Antioch, Ephesus, Alexandria, Rome, Milan, Carthage, Arles. In canon 6 of the council of Nicaea the jurisdiction of the bishops of Alexandria, Rome and Antioch over a number of provinces is recognized. At the council of Constantinople (381) the bishop of Constantinople or New Rome was ranked next after the bishop of Rome (canon 3), and at the council of Chalcedon (451) he was given authority over the churches of the political dioceses of Pontus, Asia and Thrace (canon 28). To the bishops of Rome, Constantinople, Antioch and Alexandria was added at the council of Chalcedon (session 7) the bishop of Jerusalem, the mother church of Christendom, and the bishops thus recognized as possessing supreme jurisdiction were finally known as patriarchs.

Meanwhile the Roman episcopate developed into the papacy, which claimed supremacy over the entire Christian Church, and actually exercised it increasingly in the West from the 5th century on. This development was forwarded by Augustine, who in his famous work *De civitate Dei* identified the Church with the kingdom of God, and claimed that it was supreme over all the nations of the earth, which make up the *civitas terrena* or earthly state. Augustine's theory was ultimately accepted everywhere in the West, and thus the Church of the middle ages was regarded not only as the sole ark of salvation, but also as the ultimate authority, moral, intellectual and political. Upon this doctrine was built, not by Augustine himself but by others who came after him, the structure of the papacy, the bishop of Rome being finally recognized as the head under Christ of the *civitas Dei*, and so the supreme organ of divine authority on earth (see PAPACY and POPE).

Historical Sources of the First Period.—These are of the same general character for Church history as for general history—on the one hand monumental, on the other hand documentary. Among the monuments are churches, catacombs, tombs and inscriptions of various kinds, few antedating the 3rd century, and none adding greatly to the knowledge gained from documentary sources (see De Rossi, *Roma sotterranea*, 1864 ff., and its English abridgment by Northcote and Brownlow, 1870; André Pératé, *L'Archéologie chrétienne*, 1892; W. Lowrie, *Monuments of the Early Church*, 1901, with good bibliography). The documents comprise imperial edicts, rescripts, &c., liturgies, acts of councils, decretals and letters of bishops, references in contemporary heathen writings, and above all the works of the Church Fathers. Written sources from the 1st and 2nd centuries are relatively few, comprising, in addition to some scattered allusions by outsiders, the New Testament, the Apostolic Fathers, the Greek Apologists, Clement of Alexandria, the old Catholic Fathers (Irenaeus, Tertullian and Hippolytus) and a few Gnostic fragments. For the 3rd, and especially the 4th and following centuries, the writers are much more numerous; for instance, in the East, Origen and his disciples, and later Eusebius of Caesarea, Athanasius, Apollinaris, Basil and the two Gregories, Cyril of Jerusalem, Epiphanius, Chrysostom, Ephraim the Syrian, Cyril of Alexandria, Pseudo-Dionysius; in the West, Novatian, Cyprian, Commodian, Arnobius, Lactantius, Hilary, Ambrose, Rufinus, Jerome, Augustine, Prosper, Leo the Great, Cassian, Vincent of Lerins, Faustus, Gennadius, Ennodius, Avitus, Caesarius, Fulgentius and many others.

There are many editions of the works of the Fathers in the original, the most convenient, in spite of its defects, being that of J. P. Migne (*Patrologia Graeca*, 166 vols., Paris, 1857 ff.; *Patrologia Latina*, 221 vols., 1844 ff.). Of modern critical editions, besides those containing the works of one or another individual, the best are the Berlin edition of the early Greek Fathers (*Die griechischen christlichen Schriftsteller der ersten drei Jahrhunderte*, 1897 ff.), and the

Vienna edition of the Latin Fathers (*Corpus scriptorum ecclesiasticorum Latinorum*; 1867 ff.), both of first-rate importance. There is a convenient English translation of most of the writings of the ante-Nicene Fathers by Roberts and Donaldson (*Ante-Nicene Christian Library*, 25 vols., Edinburgh, 1868 ff., American reprint in nine vols., 1886 ff.). A continuation of it, containing selected works of the Nicene and post-Nicene period, was edited by Schaff and others under the title *A Select Library of Nicene and post-Nicene Fathers* (series 1 and 2; 28 vols., Buffalo and New York, 1886 ff.).

On early Christian literature, in addition to the works on Church history, see especially the monumental *Geschichte der altchristlichen Litteratur bis Eusebius*, by Harnack (1893 ff.). The brief *Geschichte der altchristlichen Litteratur in den ersten drei Jahrhunderten*, by G. Krüger (1895, English translation 1897) is a very convenient summary. Bardenhever's *Patrologie* (1894) and his *Geschichte der altkirchlichen Litteratur* (1902 ff.) should also be mentioned. See also Smith and Wace's invaluable *Dictionary of Christian Biography* (1877 ff.). (A.C. McG.)

B. THE CHRISTIAN CHURCH IN THE MIDDLE AGES

The ancient Church was the church of the Roman empire. It is true that from the 4th century onwards it expanded beyond the borders of that empire to east and west, north and south; but the infant churches which gradually arose in Persia and Abyssinia, among some of the scattered Teutonic races, and among the Celts of Ireland, were at first not co-operating factors in the development of Christendom: they received without giving in return. True historic life is only to be found within the church of the Empire.

The middle ages came into being at the time when the political structure of the world, based upon the conquests of Alexander the Great and the achievements of Julius Caesar, began to disintegrate. They were present when the believers in Mahomet held sway in the Asiatic and African provinces which Alexander had once brought under the intellectual influence of Hellenism; while the Lombards, the West Goths, the Franks and the Anglo-Saxons had established kingdoms in Italy, Spain, Gaul and Britain. The question is: what was the position of the Church in this great change of circumstances, and what form did the Church's development take from this time onwards? In answering this question we must consider East and West separately; for their histories are no longer coincident, as they had been in the time of the Roman dominion.

I. THE EAST. (a) *The Orthodox Church*.—Ancient and medieval times were not separated by so deep a gulf in the East as in the West; for in the East the Empire continued to exist, although within narrow limits, until towards the end of the middle ages. Constantinople only fell in 1453. Ecclesiastical Byzantinism is therefore not a product of the middle ages: it is the outcome of the development of the eastern half of the empire from the time of Constantine the Great. Under Justinian I. all its essential features were already formed: imperial power extended equally over State and Church; indeed, care for the preservation of dogma and for the purity of the priesthood was the chief duty of the ruler. To fulfil this duty was to serve the interests of both State and people; for thus "a fine harmony is established, and whatever good exists becomes the portion of the whole human race." Since the emperor ruled the Church there was no longer any question of independence for the bishops, least of all for the patriarch in Constantinople; they were in every respect subordinate to the emperor.

The *orthodoxy* of the Eastern Church was also a result of the Church's development after the time of Constantine. In the long strife over dogma the old belief of the Greeks in the value of knowledge had made itself felt, and this faith was not extinct in the Eastern Church. There is no doubt that in the beginning of the middle ages both general and theological education stood higher among the Greeks than in more western countries. In the West there were no learned men who could vie with Photius (ca. 820-891) in range of knowledge and variety of scientific attainment. But the strife over dogma came to an end with the 7th century. After the termination of the monothelite controversy (638-680), creed and doctrines were complete; it was only necessary to preserve them intact. Theology, therefore, now resolved itself into the collection and reproduction of the

teaching of ancient authorities. The great dogmatist of the Eastern Church, John of Damascus (ca. 699-753), who stood on the threshold of the middle ages, formulated clearly and precisely his working principle: to put forward nothing of his own, but to present the truth according to the authority of the Bible and of the Fathers of the Church. Later teachers, Euthymius Zigadenus (d. circa 1120), Nicetas Choniates (d. circa 1200), and others, proceeded further on the same lines; Euthymius, in particular, often uses an excerpt instead of giving his own exposition.

This attitude towards dogma did not mean that it was less prized than during the period of strife. On the contrary, the sacred formulae were revered because they were believed to contain the determination of the highest truths: the knowledge of God and of the mystery of salvation. Yet it is intelligible that religious interest should have concerned itself more keenly with the mystic rites of divine worship than with dogma. Here was more than knowledge; here were representations of a mystic sensuousness, solemn rites, which brought the faithful into immediate contact with the Divine, and guaranteed to them the reception of heavenly powers. What could be of more importance than to be absorbed in this transcendental world? We may gauge the energy with which the Greek intellect turned in this direction if we call to mind that the controversy about dogma was replaced by the controversy about images. This raged in the Eastern Church for more than a century (726-843), and only sank to rest when the worship of images was unconditionally conceded. In this connexion the image was not looked upon merely as a symbol, but as the vehicle of the presence and power of that which it represented: in the image the invisible becomes operative in the visible world. Christ did not seem to be Christ unless he were visibly represented. What an ancient teacher had said with regard to the worship of Christ as the revelation of the Eternal Father—"Honours paid to the earthly representative are shared by the heavenly Archetype"—was now transferred to the painted image: it appeared as an analogy to the Incarnation. It was for this reason that the victory of image worship was celebrated by the introduction of the festival of the Orthodox Faith.

It is consistent with this circle of ideas that initiation into the profound mysteries of the liturgy was regarded, together with the preservation of dogma, as the most exalted function of theology. A beginning had been made, in the 5th century, by the neoplatonic Christian who addressed his contemporaries under the mask of Dionysius the Areopagite. He is the first of a series of theological mystics which continued through every century of the middle ages. Maximus Confessor, the heroic defender of Dyothelitism (d. 662), Symeon, the New Theologian (d. circa 1040), Nicolaus Cabasilas (d. 1371), and Symeon, like Nicholas, archbishop of Thessalonica (d. 1429), were the most conspicuous representatives of this Oriental mysticism. They left all the dogmas and institutions of the Church untouched; aspiring above and beyond these, their aim was religious experience.

It is this striving after religious experience that gives to the Oriental monachism of the middle ages its peculiar character. In the 5th and 6th centuries Egypt and Palestine had been the classic lands of monks and monasteries. But when, in consequence of the Arab invasion, the monasticism of those countries was cut off from intercourse with the rest of Christendom, it decayed. Constantinople and Mount Athos gained proportionately in importance during the middle ages. At Constantinople the monastery of Studium, founded about 460, attained to supreme influence during the controversy about images. On Mount Athos the first monastery was founded in the year 963, and in 1045 the number of monastic foundations had reached 180. In Greek monachism the old Hellenic ideal of the wise man who has no wants (*ἀνάρκεια*) was from the first fused with the Christian conception of unreserved self-surrender to God as the highest aim and the highest good. These ideas governed it in medieval times also, and in this way monastic life received a decided bent towards mysticism: the monks strove to realize the heavenly life even upon earth, their highest aim being the contemplation of God and of His ways. The teachings of

Symeon "the New Theologian" on these matters lived on in the cloisters; it was taken up by the Hesychasts of the 14th century, and developed into a peculiar theory as to the perception of the Divine Light. In spite of all opposition their teaching was finally justified by the Eastern Church (sixth synod of Constantinople, 1351). And rightly so, for it was the old Greek piety minted afresh.

The Eastern Church, then, throughout the middle ages, remained true in every particular to her ancient character. It cannot be said that she developed as did the Western Church during this period, for she remained what she had been; but she freely developed her original characteristics, consistently, in every direction. This too is life, though of a different type from that of the West.

That there was life in the Eastern Church is also proved by the fact that the power of *expansion* was not denied her. Through her agency an important bulwark for the Christian faith was created in the new nations which had sprung into existence since the beginning of the middle ages: the Bulgarians, the Servians, and the multifarious peoples grouped under the name of Russians. There is a vast difference in national character between these young peoples and the successors of the Hellenes; and it is therefore all the more significant to find that both the Church and religious sentiment should in their case have fully preserved the Byzantine character. This proves once more the ancient capacity of the Greeks for the assimilation of foreign elements.

There was yet another outcome of this stubborn persistency of a peculiar type—the impossibility of continuing to share the life of the Western Church. Neither in the East nor in the West was a *separation* desired; but it was inevitable, since the lives of East and West were moving in different directions. It was the fall of Constantinople that first weakened the vital force of the Eastern Church. May we hope that the events of modern times are leading her towards a renaissance?

(b) *The Nestorian and the Monophysite Churches.*—Since the time when the church of eastern Syria had decided, in opposition to the church of the Empire, to cling to the ancient views of Syrian theologians—therefore also to the teaching and person of Nestorius—her relations were broken off with the church in western Syria and in Greek and Latin countries; but the power of Nestorian, or, as it was termed, *Chaldaic* Christianity, was not thereby diminished. Separated from the West, it directed its energies towards the East, and here its nearest neighbour was the Persian church. The latter followed, almost without opposition, the impulse received from Syria; from the rule of the patriarch Babaeus (Syr. Bāb-hāi, 498–503) she may be considered definitely Nestorian. A certain number, too, of Arabic Christians, believers living on the west coast of India, the so-called Christians of St Thomas, and finally those belonging to places nearer the middle of Asia (Merv, Herat, Samarkand), remained in communion with the Nestorian church. Thus there survived in mid-Asia a widely-scattered remnant, which, although out of touch with the ancient usages of Christian civilization, yet in no way lacked higher culture. Nestorian philosophers and medical practitioners became the teachers of the great Arabian natural philosophers of the middle ages, and the latter obtained their knowledge of Greek learning from Syriac translations of the works of Greek thinkers.

Political conditions at the beginning of the middle ages favoured the Nestorian church, and the fact that the Arabs had conquered Syria, Palestine and Egypt, made it possible for her to exert an influence on the Christians in these countries. Of still more importance was the brisk commercial intercourse between central Asia and the countries of the Far East; for this led the Nestorians into China. The inscription of Si-ngan-fu (before 781) proves a surprisingly widespread extension of the Christian faith in that country. That it also possessed adherents in southern Siberia we gather from the inscriptions of Semiryetchensk, and in the beginning of the 11th century it found its way even into Mongolia. Nowhere were the nations Christian, but the Christian faith was everywhere accepted by a not insignificant minority. The foundation of the Mongolian empire

in the beginning of the 13th century did not disturb the position of the Nestorian church; but the revival of the Mahommedan power, which was coincident with the downfall of the Mongolian empire, was pregnant with disaster for her. The greater part of Nestorian Christendom was now swallowed up by Islam, so that only remnants of this once extensive church have survived until modern times.

The middle ages were far more disastrous for the Monophysites than for the Nestorians; in their case there was no alternation of rise and decline, and we have only a long period of gradual exhaustion to chronicle. Egypt was the home of Monophysitism, whence it extended also into Syria. It was due to the great Jacob of Edessa (Jacob Baradaeus, d. 578) that it did not succumb to the persecution by the power of the Orthodox Empire, and out of gratitude to him the Monophysite Christians of Syria called themselves *Jacobites*. The Arab conquest (after 635) freed the Jacobite church entirely from the oppression of the Orthodox, and thereby assured its continuance. The church, however, never attained any greater development, but on the contrary continued to lose adherents from century to century. While Jacob of Edessa is said to have ordained some 100,000 priests and deacons for his fellow-believers, in the 16th century the Jacobites of Syria were estimated at only 50,000 families.

The Monophysite church of Egypt had a like fate. At the time of the separation of the churches the Greeks here had remained faithful to Orthodoxy, the Copts to Monophysitism. Here too the Arab conquest (641) put an end to the oppression of the native Christians by the Greek minority; but this did not afford the Coptic church any possibility of vigorous development. It succumbed to the ceaseless alternation of tolerance and persecution which characterized the Arab rule in Egypt, and the mass of the Coptic people became unfaithful to the Church. At the time of the conquest of the country by the Turks (1517) the Coptic church seems already to have fallen to the low condition in which the 19th century found it. Though at the time of the Arab conquest the Copts were reckoned at six millions, in 1820 the Coptic Christians numbered only about one hundred thousand, and it is improbable that their number can have been much greater at the close of the middle ages. Only in Abyssinia the daughter church of the Coptic church succeeded in keeping the whole people in the Christian faith. This fact, however, is the sole outcome of the history of a thousand years; a poor result, if measured by the standard of the rich history of the Western world, yet large enough not to exclude the hope of a new development.

II. THE WEST. (a) *The Early Middle Ages. The Catholic Church as influenced by the Foundation of the Teutonic States.*—While the Eastern Church was stereotyping those peculiar characteristics which made her a thing apart, the Church of the West was brought face to face with the greatest revolution that Europe has ever experienced. At the end of the 6th century all the provinces of the Empire had become independent kingdoms, in which conquerors of Germanic race formed the dominant nationality. The remnants of the Empire showed an uncommonly tough vitality. It is true that the Teutonic states succeeded everywhere in establishing themselves; but only in England and in the erstwhile Roman Germany did the Roman nationality succumb to the Teutonic. In the other countries it not only maintained itself, but was able to assimilate the ruling German race; the Lombards, West Goths, Swabians, and even the Franks in the greater part of Gaul became Romanized. Consequently the position of the Christian Church was never seriously affected. This is the great fact which stands out at the beginning of the history of the Church in the middle ages. The continuity of the political history of Europe was violently interrupted by the Germanic invasion, but not that of the history of the Church. For, in view of the facts above stated, it was of small significance that in Britain Christianity was driven back into the western portion of the island still held by the Britons, and that in the countries of the Rhine and Danube a few bishoprics disappeared. This was of the less importance, as the Church immediately made preparations to win back the lost territory. On the

frontier line of ancient and medieval times stands the figure of Gregory I., the incarnation as it were of the change that was taking place: half Father of the Church, half medieval pope. He it was who sent the monk Augustine to England, in order to win over the Anglo-Saxons to the Christian faith. Augustine was not the first preacher of the Gospel at Canterbury. A Frankish bishop, Liudhard, had laboured there before his time; but the mission of Augustine and his ordination as a bishop were decisive in the conversion of the country and the establishment of the Anglo-Saxon church. On the continent an extension of the Frankish supremacy towards the east had already led to the advance of Christendom. Not only were the bishoprics in the towns of the Rhine country re-established, but as the Franks colonized the country on both sides of the Main, they carried the Christian faith into the very heart of Germany. Finally, the dependence of the Swabian and Bavarian peoples on the Frankish empire paved the way for Christianity in those provinces also. Celtic monks worked as missionaries in this part of the country side by side with Franks. In England it had not been possible to bring the old British and the young Anglo-Saxon churches into friendly union; but in spite of this the Celts did not abstain from working at the common tasks of Christendom, and the continent has much to thank them for. When the first century of the middle ages came to an end the Empire had not only reoccupied the former territory of the Empire, she had already begun to overstep its limits.

In so doing she had remained as of old and had yet become new. Creed and dogma, above all, remained unchanged. The doctrinal decisions of the ancient Church remained the indestructible canon of belief, and what the theologians of the ancient Church had taught was revered as beyond improvement. The entire form of divine worship remained therefore unaltered. Even where the Latin tongue was not understood by the people, the Church preserved it in the Mass and in the administration of the sacraments, in her exorcisms and in her benedictions. Furthermore, the organization of ecclesiastical offices remained unchanged: the division of the Church into bishoprics and the grouping together of bishoprics into metropolitan dioceses. Finally, the property and the whole social status of the Church and of the hierarchy remained unchanged, as did also the conviction that the perfection of the Christian life was to be sought and found in the monastic profession.

Nevertheless, the new conditions did exercise the strongest influence upon the character of the Church. The churches of the Lombards, West Goths, Franks and Anglo-Saxons, all counted themselves parts of the Catholic Church; but the Catholic Church had altered its condition; it lacked the power of organization, and split up into territorial churches. Under the Empire the ecumenical council had been looked upon as the highest representative organ of the Catholic Church; but the earlier centuries of the middle ages witnessed the convocation of no ecumenical councils. Under the Empire the bishop of Rome had possessed in the Church an authority recognized and protected by the State; respect for Rome and for the successor of Saint Peter was not forgotten by the new territorial churches, but it had altered in character; legal authority had become merely moral authority; its wielder could exhort, warn, advise but could not command.

On the other hand, the kings did command in the Church. They certainly claimed no authority over faith or doctrine, and they too respected doctrinal law; but they succeeded in asserting their rights to a practical share in the government of the Church. The clergy and laity of a diocese together elected their bishop, as they had done before; but no one could become a bishop against the will of the king, and the confirmation of their choice rested with him. The bishops continued to meet in synods as before, but the councils became territorial synods; they were called together at irregular intervals by the king, and their decisions obtained legal effect only by royal sanction.

In these circumstances the intrusion of Germanic elements into ecclesiastical law is easy to understand. This is most clearly recognizable in the case of churches which arose alongside

the episcopal cathedrals. In the Empire all churches, and all the property of the Church, were at the disposal of the bishops; in Germanic countries, on the contrary, the territorial nobles were looked upon as the owners of churches built upon their lands, and these became "proprietary churches." The logical consequence of this was that the territorial nobles claimed the right of appointing clergy, and the enjoyment of the revenues of these churches derived from the land (tithes). Even a certain number of the monastic establishments came in this way into the possession of the feudal landowners, who nominated abbots and abbesses as they appointed the incumbents of their churches.

With these conditions, and with the diminution of the ascendancy of town over country that resulted from the Teutonic conquests, is connected the rise of the parochial system in the country. The parishes were further grouped together into rural deaneries and archdeaconries. Thus the diocese, hitherto a simple unit, became an elaborately articulated whole. The bishopric of the middle ages bears the same name as that of the ancient Church; but in many respects it has greatness that is new.

This transformation of old institutions is the first great result of Germanic influence in the Christian Church. It continues to the present day in the universal survival of the parochial system.

In the middle ages the civilizing task of the Church was first approached in England. This was the home of the Latin Christian literature and theology of medieval times. Aldhelm (d. 709) and the Venerable Bede (d. 735) were the first scholars of the period. England was also the home of Winfrid Bonifatius (d. 757). We are accustomed to look upon him chiefly as a missionary; but his completion of the conversion of the peoples of central Germany (Thuringians and Hessians) and his share in that of the Frisians, are the least part of his life-work. Of more importance is the fact that, in co-operation with the bishops of Rome, he carried out the organization of the church in Bavaria, and began the reorganization of the Frankish church, which had fallen into confusion and decay during the political disorders of the last years of the Merovingians. It was Boniface, too, who, with the aid of numerous English priests, monks and nuns, introduced the literary culture of England into Germany.

Pippin (d. 768) and Charlemagne (d. 814) built on the foundations laid by Winfrid. For the importance of Charlemagne's work, from the point of view of the Church, consists also, not so much in the fact that, by his conversion of the Saxons, the Avars and the Wends in the eastern Alps, he substantially extended the Church's dominions, as in his having led back the Frankish Church to the fulfilment of her functions as a religious and civilizing agent. This was the purpose of his ecclesiastical legislation. The principal means to this end taken by him was the raising of the status of the clergy. From the priests he demanded faithfulness in preaching and teaching, from the bishops the conscientious government of their dioceses. The monasteries, too, learned to serve the Church by becoming nurseries of literary and theological culture. For the purpose of carrying out his ideas Charlemagne gathered round him the best intellects of Europe. None was more intimately associated with him than the Anglo-Saxon Alcuin (d. 804); but he was only one among many. Beside him are the Celts Josephus Scottus and Dungal, the Lombards Paulinus and Paulus Diaconus, the West Goth Theodulf and many Franks. Under their guidance theology flourished in the Frankish empire. It was as little original as that of Bede; for on the continent, too, scholars were content to think what those of old had thought before them. But in so doing they did not only repeat the old formulae; the ideas of the men of old sprang into new life. This is shown by the searching discussions to which the Adoptionist controversy gave rise. At the same time, the controversy with the Eastern Church over the adoration of images shows that the younger Western theology felt itself equal, if not superior to the Greek. This was in fact the case; for it knew how to treat the question, which divided the Greeks, in a more dispassionate and practical manner than they.

The second generation of Frankish theologians did not lag behind the first. Hrabanus of Fulda (who died archbishop of

Mainz in 856) was in the range of his knowledge undoubtedly Alcuin's superior. He was the first learned theologian produced by Germany. His disciple, Abbot Walafrid Strabo of Reichenau (d. 849), was the author of the *Glossa Ordinaria*, a work which formed the foundation of biblical exposition throughout the middle ages. France was still more richly provided with theologians in the 9th century: her most prominent names are Hincmar, archbishop of Reims (d. 882), Bishop Prudentius of Troyes (d. 861), the monks Servatus Lupus (d. 862), Radbert Paschasius (d. circa 860), and Ratramnus (d. after 868); and the last theologian who came into France from abroad, Johannes Scotus Erigena (d. circa 880). The theological method of all these was merely that of restatement. But the controversy about predestination, which, in the 9th century, Hincmar and Hrabanus fought out with the monk Gottschalk of Fulda, as well as the discussions that arose from the definition of the doctrine of transubstantiation of Radbert, enable us to gauge the intellectual energy with which theological problems were once more being handled.

Charlemagne followed his father's policy in carrying out his ecclesiastical measures in close association with the bishops of Rome. He renewed the donation of Pippin, and as *Patrician* he took Rome under his protection. From Pope Adrian I. he received the *Dionysio-Hadriana*, the Roman collection of material bearing on the ancient ecclesiastical law. But the Teutonic elements maintained their place in the law of the Frankish Church; and this was not altered by the fact that, since Christmas 800, the king of the Franks and Lombards had borne the title of Roman emperor. On the contrary, Rome itself was now for the first time affected by the predominance of the new empire; for Charlemagne converted the patriciate into effective sovereignty, and the successor of St Peter became the chief metropolitan of the Frankish empire.

There were, indeed, forces tending in the contrary direction; and these were present in the Frankish empire. Evidence of this is given by the canon law forgeries of the 9th century: the *capitula* of Angelram, the Capitularies of Benedictus Levita (see CAPITULARY), and the great collection of the Pseudo-Isidorian Decretals. For the moment, however, this party met with no success. Of more importance was the fact that at Rome the old conditions, the old claims, and the old law were unforgotten. Developing the ideas of Leo I., Gelasius I. and Gregory the Great, Nicholas I. (858-867) drew a picture of the divine right and unlimited power of the bishop of Rome, which anticipated all that the greatest of his successors were, centuries later, actually to effect. The time had not, however, yet come for the establishment of the papal world-dominion. For, while the power of Charlemagne's successors was decaying, the papacy itself became involved in the confusion of the party strife of Italy and of the city of Rome, and was plunged in consequence into such an abyss of degradation (the so-called Pornocracy), that it was in danger of forfeiting every shred of its moral authority over Christendom.

(b) *Central Period of the Middle Ages. Dominance of the Roman Spirit in the Church.*—After the accession of the House of Saxony (919), the national ecclesiastical system, founded upon the principles of Carolingian law, developed in Germany with fresh energy. The union in 962 by Otto I. of the revived Empire with the German kingship brought the latter into uninterrupted contact with the papacy. The revelation of the antagonism between the German conception of ecclesiastical affairs and Roman views of ecclesiastical law was sooner or later inevitable. This was most obvious in the matter of appointment to bishoprics. At Rome canonical election was alone regarded as lawful; in Germany, on the other hand, developments since the time of Charlemagne had led to the actual appointment of bishops being in the hands of the king, although the form of ecclesiastical election was preserved. For the transference of a bishopric a special legal form was evolved—that of investiture, the king investing the bishop elect with the see by delivering to him the ring and pastoral staff. No one found anything objectionable in this; investiture with a bishopric was parallel with the appointment by a territorial proprietor to a patronal church.

The practice customary in Germany was finally transferred to Rome itself. The desperate position of the papacy in the 11th century obliged Henry III. to intervene. When, on the 24th of December 1046, after three rival popes had been set aside, he nominated Suidgar, bishop of Bamberg, as bishop of Rome before all the people in St Peter's, the papacy was bestowed in the same way as a German bishopric; and what had occurred in this case was to become the rule. By procuring the transference of the patriciate from the Roman people to himself Henry assured his influence over the appointment of the popes, and accordingly also nominated the successors of Clement II.

His intervention saved the papacy. For the popes nominated by him, Leo IX. in particular, were men of high character, who exercised their office in a loftier spirit than their corrupt predecessors. They placed themselves at the head of the movement for ecclesiastical reform. But was it possible for the relation between Empire and Papacy to remain what Henry III. had made it?

The original sources of this reform movement lay far back, in the time of the Carolingians. It has been pointed out how Charlemagne pressed the monks into the service of his civilizing aims. We admire this; but it is certain that he thereby alienated monasticism from its original ideals. These, however, had far too strong a hold upon the Roman world for a reaction against the new tendency to be long avoided. This reaction began with the reform of Benedict of Aniane (d. 821), the aim of which was to bring the Benedictine order back to the principles of its original rules. In the next century the reform movement acquired a fresh centre in the Burgundian monastery of Cluny. The energy of a succession of distinguished abbots and the disciples whom they inspired succeeded in bringing about the victory of the reforming ideas in the French monasteries; once more the rule of St Benedict controlled the life of the monks. A large number of the reformed monasteries attached themselves to the congregation of Cluny, thus assuring the influence of reformed monasticism upon the Church, and securing likewise its independence of the diocesan bishops, since the abbot of Cluny was subordinate of the pope alone. (See CLUNY; BENEDICTINES and MONASTICISM.) At the same time that Cluny began to grow into importance, other centres of the monastic reform movement were established in Upper and Lower Lorraine; and before long the activity of the Cluniac monks made itself felt in Italy. In Germany Poppo of Stavelot (d. 1048) was a successful champion of their ideas; in England Dunstan (d. 988 as archbishop of Canterbury) worked independently, but on similar lines. Everywhere the object was the same: the supreme obligation of the Rule, the renewal of discipline, and also the economic improvement of the monasteries. The reform movement had originally no connexion with ecclesiastical politics; but that came later when the leaders turned their attention to the abuses prevalent among the clergy, to the conditions obtaining in the Church in defiance of the ecclesiastical law. "Return to the canon law!" was now the battle-cry. In the Cluniac circle was coined the principle: *Canonica auctoritas Dei lex est*, canon law being taken in the Pseudo-Isidorian sense. The programme of reform thus included not only the extirpation of simony and Nicolaitism, but also the freeing of the Church from the influence of the State, the recovery of her absolute control over all her possessions, the liberty of the Church and of the hierarchy.

As a result, the party of reform placed itself in opposition to those ecclesiastical conditions which had arisen since the conversion of the Teutonic peoples. It was, then, a fact pregnant with the most momentous consequences that Leo IX. attached himself to the party of reform. For, thanks to him and to the men he gathered round him (Hildebrand, Humbert and others), their principles were established in Rome, and the pope himself became the leader of ecclesiastical reform. But the carrying out of reforms led at once to dissensions with the civil-power, the starting-point being the attack upon simony.

Originally, in accordance with Acts viii. 18 et seq., simony was held to be the purchase of ordination. In the 9th century the interpretation was extended to include all acquisition of

ecclesiastical offices or benefices for money or money's worth. Since the landed proprietors disposed of churches and convents, and the kings of bishoprics and abbey, it became possible for them too to commit the sin of simony; hence a final expansion, in the 11th century, of the meaning of the term. The Pseudo-Isidorian idea being that all lay control over things ecclesiastical is wrong, all transferences by laymen of ecclesiastical offices or benefices, even though no money changed hands in the process, were now classed as simony (Humbert, *Adversus Simoniacos*, 1057-1058). Thus the lord who handed over a living was a simonist, and so too was the king who invested a bishop. On this question the battle began. The Church at first refrained from contesting the rights of the landowners over their own churches, and concentrated her attack upon investiture. In 1059 the new system of papal election introduced by Nicholas II. ensured the occupation of the Holy See by a pope favourable to the party of reform; and in 1078 Gregory VII. issued his prohibition of lay investiture. In the years of conflict that followed Gregory looked far beyond this point; he set his aim ever higher; until, in the end, his idea was to concentrate all ecclesiastical power in the hands of the pope, and to raise the papacy to the dominion of the world. Thus was to be realized the old dream of Augustine: that of a Kingdom of God on earth under the rule of the Church. But it was not given to Gregory to reach this goal, and his successors had to return again to the strife over investiture. The settlement of 1111 may be said to have embodied the only solution of the great question that was right in principle, since it pronounced in favour of a clear distinction between the spiritual and temporal spheres. However, a solution that was right in principle proved impossible in practice, and the long struggle ended in a compromise by the Concordat of Worms (1122). The essential part of this was that the Empire accepted the canonical election of bishops, and allowed the metropolitan to confer the sacred office by gift of ring and pastoral staff; while the Church acknowledged that the bishop held his temporal rights from the Empire, and was therefore to be invested with them by a touch from the royal sceptre. A similar solution was arrived at in England. Henry I. also renounced his claim to bestow ring and pastoral staff, but kept the right of induction into the temporalities (1106-1107). In France the demands of the Church were successful to the same degree as in England and Germany, but without any conflict. Thus the Germanic element in the law regarding appointment to bishoprics was eliminated. Somewhat later it disappeared also in the case of the churches of less importance, patronal rights over these being substituted for the former absolute ownership. The pontificate of Alexander III. (1159-1181) decided this.

Since the time of Charlemagne Germanic influence had preponderated in the West, as is shown in the expansion of the Church no less than in matters of ecclesiastical law. The whole progress of Christianity in Europe from the 9th to the 12th century was due—if we exclude Eastern Christendom—to the Teutonic nations; neither the papacy nor the peoples of Latin race were concerned in it. German priests and bishops carried the Christian faith to the Czechs and the Moravians, laboured among the Hungarians and the Poles, and won the wide district between the Elbe and the Oder at once for Christianity and for the German nation. Germany, too, was the starting-point for the conversion of the Scandinavian countries, which was completed by English priests with the assistance of native princes.

But, even while the Teutonic peoples were thus taking the lead, we can see the Latin races beginning to assert themselves. The monastic reform movement was essentially Latin in origin; and even more significant was the fact that scholasticism, the new theology, had its home in the Latin countries. Aristotelian dialectics had always been taught in the schools; and reason as well as authority had been appealed to as the foundation of theology; but for the theologians of the 9th and 10th centuries, whose method had been merely that of restatement, *ratio* and *auctoritas* were in perfect accord. Then Berengar of Tours (d. 1088) ventured to set up reason against authority: by reason the truth must be decided. This involved the question of the

relation in theology of authority and reason, and of whether the theological method is authoritative or rational. To these questions Berengar gave no answer; he was ruined by his opposition to Radbert's doctrine of transubstantiation. The Lombard Anselm (d. 1109), archbishop of Canterbury, was the first to deal with the subject. He took as his starting-point the traditional faith; but he was convinced that whoever has experience of the truths of the faith would be able to understand them. In accordance with this principle he pointed out the goal of theology and the way to its attainment: the function of theology is to demonstrate dogmas *sola ratione*.

It was a bold conception—too bold for the medieval world, for which faith was primarily the obligation to believe. It was easy, therefore, to understand why Anselm's method did not become the dominant one in theology. Not he, but the Frenchman Abelard (d. 1142), was the creator of the scholastic method. Abelard, too, started from tradition; but he discovered that the statements of the various authorities are very often in the relation of *sic et non*, yes and no. Upon this fact he based his pronouncement as to the function of theology: it must employ the dialectic method to reconcile the contradictions of tradition, and thus to shape the doctrines of the faith in accordance with reason. By teaching this method Abelard created the implements for the erection of the great theological systems of the schoolmen of the 12th and 13th centuries: Peter Lombard (d. 1160), Alexander of Hales (d. 1245), Albertus Magnus (d. 1280), and Thomas Aquinas (d. 1275). They adventured a complete exposition of Christian doctrine that should be altogether ecclesiastical and at the same time altogether rational. In so doing they set to work at the same time to complete the development of ecclesiastical dogma; the formulation of the Catholic doctrine of the Sacraments was the work of scholasticism.

Canon law is the twin-sister of scholasticism. At the very time when Peter Lombard was shaping his Sentences, the monk Gratian of Bologna was making a new collection of laws. It was not only significant that in the *Concordia discordantium canonum* ecclesiastical laws, whether from authentic or forged sources, were gathered together without regard to the existing civil law; or even greater eventual importance was the fact that Gratian taught that the contradictions of the canon law were to be reconciled by the same method as that used by theology to reconcile the discrepancies of doctrinal tradition. Thus Gratian became the founder of the science of canon law, a science which, like the scholastic theology, was entirely ecclesiastical and entirely rational (see CANON LAW).

Like the new theology and the new science of law, the new monasticism was also rooted in Latin soil. In the first of the new orders, that of the Cistercians (1098), the old monastic ideal set forth in the Rule of Benedict of Nursia still prevailed; but in the constitution and government of the order new ideas were at work. In the Premonstratensian order, however, founded in 1120 by Norbert of Xanten, a new conception of the whole function of monachism was introduced: the duty of the priest-monk is not only to work out his own salvation, but, by preaching and cure of souls, to labour for others. This was the dominant idea of the order of friars preachers founded in 1216, on the basis of the Premonstratensian rule, by Dominic of Osma (see DOMINIC, SAINT, and DOMINICANS). It was also the basis of the order of friars minor (Franciscans, *q.v.*), founded in 1210. For the foundation of Francis of Assisi came into existence as a society of itinerant preachers: no one was more deeply convinced than Francis of the duty of working for others, and his own mission was, as he said, to win souls. But with this idea he fused another, namely, that it is the task of the monk to imitate the humility and poverty of Jesus; and his order thus became a mendicant order. From the earliest times the monks had renounced all private property, and no individual monk, but only the order to which he belonged, could acquire possessions. For Francis this was not enough: he put "holy poverty" in place of renunciation of private property, and allowed neither monk nor monastery to have any possessions whatever; for only thus is the following of Jesus complete. So

mighty was the impression made by the poverty of the Minorites, that the Dominicans promptly followed their example and likewise became mendicant.

This alone would serve to indicate the remarkable deepening of the religious life that had taken place in the Latin countries. Its beginning may be traced as early as the 11th century (Pietro Damiani, *q.v.*), and in the 12th century the most influential exponent of this new piety was Bernard (*q.v.*) of Clairvaux, who taught men to find God by leading them to Christ. Contemporary with him were Hugh (*q.v.*) of St Victor and his pupil Richard (*q.v.*) of St Victor, both monks of the abbey of St Victor at Paris, the aim of whose teaching, based on that of the Pseudo-Dionysius, was a mystical absorption of thought in the Godhead and the surrender of self to the Eternal Love. Under the influence of these ideas, in part purely Christian and in part neo-platonic, piety gained in warmth and depth and became more personal; and though at first it flourished in the monasteries, and in those of the mendicant orders especially, it penetrated far beyond them and influenced the laity everywhere.

The new piety did not set itself in opposition either to the hierarchy or to the institutions of the Church, such as the sacraments and the discipline of penance, nor did it reject those foreign elements (asceticism, worship of saints and the like) which had passed of old time into Christianity from the ancient world. Its temper was not critical, but aggressively practical. It led the Romance nations to battle for Christendom. In the 11th and 12th centuries the chivalry of Spain and southern France took up the struggle with the Moors as a holy war. In the autumn of 1096 the nobles of France and Italy, joined by the Norman barons of England and Sicily, set out to wrest the Holy Land from the unbelievers; and for more than a century the cry, "Christ's land must be won for Christ," exercised an unparalleled power in Western Christendom.

All this meant a mighty exaltation of the Church, which ruled the minds of men as she had hardly ever done before. Nor was it possible that the position of the bishop of Rome, the supreme head of the Western Church, should remain unaffected by it. Two of the most powerful of the German emperors, Frederick I. and his son Henry VI., struggled to renew and to maintain the imperial supremacy over the papacy. The close relations between northern Italy and the Empire, and the union of the sovereignty of southern Italy with the German crown, seemed to afford the means for keeping Rome in subjection. But Frederick I. fought a losing battle, and when at the peace of Venice (1177) he recognized Alexander III. as pope, he relinquished the hope of carrying out his Italian policy; while Henry VI. died at the early age of thirty-two (1197), before his far-reaching schemes had been realized.

The field was thus cleared for the full development of papal power. This had greatly increased since the Concordat of Worms, and reached its height under Innocent III. (1198-1216). Innocent believed himself to be the representative of God, and as such the supreme possessor of both spiritual and temporal power. He therefore claimed in both spheres the supreme administrative, legislative and judicial authority. Just as he considered himself entitled to appoint to all ecclesiastical offices, so also he invested the emperor with his empire and kings with their kingdoms. Not only did he despatch his decretals to the universities to form the basis of the teaching of the canon law and of the decisions founded upon it, but he considered himself empowered to annul civil laws. Thus he annulled the Great Charter in 1215. Just as the Curia was the supreme court of appeal in ecclesiastical causes, so also the pope threatened disobedient princes with deposition, *e.g.* the emperor Otto IV. in 1210, and John of England in 1212.

The old institutions of the Catholic Church were transformed to suit the new position of the pope. From 1123 onward there had again been talk of general councils; but, unlike those of earlier times, these were assemblies summoned by the pope, who confirmed their resolutions. The canonical election of bishops also continued to be discussed; but the old electors, *i.e.* the clergy and laity of the dioceses, were deprived of the

right of election, this being now transferred exclusively to the cathedral chapters. The bishops kept their old title, but they described themselves accurately as "bishops by grace of the apostolic see," for they administered their dioceses as plenipotentiaries of the pope; and as time went on even the Church's criminal jurisdiction became more and more concentrated in the hands of the pope (see INQUISITION).

The rule of the Church by the Roman bishop had thus become a reality; but the papal claim to supreme temporal authority proved impossible to maintain, although Innocent III. had apparently enforced it. The long struggle against Frederick II., carried on by Gregory IX. (1227-1241) and Innocent IV. (1243-1254), did not result in victory; no papal sentence, but only death itself, deprived the emperor of his dominions; and when Boniface VIII. (1294-1303), who in the bull *Unam Sanctam* (1302) gave the papal claims to universal dominion their classical form, quarrelled with Philip IV. of France about the extension of the royal power, he could not but perceive that the national monarchy had become a force which it was impossible for the papacy to overcome.

(c) *Close of the Middle Ages. Disintegration.*—While the Church was yet at the height of her power the great revolution began, which was to end in the disruption of that union between the Temporal and the Spiritual which, under her dominion, had characterized the life of the West. The Temporal now claimed its proper rights. The political power of the Empire, indeed, had been shattered; but this left all the more room for the vigorous development of national states, notably of France and England. At the same time intellectual life was enriched by a wealth of fresh views and new ideas, partly the result of the busy intercourse with the East to which the Crusades had given the first impetus, and which had been strengthened and extended by lively trade relations, partly of the revived study, eagerly pursued, of ancient philosophy and literature (see RENAISSANCE). Old forms became too narrow, and vigorously growing national literatures appeared side by side with the universal Latin literature. The life of the Church, moreover, was affected by the economic changes due to the rise of the power of money as opposed to the old economic system based upon land.

The effects of these changes made themselves felt on all sides, in no case more strongly than in that of the papal claims to the supreme government of the world. Theoretically they were still unwaveringly asserted; indeed it was not till this time that they received their most uncompromising expression (Augustinus Triumphus, d. 1328; Alvarus Pelagius, d. 1352). After Boniface VIII., however, no pope seriously attempted to realize them; to do so had in fact become impossible, for from the time of their residence at Avignon (1305-1377) the popes were in a state of complete dependence upon the French crown. But even the curialistic theory met everywhere with opposition. In France Philip IV.'s jurists maintained that the temporal power was independent of the spiritual. In Italy, a little later, Dante championed the divine right of the emperor (*De Monarchia*, 1311). In Germany, Marsiglio of Padua and Jean of Jandun, the literary allies of the emperor Louis IV., ventured to define anew the nature of the civil power from the standpoint of natural law, and to assert its absolute sovereignty (*Defensor pacis*, c. 1352); while the Franciscan William of Occam (d. 1349) examined, also in Louis' interests, into the nature of the relation between the two powers. He too concluded that the temporal power is independent of the spiritual, and is even justified in invading the sphere of the latter in cases of necessity.

While these thoughts were filling men's minds, opposition to the papal rule over the Church was also gaining continually in strength. The reasons for this were numerous, first among them being the abuses of the papal system of finance, which had to provide funds for the vast administrative machinery of the Curia. There was also the boundless abuse and arbitrary exercise of the right of ecclesiastical patronage (provisions, reservations); and further the ever-increasing traffic in dispensations, the abuse of spiritual punishments for worldly ends, and so forth: No means, however, existed of enforcing any

remedy until the papal schism occurred in 1378. Such a schism as this, so intolerable to the ecclesiastical sense of the middle ages, necessitated the discovery of some authority superior to the rival popes, and therefore able to put an end to their quarrelling. General councils were now once more called to mind; but these were no longer conceived as mere advisory councils to the pope, but as the highest representative organ of the universal Church, and as such ranking above the pope, and competent to demand obedience even from him. This was the view of the Germans Conrad of Gelnhausen (d. 1390) and Heinrich of Langenstein (d. 1397), as also of the Frenchmen Pierre d'Ailli (d. 1420) and Jean Charlier Gerson (d. 1429). These all recognized in the convocation of a general council the means of setting bounds to the abuses in the government of the Church by an extensive reform. The council of Pisa (1409) separated without effecting anything; but the council of Constance (1414-1418) did actually put an end to the schism. The reforms begun at Constance and continued at Basel (1431-1449) proved, however, insufficient. Above all, the attempt to set up the general council as an ordinary institution of the Catholic Church failed; and the Roman papacy, restored at Constance, preserved its irresponsible and unlimited power over the government of the Church. (See PAPAcy; CONSTANCE, COUNCIL OF, and BASEL, COUNCIL OF.)

Thus the attempt to reform the Church by means of councils failed; but this very failure led to the survival of the desire for reform. It was kept alive by the most various circumstances; in the first instance by the attitude of the European states. Thanks to his recognition by the powers, Pope Eugenius IV. (1431-1447) had been victorious over the council of Basel; but neither France nor Germany was prepared to forgo the reforms passed by the council. France secured their validity, as far as she herself was concerned, by the Pragmatic Sanction of Bourges (July 7, 1438); Germany followed with the Acceptation of Mainz (March 26, 1439). The theory of the papal supremacy held by the Curia was thus at least called in question.

The antagonism of the opposition parties was even more pronounced. The tendencies which they represented had been present when the middle ages were yet at their height; but the papacy, while at the zenith of its power, had succeeded in crushing the attacks made upon the creed of the Church by its most dangerous foes, the dualistic Cathari. On the other hand it had not been able to overcome the less radical opposition of the "Poor Man of Lyons" (Waldo, d. c. 1217), and even in the 15th century stray supporters of the Waldensian teaching were to be found in Italy, France and Germany, everywhere keeping alive mistrust of the temporal power of the Church, of her priesthood and her hierarchy. In England the hierarchy was attacked by John Wycliffe (d. 1384), its greatest opponent before Luther. Starting from Augustine's conception of the Church as the community of the elect, he protested against a church of wealth and power, a church that had become a political institution instead of a school of salvation, and against its head, the bishop of Rome. Wycliffe's ideas, conveyed to the continent, precipitated the outbreak of the Hussite storm in Bohemia. The council of Constance thought to quell it by condemnation of Wycliffe's teaching and by the execution of John Huss (1415). But in vain. The flame burst forth, not in Bohemia alone, where Huss's death gave the signal for a general rising, but also in England among the Lollards, and in Germany among those of Huss's persuasion, who had many points of agreement with the remnant of the Waldenses. (See HUSS; WYCLIFFE; LOLLARDS; WALDENSES.)

This was open opposition; but there was besides another opposing force which, though it raised no noise of controversy, yet was far more widely severed from the views of the Church than either Wycliffe or Huss: this was the Renaissance, which began its reign in Italy during the 14th century. The Renaissance meant the emancipation of the secular world from the domination of the Church, and it contributed in no small measure to the rupture of the educated class with ecclesiastical tradition. Beauty of form alone was at first sought, and found in the antique; but, with the form, the spirit of the classical attitude towards life was revived. While the Church, like a

careful mother, sought to lead her children, never allowed to grow up, safely from time into eternity, the men of the Renaissance felt that they had come of age, and that they were entitled to make themselves at home in this world. They wished to possess the earth and enjoy it by means of secular education and culture, and an impassable gulf yawned between their views of religion and morality and those of the Church.

This return to the ideals of antiquity did not remain confined to Italy, but the humanism of the northern countries presents no close parallel to the Italian renaissance. However much it agreed in admiration of the ancients, it differed absolutely in its preservation of the fundamental ideas of Christianity. But neither Reuchlin (d. 1522), Erasmus (d. 1536), Faber d'Étaples (d. 1536), Thomas More (d. 1535), nor the numerous others who were their disciples, or who shared their views, were in the least degree satisfied with the conditions prevailing in the Church. Their ideal was a return to that simplicity of primitive Christendom which they believed they found revealed in the New Testament and in the writings of the early Fathers.

To this theology could not point the way. Since the time of Duns Scotus (d. 1308) theologians had been conscious of the discrepancy between Aristotelianism and ecclesiastical dogma. Faith in the infallibility of the scholastic system was thus shaken, and the system itself was destroyed by the revival of philosophic nominalism, which had been discredited in the 11th century by the realism of the great schoolmen. It now found a bold supporter in William of Occam (*q.v.*), and through him became widely accepted. But nominalism was powerless to inspire theology with new life; on the contrary, its intervention only increased the inextricable tangle of the hairsplitting questions with which theology busied itself, and made their solution more and more impossible.

Mysticism, moreover, which had no lack of noteworthy supporters in the 14th and 15th centuries, and the various new departures in thought initiated by individual theologians such as Nicolaus Cusanus (d. 1464) and Wessel Gansfort (d. 1480), were not competent to restore to the Church what she had once possessed in scholasticism—that is to say, a conception of Christianity in which all Christendom recognized the convictions in which it lived and had its being.

This was all the more significant because Western Christendom in the 15th century was by no means irreligious. Men's minds were agitated by spiritual questions, and they sought salvation and the assurance of salvation, using every means prescribed by the Church: confession and the communion, indulgences and relics, pilgrimages and oblations, prayers and attendance at church; none of all these were contemned or held cheap. Yet the age had no inward peace.

After the failure of the attempts at reform by the councils, the guidance of the Church was left undisturbed in the hands of the popes, and they were determined that it should remain so. In 1450 Eugenius IV. set up in opposition to the council of Basel a general council summoned by himself, which met first at Ferrara and afterwards at Florence. Here he appeared to score a great success. The split between East and West had led in the 11th century to the rupture of ecclesiastical relations between Rome and Constantinople. This schism had lasted since the 16th of July 1054; but now a union with the Eastern Church was successfully accomplished at Florence. Eugenius certainly owed his success merely to the political necessities of the emperor of the East, and his union was forthwith destroyed owing to its repudiation by oriental Christendom; yet at the same time his decretals of union were not devoid of importance, for in them the pope reaffirmed the scholastic doctrine regarding the sacraments as a dogma of the Church, and he spoke as the supreme head of all Christendom.

This claim to the supreme government of the Church was to be steadily maintained. In the year 1512 Julius II. called together the fifth Lateran general council, which expressly recognized the subjection of the councils to the pope (Leo X.'s bull *Pastor Aeternum*, of the 19th of December 1516), and also declared the constitution *Unam Sanctam* (see above) valid in law.

But the papacy that sought to win back its old position was itself no longer the same as of old. Eugenius IV.'s successor, Nicholas V. (1447-1455), was the first of the Renaissance popes. Under his successors the views which prevailed at the secular courts of the Italian princes came likewise into play at the Curia: the papacy became an Italian principedom. Innocent VIII., Alexander VI., Julius II. were in many respects remarkable men, but they were scarcely affected by the convictions of the Christian faith. The terrible tragedy which was consummated on the 23rd of May 1498 before the Palazzo Vecchio, in Florence, casts a lurid light upon the irreconcilable opposition in which the wearers of the papal dignity stood to medieval piety; for Girolamo Savonarola was in every fibre a loyal son of the medieval Church.

Twenty years after Savonarola's death Martin Luther made public his theses against indulgences. The Reformation which thus began brought the disintegrating process of the middle ages to an end, and at the same time divided Western Catholicism in two. Yet we may say that this was its salvation; for the struggle against Luther drove the papacy back to its ecclesiastical duties, and the council of Trent established medieval dogma as the doctrine of modern Catholicism in contradistinction to Protestantism. (See also PAPACY; RENAISSANCE; REFORMATION, and biographies of popes, &c.)

AUTHORITIES.—For sources see U. Chevalier, *Répertoire des sources historiques du moyen-âge* (Paris, 1903); A. Potthast, *Bibliotheca historica mediæ ævi* (Berlin, 1896); W. Wattenbach, *Deutschlands Geschichtsquellen im Mittelalter* (7th ed., Stuttgart, 1904); A. Molinier, *Les Sources de l'histoire de la France* (Paris, 1901). General Treatises: Philip Schaff, *History of the Christian Church* (12 vols., 5th ed., New York, 1889-1892), vol. iv. *Medieval Christianity*; W. Moeller, *Lehrbuch der Kirchengeschichte*, vol. ii. *Das Mittelalter* (Freiburg, 1891); H. H. Milman, *History of Latin Christianity* (6 vols., 2nd ed., London, 1857). Particular Treatises: J. Lingard, *The History and Antiquities of the Anglo-Saxon Church* (2 vols. 3rd ed., London, 1845); E. Churton, *The Early English Church* (London, 1878); A. Martineau, *Church History in England from the Earliest Times to the Reformation* (London, 1878); W. Hunt, *The English Church from its Foundation to the Norman Conquest* (London, 1899); W. Stubbs, *Constitutional History of England* (3 vols., London, 1874-1878); A. Bellesheim, *Geschichte der kath. Kirche in Schottland* (2 vols., Mainz, 1883; Engl. transl. with Notes and Additions by O. H. Blair, 4 vols., Edinburgh, 1887-1890); W. Stephen, *History of the Scottish Church* (Edinburgh, 1894-1896, 2 vols.); W. D. Killen, *The Ecclesiastical History of Ireland* (2 vols., London, 1875-1878); A. Bellesheim, *Geschichte der kath. Kirche in Irland* (3 vols., Mainz, 1890-1891); F. Rettberg, *Kirchengeschichte Deutschlands* (2 vols. Göttingen, 1846, 1848); A. Hauck, *Kirchengeschichte Deutschlands* (4 vols., Leipzig, 3rd ed., 1904); *Gallia Christiana in provinciis eccl. distributa* (16 and 3 vols., Paris, 1715-1900); F. N. Fager, *Histoire de l'église cathol. en France depuis son origine* (19 vols., Paris, 1862-1873); Ughelli, *Italia sacra* (10 vols., Venice, 1717-1722); P. Gams, *Kirchengeschichte von Spanien* (5 vols., Regensburg, 1862-1879); H. Reuter dahl, *Svenska Kyrkans historia* (3 vols., Lund, 1838-1863); A. v. Maurer, *Die Bekehrung des norwegischen Stammes* (2 vols., Munich, 1855-1856); Bang, *Udsigt over den norske Kirkes historie under Katholicismen* (Christiania, 1887); P. Gams, *Series episcoporum ecclesiae catholicae* (Regensburg, 1873); C. Eubel, *Hierarchia catholica mediæ ævi* (2 vols., Münster, 1898, 1901); P. Hinschius, *System des kath. Kirchenrechts* (6 vols., Berlin, 1869-1896); E. Friedberg, *Lehrbuch des Kirchenrechts* (5th ed., Leipzig, 1903); U. Stutz, "Kirchenrecht" (Holtzendorff-Kohler, *Encyklopaedie der Rechtswissenschaft*, 6th ed. II. Leipzig, 1904); B. Hauréau, *Histoire de la philosophie scolastique* (Paris, 1872); F. Schwane, *Dogmengeschichte der mittleren Zeit* (Freiburg, 1882); A. Ebert, *Allgem. Geschichte der Literatur des Mittelalters im Abendlande* (3 vols., Leipzig, 1874-1887); C. F. v. Hefele, *Conciliengeschichte* (2nd ed., 9 vols., Freiburg, 1873-1890). (A. H. *)

C. THE MODERN CHURCH

The issue in 1564 of the canons of the council of Trent marks a very definite epoch in the history of the Christian Church. Up till that time, in spite of the schism of East and West and of innumerable heresies, the idea of the Church as Catholic, not only in its faith but in its organization, had been generally accepted. From this conception the Reformers had, at the outset, no intention of departing. Their object had been to purify the Church of medieval accretions, and to restore the primitive model in the light of the new learning; the idea of rival "churches," differing in their fundamental doctrines and in their principles of organization, existing side by side, was as

abhorrent to them as to the most rigid partisan of Roman centralization. The actual divisions of Western Christendom are the outcome, less of the purely religious influences of the Reformation period than of the political forces with which they were associated and confused. When it became clear that the idea of doctrinal change would find no acceptance at Rome, the Reformers appealed to the divine authority of the civil power against that of the popes; and princes within their several states succeeded, as the result of purely political struggles and combinations, in establishing the form of religion best suited to their convictions or their policy. Thus over a great part of Europe the Catholic Church was split up into territorial or national churches, which, whatever the theoretical ties which bound them together, were in fact separate organizations, tending ever more and more to become isolated and self-contained units with no formal intercommunion, and, as the rivalry of nationalities grew, with increasingly little even of intercommunication.

It was not, indeed, till the settlement of Westphalia in 1648, after the Thirty Years' War, that this territorial division of Christendom became stereotyped, but the process had been going on for a hundred years previously; in some states, as in England and Scotland, it had long been completed; in others, as in South Germany, Bohemia and Poland, it was defeated by the political and missionary efforts of the Jesuits and other agents of the counter-Reformation. In any case, it received a vast impetus from the action of the council of Trent. With the issue of the Tridentine canons, all hope even of compromise between the "new" and the "old" religions was definitely closed. The anathema of the Roman Church had fallen upon all the fundamental doctrines for which the Reformers had contended and died; the right of free discussion within the limits of the creeds, which had given room for the speculations of the medieval philosophers, was henceforth curtailed and confined; and the definitions of the schoolmen were for ever exalted by the authority of Rome into dogmas of the Church. The Latin Church, which, by combining the tradition of the Roman centralized organization with a great elasticity in practice and in the interpretation of doctrine, had hitherto been the moulding force of civilization in the West, is henceforth more or less in antagonism to that civilization, which advances in all its branches—in science, in literature, in art—to a greater or less degree outside of and in spite of her, until in its ultimate and most characteristic developments it falls under the formal condemnation of the pope, formulated in the famous Syllabus of 1864. Considered from the standpoint of the world outside, the Roman Church is, no less than the Protestant communities, merely one of the sects into which Western Christendom has been divided—the most important and widespread, it is true, but playing in the general life and thought of the world a part immeasurably less important than that filled by the Church before the Reformation, and one in no sense justifying her claim to be considered as the sole inheritor of the tradition of the pre-Reformation Church.

If this be true of the Roman Catholic Church, it is still more so of the other great communities and confessions which emerged from the controversies of the Reformation. Of these the Anglican Church held most closely to the tradition of Catholic organization; but she has never made any higher claim than to be one of "the three branches of the Catholic Church," a claim repudiated by Rome and never formally admitted by the Church of the East. The Protestant churches established on the continent, even where—as in the case of the Lutherans—they approximate more closely than the official Anglican Church to Roman doctrine and practice, make no such claim. The Bible is for them the real source of authority in doctrine; their organization is part and parcel of that of the state. They are, in fact, the state in its religious aspect, and as such are territorial or national, not Catholic. This tendency has been common in the East also, where with the growth of racial rivalries the Orthodox Church has split into a series of national churches, holding the same faith but independent as to organization.

A yet further development, of comparatively recent growth, has been the formation of what are now commonly called in

England the "free churches." These represent a theory of the Church practically unknown to the Reformers, and only reached through the necessity for discovering a logical basis for the communities of conscientious dissidents from the established churches. According to this the Catholic Church is not a visibly organized body, but the sum of all "faithful people" throughout the world, who group themselves in churches modelled according to their convictions or needs. For the organization of these churches no divine sanction is claimed, though all are theoretically modelled on the lines laid down in the Christian Scriptures. It follows that, while in the traditional Church, with its claim to an unbroken descent from a divine original, the individual is subordinate to the Church, in the "free churches" the Church is in a certain sense secondary to the individual. The believer may pass from one community to another without imperilling his spiritual life, or even establish a new church without necessarily incurring the reproach of schism. From this theory, powerful in Great Britain and her colonies, supreme in the United States of America, has resulted an enormous multiplication of sects.

It follows from the above argument that, from the period of the Reformation onward, no historical account of the Christian Church as a whole, and considered as a definite institution, is possible. The stream of continuity has been broken, and divides into innumerable channels. The only possible synthesis is that of the Christianity common to all; as institutions, though they possess many features in common, their history is separate and must be separately dealt with. The history of the various branches of the Christian Church since the Reformation will therefore be found under their several titles (see ROMAN CATHOLIC CHURCH; ENGLAND, CHURCH OF; PRESBYTERIANISM; BAPTISTS, &c., &c.). (W. A. P.)

CHURCHILL, CHARLES (1731-1764), English poet and satirist, was born in Vine Street, Westminster, in February 1731. His father, rector of Rainham, Essex, held the curacy and lectureship of St John's, Westminster, from 1733, and the son was educated at Westminster school, where he became a good classical scholar, and formed a close and lasting intimacy with Robert Lloyd. Churchill was entered at Trinity College, Cambridge, in 1749, but never resided. He had been refused at Oxford, ostensibly on the unlikely ground of lack of classical knowledge, but more probably because of a hasty marriage which he had contracted within the rules of the Fleet in his eighteenth year. He and his wife lived in his father's house, and Churchill was afterwards sent to the north of England to prepare for holy orders. He became curate of South Cadbury, Somersetshire, and, on receiving priest's orders (1756), began to act as his father's curate at Rainham. Two years later the elder Churchill died, and the son was elected to succeed him in his curacy and lectureship. His emoluments amounted to less than £100 a year, and he increased his income by teaching in a girls' school. He fulfilled his various duties with decorum for a while, but his marriage proved unfortunate, and he spent much of his time in dissipation in the society of Robert Lloyd. He was separated from his wife in 1761, and would have been imprisoned for debt but for the timely help of Lloyd's father, who had been an usher and was now a master of Westminster school.

Churchill had already done some work for the booksellers, and his friend Lloyd had had some success with a didactic poem, "The Actor." His intimate knowledge of the theatre was now turned to account in the *Rosciad*, which appeared in March 1761. This reckless and amusing satire described with the most disconcerting accuracy the faults of the various actors and actresses on the London stage. Its immediate popularity was no doubt largely due to its personal character, but its real vigour and raciness make it worth reading even now when the objects of Churchill's wit are many of them forgotten. The first impression was published anonymously, and in the *Critical Review*, conducted by Tobias Smollett, it was confidently asserted that the poem was the joint production of George Colman, Bonnell Thornton and Robert Lloyd. Churchill owned the authorship and immediately published an *Apology addressed to the Critical Reviewers*, which, after developing the subject that it is only the caste of

authors that prey on their own kind, repeats the fierce attack on the stage. Incidentally it contains an enthusiastic tribute to Dryden, of whom Churchill was a not unworthy scholar. In the *Rosciad* he had given warm praise to Mrs Pritchard, Mrs Cibber and Mrs Clive, but no leading London actor, with the exception of David Garrick, had escaped censure, and in the *Apology* Garrick was clearly threatened. He deprecated criticism by showing every possible civility to Churchill, who became a terror to the actors. Thomas Davies wrote to Garrick attributing his blundering in the part of Cymbeline "to my accidentally seeing Mr Churchill in the pit, it rendering me confused and unmindful of my business." Churchill's satire made him many enemies, and inquiries into his way of life provided abundant matter for retort. In *Night, an Epistle to Robert Lloyd* (1761), he answered the attacks made on him, offering by way of defence the argument that any faults were better than hypocrisy. His scandalous conduct brought down the censure of the dean of Westminster, and in 1763 the protests of his parishioners led him to resign his offices, and he was free to wear his "blue coat with metal buttons" and much gold lace without remonstrance from the dean. The *Rosciad* had been refused by several publishers, and was finally published at Churchill's own expense. He received a considerable sum from the sale, and paid his old creditors in full, besides making an allowance to his wife.

He now became a close ally of John Wilkes, whom he regularly assisted with the *North Briton*. The *Prophecy of Famine: A Scots Pastoral* (1763), his next poem, was founded on a paper written originally for that journal. This violent satire on Scottish influence fell in with the current hatred of Lord Bute, and the Scottish place-hunters were as much alarmed as the actors had been. When Wilkes was arrested he gave Churchill a timely hint to retire to the country for a time, the publisher, Kearsley, having stated that he received part of the profits from the paper. His *Epistle to William Hogarth* (1763) was in answer to the caricature of Wilkes made during the trial. In it Hogarth's vanity and envy were attacked in an invective which Garrick quoted as "shocking and barbarous." Hogarth retaliated by a caricature of Churchill as a bear in torn clerical bands hugging a pot of porter and a club made of lies and *North Britons*. The *Duellist* (1763) is a virulent satire on the most active opponents of Wilkes in the House of Lords, especially on Bishop Warburton. He attacked Dr Johnson among others in *The Ghost* as "Pomposo, insolent and loud, Vain idol of a scribbling crowd." Other poems are "The Conference" (1763); "The Author" (1763), highly praised by Churchill's contemporaries; "Gotham" (1764), a poem on the duties of a king, didactic rather than satiric in tone; "The Candidate" (1764), a satire on John Montagu, fourth earl of Sandwich, one of Wilkes's bitterest enemies, whom he had already denounced for his treachery in the *Duellist* (Bk. iii.) as "too infamous to have a friend"; "The Farewell" (1764); "The Times" (1764); "Independence," and an unfinished "Journey."

In October 1764 he went to Boulogne to join Wilkes. There he was attacked by a fever of which he died on the 4th of November. He left his property to his two sons, and made Wilkes his literary executor with full powers. Wilkes did little. He wrote an epitaph for his friend and about half a dozen notes on his poems, and Andrew Kippis acknowledges some slight assistance from him in preparing his life of Churchill for the *Biographia Britannica* (1780). There is more than one instance of Churchill's generosity to his friends. In 1763 he found his friend Robert Lloyd in prison for debt. He paid a guinea a week for his better maintenance in the Fleet, and raised a subscription to set him free. Lloyd fell ill on receipt of the news of Churchill's death, and died shortly afterwards. Churchill's sister Patty, who was engaged to Lloyd, did not long survive them. William Cowper was his schoolfellow, and left many kindly references to him.

A partial collection of Churchill's poems appeared in 1763. They are included in Chalmers's edition of the English poets, and were edited (1804) by W. Tooke. This was reprinted in the Aldine edition (1844). There is a revised edition (1892) in the same series, *The Poetical Works of Charles Churchill, with a Memoir by J. L. Hannay and copious notes by W. Tooke*. For Churchill's biography,

see *Genuine Memoirs of Charles Churchill, with an account of and observations on his writings; together with some Original letters . . . between him and the author* (1765); A. Kippis, in *Biographia Britannica* (1780); also John Forster in the *Edinburgh Review* (January 1845).

CHURCHILL, LORD RANDOLPH HENRY SPENCER (1849–1895), English statesman, third son of John, seventh duke of Marlborough, by Frances, daughter of the third marquess of Londonderry, was born at Blenheim Palace, on the 13th of February 1849. His early education was conducted at home, and at Mr Tabor's preparatory school at Cheam. In January 1863 he went to Eton, where he remained till July 1865. He was not specially distinguished either in school work or games while at Eton; his contemporaries describe him as a vivacious and rather unruly lad. In October 1867 he matriculated at Merton College, Oxford. He was fond of amusement, and had carried to Oxford an early taste for sport which he retained throughout life. But he read with some industry, and obtained a second class in jurisprudence and modern history in 1870. In 1874 he was elected to parliament in the Conservative interest for Woodstock, defeating Mr George Brodrick, a fellow, and afterwards warden, of Merton College. His maiden speech, delivered in his first session, made no impression on the House.

It was not till 1878 that he forced himself into public notice as the exponent of a species of independent Conservatism. He directed a series of furious attacks against some of the occupants of the front ministerial bench, and especially that "old gang" who were distinguished rather for the respectability of their private characters, and the unblemished purity of their Toryism, than for striking talent. Mr Sclater-Booth (afterwards 1st Lord Basing), president of the Local Government Board, was the especial object of his ire, and that minister's County Government Bill was fiercely denounced as the "crowning dishonour to Tory principles," and the "supreme violation of political honesty." The audacity of Lord Randolph's attitude, and the vituperative fluency of his invective, made him a parliamentary figure of some importance before the dissolution of the 1874 parliament, though he was not as yet taken quite seriously. In the new parliament of 1880 he speedily began to play a more notable rôle. With the assistance of his devoted adherents, Sir Henry Drummond Wolff, Sir John Gorst and occasionally of Mr Arthur Balfour, and one or two others, he constituted himself at once the audacious opponent of the Liberal administration and the unsparing critic of the Conservative front bench. The "fourth party," as it was nicknamed, was effective at first not so much in damaging the government as in awakening the opposition from the apathy which had fallen upon it after its defeat at the polls. Churchill roused the Conservatives and gave them a fighting issue, by putting himself at the head of the resistance to Mr Bradlaugh, the member for Northampton, who, though an avowed atheist or agnostic, was prepared to take the parliamentary oath. Sir Stafford Northcote, the Conservative leader in the Lower House, was forced to take a strong line on this difficult question by the energy of the fourth party, who in this case clearly expressed the views of the bulk of the opposition. The long and acrimonious controversy over Mr Bradlaugh's seat, if it added little to the reputation of the English legislature, at least showed that Lord Randolph Churchill was a parliamentary champion who added to his audacity much tactical skill and shrewdness. He continued to play a conspicuous part throughout the parliament of 1880–1885, dealing his blows with almost equal vigour at Mr Gladstone and at the Conservative front bench, some of whose members, and particularly Sir Richard Cross and Mr W. H. Smith, he assailed with extreme virulence. From the beginning of the Egyptian imbroglio Lord Randolph was emphatically opposed to almost every step taken by the government. He declared that the suppression of Arabi Pasha's rebellion was an error, and the restoration of the khedive's authority a crime. He called Mr Gladstone the "Moloch of Midlothian," for whom torrents of blood had been shed in Africa. He was equally severe on the domestic policy of the administration, and was particularly bitter in his criticism of the Kilmainham treaty and the *rapprochement* between the Gladstonians and the Parnellites. It is true

that for some time before the fall of the Liberals in 1885 he had considerably modified his attitude towards the Irish question, and was himself cultivating friendly relations with the Home Rule members, and even obtained from them the assistance of the Irish vote in the English constituencies in the general election. By this time he had definitely formulated the policy of progressive Conservatism which was known as "Tory democracy." He declared that the Conservatives ought to adopt, rather than oppose, reforms of a popular character, and to challenge the claims of the Liberals to pose as the champions of the masses. His views were to a large extent accepted by the official Conservative leaders in the treatment of the Gladstonian Franchise Bill of 1884. Lord Randolph insisted that the principle of the bill should be accepted by the opposition, and that resistance should be focused upon the refusal of the government to combine with it a scheme of redistribution. The prominent, and on the whole judicious and successful, part he played in the debates on these questions, still further increased his influence with the rank and file of the Conservatives in the constituencies. At the same time he was actively spreading the gospel of democratic Toryism in a series of platform campaigns. In 1883 and 1884 he invaded the Radical stronghold of Birmingham itself, and in the latter year took part in a Conservative garden party at Aston Manor, at which his opponents paid him the compliment of raising a serious riot. He gave constant attention to the party organization, which had fallen into considerable disorder after 1880, and was an active promoter of the Primrose League, which owed its origin to the happy inspiration of one of his own "fourth party" colleagues.

In 1884 the struggle between stationary and progressive Toryism came to a head, and terminated in favour of the latter. At the conference of the Central Union of Conservative Associations, Lord Randolph was nominated chairman, notwithstanding the strenuous opposition of the parliamentary leaders of the party. The split was averted by Lord Randolph's voluntary resignation; but the episode had confirmed his title to a leading place in the Tory ranks. It was further strengthened by the prominent part he played in the events immediately preceding the fall of the Liberal government in 1885; and when Mr Childers's budget resolutions were defeated by the Conservatives, aided by about half the Parnellites, Lord Randolph Churchill's admirers were justified in proclaiming him to have been the "organizer of victory." His services were, at any rate, far too important to be refused recognition; and in Lord Salisbury's cabinet of 1885 he was appointed to no less an office than that of secretary of state for India. During the few months of his tenure of this great post the young free-lance of Tory democracy surprised the permanent officials and his own friends by the assiduity with which he attended to his departmental duties and the rapidity with which he mastered the complicated questions of Indian administration. In the autumn election of 1885 he contested Central Birmingham against Mr Bright, and though defeated here, was at the same time returned by a very large majority for South Paddington. In the contest which arose over Mr Gladstone's Home Rule scheme, both in and out of parliament, Lord Randolph again bore a conspicuous part, and in the electioneering campaign his activity was only second to that of some of the Liberal Unionists, the marquess of Hartington, Mr Goschen and Mr Chamberlain. He was now the recognized Conservative champion in the Lower Chamber, and when the second Salisbury administration was formed after the general election of 1886 he became chancellor of the exchequer and leader of the House of Commons. His management of the House was on the whole successful, and was marked by tact, discretion and temper. But he had never really reconciled himself with some of his colleagues, and there was a good deal of friction in his relations with them, which ended with his sudden resignation on the 20th of December 1886. Various motives influenced him in taking this surprising step; but the only ostensible cause was that put forward in his letter to Lord Salisbury, which was read in the House of Commons on 27th January. In this document he stated that his resignation was due to his inability, as chancellor of the exchequer, to concur

in the demands made on the treasury by the ministers at the head of the naval and military establishments. It was commonly supposed that he expected his resignation to be followed by the unconditional surrender of the cabinet, and his restoration to office on his own terms. The sequel, however, was entirely different. The cabinet was reconstructed with Mr Goschen as chancellor of the exchequer (Lord Randolph had "forgotten Goschen," as he is said to have remarked), and Churchill's own career as a Conservative chief was practically closed.

He continued, for some years longer, to take a considerable share in the proceedings of parliament, giving a general, though decidedly independent, support to the Unionist administration. On the Irish question he was a very candid critic of Mr Balfour's measures, and one of his later speeches, which recalled the acrimonious violence of his earlier period, was that which he delivered in 1890 on the report of the Parnell commission. He also fulfilled the promise made on his resignation by occasionally advocating the principles of economy and retrenchment in the debates on the naval and military estimates. In April 1889, on the death of Mr Bright, he was asked to come forward as a candidate for the vacant seat in Birmingham, and the result was a rather angry controversy with Mr Chamberlain, terminating in the so-called "Birmingham compact" for the division of representation of the Midland capital between Liberal Unionists and Conservatives. But his health was already precarious, and this, combined with the anomaly of his position, induced him to relax his devotion to parliament during the later years of the Salisbury administration. He bestowed much attention on society, travel and sport. He was an ardent supporter of the turf, and in 1889 he won the Oaks with a mare named the Abbess de Jouarre. In 1891 he went to South Africa, in search both of health and relaxation. He travelled for some months through Cape Colony, the Transvaal and Rhodesia, making notes on the politics and economics of the countries, shooting lions, and recording his impressions in letters to a London newspaper, which were afterwards republished under the title of *Men, Mines and Animals in South Africa*. He returned with renewed energy, and in the general election of 1892 once more flung himself, with his old vigour, into the strife of parties. His seat at South Paddington was uncontested; but he was active on the platform, and when parliament met he returned to the opposition front bench, and again took a leading part in debate, attacking Mr Gladstone's second Home Rule Bill with especial energy. But it was soon apparent that his powers were undermined by the inroads of disease. As the session of 1893 wore on his speeches lost their old effectiveness, and in 1894 he was listened to not so much with interest as with pity. His last speech in the House was delivered in the debate on Uganda in June 1894, and was a painful failure. He was, in fact, dying of general paralysis. A journey round the world was undertaken as a forlorn hope. Lord Randolph started in the autumn of 1894, accompanied by his wife, but the malady made so much progress that he was brought back in haste from Cairo. He reached England shortly before Christmas and died in London on the 24th of January 1895.

Lord Randolph Churchill married, in January 1874, Jennie, daughter of Mr Leonard Jerome of New York, U.S.A., by whom he had two sons. In 1900 Lady Randolph Churchill married Mr G. Cornwallis-West.

His elder son, WINSTON CHURCHILL (1874—), was educated at Harrow, and after serving for a few years in the army and acting as a special correspondent in the South African War (being taken prisoner by the Boers, Nov. 15, 1899, but escaping on Dec. 12), was elected Unionist member of parliament for Oldham in October 1900. As the son of his father, his political future excited much interest. His views, however, as to the policy of the Conservative party gradually changed, and having during 1904-1905 taken an active part in assisting the Liberal party in parliament, he stood for N.W. Manchester at the general election (1906) and was triumphantly returned as a Liberal and free-trader. He was made under-secretary for the colonies in the new Liberal government. In this position he became as

conspicuous in parliament as he had already become on the platform as a brilliant and aggressive orator, and no politician of the day attracted more interest or excited more controversy. He was promoted to cabinet rank as president of the Board of Trade in Mr Asquith's government in April (1908), but was defeated at the consequent by-election in Manchester after a contest which aroused the keenest excitement. He was then returned for Dundee, and later in the year married Miss Clementine Hozier.

An interesting and authoritative biography of Lord Randolph, by his son Winston (who had already won his spurs as a writer in his *River War*, 1899, and other books on his military experiences), appeared in 1906; and a brief and intimate appreciation by Lord Rosebery, inspired by this biography, was published a few months later. Lord Randolph's earlier speeches were edited, with an introduction and notes, by Louis Jennings (2 vols., London, 1889). See also T. H. S. Escott, *Randolph Spencer Churchill* (1895); H. W. Lucy, *Diary of Two Parliaments* (1892); and Mrs Cornwallis-West, *The Reminiscences of Lady Randolph Churchill* (i.e. of the author) (1908). (S. J. L.)

CHURCHILL (MISSINNIPPI or ENGLISH), the name of a river of the province of Saskatchewan and district of Keewatin, Canada. It rises in La Loche (or Methy) lake, a small lake in 56° 30' N. and 109° 30' W., at an altitude of 1577 ft. above the sea, and flows E.N.E. to Hudson's Bay, passing through a number of lake expansions. Its principal tributaries are the Beaver (350 m. long), Sandy and Reindeer rivers. Between Frog and Methy portages (480 m.) it formed part of the old *voyageur* route to the Peace, Athabasca, and Mackenzie. It is still navigated by canoes, but has many rapids. Its principal affluent, the Reindeer, discharges the waters of Reindeer Lake (1150 ft. above the sea, with an area of 2490 sq. m.) and Wollaston Lake (altitude, 1300 ft.). The Churchill is 925 m. long. Fort Churchill, at its mouth, is the best harbour in the southern portion of Hudson's Bay. The portage of La Loche (or Methy), 12½ m. in length, connects its head waters with the Clearwater river, a tributary of the Athabasca, draining into the Arctic Ocean.

CHURCHING OF WOMEN, the Christian ceremony of thanksgiving on the part of mothers shortly after the birth of their children. It no doubt originated in the Mosaic regulation as to purification (Lev. xii. 6). In ancient times the ceremony was usual but not obligatory in England. In the Greek and Roman Catholic Churches to-day it is imperative. The custom is first mentioned in the pseudo-Nicene Arabic canons. No ancient form of service exists, and that which figures in the English prayer-book of to-day dates only from the middle ages. Custom differs, but the usual date of churching was the fortieth day after confinement, in accordance with the Biblical date of the presentment of the Virgin Mary and the Child Jesus at the Temple. It was formerly regarded as unlucky for a woman to leave her house to go out at all after confinement till she went to be churched. It was not unusual for the churching service to be said in private houses. In Herefordshire it was not considered proper for the husband to appear in church at the service, or at all events in the same pew. In some parishes there was a special pew known as "the churching seat." The words in the rubric requiring the woman to come "decently apparelled" refer to the times when it was thought unbecoming for a woman to come to the service with the elaborate head-dress then the fashion. A veil was usually worn, and in some parishes this was provided by the church, for an inventory of goods belonging to St Benet's, Gracechurch Street, in 1560, includes "A churching cloth, fringed, white damask."

The "convenient place," which, according to the rubric, the woman must occupy, was in pre-Reformation times the church-door. In the first prayer-book of Edward VI., she was to be "nigh unto the quire door." In the second of his books, she was to be "nigh unto the place where the Table standeth." Bishop Wren's orders for the diocese of Norwich in 1636 are "That women to be churched come and kneel at a side near the Communion Table without the rail, being veiled according to custom, and not covered with a hat." In Devonshire churching was sometimes called "being uprose." Churchings were formerly registered in some parishes. In pre-Reformation days it was the custom in England for women to carry lighted tapers when

being churched, in allusion to the Feast of the Purification of the Virgin (February 2nd), the day chosen by the Roman Catholic church for the blessing of the candles for the whole year (see CANDLEMAS). At her churching a woman was expected to make some offering to the church, such as the chrisom or alb thrown over the child at christening.

CHURCH RATE, the name of a tax formerly levied in each parish in England and Ireland for the benefit of the parish church. Out of these rates were defrayed the expenses of carrying on divine service, repairing the fabric of the church, and paying the salaries of the officials connected with it. The church rates were made by the churchwardens, together with the parishioners duly assembled after proper notice in the vestry or the church. The rates thus made were recoverable in the ecclesiastical court, or, if the arrears did not exceed £10 and no questions were raised as to the legal liability, before two justices of the peace. Any payment not strictly recognized by law made out of the rate destroyed its validity. The church rate was a personal charge imposed on the occupier of land or of a house in the parish, and, though it was compulsory, much difficulty was found in effectually applying the compulsion. This was especially so in the case of Nonconformists, who had conscientious objections to supporting the Established Church; and in Ireland, where the population was preponderatingly Roman Catholic, the grievance was specially felt and resented. The agitation against church rates led in 1868 to the passing of the Compulsory Church Rates Abolition Act. By this act church rates are no longer compulsory on the person rated, but are merely voluntary, and those who are not willing to pay them are excluded from inquiring into, objecting to, or voting in respect of their expenditure (s. 8).

CHURCHWARDEN, in England, the guardian or keeper of a church, and representative of the body of the parish. The name is derived from the original duty attached to the office,—that of the custody or guardianship of the fabric and furniture of the church,—which dates from the 14th century, when the responsibility of providing for the repairs of the nave, and of furnishing the utensils for divine service, was settled on the parishioners. Churchwardens are always lay persons, and as they may, like “artificial persons,” hold goods and chattels and bring actions for them, they are recognized in law as quasi-corporations. Resident householders of a parish are those primarily eligible as churchwardens, but non-resident householders who are habitually occupiers are also eligible, while there are a few classes of persons who are either ineligible or exempted. The appointment of churchwardens is regulated by the 89th canon, which requires that the churchwardens shall be chosen by the joint consent of the ministers and parishioners, if it may be; but if they cannot agree upon such a choice, then the minister is to choose one, and the parishioners another. If, however, there is any special custom of the place, the custom prevails, and the most common custom is for the minister to appoint one, and the parishioners another, and this has been established by English statute, in the case of new parishes, by the Church Building and New Parishes Acts 1818–1884. There are other special customs recognized in various localities, e.g. in some of the larger parishes in the north of England a churchwarden is chosen for each township of the parish; in the old ecclesiastical parishes of London both churchwardens are chosen by the parishioners; in some cases they are appointed by the select vestry, or by the lord of the manor, and in a few exceptional cases are chosen by the outgoing churchwardens.

In general, churchwardens are appointed in Easter week, usually Easter Monday or Easter Tuesday, but in new parishes the first appointment must be within twenty-one days after the consecration of the church, or two calendar months after the formation of the parish, subsequent appointments taking place at the usual time for the appointment of parish officers. Each churchwarden after election subscribes before the ordinary a declaration that he will execute his office faithfully.

The duties of churchwardens comprise the provision of necessaries for divine service, so far as the church funds or voluntary subscriptions permit, the collecting the offertory of

the congregation, the keeping of order during the divine service, and the giving of offenders into custody; the assignment of seats to parishioners; the guardianship of the movable goods of the church; the preservation and repair of the church and churchyard, the fabric and the fixtures; and the presentment of offences against ecclesiastical law.

In the episcopal church of the United States churchwardens discharge much the same duties as those performed by the English officials; their duties, however, are regulated by canons of the diocese, not by canons general. In the United States, too, the usual practice is for the parishes to elect both the churchwardens.

See *Prideaux's Churchwarden's Guide* (16th ed., London, 1895); *Steer's Parish Law* (6th ed., London, 1899); *Blunt's Book of Church Law* (7th ed., London, 1894).

CHURCHYARD, THOMAS (c. 1520–1604), English author, was born at Shrewsbury about 1520, the son of a farmer. He received a good education, and, having speedily dissipated at court the money with which his father provided him, he entered the household of Henry Howard, earl of Surrey. There he remained for four years, learning something of the art-of poetry from his patron; some of the poems he contributed later (1557) to *Songes and Sonettes* may well date from this early period. In 1541 he began his career as a soldier of fortune, being, he said, “pressed into the service.” He fought his way through nearly every campaign in Scotland and the Low Countries for thirty years. He served under the emperor Charles V. in Flanders in 1542, returning to England after the peace of Crépy (1544). In the Scottish campaign of 1547 he was present at the barren victory of Pinkie, and in the next year was taken prisoner at Saint Monance, but aided by his persuasive tongue he escaped to the English garrison at Lauder, where he was once more besieged, only returning to England on the conclusion of peace in 1550. A broadside entitled *Davy Dycars Dreame*, a short and seemingly alliterative poem in the manner of Piers Plowman, brought him into trouble with the privy council, but he was dismissed with a reprimand. This tract was the starting-point of a controversy between Churchyard and a certain Thomas Camel. The whole of the “flyting” was reprinted in 1560 as *The Contention betwixte Churchyard and Camell*.

In 1550 he went to Ireland to serve the lord deputy, Sir Anthony St Leger, who had been sent to pacify the country. Here Churchyard enriched himself at the expense, it is to be feared, of the unhappy Irish; but in 1552 he was in England again, trying vainly to secure a fortune by marriage with a rich widow. After this failure he departed once more to the wars to the siege of Metz (1552), and “trailed a pike” in the emperor’s army, until he joined the forces under William, Lord Grey of Wilton, with whom he says he served eight years. Grey was in charge of the fortress of Gaines, which was besieged by the duke of Guise in 1558. Churchyard arranged the terms of surrender, and was sent with his chief to Paris as a prisoner. He was not released at the peace of Cateau Cambrésis for lack of money to pay his ransom, but he was finally set free on giving his bond for the amount, an engagement which he repudiated as soon as he was safely in England. He is not to be identified with the T. C. who wrote for the *Mirror for Magistrates* (ed. 1559), “How the Lord Mowbray . . . was banished . . . and after died miserably in exile,” which is the work of Thomas Chaloner, but “Shore’s Wife,” his most popular poem, appeared in the 1563 edition of the same work, and to that of 1587 he contributed the “Tragedie of Thomas Wolsey.” These are plain manly compositions in the seven-lined Chaucerian stanza. Repeated petitions to the queen for assistance produced at first fair words, and then no answer at all. He therefore returned to active service under Lord Grey, who was in command of an English army sent (1560) to help the Scottish rebels, and in 1564 he served in Ireland under Sir Henry Sidney. The religious disturbances in the Netherlands attracted him to Antwerp, where as the agent of William of Orange he allowed the insurgents to place him at their head, and was able to save much property from destruction. This action made him so hated by the mob that

he had to fly for his life in the disguise of a priest. In the next year he was sent by the earl of Oxford to serve definitely under the prince of Orange. After a year's service he obtained leave to return to England, and after many adventures and narrow escapes in a journey through hostile territory he embarked for Guernsey, and thence for England. His patron, Lord Oxford, disowned him, and the poet, whose health was failing, retired to Bath. He appears to have made a very unhappy marriage at this time, and returned to the Low Countries. Falling into the hands of the Spaniards he was recognized as having had a hand in the Antwerp disturbance, and was under sentence to be executed as a spy when he was saved by the intervention of a noble lady. This experience did not deter him from joining in the defence of Zutphen in 1572, but this was his last campaign, and the troubles of the remaining years of his life were chiefly domestic.

Churchyard was employed to devise a pageant for the queen's reception at Bristol in 1574, and again at Norwich in 1578. He had published in 1575 *The firste parte of Churchyardes Chippes*, the modest title which he gives to his works. No second part appeared, but there was a much enlarged edition in 1578. A passage in *Churchyardes Choise* (1579) gave offence to Elizabeth, and the author fled to Scotland, where he remained for three years. He was only restored to favour about 1584, and in 1593 he received a small pension from the queen. The affectionate esteem with which he was regarded by the younger Elizabethan writers is expressed by Thomas Nashe, who says (*Four Letters Confuted*) that Churchyard's aged muse might well be "grandmother to our grandiloquentest poets at this present." Francis Meres (*Palladis Tamia*, 1598) mentions him in conjunction with many great names among "the most passionate, among us, to bewail and bemoan the perplexities of love." Spenser, in "Colin Clout's come home again," calls him with a spice of raillery "old Palacemon" who "sung so long until quite hoarse he grew." His writings, with the exception of his contributions to the *Mirror for Magistrates*, are chiefly autobiographical in character or deal with the wars in which he had a share. They are very rare, and have never been completely reprinted. Churchyard lived right through Elizabeth's reign, and was buried in St Margaret's church, Westminster, on the 4th of April 1604.

The extant works of Churchyard, exclusive of commendatory and occasional verses, include:—*A lamentable and pitifull Description of the wofull warres in Flanders* (1578); *A general rehearsall of warres, called Churchyard's Choise* (1579), really a completion of the *Chippes*, and containing, like it, a number of detached pieces; *A light Bondel of livelie Discourses, called Churchyardes Charge* (1580); *The Worthines of Wales* (1587), a valuable antiquarian work in prose and verse, anticipating Michael Drayton; *Churchyard's Challenge* (1593); *A Musiicall Consort of Iccavenly harmonie . . . called Churchyard's Charitie* (1595); *A True Discourse Historiicall, of the succeeding Governours in the Netherlands* (1602).

The chief authority for Churchyard's biography is his own "Tragicall Discourse of the unhappy man's life" (*Churchyardes Chippes*). George Chalmers published (1817) a selection from his works relating to Scotland, for which he wrote a useful life. See also an edition of the *Chippes* (ed. J. P. Collier, 1870); of the *Worthines of Wales* (Spenser Soc. 1876), and a notice of Churchyard by H. W. Adnitt (*Transactions of the Shropshire Archaeological and Nat. Hist. Soc.*, reprinted separately 1884).

CHURCHYARD, a piece of consecrated ground attached to a parochial church, and used as a burial place. It is distinguished from a cemetery (*q.v.*), which is also a place of burial, but is separate and apart from any parochial church. A cemetery in England is either the property of a private company, incorporated by special act of parliament, or of a local authority, and is subject to the Cemeteries Clauses Act 1847, incorporated in the Public Health Acts. The practice of burying in churches or churchyards is said to have been connected with the custom of praying for the dead, and it would appear that the earlier practice was burying in the church itself. In England, about the year 750, spaces of ground adjoining the churches were enclosed and appropriated to the burial of those who had been entitled to attend divine service in those churches.

The right to burial in the parish churchyard is a common law right, controlled in many points by the provisions of the law

ecclesiastical. This double character is sufficient to explain the controversy which has so long raged round the subject of burials in England. Every man, according to the common law, has a right to be buried in his own churchyard, or, as it is sometimes put, in the churchyard of the parish where he dies. But the churchyard, as well as the church itself, is the freehold of the parson, who can in many respects deal with it as if it were a private estate. A statute of Edward I. (35, st. 2) speaks of the churchyard as the soil of the church, and the trees growing in the churchyard "as amongst the goods of the church, the which laymen have no authority to dispose," and prohibits "the parsons from cutting down such trees unless required for repairs." Notwithstanding the consecration of the church and churchyard, and the fact that they are the parson's freehold, a right of way may be claimed through them by prescription. The right to burial may be subject to the payment of a fee to the incumbent, if such has been the immemorial custom of the parish, but not otherwise. The spirit of the ancient canons regarded such burial fees as of a simoniacal complexion, inasmuch as the consecrated grounds were among the *res sacrae*—a feeling which Lord Stowell says disappeared after the Reformation. No person can be buried in a church without the consent of the incumbent, except when the owner of a manor-house prescribes for a burying-place within the church as belonging to the manor-house. In the case of *Rex v. Taylor* it was held that an information was grantable against a person for opposing the burial of a parishioner; but the court would not interpose as to the person's refusal to read the burial service because he never was baptized—that being matter for the ecclesiastical court. Strangers (or persons not dying in the parish) should not be buried, it appears, without the consent of the parishioners or churchwardens, "whose parochial right of burial is invaded thereby."

In Scotland the obligation of providing and maintaining the churchyard rests on the heritors of the parish. The guardianship of the churchyard belongs to the heritors and also to the kirk-session, either by delegation from the heritors, or in right of its ecclesiastical character. The right of burial appears to be strictly limited to parishioners, although an opinion has been expressed that any person dying in the parish has a right to be buried in the churchyard. The parishioners have no power of management. The presbytery may interfere to compel the heritors to provide due accommodation, but has no further jurisdiction. It is the duty of the heritors to allocate the churchyard. The Scottish law hesitates to attach the ordinary incidents of real property to the churchyard, while English law treats the ground as the parson's freehold. It would be difficult to say who in Scotland is the legal owner of the soil. Various opinions appear to prevail, e.g. as to grass growing on the surface and minerals found beneath. The difficulty as to religious services does not exist. On the other hand, the religious character of the ground is hostile to many of the legal rights recognized by the English law.

See also BURIAL AND BURIAL ACTS; CEMETERY.

CHURL (A.S. *ceorl*, cognate with the Ger. *Kerl* and with similar words in other Teutonic languages), one of the two main classes, *corl* and *ceorl*, into which in early Anglo-Saxon society the freemen appear to have been divided. In the course of time the status of the *ceorl* was probably reduced; but although his political power was never large, and in some directions his freedom was restricted, it hardly seems possible previous to the Norman Conquest to class him among the unfree. Some authorities, however, accept this view. At all events it is certain that the *ceorl* was frequently a holder of land, and a person of some position, and that he could attain the rank of a thegn. Except in Kent his wergild was fixed at two hundred shillings, or one-sixth of that of a thegn, and he is undoubtedly the *twyhynde* man of Anglo-Saxon law. In Kent his wergild was considerably higher, and his status probably also, but his position in this kingdom is a matter of controversy. After the Norman Conquest the *ceorls* were reduced to a condition of servitude, and the word translates the *villanus* of Domesday Book, although it also covers classes other than the *villani*. The form *ceorl* soon became *churl*, as in *Havelok the Dane* (ante 1300) and several times in Chaucer,

and subsequently *churl*. Taking a less technical sense than the ceorl of Anglo-Saxon law, *churl*, or *cherl* was used in general to mean a "man," and more particularly a "husband." In this sense it was employed about 1000 in a translation of the New Testament to render the word *ἀνήρ* (John iv. 16, 18). It was then employed to describe a "peasant," and gradually began to denote undesirable qualities. Hence comes the modern use of the word for a low-born or vulgar person, particularly one with an unpleasant, surly or miserly character.

See H. M. Chadwick, *Studies on Anglo-Saxon Institutions* (Cambridge, 1905); F. Seebohm, *Tribal Custom in Anglo-Saxon Law* (London, 1902).

CHURN (O. Eng. *cyrin*; found in various forms in most Teutonic languages, cf. Dutch *karn*; according to the *New English Dictionary* not connected with "quern," a mill), a vessel in which butter is made, by shaking or beating the cream so as to separate the fatty particles which form the butter from the serous parts or buttermilk. Early churns were upright, and in shape resembled the cans now used in the transport of milk, to which the name "churn" is also given. The upright churn was worked by hand by a wooden "plunger"; later came a box-shaped churn with a "splasher" revolving inside and turned by a handle. The modern type of churn, in large dairies worked by mechanical means, either revolves or swings itself, thus reverting to the most primitive method of butter-making, the shaking or swinging of the cream in a skin-bag or a gourd. (See DAIRY.)

CHUSAN, the principal island of a group situated off the eastern coast of China, in 30° N. 122° E., belonging to the province of Cheh-kiang. It lies N.W. and S.E., and has a circumference of 51 m., the extreme length being 20, the extreme breadth 10, and the minimum breadth 6 m. The island is beautifully diversified with hill and dale, and well watered with numerous small streams, of which the most considerable is the Tungkiang, falling into the harbour of Tinghai. Most of the surface is capable of cultivation, and nineteen-twentieths of the inhabitants are engaged in agriculture. Wherever it is possible to rear rice every other product is neglected; yet the quantity produced is not sufficient for the wants of the inhabitants. Millet, wheat, sweet potatoes, yams and tares are also grown. The tea plant is found almost everywhere, and the cotton plant is largely cultivated near the sea. The capital, Tinghai, stands about half a mile from the southern shore, and is surrounded by a wall nearly 3 m. in circuit. The ditch outside the wall is interrupted on the N.W. side by a spur from a neighbouring hill, which projects into the town, and forms an easy access to an attacking force. The town is traversed by canals, and the harbour, which has from 4 to 8 fathoms water, is landlocked by several islands. Temple (or Joss-house) Hill, which commands the town and harbour close to the beach, is 122 ft. high. The population of the entire island is estimated at 250,000, of which the capital contains about 40,000. Chusan has but few manufactures; the chief are coarse cotton stuffs and agricultural implements. There are salt works on the coast; and the fisheries employ a number of the inhabitants. In Tinghai a considerable business is carried on in carving and varnishing, and its silver wares are in high repute. The principal exports are fish, coarse black tea, cotton, vegetable tallow, sweet potatoes, and some wheat. Chusan was occupied by the Japanese during the Ming dynasty, and served as an important commercial entrepôt. It was taken by the British forces in 1840 and 1841, and retained till 1846 as a guarantee for the fulfilment of the stipulations of the treaty. It was also occupied by the British in 1860.

CHUTE (Fr. for "fall," of water or the like; pronounced as "shoot," with which in meaning it is identical), a channel or trough, artificial or natural, down which objects such as timber, coal or grain may slide from a higher to a lower level. The word is also used of a channel cut in a dam or a river for the passage of floating timber, and in Louisiana and on the Mississippi of a channel at the side of a river, or narrow way between an island and the shore. The "Water-Chute" or water tobogganing, is a

Canadian pastime, which has been popular in London and elsewhere. A steep wooden slope terminates in a shallow lake; down this run flat-bottomed boats which rapidly increase their velocity until at the end of the "chute" they dash into the water.

CHUTNEY, or **CHUTNEE** (Hindustani *chatni*), a relish or seasoning of Indian origin, used as a condiment. It is prepared from sweet fruits such as mangoes, raisins, &c., with acid flavouring from tamarinds, lemons, limes and sour herbs, and with a hot seasoning of chillies, cayenne pepper and spices.

CHUVASHES, or **TCHUVASHES**, a tribe found in eastern Russia. They form about one-fourth of the population of the government of Kazan, and live in scattered communities throughout the governments of Simbirsk, Samara, Saratov, Orenburg and Perm. They have been identified with the Burtasses of the Arab geographers, and many authorities think they are the descendants of the ancient Bolgars. In general they physically resemble the Finns, being round-headed, flat-featured and light-eyed, but they have been affected by long association with the Tatar element. In dress they are thoroughly Russianized, and they are nominally Christians, though they cling to many of the Old Shamanistic practices. They number some half a million. Their language belongs to the Tatar or Turkish group, but has been strongly influenced by the Finno-Ugrian idioms spoken round it.

See Schott, *De Lingua Tschuwasschorum* (Berlin, 1841).

CIALDINI, ENRICO (1811–1892), Italian soldier, politician and diplomatist, was born at Castelvetro, in Modena, on the 10th of August 1811. In 1831 he took part in the insurrection at Modena, fleeing afterwards to Paris, whence he proceeded to Spain to fight against the Carlists. Returning to Italy in 1848, he commanded a regiment at the battle of Novara. In 1859 he organized the Alpine Brigade, fought at Palestro at the head of the 4th Division, and in the following year invaded the Marches, won the battle of Castelfidardo, took Ancona, and subsequently directed the siege of Gaeta. For these services he was created duke of Gaeta by the king, and was assigned a pension of 10,000 lire by parliament. In 1861 his intervention envenomed the Cavour-Garibaldi dispute, royal mediation alone preventing a duel between him and Garibaldi. Placed in command of the troops sent to oppose the Garibaldian expedition of 1862, he defeated Garibaldi at Aspromonte. Between 1862 and 1866 he held the position of lieutenant-royal at Naples, and in 1864 was created senator. On the outbreak of the war of 1866 he resumed command of an army corps, but dissensions between him and La Marmora prejudiced the issue of the campaign and contributed to the defeat of Custoza. After the war he refused the command of the General Staff, which he wished to render independent of the war office. In 1867 he attempted unsuccessfully to form a cabinet sufficiently strong to prevent the threatened Garibaldian incursion into the papal states, and two years later failed in a similar attempt, through disagreement with Lanza concerning the army estimates. On the 3rd of August 1870 he pleaded in favour of Italian intervention in aid of France, a circumstance which enhanced his influence when in July 1876 he replaced Nigra as ambassador to the French Republic. This position he held until 1882, when he resigned on account of the publication by Mancini of a despatch in which he had complained of arrogant treatment by M. Waddington. He died at Leghorn, on the 8th of September 1892. (H. W. S.)

CIBBER (or **CIBERT**), **CAIUS GABRIEL** (1630–1700), Danish sculptor, was born at Flensburg. He was the son of the king's cabinetmaker, and was sent to Rome at the royal charge while yet a youth. He came to England during the Protectorate, or during the first years of the Restoration. Besides the famous statues of Melancholy and Raving Madness ("great Cibber's brazen brainless brothers"), now at South Kensington, Cibber produced the bas-reliefs round the monument on Fish Street Hill. The several kings of England and the Sir Thomas Gresham executed by him for the Royal Exchange were destroyed with the building itself in 1838. Cibber was long employed by the fourth earl of Devonshire, and many fine specimens of his work are to be seen at Chatsworth. Under that nobleman he took up arms in 1688 for William of Orange, and was appointed in return carver to the

king's closet. He died rich, and, according to Horace Walpole, built the Danish church in London, where he lies buried beside his second wife, to whom he erected a monument. She was a Miss Colley of Glaiston, grand-daughter of Sir Anthony Colley, and the mother of his son Colley Cibber.

CIBBER, COLLEY (1671-1757), English actor and dramatist, was born in London on the 6th of November 1671, the eldest son of Caius Gabriel Cibber, the sculptor. Sent in 1682 to the free school at Grantham, Lincolnshire, the boy distinguished himself by an aptitude for writing verse. He produced an "Oration" on the death of Charles II.—whom he had seen feeding his ducks in St James's Park,—and an "Ode" on the accession of James II. He was removed from school in 1687 on the chance of election to Winchester College. His father, however, had not then presented that institution with his statue of William of Wykeham, and the son was rejected, although through his mother he claimed to be of "founder's kin." The boy went to London, and indulged his passion for the theatre. He was invited to Chatsworth, the seat of William Cavendish, earl (afterwards duke) of Devonshire, for whom his father was then executing commissions, and he was on his way when the news of the landing of William of Orange was received; father and son met at Nottingham, and Colley Cibber was taken into Devonshire's company of volunteers. He served in the bloodless campaign that resulted in the coronation of the Prince of Orange, and on its conclusion presented a Latin petition to the earl imploring his interest. The earl did nothing for him, however, and he enrolled himself (1690) as an actor in Betterton's company at Drury Lane.

After playing "full three-quarters of a year" without salary, as was then the custom of all apprentice actors, he was paid ten shillings a week. His rendering of the little part of the chaplain in Otway's *Orphan* procured him a rise of five shillings; and a subsequent impersonation (1694) on an emergency, and at the author's request, of Lord Touchwood in *The Double Dealer*, advanced him, on Congreve's recommendation, to a pound a week. On this, supplemented by an allowance of £20 a year from his father, he contrived to live with his wife and family—he had married in 1693—and to produce a play, *Love's Last Shift, or the Fool in Fashion* (1696). Of this comedy Congreve said that it had "a great many things that were like wit in it"; and Vanbrugh honoured it by writing his *Relapse* as a sequel. Cibber played the part of Sir Novelty Fashion, and his performance as Lord Foppington, the same character renamed, in Vanbrugh's piece, established his reputation as an actor. In 1698 he was assailed, with other dramatists, by Jeremy Collier in the *Short View*. In November 1702 he produced, at Drury Lane, *She Wou'd and She Wou'd Not; or the Kind Impostor*, one of his best comedies; and in 1704, for himself and Mrs Oldfield, *The Careless Husband*, which Horace Walpole classed, with Cibber's *Apology*, as "worthy of immortality." In 1706 Cibber left Drury Lane for the Haymarket, but when the two companies united two years later he rejoined his old theatre through the influence of his friend Colonel Brett, a shareholder. Brett made over his share to Wilks, Estcourt and Cibber. Complaints against the management of Christopher Rich led, in 1709, to the closing of the theatre by order of the crown, and William Collier obtained the patent. After a series of intrigues Collier was bought out by Wilks, Doggett and Cibber, under whose management Drury Lane became more prosperous than it ever had been. In 1715 a new patent was granted to Sir Richard Steele, and Barton Booth was also added to the management. In 1717 Cibber produced the *Nonjuror*, an adaptation from Molière's *Tartuffe*; the play, for which Nicholas Rowe wrote an abusive prologue, ran eighteen nights, and the author received from George I., to whom it was dedicated, a present of two hundred guineas. *Tartuffe* became an English Catholic priest who incited rebellion, and there is little doubt that the Whig principles expressed in the *Nonjuror* led to Cibber's appointment as poet laureate (1730). It also provoked the animosity of the Jacobite and Catholic factions, and was possibly one of the causes of Pope's hostility to Cibber. Numerous "keys" to the *Nonjuror* appeared in 1718. In 1720 Drury Lane was closed for three days

by order of the duke of Newcastle, ostensibly on account of the refusal of the patentees to submit to the authority of the lord chamberlain, but really (it is asserted) because of a quarrel between Newcastle and Steele, in which the former demanded Cibber's resignation. In 1726 Cibber pleaded the cause of the patentees against the estate of Sir Richard Steele before Sir Joseph Jekyll, master of the rolls, and won his case. In 1730 Mrs Oldfield died, and her loss was followed in 1732 by that of Wilks; Cibber now sold his share in the theatre, appearing rarely on the stage thereafter. In 1740 he published *An Apology for the Life of Colley Cibber, Comedian . . . with an Historical View of the Stage during his Own Time*. "There are few," wrote Goldsmith, "who do not prefer a page of Montaigne or Colley Cibber, who candidly tell us what they thought of the world, and the world thought of them, to the more stately memoirs and transactions of Europe." But beside the personal interest, this book contains criticisms on acting of enduring value, and gives the best account there is of Cibber's contemporaries on the London stage. Samuel Johnson, who was no friend of Cibber, gave it grudging praise (see Boswell's *Life of Johnson*, ed. Birkbeck Hill, vol. iii. p. 72).

In 1742 Cibber was substituted for Theobald as the hero of Pope's *Dunciad*. Cibber had introduced some gag into the *Rehearsal*, in which he played the part of Bayes, referring to the ill-starred farce of *Three Hours after Marriage* (1717). This play was nominally by Gay, but Pope and Arbuthnot were known to have had a hand in it. Cibber refused to discontinue the offensive passage, and Pope revenged himself in sarcastic allusions in his printed correspondence, in the *Epistle to Dr Arbuthnot* and in the *Dunciad*. To these, Cibber replied with *A Letter from Mr Cibber to Mr Pope, inquiring into the motives that might induce him in his satirical works to be so frequently fond of Mr Cibber's name* (1742). Cibber scored with an "idle story of Pope's behaviour in a tavern" inserted in this letter, and gives an account of the original dispute over the *Rehearsal*. By the substitution of Cibber for Theobald as hero of the *Dunciad*, much of the satire lost its point. Cibber's faults certainly did not include dullness. A new edition contained a prefatory discourse, probably the work of Warburton, entitled "Ricardus Aristarchus, or the Hero of the Poem," in which Cibber is made to look ridiculous from his own *Apology*. Cibber replied in 1744 with *Another Occasional Letter . . .*, and altogether he had the best of the argument. When he was seventy-four years old he made his last appearance on the stage as Pandulph in his own *Papal Tyranny in the Reign of King John* (Covent Garden, 15th of February 1745), a miserable paraphrase of Shakespeare's play. He died on the 11th of December 1757.

Cibber's reputation has suffered unduly from the depreciation of Pope and Johnson. "I could not bear such nonsense," said Johnson of one of Cibber's odes, "and I would not let him read it to the end." Fielding attacked Cibber's style and language more than once in *Joseph Andrews* and elsewhere. Nevertheless, Cibber possessed wit, unusual good sense and tact; and in the *Apology* he showed himself the most delicate and subtle critic of acting of his time. He was frequently accused of plagiarism, and did not scruple to make use of old plays, but he is said to have been ashamed of his Shakespearian adaptations, one of which, however, *Richard III.* (Drury Lane, 1700), kept its place as the acting version until 1821. Cibber is rebuked for his mutilation of Shakespeare by Fielding in the *Historical Register for 1736*, where he figures as Ground Ivy.

If Cibber had not as much wit as his predecessors, he displayed in his best plays abundant animation and spirit, free from the extreme coarseness of many of his contemporaries, and a thorough knowledge of the requirements of the stage. His most successful comedies kept their place in the acting repertory for a long time. He was an excellent actor, especially in the rôle of the fashionable coxcomb. Horace Walpole said that as Bayes in *The Rehearsal* he made the part what it was intended to be, the burlesque of a great poet, whereas David Garrick degraded him to a "garretteer."

The *Apology* was edited in 1822 by E. Bellchambers and in 1889

by R. W. Lowe, who printed with it other valuable theatrical books and pamphlets. It is also included in Hunt and Clarke's *Autobiographies* (1826, &c.). Cibber's *Dramatic Works* were published in 1760, with an account of the life and writings of the author, and again in 1777. Besides the plays already mentioned, he wrote *Woman's Wit, or the Lady in Fashion* (1697), which was altered later (1707) into *The Schoolboy, or the Comical Rivals*; *Xerxes* (1699), a tragedy acted only once; *The Provoked Husband* (acted 1728), completed from Vanbrugh's unfinished *Journey to London*; *The Rival Queens, with the Humours of Alexander the Great* (acted 1710), a comical tragedy; *Damon and Phyllida* (acted 1729), a ballad opera; and adaptations from Beaumont and Fletcher, Dryden, Molière and Corneille. A bibliography of the numerous skits on Cibber is to be found in Lowe's *Bibliographical Account of English Theatrical Literature*.

Colley Cibber's son, THEOPHILUS CIBBER (1703-1758), also an actor and playwright, was born on the 26th of November 1703. In 1734 he was acting-manager at the Haymarket, and he subsequently played at Drury Lane, Lincoln's Inn Fields and Covent Garden. His best impersonation was as Pistol, but he also distinguished himself in some of the fine-gentleman parts affected by his father. He was one of the ringleaders in the intrigues against John Highmore, who had bought a share in the patent of Drury Lane from Colley Cibber. Theophilus Cibber, with a number of other actors, seceded from Drury Lane, and in thus depreciating the value of the patent, for which his father had received a considerable sum, acted with doubtful honesty. He contemplated the publication of an autobiography, but was effectually dissuaded by the appearance (1740) of a scathing account of his career by an unknown author, entitled *An Apology for the Life of Mr T. . . . C. . . . supposed to be written by himself*. In 1753 he began *The Lives and Characters of the most Eminent Actors and Actresses of Great Britain and Ireland*, but he went no further than the life of Barton Booth. He wrote some plays of no great merit. In 1753 appeared *An Account of the Lives of the Poets of Great Britain and Ireland*, with the name of "Mr Cibber" on the title page. The five volumes of *Lives* are chiefly based on the earlier works of Gerard Langbaine and Giles Jacob, and the MS. collections of Thomas Coxeter (1689-1747). The book is said to have been largely written by Robert Shiels, Dr Johnson's amanuensis. Theophilus Cibber perished by shipwreck on his way to Dublin to play at the Theatre Royal.

SUSANNAH MARIA CIBBER (1714-1766), wife of Theophilus, was an actress of distinction. She was the daughter of a Covent Garden upholsterer, and sister of Dr Arne (1710-1778) the composer. Mrs Cibber had a beautiful voice and began her career in opera. She was the original Galatea in Handel's *Acis and Galatea*, and the contralto arias in the *Messiah* are said to have been written for her. She played Zarah in Aaron Hill's version of Voltaire's *Zaire* in 1736, and it was as a tragic actress, not as a singer, that her greatest triumphs were won. From Colley Cibber she learned a sing-song method of declamation. Her mannerisms, however, did not obscure her real genius, and she freed herself from them entirely when she began to act with Garrick, with whom she was associated at Drury Lane from 1753. She died on the 30th of January 1766. She married Theophilus Cibber in 1734, but lived with him but a short time. Appreciations of Mrs Cibber's fine acting are to be found in many contemporary writers, one of the most discriminating being in the *Rosciad* of Charles Churchill.

Colley Cibber's youngest daughter, CHARLOTTE, married Richard Charke, a violinist, from whom she was soon separated. She began as an understudy to actresses in leading parts, but quarrelled with her manager, Charles Fleetwood, on whom she wrote a one-act skit, *The Art of Management* (1735). She also wrote two comedies and two novels of small merit, and an untrustworthy, but amusing *Narrative of Life of . . . Charlotte Charke, . . . by herself* (1755), reprinted in Hunt and Clarke's *Autobiographies* (1822).

CIBORIUM, a name in classical Latin for a drinking-vessel. It is the latinized form of the Gr. *κίβωριον*, the cup-shaped seed-vessel of the Egyptian water-lily, the seeds or nuts of which were known as "Egyptian beans." In the early Christian

Church the *ciborium* was a canopy over the altar (*q.v.*), supported on columns, and from it hung the receptacle in which was reserved the consecrated wafer of the Eucharist. The use of the word has probably been much influenced by the early false connexion with *cibus*, food, cf. Agatio, bishop of Pisa (quoted in Du Cange, *Gloss. s.v.*), "Ciborium vas esse ad ferendos cibos." In the Eastern Church the columns rested on the altar itself, in the Western they reached the ground. The name was early transferred from the canopy to the vessel containing the reserved sacrament, and in the Western Church the canopy was known as a "baldaquin," Ital. *baldaccino*, from *Baldacco*, the Italian name of Bagdad, and hence applied to a rich kind of embroidered tapestry made there and much used for canopies, &c. At the present day it is usual in the Roman Church to use the term "pyx" (*πίξίς*, properly a vessel made of boxwood) for the receptacle for the reserved sacrament used in administering the *viaticum* to the sick or dying. Medieval pyxes and ciboria are often beautiful examples of the goldsmith's, enameller's and metal-worker's craft. They take most usually the shape of a covered chalice or of a cylindrical box with conical or cylindrical cover surmounted by a cross. An exquisite ciborium fetched £6000 at the sale of the Jerdone Braikenridge collection at Christie's in 1908. It is supposed to have come from Malmesbury Abbey, and is probably of 13th-century English make. It is of copper-gilt and ornamented with champlevé enamels, apple and chrysoprase green, scarlet, mauve and white, turquoise and lapis lazuli, the flesh tints being of a pale jasper. Various subjects from the Old and New Testament, such as the sacrifice of Abel, the brazen serpent, the nativity, crucifixion and resurrection are represented on circular medallions on the outside. It is illustrated in colours in the catalogue of the exhibition of the Burlington Fine Arts Club, 1897.

CIBRARIO, LUIGI, COUNT (1802-1870), Italian statesman and historian, descended from a noble but impoverished Piedmontese family, was born in Ussegia on the 23rd of February 1802. He won a scholarship at the age of sixteen, and was teaching literature at eighteen. His verses to King Charles Albert, then prince of Carignano, on the birth of his son Victor Emmanuel, attracted the prince's attention and proved the beginning of a long intimacy. He entered the Sardinian civil service, and in 1824 was appointed lecturer on canon and civil law. His chief interest was the study of ancient documents, and he was sent to search the archives of Switzerland, France and Germany for charters relating to the history of Savoy. During the war of 1848, after the expulsion of the Austrians from Venice, Cibrario was sent to that city with Colli to negotiate its union with Piedmont. But the proposal fell through when the news of the armistice between King Charles Albert and Austria arrived, and the two delegates were made the objects of a hostile demonstration. In October 1848 Cibrario was made senator, and after the battle of Novara (March 1849), when Charles Albert abdicated and retired to a monastery near Oporto, Cibrario and Count Giacinto di Collegno were sent as representatives of the senate to express the sympathy of that body with the fallen king. He reached Oporto on the 28th of May, and after staying there for a month returned to Turin, which he reached just before the news of Charles Albert's death. In May 1852 he became minister of finance in the reconstructed d'Azeglio cabinet, and later minister of education in that of Cavour. In the same year he was appointed secretary to the order of SS. Maurizio and Lazzaro. It was he who in 1853 dictated the vigorous memorandum of protest against the confiscation by Austria of the property of Lombard exiles who had been naturalized in Piedmont. He strongly supported Cavour's Crimean policy (1855), and when General La Marmora departed in command of the expeditionary force and Cavour took the war office, Cibrario was made minister for foreign affairs. He conducted the business of the department with great skill, and ably seconded Cavour in bringing about the admission of Piedmont to the congress of Paris on an equal footing with the great powers. On retiring from the foreign office Cibrario was created count. In 1860 he acted as mediator between Victor Emmanuel's

government and the republic of San Marino, and arranged a treaty by which the latter's liberties were guaranteed. After the war of 1866 by which Austria lost Venetia, Cibrario negotiated with that government for the restitution of state papers and art treasures removed by it from Lombardy and Venetia to Vienna. He died in October 1870, near Salò, on the lake of Garda.

His most important work was his *Economia politica del medio evo* (Turin, 1839), which enjoyed great popularity at the time, but is now of little value. His *Schiavitù e servaggio* (Milan, 1868-1869) gave an account of the development and abolition of slavery and serfdom. Among his historical writings the following deserve mention:—*Delle artiglierie dal 1300 al 1700* (Turin, 1847); *Origini . . . della monarchia di Savoia* (Turin, 1854); *Degli ordini cavallereschi* (Turin, 1846); *Degli ordini religiosi* (Turin, 1845); and the *Memorie Segrete* of Charles Albert, written by order of Victor Emmanuel but afterwards withdrawn. Cibrario was a good example of the loyal, industrious, honest Piedmontese aristocrat of the old school.

His biography has been written by F. Odorici, *Il Conte L. Cibrario* (Florence, 1872). (L. V.)*

CICADA (*Cicadidae*), insects of the homopterous division of the Hemiptera, generally of large size, with the femora of the anterior legs toothed below, two pairs of large clear wings, and prominent compound eyes. Cicadas are chiefly remarkable for the shrill song of the males, which in some cases may be heard in concert at a distance of a quarter of a mile or more. The vocal organs, of which there is a pair in the thorax, protected by an opercular plate, are quite unlike the sounding organs of other insects. Each consists in essence of a tightly stretched membrane or drum which is thrown into a state of rapid vibration by a powerful muscle attached to its inner surface and passing thence downwards to the floor of the thoracic cavity. Although no auditory organs have been found in the females, the song of the males is believed to serve as a sexual call. Cicadas are also noteworthy for their longevity, which so far as is known surpasses that of all other insects. By means of a saw-like ovipositor the female lays her eggs in the branches of trees. Upon hatching, the young, which differ from the adult in possessing long antennae and a pair of powerful fossorial anterior legs, fall to the ground, burrow below the surface, and spend a prolonged subterranean larval existence feeding upon the roots of vegetation. After many years the larva is transformed into the pupa or nymph, which is distinguishable principally by the shortness of its antennae and the presence of wing pads. After a brief existence the pupa emerges from the ground, and, holding on to a plant stem by means of its powerful front legs, sets free the perfect insect through a slit along the median dorsal line of the thorax. In some cases the pupa upon emerging constructs a chimney of soil, the use of which is not known. In one of the best-known species, *Cicada septemdecim*, from North America, the life-cycle is said to extend over seventeen years. Cicadas are particularly abundant in the tropics, where the largest forms are found. They also occur in temperate countries, and were well known to the ancient Greeks and Romans. One species only is found in England, where it is restricted to the southern counties but is an insect not commonly met with.

CICELY, *Myrrhis odorata* (natural order Umbelliferae), a perennial herb with a leafy hollow stem, 2 to 3 ft. high, much divided leaves, whitish beneath, a large sheathing base, and terminal umbels of small white flowers, the outer ones only of which are fertile. The fruit is dark brown, long ($\frac{3}{4}$ to 1 in.), narrow and beaked. The plant is a native of central and southern Europe, and is found in parts of England and Scotland in pastures, usually near houses. It has aromatic and stimulant properties and was formerly used as a pot-herb.

CICERO, the name of two families of ancient Rome. It may perhaps be derived from *cicer* (pulse), in which case it would be analogous to such names as *Lentulus*, *Tubero*, *Piso*. Of one family, of the plebeian Claudian gens, only a single member, Gaius Claudius Cicero, tribune in 454 B.C., is known. The other family was a branch of the Tullii, settled from an ancient period at Arpinum. This family, four of whose members are noticed

specially below, did not achieve more than municipal eminence until the time of M. Tullius Cicero, the great orator.

1. **MARCUS TULLIUS CICERO** (106-43 B.C.), Roman orator and politician, was born at Arpinum on the 3rd of January 106 B.C. His mother, Helvia, is said to have been of good family. His father was by some said to have been descended from Attius Tullius, the Volscian host of Coriolanus, while spiteful persons declared him to have been a fuller; in any case he was a Roman knight with property at Arpinum and a house in Rome. His health was weak, and he generally lived at Arpinum, where he devoted himself to literary pursuits. Cicero spent his boyhood partly in his native town and partly at Rome. The poet Archias, he says, first inspired him with the love of literature. He was much impressed by the teaching of Phaedrus, the Epicurean, at a period before he assumed the *toga virilis*; he studied dialectic under Diodotus the Stoic, and in 88 B.C. attended the lectures of Philo, the head of the Academic school, whose devoted pupil he became. He studied rhetoric under Molo (Molon) of Rhodes, and law under the guidance of Q. Mucius Scaevola, the augur and jurisconsult. After the death of the augur, he transferred himself to the care of Q. Mucius Scaevola, the *pontifex maximus*, a still more famous jurisconsult, nephew of the augur. His literary education at this period consisted largely of verse-writing and making translations from Greek authors. We hear of an early poem named *Pontius Glaucus* the subject of which is uncertain, and of translations of Xenophon's *Oeconomica* and the *Phenomena* of Aratus. Considerable fragments of the latter work are still extant. To this period also belongs his *de Inventione rhetorica*, of which he afterwards spoke lightly (*de Orat.* i. 5), but which enjoyed a great vogue in the middle ages. Cicero also, according to Roman practice, received military training. At the age of seventeen he served in the social war successively under Pompeius Strabo and Sulla (89 B.C.). In the war between Marius and Sulla his sympathies were with Sulla, but he did not take up arms (*Sext. Rosc.* 136, 142).

His forensic life begins in 81 B.C., at the age of twenty-five. A speech delivered in this year, *pro Quinctio*, is still extant; it is concerned with a technical point of law and has little literary merit. In the following year he made his celebrated defence of Sextus Roscius on a charge of parricide. He subsequently defended a woman of Arretium, whose freedom was impugned on the ground that Sulla had confiscated the territory of that town. Cicero then left Rome on account of his health, and travelled for two years in the East. He studied philosophy at Athens under various teachers, notably Antiochus of Ascalon, founder of the Old Academy, a combination of Stoicism, Platonism and Peripateticism. In Asia he attended the courses of Xenocles, Dionysius and Menippus, and in Rhodes those of Posidonius, the famous Stoic. In Rhodes also he studied rhetoric once more under Molo, to whom he ascribes a decisive influence upon the development of his literary style. He had previously affected the florid, or Asiatic, style of oratory then current in Rome. The chief faults of this were excess of ornament, antithesis, alliteration and assonance, monotony of rhythm, and the insertion of words purely for rhythmical effect. Molo, he says, rebuked his youthful extravagance and he came back "a changed man."¹

He returned to Rome in 77 B.C., and appears to have married at this time Terentia, a rich woman with a domineering temper, to whom many of his subsequent embarrassments were due.² He engaged at once in forensic and political life. He was quaestor in 75, and was sent to Lilybaeum to supervise the corn supply. His connexion with Sicily led him to come forward in 70 B.C., when curule-aedile elect, to prosecute Gaius Verres, who had oppressed the island for three years. Cicero seldom prosecuted, but it was the custom at Rome for a rising politician to

¹ *Brutus*, § 316 " (Molon) dedit operam . . . ut nimis redundantis nos et supra fluentis juvenili quadam dicendi impunitate et licentia reprimeret et quasi extra ripas diffluentis coërceret."

² According to Plutarch she urged her husband to take vigorous action against Catiline, who had compromised her half-sister Fabia, a vestal virgin; also to give evidence against Clodius, being jealous of his sister Clodia.

win his spurs by attacking a notable offender (*pro Caelio*, 73). In the following year he defended Marcus (or Manius) Fonteius on a charge of extortion in Gaul, using various arguments which might equally well have been advanced on behalf of Verres himself.

In 68 B.C. his letters begin, from which (and especially those to T. Pomponius Atticus, his "second self") we obtain wholly unique knowledge of Roman life and history. In 66 B.C. he was praetor, and was called upon to hear cases of extortion. In the same year he spoke on behalf of the proposal of Gaius Manilius to transfer the command against Mithradates from Lucullus to Pompey (*de Lege Manilia*), and delivered his clever but disingenuous defence of Aulus Cluentius (*pro Cluentio*). At this time he was a prospective candidate for the consulship, and was obliged by the hostility of the nobles towards "new men" to look for help wherever it was to be found. In 65 B.C. he even thought of defending Catiline on a charge of extortion, and delivered two brilliant speeches on behalf of Gaius Cornelius, tribune in 67 B.C., a leader of the democratic party. In 64 B.C. he lost his father and his son Marcus was born. The optimates finally decided to support him for the consulship in order to keep out Catiline, and he eagerly embraced the "good cause," his affection for which from this time onward never varied, though his actions were not always consistent.

The public career of Cicero henceforth is largely covered by the general article on ROME: *History*, II. "The Republic," *ad fin.* The year of his consulship (63) was one of amazing activity, both administrative and oratorical. Besides the three speeches against Publius Rullus and the four against Catiline, he delivered a number of others, among which that on behalf of Gaius Rabirius is especially notable. The charge was that Rabirius (*q.v.*) had killed Saturninus in 100 B.C., and by bringing it the democrats challenged the right of the senate to declare a man a public enemy. Cicero, therefore, was fully aware of the danger which would threaten himself from his execution of the Catilinarian conspirators. He trusted, however, to receive the support of the nobles. In this he was disappointed. They never forgot that he was a "new man," and were jealous of the great house upon the Palatine which he acquired at this time. Caesar had made every possible effort to conciliate Cicero,¹ but, when all overtures failed, allowed Publius Clodius to attack him. Cicero found himself deserted, and on the advice of Cato went into exile to avoid bloodshed. He left Rome at the end of March 58, and arrived on the 23rd of May at Thessalonica, where he remained in the deepest dejection until the end of November, when he went to Dyrrhachium (Durazzo) awaiting his recall. He left for Italy on the 4th of August 57, and on arriving at Brundisium (Brindisi) found that he had been recalled by a law passed by the *comitia* on the very day of his departure. On his arrival at Rome he was received with enthusiasm by all classes, but did not find the nobles at all eager to give him compensation for the loss of his house and villas, which had been destroyed by Clodius. He was soon encouraged by the growing coolness between Pompey and Caesar to attack the acts of Caesar during his consulship, and after his successful defence of Publius Sestius on the 10th of March he proposed on the 5th of April that the senate should on the 15th of May discuss Caesar's distribution of the Campanian land. This brought about the conference of Luca (Lucca). Cicero was again deserted by his supporters and threatened with fresh exile. He was forced to publish a "recantation," probably the speech *de Provinciis Consularibus*, and in a private letter says frankly, "I know that I have been a regular ass." His conduct for the next three years teems with inconsistencies which we may deplore but cannot pass over. He was obliged to defend in 54 Publius Vatinius, whom he had fiercely attacked during the trial of Sestius; also Aulus Gabinius, one of the consuls to whom his exile was due; and Rabirius Postumus, an agent of Gabinius. On the other hand, he made a violent speech in the senate in 55 against Lucius Piso, the col-

¹ Caesar, at one time, offered him a place on the coalition, which on his refusal became a triumvirate (*Att.* ii. 3. 3; *Prov. Cons.* 41), and afterwards a post on his commission for the division of the Campanian land, or a *legatio libera*.

league of Gabinius in 58. We know from his letters that he accepted financial aid from Caesar, but that he repaid the loan before the outbreak of the civil war.² There is no doubt that he was easily deceived. He was always an optimist, and thought that he was bringing good influence to bear upon Caesar as afterwards upon Octavian. His actions, however, when Caesar's projects became manifest, sufficiently vindicated his honesty. During these unhappy years he took refuge in literature. The *de Oratore* was written in 55 B.C., the *de Republica* in 54, and the *de Legibus* at any rate begun in 52. The latter year is famous for the murder of Clodius by T. Annius Milo on the Appian Way (on the 18th of January), which brought about the appointment of Pompey as sole consul and the passing of the special laws dealing with rioting and bribery. Cicero took an active part in the trials which followed, both as a defender of Milo and his adherents and as a prosecutor of the opposite faction. At the close of the year, greatly to his annoyance, he was sent to govern Cilicia under the provisions of Pompey's law (see POMPEY and ROME: *History*). His reluctance to leave Rome, already shown by his refusal to take a province, after his praetorship and consulship, was increased by the inclination of his daughter Tullia, then a widow, to marry again.³ During his absence she married the profligate spendthrift, P. Cornelius Dolabella.

The province of Cilicia was a large one. It included, in addition to Cilicia proper, Isauria, Lycaonia, Pisidia, Pamphylia and Cyprus, as well as a protectorate over the client kingdoms of Cappadocia and Galatia. There was also danger of a Parthian inroad. Cicero's legate was his brother Quintus Cicero (below), an experienced soldier who had gained great distinction under Caesar in Gaul. The fears of Parthian invasion were not realized, but Cicero, after suppressing a revolt in Cappadocia, undertook military operations against the hill-tribes of the Amanus and captured the town of Pindenissus after a siege of forty-six days. A *supplicatio* in his honour was voted by the senate. The early months of 50 were occupied by the administration of justice, chiefly at Laodicea, and by various attempts to alleviate the distress in the province caused by the exactions of his predecessor, Appius Claudius. He had to withstand pressure from influential persons (e.g. M. Brutus, who had business interests in his province), and refused to provide his friends with wild beasts for their games in Rome. Leaving his province on the earliest opportunity, he reached Brundisium on the 24th of November, and found civil war inevitable. He went to Rome on the 4th of January, but did not enter the city, since he aspired to a triumph for his successes.⁴ After the outbreak of war he was placed by Pompey in charge of the Campanian coast. After much irresolution he refused Caesar's invitations and resolved to join Pompey's forces in Greece. He was shocked by the ferocious language of his party, and himself gave offence by his bitter jests (*Plut. Cic.* 38). Through illness he was not present at the battle of Pharsalus, but afterwards was offered the command by Cato the Younger at Corcyra, and was threatened with death by the young Cn. Pompeius when he refused to accept it. Thinking it useless to continue the struggle, he sailed to Brundisium, where he remained until the 12th of August 47, when, after receiving a kind letter from Caesar, he went to Rome. Under Caesar's dictatorship Cicero abstained from politics. His voice was raised on three occasions only: once in the senate in 46 to praise Caesar's clemency to M. Claudius Marcellus (*pro Marcello*), to plead in the same year before Caesar for Quintus Ligarius, and in 45 on behalf of Deiotarus, tetrarch of Galatia, also before Caesar. He suffered greatly from family troubles at this period. In 46, his patience giving way, he divorced Terentia, and married his young and wealthy ward Publilia. Then came the greatest grief

² *Att.* vii. 8. 5 "est enim ἀμορφον ἀντιπολιτευομένου χρωφειλέτην esse."

³ She was married in 63 B.C. to C. Calpurnius Piso Frugi, whom Cicero found a model son-in-law. He appears to have died before 56, since in that year Tullia was betrothed to Furius Crassipes (quaestor in Bithynia in 51). It is not known if this marriage actually took place.

⁴ That the loss of his triumph rankled in his mind may be seen from *Brutus*, § 255: "hanc gloriam . . . tuae quidem supplicationi non, sed triumphis multorum antepono."

of his life, the death of Tullia, his beloved daughter. He shortly afterwards divorced Publilia, who had been jealous of Tullia's influence and proved unsympathetic. To solace his troubles he devoted himself wholly to literature. To this period belong several famous rhetorical and philosophical works, the *Brutus*, *Orator*, *Partitiones Oratoriae*, *Paradoxa*, *Academica*, *de Finibus*, *Tusculan Disputations*, together with other works now lost, such as his *Laus Catonis*, *Consolatio* and *Hortensius*.

His repose was broken by Caesar's murder on the 15th of March 44, to which he was not a party. On the 17th of March he delivered a speech in the senate urging a general amnesty like that declared in Athens after the expulsion of the Thirty Tyrants. When it became apparent that the conspirators had only removed the despot and left the despotism, he again devoted himself to philosophy, and in an incredibly short space of time produced the *de Natura Deorum*, *de Divinatione*, *de Fato*, *Cato maior* (or *de Senectute*), *Laelius* (or *de Amicitia*), and began his treatise *de Officiis*. To this period also belongs his lost work *de Gloria*. He then projected a journey to Greece in order to see his son Marcus, then studying at Athens, of whose behaviour he heard unfavourable reports. He reached Syracuse on the 1st of August, having during the voyage written from memory a translation of Aristotle's *Topica*. He was driven back by unfavourable winds to Leucopetra, and then, hearing better news, returned to Rome on the 21st of August. He was bitterly attacked by Marcus Antonius (Mark Antony) in the senate on the 1st of September for not being present there, and on the next day replied in his First *Philippic*. He then left Rome and devoted himself to the completion of the *de Officiis*, and to the composition of his famous Second *Philippic*, which was never delivered, but was circulated, at first privately, after Antony's departure from Rome to Cisalpine Gaul on the 28th of November.

Cicero returned to Rome on the 9th of December, and from that time forward led the republican party in the senate. His policy, stated briefly, was to make use of Octavian, whose name was all-powerful with the veterans, until new legions had been raised which would follow the republican commanders (*Phil.* xi. 39). Cicero pledged his credit for the loyalty of Octavian, who styled him "father" and affected to take his advice on all occasions (*Epp. ad Brut.* i. 17. 5). Cicero, an incurable optimist in politics, may have convinced himself of Octavian's sincerity. The breach, however, was bound to come, and the saying, maliciously attributed to Cicero, that Octavian was an "excellent youth who must be praised and—sent to another place," neatly expresses the popular view of the situation.¹ Cicero was sharply criticized by M. Junius Brutus for truckling to Octavian while showing irreconcilable enmity to Antony and Lepidus (*ad Brut.* i. 16. 4, i. 15. 9); but Brutus was safe in his province, and it is difficult to see what other course was open to a politician in Rome. Whether Cicero was right or wrong, none can question his amazing energy. He delivered his long series of *Philippics* at Rome, and kept up a correspondence with the various provincial governors and commanders, all short-sighted and selfish, and several of them half-hearted, endeavouring to keep each man in his place and to elaborate a common plan of operations. He was naturally included in the list of the proscribed, though it is said that Octavian fought long on his behalf, and was slain near Formiae on the 7th of December 43. He had a ship near in which he had previously attempted to fly, but being cast back by unfavourable winds he returned to his villa, saying, "Let me die in the country which I have often saved." His head and hands were sent to Rome and nailed to the rostra, after Fulvia, wife of Antony and widow of Clodius, had thrust a hairpin through the tongue.

Works.—The literary works of Cicero may be classed as (1) rhetorical; (2) oratorical; (3) philosophical and political; (4) epistolary.

(i.) *Rhetorical*.²—His chief works of this kind are: (a) *de*

Oratore, a treatise in three books dedicated to his brother Quintus. The discussion is conducted in the form of a dialogue which is supposed to have occurred in 91 B.C. chiefly between the two orators L. Crassus and M. Antonius. The first book deals with the studies necessary for an orator; the second with the treatment of the subject matter; the third with the form and delivery of a speech. Cicero says of this work in a letter (*Fam.* i. 9. 23) that it "does not deal in hackneyed rules and embraces the whole theory of oratory as laid down by Isocrates and Aristotle."

(b) *Brutus*, or *de claris oratoribus*, a history of Roman eloquence containing much valuable information about his predecessors, drawn largely from the *Chronicle* (*liber annalis*) of Atticus (§§ 14, 15). (c) *Orator*, dedicated to M. Brutus, sketching a portrait of the perfect and ideal orator, Cicero's last word on oratory. The sum of his conclusion is that the perfect orator must also be a perfect man. Cicero says of this work that he has "concentrated in it all his taste" (*Fam.* vi. 18. 4). The three treatises are intended to form a continuous series containing a complete system of rhetorical training.

It will be convenient to mention here a feature of Ciceronian prose on which singular light has been thrown by recent inquiry. In *de Oratore*, iii. 173 sqq., he considers the element of rhythm or metre in prose, and in the *Orator* (174-226) he returns to the subject and discusses it at length. His main point is that prose should be metrical in character, though it should not be entirely metrical, since this would be poetry (*Orator*, 220). Greek writers relied for metrical effect in prose on those feet which were not much used in poetry. Aristotle recommended the paean $\cup\cup\cup\cup$. Cicero preferred the cretic $\cup\text{—}$, which he says is the metrical equivalent of the paean. Demosthenes was especially fond of the cretic. Rhythm pervades the whole sentence but is most important at the end or *clausula*, where the swell of the period sinks to rest. The ears of the Romans were incredibly sensitive to such points. We are told that an assembly was stirred to wild applause by a double trochee $\cup\text{—}\cup\text{—}$.³ If the order were changed, Cicero says, the effect would be lost. The same rhythm should be found in the *membra* which compose the sentence. He quotes a passage from one of his own speeches in which any change in the order would destroy the rhythm. Cicero gives various *clausulae* which his ears told him to be good or bad, but his remarks are desultory, as also are those of Quintilian, whose examples were largely drawn from Cicero's writings. It was left for modern research to discover rules of harmony which the Romans obeyed unconsciously. Other investigators had shown that Cicero's *clausulae* are generally variations of some three or four forms in which the rhythm is trochaic. Dr Thaddaeus Zielinski of St Petersburg, after examining all the *clausulae* in Cicero's speeches, finds that they are governed by a law. In every *clausula* there is a basis followed by a cadence. The basis consists of a cretic or its metrical equivalent.⁴ This is followed by a cadence trochaic in character, but varying in length. The three favourite forms are (i.) $\cup\text{—}\text{—}\text{—}\text{—}$, (ii.) $\cup\text{—}\cup\text{—}\cup\text{—}$, (iii.) $\text{—}\text{—}\cup\text{—}\text{—}$. These he styles *verae* (V). Other frequent *clausulae*, which he terms *licitae* (L), are those in which a long syllable is resolved, as in verse, into two shorts, e.g. *essē vidētūr*. These two classes, V and L, include 86% of the *clausulae* in the orations. Some rarer *clausulae* which he terms M (= *malae*) introduce no new principle. There remain two interesting forms, viz. S (= *selectae*), in which a spondee is substituted for a trochee in the cadence, e.g. $\cup\text{—}\text{—}\text{—}\text{—}$, this being done for special emphasis, and P (= *pesimae*), where a dactyl is so used, e.g. $\cup\text{—}\cup\text{—}\cup\text{—}\text{—}$, this being the *heroica clausula* condemned by Quintilian. Similar rules apply to the *membra* of the sentence, though in these the S and P forms are more frequent, harmony being restored in the *clausula*.

These results apply not only to the speeches but also to the

(iii. i. 21). This is a manual of rhetoric derived from Greek sources with illustrations of figures drawn from Roman orators. Cicero's juvenile work *de Inventione* appears to be drawn partly from this and partly from a treatise by Hermagoras. This is a slight production and does not require detailed notice. Other minor works written in later life, such as the *Partitiones Oratoriae*, a catechism of rhetoric, in which instruction is given by Cicero to his son Marcus; the *Topica*, and an introduction to a translation of the speeches delivered by Demosthenes and Aeschines for and against Ctesiphon, styled *de optimo genere oratorum*, also need only be mentioned.

² *Orator*, § 214 "patris dictum sapiens temeritas filii comprobavit—hoc dichoreo tantus clamor contionis excitatus est ut admirabile esset. Quaero, nonne id numerus efficit? Verborum ordinem immuta, fac sic: 'Comprobavit filii temeritas? jam nihil erit.'"

³ This theory is partly anticipated by Terentianus Maurus (c. A.D. 290), who says of the cretic (v. 1440 sqq.)

"Plurimum orantes decedit quando paene in ultimo Obtinet sedem beatam, terminet si clausulam Dactylus spondeus imam, nec trochaicum respuo; Plenius tractatur istud arte prosa rhetoricum."

¹ *Fam.* xi. 20 "laudandum adolescentem, ornandum, tollendum."

² With these it is usual to include a treatise to Herennius by an anonymous author, a contemporary of Sulla, in modern times generally identified with a person named Cornificius, quoted by Quintilian

philosophical writings and the more elaborate letters, and with modifications to other rhythmical prose, e.g. that of Pliny and Seneca. Rhythm was avoided by Caesar who was an Atticist, and by Sallust who was an archaist. Livy's practice is exactly opposite to that of Cicero, since he has a marked preference for the *S* forms, thereby exemplifying Cicero's saying that long syllables are more appropriate to history than to oratory.¹

(ii.) *Speeches*.—These were generally delivered before the senate or people, if political in character, and before jurors sitting in a *quaestio*, if judicial. The speech against Vatinius was an attack upon a witness under examination; that *de Domo* was made before the Pontifices; that *pro C. Rabirio perduellionis reo* in the course of a *provocatio* to the people; and those *pro Ligario* and *pro rege Dciotaro* before Caesar. The five orations composing the *Actio Secunda in Verrem* were never spoken, but written after Verres had gone into exile. The Second *Philippic* also was not delivered but issued as a pamphlet. Cicero's speech for Milo at his trial was not a success, though, as Quintilian (ix. 2. 54) quotes from it, as taken down by shorthand reporters, an example of a rhetorical figure well used, it cannot have been such a failure as is alleged by later writers. The extant speech was written by Cicero at his leisure. None of the other speeches are in the exact form in which they were delivered. Cicero's method was to construct a *commentarius* or skeleton of his speech, which he used when speaking. If he was pleased with a speech he then wrote it out for publication. Sometimes he omitted in the written speech a subject on which he had spoken. A record of this is sometimes preserved: e.g. "de Postumi criminibus" (*Mur.* 51), "de teste Fufio" (*Cael.* 19). These *commentarii* were published by his freedman Tiro and are quoted by Asconius (*ad Orat. in Toga Candida*, p. 87).

Cicero in his speeches must be given all the privileges of an advocate. Sometimes he had a bad client; he naively confesses the straits to which he was put when defending Scamander (*Clu.* 51; cf. *Phil.* xiii. 26). He thought of defending Catiline, though he says that his guilt is clear as noon-day (*Att.* i. 1-2 and 2. 1). Sometimes the brief which he held at the moment compelled him to take a view of facts contrary to that which he had previously advocated. Thus in the *pro Caecina* he alleges judicial corruption against a witness, Falcula, while in the *pro Cluentio* he contends that the offence was not proved (*Caec.* 28, *Clu.* 103). He says quite openly that "it is a great mistake to suppose that statements in his speeches express his real opinions" (*Clu.* 139). It is therefore idle to reproach him with inconsistencies, though these are sometimes very singular. Thus in the *pro Cornelio* he speaks with praise of Aulus Gabinius, who, when a colleague vetoed his proposal, proceeded to depose him after the precedent set by Tiberius Gracchus (Asconius *in Corncl.* p. 71). In the *pro Cluentio*, 111, he contends that nothing is easier than for a new man to rise at Rome. In the *pro Caelio* he says that Catiline had in him undeveloped germs of the greatest virtues, and that it was the good in him that made him so dangerous (*Cacl.* 12-14). He sometimes deliberately puts the case upon a wrong issue. In the *pro Milone* he says that either Milo must have lain in wait for Clodius or Clodius for Milo, leaving out of sight the truth, that the encounter was due to chance. He used to boast that he had cast dust into the eyes of the jury in the case of Cluentius (Quintil. ii. 17-21).

Cicero had a perfect mastery of all weapons wielded by a pleader in Rome. He was specially famous for his pathos, and for this reason, when several counsel were employed, always spoke last (*Orat.* 130). A splendid specimen of pathos is to be found in his account of the condemnation and execution of the Sicilian captains (*Verr. (Act. ii.) v. 106-122*). Much exaggeration was permitted to a Roman orator. Thus Cicero frequently speaks as if his client were to be put to death, though a criminal could always evade capital consequences by going into exile. His enemies scoffed at his "tear-drops." He indulged in the more violent invective, which, though shocking to a modern reader, e.g. in his speeches against Vatinius and Piso, was not offensive to Roman taste (*de Orat.* ii. 216-290). He was much

¹ *Orator*, § 212 "cursum contentiones magis requirunt, expositiones rerum tarditatem."

criticized for his jokes, and even Quintilian (ii. 17-21) regrets that he made so many in his speeches. He could never resist the temptation to make a pun. It must be remembered, however, that he was the great wit of the period. Caesar used to have a collection of Cicero's *bon-mots* brought to him. Cicero complains that all the jokes of the day were attributed to himself, including those made by very sorry jesters (*Fam.* vii. 32. 1). A fine specimen of sustained humour is to be found in his speech *pro Murena*, where he rallies the jurisconsults and the Stoics. He was also criticized for his vanity and perpetual references to his own achievements. His vanity, however, as has been admirably remarked, is essentially that of "the peacock, not of the gander," and is redeemed by his willingness to raise a laugh at his own expense (Strachan-Davidson, p. 192). Some critics have impugned his legal knowledge, but probably without justice. It is true that he does not claim to be a great expert, though a pupil of the Scaevolae, and when in doubt would consult a jurisconsult; also, that he frequently passes lightly over important points of law, but this was probably because he was conscious of a flaw in his case.

(iii.) *Political and Philosophical Treatises*.—These are generally written in the form of dialogues, in which the speakers sometimes belong to bygone times and sometimes to the present. The first method was known as that of Heraclides, the second as that of Aristotle (*Att.* xiii. 19. 4). There is no reason to suppose that the speakers held the views with which Cicero credits them, or had such literary powers as would make them able to express such views (*ib.* xiii. 12. 3). The political works are *de Republica* and *de Legibus*. The first was a dialogue in six books concerning the best form of constitution, in which the speakers are Scipio Africanus Minor and members of his circle. He tells us that he drew largely from Plato, Aristotle, Theophrastus and writings of the Peripatetics. The famous "Dream of Scipio" recalls the "Vision of Er" in Plato's *Republic* (Book x. *ad fin.*). The *de Legibus*, a sequel to this work in imitation of Plato's *Laws*, is drawn largely from Chrysippus.

Cicero as a philosopher belonged to the New Academy. The followers of this school were free to hear all arguments for and against, and to accept the conclusion which for the moment appeared most probable (*Acad.* ii. 131). Thus in the *Tusculan Disputations* v. he expresses views which conflict with *de Finibus* iv., and defends himself on the ground that as an Academic he is free to change his mind. He was much fascinated by the Stoic morality, and it has been noticed that the *Tusculan Disputations* and *de Officiis* are largely Stoic in tone. He has nothing but contempt for the Epicureans, and cannot forgive their neglect of literary style. As Cicero's philosophical writings have been severely attacked for want of originality, it is only fair to recollect that he resorted to philosophy as an anodyne when suffering from mental anguish, and that he wrote incredibly fast. He issued two editions of his *Academics*. The first consisted of two books, in which Catulus and Lucullus were the chief speakers. He then rewrote his treatise in four books, making himself, Varro and Atticus the speakers. The Romans at this time had no manuals of philosophy or any philosophical writings in Latin apart from the poem of Lucretius and some unskilful productions by obscure Epicureans. Cicero set himself to supply this want. His works are confessedly in the main translations and compilations (*Att.* xiii. 52. 3); all that he does is to turn the discussion into the form of a dialogue, to adapt it to Roman readers by illustrations from Roman history, and to invent equivalents for Greek technical terms. This is equally true of the political treatises. Thus, when Atticus criticized a strange statement in *de Republ.* ii. 8, that all the cities of the Peloponnese had access to the sea, he excuses himself by saying that he found it in Dicaearchus and copied it word for word (*Att.* vi. 2. 3): In the same passage he used an incorrect adjective, *Phliuntii* for *Phliasii*; he says that he had already corrected his own copy, but the mistake survives in the single palimpsest in which this work has been preserved. The only merits, therefore, which can be claimed for Cicero are that he invented a philosophical terminology for the Romans, and that he produced a

series of manuals which from their beauty of style have had enduring influence upon mankind.

The most famous of these treatises are the following:—

De Finibus, on the Supreme Good. In Book i. L. Manlius Torquatus explains the Epicurean doctrine, which is refuted in ii. by Cicero. In iii. and iv. M. Porcius Cato sets forth the doctrine of the Stoics which is shown by Cicero to agree with that of Antiochus of Ascalon; in v. M. Pupius Piso explains the views of the Academics and Peripatetics.

Tusculanae Disputationes, so called from Cicero's villa at Tusculum in which the discussion is supposed to have taken place. The subjects treated are:—in Book i., the nature of death and the reasons for despising it; Book ii., the endurance of pain: Pain is not an evil; Book iii., wisdom makes a man insensible to sorrow; Book iv., wisdom banishes all mental disquietude; Book v., virtue is sufficient to secure happiness. The materials are drawn largely from works of Dicaearchus.

De Deorum Natura.—The dialogue is placed in 77 B.C. In Book i. Velleius attacks other philosophies and explains the system of Epicurus. He is then refuted by Cotta. In Book ii. Balbus, speaking as a Stoic, discusses the existence of the gods, nature, the government of the world and providence. In Book iii. Cotta criticizes the views of Balbus. The statement of the Epicurean doctrine is drawn from the work of Phaedrus *Περὶ θεῶν*, the criticism of this from Posidonius. The Stoic teaching is derived from Cleanthes, Chrysippus and Zenon, and is criticized from the writings of Carneades and Clitomachus.

De Officiis, addressed to his son Marcus. In this the form of dialogue was not employed. The material is chiefly drawn from Stoic sources, e.g. works of Panaetius in Books i. and ii., of Posidonius and Hecato in Book iii.

The *Academica*, as they have come down to us, are a conflation from the two editions of this work. They consist of the second book from the first edition, and a portion of the first book from the second edition.

Cato maior, or de Senectute, a dialogue placed in 150 B.C. in which Cato, addressing Scipio and Laelius, set forth the praises of old age. The idea is drawn from Aristo of Chios, and the materials largely derived from Xenophon and Plato.

Laelius, or de Amicitia, a dialogue between Laelius and his sons-in-law, in which he sets forth the theory of friendship, speaking with special reference to the recent death of Scipio. Cicero here draws from a work of Theophrastus on the same subject and from Aristotle.

(iv.) *Letters*.—Those preserved are (1) *ad Familiares*, i.-xvi.; (2) *ad Atticum*, i.-xvi.; (3) *ad Quintum*, i.-iii., *ad Brutum*, i.-ii. Some thirty-five other books of letters were known to antiquity, e.g. to Caesar, to Pompey, to Octavian and to his son Marcus.

The collection includes nearly one hundred letters written by other persons. Thus, the eighth Book *ad Fam.* consists entirely of letters from Caelius to Cicero when in Cilicia. When writing to Atticus Cicero frequently sent copies of letters which he had received. There is a great variety in the style not only of Cicero's correspondents, but also of Cicero himself. Caelius writes in a breezy, school-boy style; the Latinity of Plancus is Ciceronian in character; the letter of Sulpicius to Cicero on the death of Tullia is a masterpiece of style; Matius writes a most dignified letter justifying his affectionate regard for Caesar's memory. There is an amazingly indiscreet letter of Quintus to his brother's freedman, Tiro, in which he says of the consul-elect, Hirtius and Pansa, that he would hesitate to put one of them in charge of a village on the frontier, and the other in that of the basement of a tavern (*Fam.* xvi. 27. 2). Several of his correspondents are indifferent stylists. Cato labours to express himself in an awkward and laconic epistle, apologizing for its length. Metellus Celer is very rude, but gives himself away in every word. Antony writes bad Latin, while Cicero himself writes in various styles. We have such a *cri de cœur* as his few words to one of the conspirators after Caesar's murder, "I congratulate you. I rejoice for myself. I love you. I watch your interests; I wish for your love and to be informed what you are doing and what is being done" (*Fam.* vi. 15). When writing to Atticus he eschews all ornamentation, uses short sentences, colloquial idioms, rare diminutives and continually quotes Greek. This use of Greek tags and quotations is also found in letters to other intimate friends, e.g. Paetus and Caelius; also in letters written by other persons, e.g. Cassius to Cicero; Quintus to Tiro, and subsequently in those of Augustus to Tiberius. It is a feature of the colloquial style and often corresponds to the modern use of "slang." Other letters of Cicero,

especially those written to persons with whom he was not quite at his ease or those meant for circulation, are composed in his elaborate style with long periods, parentheses and other devices for obscuring thought. These are throughout rhythmical in character, like his speeches and philosophical works.

We know from Cicero's own statement (*Att.* xvi. 5. 5) that he thought of publishing some of his letters during his lifetime. On another occasion he jestingly charges Tiro with wishing to have his own letters included in the "volumes" (*Fam.* xvi. 17. 1). It is obvious that Cicero could not have meant to publish his private letters to Atticus in which he makes confessions about himself, or those to Quintus in which he sometimes outsteps the limits of brotherly criticism, but was thinking of polished productions such as the letters to Lentulus Spinther or that to Luceius which he describes as "very pretty" (*Att.* iv. 6. 4).

It is universally agreed that the letters *ad Familiares* were published by Tiro, whose hand is revealed by the fact that he suppresses all letters written by himself, and modestly puts at the end those written to him. That Cicero kept copies of his letters, or of many of them, we know from a passage in which, when addressing a friend who had inadvertently torn up a letter from him, he says that there is nothing to grieve about; he has himself a copy at home and can replace the loss (*Fam.* vii. 25. 1). Tiro may have obtained from Terentia copies of letters written to her. It has been suggested that he may also have edited the letters to Quintus, as he could obtain them from members of the family. The letters *ad Familiares* were generally quoted in antiquity by books, the title being taken from the first letter, e.g. *Cicero ad Varronem epistula Pacli*.

While the letters *ad Familiares* were circulated at once, those to Atticus appear to have been suppressed for a considerable time. Cornelius Nepos (*Att.* 16) knew of their existence but distinguishes them from the published letters. Asconius (p. 87), writing under Claudius, never quotes them, though, when discussing Cicero's projected defence of Catiline, he could hardly have failed to do so, if he had known them. The first author who quotes them is Seneca. It is, therefore, probable that they were not published by Atticus himself, who died 32 B.C., though his hand may be seen in the suppression of all letters written by himself, but that they remained in the possession of his family and were not published until about A.D. 60. At that date they could be published without expurgation of any kind, whereas in the letters *ad Familiares* the editor's hand is on one occasion (*iii.* 10. 11) manifest. Cicero is telling Appius, his predecessor in Cilicia, of the measures which he is taking on his behalf. There then follows a lacuna. It is obvious that Tiro thought the passage compromising and struck it out. In the letters to Atticus, on the other hand, we have Cicero's private journal, his confessions to the director of his conscience, the record of his moods from day to day, without alterations of any kind.

Cicero's letters are the chief and most reliable source of information for the period. It is due to them that the Romans of the day are living figures to us, and that Cicero, in spite of, or rather in virtue of his frailties, is intensely human and sympathetic. The letters to Atticus abound in the frankest self-revelation, though even in the presence of his confessor his instinct as a pleader makes him try to justify himself. The historical value of the letters, therefore, completely transcends that of Cicero's other works. It is true that these are full of information. Thus we learn much from the *de Legibus* regarding the constitutional history of Rome, and much from the *Brutus* concerning the earlier orators. The speeches abound in details which may be accepted as authentic, either because there is no reason for misrepresentation or on account of their circumstantiality. Thus the *Verrines* are our chief source of information for the government of the provinces, the system of taxation, the powers of the governor. We hear from them of such interesting details as that the senate annul a judicial decision improperly arrived at by the governor, or that the college of tribunes could consider the status at Rome of a man affected by this decision (*Verr.* II. ii. 95-100). We have unfolded to us the monstrous system by which the governor could fix upon a remote place

for the delivery of corn, and so compel the farmer to compound by a payment in money which the orator does not blame, on the ground that it is only proper to allow magistrates to receive corn wherever they wish (*ib.* iii. 190). From the speech *pro Cluentio* (145-154) we gain unique information concerning the condition of society in a country town, the extraordinary exemption of equites from prosecution for judicial corruption, the administration of domestic justice in the case of slaves examined by their owner (*ib.* 176-187). But we have always to be on our guard against misrepresentation, exaggeration and falsehood. The value of the letters lies in the fact that in them we get behind Cicero and are face to face with the other *dramatis personae*; also that we are admitted behind the scenes and read the secret history of the times. One of the most interesting documents in the correspondence is a despatch of Caesar to his agent Oppius, written in great haste and in disjointed sentences. It runs as follows: "On the 9th I came to Brundisium. Pompey is at Brundisium. He sent Magius to me to treat of peace. I gave him a suitable answer" (*Att.* ix. 13, Ai.). In the *de Bello civili*, on the other hand, Caesar, who wishes to show that he did his best to make peace, after stating that he sent his captive Magius to negotiate, expresses mild surprise at the fact that Pompey did not send him back (*Bell. Civ.* i. 26). We hear of the extraordinary agreement made by two candidates for the consulship in Caesar's interest with the sitting consuls of 54 B.C., which Cicero says he hardly ventures to put on paper. Under the terms of this the consuls, who were *optimates*, bound themselves to betray their party by securing, apparently fraudulently, the election of the candidates while they in turn bound themselves to procure two ex-consuls who would swear that they were present in the senate when supplies were voted for the consular provinces, though no meeting of the senate had been held, and three augurs who would swear that a *lex curiata* had been passed, though the *comitia curiata* had not been convened (*Att.* iv. 18. 2). But perhaps the most singular scene is the council of three great ladies presided over by Servilia at Antium, which decides the movements of Brutus and Cassius in June 44 B.C., when Cassius "looking very fierce—you would say that he was breathing fire and sword"—blustered concerning what he considered an insult, viz. a commission to supply corn which had been laid upon him. Servilia calmly remarks she will have the commission removed from the decree of the senate (*Att.* xv. 11. 2).

(v.) *Miscellaneous*.—It is not necessary to dwell upon the other forms of literary composition attempted by Cicero. He was a fluent versifier, and would write 500 verses in one night. Considerable fragments from a juvenile translation of Aratus have been preserved. His later poems upon his own consulship and his exile were soon forgotten except for certain lines which provoked criticism, such as the unfortunate verse:

"O fortunatam natam me consule Romam."

He wrote a memoir of his consulship in Greek and at one time thought of writing a history of Rome. Nepos thought that he would have been an ideal historian, but as Cicero ranks history with declamation and on one occasion with great *naïveté* asks Lucius Luceius (*q.v.*), who was embarking on this task, to embroider the facts to his own credit; we cannot accept this criticism (*Fam.* vi. 2. 3).

(vi.) *Authenticity*.—The genuineness of certain works of Cicero has been attacked. It was for a long time usual to doubt the authenticity of the speeches *post reditum* and *pro Marcello*.¹ Recent scholars consider them genuine. As their rhythmical structure corresponds more or less exactly with the canon of authenticity formed by Zielinski from the other speeches, the question may now be considered closed.² Absurd suspicion has been cast upon the later speeches in *Catilinam* and that *pro Archia*. An oration *pridie quam in exsilium iret* is certainly a forgery, as also a letter to Octavian. There is a "controversy" between Cicero and Sallust which is palpably a forgery, though

¹ Markland and F. A. Wolf first rejected them.

² In the speeches generally $L+V=86\%$. In the *de Domo* the proportion is 88 and in the *pro Marcello* 87 %.

a quotation from it occurs in Quintilian.³ Suspicion has been attached to the letters to Brutus, which in the case of two letters (i. 16 and 17) is not unreasonable since they somewhat resemble the style of *suasoriae*, or rhetorical exercises, but the latest editors, Tyrrell and Purser, regard these also as genuine.

Criticism. (i.) *Ancient*.—After Cicero's death his character was attacked by various detractors, such as the author of the spurious *Controversia* put into the mouth of Sallust, and the calumniator from whom Dio Cassius (xlv. 1-28) draws the libellous statements which he inserts into the speech of Q. Fufius Calenus in the senate. Of such critics, Asconius (in *Tog. Cand.* p. 95) well says that it is best to ignore them. His prose style was attacked by Pollio as Asiatic, also by his son, Asinius Gallus, who was answered by the emperor Claudius (Suet. 41). The writers of the silver age found fault with his prolixity, want of sparkle and epigram, and monotony of his clausulae.⁴ A certain Larius Licinius gained notoriety by attacking his Latinity in a work styled *Ciceromastix*. His most devoted admirers were the younger Pliny, who reproduced his oratorical style with considerable success, and Quintilian (x. 1. 112), who regarded him as the perfect orator, and draws most of his illustrations from his works. At a later period his style fascinated Christian writers, notably Lactantius, the "Christian Cicero," Jerome and S. Augustine, who drew freely from his rhetorical writings.

The first commentator upon Cicero was Asconius, a Roman senator living in the reign of Claudius, who wrote a commentary upon the speeches, in which he explains obscure historical points for the instruction of his sons (see ASCONIUS). Passing over a number of grammatical and rhetorical writers who drew illustrations from Cicero, we may mention the *Commentary* of Victorinus, written in the 4th century, upon the treatise *de Inventione*, and that of Boethius (A.D. 480-524) upon the *Topica*. Among scholiasts may be mentioned the *Scholiasa Bobiensis* who is assigned to the 5th century, and a pseudo-Asconius, who wrote notes upon the *Verrines* dealing with points of grammar and rhetoric.

(ii.) *Medieval Scholars*.—In the middle ages Cicero was chiefly known as a writer on rhetoric and morals. The works which were most read were the *de Inventione* and *Topica*—though neither of these was quite so popular as the treatise *ad Herennium*, then supposed to be by Cicero—and among the moral works, the *de Officiis*, and the *Cato Maior*. John of Salisbury (1110-1180) continually quotes from rhetorical and philosophical writings, but only once from the speeches. The value set upon the work *de Inventione* is shown by a passage in which Notker (d. 1022) writing to his bishop says that he has lent a MS. containing the *Philippics* and a commentary upon the *Topics*, but has received as a pledge something far more valuable, viz. the *de Inventione*, and the "famous commentary of Victorinus."⁵ We have an interesting series of excerpts made by a priest named Hadoard, in the 9th century, taken from all the philosophical writings now preserved, also from the *de Oratore*.⁶

The other works of Cicero are seldom mentioned. The most popular speeches were those against Catiline, the *Verrines*, *Caesarianae* and *Philippics*, to which may be added the spurious *Controversia*. A larger knowledge of the speeches is shown by Wibald, abbot of Corvey, who in 1146 procured from Hildesheim a MS. containing with the *Philippics* the speeches against Rullus, wishing to form a *corpus* of Ciceronian works.⁷ Gerbert (afterwards Pope Silvester II., 940-1003) was especially interested in the speeches, and in a letter to a friend (*Epist.* 86) advises him to take them with him when journeying. The letters are rarely mentioned. The abbey of Lorsch possessed in the 9th century five MSS. containing "Letters of Cicero," but those to Atticus are only mentioned once, in the catalogue of Cluny written in the 12th century.⁸ Letters of Cicero were known to Wibald of Corvey, also to Servatus Lupus, abbot of Ferrières (805-832), who prosecuted in the 9th century a search for MSS. which reminds us of the Italian humanists in the 15th century. A good deal of textual criticism must have been devoted to Cicero's works during this period. The earliest critic was Tiro, who, as we know from Aulus Gellius (i. 7. 1), corrected MSS. which were greatly valued as containing his recension. We have a very interesting colophon to the speeches against Rullus, in which Statilius Maximus states that he had corrected the text by the help of a MS. giving the recension of Tiro, which he had collated with five other ancient copies.⁹

It is interesting to notice that Servatus Lupus did similar work in the 9th century. Thus, writing to Ansbald of Prüfing, he says, "I will collate the letters of Cicero which you sent with the copy

³ Quintil. iv. 1. 68. It is possible that the writer may have used a quotation preserved from a real speech by Quintilian.

⁴ Tacitus, *Dial.* 22 "omnis clausulas uno et eodem modo determinet."

⁵ Ed. P. Piper, p. 861.

⁶ *Philologus* (1886), Suppl. Bd. v.

⁷ Jaffé, *Bibl. Rer. German.*, i. 326.

⁸ Delisle, *Cabinet des MSS.*, ii. 459.

⁹ "Statilius Maximus rursus emendavi ad Tironem et Laecanium et dom. et alios veteres III." He was a grammarian who lived at the end of the 2nd century.

which I have so as to elicit the true reading, if possible, by comparing the two."¹ He asks another correspondent to supply him with a copy of the *Verrines* or any other works for a similar purpose.

Brunetto Latini (d. ca. 1294), the master of Dante, translated the *Caesarianae* into Italian. Dante himself appears to be acquainted only with the *Laelius*, *Cato Maior*, *de Officiis*, *de Finibus*, *de Inventione* and *Paradoxa*. Petrarch says that among his countrymen Cicero was a great name, but was studied by few. Petrarch himself sought for MSS. of Cicero with peculiar ardour. He found the speech *pro Archia* at Liège in 1333, and in 1345 at Verona made his famous discovery of the letters to Atticus, which revealed to the world Cicero as a man in place of the "god of eloquence" whom they had worshipped. Petrarch was under the impression in his old age that he had once possessed Cicero's lost work *de Gloria*, but it is probable that he was misled by one of the numerous passages in the extant writings dealing with this subject.² The letters *ad Familiares* were discovered towards the close of the 14th century at Vercelli. The largest addition to the sum of Ciceronian writings was made by Poggio (Gian Francesco Poggio Bracciolini) in the course of his celebrated mission to the Council of Constance (1414-1417). He brought back no less than ten speeches of Cicero previously unknown to the Italians, viz. *pro Sexto Roscio*, *pro Murena*, *pro Caccina*, *de lege agraria* i.-iii., *pro Rabirio perduellionis reo*, *pro Rabirio Postumo*, *pro Roscio Comoedo*, and *in Pisonem*. An important discovery was made at Lodi in 1422 of a MS. which, in addition to complete copies of the *de Oratore* and *Orator*, hitherto known from mutilated MSS., contained an entirely new work, the *Brutus*. The second book of Cicero's letters to Brutus was first printed by Cratander of Basel in 1523 from a MS. obtained for him by Sichardus from the abbey of Lorsch.³

All these MSS. are now lost, except that containing the *Epistolae ad Familiares*, a MS. written in the 9th century and now at Florence (Laur. xlix. 9). A similar fate overtook three other MSS. containing the letters to Atticus, independent of the *Veronensis*, viz. a mutilated MS. of Books i.-vii. discovered by Cardinal Capra in 1409, a Lorsch MS. used by Cratander (C), and a French MS. (Z), generally termed *Tornaesianus* from its owner, Jean de Tournes, a printer of Lyons, probably identical with No. 492 in the old Cluny catalogue, used by Turnebus, Lambinus and Bosius. A strange mystification was practised by the last named, a scholar of singular brilliancy, who claimed to have a mutilated MS. which he called his *Decurtatus*, bought from a common soldier who had obtained it from a sacked monastery; also to have been furnished by a friend, Pierre de Crouzeil, a doctor of Limoges, with variants taken from an old MS. found at Noyon, and entered in the margin of a copy of the Lyons edition. The rough draft of his notes, however, upon Books x.-xvii., which afterwards came into the hands of Baluze, is preserved in the Paris library (Lat. 8538 A), in which he continually ascribes different readings to these MSS., the alteration corresponding with a change in his own conjecture. It is, therefore, obvious that he invented the readings in order to strengthen his own corrections. The book, which he termed his *Crusellinus*, may well be his copy of the Lyons edition of 1545 (number 8665 in the sale-catalogue of Baluze), which is described as *cum notis et emendationibus MSS. manu ejusdem Bosii*.⁴

The oldest evidence now existing for any works of Cicero is to be found in palimpsests written in the 4th or 5th century. The most interesting of these, now in the Vatican (Lat. 5757), discovered by Angelo Mai in 1822, contains the treatise *de Republica*, only known from this source. Fragments of the lost speeches *pro Tullio* and *pro Scuro* were discovered in two Milan and Turin palimpsests. The Vatican also possesses an important palimpsest of the *Verrines* (Reg. 2077). A palimpsest containing fragments of various orations was recently destroyed by the fire at the Turin library. The works *de Oratore* and *Orator* are well represented by ancient MSS., the two best known being one at Avranches (*Abrincensis* 238) and a Harleian MS. (2736), both written in the 9th century. The *Brutus* is only known from 15th-century transcripts of the lost *cod. Lodensis*.

The oldest MS. of any speeches, or indeed of any work of Cicero's, apart from the palimpsests, belongs to the Chapter-house of St Peter's in Rome (H. 25). It contains the speeches in *Pisonem*, *pro Fonteio*, *pro Flacco* and the *Philippics*. The earlier part of the MS. was written in the 8th century. The Paris library has two 9th-century MSS., viz. 7774 A. containing in *Verrem* (*Act. ii.*), iv. and v., and 7794, containing the *post reditum* speeches, together with those *pro Sestio*, in *Vatinius*, *de provinciis consularibus*, *pro Balbo*, *pro Caelio*. The only other 9th-century MS. of the speeches is now in Lord Leicester's library at Holkham, No. 387.⁵ It originally belonged to Cluny, being No. 498 in the old catalogue. It contains in a mutilated form the speeches in *Catilinam*, *pro Ligario*, *pro rege Deiotaro* and in *Verrem* (*Act. ii.*).

The speeches *pro Sex. Roscio* and *pro Murena* are only known from an ancient and illegible MS. discovered by Poggio at Cluny,

No. 496 in the old catalogue, and now lost. The most faithful transcript was made in France (Paris, Lat. 14,749) before the MS. passed into Poggio's hand by a writer who carefully reproduced the corruptions, sometimes in facsimile.⁶ The speeches *pro Roscio Comoedo*, *pro Rabirio perduellionis reo* and *pro Rabirio Postumo* are only known from Italian copies of the transcript (now lost) made by Poggio from lost MSS. The *de Officiis*, *Tusculan Disputations* and *Cato Maior* are found in a number of 9th-century MSS. A collection, consisting of *de Natura deorum*, *de Divinatione*, *Timaemus*, *de Fato*, *Paradoxa*, *Lucullus* (= *Acad. Prior.*) and *de Legibus*, is found in several MSS. of the same date. Only one MS. of the *Laelius* is as old as the 10th century.

The *Academica Posteriara* are said by editors to be found only in 15th-century MSS. A MS. in the Paris library (Lat. 6331) is, however, assigned by Chatelain to the 12th century.

For the letters *ad Familiares* our chief source of information is Laur. xlix. 9 (9th century), which contains all the sixteen books. There are independent MSS. written in France and Germany in the 11th and 12th centuries, containing i.-viii. and ix.-xvi. respectively. There is no extant MS. of the letters to Atticus older than the 14th century, apart from a few leaves from a 12th-century MS. discovered at or near Würzburg in the last century. Very great importance has been attached to a Florentine MS. (Laur. xlix. 18) M., which until recently was supposed to have been copied by Petrarch himself from the lost *Veronensis*. It is now known not to be in the hand of Petrarch, but it was still supposed to be the archetype of all Italian MSS., and possibly of all MSS., including the lost C and Z. It has, however, been shown by Lehmann that there is an independent group of Italian MSS., termed by him Z, containing Books i.-vii. in a mutilated form, and probably connected with the MS. of Capra. These often agree with CZ against M, and the readings of CZΣ are generally superior.

BIBLIOGRAPHY.—It is impossible to mention more than a few works as the literature is so vast. (1) *Historical.*—J. L. Strachan-Davidson, *Life of Cicero* (Heroes of the Nations); G. Boissier, *Cicéron et ses amis*; Suringar, *Cicero de vita sua* (Leiden, 1854); W. Warde Fowler, *Social Life at Rome* (1908); introductions to Tyrrell and Purser's edition of the letters. (2) *Palaeographical.*—Facsimiles of the best-known MSS. are given by E. Chatelain in *Paléographie des classiques latins*, parts 2, 3 and 7. Information regarding various MSS. will be found in Halm, *Zur Handschriftenkunde der ciceronischen Schriften* (Munich, 1850); Deschamps, *Essai bibliographique sur Cicéron* (Paris, 1863) (an unscientific work); Lehmann, *De Ciceronis ad Atticum epistulis recensendis* (Berlin, 1892); *Anecdota Oxoniensia*, classical series, parts vii., ix., x. (3) *Literary.*—M. Schanz, *Geschichte der römischen Literatur*, i. 194-274 (München, 1890). (4) *Linguistic.*—Merguet, *Lexicon to Oratorical and Philosophical Works*; Le Breton, *Études sur la langue et la grammaire de Cicéron* (Paris, 1901); Norden, *Die antike Kunstprosa* (Leipzig, 1898); Th. Zielinski, *Das Clauselgesetz in Ciceros Reden* (Leipzig, 1904). Much information on points of Ciceronian idiom and language will be found in J. S. Reid's *Academica* (London, 1885) and Landgraf's *Pro Sexto Roscio* (Erlangen, 1884). (5) *Legal.*—A. H. J. Greenidge, *The Legal Procedure of Cicero's Time* (Oxford, 1901). (6) *Philosophical.*—An excellent account of Cicero as a philosopher is given in the preface to Reid's edition of the *Academica*. (7) *Editions* (critical) of the complete texts.—Baiter-Halm (1845-1861); C. F. W. Müller (1880-1896); Oxford Classical Texts. (A. C. C.)

2. **QUINTUS TULLIUS CICERO**, brother of the orator and brother-in-law of T. Pomponius Atticus, was born about 102 B.C. He was aedile in 67, praetor in 62, and for the three following years propraetor in Asia, where, though he seems to have abstained from personal aggrandizement, his profligacy and ill-temper gained him an evil notoriety. After his return to Rome, he heartily supported the attempt to secure his brother's recall from exile, and was nearly murdered by gladiators in the pay of P. Clodius Pulcher. He distinguished himself as one of Julius Caesar's legates in the Gallic campaigns, served in Britain, and afterwards under his brother in Cilicia. On the outbreak of the civil war between Pompey and Caesar, Quintus, like Marcus, supported Pompey, but after Pharsalus he deserted and made peace with Caesar, largely owing to the intercession of Marcus. Both the brothers fell victims to the proscription which followed Caesar's death, Quintus being put to death in 43, some time before Marcus. His marriage with Pomponia was very unhappy, and he was much under the influence of his slave Statius. Though trained on the same lines as Marcus he never spoke in public, and even said, "One orator in a family is enough, nay even in a city." Though essentially a soldier, he took considerable interest in literature, wrote epic poems, tragedies and annals, and translated plays of Sophocles. There are extant

¹ *Epist.* 69 "Tullianas epistulas quas misisti cum nostris conferri faciam ut ex utrisque, si possit fieri, veritas exculpatur"

² Nolhac, *Pétrarque et l'humanisme*, pp. 216-223.

³ Lehmann, *De Ciceronis ad Atticum epp. recensendis*, p. 128.

⁴ *Philologus*, 1901, p. 216.

⁵ *Anecdota Oxoniensia*, Classical Series, part ix. (W. Petersen).

⁶ *Anecdota Oxoniensia*, Classical Series, part x. (A. C. Clark).

four letters written by him (one to his brother Marcus, and three to his freedman Tiro) and a short paper, *De Petitione Consulatus* (on canvassing for the consulship), addressed to his brother in 64. Some consider this the work of a rhetorician of later date. A few hexameters by him on the twelve signs of the Zodiac are quoted by Ausonius.

Cicero in several of his *Letters* (ed. Tyrrell and Purser); *pro Sestio*, 31; Caesar, *Bell. Gal.*; Appian, *Bell. Civ.* iv. 20; Dio Cassius, xl. 7, xlvii. 10; text of the *De Petil. Cons.* in A. Eussner, *Commentariolum Petitionis* (1872), see also R. Y. Tyrrell in *Hermathena*, v. (1877), and A. Beltrami, *De Commentariolo Petitionis Q. Ciceroni vindicando* (1892); G. Boissier, *Cicero and His Friends* (Eng. trans., 1897), especially pp. 235-241.

3. MARCUS TULLIUS CICERO, only son of the orator and his wife Terentia, was born in 65 B.C. At the age of seventeen he served with Pompey in Greece, and commanded a squadron of cavalry at the battle of Pharsalus. In 45 he was sent to Athens to study rhetoric and philosophy, but abandoned himself to a life of dissipation. It was during his stay at Athens that his father dedicated the *de Officiis* to him. After the murder of Caesar (44) he attracted the notice of Brutus, by whom he was offered the post of military tribune, in which capacity he rendered good service to the republican cause. After the battle of Philippi (42), he took refuge with Sextus Pompeius in Sicily, where the remnants of the republican forces were collected. He took advantage of the amnesty granted by the treaty of Misenum (39) to return to Rome, where he took no part in public affairs, but resumed his former dissipated habits. In spite of this, he received signal marks of distinction from Octavian, who not only nominated him augur, but accepted him as his colleague in the consulship (30). He had the satisfaction of carrying out the decree which ordered that all the statues of Antony should be demolished, and thus "the divine justice reserved the completion of Antony's punishment for the house of Cicero" (Plutarch). He was subsequently appointed proconsul of Asia or Syria, but nothing further is known of his life. In spite of his debauchery, there is no doubt that he was a man of considerable education and no mean soldier, while Brutus, in a letter to his father (*Epp. ad Brutum*, ii. 3), even goes so far as to say that the son would be capable of attaining the highest honours without borrowing from the father's reputation.

See Plutarch, *Cicero, Brutus*; Appian, *Bell. Civ.* ii. 20, 51, iv. 20; Dio Cassius xlv. 15, xlvi. 18, li. 19; Cicero's *Letters* (ed. Tyrrell and Purser); G. Boissier, *Cicero and His Friends* (Eng. trans., 1897), pp. 104-107.

4. QUINTUS TULLIUS CICERO (c. 67-43 B.C.), son of Quintus Tullius Cicero (brother of the orator). He accompanied his uncle Marcus to Cilicia, and, in the hope of obtaining a reward, repaid his kindness by informing Caesar of his intention of leaving Italy. After the battle of Pharsalus he joined his father in abusing his uncle as responsible for the condition of affairs, hoping thereby to obtain pardon from Caesar. After the death of Caesar he attached himself to Mark Antony, but, owing to some fancied slight, he deserted to Brutus and Cassius. He was included in the proscription lists, and was put to death with his father in 43. In his last moments he refused under torture to disclose his father's hiding-place. His father, who in his concealment was a witness of what was taking place, thereupon gave himself up, stipulating that he and his son should be executed at the same time.

See Cicero, *ad Att.* x. 4, 6, 7, 3; xiv. 20, 5; Dio Cassius xlvii. 10.

CICERONE, a guide, one who conducts visitors to museums, galleries, &c., and explains matters of archaeological, antiquarian, historic or artistic interest. The word is presumably taken from Marcus Tullius Cicero, as a type of learning and eloquence. The *New English Dictionary* finds examples of the use earlier in English than Italian, the earliest quotation being from Addison's *Dialogues on Medals* (published posthumously 1726). It appears that the word was first applied to "learned antiquarians who show and explain to foreigners the antiquities and curiosities of the country" (quotation of 1762 in the *New English Dictionary*).

CICHLID (*Cichlidae*), a family of Acanthopterygian fishes, related to the perches and wrasses, and confined to the fresh

and brackish waters of Central and South America, Africa, Syria, and India and Ceylon. It has recently assumed special importance through the large number of genera and species, many of them showing extraordinary modifications of the dentition, which have been discovered in tropical Africa, especially in the great lakes Victoria, Tanganyika and Nyasa. About 180 species are known from Africa (with Syria and Madagascar), 150 from America, and 3 from India and Ceylon. They were formerly known under the inappropriate name of *Chromides*.

These fish are further remarkable for their nursing habits. It was formerly believed that the male takes charge of the eggs, and later the young, by sheltering them in the mouth and pharynx. This may still be true of some of the American species, but a long series of recent observations have shown that this most efficacious parental care devolves invariably on the female in the African and Syrian species. We are now acquainted with a large number of species in which this extraordinary habit has been observed, the number having lately been greatly increased by the collections made in Lakes Tanganyika and Victoria.

L. Lortet had described a fish from Lake Tiberias in which he believed he had observed the male take up the eggs after their deposition and retain them in his mouth and pharynx long after eclosion, in fact until the young are able to shift for themselves, and this fish he named *Chromis paterfamilias*. A. Günther had also ascribed the same sex to a fish from Natal, *Chromis philander*, observed by N. Abraham to have similar habits. G. A. Boulenger has since had an opportunity to examine the latter specimen and found it to be a female, as in all other nursing individuals from various parts of Africa, previously observed by himself; whilst J. Pellegrin has ascertained the female sex of a specimen with eggs in the mouth presented to the Paris museum by Lortet as his *Chromis paterfamilias* (= *Tilapia simonis*). Further observations by Pellegrin on *Tilapia galilaea* and *Pelmatochromis lateralis*, by E. Schoeller on *Paratilapia multicolor*, have led to the same result.

It therefore remains unproven whether in any of the African *Cichlidae* the buccal "incubation," as it has been called by Pellegrin, devolves on the male; the instances previously adduced being unsupported by the only trustworthy evidence—an examination of the genital glands.

The relative size and number of the eggs thus taken charge of vary very much according to the species. Thus they may be moderately large and numerous (100 to 200) in *Tilapia nilotica* and *galilaea*, larger and only about 30 in number in *Paratilapia multicolor*, while in *Tropheus moorii*, a fish measuring only 110 mm., the eggs filling the mouth and pharynx measure 4 mm. in diameter and are only four in number, they being proportionally the largest Teleostome eggs known. In *Paratilapia pfefferi*, a fish measuring 75 mm., the eggs found in the pharynx were only about a dozen in number, and they measure 2½ mm. in diameter. In *Tilapia dardennii*, which grows to a length of 240 mm., a score of eggs fills the mouth and pharynx, and each measures 5 to 6 mm. in diameter, an enormous size for so small a fish.

Pellegrin has made the interesting observation on *Tilapia galilaea* that while the eggs are developing in the bucco-pharyngeal cavity the ovarian eggs are rapidly growing towards maturity, so that a fresh deposition of ova may almost immediately follow the release of the young fishes from maternal care. (G. A. B.)

CICISBEO (Ital., of uncertain origin; perhaps an inversion of *bel cece*, "beautiful chick (pea)," or from Fr. *chiche beau*, with same meaning), the term in Italy from the 17th century onwards for a dangler about women. The cicisbeo was the professed gallant of a married woman, who attended her at all public entertainments, it being considered unfashionable for the husband to be escort.

CICOGNARA, LEOPOLDO, COUNT (1767-1834), Italian archaeologist and writer on art, was born at Ferrara on the 17th of November 1767. Mathematical and physical science diverted him a while; but his bent was decided, and not even the notice of such men as Spallanzani and Scarpa could make a savant of him. A residence of some years at Rome, devoted to painting

and the study of the antiquities and galleries of the Eternal City, was followed by a visit to Naples and Sicily, and by the publication, at Palermo, of his first work, a poem of no merit. The island explored, he betook himself to Florence, Milan, Bologna and Venice, acquiring a complete archaeological knowledge of these and other cities. In 1795 he took up his abode at Modena, and was for twelve years engaged in politics, becoming a member of the legislative body, a councillor of state, and minister plenipotentiary of the Cisalpine Republic at Turin. Napoleon decorated him with the Iron Crown; and in 1808 he was made president of the Academy of the Fine Arts at Venice, a post in which he did good work for a number of years. In 1808 appeared his treatise *Del bello ragionamenti*, dedicated in glowing terms to Napoleon. This was followed (1813-1818) by his *magnum opus*, the *Storia della scultura dal suo risorgimento in Italia al secolo di Napoleone*, in the composition of which he had been encouraged and advised by Giordano and Wilhelm Schlegel (1767-1845). The book was designed to complete the works of Winckelmann and D'Agincourt, and is illustrated with 180 plates in outline. In 1814, on the fall of Napoleon, Cicognara was patronized by Francis I. of Austria, and published (1815-1820), under the auspices of that sovereign, his *Fabbriche più cospicue di Venezia*, two superb folios, containing some 150 plates. Charged by the Venetians with the presentation of their gifts to the empress Caroline at Vienna, Cicognara added to the offering an illustrated catalogue of the objects it comprised; this book, *Omaggio delle Provincie Venete alla maestà di Carolina Augusta*, has since become of great value to the bibliophile. Reduced to poverty by these splendid editorial speculations, Cicognara contrived to alienate the imperial favour by his political opinions. He left Venice for Rome; his library was offered for sale; and in 1821 he published at Pisa a *catalogue raisonné*, rich in bibliographical lore, of this fine collection, the result of thirty years of loving labour, which in 1824 was purchased *en bloc* by Pope Leo XII., and added to the Vatican library. The other works of Cicognara are—the *Memorie storiche de' litterati ed artisti Ferraresi* (1811); the *Vite de' più insigni pittori e scultori Ferraresi*, MS.; the *Memorie spettanti alla storia della calcografia* (1831); and a large number of dissertations on painting, sculpture, engraving and other kindred subjects. (See Papoli, in No. 11 of the *Exile*, a print written and published by Italian refugees.) Cicognara's work in the academy at Venice, of which he became president in 1808, had important results in the increase in number of the professors, the improvement in the courses of study, the institution of prizes, and the foundation of a gallery for the reception of Venetian pictures. He died on the 5th of March 1834.

See Zanetti, *Cenni biografici di Leopoldo Cicognara* (Venice, 1834); Malmani, *Memorie del conte Leopoldo Cicognara* (Venice, 1888).

CID, THE, the favourite hero of Spain, and the most prominent figure in her literature. The name, however, is so obscured by myth and fable as scarcely to belong to history. So extravagant are the deeds ascribed to him, and so marvellous the attributes with which he has been clothed by the fond idolatry of his countrymen, that by some he has been classed with the Amadis and the Orlando whose exploits he emulated. The Jesuit Masdeu stoutly denies that he had any real existence, and this heresy has not wanted followers even in Spain. The truth of the matter, however, has been expressed by Cervantes, through the mouth of the Canon in *Don Quixote*: "There is no doubt there was such a man as the Cid, but much doubt whether he achieved what is attributed to him." The researches of Professor Dozy, of Leiden, have amply confirmed this opinion. There is a Cid of history and a Cid of romance, differing very materially in character, but each filling a large space in the annals of his country, and exerting a singular influence in the development of the national genius.

The Cid of history, though falling short of the poetical ideal which the patriotism of his countrymen has so long cherished, is still the foremost man of the heroic period of Spain—the greatest warrior produced out of the long struggle between Christian and Moslem, and the perfect type of the Castilian of the 12th century. Rodrigo Diaz, called de Bivar, from the place

of his birth, better known by the title given him by the Arabs as the *Cid* (*El Seid*, the lord), and *El Campeador*, the champion *par excellence*, was of a noble family, one of whose members in a former generation had been elected judge of Castile. The date of his birth cannot be fixed with any certainty, but it was probably between 1030 and 1040. As Rodrigo Diaz de Vivar he is first mentioned in a charter of Ferdinand I. of the year 1064. The legends which speak of the Cid as accompanying this monarch in his expeditions to France and Italy must be rejected as purely apocryphal. Ferdinand, a great and wise prince, under whom the tide of Moslem conquest was first effectually stemmed, on his deathbed, in 1065, divided his territories among his five children. Castile was left to his eldest son Sancho, Leon to Alphonso, Galicia to Garcia, Zamora and Toro to his two daughters Urraca and Elvira. The extinction of the western caliphate and the dispersion of the once noble heritage of the Ommayyads into numerous petty independent states, had taken place some thirty years previously, so that Castilian and Moslem were once again upon equal terms, the country being almost equally divided between them. On both sides was civil war, urged as fiercely as that against the common enemy, in which the parties sought allies indiscriminately among Christians and Mahomedans.

No condition of affairs could be more favourable to the genius of the Cid. He rose to great distinction in the war between Sancho of Castile and Sancho of Navarre, in which he won his name of *Campeador*, by slaying the enemy's champion in single combat. In the quarrel between Sancho and his brother Alphonso, Rodrigo Diaz espoused the cause of the former, and it was he who suggested the perfidious stratagem by which Sancho eventually obtained the victory and possession of Leon. Sancho having been slain in 1072, while engaged in the siege of Zamora, Alphonso returned from exile and occupied the vacant throne. One of the most striking of the passages in the Cid's legendary history is that wherein he is represented as forcing the new king to swear that he had no part in his brother's death; but there was cause enough without this for Alphonso's animosity against the man who had helped to despoil him of his patrimony. For a time the Cid, already renowned throughout Spain for his prowess in war, was even advanced by the king's favour and entrusted with high commissions of state. In 1074 the Cid was wedded to Ximena, daughter of the count of Oviedo, and granddaughter, by the mother's side, of Alphonso V. The original deed of the marriage-contract is extant. Some time afterwards the Cid was sent on an embassy to collect tribute from Motamid, the king of Seville, whom he found engaged in a war with Abdallah, the king of Granada. On Abdallah's side were many Castilian knights, among them Count Garcia Ordoñez, a prince of the blood, whom the Cid endeavoured vainly to persuade of the disloyalty of opposing their master's ally. In the battle which ensued under the walls of Seville, Abdallah and his auxiliaries were routed with great slaughter, the Cid returning to Burgos with many prisoners and a rich booty. There fresh proofs of his prowess only served to kindle against him the rancour of his enemies and the jealousy of the king. Garcia Ordoñez accused him to Alphonso of keeping back part of the tribute received from Seville, and the king took advantage of the Cid's absence on a raid against the Moors to banish him from Castile.

Henceforth Rodrigo Diaz began to live that life of a soldier of fortune which has made him famous, sometimes fighting under the Christian banner, sometimes under Moorish, but always for his own hand. At the head of a band of 300 free lances he offered his services first to the count of Barcelona; then, failing him, to Moktadir, the Arab king of Saragossa, of the race of the Beni Houd. Under Moktadir, and his successors Moutamin and Mostain, the Cid remained for nearly eight years, fighting their battles against Mahomedan and Christian, when not engaged upon his own, and being admitted almost to a share of their royal authority. He made more than one attempt to be reconciled with Alphonso, but, his overtures being rejected, he turned his arms against the enemies of the Beni Houd, extending their dominions at the expense of the Christian states

of Aragon and Barcelona, and harrying even the border lands of Castile. Among the enterprises of the Cid the most famous was that against Valencia, then the richest and most flourishing city of the peninsula, and an object of cupidity to both Christian and Moslem. The Cid appeared before the place at the head of an army of 7000 men, for the greater part Mahomedans. In vain did the Valencians implore succour from the emir of Cordova, and from their co-religionists in other parts of the peninsula. In defiance of an army which marched to the relief of the beleaguered city under Yusef the Almoravide, the Cid took Valencia after a siege of nine months, on the 15th of June 1094—the richest prize which up to that time had been recovered from the Moors. The conditions of the surrender were all violated—the *cadi* Ibn Djahhaff burnt alive, a vast number of the citizens who had escaped death by famine slaughtered, and the possessions divided among the Campeador's companions. In other respects the Cid appears to have used his victory mildly, ruling his kingdom, which now embraced nearly the whole of Valencia and Murcia, for four years with vigour and justice. At length the Almoravides, whom he had several times beaten, marched against him in great force, inflicting a crushing defeat at Cuenca upon the Cid's army, under his favourite lieutenant, Alvar Fanez. The blow was a fatal one to the aged and war-worn Campeador, who died of anger and grief in July 1099. His widow maintained Valencia for three years longer against the Moors, but was at last compelled to evacuate the city, taking with her the body of the Cid to be buried in the monastery of San Pedro at Cardeña, in the neighbourhood of Burgos. Here, in the centre of a small chapel, surrounded by his chief companions in arms, by Alvar Fanez Minaya, Pero Bermudez, Martin Antolinez and Pelaez the Asturian, were placed the remains of the mighty warrior, the truest of Spanish heroes, the embodiment of all the national virtues and most of the national vices. The bones have since been removed to the town hall of Burgos. Philip II. tried to get him canonized, but Rome objected, and not without reason.

Whatever were his qualities as a fighter, the Cid was but indifferent material out of which to make a saint,—a man who battled against Christian and against Moslem with equal zeal, who burnt churches and mosques with equal zest, who ravaged, plundered and slew as much for a livelihood as for any patriotic or religious purpose, and was in truth almost as much of a Mussulman as a Christian in his habits and his character. His true place in history is that of the greatest of the *guerrilleros*—the perfect type of that sort of warrior in which, from the days of Viriathus to those of Juan Diaz, El Empecinado, the soil of Spain has been most productive.

The Cid of romance, the Cid of a thousand battles, legends and dramas, the Cid as apotheosized in literature, the Cid invoked by good Spaniards in every national crisis, whose name is a perpetual and ever-present inspiration to Spanish patriotism, is a very different character from the historical Rodrigo Diaz—the freebooter, the rebel, the consorter with the infidels and the enemies of Spain. He is the Perfect One, the Born in a Happy Hour, "My Cid," the invincible, the magnanimous, the all-powerful. He is the type of knightly virtue, the mirror of patriotic duty, the flower of all Christian grace. He is Roland and Bayard in one. In the popular literature of Spain he holds a place such as has no parallel in other countries. From an almost contemporary period he has been the subject of song; and he who was chanted by wandering minstrels in the 12th century has survived to be hymned in revolutionary odes of the 19th. In a barbarous Latin poem, written in celebration of the conquest of Almeria by Alphonso VII. in the year 1147, we have the bard testifying to the supereminence of the Cid among his country's heroes:—

"Ipse Rodericus Mio Cid semper vocatus,
De quo cantatur quod ab hostibus haud superatus,
Qui domuit Mauros, comites domuit quoque nostros."

Within a hundred years of his death the Cid had become the centre of a whole system of myths. The *Poema del Cid*, written in the latter half of the 12th century, has scarcely any

trace of a historical character. Already the Cid had reached his apotheosis, and Castilian loyalty could not consent to degrade him when banished by his sovereign:—

"Dios, que buen vassalo si oviese buen señor!"
cry the weeping citizens of Burgos, as they speed the exile on his way.

The Poem of the Cid is but a fragment of 3744 lines, written in a barbarous style, in rugged assonant rhymes, and a rude Alexandrine measure, but it glows with the pure fire of poetry, and is full of a noble simplicity and a true epical grandeur, invaluable as a living picture of the age. The ballads relating to the Cid, of which nearly two hundred are extant, are greatly inferior in merit, though some of them are not unworthy to be ranked with the best in this kind. Duran believes the greater part of them to have been written in the 16th century. A few betray, not more by the antiquity of their language than by their natural and simple tone, traces of an earlier age and a freer national life. They all take great liberties with history, thus belying the opinion of Sancho Panza that "the ballads are too old to tell lies." Such of them as are not genuine relics of the 12th century are either poetical versions of the leading episodes in the hero's life as contained in the *Chronicle*, that *Chronicle* itself having been doubtless composed out of still earlier legends as sung by the wandering *juglares*, or pure inventions of a later time, owing their inspiration to the romances of chivalry. In these last the ballad-mongers, not to let their native hero be outdone by the Amadises, the Esplandians, and the Felixmarts, engage him in the most extravagant adventures—making war upon the king of France and upon the emperor, receiving embassies from the sultan of Persia, bearding the pope at Rome, and performing other feats not mentioned even in the Poem or the *Chronicle*. The last and the worst of the Cid ballads are those which betray by their frigid conceits and feeble mimicry of the antique the false taste and essentially unheroic spirit of the age of Philip II. As for the innumerable other poems, dramas and tales which have been founded on the legend of the Cid, from the days of Guillen de Castro and Diamante to those of Quintana and Trueba, they serve merely to prove the abiding popularity of the national hero in his native land.

The chief sources from which the story of the Cid is to be gathered are, first, the Latin chronicle discovered by Risco in the convent of San Isidro at Leon, proved by internal evidence to have been written before 1258; the *Cronica General*, composed by Alphonso X. in the second half of the 13th century, partly (so far as relates to the Cid) from the above, partly from contemporary Arabic histories, and partly from tradition; the *Cronica del Cid*, first published in 1512, by Juan de Velorado, abbot of the monastery of San Pedro at Cardeña, which is a compilation from the last, interlarded with new fictions due to the piety of the compiler; lastly, various Arabic manuscripts, some of contemporary date, which are examined and their claims weighed in the second volume of Professor Dozy's *Recherches sur l'histoire politique et littéraire de l'Espagne pendant le moyen âge* (Leiden, 1849). Huber, Müller, and Ferdinand Wolf are among the leading authorities in the history and literature of the Cid. M. Damas Hinard has published the poem, with a literal French translation and notes, and John Hookham Frere has rendered it into English with extraordinary spirit and fidelity. The largest collection of the Cid ballads is that of Durant, in the *Romancero general*, in two volumes, forming part of Rivadeneyra's *Biblioteca de autores españoles*. (H. E. W.)

CIDER, or **CYDER** (from the Fr. *cidre*, derived from the Lat. *sicera* or *cisera*, Gr. *σίκερα*, Heb. *shēkār*, strong drink), an alcoholic beverage made from apples.

Cider and perry (the corresponding beverage made from pears) are liquors containing from as little as 2% of alcohol to 7 or 8%, seldom more, and rarely as much, produced by the vinous fermentation of the expressed juice of apples and pears; but cider and perry of prime quality can only be obtained from vintage fruit, that is, apples and pears grown for the purpose and unsuited for the most part for table use. A few table apples make good cider, but the best perry is only to be procured from pears too harsh and astringent for consumption in any other form. The making of perry is in England confined, in the main, to the counties of Hereford, Worcester and Gloucester. These three counties, together with Somerset and Devon, constitute, too, the principal cider-making district of the country; but the

industry, which was once more widely spread, still survives in Norfolk, and has lately been revived in Kent, though, in both these counties, much of the fruit used in cider-making is imported from the west country and some from the continent. Speaking generally, the cider of Herefordshire is distinguished for its lightness and briskness, that of Somerset for its strength, and that of Devonshire for its lusciousness.

Cider used to be made in the south of Ireland, but the industry had almost become extinct until revived by the Department of Agriculture, which in 1904 erected a cider-making plant at Drogheda, Co. Louth, gave assistance to private firms at Dungan, Co. Waterford, and Fermoy, Co. Cork, and provided a travelling mill and press to work in the South Riding of Co. Tipperary. The results have been highly satisfactory, a large quantity of good cider having been produced.

Inasmuch as English orchards are crowded with innumerable varieties of cider apples, many of them worthless, a committee composed of members of the Herefordshire Fruit-Growers' Association and of the Fruit and Chrysanthemum Society was appointed in 1899 to make a selection of vintage apples and pears best suited to Herefordshire and the districts adjoining. The following is the list drawn up by the committee:—

Apples.—Old Foxwhelp, Cherry Pearmain, Cowarne Red, Dymock Red, Eggleton Styre, Kingston Black or Black Taunton, Skyrme's Kernel, Spreading Redstreak, Carrion Apple, Cherry Norman, Cummy Norman, Royal Wilding, Handsome Norman, Strawberry Norman, White Bache or Norman, Broad-leaved Norman, Argile Grise, Bramtôt, De Boutville, Fréquin Audièvre, Médaille d'Or, the last five being French sorts introduced from Normandy about 1880, and now established in the orchards of Herefordshire.

Pears.—Taynton Squash, Barland, Oldfield, Moorcroft or Malvern Hill, Red-pear, Thurston's Red, Longland, Pine pear.

No equally authoritative selection has been made for the Somerset and Devon districts, but the following varieties of cider apples are held in good repute in those parts:—Kingston Black, Jersey Chisel, Hangdowns, Fair Maid of Devon, Woodbine, Duck's Bill, Slack-my-Girdle, Bottle Stopper, Golden Ball, Sugar-loaf, Red Cluster, Royal Somerset and Cadbury (believed to be identical with the Royal Wilding of Herefordshire). As a rule the best cider apples are of small size. "Petites pommes, gros cidre," say the French.

Cider and perry not being taxable liquors in England, it is impossible to estimate with even an approach to accuracy the amount of the annual production of them. In 1896 Mr Sampson, the then secretary of the National Association of English Cider-makers, in his evidence before the royal commission on agriculture, put it at 55½ million gallons. Since that date the increased demand for these native wines has given such an impetus to the industry that this figure might with safety be doubled. In France official statistics are available, and these show not only that that country is the largest producer of cider (including perry) in the world, but that the output is yearly increasing. A great proportion, however, of what passes as cider in France is *boisson*, i.e. cider to which water has been added in the process of making or at a subsequent stage; while much of the perry is disposed of to the makers of champagne. Although some cider is made in sixty-five departments, by far the largest amount comes from the provinces of Normandy and Brittany. In Germany cider-making is a considerable and growing industry. Manufactories on a small scale exist in north Germany, as at Guben and Grünberg, but the centre of the industry is at Frankfort-on-Main, Sachsenhausen and the neighbourhood, where there are five large and twenty-five small factories employing upwards of 1000 hands. Large quantities of cider fruit are imported from foreign countries, as, speaking generally, the native-grown fruit used in Germany for cider-making consists of inferior and undersized table apples not worth marketing. The bottled cider for export is treated much like champagne, and is usually fortified and flavoured until, in the words of an acknowledged French authority, M. Truelle, it becomes a hybrid between cider and white wine rather than pure cider

The practice which formerly prevailed in England of making cider on the farm from the produce of the home orchards has within the last few years been to a large extent given up, and, as in Germany and many parts of France, farmers now sell their fruit to owners of factories where the making of cider and perry is carried on as a business of itself. In these hand or horse power is superseded by steam and sometimes by electricity, as in the factory of E. Seigel in Grünberg, and the old-fashioned appliances of the farm by modern mills and presses capable of turning out large quantities of liquor. The clearing of the juice, too, which used to be effected by running it through bags, is in the factories accomplished more quickly by forcing it through layers of compressed cotton in a machine of German origin known as Lumley's filter. The actual process of cider and perry making is simple, and resembles that of making grape wine. The fruit is ground or crushed in machines of various construction, the latest and most powerful being of American origin. The resulting pomace is pressed for the extraction of the juice, which is then run into vats, where it undergoes fermentation, which, converting the saccharine ingredients into alcohol and carbonic acid gas, turns it into cider. Cider made from a judicious mixture of several varieties of apples is to be preferred to cider made from one variety only, inasmuch as it is less difficult to find the requisite degrees of richness, astringency and flavour in several varieties than in one; but the contrary is the case with pears, of which the most noted sorts, such as the Barland, the Taynton Squash and the Oldfield, produce the best perry when unmixed with other varieties. Some fining of an albuminous nature is generally requisite in order to clear the juice and facilitate its passage through the filter, but the less used the better. The simplest and cleanest is skim milk whipped to a froth and blended gradually with the cider as it is pumped into the mixing vat. Many nostrums are sold for the clearing of cider, but none is necessary and most are harmful.

Of late years the practice has largely obtained of using preservatives for the purpose of checking fermentation. The principal preservatives employed are salicylic and boracic acids and formalin. The two former are ineffective except in quantities likely to prove hurtful to health, while formalin, in itself a powerful and deleterious drug, though it stops fermentation, renders the liquor cloudy and undrinkable. Other foreign ingredients, such as saccharin and porcherine, both coal-tar derivatives—the latter a recent discovery of a French chemist, after whom it is named—are used by many makers, chiefly for the purpose of rendering bad and therefore unwholesome cider palatable and saleable. Provided that cider and perry be properly filtered, and attention paid to perfect cleanliness of vessels and appliances, there is no need of preservatives or sweeteners, and their use ought to be forbidden by law in England, as it is in most continental states in the case of liquors to be consumed within their borders, though not, it is significant to note, in the case of liquors intended for exportation.

The wholesome properties of cider and perry when pure and unadulterated have been recognized by medical men, who recommend them as pleasant and efficacious remedies in affections of a gouty or rheumatic nature, maladies which, strange to say, these very liquors were once supposed to foster, if not actually to originate. Under a similar false impression the notion is general that hard rough cider is apt to cause diarrhoea, colic and kindred complaints, whereas, as a fact, disorders of this kind are conspicuous by their absence in those parts of the country where rough cider and perry constitute the staple drinks of the working-classes. This is especially the case in Herefordshire, which is said also to be the only county in England whence no instance of the occurrence of Asiatic cholera has ever been reported.

The importance which the cider industry has of late attained in England has been marked by the establishment of the National Fruit and Cider Institute at Long Ashton near Bristol. This institute, founded in 1903 at the instance of the Board of Agriculture, is supported by grants from the board, the Bath and West of England Society, the councils of the cider-producing

counties of Hereford, Gloucester, Worcester, Monmouth, Devon and Somerset, and by subscription of members. The objects of the institute are the promotion of research into the causes of the changes which occur in cider and perry during fermentation, with the view of imparting to these liquors a degree of exactitude hitherto unattainable; the adoption from time to time of improved machinery and methods in cider-making; the detection of adulteration; the giving of instruction in the principles and practice of cider-making; the publication of reports detailing the results of the researches undertaken at the institute; the testing and selection of the sorts of fruit best suited for vintage purposes; the propagation of useful varieties likely from neglect to go out of cultivation; and the conducting of experiments in regard to the best systems of planting and protecting young fruit trees.

Fruit-growers who look to cider-making "as a means of utilizing windfalls and small and inferior apples of cooking and dessert varieties not worth sending to market" should be warned that it is as important to the cider industry that good cider only should be on sale as it is to the fruit-growing industry that good fruit only should be sent to market. The juice of the apple is naturally affected by the condition of the fruit itself, and if this be unripe, unsound or worm-eaten the cider made from it will be inferior to that made from full-grown, ripe and sound fruit. If such fruit be not good enough to send to market, neither will the cider made from it be good enough to place before the public. Nevertheless, it may furnish a sufficiently palatable drink for home consumption, and may therefore be so utilized. But when, as happens from time to time in fruit-growing districts, there is a glut, and even the best table fruit is not saleable at a profit, then, indeed, cider-making is a means of storing in a liquid form what would otherwise be left to rot on the ground; whilst if a proportion of vintage fruit were mixed therewith, a drink would be produced which would not discredit the cider trade, and would bring a fair return to the maker. (C. W. R. C.)

CIENFUEGOS, NICASIO ÁLVAREZ DE (1764-1809), Spanish poet and publicist, was born at Madrid on the 14th of December 1764. He studied with distinction at Salamanca, where he met the poet Melendez Valdés. His poems, published in 1778, immediately attracted attention. He was successively editor of the *Gaceta* and *Mercurio*, and was condemned to death for having published an article against Napoleon; on the petition of his friends, he was respited and deported to France; he died at Orthez early in the following year. His verses are modelled on those of Melendez Valdés; though not deficient in technique or passion, they are often disfigured by spurious sentimentality and by the flimsy philosophy of the age. Cienfuegos was blamed for an unsparing use of both archaisms and gallicisms. His plays, *Pilaco*, *Zoraida*, *La Condesa de Castilla* and *Idomeneo*, four tragedies on the pseudo-classic French model, and *Las Hermanas generosas*, a comedy, are deservedly forgotten.

CIENFUEGOS (originally FERNANDINA DE JAGUA), one of the principal cities of Cuba, in Santa Clara province, near the central portion of the S. coast, 195 m. E.S.E. of Havana. Pop. (1907) 30,100. Cienfuegos is served by the United Railways and by steamers connecting with Santiago, Batabanó, Trinidad and the Isle of Pines. It lies about 6 m. from the sea on a peninsula in the magnificent landlocked bay of Jagua. Vessels drawing 16 ft. have direct access to the wharves. A circular railway about the water-front, wharves and warehouses facilitates the loading and unloading of vessels. The city streets are broad and regularly laid out. There is a handsome cathedral; and the Tomas Terry theatre (given to the city by the heirs of one of the millionaire sugar planters of the jurisdiction), the governor's house (1841-1844), the military and government hospitals, market place and railway station are worthy of note. In the Cathedral Square (Plaza de Armas), embracing two city-squares, and shaded—like all the plazas of the island—with laurels and royal palms, are a statue of Isabel the Catholic, and two marble lions given by Queen Isabel II.; elsewhere there are statues of General Clouet and Marshal Serrano, once captain-general. The city is lighted by gas and electricity, has an

abundant water-supply, and cable connexion with Europe, the United States, other Antilles and South America. The surrounding country is one of the prettiest and most fertile regions in Cuba, varied with woods, rivers, rocky gulches, beautiful cascades and charming tropic vegetation. Several of the largest and finest sugar estates in the world are situated in the vicinity, including the Soledad (with a botanical experiment station maintained by Harvard University), the Terry and others—most of them connected with the city by good drive-ways. Cienfuegos is a centre of the sugar trade on the south coast; tobacco too is exported.

The bay of Jagua was visited by Columbus. The city was founded in 1819, with the aid of the Spanish government, by a Louisianian, General Luis de Clouet; it was destroyed by a hurricane and was rebuilt in 1825. Many naturalized foreign Catholics, including Americans, were among the original settlers. The settlement was first named in honour of Ferdinand VII., and later in honour of Captain-General José Cienfuegos Jovelanos. The harbour was known from the earliest times, and has been declared by Mahan to be the most important of the Caribbean Sea for strategic purposes. In 1740-1745 a fortification called Nuestra Señora de los Angeles was erected at the entrance; it is still standing, on a steep bluff overlooking the sea, and is one of the most picturesque of the old fortifications of the island. On the 11th of May 1898 a force from two vessels of the United States fleet under Admiral Schley, searching for Cervera and blockading the port, cut two of the three cables here (at Point Colorado, at the entrance of the harbour), and for the first time in the Spanish-American War the American troops were under fire.

CIENZA, a town of south-eastern Spain, in the province of Murcia, on the right bank of the river Segura, and on the Madrid-Cartagena railway. Pop. (1900) 13,626. Cieza is built in a narrow bend of the Segura valley, which is enclosed on the north by mountains, and on the south broadens into a fertile plain, producing grain, wine, olives, raisins, oranges and esparto grass. In the town itself there are flour and paper mills, sawmills and brandy distilleries. Between 1870 and 1900 local trade and population increased rapidly, owing partly to improved means of communication; and the appearance of Cieza is thoroughly modern.

CIGAR, the common term for tobacco-leaf prepared for smoking by being rolled into a short cylinder tapering to a point at the end which is placed in the mouth, the other end, which is lighted, being usually cut square (see TOBACCO). The Spanish *cigarro* is of doubtful origin, possibly connected with *cigarra*, a cicada, from its resemblance to the body of that insect, or with *cigarral*, a word of Arabic origin meaning a pleasure garden. The explanation that it comes from a Cuban word for a certain species of tobacco is probably erroneous, since no native word of the kind is known. The diminutive, *cigarette*, denotes a roll of cut tobacco enclosed usually in thin paper, but sometimes also in tobacco-leaf or the husk of Indian corn.

CIGNANI, CARLO (1628-1719), Italian painter, was born of a noble family at Bologna, where he studied under Battista Cairo, and afterwards under Francesco Albani. Though an intimate friend of the latter, and his most famous disciple, Cignani was yet strongly and deeply influenced by the genius of Correggio. His greatest work, moreover, the "Assumption of the Virgin," round the cupola of the church of the Madonna della Fuoca at Forlì, which occupied him some twenty years, and is in some respects one of the most remarkable works of art of the 17th century, is obviously inspired from the more renowned fresco of Correggio in the cupola of the cathedral of Parma. Cignani had some of the defects of his masters; his elaborate finish, his audacious artificiality in the use of colour and in composition, mark the disciple of Albani; but he imparted to his work a more intellectual character than either of his models, and is not without other remarkable merits of his own. As a man Cignani was eminently amiable, unassuming and generous. His success, however, made him many enemies; and the envy of some of these is said to have impelled them to deface certain of his works.

He accepted none of the honours offered him by the duke of Parma and other princes, but lived and died an artist. On his removal to Forli, where he died, the school he had founded at Bologna was fain in some sort to follow its master. His most famous pictures, in addition to the Assumption already cited, are—the "Entry of Paul III. into Bologna"; the "François I. Touching for King's Evil"; a "Power of Love," painted under a fine ceiling by Agostino Carracci, on the walls of a room in the ducal palace at Parma; an "Adam and Eve" (at the Hague); and two of "Joseph and Potiphar's Wife" (at Dresden and Copenhagen). His son Felice (1660-1724) and nephew Paolo (1709-1764) were also painters.

CIGOLI (or **CRVOLI**), **LODOVICO CARDI DA** (1559-1613), Italian painter, architect and poet, was born at Cigoli in Tuscany. Educated under Alessandro Allori and Santi di Tito, he formed a peculiar style by the study at Florence of Michelangelo, Correggio, Andrea del Sarto and Pontormo. Assimilating more of the second of these masters than of all the others, he laboured for some years with success; but the attacks of his enemies, and intense application to the production of a wax model of certain anatomical preparations, induced an alienation of mind which affected him for three years. At the end of this period he visited Lombardy, whence he returned to Florence. There he painted an "Ecce Homo," in competition with Passignani and Caravaggio, which gained the prize. This work was afterwards taken by Bonaparte to the Louvre, and was restored to Florence in 1815. Other important pictures are—a "St Peter Healing the Lame Man," in St Peter's at Rome; a "Conversion of St Paul," in the church of San Paolo fuori le Mura, and a "Story of Psyche," in fresco, at the Villa Borghese; a "Martyrdom of Stephen," which earned him the name of the Florentine Correggio, a "Venus and Satyr," a "Sacrifice of Isaac," a "Stigmata of St Francis," at Florence. Cigoli, who was made a knight of Malta at the request of Pope Paul III., was a good and solid draughtsman and the possessor of a rich and harmonious palette. He died, it is said, of grief at the failure of his last fresco (in the Roman church of Santa Maria Maggiore), which is rendered ridiculous by an abuse of perspective.

CILIA (plural of Lat. *cilium*, eyelash), in biology, the thread-like processes by the vibration of which many lowly organisms, or the male reproductive cells of higher organisms, move through water.

CILIATA (M. Pertz), one of the two divisions of Infusoria, characterized by the permanent possession of cilia or organs derived from these (cirrhi, membranelles, &c.), and possessing a single mouth (except in the *Opalinopsisidae*, all parasitic). They are the most highly differentiated among the Protozoa.

CILICIA, in ancient geography, a district of Asia Minor, extending along the south coast from the Alara Su, which separated it from Pamphylia, to the Giaour Dagh (Mt. Amanus), which parted it from Syria. Its northern limit was the crest of Mt. Taurus. It was naturally divided into Cilicia Trachea, W. of the Lamas Su, and Cilicia Pedias, E. of that river.

Cilicia Trachea is a rugged mountain district formed by the spurs of Taurus, which often terminate in rocky headlands with small sheltered harbours,—a feature which, in classical times, made the coast a resort of pirates, and, in the middle ages, led to its occupation by Genoese and Venetian traders. The district is watered by the Geuk Su (Calycadnus and its tributaries), and is covered to a large extent by forests, which still, as of old, supply timber to Egypt and Syria. There were several towns but no large trade centres. In the interior were Coropissus (Da Bazar), Olba (Uzunjaburj), and, in the valley of the Calycadnus, Claudiopolis (Mut) and Germanicopolis (Ermenek). On or near the coast were Coracesium (Alaya). Selinus-Trajanopolis (Selinti), Anemourium (Anamur), Kelenderis (Kilindria), Seleucia ad Calycadnum (Selefkch), Corycus (Korghoz) and Elaëusa-Sebaste (Ayash). Roads connected Laranda, north of the Taurus, with Kelenderis and Seleucia.

Cilicia Pedias included the rugged spurs of Taurus and a large plain, which consists, in great part, of a rich stoneless loam. Its eastern half is studded with isolated rocky crags, which are

crowned with the ruins of ancient strongholds, and broken by the low hills that border the plain of Issus. The plain is watered by the Cydnus (Tarsus Chai), the Sarus (Sihun) and the Pyramus (Jihun), each of which brings down much silt. The Sarus now enters the sea almost due south of Tarsus, but there are clear indications that at one period it joined the Pyramus, and that the united rivers ran to the sea west of Kara-tash. Such appears to have been the case when Alexander's army crossed Cilicia. The plain is extremely productive, though now little cultivated. Through it ran the great highway, between the east and the west, on which stood Tarsus on the Cydnus, Adana on the Sarus, and Mopsuestia (Missis) on the Pyramus. North of the road between the two last places were Sision-Flaviopolis (Sis), Anazarbus (Anazarba) and Hierapolis-Kastabala (Budrum); and on the coast were Soli-Pompeiiopolis, Mallus (Kara-tash), Aegae (Ayash), Issus, Baiae (Piyas) and Alexandria ad Issum (Alexandretta). The great highway from the west, on its long rough descent from the Anatolian plateau to Tarsus, ran through a narrow pass between walls of rock called the Cilician Gate, Ghulek Boghaz. After crossing the low hills east of the Pyramus it passed through a masonry (Cilician) gate, Demir Kapu, and entered the plain of Issus. From that plain one road ran southward through a masonry (Syrian) gate to Alexandretta, and thence crossed Mt. Amanus by the Syrian Gate, Beilan Pass, to Antioch and Syria; and another ran northwards through a masonry (Amanian) gate, south of Toprak Kaleh, and crossed Mt. Amanus by the Amanian Gate, Baghche Pass, to North Syria and the Euphrates. By the last pass, which was apparently unknown to Alexander, Darius crossed the mountains prior to the battle of Issus. Both passes are short and easy, and connect Cilicia Pedias geographically and politically with Syria rather than with Asia Minor. Another important road connected Sision with Cocycus and Melitene. In Roman times Cilicia exported the goats' hair cloth, Cilicium, of which tents were made.

The Cilicians appear as Khilikku in Assyrian inscriptions, and in the early part of the first millennium B.C. were one of the four chief powers of western Asia. It is generally assumed that they had previously been subject to the Syro-Cappadocian empire; but, up to 1909 at all events, "Hittite" monuments had not been found in Cilicia; and we must infer that the "Hittite" civilizations which flourished in Cappadocia and N. Syria, communicated with each other by passes E. of Amanus and not by the Cilician Gates. Under the Persian empire Cilicia was apparently governed by tributary native kings, who bore a name or title graecized as Syennesis; but it was officially included in the fourth satrapy by Darius. Xenophon found a queen in power, and no opposition was offered to the march of Cyrus. Similarly Alexander found the Gates open, when he came down from the plateau in 333 B.C.; and from these facts it may be inferred that the great pass was not under direct Persian control, but under that of a vassal power always ready to turn against its suzerain. After Alexander's death it was long a battle ground of rival marshals and kings, and for a time fell under Ptolemaic dominion, but finally under that of the Seleucids, who, however, never held effectually more than the eastern half. Cilicia Trachea became the haunt of pirates, who were subdued by Pompey. Cilicia Pedias became Roman territory in 103 B.C., and the whole was organized by Pompey, 64 B.C., into a province which, for a short time, extended to and included part of Phrygia. It was reorganized by Caesar, 47 B.C., and about 27 B.C. became part of the province Syria-Cilicia-Phoenice. At first the western district was left independent under native kings or priest-dynasts, and a small kingdom, under Tarkondimotus, was left in the east; but these were finally united to the province by Vespasian, A.D. 74. Under Diocletian (circa 297), Cilicia, with the Syrian and Egyptian provinces, formed the Diocesis Orientis. In the 7th century it was invaded by the Arabs, who held the country until it was reoccupied by Nicephorus II. in 965.

The Seljuk invasion of Armenia was followed by an exodus of Armenians southwards, and in 1080 Rhupen, a relative of the last king of Ani, founded in the heart of the Cilician Taurus a small

principality, which gradually expanded into the kingdom of Lesser Armenia. This Christian kingdom—situated in the midst of Moslem states, hostile to the Byzantines, giving valuable support to the crusaders, and trading with the great commercial cities of Italy—had a stormy existence of about 300 years. Gosdantin I. (1095–1100) assisted the crusaders on their march to Antioch, and was created knight and marquis. Thoros I. (1100–1123), in alliance with the Christian princes of Syria, waged successful war against Byzantines and Seljuks. Levond (Leo) II., "the Great" (1185–1219), extended the kingdom beyond Mount Taurus and established the capital at Sis. He assisted the crusaders, was crowned king by the archbishop of Mainz, and married one of the Lusignans of Cyprus. Haithon I. (1224–1269) made an alliance with the Mongols, who, before their adoption of Islam, protected his kingdom from the Mamelukes of Egypt. When Levond V. died (1342), John of Lusignan was crowned king as Gosdantin IV.; but he and his successors alienated the Armenians by attempting to make them conform to the Roman Church, and by giving all posts of honour to Latins, and at last the kingdom, a prey to internal dissensions, succumbed (1375) to the attacks of the Egyptians. Cilicia Trachea was occupied by the Osmanlis in the 15th century, but Cilicia Pedias was only added to the empire in 1515.

From 1833 to 1849 Cilicia formed part of the territories administered by Mehemet Ali of Cairo, who was compelled to evacuate it by the allied powers. Since that date it has formed the vilayet of Adana (q.v.).

BIBLIOGRAPHY.—Beside the general authorities for ASIA MINOR, see:—W. B. Barker, *Lares and Penates* (1853); V. Langlois, *Voyage dans la Cilicie* (1861); F. Beaufort, *Karamania* (1817); W. F. Ainsworth, *Narrative of the Euphrates Expedition* (1888), and *Travels in Asia Minor* (1842); R. Heberdey and A. Wilhelm, *Reisen in Kilikien* (1896); D. G. Hogarth and J. A. R. Munro, *Mod. and Anc. Roads in E. Asia Minor* (R. G. S. Supp. Papers, iii.) (1893); D. G. Hogarth, *A Wandering Scholar* (1896); G. L. Schlumberger, *Un Empereur byzantin* (1890); T. Kotschy, *Reise in dem cilicischen Taurus* (1858); H. C. Barkley, *Ride through Asia Minor and Armenia* (1891); E. J. Davis, *Life in Asiatic Turkey* (1879); J. Marquardt, *Röm. Staatsverwaltung*, i. (1874); J. R. S. Sterrett, *Wolfe Expedition* (1888). See also authorities under ARMENIA and MEHEMET ALI. (C. W. W.; D. G. H.)

CILLI, ULRICH, COUNT OF (1406–1456), son of Frederick II., count of Cilli, and Elizabeth Frangepan. Of his youth we know nothing certain. About 1432 he married Catherine, daughter of George Brankovich, despot of Servia.

His influence in the troubled affairs of Hungary and the Empire early overshadowed that of his father, together with whom he was made a prince of the Empire by the emperor Sigismund (1436). Hence feuds with the Habsburgs, wounded in their rights as overlords of Cilli, ending, however, in an alliance with the Habsburg king Albert II., who made Ulrich for a short while his lieutenant in Bohemia. After Albert's death (1439) Ulrich took up the cause of his widow Elizabeth, and presided at the coronation of her infant son Ladislaus V. Posthumus (1440). A feud with the Hunyadis followed, embittered by John Hunyadi's attack on George Brankovich of Servia (1444) and his refusal to recognize Ulrich's claim to Bosnia on the death of Stephen Tvrtko (1443). In 1446 Hunyadi, now governor of Hungary, harried the Cilli territories in Croatia-Slavonia; but his power was broken at Kossovo (1448), and Count Ulrich was able to lead a successful crusade, nominally in the Habsburg interest, into Hungary (1450). In 1452 he forced the emperor Frederick III. to hand over the boy king Ladislaus V. to his keeping, and became thus practically ruler of Hungary. In 1454 his power was increased by his succession to his father's vast wealth; and in 1456 he was named by Ladislaus his lieutenant in Hungary. The Hunyadis now conspired to destroy him. On the 8th of November, in spite of warnings, he entered Belgrade with the king; the next day he was attacked by Laszlo Hunyadi and his friends, and done to death. With him died the male line of the counts of Cilli.

Count Ulrich's ambition was boundless, his passions unbridled; but the hostile judgments passed by Aeneas

Sylvius and other contemporaries upon him must be read with caution.

CILLI (Slovene, *Celje*), a town in Styria, Austria, 82 m. S. by W. of Graz by rail. Pop. (1900) 6743. It is picturesquely situated on the left bank of the river Sann, and still has remains of the old walls and towers, with which it was once surrounded. Memorials of a still earlier period in its history—Roman antiquities—are to be seen in the municipal museum, while its canals and sewers are also of Roman origin. These were discovered during the second half of the 19th century, and were in such a good state of preservation that after a few small repairs they are now utilized. The parish church, dating from the 14th century, with its beautiful Gothic chapel, is one of the most interesting specimens of mediæval architecture. The so-called German church, in Romanesque style, belonged to the Minorite monastery, founded in 1241 and closed in 1808. The throne of the counts of Cilli is preserved here, and also the tombs of several members of the family. On the Schlossberg (1320 ft.), situated to the S.E. of the town, are the ruins of the castle of Ober-Cilli, the former residence of the counts of Cilli. Ten miles to the N.W. of Cilli are situated the baths of Neuhaus, with indifferent thermal waters (117° F.), frequented by ladies. Not far from it is the ruined castle of Neuhaus, called since 1643 Schlangenburg, from which an extensive view of the neighbouring Alps is obtained.

Cilli is one of the oldest places in Styria, and was probably a Celtic settlement. It was taken possession of by the Romans in 15 B.C., and in A.D. 50 the emperor Claudius raised it to a Roman municipium and named it *Claudia Celeja*. It soon became one of the most flourishing Roman colonies, and possessed numerous great buildings, of which the temple of Mars was famous throughout the whole empire. It was incorporated with Aquileia, under Constantine; and towards the end of the 6th century was destroyed by the invading Slavs. It had a period of exceptional prosperity from the middle of the 14th to the latter half of the 15th century, under the counts of Cilli, on the extinction of which family it fell to Austria. In the 16th century it suffered greatly both from revolts of the peasantry and from the Counter-Reformation, Protestantism having made many converts in the district, particularly among the nobles.

See Glantschnigg, *Celeja* (Cilli, 1892).

CIMABUE, GIOVANNI (1240 to about 1302), Italian painter, was born in Florence of a respectable family, which seems to have borne the name of Gualtieri, as well as that of Cimabue (Bullhead). He took to the arts of design by natural inclination, and sought the society of men of learning and accomplishment. Vasari, the historian of Italian painting, zealous for his own native state of Florence, has left us the generally current account of Cimabue, which later researches have to a great extent invalidated. We cannot now accept his assertion that art, extinct in Italy, was revived solely by Cimabue, after he had received some training from Greek artists invited by the Florentine government to paint the chapel of the Gondi in the church of S. Maria Novella; for native Italian art was not then a nullity, and this church was only begun when Cimabue was already forty years old. Even Lanzi's qualifying statement that Greek artists, although they did not paint the chapel of the Gondi, did execute rude decorations in a chapel below the existing church, and may thus have inspired Cimabue, makes little difference in the main facts. What we find as the general upshot is that some Italian painters preceded Cimabue—particularly Guido of Siena and Giunta of Pisa; that he worked on much the same principle as they, and to a like result; but that he was nevertheless the most advanced master of his time, and, by his own works, and the training which he imparted to his mighty pupil Giotto, he left the art far more formed and more capable of growth than he found it (see PAINTING).

The undoubted admiration of his contemporaries would alone demonstrate the conspicuous position which Cimabue held, and deserved to hold. For the chapel of the Rucellai in S. Maria Novella he painted in tempera a colossal "Madonna and Child with Angels," the largest altarpiece produced up to that date;

before its removal from the studio it was visited with admiration by Charles of Anjou, with a host of eminent men and gentle ladies, and it was carried to the church in a festive procession of the people and trumpeters. Cimabue was at this time living in the Borgo Allegri, then outside the walls of Florence; the legend that the name Allegri (Joyous) was bestowed on the locality in consequence of this striking popular display is more attractive than accurate, for the name existed already. Of this celebrated picture, one of the great landmarks of modern and sacred art, some details may be here given, which we condense from the *History of Painting in Italy* by Crowe and Cavalcaselle.

"The Virgin in a red tunic and blue mantle, with her feet resting on an open-worked stool, is sitting on a chair hung with a white drapery flowered in gold and blue, and carried by six angels kneeling in threes above each other. A delicately engraved nimbus surrounds her head, and that of the infant Saviour on her lap, who is dressed in a white tunic, and purple mantle shot with gold. A dark-coloured frame surrounds the gabled square of the picture, delicately traced with an ornament interrupted at intervals by thirty medallions on gold ground, each of which contains the half-figure of a saint. In the face of the Madonna is a soft and melancholy expression; in the form of the infant, a certain freshness, animation and natural proportion; in the group, affection—but too rare at this period. There is sentiment in the attitudes of the angels, energetic mien in some prophets, comparative clearness and soft harmony in the colours. A certain loss of balance is caused by the overweight of the head in the Virgin as compared with the slightness of her frame. The features are the old ones of the 13th century; only softened, as regards the expression of the eye, by an exaggeration of elliptical form in the iris, and closeness of the curves of the lids. In the angels the absence of all true notions of composition may be considered striking; yet their movements are more natural and pleasing than hitherto. One indeed, to the spectator's right of the Virgin, combines more tender reverence in its glance than any that had yet been produced. Cimabue gave to the flesh-tints a clear and carefully fused colour, and imparted to the forms some of the rotundity which they had lost. With him vanished the sharp contrasts of hard lights, half-tones and shadows."

In a general way, it may be said that Cimabue showed himself forcible in his paintings, as especially in heads of aged or strongly characterized men; and, if the then existing development of art had allowed of this, he might have had it in him to express the beautiful as well. He, according to Vasari, was the first painter who wrote words upon his paintings,—as, for instance, round the head of Christ in a picture of the Crucifixion, the words addressed to Mary, *Mulier ecce filius tuus*.

Other paintings still extant by Cimabue are the following:—In the academy of Arts in Florence, a "Madonna and Child," with eight angels, and some prophets in niches,—better than the Rucellai picture in composition and study of nature, but more archaic in type, and the colour now spoiled (this work was painted for the Badia of S. Trinita, Florence); in the National Gallery, London, a "Madonna and Child with Angels," which came from the Ugo Baldi collection, and had probably once been in the church of S. Croce, Florence; in the Louvre, a "Madonna and Child," with twenty-six medallions in the frame, originally in the church of S. Francesco, Pisa. In the lower church of the Basilica of S. Francesco at Assisi, Cimabue, succeeding Giunta da Pisa, probably adorned the south transept,—painting a colossal "Virgin and Child between four Angels," above the altar of the Conception, and a large figure of St Francis. In the upper church, north transept, he has the "Saviour Enthroned and some Angels," and, on the central ceiling of the transept, the "Four Evangelists with Angels." Many other works in both the lower and the upper church have been ascribed to Cimabue, but with very scanty evidence; even the above-named can be assigned to him only as matter of probability. Numerous others which he indisputably did paint have perished,—for instance, a series (earlier in date than the Rucellai picture) in the Carmine church at Padua, which were destroyed by a fire.

From Assisi Cimabue returned to Florence. In the closing years of his life he was appointed capomaestro of the mosaics of the cathedral of Pisa, and was afterwards, hardly a year before his death, joined with Arnolfo di Cambio as architect for the cathedral of Florence. In Pisa he executed a Majesty in the apse,—“Christ in glory between the Virgin and John

the Evangelist,” a mosaic, now much damaged, which stamps him as the leading artist of his time in that material. This was probably the last work that he produced.

The debt which art owes to Cimabue is not limited to his own performances. He was the master of Giotto, whom (such at least is the tradition) he found a shepherd boy of ten, in the pastures of Vespignano, drawing with a coal on a slate the figure of a lamb. Cimabue took him to Florence, and instructed him in the art; and after his death Giotto occupied a house which had belonged to his master in the Via del Cocomero. Another painter with whom Cimabue is said to have been intimate was Gaddo Gaddi.

It had always been supposed that the bodily semblance of Cimabue is preserved to us in a portrait-figure by Simon Memmi painted in the Cappella degli Spagnuoli, in S. Maria Novella,—a thin hooded face in profile, with small beard, reddish and pointed. This is, however, extremely dubious. Simone Martini of Siena (commonly called Memmi) was born in 1283, and would therefore have been about nineteen years of age when Cimabue died; it is not certain that he painted the work in question, or that the figure represents Cimabue. The Florentine master is spoken of by a nearly contemporary commentator on Dante (the so-called Anonimo, who wrote about 1334) as *arrogante e disdegnoso*; so “arrogant and scornful” that, if any one or if he himself, found a fault in any work of his, however cherished till then, he would abandon it in disgust. This, however, to a modern mind, looks more like an aspiring and fastidious desire for perfection than any such form of “arrogance and scorn” as blemishes a man’s character. Giovanni Cimabue was buried in the cathedral of Florence, S. Maria del Fiore, with an epitaph written by one of the Nini:—

“Credidit ut Cimabos picturae castra tenere,
Sic tenuit vivens; nunc tenet astra poli.”

Here we recognize distinctly a parallel to the first clause in the famous triplet of Dante:

“Credette Cimabue nella pittura
Tener lo campo; ed ora ha Giotto il grido,
Sì che la fama di colui s’oscura.”

Besides Vasari, and Crowe and Cavalcaselle (re-edited by Langton), the following works may be consulted:—P. Angeli, *Storia della basilica d’Assisi*; Cole and Stillman, *Old Italian Masters* (1892); Mrs Ady, *Painters of Florence* (1900). (W. M. R.)

CIMAROSA, DOMENICO (1749–1801), Italian musical composer, was born at Aversa, in the kingdom of Naples, on the 17th of December 1749. His parents were poor, but anxious to give their son a good education; and after removing to Naples they sent him to a free school connected with one of the monasteries of that city. The organist of the monastery, Padre Polcano, was struck with the boy’s intellect, and voluntarily instructed him in the elements of music, as also in the ancient and modern literature of his country. To his influence Cimarosa owed a free scholarship at the musical institute of Santa Maria di Loreto, where he remained for eleven years, studying chiefly the great masters of the old Italian school. Piccini, Sacchini and other musicians of repute are mentioned amongst his teachers. At the age of twenty-three Cimarosa began his career as a composer with a comic opera called *Le Stravaganze del Conte*, first performed at the Teatro dei Fiorentini at Naples in 1772. The work met with approval, and was followed in the same year by *Le Pazzie di Stellidanza e di Zoroastro*, a farce full of humour and eccentricity. This work also was successful, and the fame of the young composer began to spread all over Italy. In 1774 he was invited to Rome to write an opera for the *stagione* of that year; and he there produced another comic opera called *L’Italiano in Londra*.

The next thirteen years of Cimarosa’s life are not marked by any event worth mentioning. He wrote a number of operas for the various theatres of Italy, living temporarily in Rome, in Naples, or wherever else his vocation as a conductor of his works happened to call him. From 1784–1787 he lived at Florence, writing exclusively for the theatre of that city. The productions of this period of his life are very numerous, consisting of operas, both comic and serious, cantatas, and various sacred

compositions. The following works may be mentioned amongst many others:—*Caio Mario*; the three biblical operas, *Assalonne*, *La Giuditta* and *Il Sacrificio d' Abramo*; also *Il Convito di Pietra*; and *La Ballerina amante*, a pretty comic opera first performed at Venice with enormous success.

About the year 1788 Cimarosa went to St Petersburg by invitation of the empress Catherine II. At her court he remained four years and wrote an enormous number of compositions, mostly of the nature of *pièces d'occasion*. Of most of these not even the names are on record. In 1792 Cimarosa left St Petersburg, and went to Vienna at the invitation of the emperor Leopold II. Here he produced his masterpiece, *Il Matrimonio segreto*, which ranks amongst the highest achievements of light operatic music. In 1793 Cimarosa returned to Naples, where *Il Matrimonio segreto* and other works were received with great applause. Amongst the works belonging to his last stay in Naples may be mentioned the charming opera *Le Astuzie femminili*. This period of his life is said to have been embittered by the intrigues of envious and hostile persons, amongst whom figured his old rival Paisiello. During the occupation of Naples by the troops of the French Republic, Cimarosa joined the liberal party, and on the return of the Bourbons, was, like many of his political friends, condemned to death. By the intercession of influential admirers his sentence was commuted into banishment, and he left Naples with the intention of returning to St Petersburg. But his health was broken, and after much suffering he died at Venice on the 11th of January 1801, of inflammation of the intestines. The nature of his disease led to the rumour of his having been poisoned by his enemies, which, however, a formal inquest proved to be unfounded. He worked till the last moment of his life, and one of his operas, *Artemizia*, remained unfinished at his death.

CIMBRI, a Teutonic tribe who made their first appearance in Roman history in the year 113 B.C., when they defeated the consul Gnaeus Papirius Carbo near Noreia in the modern Carinthia. It was the common belief that they had been driven from their homes on the North Sea by inundations, but, whatever the cause of their migration, they had been wandering along the Danube for some years warring with the Celtic tribes on either bank. After the victory of 113 they passed westwards over the Rhine, threatening the territory of the Allobroges. Their request for land was not granted, and in 109 B.C. they defeated the consul Marcus Junius Silanus in southern Gaul, but did not at once follow up the victory. In 105 they returned to the attack under their king Boiorix, and favoured by the dissensions of the Roman commanders Gnaeus Mallius Maximus and Caepio, defeated them in detail and annihilated their armies at Arausio (Orange). Again the victorious Cimbri turned away from Italy, and, after attempting to reduce the Arverni, moved into Spain, where they failed to overcome the desperate resistance of the Celtiberian tribes. In 103 they marched back through Gaul, which they overran as far as the Seine, where the Belgae made a stout resistance. Near Rouen the Cimbri were reinforced by the Teutoni and two cantons of the Helvetii. Thereupon the host marched southwards by two routes, the Cimbri moving on the left towards the passes of the Eastern Alps, while the newly arrived Teutoni and their allies made for the western gates of Italy. In 102 B.C. the Teutoni and Ambrones were totally defeated at Aquae Sextiae by Marius, while the Cimbri succeeded in passing the Alps and driving Q. Lutatius Catulus across the Adige and Po. In 101 Marius overthrew them on the Raudine Plain near Vercellae. Their king Boiorix was killed and the whole army destroyed. The Cimbri were the first in the long line of the Teutonic invaders of Italy.

The original home of the Cimbri has been much disputed. It is recorded in the *Monumentum Ancyranum* that a Roman fleet sailing eastwards from the mouth of the Rhine (c. A.D. 5) received at the farthest point reached the submission of a people called Cimbri, who sent an embassy to Augustus. Several early writers agree in saying that the Cimbri occupied a peninsula, and in the map of Ptolemy Jutland appears as the Cimbric Chersonese. As Ptolemy seems to have regarded the district

north of the Liimfjord (Limfjord) as a group of islands, the territory of the Cimbri, the northernmost tribe of the peninsula, would be included in the modern county (*Amt*) of Aalborg. This was formerly called Himmersyssel or Himmerland, forms which may very well preserve their name, especially as the name Charydes, mentioned next to them in the *Monumentum Ancyranum*, appears to survive in the modern Hardeland. Possibly also the district across the Liimfjord formerly called Thythsyssel or Thyland may in the same way preserve the name of the Teutoni (*q.v.*). Strabo and other early writers relate a number of curious facts concerning the customs of the Cimbri, which are of great interest as the earliest records of the manner of life of the Teutonic nations.

SOURCES.—Livy, *Epitome*, lxxvii., lxxviii.; *Monumentum Ancyranum*; Pomponius Mela iii. 3; C. Plinius Secundus, *Nat. Hist.* iv. cap. 13 and 14, §§ 95 ff.; Strabo p. 292 ff.; Plutarch, *Marius*, *passim*; Florus iii. 3; Ptolemy ii. 11. 11 f. (F. G. M. B.)

CIMICIFUGA, in botany, a small genus of herbaceous plants, of the natural order Ranunculaceae, which is widely distributed in the north temperate zone. *C. foetida*, hughane, is used as a preventive against vermin; and the root of a North American species, *C. racemosa*, known as black snake-root, as an emetic.

CIMMERII, an ancient people of the far north or west of Europe, first spoken of by Homer (*Odyssey*, xi. 12-19), who describes them as living in perpetual darkness. Herodotus (iv. 11-13), in his account of Scythia, regards them as the early inhabitants of South Russia (after whom the Bosphorus Cimmerius [*q.v.*] and other places were named), driven by the Scyths along by the Caucasus into Asia Minor, where they maintained themselves for a century. But the Cimmerii are often mentioned in connexion with the Thracian Treres who made their raids across the Hellespont, and it is quite possible that some Cimmerii took this route, having been cut off by the Scyths as the Alani (*q.v.*) were by the Huns. Certain it is that in the middle of the 7th century B.C., Asia Minor was ravaged by northern nomads (Herod. iv. 12), one body of whom is called in Assyrian sources *Gimirrai* and is represented as coming through the Caucasus. They were probably Iranian speakers, to judge by the few proper names preserved. The name has also been identified with the biblical Gomer, son of Japheth (Gen. x. 2, 3). To the north of the Euxine their main body was merged in the invading Scyths. Later writers identified them with the Cimbri of Jutland, who were probably Teutonized Celts, but this is a mere guess due to the similarity of name. The Homeric Cimmerii belong to an early part of the *Odyssey* in which the hero was conceived as wandering in the Euxine; these adventures were afterwards translated to the western Mediterranean in accordance with a wider geographical outlook.

For the Cimmerian invasions described by Herodotus, see SCYTHIA; LYDIA; GYGES. (E. H. M.)

CIMON [Κίμων] (c. 507-449), Athenian statesman and general, was the son of Miltiades (*q.v.*) and Hegesipyle, daughter of the Thracian prince Olorus. Miltiades died in disgrace, leaving unpaid the fine imposed upon him for his conduct at Paros. Cimon's first task in life, therefore, was to remove the stain on the family name by paying this fine (about £12,000). In the second Persian invasion, especially at Salamis, and in the consolidation of the Delian League, he won a high reputation for courage and integrity. At first with Aristides, and afterwards as sole commander, he directed the Athenian contingent of the fleet; on the disgrace of Pausanias he practically commanded the entire Greek fleet and drove Pausanias from his retreat in Byzantium. Having captured Eion (at the mouth of the Strymon), he expelled the Persian garrisons from the entire seaboard of Thrace with the exception of Doriscus, and, having defeated the piratical Dolopians of Scyros (470), confirmed his popularity by transferring thence to Athens the supposed bones of the Attic hero Theseus. The bones were buried in Athens, and over the tomb the Theseum (temple) was erected. In 466 Cimon proceeded to liberate the Greek cities of Lycia and Pamphylia, and at the mouth of the Eurymedon he defeated the Persians decisively by land and sea.

The Persian danger was now over, and the immediate purpose of the Delian League was achieved. Already, however, Athens had introduced the policy of coercion which was to transform the league into an empire, a policy which, after the ostracism of Themistocles and the death of Aristides, must be attributed to Cimon, whose fundamental idea was the union of the Greeks against all outsiders (see DELIAN LEAGUE). Carystus was compelled to join the league; Naxos (c. 469) and Thasos (465-463), which had revolted, were compelled to accept the position of tributary allies. In 464 Sparta was involved in war with her Helots (principally of Messenian origin) and was in great difficulties. Cimon, then the most prominent man in Athens, persuaded the Athenians to send assistance, on the ground that Athens could not "stand without her yoke-fellow" and leave "Hellas lame." The expedition was a failure, and Cimon was exposed to the attacks of the democrats led by Ephialtes. The history of this party struggle is not clear. The ordinary account is that Ephialtes during Cimon's absence in Messenia destroyed the powers of the Areopagus (*q.v.*) and then obtained the ostracism of Cimon, who attempted to reverse his policy. Without going fully into the question, which is full of difficulty, it may be pointed out (1) that when the Messenian expedition started Cimon had twice within the preceding year triumphed over the opposition of Ephialtes, and (2) that presumably the Cimonian party was predominant until after the expedition proved a failure. It is therefore unlikely that, immediately after Cimon's triumph in obtaining permission to go to Messenia, Ephialtes was able to attack the Areopagus with success. The probability is that when the expedition failed, Cimon was ostracized, and that then Ephialtes defeated the Areopagus, and also made a change in foreign policy by making alliances with Sparta's enemies, Argos and Thessaly. This hypothesis alone explains the absence of any account of a third struggle between Cimon and Ephialtes over the Areopagus. The chronology would thus be: ostracism of Cimon, spring, 461; fall of the Areopagus and reversal of Philo-Laonian policy, summer, 461.

A more difficult question is involved in the date of Cimon's return from ostracism. The ordinary account says that he was recalled after the battle of Tanagra (457) to negotiate the Five Years' Truce (451 or 450). To ignore the unexplained interval of six or seven years is an uncritical expedient, which, however, has been adopted by many writers. Some maintaining that Cimon did return soon after 457, say that the truce which he arranged was really the four months' truce recorded by Diodorus (only). To this there are two main objections: (1) if Cimon returned in 457, why does the evidence of antiquity connect his return specifically with the truce of 451? and (2) why does he after 457 disappear for six years and return again to negotiate the Five Years' Truce and to command the expedition to Cyprus? It seems much more likely that he returned in 451, at the very time when Athens returned to his old policy of friendship with Sparta and war in the East against Persia (*i.e.* the Cyprus expedition). Thus it would appear that from 453 onwards there was a recrudescence of conservative influence, and that for four years (453-449) Pericles was not master in Athens (see PERICLES); this theory is corroborated by the fact that Pericles, in the alarm caused by the Egyptian failure of 454, was induced to remove the Delian treasury to Athens and to abandon his anti-Spartan policy of land empire.

Cimon died in Cyprus before the walls of Citium (449), and was buried in Athens. Later Attic orators speak in glowing terms of a "Peace" between Athens and Persia, which is sometimes connected with the name of Cimon and sometimes with that of one Callias. If any such peace was concluded, it cannot have been soon after the battle of the Eurymedon as Plutarch assumes. It can have been only after Cimon's death and the evacuation of Cyprus (*i.e.* c. 448). It is only in this form that the view has been maintained logically in modern times. Apart from the fact that the peace is ignored by Thucydides and that the earliest reference to it is the passage in Isocrates (*Paneg.* 118 and 120), there are weighty reasons which render it improbable that any formal peace can have been concluded at

that period between Athens and Persia (see further Ed. Meyer's *Forschungen*, ii.).

Cimon's services in connexion with the consolidation of the Empire rank with those of Themistocles and Aristides. He is described as genial, brave and generous. He threw open his house and gardens to his fellow-demesmen, and beautified the city with trees and buildings. But as a statesman he failed to cope with the new conditions created by the democracy of Cleisthenes. The one great principle for which he is memorable is that of the balance of power between Athens and Sparta, as respectively the naval and military leaders of a united Hellas. It has been the custom to regard Cimon as a man of little culture and refinement. It is clear, however, from his desire to adorn the city, that he was by no means without culture and imagination. The truth is that, as in politics, so in education and attitude of mind, he represented the ideals of an age which, in the new atmosphere of democratic Athens, seemed to savour of rusticity and lack of education.

The lives of Cimon by Plutarch and Cornelius Nepos are uncritical; the conclusions above expressed are derived from a comparison of Plutarch, *Cimon*, 17, *Pericles*, 10; Theopompus, fragm. 92; Andocides, *de Pace*, §§ 3, 4; Diodorus xi. 86 (the four months' truce). See histories of Greece (*e.g.* Grote, ed. 1907, 1 vol.); also PERICLES; DELIAN LEAGUE, with works quoted. (J. M. M.)

CIMON OF CLEONAE, an early Greek painter, who is said to have introduced great improvements in drawing. He represented "figures out of the straight, and ways of representing faces looking back, up or down; he also made the joints of the body clear, emphasized veins, worked out folds and doublings in garments" (Pliny). All these improvements are such as may be traced in the drawing of early Greek red-figured vases (see GREEK ART).

CINCHONA, the generic name of a number of trees which belong to the natural order Rubiaceae. Botanically the genus includes trees of varying size, some reaching an altitude of 80 ft. and upwards, with evergreen leaves and deciduous stipules. The flowers are arranged in panicles, white or pinkish in colour, with a pleasant odour, the calyx being 5-toothed superior, and the corolla tubular, 5-lobed and fringed at the margin. The stamens are 5, almost concealed by the tubular corolla, and the ovary terminates in a fleshy disk. The fruit is an ovoid or sub-cylindrical capsule, splitting from the base, and held together at the apex. The numerous seeds are flat and winged all round. About 40 species have been distinguished, but of these not more than about a dozen have been economically utilized. The plants are natives of the western mountainous regions of South America, their geographical range extending from 10° N. to 22° S. lat.; and they flourish generally at an elevation of from 5000 to 8000 ft. above sea-level, although some have been noted growing as high up as 11,000 ft., and others have been found down to 2600 ft.

The trees are valued solely on account of their bark, which long has been the source of the most valuable febrifuge or antipyretic medicine, quinine (*q.v.*), that has ever been discovered. The earliest well-authenticated instance of the medicinal use of cinchona bark is found in the year 1638, when the countess of Chinchon (hence the name), the wife of the governor of Peru, was cured of an attack of fever by its administration. The medicine was recommended in her case by the corregidor of Loxa, who was said himself to have practically experienced its supreme virtues eight years earlier. A knowledge of the bark was disseminated throughout Europe by members of the Jesuit brotherhood, whence it also became generally known as Jesuits' bark. According to another account, this name arose from its value having been first discovered to a Jesuit missionary who, when prostrate with fever, was cured by the administration of the bark by a South American Indian. In each of the above instances the fever was no doubt malaria.

The procuring of the bark in the dense forests of New Granada, Ecuador, Peru and Bolivia is a work of great toil and hardship to the Indian *cascañeros* or *cascañeros* engaged in the pursuit. The trees grow isolated or in small clumps, which have to be searched out by the experienced *cascañero*, who laboriously cuts his way through the dense forest to the spot where he discovers

a tree. Having freed the stem from adhering parasites and twining plants, he proceeds, by beating and cutting oblong pieces, to detach the stem bark as far as is within his reach. The tree is then felled, and the entire bark of stem and branches secured. The bark of the smaller branches, as it dries, curls up, forming "quills," the thicker masses from the stems constituting the "flat" bark of commerce. The drying, packing and transport of the bark are all operations of a laborious description conducted under most disadvantageous conditions.

The enormous medicinal consumption of these barks, and the wasteful and reckless manner of procuring them in America long ago, caused serious and well-grounded apprehension that the native forests would quickly become exhausted. The attention of European communities was early directed to the necessity of securing steady and permanent supplies by introducing the more valuable species into localities likely to be favourable to their cultivation. The first actual attempt to rear plants was made in Algeria in 1849; but the effort was not successful. In 1854 the Dutch government seriously undertook the task of introducing the trees into the island of Java, and an expedition for that purpose was fitted out on an adequate scale. Several hundreds of young trees were obtained, of which a small proportion was successfully landed and planted in Java; and as the result of great attention the cultivation of cinchona plantations in that island became highly prosperous and promising. The desirability of introducing cinchonas into the East Indies was urged in a memorial addressed to the East India Company between 1838 and 1842 by Sir Robert Christison and backed by Dr Forbes Royle; but no active step was taken till 1852, when, again on the motion of Dr Royle, some efforts to obtain plants were made through consular agents. In the end the question was seriously taken up, and Sir Clements R. Markham was appointed to head an expedition to obtain young trees from South America and convey them to India. The transference of the plants was attended with considerable difficulty, but in 1861 under his superintendence a consignment of plants was planted in a favourable situation in the Nilgiri Hills. For several years subsequently additional supplies of plants of various species were obtained from different regions of South America, and some were also procured from the Dutch plantations in Java. Now the culture has spread over a wide area in southern India, in Ceylon, on the slopes of the Himalayas, and in British Burma, and has become widely spread through the tropics generally. The species grown are principally *Cinchona officinalis*, *C. Calisaya*, *C. succirubra*, *C. pitayensis*, and *C. Pahudiana*, some agreeing with certain soils and climates better than others, while the yield of alkaloids and the relative proportions of the different alkaloids differ in each species.

The official "bark" of the British Pharmacopoeia is that of *Cinchona succirubra* or red bark. It is imported in the form of quills or recurved pieces, with a rough brown outer surface and a deep red inner surface, forming a reddish brown odourless powder, which has a bitter, astringent taste. The British Pharmacopoeia directs that the bark, when used to make the various medicinal preparations, shall contain not less than 5 nor more than 6% of total alkaloids, of which at least one-half is to be constituted by quinine and cinchonidine. The preparations of this bark are four: a liquid extract, standardized to contain 5% of total alkaloids; an acid infusion; a tincture standardized to contain 1% of total alkaloids; and a compound tincture which must possess one-half the alkaloidal strength of the last. The only purpose for which these preparations of cinchona bark should be used is as tonics; and even when this is the desired action there are many reasons why the alkaloid should be preferred, even though the recent introduction of standardization removes one of the chief objections to their use.

The pharmacology of red bark, dependent as it is almost entirely upon the contained quinine, will not here be discussed (see QUININE). But the composition of cinchona bark is a matter of importance and interest. The bark contains, in the first place, five alkaloids, of which all but quinine may here be dealt with. Quinidine, $C_{20}H_{21}N_3O_2$, is isomeric with quinine, from which it differs in crystallizing in prisms instead of needles, in being dextro- and not laevo-

rotatory, and in being insoluble in ammonia except in much excess. Cinchonine has the formula $C_{19}H_{21}N_3O$, quinine being methoxy cinchonine, i.e. $C_{19}H_{21}(OCH_3)N_3O$. It occurs in inodorous, bitter, colourless prisms; unlike the two alkaloids already named, does not yield a green colour with chlorine water and ammonia; is dextro-rotatory; not fluorescent, and practically insoluble in ammonia and in ether. A fourth alkaloid, cinchonidine, is isomeric with cinchonine, which yields it when boiled with amyl alcoholic potash, but is laevo-rotatory, slightly soluble in ether, and faintly fluorescent. When red bark is extracted with dilute hydrochloric acid, the product filtered, and excess of sodium hydrate added thereto, quinine and quinidine are precipitated: on concentrating the mother liquor, cinchonine falls down, and on further concentration with addition of still more alkali, cinchonidine is thrown out. Yellow bark, which is not official, yields 3% of quinine, and pale bark about 10% of total alkaloids, of which hardly any is quinine, cinchonine and quinidine being its chief constituents. The various forms of bark also yield a very small quantity of an unimportant alkaloid, *conquinamine*. In addition to the above, red bark contains *quinic acid*, $C_7H_{12}O_6$, which is closely allied to benzoic acid and is excreted in the urine as hippuric acid. There also occurs *chinovic acid*, derived from a glucoside *chinovin*, which occurs as such in the bark. Besides a trace of volatile oil which gives the bark its characteristic odour, and cinchona red (the bark pigment), there occurs about 2% of *cincho-tannic acid*, closely allied to tannic acid and giving the bark its astringent property. Cinchona is never used, however, in order to obtain an astringent action.

The importance of recognizing the complex and inconstant composition of cinchona bark lies, as in so many other instances, in this—that the physician who employs it can have only a very imperfect knowledge of the drug he is using. The latest work on the action of these alkaloids has shown that cinchonine has a tendency to produce convulsions in certain patients, and that this action is a still more marked feature of cinchonidine and cinchonamine. Even small doses administered to epileptics increase the number of their attacks. They will probably be classified later among the convulsive poisons. The use of cinchona bark and its preparations, now that definite active principles can be readily obtained and precisely studied, is almost entirely to be deprecated. Quinidine is almost as powerful an antidote to malaria as quinine; cinchonidine has about two-thirds the power of quinine, and cinchonine less than one-half.

CINCINNATI, a city and the county-seat of Hamilton county, Ohio, U.S.A., on the Ohio river, opposite the mouth of the Licking, about 100 m. S.W. of Columbus, about 305 m. by rail S.E. of Chicago, and about 760 m. (by rail) W.S.W. of New York. Through the city flows Mill Creek, which empties into the Ohio. Pop. (1890¹) 296,908; (1900) 325,902, of whom 197,896 were of foreign parentage (i.e. either their fathers or mothers or both were foreign-born), 57,961 were foreign-born, and 14,482 were negroes; (1910) 363,591. The German is by far the most important of the foreign elements. In addition to the large number of inhabitants of German descent, there were, in 1900, 107,152 of German parentage, and of the foreign-born 38,219 came from Germany.

Cincinnati is situated on the N. side of the river upon two terraces or plateaus—the first about 60 ft., the second from 100 to 150 ft., above low water—and upon hills which enclose these terraces on three sides in the form of an amphitheatre, rising to a height of about 400 ft. on the E. and of about 460 ft. on the W., and commanding magnificent views of the river, the valley, the numerous suburbs, and the more distant wooded hills. About half of the hill-enclosed plain lies S. of the river, and it is upon this southern half that Covington, Newport, Dayton, Ludlow and other Kentucky suburbs of Cincinnati are situated. Cincinnati has a river-frontage of about 14 m., extends back about 6 m. on the W. side in the valley of Mill Creek, and occupies a total area of about 44 sq. m. Since 1867 it has been connected with Covington by a wire suspension bridge designed by John A. Roebling, and rebuilt and enlarged in 1897. This bridge is 1057 ft. long between towers (or, including the approaches, 2252 ft. long), with a height of 101 ft. above low water, and has a double wagon road and two ways for pedestrians. By two bridges there is direct communication with Newport; by one, that of the Cincinnati Southern railway, with Ludlow; and by one (Chesapeake & Ohio; see vol. v., p. 109)

¹ Previous census reports of the total population were as follows: (1810) 25,40; (1820) 9642; (1830) 24,831; (1840) 46,338; (1850) 115,435; (1860) 161,044; (1870) 216,239; (1880) 225,139. In the territory within a radius of 10 m. of the United States government building there was in 1900 a population of about 480,000.

with West Covington. On the terraces the streets generally intersect at right angles, but on the hills their directions are irregular. To the "bottoms" (which have suffered much from floods¹) between Third Street and the river the manufacturing and wholesale districts are for the most part confined, although many of these interests are now on the higher levels or in the suburbs; the principal retail houses are on the higher levels N. of Third Street, and the handsomest residences are on the picturesque hills before mentioned, in those parts of the city, formerly separate villages, known as Avondale, Mt. Auburn, Clifton, Price Hill, Walnut Hills and Mt. Lookout. The main part of the city is connected with these residential districts by electric street railways, whose routes include four inclined-plane railways, namely, Mt. Adams (268 ft. elevation), Bellevue (300 ft.), Fairview (210 ft.) and Price Hill (350 ft.), from each of which an excellent panoramic view of the city and suburbs may be obtained. There are various suburbs, chiefly residential, in the Mill Creek valley, among them being Carthage, Hartwell, Wyoming, Lockland and Glendale. Other populous and attractive suburbs N. of the Ohio river are Norwood and College Hill.

Buildings, &c.—Brick, blue limestone, and a greyish buff freestone are the most common building materials, and the city has various buildings of much architectural merit. The chamber of commerce (completed 1889), designed by H. H. Richardson, is one of the finest public buildings in the United States. Its walls are of undressed granite, and it occupies a ground area of 100 by 150 ft. The United States government building (designed by A. B. Mullet, and built of Maine and Missouri granite) is a fine structure in classic style, 360 ft. long and 160 ft. wide, and $4\frac{1}{2}$ storeys high; its outer walls are faced with sawn freestone. It was erected in 1874-1885 and cost (including the land) \$5,250,000. The city hall (332 ft. by 203 ft.), with walls of red granite and brown sandstone, is a massive and handsome building erected at a cost of \$1,600,000. The county court house (rebuilt in 1887) is in the Romanesque style, and with the gaol attached occupies an entire square. The Cincinnati hospital (completed 1869), comprising eight buildings grouped about a central court and connected by corridors, occupies a square of four acres. A new public hospital for the suburbs was projected in 1907. St Peter's (Roman Catholic) cathedral (begun 1839, consecrated 1844), Grecian in style, is a fine structure, with a graceful stone spire 224 ft. in height and a chime of 13 bells; it has as an altar-piece Murillo's "St Peter Liberated by an Angel." The church of St Francis de Sales (in Walnut Hills), built in 1888, has a bell, cast in Cincinnati, weighing fifteen tons, and said to be the largest swinging bell in the world. Several of the Protestant churches, such as the First Presbyterian (built 1835; steeple, including spire, 285 ft. high), Second Presbyterian (1872), Central Christian (1869), St Paul's Methodist Episcopal (1870), and St Paul's Protestant Episcopal pro-cathedral (1851), are also worthy of mention, and in the residential suburbs there are many fine churches. Cincinnati is the seat of a Roman Catholic archbishopric and a Protestant Episcopal and Methodist Episcopal bishopric. The Masonic temple (195 ft. long and 100 ft. wide), in the Byzantine style, is four storeys high, and has two towers of 140 ft.; the building was completed in 1860 and has subsequently been remodelled. Among other prominent buildings are the Oddfellows' temple (completed 1804), the public library, the art museum (1886), a Jewish synagogue (in Avondale), and the (Jewish) Plum Street temple (1866), Moorish in architecture. The Soldiers', Sailors' and Pioneers' building (1907) is a beautiful structure, classic in design. The business houses are of stone or brick, and many of them are attractive architecturally; there are a number of modern office buildings from 15 to 20 storeys in height. There are also several large hotels and ten theatres (besides halls and auditoriums for concerts and public gatherings), the most notable being Springer music hall.

¹ The most destructive floods have been those of 1832, 1847, 1883, 1884 and 1907; the highest stage of the water before 1904 was 71 ft. $\frac{3}{4}$ in. in 1884, the lowest 1 ft. 11 in. in 1881.

One of the most noted pieces of monumental art in the United States is the beautiful Tyler Davidson bronze fountain in Fountain Square (Fifth Street, between Walnut and Vine streets), the business centre of the city, by which (or within one block of which) all car lines run. The fountain was unveiled in 1871 and was presented to the city by Henry Probasco (1820-1902), a wealthy citizen, who named it in honour of his deceased brother-in-law and business partner, Mr Tyler Davidson. The design, by August von Kreling (1819-1876), embraces fifteen bronze figures, all cast at the royal bronze foundry in Munich, the chief being a female figure with outstretched arms, from whose fingers the water falls in a fine spray. This figure reaches a height of 45 ft. above the ground. The city has, besides, monuments to the memory of Presidents Harrison and Garfield (both in Garfield Place, the former an equestrian statue by Louis T. Rebisso, and the latter by Charles H. Niehaus); also, in Spring Grove cemetery, a monument to the memory of the Ohio volunteers who lost their lives in the Civil War. The art museum, in Eden Park, contains paintings by celebrated European and American artists, statuary, engravings, etchings, metal work, wood carving, textile fabrics, pottery, and an excellent collection in American ethnology and archaeology. The Cincinnati Society of Natural History (incorporated 1870) has a large library and a museum containing a valuable palaeontological collection, and bones and implements from the prehistoric cemetery of the mound-builders, at Madisonville, Ohio.

Parks.—In 1908 Cincinnati had parks covering about 540 acres; there are numerous pleasant driveways both within the city limits and in the suburban districts, and several attractive resorts are within easy reach. Eden Park, of 214 acres, on Mount Adams, about 1 m. E. of the business centre and near the river, is noted for its natural beauty, greatly supplemented by the landscape-gardener's skill, and for its commanding views. The ground was originally the property of Nicholas Longworth (1782-1863), a wealthy citizen and well-known horticulturist, who here grew the grapes from which the Catawba wine, introduced by him in 1828, was made. The park contains the art museum and the art academy. Its gateway, Elsinore, is a medieval reproduction; other prominent features are the reservoirs, which resemble natural lakes, and a high water tower, from which there is a delightful view. In Burnet Woods Park, lying to the N.E. of Eden and containing about 163 acres, are the buildings and grounds of the University of Cincinnati, and a lake for boating and skating. The zoological gardens occupy 60 acres and contain a notable collection of animals and birds. Other pleasure resorts are the Lagoon on the Kentucky side (in Ludlow, Ky.), Chester Park, about 6 m. N. of the business centre, and Coney Island, about 10 m. up the river on the Ohio side. Washington (5.6 acres), Lincoln (10 acres), Garfield and Hopkins are small parks in the city. In 1907 an extensive system of new parks, parkways and boulevards was projected. Spring Grove cemetery, about 6 m. N.W. of Fountain Square, contains 600 acres picturesquely laid out on the park plan. It contains many handsome monuments and private mausoleums, and a beautiful mortuary chapel in the Norman style.

Water-Supply.—A new and greatly improved water-supply system for the city was virtually completed in 1907. This provides for taking water from the Ohio river at a point on the Kentucky side opposite the village of California, Ohio, and several miles above the discharge of the city sewers; for the carrying of the water by a gravity tunnel under the river to the Ohio side, the water being thence elevated by four great pumping engines, each having a daily capacity of 30,000,000 gallons, to settling basins, being then passed through filters of the American or mechanical type, and flowing thence by a gravity tunnel more than 4 m. long to the main pumping station, on the bank of the river, within the city; and for the pumping of the water thence, a part directly into the distributing pipes and a part to the principal storage reservoir in Eden Park.

Education.—Cincinnati is an important educational centre. The University of Cincinnati, originally endowed by Charles M'Micken (d. 1858) and opened in 1873, occupies a number of

handsome buildings erected since 1895 on a campus of 43 acres in Burnet Woods Park, has an astronomical observatory on the highest point of Mt. Lookout, and is the only strictly municipal university in the United States. The institution embraces a college of liberal arts, a college of engineering, a college of law (united in 1897 with the law school of Cincinnati College, then the only surviving department of that college, which was founded as Lancaster Seminary in 1815 and was chartered as Cincinnati College in 1819), a college of medicine (from 1819 to 1896 the Medical College of Ohio; the college occupies the site of the old M'Micken homestead), a college for teachers, a graduate school, and a technical school (founded in 1886 and transferred to the university in 1901); while closely affiliated with it are the Clinical and Pathological School of Cincinnati and the Ohio College of Dentistry. With the exception of small fees charged for incidental expenses, the university is free to all students who are residents of the city; others pay \$75 a year for tuition. It is maintained in part by the city, through public taxation, and in part by the income from endowment funds given by Charles M'Micken, Matthew Thoms, David Sinton and others. The government of the university is entrusted mainly to a board of nine directors appointed by the mayor. In 1909 it had a faculty of 144 and 1364 students. Lane Theological Seminary is situated in Walnut Hills, in the north-eastern part of the city; it was endowed by Ebenezer Lane and the Kemper family; was founded in 1829 for the training of Presbyterian ministers; had for its first president (1832-1852) Lyman Beecher; and in 1834 was the scene of a bitter contest between abolitionists in the faculty and among the students, led by Theodore Dwight Weld, and the board of trustees, who forbade the discussion of slavery in the seminary and so caused about four-fifths of the students to leave, most of them going to Oberlin College. The city has also Saint Francis Xavier College (Roman Catholic, established in 1831 and until 1840 known as the Athenaeum); Saint Joseph College (Roman Catholic, 1873); Mount St Mary's of the West Seminary (Roman Catholic, theological, 1848, at Cedar Point, Ohio); Hebrew Union College (1875), the leading institution in the United States for educating rabbis; the largely attended Ohio Mechanics' Institute (founded 1828), a private corporation not conducted for profit, its object being the education of skilled workmen, the training of industrial leaders, and the advancement of the mechanic arts (in 1907 there were in all departments 1421 students, a large majority of whom were in the evening classes); an excellent art academy, modelled after that of South Kensington; the College of Music and the Conservatory of Music (mentioned below); the Miami Medical College (opened in 1852); the Pulte Medical College (homeopathic; coeducational; opened 1872); the Eclectic Medical Institute (chartered 1845); two women's medical colleges, two colleges of dental surgery, a college of pharmacy, and several business colleges. The public, district, and high schools of the city are excellent. The City (or public) library contained in 1906 301,380 vols. and 57,562 pamphlets; the University library (including medical, law and astronomical branches), 80,000 vols. (including the Robert Clarke collection, rich in Americana, and the library—about 5000 vols.—of the American Association for the Advancement of Science); the Young Men's Mercantile library, 70,000 vols.; and the Law library, 35,000 vols.; in addition, the Lloyd library and museum of botany and pharmacy, and the library of the Historical and Philosophical Society of Ohio (1831), which contains a valuable collection of rare books, pamphlets and manuscripts, are worthy of mention.

Art, &c.—The large German population makes the city noteworthy for its music. The first Sangerfest was held in Cincinnati in 1849, and it met here again in 1870, when a new hall was built for its accommodation. Under the leadership of Theodore Thomas (1835-1905), the Cincinnati Musical Festival Association was incorporated, and the first of its biennial May festivals was held in 1873. In 1875-1878 was built the large Springer music hall, named in honour of Reuben R. Springer (1800-1884), its greatest benefactor, who endowed the Cincinnati College of

Music (incorporated in 1878), of which Thomas was director in 1878-1881. Until his death Thomas was director of the May festivals also. The grounds for the music hall were given by the city and are perpetually exempt from taxation. The great organ in the music hall was dedicated at the third of the May festivals in 1878. The Sangerfest met in Cincinnati for the third time in 1879, and its jubilee was held here in 1899. By 1880 the May festival chorus had become a permanent organization. The city has several other musical societies—the Apollo and Orpheus clubs (1881 and 1893), a Liederkrantz (1886), and a United Singing Society (1896) being among the more prominent; and there are two schools of music—the Conservatory of Music and the College of Music.

The city has large publishing interests, and various religious (Methodist Episcopal and Roman Catholic) and fraternal periodicals, and several technical journals and trade papers are published here. The principal daily newspapers are the *Enquirer*, a Democratic journal, established in 1842 and conducted for many years after 1852 by Washington McLean (1816-1890), and then by his son, John Roll McLean (b. 1848); the *Commercial Tribune* (Republican; previously the *Commercial-Gazette* and still earlier the *Commercial*, founded in 1793, *The Tribune* being merged with it in 1896), the *Times-Star* (the *Times* established in 1836), and the *Post*, established in 1881 (both evening papers); and several influential German journals, including the *Volksblatt* (Republican; established 1836), and the *Volksfreund* (Democratic; established 1850).

Among the social clubs of the city are the Queen City Club, organized in 1874; the Phoenix Club, organized in 1856 and the leading Jewish club in the city; the Cuvier Club, organized in 1871 and originally an association of hunters and anglers for the preservation of game and fish; the Cincinnati Club, the Business Men's Club, the University Club, the Art Club, and the Literary Club, of the last of which many prominent men, including President Hayes, have been members. This club dates from 1849, and is said to be the oldest literary club in the country. There are various commercial and trade organizations, the oldest and most influential being the Cincinnati Chamber of Commerce and Merchants' Exchange, which dates from 1839.

Administration.—The city is governed under the municipal code enacted by the state legislature in 1902, for the provisions of which see OHIO.

Among the institutions are the City infirmary (at Hartwell, a suburb, which, besides supporting pauper inmates, affords relief to outdoor poor; the Cincinnati hospital, which is supported by taxation and treats without charge all who are unable to pay; twenty other hospitals, some of which are charitable institutions; a United States marine hospital; the Longview hospital for the insane, at Carthage, 10 m. from the city, and belonging to Hamilton county, whose population consists largely of the inhabitants of Cincinnati; an insane asylum for negroes; six orphan asylums—the Cincinnati, two Protestant, two Roman Catholic, and one for negroes; a home for incurables; a day nursery; a fresh-air home and farm for poor children; the Franciscan Brothers' Protectory for boys; a children's home; two widows' homes; two old men's homes; several homes for indigent and friendless women; a foundling asylum; the rescue mission and home for erring women; a social settlement conducted by the University of Cincinnati; the house of refuge (1850) for "the reformation and education of homeless and incorrigible children under 16 years of age"; and a workhouse for adults convicted of minor offences.

Communications.—Cincinnati is a railway centre of great importance and has an extensive commerce both by rail and by river. It is served by the following railways: the Pittsburg, Cincinnati, Chicago & St Louis (Pennsylvania system), the Cleveland, Cincinnati, Chicago & St Louis (New York Central system), the Chicago, Cincinnati & Louisville, the Cincinnati, New Orleans & Texas Pacific (the lessee of the Cincinnati Southern railway,¹ connecting Cincinnati and Chattanooga, Tenn., its line

¹ The Cincinnati Southern railway is of especial interest in that it was built by the city of Cincinnati in its corporate capacity. Much

forming part of the so-called Queen & Crescent Route to New Orleans), the Erie, the Baltimore & Ohio South-Western (Baltimore & Ohio system), the Chesapeake & Ohio, the Norfolk & Western, the Louisville & Nashville, the Cincinnati, Hamilton & Dayton, the Cincinnati Northern (New York Central system), the Cincinnati & Muskingum Valley (Pennsylvania system), and the Cincinnati, Lebanon & Northern (Pennsylvania system). Most of these railways use the Union Station; the Pennsylvania and the Cincinnati, Hamilton & Dayton, have separate stations. The city's river commerce, though of less relative importance since the advent of railways, is large and brings to its wharves much bulky freight, such as coal, iron and lumber; it also helps to distribute the products of the city's factories; and the National government has done much to sustain this commerce by deepening and lighting the channel. Formerly there was considerable commerce with Lake Erie by way of the Miami & Erie Canal to Toledo; the canal was completed in 1830 and has never been entirely abandoned.

Industries.—Although the second city in population in the state, Cincinnati ranked first in 1900 as a manufacturing centre, but lost this pre-eminence to Cleveland in 1905, when the value of Cincinnati's factory product was \$166,059,050, an increase of 17.2% over the figures for 1900. In the manufacture of vehicles, harness, leather, hardwood lumber, wood-working machinery, machine tools, printing ink, soap, pig-iron, malt liquors, whisky, shoes, clothing, cigars and tobacco, furniture, cooperage goods, iron and steel safes and vaults, and pianos, also in the packing of meat, especially pork,¹ it ranks very high among the cities of the Union. The well-known and beautiful Rookwood ware has been made in Cincinnati since 1880; at the Rookwood Pottery (on Mt. Adams), founded by Mrs Bellamy (Maria Longworth) Storer, named from her father's home near the city, the first American pottery to devote exclusive attention to art ware. The earlier wares were yellow, brown and red; then came deep greens and blues, followed by mat glazes and by "vellum" ware (first exhibited in 1904), a lustreless pottery, resembling old parchment, with its decoration painted or modelled or both. The clays used are exclusively American, much being obtained in Missouri. Among the more important manufactures of the city in 1905 were the following, with the value of the product for that year: clothing (\$16,972,484), slaughtering and meat-packing products (\$13,446,202), foundry and machine-shop products (\$11,528,768), boots and shoes (\$10,596,928), distilled liquors (\$9,609,826), malt liquors (\$7,702,693), and carriages and wagons (\$6,323,803).²

History.—Cincinnati was founded by some of the first settlers in that part of the North-West Territory which afterwards became the state of Ohio. It lies on part of the land purchased for himself and others by John Cleves Symmes (1742-1814) from the United States government in 1788, and the settlement was established near the close of the same year by immigrants chiefly from New Jersey and Kentucky. When the town was laid out early in 1789, John Filson, one of the founders, named it Losanti-ville of the city's trade had always been with the Southern states, and the urgent need of better facilities for this trade than the river and existing railway lines afforded led to the building of this road by the city. The work was carried on under the direction of a board of five trustees appointed by the superior court of Cincinnati in accordance with the so-called Ferguson Act passed by the Ohio legislature in 1869, and the railway was completed to Chattanooga in February 1880. For accounts of the building and the management of the railway, see J. H. Hollander, *The Cincinnati Southern Railway; A Study in Municipal Activity* (Baltimore, 1894), one of the Johns Hopkins University Studies in Historical and Political Science; and *The Founding of the Cincinnati Southern Railway, with an Autobiographical Sketch* by E. A. Ferguson (Cincinnati, 1905).

¹ Before 1863 Cincinnati was the principal centre in the United States for the slaughtering of hogs and the packing of pork. The industry began as early as 1820 and rapidly increased in importance, but after 1863 Chicago took the lead.

² These figures are from the U.S. census, and are of course for Cincinnati proper: some of the largest industrial establishments, however, are just outside the city limits—among these are manufactory of soap (the Ivory Soap Works), machine tools, electrical machinery and appliances, structural and architectural iron work, and office furnishings.

ville (*L* for Licking; *os*, Latin for mouth; *anti*, Greek for opposite; and *vile*, French for town), but early in the next year Symmes caused the present name to be substituted in honour of the Order of the Cincinnati, General Arthur St Clair, the governor of the North-West Territory, being then president of the Pennsylvania State Society of the Cincinnati. St Clair arrived about the time the change in name was made, immediately erected Hamilton County, and made Cincinnati its seat of government; the territorial legislature also held its sessions here from the time of its first organization in 1799 until 1801, when it removed to Chillicothe. During the early years the Indians threatened the life of the settlement, and in 1789 Fort Washington, a log building for protection against the Indians, was built in the city; General Josiah Harmar, in 1790, and General St Clair, in 1791, made unsuccessful expeditions against them, and the alarm increased until 1794, when General Wayne won a decisive victory over the savages at Maumee Rapids in the battle of Fallen Timbers, after which he secured their consent to the terms of the treaty of Greenville (1795). Cincinnati was incorporated as a village in 1802, received a second charter in 1815, was chartered as a city in 1819, and received its second city charter in 1827 and its third in 1832; since 1851 it has been governed nominally by general laws of the state, although by the state's method of classifying cities many acts for its government have been in reality special. When first incorporated its limits were confined to an area of 3 sq. m., but by annexations in 1849 and 1850 this area was doubled; in 1854 another square mile was added; in 1869 and 1870 large additions were made, which included the villages of Sedamsville, Price Hill, Walnut Hills, Mount Auburn, Clintonville, Corryville, Vernon, Mount Harrison, Barrsville, Fairmount, West Fairmount, St Peters, Lick Run and Clifton Heights; in 1872 Columbia, which was settled a short time before Cincinnati, was added, in 1873 Cumminsville and Woodburn; in 1895 Avondale, Riverside, Clifton, Linwood and Westwood; in 1903 Bond Hill, Winton Place, Hyde Park and Evanston; in 1904 portions of Mill Creek township, and in 1905 a small tract in Mill Creek Valley.

In 1829 Mrs Frances Trollope established in Cincinnati, where she lived for a part of two years, a "Bazar," which as the principal means of carrying out her plan to benefit the town was entirely unsuccessful; a vivid but scarcely unbiassed picture of Cincinnati in the early thirties is to be found in her *Domestic Manners of the Americans* (1831). In 1845 began the marked influx of Germans, which lasted in large degree up to 1860; they first limited themselves to the district "Over the Rhine" (the Rhine being the Miami & Erie Canal), in the angle north-east of the junction of Canal and Sycamore streets, but gradually spread throughout the city, although this "Over the Rhine" is still most typically German.

For more than ten years preceding the Civil War the city was much disturbed by slavery dissension—the industrial interests were largely with the South, but abolitionists were numerous and active, and the city was an important station on the "Underground Railroad," of which Dr Norton S. Townshend (1815-95) was conductor, and one of the stations was the home of Mrs. Harriet Beecher Stowe, who lived in Cincinnati from 1832 to 1850, and gathered there much material embodied in *Uncle Tom's Cabin*. In 1834 came the Lane Seminary controversies over slavery previously referred to. In 1835 James G. Birney established here his anti-slavery journal, *The Philanthropist*, but his printing shops were repeatedly mobbed and his presses destroyed, and in January of 1836 his bold speech before a mob gathered at the court-house was the only thing that saved him from personal violence, as the city authorities had warned him that they had not sufficient force to protect him.

At the time of the Civil War the city was strongly in sympathy with the North. In September 1862 the city was threatened by a Confederate force under General Kirby Smith, who led the advance of General Bragg's army (see AMERICAN CIVIL WAR). On the 28th of March 1884 many of the citizens met at Music Hall to protest against the lax way in which the law was enforced, notably in the case of a recent murder, when the confessed

criminal had been found guilty of manslaughter only. An attack was made on the gaol by the lawless element outside the hall, but was futile,—the murderer having been removed by the authorities to Columbus. In its efforts to break into the gaol and court-house the mob was confronted by the militia, and bloodshed and loss of life resulted; during the rioting the court-house was fired by the mob and practically destroyed, and many valuable records were burned. Various important political conventions have met in Cincinnati, including the national Democratic convention of 1856, the national Liberal-Republican convention of 1872, the national Republican convention of 1876, and the national Democratic convention of 1880,—by which, respectively, James Buchanan, Horace Greeley, R. B. Hayes and Winfield Scott Hancock were nominated for the presidency.

See C. T. Greve, *Centennial History of Cincinnati and Representative Citizens* (Chicago, 1904), the official municipal documents, the Annual Reports of the Cincinnati Chamber of Commerce, &c.

CINCINNATUS,¹ **LUCIUS QUINCTIUS** (b. c. 519 B.C.), one of the heroes of early Rome, a model of old Roman virtue and simplicity. A persistent opponent of the plebeians, he resisted the proposal of Terentilius Arsa (or Harsa) to draw up a code of written laws applicable equally to patricians and plebeians. He was in humble circumstances, and lived and worked on his own small farm. The story that he became impoverished by paying a fine incurred by his son Caeso is an attempt to explain the needy position of so distinguished a man. Twice he was called from the plough to the dictatorship of Rome in 458 and 439. In 458 he defeated the Aequians in a single day, and after entering Rome in triumph with large spoils returned to his farm. The story of his success, related five times under five different years, possibly rests on an historical basis, but the account given in Livy of the achievements of the Roman army is obviously incredible.

See Livy iii. 26-29; Dion. Halic. x. 23-25; Florus i. 11. For a critical examination of the story see Schwegler, *Römische Geschichte*, bk. xxviii. 12; Sir G. Cornewall Lewis, *Credibility of early Roman History*, ch. xii. 40; W. Ihne, *History of Rome*, i.; E. Pais, *Storia di Roma*, i. ch. 4 (1898).

CINDERELLA (*i.e.* little cinder girl), the heroine of an almost universal fairy-tale. Its essential features are (1) the persecuted maiden whose youth and beauty bring upon her the jealousy of her step-mother and sisters, (2) the intervention of a fairy or other supernatural instrument on her behalf, (3) the prince who falls in love with and marries her. In the English version, a translation of Perrault's *Cendrillon*, the glass slipper which she drops on the palace stairs is due to a mistranslation of *gantouffe en vair* (a fur slipper), mistaken for *en verre*. It has been suggested that the story originated in a nature-myth, Cinderella being the dawn, oppressed by the night-clouds (cruel relatives) and finally rescued by the sun (prince).

See Marian Rolfe Cox, *Cinderella; Three Hundred and Forty-five Variants* (1893); A Lang, *Perrault's Popular Tales* (1888).

CINEAS, a Thessalian, the chief adviser of Pyrrhus, king of Epirus. He studied oratory in Athens, and was regarded as the most eloquent man of his age. He tried to dissuade Pyrrhus from invading Italy, and after the defeat of the Romans at Heraclea (280 B.C.) was sent to Rome to discuss terms of peace. These terms, which are said by Appian (*De Rebus Samniticis*, 10, 11) to have included the freedom of the Greeks in Italy and the restoration to the Bruttians, Apulians and Samnites of all that had been taken from them, were rejected chiefly through the vehement and patriotic speech of the aged Appius Claudius Caecus the censor. The withdrawal of Pyrrhus from Italy was demanded, and Cineas returned to his master with the report that Rome was a temple and its senate an assembly of kings. Two years later Cineas was sent to renew negotiations with Rome on easier terms. The result was a cessation of hostilities, and Cineas crossed over to Sicily, to prepare the ground for Pyrrhus's campaign. Nothing more is heard of him. He is said to have made an epitome of the *Tactica* of Aeneas, probably referred to by Cicero, who speaks of a Cineas as the author of a treatise *De Re Militari*.

¹ *I.e.* the "curly-haired."

See Plutarch, *Pyrrhus*, 11-21; Justin xviii. 2; Eutropius ii. 12; Cicero, *Ad Fam.* ix. 25.

CINEMATOGRAPH, or **KINEMATOGRAPH** (from *κίνημα*, motion, and *γράφειν*, to depict), an apparatus in which a series of views representing closely successive phases of a moving object are exhibited in rapid sequence, giving a picture which, owing to persistence of vision, appears to the observer to be in continuous motion. It is a development of the zoetrope or "wheel of life," described by W. G. Horner about 1833, which consists of a hollow cylinder turning on a vertical axis and having its surface pierced with a number of slots. Round the interior is arranged a series of pictures representing successive stages of such a subject as a galloping horse, and when the cylinder is rotated an observer looking through one of the slots sees the horse apparently in motion. The pictures were at first drawn by hand, but photography was afterwards applied to their production. E. Muybridge about 1877 obtained successive pictures of a running horse by employing a row of cameras, the shutters of which were opened and closed electrically by the passage of the horse in front of them, and in 1883 E. J. Marey of Paris established a studio for investigating the motion of animals by similar photographic methods.

The modern cinematograph was rendered possible by the invention of the celluloid roll film (employed by Marey in 1890), on which the serial pictures are impressed by instantaneous photography, a long sensitized film being moved across the focal plane of a camera and exposed intermittently. In one apparatus for making the exposures a cam jerks the film across the field once for each picture, the slack being gathered in on a drum at a constant rate. In another four lenses are rotated so as to give four images for each rotation, the film travelling so as to present a new portion in the field as each lens comes in place. Sixteen to fifty pictures may be taken per second. The films are developed on large drums, within which a ruby electric light may be fixed to enable the process to be watched. A positive is made from the negative thus obtained, and is passed through an optical lantern, the images being thus successively projected through an objective lens upon a distant screen. For an hour's exhibition 50,000 to 165,000 pictures are needed. To regulate the feed in the lantern a hole is punched in the film for each picture. These holes must be extremely accurate in position; when they wear the feed becomes irregular, and the picture dances or vibrates in an unpleasant manner. Another method of exhibiting cinematographic effects is to bind the pictures together in book form by one edge, and then release them from the other in rapid succession by means of the thumb or some mechanical device as the book is bent backwards. In this case the subject is viewed, not by projection, but directly, either with the unaided eye or through a magnifying glass.

Cinematograph films produced by ordinary photographic processes, being in black and white only, fail to reproduce the colouring of the subjects they represent. To some extent this defect has been remedied by painting them by hand, but this method is too expensive for general adoption, and moreover does not yield very satisfactory results. Attempts to adapt three-colour photography, by using simultaneously three films, each with a source of light of appropriate colour, and combining the three images on the screen, have to overcome great difficulties in regard to maintenance of register, because very minute errors of adjustment between the pictures on the films are magnified to an intolerable extent by projection. In a process devised by G. A. Smith, the results of which were exhibited at the Society of Arts, London, in December 1908, the number of colour records was reduced to two. The films were specially treated to increase their sensitiveness to red. The photographs were taken through two colour filters alternately interposed in front of the film; both admitted white and yellow, but one, of red, was in addition specially concerned with the orange and red of the subject, and the other, of blue-green, with the green, blue-green, blue and violet. The camera was arranged to take not less than 16 pictures a second through each filter, or 32 a second in all. The positive transparency made from the negative thus obtained

was used in a lantern so arranged that beams of red (composed of crimson and yellow) and of green (composed of yellow and blue) issued from the lens alternately, the mechanism presenting the pictures made with the red filter to the red beam, and those made with the green filter to the green beam. A supplementary shutter was provided to introduce violet and blue, to compensate for the deficiency in those colours caused by the necessity of cutting them out in the camera owing to the over-sensitiveness of the film to them, and the result was that the successive pictures, blending on the screen by persistence of vision, gave a reproduction of the scene photographed in colours which were sensibly the same as those of the original.

The cinematograph enables "living" or "animated pictures" of such subjects as an army on the march, or an express train at full speed, to be presented with marvellous distinctness and completeness of detail. Machines of this kind have been devised in enormous numbers and used for purposes of amusement under names (bioscope, biograph, kinoscope, mutograph, &c.) formed chiefly from combinations of Greek and Latin words for life, movement, change, &c., with suffixes taken from such words as *σκοπεῖν*, to see, *γράφειν*, to depict; they have also been combined with phonographic apparatus, so that, for example, the music of a dance and the motions of the dancer are simultaneously reproduced to ear and eye. But when they are used in public places of entertainment, owing to the extreme inflammability of the celluloid film and its employment in close proximity to a powerful source of light and heat, such as is required if the pictures are to show brightly on the screen, precautions must be taken to prevent, as far as possible, the heat rays from reaching it, and effective means must be provided to extinguish it should it take fire. The production of films composed of non-inflammable material has also engaged the attention of inventors.

See H. V. Hopwood, *Living Pictures* (London, 1899), containing a bibliography and a digest of the British patents, which is supplemented in the *Optician*, vol. xviii. p. 85; Eugène Trutat, *La Photographie animée* (1899), which contains a list of the French patents. For the camera see also PHOTOGRAPHY: *Apparatus*.

CINERARIA. The garden plants of this name have originated from a species of *Senecio*, *S. cruentus* (nat. ord. Compositae), a native of the Canary Isles, introduced to the royal gardens at Kew in 1777. It was known originally as *Cineraria cruenta*, but the genus *Cineraria* is now restricted to a group of South African species, and the Canary Island species has been transferred to the large and widespread genus *Senecio*. *Cinerarias* can be raised freely from seeds. For spring flowering in England the seeds are sown in April or May in well-drained pots or pans, in soil of three parts loam to two parts leaf-mould, with one-sixth sand; cover the seed thinly with fine soil, and press the surface firm. When the seedlings are large enough to handle, prick them out in pans or pots of similar soil, and when more advanced pot them singly in 4-in. pots, using soil a trifle less sandy. They should be grown in shallow frames facing the north, and, if so situated that the sun shines upon the plants in the middle of the day, they must be slightly shaded; give plenty of air, and never allow them to get dry. When well established with roots, shift them into 6-in. pots, which should be liberally supplied with manure water as they get filled with roots. In winter remove to a pit or house, where a little heat can be supplied whenever there is a risk of their getting frozen. They should stand on a moist bottom, but must not be subjected to cold draughts. When the flowering stems appear, give manure water at every alternate watering. Seeds sown in March, and grown on in this way, will be in bloom by Christmas if kept in a temperature of from 40° to 45° at night, with a little more warmth in the day; and those sown in April and May will succeed them during the early spring months, the latter set of plants being subjected to a temperature of 38° or 40° during the night. If grown much warmer than this, the *Cineraria* maggot will make its appearance in the leaves, tunnelling its way between the upper and lower surfaces and making whitish irregular markings all over. Such affected leaves must be picked off and burned. Green fly is a

great pest on young plants, and can only be kept down by fumigating or vaporizing the houses, and syringing with a solution of quassia chips, soft soap and tobacco.

CINGOLI (anc. *Cingulum*), a town of the Marches, Italy, in the province of Macerata, about 14 m. N.W. direct, and 17 m. by road, from the town of Macerata. Pop. (1901) 13,357. The Gothic church of S. Esuperanzio contains interesting works of art. The town occupies the site of the ancient Cingulum, a town of Picenum, founded and strongly fortified by Caesar's lieutenant T. Labienus (probably on the site of an earlier village) in 63 B.C. at his own expense. Its lofty position (2300 ft.) made it of some importance in the civil wars, but otherwise little is heard of it. Under the empire it was a *municipium*.

CINNA, a Roman patrician family of the gens Cornelia. The most prominent member was LUCIUS CORNELIUS CINNA, a supporter of Marius in his contest with Sulla. After serving in the war with the Marsi as praetorian legate, he was elected consul in 87 B.C. Breaking the oath he had sworn to Sulla that he would not attempt any revolution in the state, Cinna allied himself with Marius, raised an army of Italians, and took possession of the city. Soon after his triumphant entry and the massacre of the friends of Sulla, by which he had satisfied his vengeance, Marius died. L. Valerius Flaccus became Cinna's colleague, and on the murder of Flaccus, Cn. Papirius Carbo. In 84, however, Cinna, who was still consul, was forced to advance against Sulla; but while embarking his troops to meet him in Thessaly, he was killed in a mutiny. His daughter Cornelia was the wife of Julius Caesar, the dictator; but his son, L. CORNELIUS CINNA, praetor in 44 B.C., nevertheless sided with the murderers of Caesar and publicly extolled their action.

The hero of Corneille's tragedy *Cinna* (1640) was Cn. Cornelius Cinna, surnamed *Magnus* (after his maternal grandfather Pompey), who was magnanimously pardoned by Augustus for conspiring against him.

CINNA, GAIVS HELVIUS, Roman poet of the later Ciceronian age. Practically nothing is known of his life except that he was the friend of Catullus, whom he accompanied to Bithynia in the suite of the praetor Memmius. The circumstances of his death have given rise to some discussion. Suetonius, Valerius Maximus, Appian and Dio Cassius all state that, at Caesar's funeral, a certain Helvius Cinna was killed by mistake for Cornelius Cinna, the conspirator. The last three writers mentioned above add that he was a tribune of the people, while Plutarch, referring to the affair, gives the further information that the Cinna who was killed by the mob was a poet. This points to the identity of Helvius Cinna the tribune with Helvius Cinna the poet. The chief objection to this view is based upon two lines in the 9th eclogue of Virgil, supposed to have been written 41 or 40 B.C. Here reference is made to a certain Cinna, a poet of such importance that Virgil deprecates comparison with him; it is argued that the manner in which this Cinna, who could hardly have been any one but Helvius Cinna, is spoken of implies that he was then alive; if so, he could not have been killed in 44. But such an interpretation of the Virgilian passage is by no means absolutely necessary; the terms used do not preclude a reference to a contemporary no longer alive. It has been suggested that it was really Cornelius, not Helvius Cinna, who was slain at Caesar's funeral, but this is not borne out by the authorities. Cinna's chief work was a mythological epic poem called *Smyrna*, the subject of which was the incestuous love of Smyrna (or Myrrha) for her father Cinyras, treated after the manner of the Alexandrian poets. It is said to have taken nine years to finish. A *Propempticon Pollionis*, a send-off to [Asinius] Pollio, is also attributed to him. In both these poems, the language of which was so obscure that they required special commentaries, his model appears to have been Parthenius of Nicaea.

See A. Weichert, *Poëtarum Latinorum Vitae* (1830); L. Müller's edition of Catullus (1870), where the remains of Cinna's poems are printed; A. Kiessling, "De C. Helvio Cinna Poëta" in *Commentationes Philologicae in honorem T. Mommsen* (1878); O. Ribbeck, *Geschichte der römischen Dichtung*, i. (1887); Teuffel-Schwabe, *Hist. of Roman Lit.* (Eng. tr. 213, 2-5); Plessis, *Poësie latine* (1909).

CINNABAR (Ger. *Zinnober*), sometimes written cinnabarite, a name applied to red mercuric sulphide (HgS), or native vermilion, the common ore of mercury. The name comes from the Greek *κιννάβαρι*, used by Theophrastus, and probably applied to several distinct substances. Cinnabar is generally found in a massive, granular or earthy form, of bright red colour, but it occasionally occurs in crystals, with a metallic adamantine lustre. The crystals belong to the hexagonal system, and are generally of rhombohedral habit, sometimes twinned. Cinnabar presents remarkable resemblance to quartz in its symmetry and optical characters. Like quartz it exhibits circular polarization, and A. Des Cloizeaux showed that it possessed fifteen times the rotatory power of quartz (see POLARIZATION OF LIGHT). Cinnabar has higher refractive power than any other known mineral, its mean index for sodium light being 3.02, whilst the index for diamond—a substance of remarkable refraction—is only 2.42 (see REFRACTION). The hardness of cinnabar is 3, and its specific gravity 8.998.

Cinnabar is found in all localities which yield quicksilver, notably Almaden (Spain), New Almaden (California), Idria (Austria), Landsberg, near Ober-Moschel in the Palatinate, Ripa, at the foot of the Apuan Alps (Tuscany), the mountain Avala (Servia), Huancavelica (Peru), and the province of Kweichow in China, whence very fine crystals have been obtained. Cinnabar is in course of deposition at the present day from the hot waters of Sulphur Bank, in California, and Steamboat Springs, Nevada.

Hepatic cinnabar is an impure variety from Idria in Carniola, in which the cinnabar is mixed with bituminous and earthy matter.

Metacinnabarite is a cubic form of mercuric sulphide, this compound being dimorphous.

For a general description of cinnabar, see G. F. Becker's *Geology of the Quicksilver Deposits of the Pacific Slope*, U.S. Geol. Surv. Monographs, No. xiii. (1888). (F. W. R.*)

CINNAMIC ACID, or **PHENYLACRYLIC ACID**, $C_9H_8O_2$ or $C_6H_5\cdot CH:CH\cdot COOH$, an acid found in the form of its benzyl ester in Peru and Tolu balsams, in storax and in some gumbenzoin. It can be prepared by the reduction of phenyl propionic acid with zinc and acetic acid, by heating benzal malonic acid, by the condensation of ethyl acetate with benzaldehyde in the presence of sodium ethylate or by the so-called "Perkin reaction"; the latter being the method commonly employed. In making the acid by this process benzaldehyde, acetic anhydride and anhydrous sodium acetate are heated for some hours to about 180° C., the resulting product is made alkaline with sodium carbonate, and any excess of benzaldehyde removed by a current of steam. The residual liquor is filtered and acidified with hydrochloric acid, when cinnamic acid is precipitated, $C_6H_5\cdot CHO + CH_2\cdot COONa = C_6H_5\cdot CH:CH\cdot COONa + H_2O$. It may be purified by recrystallization from hot water. Considerable controversy has taken place as to the course pursued by this reaction, but the matter has been definitely settled by the work of R. Fittig and his pupils (*Annalen*, 1883, 216, pp. 100, 115; 1885, 227, pp. 55, 119), in which it was shown that the aldehyde forms an addition compound with the sodium salt of the fatty acid, and that the acetic anhydride plays the part of a dehydrating agent. Cinnamic acid crystallizes in needles or prisms, melting at 133° C.; on reduction it gives *phenyl propionic acid*, $C_6H_5\cdot CH_2\cdot CH_2\cdot COOH$. Nitric acid oxidizes it to benzoic acid and acetic acid. Potash fusion decomposes it into benzoic and acetic acids. Being an unsaturated acid it combines directly with hydrochloric acid, hydrobromic acid, bromine, &c. On nitration it gives a mixture of ortho and para nitrocinnamic acids, the former of which is of historical importance, as by converting it into orthonitrophenyl propionic acid A. Baeyer was enabled to carry out the complete synthesis of indigo (*q.v.*). Reduction of orthonitrocinnamic acid gives orthoaminocinnamic acid, $C_6H_4(NH_2)CH:CH\cdot COOH$, which is of theoretical importance, as it readily gives a quinoline derivative. An isomer of cinnamic acid known as *allo-cinnamic acid* is also known.

For the oxy-cinnamic acids see COUMARIN.

CINNAMON, the inner bark of *Cinnamomum zeylanicum*, a small evergreen tree belonging to the natural order Lauraceae, native to Ceylon. The leaves are large, ovate-oblong in shape, and the flowers, which are arranged in panicles, have a greenish colour and a rather disagreeable odour. Cinnamon has been known from remote antiquity, and it was so highly prized among ancient nations that it was regarded as a present fit for monarchs and other great potentates. It is mentioned in Exod. xxx. 23, where Moses is commanded to use both sweet cinnamon (*Kiunnamon*) and cassia, and it is alluded to by Herodotus under the name *κιννάμωμον*, and by other classical writers. The tree is grown at Tellicherry, in Java, the West Indies, Brazil and Egypt, but the produce of none of these places approaches in quality that grown in Ceylon. Ceylon cinnamon of fine quality is a very thin smooth bark, with a light-yellowish brown colour, a highly fragrant odour, and a peculiarly sweet, warm and pleasing aromatic taste. Its flavour is due to an aromatic oil which it contains to the extent of from 0.5 to 1%. This essential oil, as an article of commerce, is prepared by roughly pounding the bark, macerating it in sea-water, and then quickly distilling the whole. It is of a golden-yellow colour, with the peculiar odour of cinnamon and a very hot aromatic taste. It consists essentially of cinnamic aldehyde, and by the absorption of oxygen as it becomes old it darkens in colour and develops resinous compounds. Cinnamon is principally employed in cookery as a condiment and flavouring material, being largely used in the preparation of some kinds of chocolate and liqueurs. In medicine it acts like other volatile oils and has a reputation as a cure for colds. Being a much more costly spice than cassia, that comparatively harsh-flavoured substance is frequently substituted for or added to it. The two barks when whole are easily enough distinguished, and their microscopical characters are also quite distinct. When powdered bark is treated with tincture of iodine, little effect is visible in the case of pure cinnamon of good quality, but when cassia is present a deep-blue tint is produced, the intensity of the coloration depending on the proportion of the cassia.

CINNAMON-STONE, a variety of garnet, belonging to the lime-alumina type, known also as essonite or hessonite, from the Gr. *ἡσσων*, "inferior," in allusion to its being less hard and less dense than most other garnet. It has a characteristic red colour, inclining to orange, much like that of hyacinth or jacinth. Indeed it was shown many years ago, by Sir A. H. Church, that many gems, especially engraved stones, commonly regarded as hyacinth, were really cinnamon-stone. The difference is readily detected by the specific gravity, that of hessonite being 3.64 to 3.69, whilst that of hyacinth (zircon) is about 4.6. Hessonite is rather a soft stone, its hardness being about that of quartz or 7, whilst the hardness of most garnet reaches 7.5. Cinnamon-stone comes chiefly from Ceylon, where it is found generally as pebbles, though its occurrence in its native matrix is not unknown.

CINNAMUS [ΚΙΝΝΑΜΟΣ], JOHN, Byzantine historian, flourished in the second half of the 12th century. He was imperial secretary (probably in this case a post connected with the military administration) to Manuel I. Comnenus (1143-1180), whom he accompanied on his campaigns in Europe and Asia Minor. He appears to have outlived Andronicus I., who died in 1185. Cinnamus was the author of a history of the period 1118-1176, which thus continues the *Alexiad* of Anna Comnena, and embraces the reigns of John II. and Manuel I., down to the unsuccessful campaign of the latter against the Turks, which ended with the disastrous battle of Myriokephalon and the rout of the Byzantine army. Cinnamus was probably an eye-witness of the events of the last ten years which he describes. The work breaks off abruptly; originally it no doubt went down to the death of Manuel, and there are indications that, even in its present form, it is an abridgment. The text is in a very corrupt state. The author's hero is Manuel; he is strongly impressed with the superiority of the East to the West, and is a determined opponent of the pretensions of the papacy. But he cannot be reproached with undue bias; he writes with the

straightforwardness of a soldier, and is not ashamed on occasion to confess his ignorance. The matter is well arranged, the style (modelled on that of Xenophon) simple, and on the whole free from the usual florid bombast of the Byzantine writers.

Editio princeps, C. Tollius (1652); in Bonn, *Corpus Scriptorum Hist. Byz.*, by A. Meineke (1836), with Du Cange's valuable notes; Migne, *Patrologia Graeca*, cxxxiii.; see also C. Neumann, *Griechisch-Geschichtsschreiber im 12. Jahrhundert* (1888); H. von Kap-Herr, *Die abendländische Politik Kaiser Manuels* (1881); C. Krumbacher, *Geschichte der byzantinischen Litteratur* (1897).

CINNOLIN, $C_8H_6N_2$, a compound isomeric with pthalazine, prepared by boiling dihydrocinnolin dissolved in benzene with freshly precipitated mercuric oxide. The solution is filtered and the hydrochloride of the base precipitated by alcoholic hydrochloric acid; the free base is obtained as an oil by adding caustic soda. It may be obtained in white silky needles, melting at 24-25° C. and containing a molecule of ether of crystallization by cooling the oil dissolved in ether. The free base melts at 39° C. It is a strong base, forming stable salts with mineral acids, and is easily soluble in water and in the ordinary organic solvents. It has a taste resembling that of chloral hydrate, and leaves a sharp irritation for some time on the tongue; it is also very poisonous (M. Busch and A. Rast, *Berichte*, 1897, 30, p. 521). Cinnolin derivatives are obtained from oxycinnolin carboxylic acid, which is formed by digesting orthophenyl propiolic acid diazo chloride with water. Oxycinnolin carboxylic acid on heating gives oxycinnolin, melting at 225°, which with phosphorus pentachloride gives chlorcinnolin. This substance is reduced by iron filings and sulphuric acid to dihydrocinnolin.

The relations of these compounds are here shown:—

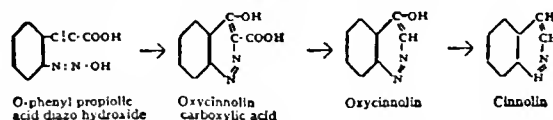

CINO DA PISTOIA (1270-1336), Italian poet and jurist, whose full name was GUFFONCINO DE' SINIBALDI, was born in Pistoia, of a noble family. He studied law at Bologna under Dinus Muggelanus (Dino de Rossonis: d. 1303) and Franciscus Accursius, and in 1307 is understood to have been assessor of civil causes in his native city. In that year, however, Pistoia was disturbed by the Guelph and Ghibelline feud. The Ghibellines, who had for some time been the stronger party, being worsted by the Guelphs, Cino, a prominent member of the former faction, had to quit his office and the city of his birth. Pitecchio, a stronghold on the frontiers of Lombardy, was yet in the hands of Filippo Vergiolesi, chief of the Pistoian Ghibellines; Selvaggia, his daughter, was beloved by Cino (who was probably already the husband of Margherita degli Ungni); and to Pitecchio did the lawyer-poet betake himself. It is uncertain how long he remained at the fortress; it is certain, however, that he was not with the Vergiolesi at the time of Selvaggia's death, which happened three years afterwards (1310), at the Monte della Sambuca, in the Apennines, whither the Ghibellines had been compelled to shift their camp. He visited his mistress's grave on his way to Rome, after some time spent in travel in France and elsewhere, and to this visit is owing his finest sonnet. At Rome Cino held office under Louis of Savoy, sent thither by the Ghibelline leader Henry of Luxemburg, who was crowned emperor of the Romans in 1312. In 1313, however, the emperor died, and the Ghibellines lost their last hope. Cino appears to have thrown up his party, and to have returned to Pistoia. Thereafter he devoted himself to law and letters. After filling several high judicial offices, a doctor of civil law of Bologna in his forty-fourth year, he lectured and taught from the professor's chair at the universities of Treviso, Siena, Florence and Perugia in succession; his reputation and success were great, his judicial experience enabling him to travel out of the routine of the schools. In literature he continued in some sort the tradition of Dante during the interval dividing that great poet from his successor Petrarch. The latter, besides celebrating Cino in an obituary

sonnet, has coupled him and his Selvaggia with Dante and Beatrice in the fourth *capitolo* of his *Trionfi d' Amore*.

Cino, the master of Bartolus, and of Joannes Andreae the celebrated canonist, was long famed as a jurist. His commentary on the statutes of Pistoia, written within two years, is said to have great merit; while that on the code (*Lectura Cino Pistoia super codice*, Pavia, 1483; Lyons, 1526) is considered by Savigny to exhibit more practical intelligence and more originality of thought than are found in any commentary on Roman law since the time of Accursius. As a poet he also distinguished himself greatly. He was the friend and correspondent of Dante's later years, and possibly of his earlier also, and was certainly, with Guido Cavalcanti and Durante da Maiano, one of those who replied to the famous sonnet *A ciascun' alma presa e gentil core* of the *Vita Nuova*. In the treatise *De Vulgari Eloquio* Dante refers to him as one of "those who have most sweetly and subtly written poems in modern Italian," but his works, printed at Rome in 1559, do not altogether justify the praise. Strained and rhetorical as many of his outcries are, however, Cino is not without moments of true passion and fine natural eloquence. Of these qualities the sonnet in memory of Selvaggia, *Io fui in sull' alto e in sul beato monte*, and the canzone to Dante, *Avegnachè di omaggio più per tempo*, are interesting examples.

The text-book for English readers is D. G. Rossetti's *Early Italian Poets*, wherein will be found not only a memoir of Cino da Pistoia, but also some admirably translated specimens of his verse—the whole wrought into significant connexion with that friendship of Cino's which is perhaps the most interesting fact about him. See also Ciampi, *Vita e poesie di messer Cino da Pistoia* (Pisa, 1813).

CINQ-MARS, HENRI COIFFIER RUZÉ D'EFFIAT, MARQUIS DE (1620-1642), French courtier, was the second son of Antoine Coiffier Ruzé, marquis d'Effiat, marshal of France (1581-1632), and was introduced to the court of Louis XIII. by Richelieu, who had been a friend of his father and who hoped he would counteract the influence of the queen's favourite Mlle. de Hautefort. Owing to his handsome appearance and agreeable manners he soon became a favourite of the king, and was made successively master of the wardrobe and master of the horse. After distinguishing himself at the siege of Arras in 1640, Cinq-Mars wished for a high military command, but Richelieu opposed his pretensions and the favourite talked rashly about overthrowing the minister. He was probably connected with the abortive rising of the count of Soissons in 1641; however that may be, in the following year he formed a conspiracy with the duke of Bouillon and others to overthrow Richelieu. This plot was under the nominal leadership of the king's brother Gaston of Orleans. The plans of the conspirators were aided by the illness of Richelieu and his absence from the king, and at the siege of Narbonne Cinq-Mars almost induced Louis to agree to banish his minister. Richelieu, however, recovered, became acquainted with the attempt of Cinq-Mars to obtain assistance from Spain, and laid the proofs of his treason before the king, who ordered his arrest. Cinq-Mars was brought to trial, admitted his guilt, and was condemned to death. He was executed at Lyons on the 12th of September 1642. It is possible that Cinq-Mars was urged to engage in this conspiracy by his affection for Louise Marie de Gonzaga (1612-1667), afterwards queen of Poland, who was a prominent figure at the court of Louis XIII.; and this tradition forms part of the plot of Alfred de Vigny's novel *Cinq-Mars*.

See Le P. Griffet, *Histoire de Louis XIII.*; A. Bazin, *Histoire de Louis XIII* (1846); L. D'Astarac de Frontrailles, *Relations des choses particulières de la cour pendant la faveur de M. de Cinq-Mars*.

CINQUE CENTO (Italian for five hundred; short for 1500), in architecture, the style which became prevalent in Italy in the century following 1500, now usually called "16th-century work." It was the result of the revival of classic architecture known as Renaissance, but the change had commenced already a century earlier, in the works of Ghiberti and Donatello in sculpture, and of Brunelleschi and Alberti in architecture.

CINQUE PORTS, the name of an ancient jurisdiction in the south of England, which is still maintained with considerable modifications and diminished authority. As the name implies,

the ports originally constituting the body were only five in number—Hastings, Romney, Hythe, Dover and Sandwich; but to these were afterwards added the "ancient towns" of Winchelsea and Rye with the same privileges, and a good many other places, both corporate and non-corporate, which, with the title of limb or member, held a subordinate position. To Hastings were attached the corporate members of Pevensey and Seaford, and the non-corporate members of Bulvarhythe, Petit Iham (Yham or Higham), Hydney, Bekesbourn, Northey and Grenche or Grange; to Romney, Lydd, and Old Romney, Dengemarsh, Orwaldstone, and Bromhill or Promehill; to Dover, Folkestone and Faversham, and Margate, St John's, Goresend (now Birchington), Birchington Wood (now Woodchurch), St Peter's, Kingsdown and Ringwoud; to Sandwich, Fordwich and Deal, and Walmer, Ramsgate, Reculver, Stonor (Estanor), Sarre (or Serre) and Brightlingsca (in Essex). To Rye was attached the corporate member of Tenterden, and to a Hythe the non-corporate member of West Hythe. The jurisdiction thus extends along the coast from Seaford in Sussex to Birchington near Margate in Kent; and it also includes a number of inland districts, at a considerable distance from the ports with which they are connected. The non-incorporated members are within the municipal jurisdiction of the ports to which they are attached; but the corporate members are as free within their own liberties as the individual ports themselves.

The incorporation of the Cinque Ports had its origin in the necessity for some means of defence along the southern seaboard of England, and in the lack of any regular navy. Up to the reign of Henry VII. they had to furnish the crown with nearly all the ships and men that were needful for the state; and for a long time after they were required to give large assistance to the permanent fleet. The oldest charter now on record is one belonging to the 6th year of Edward I.; and it refers to previous documents of the time of Edward the Confessor and William the Conqueror. In return for their services the ports enjoyed extensive privileges. From the Conquest or even earlier they had, besides various lesser rights—(1) exemption from tax and tallage; (2) soc and sac, or full cognizance of all criminal and civil cases within their liberties; (3) tol and team, or the right of receiving toll and the right of compelling the person in whose hands stolen property was found to name the person from whom he received it; (4) blodwit and fledwit, or the right to punish shedders of blood and those who were seized in an attempt to escape from justice; (5) pillory and tumbrel; (6) infangentheof and outfangentheof, or power to imprison and execute felons; (7) mundbryce (the breaking into or violation of a man's *mund* or property in order to erect banks or dikes as a defence against the sea); (8) waives and strays, or the right to appropriate lost property or cattle not claimed within a year and a day; (9) the right to seize all flotsam, jetsam, or ligam, or, in other words, whatever of value was cast ashore by the sea; (10) the privilege of being a gild with power to impose taxes for the common weal; and (11) the right of assembling in portmote or parliament at Shepway or Shepway Cross, a few miles west of Hythe (but afterwards at Dover), the parliament being empowered to make by-laws for the Cinque Ports, to regulate the Yarmouth fishery, to hear appeals from the local courts, and to give decision in all cases of treason, sedition, illegal coining or concealment of treasure trove. The ordinary business of the ports was conducted in two courts known respectively as the court of brotherhood and the court of brotherhood and guestling,—the former being composed of the mayors of the seven principal towns and a number of jurats and freemen from each, and the latter including in addition the mayors, bailiffs and other representatives of the corporate members. The court of brotherhood was formerly called the brothereyeld, broddall or brodhull; and the name guestling seems to owe its origin to the fact that the officials of the "members" were at first in the position of invited guests.

The highest office in connexion with the Cinque Ports is that of the lord warden, who also acts as governor of Dover Castle, and has a maritime jurisdiction (*vide infra*) as admiral of the

ports. His power was formerly of great extent, but he has now practically no important duty to exercise except that of chairman of the Dover harbour board. The emoluments of the office are confined to certain insignificant admiralty droits. The patronage attached to the office consists of the right to appoint the judge of the Cinque Ports admiralty court, the registrar of the Cinque Ports and the marshal of the court; the right of appointing salvage commissioners at each Cinque Port and the appointment of a deputy to act as chairman of the Dover harbour board in the absence of the lord warden. Walmer Castle was for long the official residence of the lord warden, but has, since the resignation of Lord Curzon in 1903, ceased to be so used, and those portions of it which are of historic interest are now open to the public. George, prince of Wales (lord warden, 1903-1907), was the first lord warden of royal blood since the office was held by George, prince of Denmark, consort of Queen Anne.

Admiralty Jurisdiction.—The court of admiralty for the Cinque Ports exercises a co-ordinate but not exclusive admiralty jurisdiction over persons and things found within the territory of the Cinque Ports. The limits of its jurisdiction were declared at an inquisition taken at the court of admiralty, held by the seaside at Dover in 1682, to extend from Shore Beacon in Essex to Redcliff, near Seaford, in Sussex; and with regard to salvage, they comprise all the sea between Seaford in Sussex to a point five miles off Cape Grisnez on the coast of France, and the coast of Essex. An older inquisition of 1526 is given by R.G. Marsden in his *Select Pleas of the Court of Admiralty*, II. xxx. The court is an ancient one. The judge sits as the official and commissary of the lord warden, just as the judge of the high court of admiralty sat as the official and commissary of the lord high admiral. And, as the office of lord warden is more ancient than the office of lord high admiral (*The Lord Warden v. King in his office of Admiralty*, 1831, 2 Hagg. Admy. Rep. 438), it is probable that the Cinque Ports court is the more ancient of the two.

The jurisdiction of the court has been, except in one matter of mere antiquarian curiosity, unaffected by statute. It exercises only, therefore, such jurisdiction as the high court of admiralty exercised, apart from restraining statutes of 1389 and 1391 and enabling statutes of 1840 and 1861. Cases of collision have been tried in it (the "Vivid," 1 *Asp. Maritime Law Cases*, 601). But salvage cases (the "Clarisse," *Swabey*, 129; the "Marie," *Law. Rep. 7 P.D.* 203) are the principal cases now tried. It has no prize jurisdiction. The one case in which jurisdiction has been given to it by statute is to enforce forfeitures under the statute of 1538.

Dr (afterwards the Right Hon. Robert Joseph) Phillimore succeeded his father as judge of the court from 1855 to 1875, being succeeded by Mr Arthur Cohen, K.C. As Sir R. Phillimore was also the last judge of the high court of admiralty, from 1867 (the date of his appointment to the high court) to 1875, the two offices were, probably for the first time in history, held by the same person. Dr Phillimore's patent had a grant of the "place or office of judge official and commissary of the court of admiralty of the Cinque Ports, and their members and appurtenances, and to be assistant to my lieutenant of Dover castle in all such affairs and business concerning the said court of admiralty wherein yourself and assistance shall be requisite and necessary." Of old the court sat sometimes at Sandwich, sometimes at other ports. But the regular place for the sitting of the court has for a long time been, and still is, the aisle of St James's church, Dover. For convenience the judge often sits at the royal courts of justice. The office of marshal in the high court is represented in this court by a serjeant, who also bears a silver oar. There is a registrar, as in the high court. The appeal is to the king in council, and is heard by the judicial committee of the privy council. The court can hear appeals from the Cinque Ports salvage commissioners, such appeals being final (Cinque Ports Act 1821). Actions may be transferred to it, and appeals made to it, from the county courts in all cases arising within the jurisdiction of the Cinque Ports as defined by that act. At the solemn installation of the lord warden the judge as the next principal officer installs him.

The Cinque Ports from the earliest times claimed to be exempt from the jurisdiction of the admiral of England. Their early charters do not, like those of Bristol and other seaports, express this exemption in terms. It seems to have been derived from the general words of the charters which preserve their liberties and privileges.

The lord warden's claim to prize was raised in, but not finally decided by, the high court of admiralty in the "Ooster Ems," 1 C. Rob. 284, 1783.

See S. Jeake, *Charters of the Cinque Ports* (1728); Boys, *Sandwich and Cinque Ports*; Knocker, *Grand Court of Shepway* (1862); M. Burrows, *Cinque Ports* (1895); F. M. Hueffer, *Cinque Ports* (1900); *Indices of the Great White and Black Books of the Cinque Ports* (1905).

CINTRA, a town of central Portugal, in the district of Lisbon, formerly included in the province of Estramadura; 17 m. W.N.W. of Lisbon by the Lisbon-Caçem-Cintra railway, and 6 m. N. by E. of Cape da Roca, the westernmost promontory of the European mainland. Pop. (1900) 5914. Cintra is magnificently situated on the northern slope of the Serra da Cintra, a rugged mountain mass, largely overgrown with pines, eucalyptus, cork and other forest trees, above which the principal summits rise in a succession of bare and jagged grey peaks; the highest being Cruz Alta (1772 ft.), marked by an ancient stone cross, and commanding a wonderful view southward over Lisbon and the Tagus estuary, and north-westward over the Atlantic and the plateau of Mafra. Few European towns possess equal advantages of position and climate; and every educated Portuguese is familiar with the verses in which the beauty of Cintra is celebrated by Byron in *Childe Harold* (1812), and by Camoens in the national epic *Os Lusíadas* (1572). One of the highest points of the Serra is surmounted by the Palacio da Pena, a fantastic imitation of a medieval fortress, built on the site of a Hieronymite convent by the prince consort Ferdinand of Saxe-Coburg (d. 1885); while an adjacent part of the range is occupied by the Castello des Mouros, an extensive Moorish fortification, containing a small ruined mosque and a very curious set of ancient cisterns. The lower slopes of the Serra are covered with the gardens and villas of the wealthier inhabitants of Lisbon, who migrate hither in spring and stay until late autumn.

In the town itself the most conspicuous building is a 14th-15th-century royal palace, partly Moorish, partly debased Gothic in style, and remarkable for the two immense conical chimneys which rise like towers in the midst. The 18th-century Palacio de Seteas, built in the French style then popular in Portugal, is said to derive its name ("Seven Ahs") from a sevenfold echo; here, on the 22nd of August 1808, was signed the convention of Cintra, by which the British and Portuguese allowed the French army to evacuate the kingdom without molestation. Beside the road which leads for 3½ m. W. to the village of Collares, celebrated for its wine, is the Penha Verde, an interesting country house and chapel, founded by João de Castro (1500-1548), fourth viceroy of the Indies. De Castro also founded the convent of Santa Cruz, better known as the Convento de Cortiça or Cork convent, which stands at the western extremity of the Serra, and owes its name to the cork panels which formerly lined its walls. Beyond the Penha Verde, on the Collares road, are the palace and park of Montserrat. The palace was originally built by William Beckford, the novelist and traveller (1761-1844), and was purchased in 1856 by Sir Francis Cook, an Englishman who afterwards obtained the Portuguese title viscount of Montserrat. The palace, which contains a valuable library, is built of pure white stone, in Moorish style; its walls are elaborately sculptured. The park, with its tropical luxuriance of vegetation and its variety of lake, forest and mountain scenery, is by far the finest example of landscape gardening in the Iberian Peninsula, and probably among the finest in the world. Its high-lying lawns, which overlook the Atlantic, are as perfect as any in England, and there is one ravine containing a whole wood of giant tree-ferns from New Zealand. Other rare plants have been systematically collected and brought to Montserrat from all parts of the world by Sir Francis Cook, and afterwards by his successor, Sir

Frederick Cook, the second viscount. The Praia das Maças, or "beach of apples," in the centre of a rich fruit-bearing valley, is a favourite sea-bathing station, connected with Cintra by an extension of the electric tramway which runs through the town.

CIPHER, or **CYPHER** (from Arab. *ṣifr*, void), the symbol 0, nought, or zero; and so a name for symbolic or secret writing (see **CRYPTOGRAPHY**), or even for shorthand (*q.v.*), and also in elementary education for doing simple sums ("ciphering").

CIPPUS (Lat. for a "post" or "stake"), in architecture, a low pedestal, either round or rectangular, set up by the Romans for various purposes such as military or mile stones, boundary posts, &c. The inscriptions on some in the British Museum show that they were occasionally funeral memorials.

CIPRIANI, GIOVANNI BATTISTA (1727-1785), Italian painter and engraver, Pistoiese by descent, was born in Florence in 1727. His first lessons were given him by an Englishman, Ignatius Heckford, and under his second master, Antonio Domenico Gabbiani, he became a very clever draughtsman. He was in Rome from 1750 to 1753, where he became acquainted with Sir William Chambers, the architect, and Joseph Wilton, the sculptor, whom he accompanied to England in August 1755. He had already painted two pictures for the abbey of San Michele in Pelago, Pistoia, which had brought him reputation, and on his arrival in England he was patronized by Lord Tilney, the duke of Richmond and other noblemen. His acquaintance with Sir William Chambers no doubt helped him on, for when Chambers designed the Albany in London for Lord Holland, Cipriani painted a ceiling for him. He also painted part of a ceiling in Buckingham Palace, and a room with poetical subjects at Standlynch in Wiltshire. Some of his best and most permanent work was, however, done at Somerset House, built by his friend Chambers, upon which he lavished infinite pains. He not only prepared the decorations for the interior of the north block, but, says Joseph Baretti in his *Guide through the Royal Academy* (1780), "the whole of the carvings in the various fronts of Somerset Place—excepting Bacon's bronze figures—were carved from finished drawings made by Cipriani." These designs include the five masks forming the keystones to the arches on the courtyard side of the vestibule, and the two above the doors leading into the wings of the north block, all of which are believed to have been carved by Nollekens. The grotesque groups flanking the main doorways on three sides of the quadrangle and the central doorway on the terrace appear also to have been designed by Cipriani. The apartments in Sir William Chambers's stately palace that were assigned to the Royal Academy, into which it moved in 1780, owed much to Cipriani's graceful, if mannered, pencil. The central panel of the library ceiling was painted by Sir Joshua Reynolds, but the four compartments in the coves, representing Allegory, Fable, Nature and History, were Cipriani's. These paintings still remain at Somerset House, together with the emblematic painted ceiling, also his work, of what was once the library of the Royal Society. It was natural that Cipriani should thus devote himself to adorning the apartments of the academy, since he was an original member (1768) of that body, for which he designed the diploma so well engraved by Bartolozzi. In recognition of his services in this respect the members presented him in 1769 with a silver cup with a commemorative inscription. He was much employed by the publishers, for whom he made drawings in pen and ink, sometimes coloured. His friend Bartolozzi engraved most of them. Drawings by him are in both the British Museum and Victoria and Albert Museum. His best autograph engravings are "The Death of Cleopatra," after Benvenuto Cellini; "The Descent of the Holy Ghost," after Gabbiani; and portraits for Hollis's memoirs, 1780. He painted allegorical designs for George III.'s state coach—which is still in use—in 1782, and repaired Verrio's paintings at Windsor and Rubens's ceiling in the Banqueting House at Whitehall. If his pictures were often weak, his decorative treatment of children was usually exceedingly happy. Some of his most pleasing work was that which, directly or indirectly, he executed for the decoration of furniture. He designed many groups of nymphs and *amorini* and medallion subjects to form

the centre of Pergolesi's bands of ornament, and they were continually reproduced upon the elegant satin-wood furniture which was growing popular in his later days and by the end of the 18th century became a rage. Sometimes these designs were inlaid in marqueterie, but most frequently they were painted upon the satin-wood by other hands with delightful effect, since in the whole range of English furniture there is nothing more enchanting than really good finished satin-wood pieces. There can be little doubt that some of the beautiful furniture designed by the Adams was actually painted by Cipriani himself. He also occasionally designed handles for drawers and doors. Cipriani died at Hammersmith in 1785 and was buried at Chelsea, where Bartolozzi erected a monument to his memory. He had married an English lady, by whom he had two sons.

CIRCAR, an Indian term applied to the component parts of a *subah* or province, each of which is administered by a deputy-governor. In English it is principally employed in the name of the **NORTHERN CIRCARS**, used to designate a now obsolete division of the Madras presidency, which consisted of a narrow slip of territory lying along the western side of the Bay of Bengal from 15° 40' to 20° 17' N. lat. These Northern Circars were five in number, Chicacole, Rajahmundry, Ellore, Kondapalli and Guntur, and their total area was about 30,000 sq. m.

The district corresponds in the main to the modern districts of Kistna, Godavari, Vizagapatam, Ganjam and a part of Nellore. It was first invaded by the Mahommedans in 1471; in 1541 they conquered Kondapalli, and nine years later they extended their conquests over all Guntur and the districts of Masulipatam. But the invaders appear to have acquired only an imperfect possession of the country, as it was again wrested from the Hindu princes of Orissa about the year 1571, during the reign of Ibrahim, of the Kutb Shahi dynasty of Hyderabad or Golconda. In 1687 the Circars were added, along with the empire of Hyderabad, to the extensive empire of Aurangzeb. Salabat Jang, the son of the nizam ul mulk Asaf Jah, who was indebted for his elevation to the throne to the French East India Company, granted them in return for their services the district of Kondavid or Guntur, and soon afterwards the other Circars. In 1759, by the conquest of the fortress of Masulipatam, the dominion of the maritime provinces on both sides, from the river Gundlakamma to the Chilka lake, was necessarily transferred from the French to the British. But the latter left them under the administration of the nizam, with the exception of the town and fortress of Masulipatam, which were retained by the English East India Company. In 1765 Lord Clive obtained from the Mogul emperor Shah Alam a grant of the five Circars. Hereupon the fort of Kondapalli was seized by the British, and on the 12th of November 1766 a treaty of alliance was signed with Nizam Ali by which the Company, in return for the grant of the Circars, undertook to maintain troops for the nizam's assistance. By a second treaty, signed on the 1st of March 1768, the nizam acknowledged the validity of Shah Alam's grant and resigned the Circars to the Company, receiving as a mark of friendship an annuity of £50,000. Guntur, as the personal estate of the nizam's brother Basalat Jang, was excepted during his lifetime under both treaties. He died in 1782, but it was not till 1788 that Guntur came under British administration. Finally, in 1823, the claims of the nizam over the Northern Circars were bought outright by the Company, and they became a British possession.

CIRCASSIA, a name formerly given to the north-western portion of the Caucasus, including the district between the mountain range and the Black Sea, and extending to the north of the central range as far as the river Kuban. Its physical features are described in the article on the Russian province of **KUBAN**, with which it approximately coincides. The present article is confined to a consideration of the ethnographical relations and characteristics of the people, their history being treated under **CAUCASIA**.

The Cherkesses or Circassians, who gave their name to this region, of which they were until lately the sole inhabitants, are a peculiar race, differing from the other tribes of the Caucasus in

origin and language. They designate themselves by the name of Adigheb, that of Cherkesses being a term of Russian origin. By their long-continued struggles with the power of Russia, during a period of nearly forty years, they attracted the attention of the other nations of Europe in a high degree, and were at the same time an object of interest to the student of the history of civilization, from the strange mixture which their customs exhibited of chivalrous sentiment with savage customs. For this reason it may be still worth while to give a brief summary of their national characteristics and manners, though these must now be regarded as in great measure things of the past.

In the patriarchal simplicity of their manners, the mental qualities with which they were endowed, the beauty of form and regularity of feature by which they were distinguished, they surpassed most of the other tribes of the Caucasus. At the same time they were remarkable for their warlike and intrepid character, their independence, their hospitality to strangers, and that love of country which they manifested in their determined resistance to an almost overwhelming power during the period of a long and desolating war. The government under which they lived was a peculiar form of the feudal system. The free Circassians were divided into three distinct ranks, the princes or *pshi*, the nobles or *work* (Tatar *usden*), and the peasants or *hokoll*. Like the inhabitants of the other regions of the Caucasus, they were also divided into numerous families, tribes or clans, some of which were very powerful, and carried on war against each other with great animosity. The slaves, of whom a large proportion were prisoners of war, were generally employed in the cultivation of the soil, or in the domestic service of some of the principal chiefs.

The will of the people was acknowledged as the supreme source of authority; and every free Circassian had a right to express his opinion in those assemblies of his tribe in which the questions of peace and war, almost the only subjects which engaged their attention, were brought under deliberation. The princes and nobles, the leaders of the people in war and their rulers in peace, were only the administrators of a power which was delegated to them. As they had no written laws, the administration of justice was regulated solely by custom and tradition, and in those tribes professing Mahommedanism by the precepts of the Koran. The most aged and respected inhabitants of the various *auls* or villages frequently sat in judgment, and their decisions were received without a murmur by the contending parties. The Circassian princes and nobles were professedly Mahommedans; but in their religious services many of the ceremonies of their former heathen and Christian worship were still preserved. A great part of the people had remained faithful to the worship of their ancient gods—Shible, the god of thunder, of war and of justice; Tleps, the god of fire; and Seosseres, the god of water and of winds. Although the Circassians are said to have possessed minds capable of the highest cultivation, the arts and sciences, with the exception of poetry and music, were completely neglected. They possessed no written language. The wisdom of their sages, the knowledge they had acquired, and the memory of their warlike deeds were preserved in verses, which were repeated from mouth to mouth and descended from father to son.

The education of the young Circassian was confined to riding, fencing, shooting, hunting, and such exercises as were calculated to strengthen his frame and prepare him for a life of active warfare. The only intellectual duty of the *atalik* or instructor, with whom the young men lived until they had completed their education, was that of teaching them to express their thoughts shortly, quickly and appropriately. One of their marriage ceremonies was very strange. The young man who had been approved by the parents, and had paid the stipulated price in money, horses, oxen, or sheep for his bride, was expected to come with his friends fully armed, and to carry her off by force from her father's house. Every free Circassian had unlimited right over the lives of his wife and children. Although polygamy was allowed by the laws of the Koran, the custom of the country forbade it, and the Circassians were generally faithful to the

marriage bond. The respect for superior age was carried to such an extent that the young brother used to rise from his seat when the elder entered an apartment, and was silent when he spoke. Like all the other inhabitants of the Caucasus, the Circassians were distinguished for two very opposite qualities—the most generous hospitality and implacable vindictiveness. Hospitality to the stranger was considered one of the most sacred duties. Whatever were his rank in life, all the members of the family rose to receive him on his entrance, and conduct him to the principal seat in the apartment. The host was considered responsible with his own life for the security of his guest, upon whom, even although his deadliest enemy, he would inflict no injury while under the protection of his roof. The chief who had received a stranger was also bound to grant him an escort of horse to conduct him in safety on his journey, and confide him to the protection of those nobles with whom he might be on friendly terms. The law of vengeance was no less binding on the Circassian. The individual who had slain any member of a family was pursued with implacable vengeance by the relatives, until his crime was expiated by death. The murderer might, indeed, secure his safety by the payment of a certain sum of money, or by carrying off from the house of his enemy a newly-born child, bringing it up as his own, and restoring it when its education was finished. In either case, the family of the slain individual might discontinue the pursuit of vengeance without any stain upon its honour. The man closely followed by his enemy, who, on reaching the dwelling of a woman, had merely touched her hand, was safe from all other pursuit so long as he remained under the protection of her roof. The opinions of the Circassians regarding theft resembled those of the ancient Spartans. The commission of the crime was not considered so disgraceful as its discovery; and the punishment of being compelled publicly to restore the stolen property to its original possessor, amid the derision of his tribe, was much dreaded by the Circassian who would glory in a successful theft. The greatest stain upon the Circassian character was the custom of selling their children, the Circassian father being always willing to part with his daughters, many of whom were bought by Turkish merchants for the harems of Eastern monarchs. But no degradation was implied in this transaction, and the young women themselves were generally willing partners in it. Herds of cattle and sheep constituted the chief riches of the inhabitants. The princes and nobles, from whom the members of the various tribes held the land which they cultivated, were the proprietors of the soil. The Circassians carried on little or no commerce, and the state of perpetual warfare in which they lived prevented them from cultivating any of the arts of peace.

CIRCE (Gr. Κίρκη), in Greek legend, a famous sorceress, the daughter of Helios and the ocean nymph Perse. Having murdered her husband, the prince of Colchis, she was expelled by her subjects and placed by her father on the solitary island of Aeaëa on the coast of Italy. She was able by means of drugs and incantations to change human beings into the forms of wolves or lions, and with these beings her palace was surrounded. Here she was found by Odysseus and his companions; the latter she changed into swine, but the hero, protected by the herb *moly* (*q.v.*), which he had received from Hermes, not only forced her to restore them to their original shape, but also gained her love. For a year he relinquished himself to her endearments, and when he determined to leave, she instructed him how to sail to the land of shades which lay on the verge of the ocean stream, in order to learn his fate from the prophet Teiresias. Upon his return she also gave him directions for avoiding the dangers of the journey home (Homer, *Odyssey*, x.—xii.; Hyginus, *Fab.* 125). The Roman poets associated her with the most ancient traditions of Latium, and assigned her a home on the promontory of Circei (Virgil, *Aeneid*, vii. 10). The metamorphoses of Scylla and of Picus, king of the Ausonians, by Circe, are narrated in Ovid (*Metamorphoses*, xiv.).

The Myth of Kirke, by R. Brown (1883), in which Circe is explained as a moon-goddess of Babylonian origin, contains an exhaustive summary of facts, although many of the author's speculations may

be proved untenable (review by H. Bradley in *Academy*, January 19, 1884); see also J. E. Harrison, *Myths of the Odyssey* (1882); C. Seeliger in W. H. Roscher's *Lexikon der Mythologie*.

CIRCEIUS MONS (mod. *Monte Circeo*), an isolated promontory on the S.W. coast of Italy, about 80 m. S.E. of Rome. It is a ridge of limestone about $3\frac{1}{2}$ m. long by 1 m. wide at the base, running from E. to W. and surrounded by the sea on all sides except the N. The land to the N. of it is 53 ft. above sea-level, while the summit of the promontory is 1775 ft. The origin of the name is uncertain: it has naturally been connected with the legend of Circe, and Victor Bérard (in *Les Phéniciens et l'Odyssee*, ii. 261 seq.) maintains in support of the identification that *Aiaîη*, the Greek name for the island of Circe, is a faithful transliteration of a Semitic name, meaning "island of the hawk," of which *νῆσος Κίρκης* is the translation. The difficulty has been raised, especially by geologists, that the promontory ceased to be an island at a period considerably before the time of Homer; but Procopius very truly remarked that the promontory has all the appearance of an island until one is actually upon it. Upon the E. end of the ridge of the promontory are the remains of an enceinte, forming roughly a rectangle of about 200 by 100 yds. of very fine polygonal work, on the outside, the blocks being very carefully cut and jointed and right angles being intentionally avoided. The wall stands almost entirely free, as at Arpinum—polygonal walls in Italy are as a rule embanking walls—and increases considerably in thickness as it descends. The blocks of the inner face are much less carefully worked both here and at Arpinum. It seems to have been an acropolis, and contains no traces of buildings, except for a subterranean cistern, circular, with a beehive roof of converging blocks. The modern village of S. Felice Circeo seems to occupy the site of the ancient town, the citadel of which stood on the mountain top, for its medieval walls rest upon ancient walls of Cyclopean work of less careful construction than those of the citadel, and enclosing an area of 200 by 150 yds.

Circei was founded as a Roman colony at an early date—according to some authorities in the time of Tarquinius Superbus, but more probably about 390 B.C. The existence of a previous population, however, is very likely indicated by the revolt of Circei in the middle of the 4th century B.C., so that it is doubtful whether the walls described are to be attributed to the Romans or the earlier Volscian inhabitants. At the end of the republic, however, or at latest at the beginning of the imperial period, the city of Circei was no longer at the E. end of the promontory, but on the E. shores of the Lago di Paola (a lagoon—now a considerable fishery—separated from the sea by a line of sandhills and connected with it by a channel of Roman date: Strabo speaks of it as a small harbour) one mile N. of the W. end of the promontory. Here are the remains of a Roman town, belonging to the 1st and 2nd centuries, extending over an area of some 600 by 500 yards, and consisting of fine buildings along the lagoons, including a large open *piscina* or basin, surrounded by a double portico, while farther inland are several very large and well-preserved water-reservoirs, supplied by an aqueduct of which traces may still be seen. An inscription speaks of an amphitheatre, of which no remains are visible. The transference of the city did not, however, mean the abandonment of the E. end of the promontory, on which stand the remains of several very large villas. An inscription, indeed, cut in the rock near S. Felice, speaks of this part of the *promunturium Veneris* (the only case of the use of this name) as belonging to the city of Circei. On the S. and N. sides of the promontory there are comparatively few buildings, while at the W. end there is a sheer precipice to the sea. The town only acquired municipal rights after the Social War, and was a place of little importance, except as a seaside resort. For its villas Cicero compares it with Antium, and probably both Tiberius and Domitian possessed residences there. The beetroot and oysters of Circei had a certain reputation. The view from the highest summit of the promontory (which is occupied by ruins of a platform attributed with great probability to a temple of Venus or Circe) is of remarkable beauty; the whole mountain is covered with fragrant

shrubs. From any point in the Pomptine Marshes or on the coast-line of Latium the Circeian promontory dominates the landscape in the most remarkable way.

See T. Ashby, "Monte Circeo," in *Mélanges de l'école française de Rome*, xxv. (1905) 157 seq. (T. As.)

CIRCLE (from the Lat. *circulus*, the diminutive of *circus*, a ring; the cognate Gr. word is *κίρκος*, generally used in the form *κίρκος*), a plane curve definable as the locus of a point which moves so that its distance from a fixed point is constant.

The form of a circle is familiar to all; and we proceed to define certain lines, points, &c., which constantly occur in studying its geometry. The fixed point in the preceding definition is termed the "centre" (C in fig. 1); the constant distance, e.g. CG, the "radius." The curve itself is sometimes termed the "circumference." Any line through the centre and terminated at both extremities by the curve, e.g. AB, is a "diameter"; any other line similarly terminated, e.g. EF, a "chord." Any line drawn from an external point to cut the circle in two points, e.g. DEF, is termed a "secant"; if it touches the circle, e.g. DG, it is a "tangent." Any portion of the circumference terminated by two points, e.g. AD (fig. 2), is termed an "arc"; and the plane figure enclosed by a chord and arc, e.g. ABD, is termed a "segment"; if the chord be a diameter, the segment is termed a "semicircle." The figure included by two radii and an arc is a "sector," e.g. ECF (fig. 2). "Concentric circles" are, as the name obviously shows, circles having the same centre; the figure enclosed by the circumferences of two concentric circles is an "annulus" (fig. 3), and of two non-con-

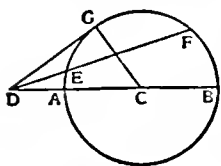

FIG. 1.

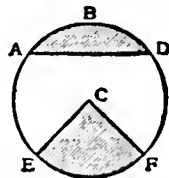

FIG. 2.

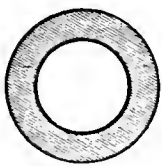

FIG. 3.

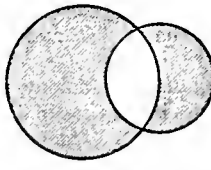

FIG. 4.

centric circles a "lune," the shaded portions in fig. 4; the clear figure is sometimes termed a "lens."

The circle was undoubtedly known to the early civilizations, its simplicity specially recommending it as an object for study. Euclid defines it (Book I. def. 15) as a "plane figure enclosed by one line, all the straight lines drawn to which from one point within the figure are equal to one another." In the succeeding three definitions the centre, diameter and the semicircle are defined, while the third postulate of the same book demands the possibility of describing a circle for every "centre" and "distance." Having employed the circle for the construction and demonstration of several propositions in Books I. and II. Euclid devotes his third book entirely to theorems and problems relating to the circle, and certain lines and angles, which he defines in introducing the propositions. The fourth book deals with the circle in its relations to inscribed and circumscribed triangles, quadrilaterals and regular polygons. Reference should be made to the article *GEOMETRY: Euclidean*, for a detailed summary of the Euclidean treatment, and the elementary properties of the circle.

Analytical-Geometry of the Circle.

In the article *GEOMETRY: Analytical*, it is shown that the general equation to a circle in rectangular Cartesian co-ordinates is $x^2 + y^2 + 2gx + 2fy + c = 0$, i.e. in the general equation of the second degree the co-efficients of x^2 and y^2 are equal, and of xy zero. The co-ordinates of its centre are $-g/c, -f/c$; and its radius is $(g^2 + f^2 - c)^{1/2}$. The equations to the chord, tangent and normal are readily derived by the ordinary methods.

Cartesian co-ordinates.

Consider the two circles:—

$$x^2 + y^2 + 2gx + 2fy + c = 0, \quad x^2 + y^2 + 2g'x + 2f'y + c' = 0.$$

Obviously these equations show that the curves intersect in four points, two of which lie on the intersection of the line, $2(g-g')x + 2(f-f')y + c - c' = 0$, the radical axis, with the circles, and the other two where the lines $x^2 + y^2 = (x+iy)(x-iy) = 0$ (where $i = \sqrt{-1}$) intersect the circles. The first pair of intersections may be either real or imaginary; we proceed to discuss the second pair.

The equation $x^2 + y^2 = 0$ denotes a pair of perpendicular imaginary lines; it follows, therefore, that circles always intersect in two imaginary points at infinity along these lines, and since the terms $x^2 + y^2$ occur in the equation of every circle, it is seen that all circles pass through two fixed points at infinity. The introduction of these lines and points constitutes a striking achievement in geometry, and from their association with circles they have been named the "circular lines" and "circular points." Other names for the circular lines are "circulars" or "isotropic lines." Since the equation to a circle of zero radius is $x^2 + y^2 = 0$, i.e. identical with the circular lines, it follows that this circle consists of a real point and the two imaginary lines; conversely, the circular lines are both a pair of lines and a circle. A further deduction from the principle of continuity follows by considering the intersections of concentric circles. The equations to such circles may be expressed in the form $x^2 + y^2 = a^2, x^2 + y^2 = b^2$. These equations show that the circles touch where they intersect the lines $x^2 + y^2 = 0$, i.e. concentric circles have double contact at the circular points, the chord of contact being the line at infinity.

In various systems of triangular co-ordinates the equations to circles specially related to the triangle of reference assume comparatively simple forms; consequently they provide elegant algebraical demonstrations of properties concerning a triangle and the circles intimately associated with its geometry. In this article the equations to the more important circles—the circumscribed, inscribed, escribed, self-conjugate—will be given; reference should be made to the article *TRIANGLE* for the consideration of other circles (nine-point, Brocard, Lemoine, &c.); while in the article *GEOMETRY: Analytical*, the principles of the different systems are discussed.

The equation to the circumcircle assumes the simple form $a\beta\gamma + b\gamma a + c\alpha\beta = 0$, the centre being $\cos A, \cos B, \cos C$. The inscribed circle is $\cos \frac{1}{2}A \sqrt{a} + \cos \frac{1}{2}B \sqrt{b} + \cos \frac{1}{2}C \sqrt{c} = 0$, with centre $\alpha = \beta = \gamma$; while the escribed circle opposite the angle A is $\cos \frac{1}{2}A \sqrt{-a} + \sin \frac{1}{2}B \sqrt{b} + \sin \frac{1}{2}C \sqrt{c} = 0$, with centre $-\alpha = \beta = \gamma$. The self-conjugate circle is $a^2 \sin 2A + b^2 \sin 2B + c^2 \sin 2C = 0$, or the equivalent form $a \cos A a^2 + b \cos B b^2 + c \cos C c^2 = 0$, the centre being $\sec A, \sec B, \sec C$.

Trilinear co-ordinates.

The general equation to the circle in trilinear co-ordinates is readily deduced from the fact that the circle is the only curve which intersects the line infinity in the circular points. Consider the equation

$$a\beta\gamma + b\gamma a + c\alpha\beta + (la + m\beta + n\gamma)(\alpha a + \beta b + \gamma c) = 0 \quad (1).$$

This obviously represents a conic intersecting the circle $a\beta\gamma + b\gamma a + c\alpha\beta = 0$ in points on the common chords $la + m\beta + n\gamma = 0, \alpha a + \beta b + \gamma c = 0$. The line $la + m\beta + n\gamma$ is the radical axis, and since $\alpha a + \beta b + \gamma c = 0$ is the line infinity, it is obvious that equation (1) represents a conic passing through the circular points, i.e. a circle. If we compare (1) with the general equation of the second degree $ua^2 + vb^2 + wc^2 + 2u'\beta\gamma + 2v'\gamma a + 2w'\alpha\beta = 0$, it is readily seen that for this equation to represent a circle we must have

$$-kabc = v^2 + w^2 - 2u'bc = wa^2 + uc^2 - 2v'ca = ub^2 + va^2 - 2w'ab.$$

The corresponding equations in areal co-ordinates are readily derived by substituting $x/a, y/b, z/c$ for a, β, γ respectively in the trilinear equations. The circumcircle is thus seen to be $a^2yz + b^2zx + c^2xy = 0$, with centre $\sin 2A, \sin 2B, \sin 2C$; the inscribed circle is $\sqrt{(x \cot \frac{1}{2}A) + \sqrt{(y \cot \frac{1}{2}B) + \sqrt{(z \cot \frac{1}{2}C)}} = 0$, with centre $\sin A, \sin B, \sin C$; the escribed circle opposite the angle A is $\sqrt{(-x \cot \frac{1}{2}A) + \sqrt{(y \tan \frac{1}{2}B) + \sqrt{(z \tan \frac{1}{2}C)}} = 0$, with centre $-\sin A, \sin B, \sin C$; and the self-conjugate circle is $x^2 \cot A + y^2 \cot B + z^2 \cot C = 0$, with centre $\tan A, \tan B, \tan C$. Since in areal co-ordinates the line infinity is represented by the equation $x + y + z = 0$ it is seen that every circle is of the form $a^2yz + b^2zx + c^2xy + (lx + my + nz)(x + y + z) = 0$. Comparing this equation with $ux^2 + vy^2 + wz^2 + 2u'yz + 2v'zx + 2w'xy = 0$, we obtain as the condition for the general equation of the second degree to represent a circle:—

Areal co-ordinates.

$$(v + w - 2u')/a^2 = (w + u - 2v')/b^2 = (u + v - 2w')/c^2.$$

In tangential (p, q, r) co-ordinates the inscribed circle has for its equation $(s-a)qr + (s-b)rp + (s-c)pq = 0$, s being equal to $\frac{1}{2}(a+b+c)$; an alternative form is $qr \cot \frac{1}{2}A + rp \cot \frac{1}{2}B + pq \cot \frac{1}{2}C = 0$; the centre is $ap + bq + cr = 0$, or $p \sin A + q \sin B + r \sin C = 0$. The escribed circle opposite the angle A is $-sqr + (s-c)rp + (s-b)pq = 0$ or $-qr \cot \frac{1}{2}A + rp \tan \frac{1}{2}B + pq \tan \frac{1}{2}C = 0$, with centre $-ap + bq + cr = 0$. The circumcircle is $a\sqrt{p} + b\sqrt{q} + c\sqrt{r} = 0$, the centre being $p \sin 2A + q \sin 2B + r \sin 2C = 0$. The general equation to a circle in this system of co-ordinates is deduced as follows: If ρ be the radius and $lp + mq + nr = 0$ the centre, we have $\rho = (lp_1 + mq_1 + nr_1)/(l+m+n)$, in which p_1, q_1, r_1 is a line distant ρ from the point $lp + mq + nr = 0$. Making this equation homogeneous

Tangential co-ordinates.

by the relation $\Sigma a^2(p-q)(p-r) = 4\Delta^2$ (see GEOMETRY: *Analytical*, which is generally written $\{ap, bq, cr\}^2 = 4\Delta^2$, we obtain $\{ap, bq, cr\}^2 p^2 = 4\Delta^2 \{lp+mq+nr\} / (l+m+n)^2$, the accents being dropped, and p, q, r regarded as current co-ordinates. This equation, which may be more conveniently written $\{ap, bq, cr\}^2 = (\lambda p + \mu q + \nu r)^2$, obviously represents a circle, the centre being $\lambda p + \mu q + \nu r = 0$, and radius $2\Delta / (\lambda + \mu + \nu)$. If we make $\lambda = \mu = \nu = 0$, p is infinite, and we obtain $\{ap, bq, cr\}^2 = c$ as the equation to the circular points.

Systems of Circles.

Centres and Circle of Similitude.—The “centres of similitude” of two circles may be defined as the intersections of the common tangents to the two circles, the direct common tangents giving rise to the “external centre,” the transverse tangents to the “internal centre.” It may be readily shown that the external and internal centres are the points where the line joining the centres of the two circles is divided externally and internally in the ratio of their radii.

The circle on the line joining the internal and external centres of similitude as diameter is named the “circle of similitude.” It may be shown to be the locus of the vertex of the triangle which has for its base the line between the centres of the circles and the ratio of the remaining sides equal to the ratio of the radii of the two circles.

With a system of three circles it is readily seen that there are six centres of similitude, viz. two for each pair of circles, and it may be shown that these lie three by three on four lines, named the “axes of similitude.” The collinear centres are the three sets of one external and two internal centres, and the three external centres.

Coaxial Circles.—A system of circles is coaxial when the locus of points from which tangents to the circles are equal is a straight line. Consider the case of two circles, and in the first place suppose them to intersect in two real points A and B. Then by Euclid iii. 36 it is seen that the line joining the points A and B is the locus of the intersection of equal tangents, for if P be any point on AB and PC and PD the tangents to the circles, then $PA \cdot PB = PC^2 = PD^2$, and therefore $PC = PD$. Furthermore it is seen that AB is perpendicular to the line joining the centres, and divides it in the ratio of the squares of the radii. The line AB is termed the “radical axis.” A system coaxial with the two given circles is readily constructed by describing circles through the common points on the radical axis and any third point; the minimum circle of the system is obviously that which has the common chord of intersection for diameter, the maximum

is the radical axis—considered as a circle of infinite radius. In the case of two non-intersecting circles it may be shown that the radical axis has the same metrical relations to the line of centres.

There are several methods of constructing the radical axis in this case. One of the simplest is: Let P and P' (fig. 5) be the points of contact of a common tangent; drop perpendiculars PL, P'L', from P and P' to OO', the line joining the centres, then the radical axis bisects LL' (at X) and is perpendicular to OO'. To prove this let AB, AB' be the tangents from any point on the line AX. Then by Euc. i. 47, $AB^2 = AO^2 - OB^2 = AX^2 + OX^2 - OP^2$; and $OX^2 = OD^2 - DX^2 = OP^2 + PD^2 - DX^2$. Therefore $AB^2 = AX^2 - DX^2 + PD^2$. Similarly $AB'^2 = AX^2 - DX^2 + DP'^2$. Since $PD = PD'$, it follows that $AB = AB'$.

To construct circles coaxial with the two given circles, draw the tangent, say XR, from X, the point where the radical axis intersects the line of centres, to one of the given circles, and with centre X and radius XR describe a circle. Then circles having the intersections of tangents to this circle and the line of centres for centres, and the lengths of the tangents as radii, are members of the coaxial system.

In the case of non-intersecting circles, it is seen that the minimum circles of the coaxial system are a pair of points I and I', where the orthogonal circle to the system intersects the line of centres; these points are named the “limiting points.” In the case of a coaxial system having real points of intersection the limiting points are imaginary. Analytically, the Cartesian

equation to a coaxial system can be written in the form $x^2 + y^2 + 2ax = k^2 = 0$, where a varies from member to member, while k is a constant. The radical axis is $x = 0$, and it may be shown that the length of the tangent from a point $(0, h)$ is $h^2 = k^2$, i.e. it is independent of a , and therefore of any particular member of the system. The circles intersect in real or imaginary points according to the lower or upper sign of k^2 , and the limiting points are real for the upper sign and imaginary for the lower sign.

The fundamental properties of coaxial systems may be summarized:—

1. The centres of circles forming a coaxial system are collinear;
2. A coaxial system having real points of intersection has imaginary limiting points;
3. A coaxial system having imaginary points of intersection has real limiting points;
4. Every circle through the limiting points cuts all circles of the system orthogonally;
5. The limiting points are inverse points for every circle of the system.

The theory of centres of similitude and coaxial circles affords elegant demonstrations of the famous problem: To describe a circle to touch three given circles. This problem, also termed the “Apollonian problem,” was demonstrated with the aid of conic sections by Apollonius in his book on *Contacts or Tangencies*; geometrical solutions involving the conic sections were also given by Adrianus Romanus, Vieta, Newton and others. The earliest analytical solution appears to have been given by the princess Elizabeth, a pupil of Descartes and daughter of Frederick V. John Casey, professor of mathematics at the Catholic university of Dublin, has given elementary demonstrations founded on the theory of similitude and coaxial circles which are reproduced in his *Sequel to Euclid*; an analytical solution by Gergonne is given in Salmon's *Conic Sections*. Here we may notice that there are eight circles which solve the problem.

Mensuration of the Circle.

All exact relations pertaining to the mensuration of the circle involve the ratio of the circumference to the diameter. This ratio, invariably denoted by π , is constant for all circles, but it does not admit of exact arithmetical expression, being of the nature of an incommensurable number. Very early in the history of geometry it was known that the circumference and area of a circle of radius r could be expressed in the forms $2\pi r$ and πr^2 . The exact geometrical evaluation of the second quantity, viz. πr^2 , which, in reality, is equivalent to determining a square equal in area to a circle, engaged the attention of mathematicians for many centuries. The history of these attempts, together with modern contributions to our knowledge of the value and nature of the number π , is given below (*Squaring of the Circle*).

The following table gives the values of this constant and several expressions involving it:—

	Number.	Logarithm.		Number.	Logarithm.
π	3.1415927	0.4971499	π^2	9.8696044	0.9942997
2π	6.2831853	0.7981799	$\frac{1}{6\pi^2}$	0.0168869	2.2275490
4π	12.5663706	1.0992099	$\sqrt{\pi}$	1.7724539	0.2485750
$\frac{1}{2}\pi$	1.5707963	0.1961199	$\sqrt[3]{\pi}$	1.4645919	0.1657166
$\frac{1}{4}\pi$	0.7853982	0.020 286	$\frac{1}{\sqrt{\pi}}$	0.5641896	1.7514251
$\frac{1}{8}\pi$	0.3926991	1.7189986	$\frac{2}{\sqrt{\pi}}$	1.1283792	0.0524551
$\frac{1}{16}\pi$	0.2467994	1.5340599	$\frac{1}{2\sqrt{\pi}}$	0.2820948	1.4503951
$\frac{1}{32}\pi$	0.1233997	1.4179686	$\sqrt[3]{\frac{6}{\pi}}$	1.2407010	0.0936671
$\frac{1}{64}\pi$	0.0616998	0.6220386	$\sqrt[3]{\frac{3}{4\pi}}$	0.6203505	1.7926371
$\frac{1}{180}\pi$	0.0174533	2.2418774	$\frac{180}{\pi}$	57.2957795	1.7581226
$\frac{1}{\pi}$	0.3183099	1.5028501	$\log_e \pi$	1.1447299	0.0587030
$\frac{4}{\pi}$	1.2732395	0.1049101			
$\frac{1}{4\pi}$	0.0795775	2.9007901			
$\frac{180}{\pi}$	57.2957795	1.7581226			

Useful fractional approximations are $22/7$ and $355/113$.
 A synopsis of the leading formula connected with the circle will now be given.
 1. **Circle.**—Data: radius = a . Circumference = $2\pi a$. Area = πa^2 .
 2. **Arc and Sector.**—Data: radius = a ; θ = circular measure of angle subtended at centre by arc; c = chord of arc; c_2 = chord of semi-arc; c_4 = chord of quarter-arc.

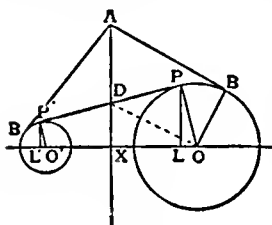

FIG. 5.

Exact formulae are:—Arc = $a\theta$, where θ may be given directly, or indirectly by the relation $c = 2a \sin \frac{1}{2}\theta$. Area of sector = $\frac{1}{2}a^2\theta = \frac{1}{2}$ radius \times Arc.

Approximate formulae are:—Arc = $\frac{1}{3}(8c_2 - c)$ (Huygen's formula); arc = $\frac{1}{2}(c - 40c_2 + 256c_4)$.

3. Segment.—Data: a, θ, c, c_2 , as in (2); h = height of segment, i.e. distance of mid-point of arc from chord.

Exact formulae are:—Area = $\frac{1}{2}a^2(\theta - \sin \theta) = \frac{1}{2}a^2\theta - \frac{1}{2}c^2 \cot \frac{1}{2}\theta = \frac{1}{2}a^2 - \frac{1}{2}c\sqrt{a^2 - \frac{1}{4}c^2}$. If h be given, we can use $c^2 + 4h^2 = 8ah, 2h = c \tan \frac{1}{2}\theta$ to determine θ .

Approximate formulae are:—Area = $r_1^2(6c + 8c_2)h; = \frac{2}{3}\sqrt{c^2 + \frac{8}{3}h^2} \cdot h; = \frac{1}{3}(7c + 3a)h$, a being the true length of the arc.

From these results the mensuration of any figure bounded by circular arcs and straight lines can be determined, e.g. the area of a lune or meniscus is expressible as the difference or sum of two segments, and the circumference as the sum of two arcs. (C. E.*)

Squaring of the Circle.

The problem of finding a square equal in area to a given circle, like all problems, may be increased in difficulty by the imposition of restrictions; consequently under the designation there may be embraced quite a variety of geometrical problems. It has to be noted, however, that, when the "squaring" of the circle is especially spoken of, it is almost always tacitly assumed that the restrictions are those of the Euclidean geometry.

Since the area of a circle equals that of the rectilinear triangle whose base has the same length as the circumference and whose altitude equals the radius (Archimedes, *Kύκλου μέτρησις*, prop. 1), it follows that, if a straight line could be drawn equal in length to the circumference, the required square could be found by an ordinary Euclidean construction; also, it is evident that, conversely, if a square equal in area to the circle could be obtained it would be possible to draw a straight line equal to the circumference. Rectification and quadrature of the circle have thus been, since the time of Archimedes at least, practically identical problems. Again, since the circumferences of circles are proportional to their diameters—a proposition assumed to be true from the dawn almost of practical geometry—the rectification of the circle is seen to be transformable into finding the ratio of the circumference to the diameter. This correlative numerical problem and the two purely geometrical problems are inseparably connected historically.

Probably the earliest value for the ratio was 3. It was so among the Jews (1 Kings vii. 23, 26), the Babylonians (Oppert, *Journ. asiatique*, August 1872, October 1874), the Chinese (Biot, *Journ. asiatique*, June 1841), and probably also the Greeks. Among the ancient Egyptians, as would appear from a calculation in the Rhind papyrus, the number $(\frac{256}{81})^2$, i.e. 3.1605, was at one time in use.¹ The first attempts to solve the purely geometrical problem appear to have been made by the Greeks (Anaxagoras, &c.)², one of whom, Hippocrates, doubtless raised hopes of a solution by his quadrature of the so-called *meniscus* or *lune*.³

[The Greeks were in possession of several relations pertaining to the quadrature of the lune. The following are among the more interesting. In fig. 6, ABC is an isosceles triangle right

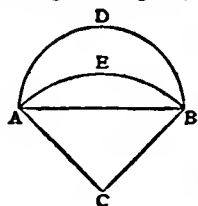

FIG. 6.

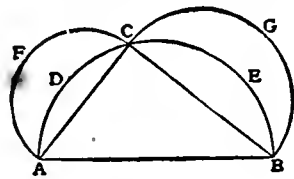

FIG. 7.

angled at C, ADB is the semicircle described on AB as diameter, AEB the circular arc described with centre C and radius CA = CB. It is easily shown that the areas of the lune ADBEA and the triangle ABC are equal. In fig. 7, ABC is any triangle

¹ Eisenlohr, *Ein math. Handbuch d. allen Ägypter, übers. u. erklärt* (Leipzig, 1877); Rodet, *Bull. de la Soc. Math. de France*, vi. pp. 139-149.

² H. Hankel, *Zur Gesch. d. Math. im Alterthum, &c.*, chap. v (Leipzig, 1874); M. Cantor, *Vorlesungen über Gesch. d. Math. i.* (Leipzig, 1880); Tannery, *Mém. de la Soc., &c., à Bordeaux*; Allman, in *Hermathena*.

³ Tannery, *Bull. des sc. math.* [2], x. pp. 213-226.

right angled at C, semicircles are described on the three sides, thus forming two lunes AFCDA and CGBEC. The sum of the areas of these lunes equals the area of the triangle ABC.]

As for Euclid, it is sufficient to recall the facts that the original author of prop. 8 of book iv. had strict proof of the ratio being < 4 , and the author of prop. 15 of the ratio being > 3 , and to direct attention to the importance of book x. on incommensurables and props. 2 and 16 of book xii., viz. that "circles are to one another as the squares on their diameters" and that "in the greater of two concentric circles a regular $2n$ -gon can be inscribed which shall not meet the circumference of the less," however nearly equal the circles may be.

With Archimedes (287-212 B.C.) a notable advance was made. Taking the circumference as intermediate between the perimeters of the inscribed and the circumscribed regular n -gons, he showed that, the radius of the circle being given and the perimeter of some particular circumscribed regular polygon obtainable, the perimeter of the circumscribed regular polygon of double the number of sides could be calculated; that the like was true of the inscribed polygons; and that consequently a means was thus afforded of approximating to the circumference of the circle.

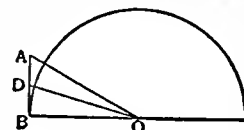

FIG. 8.

As a matter of fact, he started with a semi-side AB of a circumscribed regular hexagon meeting the circle in B (see fig. 8), joined A and B with O the centre, bisected the angle AOB by OD, so that BD became the semi-side of a circumscribed regular 12-gon; then as $AB:BO:OA :: 1 : \sqrt{3}:2$ he sought an approximation to $\sqrt{3}$ and found that $AB:BO > 153:265$. Next he applied his theorem⁴ $BO+OA:AB :: OB:BD$ to calculate BD; from this in turn he calculated the semi-sides of the circumscribed regular 24-gon, 48-gon and 96-gon, and so finally established for the circumscribed regular 96-gon that perimeter $<$ diameter $< 3\frac{1}{7}:1$. In a quite analogous manner he proved for the inscribed regular 96-gon that perimeter $>$ diameter $> 3\frac{1}{7}:1$. The conclusion from these therefore was that the ratio of circumference to diameter is $< 3\frac{1}{7}$ and $> 3\frac{1}{7}$. This is a most notable piece of work; the immature condition of arithmetic at the time was the only real obstacle preventing the evaluation of the ratio to any degree of accuracy whatever.⁵

No advance of any importance was made upon the achievement of Archimedes until after the revival of learning. His immediate successors may have used his method to attain a greater degree of accuracy, but there is very little evidence pointing in this direction. Ptolemy (fl. 127-151), in the *Great Syntaxis*, gives 3.141552 as the ratio⁶; and the Hindus (c. A.D. 500), who were very probably indebted to the Greeks, used 62832/20000, that is, the now familiar 3.1416.⁷

It was not until the 15th century that attention in Europe began to be once more directed to the subject, and after the resuscitation a considerable length of time elapsed before any progress was made. The first advance in accuracy was due to a certain Adrian, son of Anthony, a native of Metz (1527), and father of the better-known Adrian Metius of Alkmaar. In refutation of Duchesne (Van der Eycke), he showed that the ratio was $< 3\frac{1}{7}$ and $> 3\frac{1}{6}$, and thence made the exceedingly lucky step of taking a mean between the two by the quite unjustifiable process of halving the sum of the two numerators for a new numerator and halving the sum of the two denominators for a new denominator, thus arriving at the now well-known approximation $3\frac{1}{6}$ or $\frac{355}{113}$, which, being equal to 3.1415929... is correct to the sixth fractional place.⁸

⁴ In modern trigonometrical notation, $1 + \sec \theta : \tan \theta :: 1 : \tan \frac{1}{2}\theta$.

⁵ Tannery, "Sur la mesure du cercle d'Archimède," in *Mém. de la Soc. Math. de France*, [2], iv. pp. 313-339; Menge, *Des Archimedes Kreismessung* (Coblenz, 1874).

⁶ De Morgan, in *Penny Cyclop.*, xix. p. 186.

⁷ Kern, *Aryabhattiyam* (Leiden, 1874), trans. by Rodet (Paris, 1879).

⁸ De Morgan, art. "Quadrature of the Circle," in *English Cyclop.*; Glaisher, *Mess. of Math.* ii. pp. 119-128, iii. pp. 27-46; de Haan, *Nieuw Archief v. Wisk.* i. pp. 70-86, 206-211.

The next to advance the calculation was Francisco Vieta. By finding the perimeter of the inscribed and that of the circumscribed regular polygon of 393216 (*i.e.* 6×2^{16}) sides, he proved that the ratio was > 3.1415926535 and < 3.1415926537 , so that its value became known (in 1579) correctly to 10 fractional places. The theorem for angle-bisection which Vieta used was not that of Archimedes, but that which would now appear in the form $1 - \cos \theta = 2 \sin^2 \frac{1}{2} \theta$. With Vieta, by reason of the advance in arithmetic, the style of treatment becomes more strictly trigonometrical; indeed, the *Universales Inspectiones*, in which the calculation occurs, would now be called plane and spherical trigonometry, and the accompanying *Canon mathematicus* a table of sines, tangents and secants.¹ Further, in comparing the labours of Archimedes and Vieta, the effect of increased power of symbolical expression is very noticeable. Archimedes's process of unending cycles of arithmetical operations could at best have been expressed in his time by a "rule" in words; in the 16th century it could be condensed into a "formula." Accordingly, we find in Vieta a formula for the ratio of diameter to circumference, viz. the interminate product²—

$$\frac{1}{2} \sqrt{\frac{1}{2}} \cdot \sqrt{\frac{1}{2} + \frac{1}{2} \sqrt{\frac{1}{2}}} \cdot \sqrt{\frac{1}{2} + \frac{1}{2} \sqrt{\frac{1}{2} + \frac{1}{2} \sqrt{\frac{1}{2}}}} \dots$$

From this point onwards, therefore, no knowledge whatever of geometry was necessary in any one who aspired to determine the ratio to any required degree of accuracy; the problem being reduced to an arithmetical computation. Thus in connexion with the subject a genus of workers became possible who may be styled "π-computers or circle-squarers"—a name which, if it connotes anything uncomplimentary, does so because of the almost entirely fruitless character of their labours. Passing over Adriaan van Roomen (Adrianus Romanus) of Louvain, who published the value of the ratio correct to 15 places in his *Idea mathematica* (1593),³ we come to the notable computer Ludolph van Ceulen (d. 1610), a native of Germany, long resident in Holland. His book, *Van den Circkel* (Delft, 1596), gave the ratio correct to 20 places, but he continued his calculations as long as he lived, and his best result was published on his tombstone in St Peter's church, Leiden. The inscription, which is not known to be now in existence,⁴ is in part as follows:—

... Qui in vita sua multo labore circumferentiae circuli proximam rationem ad diametrum invenit sequentem—
quando diameter est 1
tum circuli circumferentia plus est
quam 314159265358979323846264338327950288
100
et minus
quam 314159265358979323846264338327950289
100 . . .

This gives the ratio correct to 35 places. Van Ceulen's process was essentially identical with that of Vieta. Its numerous root extractions amply justify a stronger expression than "multo labore," especially in an epitaph. In Germany the "Ludolphische Zahl" (Ludolph's number) is still a common name for the ratio.⁵

Up to this point the credit of most that had been done may be set down to Archimedes. A new departure, however, was made

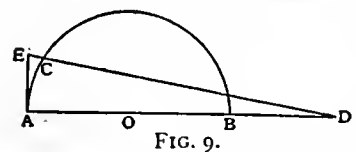

FIG. 9.

whose centre is O, and AC the arc to be rectified, he produced AB to D, making BD equal to the radius, joined DC,

¹ Vieta, *Opera math.* (Leiden, 1646); Maric, *Hist. des sciences math.* iii. 27 seq. (Paris, 1884).
² Klügcl, *Math. Wörterb.* ii. 606, 607.
³ Kästner, *Gesch. d. Math.* i. (Göttingen, 1796-1800).
⁴ But see *Les Délices de Leide* (Leiden, 1712); or de Haan, *Mess. of Math.* iii. 24-26.
⁵ For minute and lengthy details regarding the quadrature of the circle in the Low Countries, see de Haan, "Bouwstoffen voor de geschiedenis, &c.," in *Versl. en Mededeel. der K. Akad. van Wetensch.* ix., x., xi., xii. (Amsterdam); also his "Notice sur quelques quadrateurs, &c.," in *Bull. di bibliogr. e di storia delle sci. mat. e fis.* vii. 99-144.

and produced it to meet the tangent at A in E; and then his assertion (not established by him) was that AE was nearly equal to the arc AC, the error being in defect. For the purposes of the calculator a solution erring in excess was also required, and this Snell gave by slightly varying the former construction.

Instead of producing AB (see fig. 10) so that BD was equal to *r*, he produced it only so far that, when the extremity D' was joined with C, the part D'F outside the circle was equal to *r*; in other words, by a non-Euclidean construction he trisected the angle AOC, for it is readily seen that, since FD' = FO = OC, the angle FOB = $\frac{1}{3}$ AOC.⁶ This couplet of constructions is as important from the calculator's point of view as it is interesting geometrically. To compare it on this score with the fundamental proposition of Archimedes, the latter must be put into a form similar to Snell's. AMC being an arc of a circle (see fig. 11) whose centre is O, AC its chord, and HK the tangent drawn at the middle point of the arc and bounded by OA, OC produced, then, according to Archimedes, AMC < HK, but > AC. In modern trigonometrical notation the propositions to be compared stand as follows:—

$$2 \tan \frac{1}{2} \theta > \theta > 2 \sin \frac{1}{2} \theta \quad (\text{Archimedes});$$

$$\tan \frac{1}{3} \theta + 2 \sin \frac{1}{3} \theta > \theta > \frac{3 \sin \theta}{2 + \cos \theta} \quad (\text{Snell}).$$

It is readily shown that the latter gives the best approximation to θ ; but, while the former requires for its application a knowledge of the trigonometrical ratios of only one angle (in other words, the ratios of the sides of only one right-angled triangle), the latter requires the same for two angles, θ and $\frac{1}{3} \theta$.

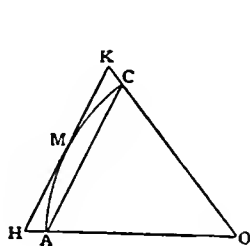

FIG. 11.

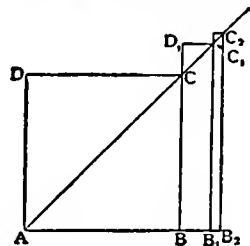

FIG. 12.

Grienberger, using Snell's method, calculated the ratio correct to 39 fractional places.⁷ C. Huygens, in his *De Circuli Magnitudine Inventa*, 1654, proved the propositions of Snell, giving at the same time a number of other interesting theorems, for example, two inequalities which may be written as follows⁸—

$$\text{chd } \theta + \frac{4 \text{ chd } \theta + \sin \theta}{2 \text{ chd } \theta + 3 \sin \theta} \cdot \frac{1}{3} (\text{chd } \theta - \sin \theta) > \theta > \text{chd } \theta + \frac{1}{3} (\text{chd } \theta - \sin \theta).$$

As might be expected, a fresh view of the matter was taken by René Descartes. The problem he set himself was the exact converse of that of Archimedes. A given straight line being viewed as equal in length to the circumference of a circle, he sought to find the diameter of the circle. His construction is as follows (see fig. 12). Take AB equal to one-fourth of the given line; on AB describe a square ABCD; join AC; in AC produced find, by a known process, a point C₁ such that, when C₁B₁ is drawn perpendicular to AB produced and C₁D₁ perpendicular to BC produced, the rectangle BC₁ will be equal to $\frac{1}{4}$ ABCD; by the same process find a point C₂ such that the rectangle B₁C₂ will be equal to $\frac{1}{4}$ BC₁; and so on *ad infinitum*. The diameter sought is the straight line from A to the limiting position of the series of B's, say the straight line AB∞. As in the case of the process of

⁶ It is thus manifest that by his first construction Snell gave an approximate solution of two great problems of antiquity.
⁷ *Elementa trigonometrica* (Rome, 1630); Glaisher, *Messenger of Math.* iii. 35 seq.
⁸ See Kiessling's edition of the *De Circ. Magn. Inv.* (Flensburg, 1869); or Pirie's tract on *Geometrical Methods of Approx. to the Value of π* (London, 1877).

Archimedes, we may direct our attention either to the infinite series of geometrical operations or to the corresponding infinite series of arithmetical operations. Denoting the number of units in AB by $\frac{1}{4}c$, we can express BB_1, B_1B_2, \dots in terms of $\frac{1}{4}c$, and the identity $AB_\infty = AB + BB_1 + B_1B_2 + \dots$ gives us at once an expression for the diameter in terms of the circumference by means of an infinite series.¹ The proof of the correctness of the construction is seen to be involved in the following theorem, which serves likewise to throw new light on the subject:—AB being any straight line whatever, and the above construction being made, then AB is the diameter of the circle circumscribed by the square ABCD (self-evident), AB_1 is the diameter of the circle circumscribed by the regular 8-gon having the same perimeter as the square, AB_2 is the diameter of the circle circumscribed by the regular 16-gon having the same perimeter as the square, and so on. Essentially, therefore, Descartes's process is that known later as the process of *isoperimeters*, and often attributed wholly to Schwab.²

In 1655 appeared the *Arithmetica Infinitorum* of John Wallis, where numerous problems of quadrature are dealt with, the curves being now represented in Cartesian co-ordinates, and algebra playing an important part. In a very curious manner, by viewing the circle $y = (1-x^2)^{\frac{1}{2}}$ as a member of the series of curves $y = (1-x^2)^1, y = (1-x^2)^2, \&c.$, he was led to the proposition that four times the reciprocal of the ratio of the circumference to the diameter, *i.e.* $4/\pi$, is equal to the infinite product

$$\frac{3 \cdot 3 \cdot 5 \cdot 5 \cdot 7 \cdot 7 \cdot 9 \dots}{2 \cdot 4 \cdot 4 \cdot 6 \cdot 6 \cdot 8 \cdot 8 \dots}$$

and, the result having been communicated to Lord Brouncker, the latter discovered the equally curious equivalent continued fraction

$$1 + \frac{1^2}{2} + \frac{3^2}{2} + \frac{5^2}{2} + \frac{7^2}{2} \dots$$

The work of Wallis had evidently an important influence on the next notable personality in the history of the subject, James Gregory, who lived during the period when the higher algebraic analysis was coming into power, and whose genius helped materially to develop it. He had, however, in a certain sense one eye fixed on the past and the other towards the future. His first contribution³ was a variation of the method of Archimedes. The latter, as we know, calculated the perimeters of successive polygons, passing from one polygon to another of double the number of sides; in a similar manner Gregory calculated the areas. The general theorems which enabled him to do this, after a start had been made, are

$$A_{2n} = \sqrt{A_n A'_n} \text{ (Snell's Cyclom.)}$$

$$A'_{2n} = \frac{2A_n A'_n}{A_n + A_{2n}} \text{ or } \frac{2A'_n A_{2n}}{A'_n + A_{2n}} \text{ (Gregory),}$$

where A_n, A'_n are the areas of the inscribed and the circumscribed regular n -gons respectively. He also gave approximate rectifications of circular arcs after the manner of Huygens; and, what is very notable, he made an ingenious and, according to J. E. Montucla, successful attempt to show that quadrature of the circle by a Euclidean construction was impossible.⁴ Besides all this, however, and far beyond it in importance, was his use of infinite series. This merit he shares with his contemporaries N. Mercator, Sir I. Newton and G. W. Leibnitz, and the exact dates of discovery are a little uncertain. As far as the circle-squaring functions are concerned, it would seem that Gregory was the first (in 1670) to make known the series for the arc in terms of the tangent, the series for the tangent in terms of the arc, and the secant in terms of the arc; and in 1669 Newton showed to Isaac Barrow a little treatise in manuscript containing the series for the arc in terms of the sine, for the sine in terms of the arc, and for the cosine in terms of the arc. These discoveries

¹ See Euler, "Annotationes in locum quendam Cartesii," in *Nov. Comm. Acad. Petrop.* viii.

² Gergonne, *Annales de math.* vi.

³ See *Vera Circuli et Hyperbolae Quadratura* (Padua, 1667); and the *Appendicula* to the same in his *Exercitationes geometricae* (London, 1668).

⁴ *Penny Cyclop.* xix. 187.

formed an epoch in the history of mathematics generally, and had, of course, a marked influence on after investigations regarding circle-quadrature. Even among the mere computers the series

$$9 = \tan \theta - \frac{1}{3} \tan^3 \theta + \frac{1}{5} \tan^5 \theta - \dots,$$

specially known as Gregory's series, has ever since been a necessity of their calling.

The calculator's work having now become easier and more mechanical, calculation went on apace. In 1699 Abraham Sharp, on the suggestion of Edmund Halley, took Gregory's series, and, putting $\tan \theta = \frac{1}{3}\sqrt{3}$, found the ratio equal to

$$\sqrt{12} \left(1 - \frac{1}{3 \cdot 3^3} + \frac{1}{5 \cdot 3^5} - \frac{1}{7 \cdot 3^7} + \dots \right),$$

from which he calculated it correct to 71 fractional places.⁵ About the same time John Machin calculated it correct to 100 places, and, what was of more importance, gave for the ratio the rapidly converging expression

$$\frac{16}{5} \left(1 - \frac{1}{3 \cdot 5^3} + \frac{1}{5 \cdot 5^5} - \frac{1}{7 \cdot 5^7} + \dots \right) - \frac{4}{239} \left(1 - \frac{1}{3 \cdot 239^3} + \frac{1}{5 \cdot 239^5} - \dots \right),$$

which long remained without explanation.⁶ Fautet de Lagny, still using $\tan 30^\circ$, advanced to the 127th place.⁷

Leonhard Euler took up the subject several times during his life, effecting mainly improvements in the theory of the various series.⁸ With him, apparently, began the usage of denoting by π the ratio of the circumference to the diameter.⁹

The most important publication, however, on the subject in the 18th century was a paper by J. H. Lambert,¹⁰ read before the Berlin Academy in 1751, in which he demonstrated the irrationality of π . The general test of irrationality which he established is that, if

$$\frac{a_1}{b_1} = \frac{a_2}{b_2} = \frac{a_3}{b_3} = \dots$$

be an interminate continued fraction, $a_1, a_2, \dots, b_1, b_2, \dots$ be integers, $a_1/b_1, a_2/b_2, \dots$ be proper fractions, and the value of every one of the interminate continued fractions $\frac{a_1}{b_1} = \dots, \frac{a_2}{b_2} = \dots, \dots$ be < 1 , then the given continued fraction represents an irrational quantity. If this be applied to the right-hand side of the identity

$$\tan \frac{m}{n} = \frac{m}{n} - \frac{m^2}{3n} + \frac{m^3}{5n^3} \dots$$

it follows that the tangent of every arc commensurable with the radius is irrational, so that, as a particular case, an arc of 45° , having its tangent rational, must be incommensurable with the radius; that is to say, $\pi/4$ is an incommensurable number.¹¹

This incontestable result had no effect, apparently, in repressing the π -computers. G. von Vega in 1789, using series like Machin's, *viz.* Gregory's series and the identities

$$\pi/4 = 5 \tan^{-1} \frac{1}{5} + 2 \tan^{-1} \frac{1}{7}, \text{ (Euler, 1779),}$$

$$\pi/4 = \tan^{-1} \frac{1}{2} + 2 \tan^{-1} \frac{1}{5} \text{ (Hutton, 1776),}$$

neither of which was nearly so advantageous as several found by Charles Hutton, calculated π correct to 136 places.¹² This achievement was anticipated or outdone by an unknown calculator, whose manuscript was seen in the Radcliffe library, Oxford, by Baron von Zach towards the end of the century, and contained the ratio correct to 152 places. More astonishing still have been the deeds of the π computers of the 19th century.

⁵ See Sherwin's *Math. Tables* (London, 1705), p. 59.

⁶ See W. Jones, *Synopsis Palmariorum Matheseos* (London, 1706); Maseres, *Scriptores Logarithmici* (London, 1791-1796), iii. 159 seq.; Hutton, *Tracts*, i. 266.

⁷ See *Hist. de l'Acad.* (Paris, 1719); 7 appears instead of 8 in the 113th place.

⁸ *Comment. Acad. Petrop.* ix., xi.; *Nov. Comm. Ac. Pet.* xvi.; *Nova Acta Acad. Pet.* xi.

⁹ *Introd. in Analysis Infin.* (Lausanne, 1748), chap. viii.

¹⁰ *Mém. sur quelques propriétés remarquables des quantités transcendentes, circulaires, et logarithmiques.*

¹¹ See Legendre, *Eléments de géométrie* (Paris, 1794), note iv.; Schömilch, *Handbuch d. algeb. Analysis* (Jena, 1851), chap. xiii.

¹² *Nova Acta Petrop.* ix. 41; *Thesaurus Logarithm. Completus*, 633.

A condensed record compiled by J. W. L. Glaisher (*Messenger of Math.* ii. 122) is as follows:—

Date.	Computer.	No. of fr. digits calcd.	No. of fr. digits correct.	Place of Publication.
1842	Rutherford . .	208	152	<i>Trans. Roy. Soc.</i> (London, 1841), p. 283.
1844	Dase	205	200	<i>Crelle's Journ.</i> xxvii. 198.
1847	Clausen . . .	250	248	<i>Astron. Nachr.</i> xxv. col. 207.
1853	Shanks . . .	318	318	<i>Proc. Roy. Soc.</i> (London, 1853), 273.
1853	Rutherford . .	440	440	<i>Ibid.</i>
1853	Shanks . . .	530	..	<i>Ibid.</i>
1853	Shanks . . .	607	..	W. Shanks, <i>Rectification of the Circle</i> (London, 1853).
1853	Richter . . .	333	330	<i>Gruner's Archiv</i> , xxi. 119.
1854	Richter . . .	400	330	<i>Ibid.</i> xxii. 473.
1854	Richter . . .	400	400	<i>Ibid.</i> xxiii. 476.
1854	Richter . . .	500	500	<i>Ibid.</i> xxv. 472.
1873	Shanks . . .	707	..	<i>Proc. Roy. Soc.</i> (London), xxi.

By these computers Machin's identity, or identities analogous to it, e.g.

$$\pi/4 = \tan^{-1} \frac{1}{2} + \tan^{-1} \frac{1}{3} + \tan^{-1} \frac{1}{4} \quad (\text{Dase, 1844}),$$

$$\pi/4 = 4 \tan^{-1} \frac{1}{5} - \tan^{-1} \frac{1}{70} + \tan^{-1} \frac{1}{98} \quad (\text{Rutherford}),$$

and Gregory's series were employed.¹

A much less wise class than the π -computers of modern times are the pseudo-circle-squarers, or circle-squarers technically so called, that is to say, persons who, having obtained by illegitimate means a Euclidean construction for the quadrature or a finitely expressible value for π , insist on using faulty reasoning and defective mathematics to establish their assertions. Such persons have flourished at all times in the history of mathematics; but the interest attaching to them is more psychological than mathematical.²

It is of recent years that the most important advances in the theory of circle-quadrature have been made. In 1873 Charles Hermite proved that the base e of the Napierian logarithms cannot be a root of a rational algebraical equation of any degree.³ To prove the same proposition regarding π is to prove that a Euclidean construction for circle-quadrature is impossible. For in such a construction every point of the figure is obtained by the intersection of two straight lines, a straight line and a circle, or two circles; and as this implies that, when a unit of length is introduced, numbers employed, and the problem transformed into one of algebraic geometry, the equations to be solved can only be of the first or second degree, it follows that the equation to which we must be finally led is a rational equation of even degree. Hermite⁴ did not succeed in his attempt on π ; but in 1882 F. Lindemann, following exactly in Hermite's steps, accomplished the desired result.⁵ (See also TRIGONOMETRY.)

REFERENCES.—Besides the various writings mentioned, see for the history of the subject F. Rudio, *Geschichte des Problems von der Quadratur des Zirckels* (1892); M. Cantor, *Geschichte der Mathematik* (1894-1901); Montucla, *Hist. des. math.* (6 vols., Paris, 1758, 2nd ed. 1799-1802); Murhard, *Bibliotheca Mathematica*, ii. 106-123 (Leipzig, 1798); Reuss, *Repertorium Comment.* vii. 42-44 (Göttingen, 1808). For a few approximate geometrical solutions, see Leybourn's *Math. Repository*, vi. 151-154; *Gruner's Archiv*, xii. 98, xlix. 3; *Nieuw Archief v. Wisk.* iv. 200-204. For experimental determinations of π , dependent on the theory of probability, see *Mess. of Math.* ii. 113, 119; *Casopis pro pěstování math. a fys.* x. 272-275; *Analyst*, ix. 176. (T. Mu.)

CIRCLEVILLE, a city and the county-seat of Pickaway county, Ohio, U.S.A., about 26 m. S. by E. of Columbus, on the Scioto river and the Ohio Canal. Pop. (1890) 6556; (1900) 6991 (551 negroes); (1910) 6744. It is served by the Cincinnati & Muskingum Valley (Pennsylvania lines) and the Norfolk & Western railways, and by the Scioto Valley electric line. Circleville is situated in a farming region, and its leading industries are the manufacture of straw boards and agricultural imple-

¹ On the calculations made before Shanks, see Lehmann, "Beitrag zur Berechnung der Zahl π ," in *Gruner's Archiv*, xxi. 121-174.

² See Montucla, *Hist. des rech. sur la quad. du cercle* (Paris, 1754, 2nd ed. 1831); de Morgan, *Budget of Paradoxes* (London, 1872).

³ "Sur la fonction exponentielle," *Comptes rendus* (Paris), lxxvii. 18, 74, 226, 285.

⁴ See *Crelle's Journal*, lxxvi. 342.

⁵ See "Über die Zahl π ," in *Math. Ann.* xx. 213.

ments, and the canning of sweet corn and other produce. The city occupies the site of prehistoric earth-works, from one of which, built in the form of a circle, it derived its name. Circleville, first settled about 1806, was chosen as the county-seat in 1810. The court-house was built in the form of an octagon at the centre of the circle, and circular streets were laid out around it; but this arrangement proved to be inconvenient, the court-house was destroyed by fire in 1841, and at present no trace of the ancient landmarks remains. Circleville was incorporated as a village in 1814, and was chartered as a city in 1853.

CIRCUIT (Lat. *circuilus*, from *circum*, round, and *ire*, to go), the act of moving round; so circumference, or anything encircling or encircled. The word is particularly known as a law term, signifying the periodical progress of a legal tribunal for the purpose of carrying out the administration of the law in the several provinces of a country. It has long been applied to the journey or progress which the judges have been in the habit of making through the several counties of England, to hold courts and administer justice, where recourse could not be had to the king's court at Westminster (see ASSIZE).

In England, by sec. 23 of the Judicature Act 1875, power was conferred on the crown, by order in council, to make regulations respecting circuits, including the discontinuance of any circuit, and the formation of any new circuit, and the appointment of the place at which assizes are to be held on any circuit. Under this power an order of council, dated the 5th of February 1876, was made, whereby the circuit system was remodelled. A new circuit, called the North-Eastern circuit, was created, consisting of Newcastle and Durham taken out of the old Northern circuit, and York and Leeds taken out of the Midland circuit. Oakham, Leicester and Northampton, which had belonged to the Norfolk circuit, were added to the Midland. The Norfolk circuit and the Home circuit were abolished and a new South-Eastern circuit was created, consisting of Huntingdon, Cambridge, Ipswich, Norwich, Chelmsford, Hertford and Lewes, taken partly out of the old Norfolk circuit and partly out of the Home circuit. The counties of Kent and Surrey were left out of the circuit system, the assizes for these counties being held by the judges remaining in London. Subsequently Maidstone and Guildford were united under the revived name of the Home circuit for the purpose of the summer and winter assizes, and the assizes in these towns were held by one of the judges of the Western circuit, who, after disposing of the business there, rejoined his colleague in Exeter. In 1899 this arrangement was abolished, and Maidstone and Guildford were added to the South-Eastern circuit. Other minor changes in the assize towns were made, which it is unnecessary to particularize. Birmingham first became a circuit town in the year 1884, and the work there became, by arrangement, the joint property of the Midland and Oxford circuits. There are alternative assize towns in the following counties, viz.:—On the Western circuit, Salisbury and Devizes for Wiltshire, and Wells and Taunton for Somerset; on the South-Eastern, Ipswich and Bury St Edmunds for Suffolk, on the North Wales circuit, Welshpool and Newtown for Montgomery; and on the South Wales circuit, Cardiff and Swansea for Glamorgan.

According to the arrangements in force in 1909 there are four assizes in each year. There are two principal assizes, viz. the winter assizes, beginning in January, and the summer assizes, beginning at the end of May. At these two assizes criminal and civil business is disposed of in all the circuits. There are two other assizes, viz. the autumn assizes and the Easter assizes. The autumn assizes are regulated by acts of 1876 and 1877 (Winter Assizes Acts 1876 and 1877), and orders of council made under the former act. They are held for the whole of England and Wales, but for the purpose of these assizes the work is to a large extent "grouped," so that not every county has a separate assize. For example, on the South-Eastern circuit Huntingdon

is grouped with Cambridge; on the Midland, Rutland is grouped with Lincoln; on the Northern, Westmorland is grouped with Cumberland; and the North Wales and South Wales circuits are united, and no assizes are held at some of the smaller towns. At these assizes criminal business only is taken, except at Manchester, Liverpool, Swansea, Birmingham and Leeds. The Easter assizes are held in April and May on two circuits only, viz. at Manchester and Liverpool on the Northern and at Leeds on the North-Eastern. Both civil and criminal business is taken at Manchester and Liverpool, but criminal business only at Leeds.

Other changes were made, with a view to preventing the complete interruption of the London sittings in the common law division by the absence of the judges on circuit. The assizes were so arranged as to commence on different dates in the various circuits. For example, the summer assizes begin in the South-Eastern and Western circuits on the 29th of May; in the Northern circuit on the 28th of June; in the Midland and Oxford circuits on the 16th of June; in the North-Eastern circuit on the 6th of July; in the North Wales circuit on the 7th of July; and in the South Wales circuit on the 11th of July. Again, there has been a continuous development of what may be called the single-judge system. In the early days of the new order the members of the court of appeal and the judges of the chancery division shared the circuit work with the judges in the common law division. This did not prove to be a satisfactory arrangement. The assize work was not familiar and was uncongenial to the chancery judges, who had but little training or experience to fit them for it. Arrears increased in chancery, and the appeal court was shorn of much of its strength for a considerable part of the year. The practice was discontinued in or about the year 1884. The appeal and chancery judges were relieved of the duty of going on circuit, and an arrangement was made by the treasury for making an allowance for expenses of circuit to the common law judges, on whom the whole work of the assizes was thrown. In order to cope with the assize work, and at the same time keep the common law sittings going in London, an experiment, which had been previously tried by Lord Cairns and Lord Cross (then home secretary) and discontinued, was revived. Instead of two judges going together to each assize town, it was arranged that one judge should go by himself to certain selected places—practically, it may be said, to all except the more important provincial centres. The only places to which two judges now go are Exeter, Winchester, Bristol, Manchester, Liverpool, Nottingham, Stafford, Birmingham, Newcastle, Durham, York, Leeds, Chester, and Cardiff or Swansea.

It could scarcely be said that, even with the amendments introduced under orders in council, the circuit system was altogether satisfactory or that the last word had been pronounced on the subject. In the first report of the Judicature Commission, dated March 25th, 1869, p. 17 (*Parl. Papers*, 1868-1869), the majority report that "the necessity for holding assizes in every county without regard to the extent of the business to be transacted in such county leads, in our judgment, to a great waste of judicial strength and a great loss of time in going from one circuit town to another, and causes much unnecessary cost and inconvenience to those whose attendance is necessary or customary at the assizes." And in their second report, dated July 3rd, 1872 (*Parl. Papers*, 1872, vol. xx.), they dwell upon the advisability of grouping or a discontinuance of holding assizes "in several counties, for example, Rutland and Westmorland, where it is manifestly an idle waste of time and money to have assizes." It is thought that the grouping of counties which has been effected for the autumn assizes might be carried still further and applied to all the assizes; and that the system of holding the assizes alternately in one of two towns within a county might be extended to two towns in adjoining counties, for example, Gloucester and Worcester. The facility of railway communication renders this reform comparatively easy, and reforms in this direction have been approved by the judges, but ancient custom and local patriotism, interests, or susceptibility bar the way. The

Assizes and Quarter Sessions Act 1908 contributed something to reform by dispensing with the obligation to hold assizes at a fixed date if there is no business to be transacted. Nor can it be said that the single-judge system has been altogether a success. When there is only one judge for both civil and criminal work, he properly takes the criminal business first. He can fix only approximately the time when he can hope to be free for the civil business. If the calendar is exceptionally heavy or one or more of the criminal cases prove to be unexpectedly long (as may easily happen), the civil business necessarily gets squeezed into the short residue of the allotted time. Suitors and their solicitors and witnesses are kept waiting for days, and after all perhaps it proves to be impossible for the judge to take the case, and a "remanet" is the result. It is the opinion of persons of experience that the result has undoubtedly been to drive to London much of the civil business which properly belongs to the provinces, and ought to be tried there, and thus at once to increase the burden on the judges and jurymen in London, and to increase the costs of the trial of the actions sent there. Some persons advocate the continuous sittings of the high court in certain centres, such as Manchester, Liverpool, Leeds, Newcastle, Birmingham and Bristol, or (in fact) a decentralization of the judicial system. There is already an excellent court for chancery cases for Lancashire in the county palatine court, presided over by the vice-chancellor, and with a local bar which has produced many men of great ability and even eminence. The Durham chancery court is also capable of development. Another suggestion has been made for continuous circuits throughout the legal year, so that a certain number of the judges, according to a rota, should be continuously in the provinces while the remaining judges did the London business. The value of this suggestion would depend on an estimate of the number of cases which might thus be tried in the country in relief of the London list. This estimate it would be difficult to make. The opinion has also been expressed that it is essential in any changes that may be made to retain the occasional administration by judges of the high court of criminal jurisdiction, both in populous centres and in remote places. It promotes a belief in the importance and dignity of justice and the care to be given to all matters affecting a citizen's life, liberty or character. It also does something, by the example set by judges in country districts, to check any tendency to undue severity of sentences in offences against property.

Counsel are not expected to practise on a circuit other than that to which they have attached themselves, unless they receive a special retainer. They are then said to "go special," and the fee in such a case is one hundred guineas for a king's counsel, and fifty guineas for a junior. It is customary to employ one member of the circuit on the side on which the counsel comes special. Certain rules have been drawn up by the Bar Committee for regulating the practice as to retainers on circuit. (1) A special retainer must be given for a particular assize (a circuit retainer will not, however, make it compulsory upon counsel retained to go the circuit, but will give the right to counsel's services should he attend the assize and the case be entered for trial); (2) if the venue is changed to another place on the same circuit, a fresh retainer is not required; (3) if the action is not tried at the assize for which the retainer is given, the retainer must be renewed for every subsequent assize until the action is disposed of, unless a brief has been delivered; (4) a retainer may be given for a future assize, without a retainer for an intervening assize, unless notice of trial is given for such intervening assize. There are also various regulations enforced by the discipline of the circuit bar mess.

In the United States the English circuit system still exists in some states, as in Massachusetts, where the judges sit in succession in the various counties of the state. The term *circuit courts* applies distinctively in America to a certain class of inferior federal courts of the United States, exercising jurisdiction, concurrently with the state courts, in certain matters where the United States is a party to the litigation, or in cases of crime against the United States. The circuit courts act in

nine judicial circuits, divided as follows: *1st circuit*, Maine, Massachusetts, New Hampshire, Rhode Island; *2nd circuit*, Connecticut, New York, Vermont; *3rd circuit*, Delaware, New Jersey, Pennsylvania; *4th circuit*, Maryland, North Carolina, South Carolina, Virginia, West Virginia; *5th circuit*, Alabama, Florida, Georgia, Louisiana, Mississippi, Texas; *6th circuit*, Kentucky, Michigan, Ohio, Tennessee; *7th circuit*, Illinois, Indiana, Wisconsin; *8th circuit*, Arkansas, Colorado, Oklahoma, Iowa, Kansas, Minnesota, Missouri, Nebraska, New Mexico, North Dakota, South Dakota, Utah, Wyoming; *9th circuit*, Alaska, Arizona, California, Idaho, Montana, Nevada, Oregon, Washington, and Hawaii. A circuit court of appeals is made up of three judges of the circuit court, the judges of the district courts of the circuit, and the judge of the Supreme Court allotted to the circuit.

In Scotland the judges of the supreme criminal court, or high court of justiciary, form also three separate circuit courts, consisting of two judges each; and the country, with the exception of the Lothians, is divided into corresponding districts, called the Northern, Western and Southern circuits. On the Northern circuit, courts are held at Inverness, Perth, Dundee and Aberdeen; on the Western, at Glasgow, Stirling and Inveraray; and on the Southern, at Dumfries, Jedburgh and Ayr.

Ireland is divided into the North-East and the North-West circuits, and those of Leinster, Connaught and Munster.

CIRCULAR NOTE, a documentary request by a bank to its foreign correspondents to pay a specified sum of money to a named person. The person in whose favour a circular note is issued is furnished with a letter (containing the signature of an official of the bank and the person named) called a letter of indication, which is usually referred to in the circular note, and must be produced on presentation of the note. Circular notes are generally issued against a payment of cash to the amount of the notes, but the notes need not necessarily be cashed, but may be returned to the banker in exchange for the amount for which they were originally issued. A forged signature on a circular note conveys no right, and as it is the duty of the payer to see that payment is made to the proper person, he cannot recover the amount of a forged note from the banker who issued the note. (See also **LETTER OF CREDIT**.)

CIRCULUS IN PROBANDO (Lat. for "circle in proving"), in logic, a phrase used to describe a form of argument in which the very fact which one seeks to demonstrate is used as a premise, *i.e.* as part of the evidence on which the conclusion is based. This argument is one form of the fallacy known as *petitio principii*, "begging the question." It is most common in lengthy arguments, the complicated character of which enables the speaker to make his hearers forget the data from which he began. (See **FALLACY**.)

CIRCUMCISION (Lat. *circum*, round, and *caedere*, to cut), the cutting off of the foreskin. This surgical operation, which is commonly prescribed for purely medical reasons, is also an initiation or religious ceremony among Jews and Mahomedans, and is a widespread institution in many Semitic races. It remains, with Jews, a necessary preliminary to the admission of proselytes, except in some Reformed communities. The origin of the rite among the Jews is in Genesis (xvii.) placed in the age of Abraham, and at all events it must have been very ancient, for flint stones were used in the operation (Exodus iv. 25; Joshua v. 2). The narrative in Joshua implies that the custom was introduced by him, not that it had merely been in abeyance in the Wilderness. At Gilgal he "rolled away the reproach of the Egyptians" by circumcising the people. This obviously means that whereas the Egyptians practised circumcision the Jews in the land of the Pharaohs did not, and hence were regarded with contempt. It was an old theory (Herodotus ii. 36) that circumcision originated in Egypt; at all events it was practised in that country in ancient times (Ebers, *Egypten und die Bücher Moses*, i. 278-284), and the same is true at the present day. But it is not generally thought probable that the Hebrews derived the rite directly from the Egyptians. As Driver puts it (*Genesis*, p. 190): "It is possible that, as Dillmann and Nowack

suppose, the peoples of N. Africa and Asia who practised the rite adopted it from the Egyptians, but it appears in so many parts of the world that it must at any rate in these cases have originated independently." In another biblical narrative (Exodus iv. 25) Moses is subject to the divine anger because he had not made himself "a bridegroom of blood," that is, had not been circumcised before his marriage.

The rite of circumcision was practised by all the inhabitants of Palestine with the exception of the Philistines. It was an ancient custom among the Arabs, being presupposed in the Koran. The only important Semitic peoples who most probably did not follow the rite were the Babylonians and Assyrians (Sayce, *Babyl. and Assyrians*, p. 47). Modern investigations have brought to light many instances of the prevalence of circumcision in various parts of the world. These facts are collected by Andrée and Ploss, and go to prove that the rite is not only spread through the Mahomedan world (Turks, Persians, Arabs, &c.), but also is practised by the Christian Abyssinians and the Copts, as well as in central Australia and in America. In central Australia (Spencer and Gillen, pp. 212-386) circumcision with a stone knife must be undergone by every youth before he is reckoned a full member of the tribe or is permitted to enter on the married state. In other parts, too (*e.g.* Loango), no uncircumcised man may marry. Circumcision was known to the Aztecs (Bancroft, *Native Races*, vol. iii.), and is still practised by the Caribs of the Orinoco and the Tacunas of the Amazon. The method and period of the operation vary in important particulars. Among the Jews it is performed in infancy, when the male child is eight days old. The child is named at the same time, and the ceremony is elaborate. The child is carried in to the godfather (*sandek*, a hebraized form of the Gr. *σύντεκνος*, "godfather," post-class.), who places the child on a cushion, which he holds on his knees throughout the ceremony. The operator (*mohel*) uses a steel knife, and pronounces various benedictions before and after the rite is performed (see S. Singer, *Authorized Daily Prayer Book*, pp. 304-307; an excellent account of the domestic festivities and spiritual joys associated with the ceremony among medieval and modern Jews may be read in S. Schechter's *Studies in Judaism*, first series, pp. 351 seq.). Some tribes in South America and elsewhere are said to perform the rite on the eighth day, like the Jews. The Mazequas do it between the first and second months. Among the Bedouins the rite is performed on children of three years, amid dances and the selection of brides (Doughty, *Arabia Deserta*, i. 340); among the Somalis the age is seven (Reinisch, *Somalisprache*, p. 110). But for the most part the tribes who perform the rite carry it out at the age of puberty. Many facts bearing on this point are given by B. Stade in *Zeitschrift für die alttest. Wissenschaft*, vi. (1886) pp. 132 seq.

The significance of the rite of circumcision has been much disputed. Some see in it a tribal badge. If this be the true origin of circumcision, it must go back to the time when men went about naked. Mutilations (tattooing, removal of teeth and so forth) were tribal marks, being partly sacrifices and partly means of recognition (see **MUTILATION**). Such initiatory rites were often frightful ordeals, in which the neophyte's courage was severely tested (Robertson Smith, *Religion of the Semites*, p. 310). Some regard circumcision as a substitute for far more serious rites, including even human sacrifice. Utilitarian explanations have also been suggested. Sir R. Burton (*Memoirs Anthropol. Soc.* i. 318) held that it was introduced to promote fertility, and the claims of cleanliness have been put forward (following Philo's example, see ed. Mangey, ii. 210). Most probably, however, circumcision (which in many tribes is performed on both sexes) was connected with marriage, and was a preparation for connubium. It was in Robertson Smith's words "originally a preliminary to marriage, and so a ceremony of introduction to the full prerogative of manhood," the transference to infancy among the Jews being a later change. On this view, the decisive Biblical reference would be the Exodus passage (iv. 25), in which Moses is represented as being in danger of his life because he had neglected the proper preliminary to marriage. In Genesis, on the other hand, circumcision is an

external sign of God's covenant with Israel, and later Judaism now regards it in this symbolical sense. Barton (*Semitic Origins*, p. 100) declares that "the circumstances under which it is performed in Arabia point to the origin of circumcision as a sacrifice to the goddess of fertility, by which the child was placed under her protection and its reproductive powers consecrated to her service." But Barton admits that initiation to the connubium was the primitive origin of the rite.

As regards the non-ritual use of male circumcision, it may be added that in recent years the medical profession has been responsible for its considerable extension among other than Jewish children, the operation being recommended not merely in cases of malformation, but generally for reasons of health.

AUTHORITIES.—On the present diffusion of circumcision see H. Ploss, *Das Kind im Brauch und Sitte der Völker*, i. 342 seq., and his researches in *Deutsches Archiv für Geschichte der Medizin*, viii. 312-344; André, "Die Beschneidung" in *Archiv für Anthropologie*, xiii. 76; and Spencer and Gillen, *Tribes of Central Australia*. The articles in the *Encyclopaedia Biblica* and *Dictionary of the Bible* contain useful bibliographies as well as historical accounts of the rite and its ceremonies, especially as concerns the Jews. The *Jewish Encyclopedia* in particular gives an extensive list of books on the Jewish customs connected with circumcision, and the various articles in that work are full of valuable information (vol. iv. pp. 92-102). On the rite among the Arabs, see Wellhausen, *Reste arabischen Heidentums*, 154. (I. A.)

CIRCUMVALLATION, LINES OF (from Lat. *circum*, round, and *vallum*, a rampart), in fortification, a continuous circle of entrenchments surrounding a besieged place. "Lines of Contravallation" were similar works by which the besieger protected himself against the attack of a relieving army from any quarter. These continuous lines of circumvallation and contravallation were used only in the days of small armies and small fortresses, and both terms are now obsolete.

CIRCUS (Lat. *circus*, Gr. *κίρκος* or *κρίκος*, a ring or circle; probably "circus" and "ring" are of the same origin), a space, in the strict sense circular, but sometimes oval or even oblong, intended for the exhibition of races and athletic contests generally. The circus differs from the theatre inasmuch as the performance takes place in a central circular space, not on a stage at one end of the building.

1. In Roman antiquities the circus was a building for the exhibition of horse and chariot races and other amusements. It consisted of tiers of seats running parallel with the sides of the course, and forming a crescent round one of the ends. The other end was straight and at right angles to the course, so that the plan of the whole had nearly the form of an ellipse cut in half at its vertical axis. Along the transverse axis ran a fence (*spina*) separating the return course from the starting one. The straight end had no seats, but was occupied by the stalls (*carceres*) where the chariots and horses were held in readiness. This end constituted also the front of the building with the main entrance. At each end of the course were three conical pillars (*metae*) to mark its limits.

The oldest building of this kind in Rome was the *Circus Maximus*, in the valley between the Palatine and Aventine hills, where, before the erection of any permanent structure, races appear to have been held beside the altar of the god Consus. The first building is assigned to Tarquin the younger, but for a long time little seems to have been done to complete its accommodation, since it is not till 329 B.C. that we hear of stalls being erected for the chariots and horses. It was not in fact till under the empire that the circus became a conspicuous public resort. Caesar enlarged it to some extent, and also made a canal 10 ft. broad between the lowest tier of seats (*podium*) and the course as a precaution for the spectators' safety when exhibitions of fighting with wild beasts, such as were afterwards confined to the amphitheatre, took place. When these exhibitions were removed, and the canal (*curipus*) was no longer necessary, Nero had it filled up. Augustus is said to have placed an obelisk on the *spina* between the *metae*, and to have built a new *pulvinar*, or imperial box; but if this is taken in connexion with the fact that the circus had been partially destroyed by fire in 31 B.C., it may be supposed that besides this he had

restored it altogether. Only the lower tiers of seats were of stone, the others being of wood, and this, from the liability to fire, may account for the frequent restorations to which the circus was subject, it would also explain the falling of the seats by which a crowd of people were killed in the time of Antoninus Pius. In the reign of Claudius, apparently after a fire, the *carceres* of stone (*tufa*) were replaced by marble, and the *metae* of wood by gilt bronze. Under Domitian, again, after a fire, the circus was rebuilt and the *carceres* increased to 12 instead of 8 as before. The work was finished by Trajan. See further for seating capacity, &c., ROME. *Archaeology*, § "Places of Amusement."

The circus was the only public spectacle at which men and women were not separated. The lower seats were reserved for persons of rank; there were also various state boxes, e.g. for the giver of the games and his friends (called *cubicula* or *suggestus*). The principal object of attraction apart from the racing must have been the *spina* or low wall which ran down the middle of the course, with its obelisks, images and ornamental shrines. On it also were seven figures of dolphins and seven oval objects, one of which was taken down at every round made in a race, so that spectators might see readily how the contest proceeded. The chariot race consisted of seven rounds of the course. The chariots started abreast, but in an oblique line, so that the outer chariot might be compensated for the wider circle it had to make at the other end. Such a race was called a *missus*, and as many as 24 of these would take place in a day. The competitors wore different colours, originally white and red (*albata* and *russata*), to which green (*prasina*) and blue (*veneta*) were added. Domitian introduced two more colours, gold and purple (*purpureus* et *auratus pannus*), which probably fell into disuse after his death. To provide the horses and large staff of attendants it was necessary to apply to rich capitalists and owners of studs, and from this there grew up in time four select companies (*factiones*) of circus purveyors, which were identified with the four colours, and with which those who organized the races had to contract for the proper supply of horses and men. The drivers (*aurigae*, *agitatores*), who were mostly slaves, were sometimes held in high repute for their skill, although their calling was regarded with contempt. The horses most valued were those of Sicily, Spain and Cappadocia, and great care was taken in training them. Chariots with two horses (*bigae*) or four (*quadrigae*) were most common, but sometimes also they had three (*trigae*), and exceptionally more than four horses. Occasionally there was combined with the chariots a race of riders (*desultores*), each rider having two horses and leaping from one to the other during the race. At certain of the races the proceedings were opened by a *pompa* or procession in which images of the gods and of the imperial family deified were conveyed in cars drawn by horses, mules or elephants, attended by the colleges of priests, and led by the presiding magistrate (in some cases by the emperor himself) seated in a chariot in the dress and with the insignia of a triumphator. The procession passed from the capitol along the forum, and on to the circus, where it was received by the people standing and clapping their hands. The presiding magistrate gave the signal for the races by throwing a white flag (*mappa*) on to the course.

Next in importance to the Circus Maximus in Rome was the *Circus Flaminius*, erected 221 B.C., in the censorship of C. Flaminius, from whom it may have taken its name; or the name may have been derived from Prata Flaminia, where it was situated, and where also were held plebeian meetings. The only games that are positively known to have been celebrated in this circus were the *Ludi Taurii* and *Plebei*. There is no mention of it after the 1st century. Its ruins were identified in the 16th century at S. Catarina dei Funari and the Palazzo Mattei.

A third circus in Rome was erected by Caligula in the gardens of Agrippina, and was known as the *Circus Neronis*, from the notoriety which it obtained through the Circensian pleasures of Nero. A fourth was constructed by Maxentius outside the Porta Appia near the tomb of Caecilia Metella, where its ruins

are still, and now afford the only instance from which an idea of the ancient circi in Rome can be obtained. It was traced to Caracalla, till the discovery of an inscription in 1825 showed it to be the work of Maxentius. Old topographers speak of six circi, but two of these appear to be imaginary, the Circus Florae and the Circus Sallustii.

Circus races were held in connexion with the following public festivals, and generally on the last day of the festival, if it extended over more than one day:—(1) The *Consualia*, August 21st, December 15th; (2) *Equirria*, February 27th, March 14th; (3) *Ludi Romani*, September 4th-19th; (4) *Ludi Plebei*, November 4th-17th; (5) *Cerialia*, April 12th-19th; (6) *Ludi Apollinares*, July 6th-13th; (7) *Ludi Megalenses*, April 4th-10th; (8) *Floralia*, April 28th-May 3rd.

In addition to Smith's *Dictionary of Antiquities* (3rd ed., 1890), see articles in Daremberg and Saglio's *Dictionnaire des antiquités*, Pauly-Wissowa's *Realencyclopädie der classischen Altertumswissenschaft*, iii. 2 (1899), and Marquardt, *Römische Staatsverwaltung*, iii. (2nd ed., 1885), p. 504. For existing remains see works quoted under ROME: *Archaeology*.

2. *The Modern Circus*.—The "circus" in modern times is a form of popular entertainment which has little in common with the institution of classical Rome. It is frequently nomadic in character, the place of the permanent building known to the ancients as the circus being taken by a tent, which is carried from place to place and set up temporarily on any site procurable at country fairs or in provincial towns, and in which spectacular performances are given by a troupe employed by the proprietor. The centre of the tent forms an arena arranged as a horse-ring, strewn with tan or other soft substance, where the performances take place, the seats of the spectators being arranged in ascending tiers around the central space as in the Roman circus. The traditional type of exhibition in the modern travelling circus consists of feats of horsemanship, such as leaping through hoops from the back of a galloping horse, standing with one foot on each of two horses galloping side by side, turning somersaults from a springboard over a number of horses standing close together, or accomplishing acrobatic tricks on horseback. These performances, by male and female riders, are varied by the introduction of horses trained to perform tricks, and by drolleries on the part of the clown, whose place in the circus is as firmly established by tradition as in the pantomime.

The popularity of the circus in England may be traced to that kept by Philip Astley (d. 1814) in London at the end of the 18th century. Astley was followed by Ducrow, whose feats of horsemanship had much to do with establishing the traditions of the circus, which were perpetuated by Hengler's and Sanger's celebrated shows in a later generation. In America a circus-actor named Ricketts is said to have performed before George Washington in 1780, and in the first half of the 19th century the establishments of Purdy, Welch & Co., and of van Amburgh gave a wide popularity to the circus in the United States. All former circus-proprietors were, however, far surpassed in enterprise and resource by P. T. Barnum (*q.v.*), whose claim to be the possessor of "the greatest show on earth" was no exaggeration. The influence of Barnum, however, brought about a considerable change in the character of the modern circus. In arenas too large for speech to be easily audible, the traditional comic dialogue of the clown assumed a less prominent place than formerly, while the vastly increased wealth of stage properties relegated to the background the old-fashioned equestrian feats, which were replaced by more ambitious acrobatic performances, and by exhibitions of skill, strength and daring, requiring the employment of immense numbers of performers and often of complicated and expensive machinery. These tendencies are, as is natural, most marked in shows given in permanent buildings in large cities, such as the London Hippodrome, which was built as a combination of the circus, the menagerie and the variety theatre, where wild animals such as lions and elephants from time to time appeared in the ring, and where convulsions of nature such as floods, earthquakes and volcanic eruptions have been produced with an extraordinary wealth of realistic display. At the Hippodrome in Paris—unlike its London namesake, a

circus of the true classical type in which the arena is entirely surrounded by the seats of the spectators—chariot races after the Roman model were held in the latter part of the 19th century, at which prizes of considerable value were given by the management.

CIRENCESTER (traditionally pronounced *Ciceter*), a market town in the Cirencester parliamentary division of Gloucestershire, England, on the river Churn, a tributary of the Thames, 93 m. W.N.W. of London. Pop. of urban district (1901) 7536. It is served by a branch of the Great Western railway, and there is also a station on the Midland and South-Western Junction railway. This is an ancient and prosperous market town of picturesque old houses clustering round a fine parish church, with a high embattled tower, and a remarkable south porch with parvise. The church is mainly Perpendicular, and among its numerous chapels that of St Catherine has a beautiful roof of fan-tracery in stone dated 1508. Of the abbey founded in 1117 by Henry I. there remain a Norman gateway and a few capitals. There are two good museums containing mosaics, inscriptions, carved and sculptured stones, and many smaller remains, for the town was the Roman *Corinium* or *Durocornovium Dobunorum*. Little trace of Corinium, however, can be seen *in situ*, except the amphitheatre and some indications of the walls. To the west of the town is Cirencester House, the seat of Earl Bathurst. The first Lord Bathurst (1684-1775) devoted himself to beautifying the fine demesne of Oakley Park, which he planted and adorned with remarkable artificial ruins. This nobleman, who became baron in 1711 and earl in 1772, was a patron of art and literature no less than a statesman; and Pope, a frequent visitor here, was allowed to design the building known as Pope's Scat, in the park, commanding a splendid prospect of woods and avenues. Swift was another appreciative visitor. The house contains portraits by Lawrence, Gainsborough, Romney, Lely, Reynolds, Hoppner, Kneller and many others. A mile west of the town is the Royal Agricultural College, incorporated by charter in 1845. Its buildings include a chapel, a dining hall, a library, a lecture theatre, laboratories, classrooms, private studies and dormitories for the students, apartments for resident professors, and servants' offices; also a museum containing a collection of anatomical and pathological preparations, and mineralogical, botanical and geological specimens. The college farm comprises 500 acres, 450 of which are arable; and on it are the well-appointed farm-buildings and the veterinary hospital. Besides agriculture, the course of instruction at the college includes chemistry, natural and mechanical philosophy, natural history, mensuration, surveying and drawing, and other subjects of practical importance to the farmer, proficiency in which is tested by means of sessional examinations. The industries of Cirencester comprise various branches of agriculture. It has connexion by a branch canal with the Thames and Severn canal.

Corinium was a flourishing Romano-British town, at first perhaps a cavalry post, but afterwards, for the greater part of the Roman period, purely a civilian city. At Chedworth, 7 m. N.E., is one of the most noteworthy Roman villas in England. Cirencester (*Cirneceaster*, *Cyrenceaster*, *Cyringceaster*) is described in Domesday as ancient demesne of the crown. The manor was granted by William I. to William Fitzosbern; on reverting to the crown it was given in 1189, with the township, to the Augustinian abbey founded here by Henry I. The struggle of the townsmen to prove that Cirencester was a borough probably began in the same year, when they were amerced for a false presentment. Four inquisitions during the 13th century supported the abbot's claims, yet in 1343 the townsmen declared in a chancery bill of complaint that Cirencester was a borough distinct from the manor, belonging to the king but usurped by the abbot, who since 1308 had abated their court of provosty. Accordingly they produced a copy of a forged charter from Henry I. to the town; the court ignored this and the abbot obtained a new charter and a writ of *supersedeas*. For their success against the earls of Kent and Salisbury Henry IV in 1403 gave the townsmen a gild merchant, although two

inquisitions reiterated the abbot's rights. These were confirmed in 1408-1409 and 1413; in 1418 the charter was annulled, and in 1477 parliament declared that Cirencester was not corporate. After several unsuccessful attempts to re-establish the gild merchant, the government in 1592 was vested in the bailiff of the lord of the manor. Cirencester became a parliamentary borough in 1572, returning two members, but was deprived of representation in 1885. Besides the "new market" of Domesday Book the abbots obtained charters in 1215 and 1253 for fairs during the octaves of All Saints and St Thomas the Martyr. The wool trade gave these great importance; in 1341 there were ten wool merchants in Cirencester, and Leland speaks of the abbots' cloth-mill, while Camden calls it the greatest market for wool in England.

See *Transactions of the Bristol and Gloucestershire Archaeological Society*, vols. ii., ix., xviii.

CIRILLO, DOMENICO (1739-1799), Italian physician and patriot, was born at Grumo in the kingdom of Naples. Appointed while yet a young man to a botanical professorship, Cirillo went some years afterwards to England, where he was elected fellow of the Royal Society, and to France. On his return to Naples he was appointed successively to the chairs of practical and theoretical medicine. He wrote voluminously and well on scientific subjects and secured an extensive medical practice. On the French occupation of Naples and the proclamation of the Parthenopean republic (1799), Cirillo, after at first refusing to take part in the new government, consented to be chosen a representative of the people and became a member of the legislative commission, of which he was eventually elected president. On the abandonment of the republic by the French (June 1799), Cardinal Ruffo and the army of King Ferdinand IV. returned to Naples, and the Republicans withdrew, ill-armed and inadequately provisioned, to the forts. After a short siege they surrendered on honourable terms, life and liberty being guaranteed them by the signatures of Ruffo, of Foote, and of Micheroux. But the arrival of Nelson changed the complexion of affairs, and he refused to ratify the capitulation. Secure under the British flag, Ferdinand and his wife, Caroline of Austria, showed themselves eager for revenge, and Cirillo was involved with the other republicans in the vengeance of the royal family. He asked Lady Hamilton (wife of the British minister to Naples) to intercede on his behalf, but Nelson wrote in reference to the petition: "Domenico Cirillo, who had been the king's physician, might have been saved, but that he chose to play the fool and lie, denying that he had ever made any speeches against the government, and saying that he only took care of the poor in the hospitals" (*Nelson and the Neapolitan Jacobins*, Navy Records Society, 1903). He was condemned and hanged on the 29th of October 1799. Cirillo, whose favourite study was botany, and who was recognized as an entomologist by Linnaeus, left many books, in Latin and Italian, all of them treating of medical and scientific subjects, and all of little value now. Exception must, however, be made in favour of the *Virtù morali dell' Asino*; a pleasant philosophical pamphlet remarkable for its double charm of sense and style. He introduced many medical innovations into Naples, particularly inoculation for smallpox.

See C. Giglioli, *Naples in 1799* (London, 1903); L. Conforti, *Napoli nel 1799* (Naples, 1889); C. Tivaroni, *L'Italia durante il dominio francese*, vol. ii. pp. 179-204. Also under NAPLES; NELSON and FERDINAND IV. OF NAPLES.

CIRQUE (Lat. *circus*, ring), a French word used in physical geography to denote a semicircular crater-like amphitheatre at the head of a valley, or in the side of a glaciated mountain. The valley cirque is characteristic of calcareous districts. In the Chiltern Hills especially, and generally along the chalk escarpments, a flat-bottomed valley with an intermittent stream winds into the hill and ends suddenly in a cirque. There is an excellent example at Ivinghoe, Buckinghamshire, where it appears as though an enormous flat-bottomed scoop had been driven into the hillside and dragged outwards to the plain. In all cases it is found that the valley floor consists of hard or

impervious rock above which lies a permeable or soluble stratum of considerable thickness. In the case of the chalk hills the upper strata are very porous, and the descending water with atmospheric and humous acids in solution has great solvent power. During the winter this upper layer becomes saturated and some of the water drains away along joints in the escarpment. An underground stream is thus developed carrying away a great deal of material in solution, and in consequence the ground above slowly collapses over the stream, while the cirque at the head, where the stream issues, gradually works backward and may pass completely through the hills, leaving a gap of which another drainage system may take possession. In the limestone country of the Cotteswold Hills, many small intermittent tributary streams are headed by cirques, and some of the longer dry valleys have springs issuing from beneath their lower ends, the dry valleys being collapsed areas above underground streams not yet revealed. In this case the pervious limestone is underlain by beds of impervious clay. There are many of these in the Jura Mountains. The Cirque de St Sulpice is a fine example where the impervious bed is a marly clay.

The origin of the glacial cirque is entirely different and is said by W. D. Johnson (*Journal of Geology*, xii. No. 7, 1904) to be due to basal sapping and erosion under the *bergschrund* of the glacier. In this he is supported by G. K. Gilbert in the same journal, who produces some remarkable examples from the Sierra Nevada in California, where the mountain fragments have been left behind "like a sheet of dough upon a board after the biscuit tin has done its work"; so that above the head of the glaciers "the rock detail is rugged and splintered but its general effect is that of a great symmetrical arc." Descending one of the *bergschrunds* of Mt. Lyell to a depth of 150 ft., Johnson found a rock floor cumbered with ice and blocks of rock and the rock face a literally vertical cliff "much riven, its fracture planes outlining sharp angular masses in all stages of displacement and dislodgment." Judging from these facts, he interprets the deep valleys with cirques at their head in formerly glaciated regions where at the head there is a "reversed grade" of slope, as due to ice-erosion at valley-heads where scour is impossible at the sides of the mountain but strongest under the glacier head where the ice is deepest. The opponents of ice-erosion nevertheless recognize the very frequent occurrence of glacial cirques often containing small lakes such as that under Cader Idris in Wales, or at the head of Little Timber Creek, Montana, and numerous examples in Alpine districts.

CIRTA (mod. *Constantine*, *q.v.*), an ancient city of Numidia, in Africa, in the country of the Massyli. It was regarded by the Romans as the strongest position in Numidia, and was made by them the converging point of all their great military roads in that country. By the early emperors it was allowed to fall into decay, but was afterwards restored by Constantine, from whom it took its modern name.

CISSEY, ERNEST LOUIS OCTAVE COURTOT DE (1810-1882), French general, was born at Paris on the 23rd of September 1810, and after passing through St Cyr, entered the army in 1832, becoming captain in 1839. He saw active service in Algeria, and became *chef d'escadron* in 1849 and lieutenant-colonel in 1850. He took part as a colonel in the Crimean War, and after the battle of Inkerman received the rank of general of brigade. In 1863 he was promoted general of division. When the Franco-German War broke out in 1870, de Cissey was given a divisional command in the Army of the Rhine, and he was included in the surrender of Bazaine's army at Metz. He was released from captivity only at the end of the war, and on his return was at once appointed by the Versailles government to a command in the army engaged in the suppression of the Commune, a task in the execution of which he displayed great rigour. From July 1871 de Cissey sat as a deputy, and he had already become minister of war. He occupied this post several times during the critical period of the reorganization of the French army. In 1880, whilst holding the command of the XI. corps at Nantes, he was accused of having relations with a certain Baroness Kaula, who was said to be a spy in the pay of Germany, and

he was in consequence relieved from duty. An inquiry subsequently held resulted in de Cisse's favour (1881). He died on the 15th of June 1882 at Paris.

CISSOID (from the Gr. *κισσός*, ivy, and *εἶδος*, form), a curve invented by the Greek mathematician Diocles about 180 B.C., for the purpose of constructing two mean proportionals between two given lines, and in order to solve the problem of duplicating the cube. It was further investigated by John Wallis, Christiaan Huygens (who determined the length of any arc in 1657), and Pierre de Fermat (who evaluated the area between the curve and its asymptote in 1661). It is constructed in the following manner. Let APB be a semicircle, BT the tangent at B, and APT a line cutting the circle in P and BT at T; take

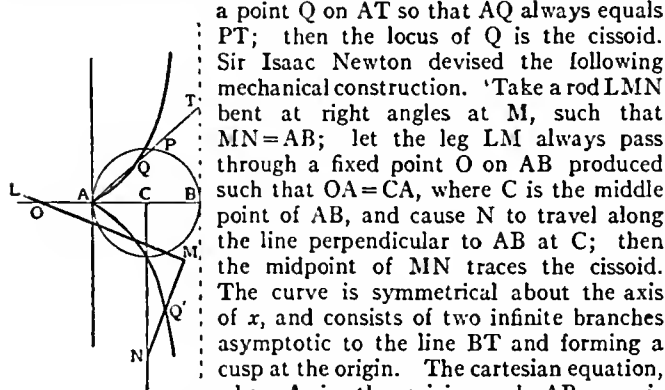

a point Q on AT so that AQ always equals PT; then the locus of Q is the cissoid. Sir Isaac Newton devised the following mechanical construction. 'Take a rod LMN bent at right angles at M, such that MN=AB; let the leg LM always pass through a fixed point O on AB produced such that OA=CA, where C is the middle point of AB, and cause N to travel along the line perpendicular to AB at C; then the midpoint of MN traces the cissoid. The curve is symmetrical about the axis of x, and consists of two infinite branches asymptotic to the line BT and forming a cusp at the origin. The cartesian equation, when A is the origin and AB=2a, is $y^2(2a-x)=x^3$; the polar equation is $r=2a \sin \theta \tan \theta$. The cissoid is the first positive pedal of the parabola $y^2+8ax=0$ for the vertex, and the inverse of the parabola $y^2=8ax$, the vertex being the centre of inversion, and the semi-latus rectum the constant of inversion. The area between the curve and its asymptote is $3\pi a^2$, i.e. three times the area of the generating circle.

The term cissoid has been given in modern times to curves generated in similar manner from other figures than the circle, and the form described above is distinguished as the cissoid of Diocles.

A *cissoid angle* is the angle included between the concave sides of two intersecting curves; the convex sides include the *sistroid angle*.

See John Wallis, *Collected Works*, vol. i.; T. H. Eagles, *Plane Curves* (1885).

CIS-SUTLEJ STATES, the southern portion of the Punjab, India. The name, now obsolete, came into use in 1809, when the Sikh chiefs south of the Sutlej passed under British protection, and was generally applied to the country south of the Sutlej and north of the Delhi territory, bounded on the E. by the Himalayas, and on the W. by Sirsa district. Before 1846 the greater part of this territory as independent, the chiefs being subject merely to control from a political officer stationed at Umballa, and styled the agent of the governor-general for the Cis-Sutlej states. After the first Sikh War the full administration of the territory became vested in this officer. In 1849 occurred the annexation of the Punjab, when the Cis-Sutlej states commissionership, comprising the districts of Umballa, Ferozepore, Ludhiana, Thanesar and Simla, was incorporated with the new province. The name continued to be applied to this division until 1862, when, owing to Ferozepore having been transferred to the Lahore, and a part of Thanesar to the Delhi division, it ceased to be appropriate. Since then, the tract remaining has been known as the Umballa division. Patiala, Jind and Nabha were appointed a separate political agency in 1901. Excluding Bahawalpur, for which there is no political agent, and Chamba, the other states are grouped under the commissioners of Jullunder and Delhi, and the superintendent of the Simla hill states.

CIST (Gr. *κίστη*, Lat. *cista*, a box; cf. Ger. *Kiste*, Welsh *kist-vacn*, stone-coffin, and also the other Eng. form "chest"), in Greek archaeology, a wicker-work receptacle used in the Eleusinian and other mysteries to carry the sacred vessels; also,

in the archaeology of prehistoric man, a coffin formed of flat stones placed edgewise with another flat stone for a cover. The word is also used for a sepulchral chamber cut in the rock (see COFFIN).

"Cistern," the common term for a water-tank, is a derivation of the same word (Lat. *cisterna*; cf. "cave" and "cavern").

CISTERCIANS, otherwise GREY or WHITE MONKS (from the colour of the habit, over which is worn a black scapular or apron). In 1098 St Robert, born of a noble family in Champagne, at first a Benedictine monk, and then abbot of certain hermits settled at Molesme near Châtillon, being dissatisfied with the manner of life and observance there, migrated with twenty of the monks to a swampy place called Citeaux in the diocese of Châlons, not far from Dijon. Count Odo of Burgundy here built them a monastery, and they began to live a life of strict observance according to the letter of St Benedict's rule. In the following year Robert was compelled by papal authority to return to Molesme, and Alberic succeeded him as abbot of Citeaux and held the office till his death in 1109, when the Englishman St Stephen Harding became abbot, until 1134. For some years the new institute seemed little likely to prosper; few novices came, and in the first years of Stephen's abbacy it seemed doomed to failure. In 1112, however, St Bernard and thirty others offered themselves to the monastery, and a rapid and wonderful development at once set in. The next three years witnessed the foundation of the four great "daughter-houses of Citeaux"—La Ferté, Pontigny, Clairvaux and Morimond. At Stephen's death there were over 30 Cistercian houses; at Bernard's (1154) over 280; and by the end of the century over 500; and the Cistercian influence in the Church more than kept pace with this material expansion, so that St Bernard saw one of his monks ascend the papal chair as Eugenius III.

The keynote of Cistercian life was a return to a literal observance of St Benedict's rule—how literal may be seen from the controversy between St Bernard and Peter the Venerable, abbot of Cluny (see Maitland, *Dark Ages*, § xxii.). The Cistercians rejected alike all mitigations and all developments, and tried to reproduce the life exactly as it had been in St Benedict's time, indeed in various points they went beyond it in austerity. The most striking feature in the reform was the return to manual labour, and especially to field-work, which became a special characteristic of Cistercian life. In order to make time for this work they cut away the accretions to the divine office which had been steadily growing during three centuries, and in Cluny and the other Black Monk monasteries had come to exceed greatly in length the regular canonical office: one only of these accretions did they retain, the daily recitation of the Office of the Dead (Edm. Bishop, *Origin of the Primer*, Early English Text Society, original series, 109, p. xxx.).

It was as agriculturists and horse and cattle breeders that, after the first blush of their success and before a century had passed, the Cistercians exercised their chief influence on the progress of civilization in the later middle ages: they were the great farmers of those days, and many of the improvements in the various farming operations were introduced and propagated by them; it is from this point of view that the importance of their extension in northern Europe is to be estimated. The Cistercians at the beginning renounced all sources of income arising from benefices, tithes, tolls and rents, and depended for their income wholly on the land. This developed an organized system for selling their farm produce, cattle and horses, and notably contributed to the commercial progress of the countries of western Europe. Thus by the middle of the 13th century the export of wool by the English Cistercians had become a feature in the commerce of the country. Farming operations on so extensive a scale could not be carried out by the monks alone; whose choir and religious duties took up a considerable portion of their time; and so from the beginning the system of lay brothers was introduced on a large scale. The lay brothers were recruited from the peasantry and were simple uneducated men, whose function consisted in carrying out the various field-works and plying all sorts of useful trades; they formed a body

of men who lived alongside of the choir monks, but separate from them, not taking part in the canonical office, but having their own fixed round of prayer and religious exercises. A lay brother was never ordained, and never held any office of superiority. It was by this system of lay brothers that the Cistercians were able to play their distinctive part in the progress of European civilization. But it often happened that the number of lay brothers became excessive and out of proportion to the resources of the monasteries, there being sometimes as many as 200, or even 300, in a single abbey. On the other hand, at any rate in some countries, the system of lay brothers in course of time worked itself out; thus in England by the close of the 14th century it had shrunk to relatively small proportions, and in the 15th century the régime of the English Cistercian houses tended to approximate more and more to that of the Black Monks.

The Cistercian polity calls for special mention. Its lines were adumbrated by Alberic, but it received its final form at a meeting of the abbots in the time of Stephen Harding, when was drawn up the *Carta Caritatis* (Migne, *Patrol. Lat.* clxvi. 1377), a document which arranged the relations between the various houses of the Cistercian order, and exercised a great influence also upon the future course of western monachism. From one point of view, it may be regarded as a compromise between the primitive Benedictine system, whereby each abbey was autonomous and isolated, and the complete centralization of Cluny, whereby the abbot of Cluny was the only true superior in the body. Cîteaux, on the one hand, maintained the independent organic life of the houses—each abbey had its own abbot, elected by its own monks; its own community, belonging to itself and not to the order in general; its own property and finances administered by itself, without interference from outside. On the other hand, all the abbeyes were subjected to the general chapter, which met yearly at Cîteaux, and consisted of the abbots only; the abbot of Cîteaux was the president of the chapter and of the order, and the visitor of each and every house, with a predominant influence and the power of enforcing everywhere exact conformity to Cîteaux in all details of the exterior life—observance, chant, customs. The principle was that Cîteaux should always be the model to which all the other houses had to conform. In case of any divergence of view at the chapter, the side taken by the abbot of Cîteaux was always to prevail (see F. A. Gasquet, *Sketch of Monastic Constitutional History*, pp. xxxv-xxxviii, prefixed to English trans. of Montalembert's *Monks of the West*, ed. 1895).

By the end of the 12th century the Cistercian houses numbered 500; in the 13th a hundred more were added; and in the 15th, when the order attained its greatest extension, there were close on 750 houses: the larger figures sometimes given are now recognized as apocryphal. Nearly half of the houses had been founded, directly or indirectly, from Clairvaux, so great was St Bernard's influence and prestige: indeed he has come almost to be regarded as the founder of the Cistercians, who have often been called Bernardines. The order was spread all over western Europe,—chiefly in France, but also in Germany, England, Scotland, Ireland, Sweden, Poland, Hungary, Italy and Sicily, Spain and Portugal,—where some of the houses, as Alcobaca, were of almost incredible magnificence. In England the first foundation was Furness (1127), and many of the most beautiful monastic buildings of the country, beautiful in themselves and beautiful in their sites, were Cistercian,—as Tintern, Rievaulx, Byland, Fountains. A hundred were established in England in the next hundred years, and then only one more up to the Dissolution (for list, see table and map in F. A. Gasquet's *English Monastic Life*, or *Catholic Dictionary*, art. "Cistercians").

For a hundred years, till the first quarter of the 13th century, the Cistercians supplanted Cluny as the most powerful order and the chief religious influence in western Europe. But then in turn their influence began to wane, chiefly, no doubt, because of the rise of the mendicant orders, who ministered more directly to the needs and ideas of the new age. But some of the reasons of Cistercian decline were internal. In the first place, there was

the permanent difficulty of maintaining in its first fervour a body embracing hundreds of monasteries and thousands of monks, spread all over Europe; and as the Cistercian very *raison d'être* consisted in its being a "reform," a return to primitive monachism, with its field-work and severe simplicity, any failures to live up to the ideal proposed worked more disastrously among Cistercians than among mere Benedictines, who were intended to live a life of self-denial, but not of great austerity. Relaxations were gradually introduced in regard to diet and to simplicity of life, and also in regard to the sources of income, rents and tolls being admitted and benefices incorporated, as was done among the Benedictines; the farming operations tended to produce a commercial spirit; wealth and splendour invaded many of the monasteries, and the choir monks abandoned field-work.

The later history of the Cistercians is largely one of attempted revivals and reforms. The general chapter for long battled bravely against the invasion of relaxations and abuses. In 1335 Benedict XII., himself a Cistercian, promulgated a series of regulations to restore the primitive spirit of the order, and in the 15th century various popes endeavoured to promote reforms. All these efforts at a reform of the great body of the order proved unavailing; but local reforms, producing various semi-independent offshoots and congregations, were successfully carried out in many parts in the course of the 15th and 16th centuries. In the 17th another great effort at a general reform was made, promoted by the pope and the king of France; the general chapter elected Richelieu (commendatory) abbot of Cîteaux, thinking he would protect them from the threatened reform. In this they were disappointed, for he threw himself wholly on the side of reform. So great, however, was the resistance, and so serious the disturbances that ensued, that the attempt to reform Cîteaux itself and the general body of the houses had again to be abandoned, and only local projects of reform could be carried out. In 1598 had arisen the reformed congregation of the Feuillants, which spread widely in France and Italy, in the latter country under the name of "Improved Bernardines." The French congregation of Sept-Fontaines (1654) also deserves mention. In 1663 de Rancé reformed La Trappe (see TRAPPISTS).

The Reformation, the ecclesiastical policy of Joseph II., the French Revolution, and the revolutions of the 19th century, almost wholly destroyed the Cistercians; but some survived, and since the beginning of the last half of the 19th century there has been a considerable recovery. They are at present divided into three bodies: (1) the Common Observance, with about 30 monasteries and 800 choir monks, the large majority being in Austria-Hungary; they represent the main body of the order and follow a mitigated rule of life; they do not carry on field-work, but have large secondary schools, and are in manner of life little different from fairly observant Benedictine Black monks; of late years, however, signs are not wanting of a tendency towards a return to older ideas; (2) the Middle Observance, embracing some dozen monasteries and about 150 choir monks; (3) the Strict Observance, or Trappists (*q.v.*), with nearly 60 monasteries, about 1600 choir monks and 2000 lay brothers.

In all there are about 100 Cistercian monasteries and about 4700 monks, including lay brothers. There have always been a large number of Cistercian nuns; the first nunnery was founded at Tart in the diocese of Langres, 1125; at the period of their widest extension there are said to have been 900 nunneries, and the communities were very large. The nuns were devoted to contemplation and also did field-work. In Spain and France certain Cistercian abbesses had extraordinary privileges. Numerous reforms took place among the nuns. The best known of all Cistercian convents was probably Port-Royal (*q.v.*), reformed by Angélique Arnaud, and associated with the story of the Jansenist controversy. After all the troubles of the 19th century there still exist 100 Cistercian nunneries with 3000 nuns, choir and lay; of these, 15 nunneries with 900 nuns are Trappist.

Accounts of the beginnings of the Cistercians and of the primitive life and spirit will be found in the lives of St Bernard, the best

whereof is that of Abbé E. Vacandard (1895); also in the Life of St Stephen Harding, in the *English Saints*. See also Henry Collins (one of the Oxford Movement, who became a Cistercian), *Spirit and Mission of the Cistercian Order* (1866). The facts are related in Helyot, *Hist. des ordres religieux* (1792), v. cc. 33-46, vi. cc. 1, 2. Useful sketches, with references to the literature, are supplied in Herzog, *Realencyklopädie* (ed. 3), art. "Cistercienser"; Wetzler und Welte, *Kirchenlexikon* (ed. 2), art. "Cistercienserorden"; Max Heimbucher, *Orden und Kongregationen* (1896), i. §§ 33, 34. Prof. Brewer's discriminating, yet on the whole sympathetic, Preface to vol. iv. of the Works of Giraldus Cambrensis (Rolls Series of *Chronicles and Memorials*) is very instructive. Denis Murphy's *Triumphalia Monasterii S. Crucis* (1891) contains a general sketch, with a particular account of the Irish Cistercians. (E. C. B.)

CITATION (Lat. *citare*, to cite), in law, a summons to appear, more particularly applied in England to process in the probate and divorce division of the high court. In the ecclesiastical courts, citation was a method of commencing a probate suit, answering to a writ of summons at common law, and it is now in English probate practice an instrument issuing from the principal probate registry, chiefly used when a person, having the superior right to take a grant, delays or declines to do so, and another having an inferior right desires to obtain a grant; the party having the prior right is cited to appear and either to renounce the grant or show cause why it should not be decreed to the citator. In divorce practice, when a petitioner has filed his petition and affidavit, he extracts a citation, *i.e.* a command drawn in the name of the sovereign and signed by one of the registrars of the court, calling upon the alleged offender to appear and make answer to the petition. In Scots law, citation is used in the sense of a writ of summons. The word in its more general literary sense means the act of quoting, or the referring to an authority in support of an argument.

CÎTEAUX, a village of eastern France, in the department of Côte d'Or, 16 m. S.S.E. of Dijon by road. It is celebrated for the great abbey founded by Robert, abbot of Molesme, in 1098, which became the headquarters of the Cistercian order. The buildings which remain date chiefly from the 18th century and are of little interest. The church, destroyed in 1792, used to contain the tombs of the earlier dukes of Burgundy.

CITHAERON, now called from its pine forests Elatea, a famous mountain range (4626 ft.) in the south of Boeotia, separating that state from Megaris and Attica. It was famous in Greek mythology, and is frequently mentioned by the great poets, especially by Sophocles. It was on Cithaeron that Actaeon was changed into a stag, that Pentheus was torn to pieces by the Bacchantes whose orgies he had been watching, and that the infant Oedipus was exposed. This mountain, too, was the scene of the mystic rites of Dionysus, and the festival of the Daedala in honour of Hera. The carriage-road from Athens to Thebes crosses the range by a picturesque defile (the pass of Dryoscephalae, "Oak-heads"), which was at one time guarded on the Attic side by a strong fortress, the ruins of which are known as Ghyphtho-kastro ("Gipsy Castle"). Plataea is situated on the north slope of the mountain, and the strategy of the battle of 479 B.C. was considerably affected by the fact that it was necessary for the Greeks to keep their communications open by the passes (see PLATAEA). The best known of these is that of Dryoscephalae, which must then, as now, have been the direct route from Athens to Thebes. Two other passes, farther to the west, were crossed by the roads from Plataea to Athens and to Megara respectively. (E. Gr.)

CITHARA (Assyrian *chelarah*; Gr. *κithára*; Lat. *cithara*; perhaps Heb. *kinura*, *kinnor*), one of the most ancient stringed instruments, traced back to 1700 B.C. among the Semitic races, in Egypt, Assyria, Asia Minor, Greece and the Roman empire, whence the use of it spread over Europe. The main feature of the Greek *kithara*, its shallow sound-chest, being the most important part of it, is also that in which developments are most noticeable; its contour varied considerably during the many musical ages, but the characteristic in respect of which it foreshadowed the precursors of the violin family, and by which they were distinguished from other contemporary stringed instruments

of the middle ages, was preserved throughout in all European descendants bearing derived names. This characteristic box sound-chest (fig. 1) consisted of two resonating tables, either flat or delicately arched, connected by ribs or sides of equal width. The cithara may be regarded as an attempt by a more skilful craftsman or race to improve upon the lyre (*q.v.*), while retaining some of its features. The construction of the cithara can fortunately be accurately studied from two actual specimens found in

Egypt and preserved in the museums of Berlin and Leiden. The Leiden cithara (fig. 2), which forms part of the d'Anastasy Collection in the Museum of Antiquities, is in a very good state of preservation. The sound-chest, in the form of an irregular square (17 cm. X 17 cm.), is hollowed out of a solid block of wood from the base, which is open; the little bar, seen through the open base and measuring 2½ cm. (1 in.), is also of the same piece of wood. The arms, one short and one long, are solid and are fixed to the body by means of wooden pins; they are glued as well for greater strength. W. Pleyte, through whose courtesy the sketch was revised and corrected, states that there are no indications on the instrument of any kind of bridge or attachment for strings except the little half-hoop of iron wire which passes through the base from back to front. To this the strings were probably attached, and the little bar performed the double duty of sound-post and support for strengthening the tail-piece and enabling it to resist the tension of the strings. The oblique transverse bar, rendered necessary by the increasing length of the strings, was characteristic of the Egyptian cithara,¹ whereas the Asiatic and Greek instruments were generally constructed with horizontal bars resting on arms of equal length, the pitch of the strings being varied by thickness and tension, instead of by length. (For the Berlin cithara see LYRE.)

The number of strings with which the cithara was strung varied from 4 to 19 or 20 at different times; they were added less for the purpose of increasing the compass in the modern sense than to enable the performer to play in the different modes of the Greek musical system. Terpander is credited with having increased the number of strings to seven; Euclid, quoting him as his authority, states that "loving no more Egyptian Cithara the tetrachordal chant, we will sing aloud from Thebes new hymns to a seven-toned phorminx." What has been said of the scale of the lyre applies also to the cithara, and need therefore not be repeated here. The strings were vibrated by means of the fingers or plectrum (*πλήκτρον*, from *πλήσσειν*, to strike; Lat. *plectrum*, from *plango*, I strike). Twanging with the fingers for strings of gut, hemp or silk was undoubtedly the more artistic method, since the player was able to command various shades of expression which are impossible

The number of strings with which the cithara was strung varied from 4 to 19 or 20 at different times; they were added less for the purpose of increasing the compass in the modern sense than to enable the performer to play in the different modes of the Greek musical system. Terpander is credited with having increased the number of strings to seven; Euclid, quoting him as his authority, states that "loving no more Egyptian Cithara the tetrachordal chant, we will sing aloud from Thebes new hymns to a seven-toned phorminx."

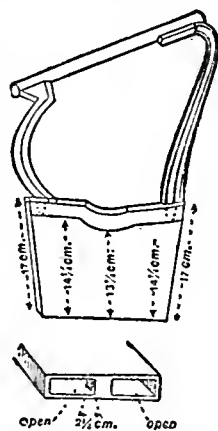

FIG. 2.—Ancient Egyptian Cithara from Thebes. Museum of Antiquities, Leiden.

What has been said of the scale of the lyre applies also to the cithara, and need therefore not be repeated here. The strings were vibrated by means of the fingers or plectrum (*πλήκτρον*, from *πλήσσειν*, to strike; Lat. *plectrum*, from *plango*, I strike). Twanging with the fingers for strings of gut, hemp or silk was undoubtedly the more artistic method, since the player was able to command various shades of expression which are impossible

¹ A drawing of an Egyptian cithara, similar to the Leiden specimen, may be seen in Champollion, *Monuments de l'Égypte et de la Nubie*, ii. pl. 175.



FIG. 1.—Nero Citharoedus (Mus. Pio-Clementino), showing back of a Roman Cithara.

with a rigid plectrum.¹ Loudness of accent and great brilliancy of tone, however, can only be obtained by the use of the plectrum.

Quotations from the classics abound to show what was the practice of the Greeks and Romans in this respect. The plectrum was held in the right hand, with elbow outstretched and palm bent inwards, and the strings were plucked with the straightened fingers of the left hand.² Both methods were used with intention according to the dictates of art for the sake of the variation in tone colour obtainable thereby.³

The strings of the cithara were either knotted round the transverse tuning bar itself (*zugon*) or to rings threaded over the bar, which enabled the performer to increase or decrease the tension by shifting the knots or rings; or else they were wound round pegs,⁴ knobs⁵ or pins⁶ fixed to the *zugon*. The other end of the strings was secured to a tail-piece after passing over a flat bridge, or the two were combined in the curious high box tail-piece which acted as a bridge. Plutarch⁷ states that this contrivance was added to the cithara in the days of Cepion, pupil of Terpander. These boxes were hinged in order to allow the lid to be opened for the purpose of securing the strings to some contrivance concealed therein. It is a curious fact that no sculptured cithara provided with this box tail-piece is represented with strings, and in many cases there could never have been any, for the hand and arm⁸ are visible across the space that would be filled by the strings, which are always carved in a solid block.



FIG. 3.—Apollo Citharoedus, showing Cithara with box tail-pieces.

Like the lyre the cithara was made in many sizes, conditioned by the pitch and the use to which the instrument was to be put. These instruments may have been distinguished by different names; the *pectis*, for instance, is declared by Sappho (22nd fragment) to have been small and shrill; the *phorminx*, on the other hand, seems to have been identical with the cithara.⁹

The Greek *kithara* was the instrument of the professional singer or citharoedus (*κιθαρωδός*) and of the instrumentalist or citharista (*κιθαριστής*), and thus served the double purpose of (1) accompanying the voice—a use placed by the Greeks far above mere instrumental music—in epic recitations and rhapsodies, in odes and lyric songs; and (2) of accompanying the dance; it was also used for playing solos at the national games, at receptions and banquets and at trials of skill. The costume of the citharoedus and citharista was rich and recognized as being distinctive; it varied but little throughout the ages, as may be deduced from a comparison of representations of the citharoedus on a coin and on a Greek vase of the best period (fig. 4). The costume consisted of a *palla* or long tunic with sleeves embroidered with gold and girt high above the waist, falling in graceful folds to the feet. This *palla* must not be confounded with the

¹ See Plutarch, *Apophthegm. Lacon.*

² Philostratus the Elder, *Imagines*, No. 10, "Amphion," and Philostratus the Younger, *Imagines*, No. 7, "Orpheus," p. 403.

³ Tibullus, *Eleg.* iii. 4. 39.

⁴ *Le Antichità de Ercolano*, vol. iii. p. 5.

⁵ *Idem*, vol. iv. p. 201.

⁶ Thomas Hope, *Costumes of the Ancients*, vol. ii. p. 193; also Edward Buhle, *Die musikalischen Instrumente in den Miniaturen des frühen Mittelalters* (Leipzig, 1903), frontispiece.

⁷ See *De Musica*, ch. vi.

⁸ See Visconti, *Museo Clementino*, pl. 22, Erato's cithara, and in the same work that of Apollo Citharoedus (fig. 3 above).

⁹ See *Od.* i. 153, 155; *Il.* xviii. 569-570. In Homer the form is always *κιθάρις*.

mantle of the same name worn by women. Over one shoulder, or hanging down the back, was the purple *chlamys* or cloak, and on his brow a golden wreath of laurels. All the citharoedi bear instruments of the type here described as the cithara, and never one of the lyre type. The records of the citharoedi extend over more than thirteen centuries and fall into two natural divisions: (1) The mythological period, approximately from the 13th century B.C. to the first Olympiad, 776 B.C.; and (2) the historical period to the days of Ptolemy, A.D. 161. One of the very few authentic Greek odes extant is a Pythian ode by Pindar, in which the phorminx of Apollo is mentioned; the solo is followed by a chorus of citharoedi. The scope of the solemn games and processions, called *Panathenaea*, held every four years in honour of the goddess Athena, which originally consisted principally of athletic sports and horse and chariot races, was extended under Peisistratus (c. 540 B.C.), and the celebration made to include contests of singers and instrumentalists, recitations of portions of the *Iliad* and *Odyssey*, such as are represented on the frieze of the Parthenon (in the Elgin Room at the British Museum) and later on friezes by Pheidias. It was at the same period that the first contests for solo-playing on the cithara (*κιθαριστής*) and for solo *aulos*-playing were instituted at the 8th Pythian Games.¹⁰ One of the principal items at these contests for *aulos* and cithara was the *Nomos Pythikos*, descriptive of the victory of Apollo over the python and of the defeat of the monster.¹¹

The Pythian Games survived the classic Greek period and were continued under Roman sway until about A.D. 394. Not only were these games held at Delphi, but smaller contests, called Pythia, modelled on the great Pythian, were instituted in various provinces of the empire, and more especially in Asia Minor.

The games lasted for several days, the first being devoted to music. To the games at Delphi came musicians from all parts of the civilized world; and the Spaniards, at the beginning of our era, had attained to such a marvellous proficiency in playing the cithara, an instrument which they had learnt to know from the Phoenician colonists before the conquest by the Romans, that some of their citharoedi easily carried off the honours at the musical contests. The consul Metellus was so charmed with the music of the Spanish competitors that he sent some to Rome for the festivals, where the impression created was so great that the Spanish citharoedi obtained a permanent footing in Rome. Aulus Gellius (*Noct. Att.*) describes an incident at a banquet which corroborates this statement.

The degeneration of music as an art among the Romans, and its gradual degradation by association with the sensual amusements of corrupt Rome, nearly brought about its extinction at the end of the 4th century, when the condemnation of the Church closed the theatres, and the great national games came to an end. Instrumental music was banished from civil life and from religious rites, and thenceforth the slender threads which connect the musical instruments of Greeks and Romans with those of



FIG. 4.—Cithara or Phorminx, from a vase in the British Museum.

¹⁰ See Pausanias x. 7, § 4 et seq.

¹¹ For a description of the *Nomos Pythikos* in its relation to Greek music see Kathleen Schlesinger, "Researches into the Origin of the Organs of the Ancients," *Intern. Mus. Ges. Sbd.* ii. (1901), 2, p. 177, and Strabo ix. p. 421.

the middle ages must be sought among the unconverted barbarians of northern and western Europe, who kept alive the traditions taught them by conquerors and colonists; but as civilization was in its infancy with them the instruments sent out from their workshops must have been crude and primitive. Asia, the cradle of the cithara, also became its foster-mother; it was among the Greeks of Asia Minor that the several steps in the transition from cithara into guitar¹ (*q.v.*) took place.

The first of these steps produced the *rotta* (*q.v.*), by the construction of body, arms and transverse bar in one piece. The Semitic races used the *rotta* at a very remote period (1700 B.C.), as we know from a fresco at Beni-Hasan, dating from the reign of Senwosri II., which depicts a procession of strangers bringing tribute; among them is a bearded musician of Semitic type bearing a *rotta* which he holds horizontally in front of him in the Assyrian manner, and quite unlike the Greeks, who always played the lyre and cithara in an upright position. A unique specimen of this rectangular *rotta* was found in an Alamannic tomb of the 5th or 6th century at Obersflacht in the Black Forest. The instrument was clasped in the arms of an armed knight; it is now preserved in the Völker Museum in Berlin. This old German *rotta* is an exact counterpart of instruments pictured in illuminated MSS. of the 8th century, and is derived from the

cithara with rectangular body, while from the cithara with a body having the curve of the lower half of the violin was produced a *rotta* with the outline of the guitar. Both types were common in Europe until the 14th century, some played with a bow, others twanged by the fingers, and bearing indifferently both names, cithara and *rotta*. The addition of a finger-

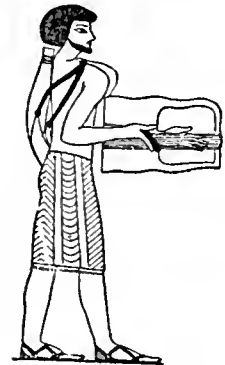

FIG. 5.—Asiatic Cithara in transition (or *rotta*). From a fresco at Beni-Hasan (c. 1700 B.C.).

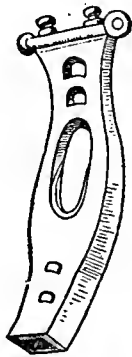

FIG. 6.—Roman Cithara in transition, of the Lycian Apollo (Rome Mus. Capit.).

board, stretching like a short neck from body to transverse bar, leaving on each side of the finger-board space for the hand to pass through in order to stop the strings, produced the *crwth* or *crowd* (*q.v.*), and brought about the reduction in the number of the strings to three or four. The conversion of the *rotta* into the guitar (*q.v.*) was an easy transition effected by the addition of a long neck to a body derived from the oval *rotta*. When the bow was applied the result was the guitar or troubadour fiddle. At first the instrument called *cithara* in the Latin versions of the Psalms was glossed *citrān*, *citre* in Anglo-Saxon, but in the 11th century the same instrument was rendered *hearpan*, and in French and English *harpe* or *harp*, and our modern versions have retained this translation. The *cittern* (*q.v.*), a later descendant of the cithara, although preserving the characteristic features of the cithara, the shallow sound-chest with ribs, adopted the pear-shaped outline of the Eastern instruments of the lute tribe. (K. S.)

CITIUM (Gr. *Kition*), the principal Phoenician city in Cyprus, situated at the north end of modern Larnaca, on the bay of the same name on the S.E. coast of the island. Converging currents from E. and W. meet and pass seawards off Cape Kiti a few miles south, and greatly facilitated ancient trade. To S. and W. the site is protected by lagoons, the salt from which was one of the sources of its prosperity. The earliest remains near the site go

back to the Mycenaean age (c. 1400–1100 B.C.) and seem to mark an Aegean colony;² but in historic times Citium is the chief centre of Phoenician influence in Cyprus. That this was still a recent settlement in the 7th century is suggested by an allusion in a list of the allies of Assur-bani-pal of Assyria in 668 B.C. to a King Damasu of Kartihadasti (Phoenician for “New-town”), where Citium would be expected. A Phoenician dedication to “Baal of Lebanon” found here, and dated also to the 7th century, suggests that Citium may have belonged to Tyre. The biblical name Kittim, derived from Citium, is in fact used quite generally for Cyprus as a whole;³ later also for Greeks and Romans in general.⁴ The discovery here of an official monument of Sargon II. suggests that Citium was the administrative centre of Cyprus during the Assyrian protectorate (709–668 B.C.).⁵ During the Greek revolts of 500, 386 foll. and 352 B.C., Citium led the side loyal to Persia and was besieged by an Athenian force in 449 B.C.; its extensive necropolis proves that it remained a considerable city even after the Greek cause triumphed with Alexander. But like other cities of Cyprus, it suffered repeatedly from earthquake, and in medieval times when its harbour became silted the population moved to Larnaca, on the open roadstead, farther south. Harbour and citadel have now quite disappeared, the latter having been used to fill up the former shortly after the British occupation; some gain to health resulted, but an irreparable loss to science. Traces remain of the circuit wall, and of a sanctuary with copious terra-cotta offerings; the large necropolis yields constant loot to illicit excavation.

BIBLIOGRAPHY.—W. H. Engel, *Kypros* (Berlin, 1841), (classical allusions); J. L. Myres, *Journ. Hellenic Studies*, xvii. 147 ff. (excavations); *Cyprus Museum Catalogue* (Oxford, 1899), p. 5-6; 153-155; Index (Antiquities); G. F. Hill, *Brit. Mus. Cal. Coins of Cyprus* (London, 1904), (Coins). (J. L. M.)

CITIZEN (a form corrupted in Eng., apparently by analogy with “denizen,” from O. Fr. *citeain*, mod. Fr. *citoyen*), etymologically the inhabitant of a city, *citē* or *civitas* (see **CITY**), and in England the term still used primarily of persons possessing civic rights in a borough; thus used also of a townsman as opposed to a countryman. The more extended use of the word, however, corresponding to *civitas*, gives “citizen” the meaning of one who is a constituent member of a state in international relations and as such has full national rights and owes a certain allegiance (*q.v.*) as opposed to an “alien”; in republican countries the term is then commonly employed as the equivalent of “subject” in monarchies of feudal origin. For the rules governing the obtaining of citizenship in this latter sense in the United States and elsewhere see **NATURALIZATION**.

CITOLE, also spelled **SYTOLE**, **CYTHOLE**, **GYTOLLE**, &c. (probably a Fr. diminutive form of *cithara*, and not from Lat. *cista*, a box), an obsolete musical instrument of which the exact form is uncertain. It is frequently mentioned by poetical writers of the 13th to the 15th centuries, and is found in Wycliffe’s Bible (1360) in 2 Samuel vi. 5, “Harpis and sitols and tympane.” The Authorized Version has “psalteries,” and the Vulgate “lyrac.” It has been supposed to be another name for the psalterly (*q.v.*), a box-shaped instrument often seen in the illuminated missals of the middle ages.

CITRIC ACID, *Acidum citricum*, or **OXYTRICARBALLYLIC ACID**, $C_6H_8(OH)(CO-OH)_3$, a tetrahydroxytribasic acid, first obtained in the solid state by Karl Wilhelm Scheele, in 1784, from the juice of lemons. It is present also in oranges, citrons, currants, gooseberries and many other fruits, and in several bulbs and tubers. It is made on a large scale from lime or lemon juice, and also by the fermentation of glucose under the influence of *Citromyces pfefferianus*, *C. glaber* and other ferments. Lemon juice is fermented for some time to free it from mucilage, then boiled

² Cf. the name Kathian in a Ramessid list of cities of Cyprus, Oberhammer, *Die Insel Cypern* (Munich, 1903), p. 4.

³ Gen. x. 4; Num. xxiv. 24; Is. xxiii. 1, 12; Jer. ii. 10; Ezek. xxvii. 6.

⁴ Dan. xi. 30; 1 Macc. i. 1; viii. 5.

⁵ Schrader, “Die Sargonstele des Berliner Museums,” in *Abh. d. k. Preuss. Akad. Wiss.* (1881); *Zur Geogr. d. assyr. Reiches* (Berlin, 1890), pp. 337-344.

¹ For a discussion of this question see Kathleen Schlesinger, *The Instruments of the Orchestra*, part ii., and especially chapters on the cithara in transition during the middle ages, and the question of the origin of the Utrecht Psalter, in which the evolution of the cithara is traced at some length.

and filtered, and neutralized with powdered chalk and a little milk of lime; the precipitate of calcium citrate so obtained is decomposed with dilute sulphuric acid, the solution filtered, evaporated to remove calcium sulphate and concentrated, preferably in vacuum pans. The acid is thus obtained in colourless rhombic prisms of the composition $C_6H_8O_7 + H_2O$. Crystals of a different form are deposited from a strong boiling solution of the acid. About 20 gallons of lemon juice should yield about 10 lb of crystallized citric acid. The acid may also be prepared from the juice of unripe gooseberries. Calcium citrate must be manufactured with care to avoid an excess of chalk or lime, which would precipitate constituents of the juice that cause the fermentation of the citrate and the production of calcium acetate and butyrate.

The synthesis of citric acid was accomplished by L. E. Grimaux and P. Adam in 1881. Glycerin when treated with hydrochloric acid gives propenyl dichlorhydrin, which may be oxidized to *s*-dichloracetone. This compound combines with hydrocyanic acid to form a nitrile which hydrolyses to dichlorhydroxy iso-butyric acid. Potassium cyanide reacts with this acid to form the corresponding dinitrile, which is converted by hydrochloric acid into citric acid. This series of operations proves the constitution of the acid. A. Haller and C. A. Held synthesized the acid from ethyl chlor-acetoacetate (from chlorine and acetoacetic ester) by heating with potassium cyanide and saponifying the resulting nitrile. The acetone dicarboxylic acid, $CO(CH_2CO_2H)_2$, so obtained combines with hydrocyanic acid, and this product yields citric acid on hydrolysis.

Citric acid has an agreeable sour taste. It is soluble in $\frac{2}{3}$ ths of its weight of cold, and in half its weight of boiling water, and dissolves in alcohol, but not in ether. At $150^\circ C$. it melts, and on the continued application of heat boils, giving off its water of crystallization. At $175^\circ C$. it is resolved into water and aconitic acid, $C_6H_6O_6$, a substance found in *Equisetum fluviatile*, monkshood and other plants. A higher temperature decomposes this body into carbon dioxide and itaconic acid, $C_5H_4O_4$, which, again, by the expulsion of a molecule of water, yields citraconic anhydride, $C_5H_4O_3$. Citric acid digested at a temperature below $40^\circ C$. with concentrated sulphuric acid gives off carbon monoxide and forms acetone dicarboxylic acid. With fused potash it forms potassium oxalate and acetate. It is a strong acid, and dissolved in water decomposes carbonates and attacks iron and zinc.

The citrates are a numerous class of salts, the most soluble of which are those of the alkaline metals; the citrates of the alkaline earth metals are insoluble. Citric acid, being tribasic, forms either acid monometallic, acid dimetallic or neutral trimetallic salts; thus, mono-, di- and tri-potassium and sodium citrates are known. On warming citric acid with an excess of lime-water a precipitate of calcium citrate is obtained which is redissolved as the liquid cools.

The impurities occasionally present in commercial citric acid are salts of potassium and sodium, traces of iron, lead and copper derived from the vessels used for its evaporation and crystallization, and free sulphuric, tartaric and even oxalic acid. Tartaric acid, which is sometimes present in large quantities as an adulterant in commercial citric acid, may be detected in the presence of the latter, by the production of a precipitate of acid potassium tartrate when potassium acetate is added to a cold solution. Another mode of separating the two acids is to convert them into calcium salts, which are then treated with a perfectly neutral solution of cupric chloride, soluble cupric citrate and calcium chloride being formed, while cupric tartrate remains undissolved. Citric acid is also distinguished from tartaric acid by the fact that an ammonia solution of silver tartrate produces a brilliant silver mirror when boiled, whereas silver citrate is reduced only after prolonged ebullition.

Citric acid is used in calico printing, also in the preparation of effervescing draughts, as a refrigerant and sialogogue, and occasionally as an antiscorbutic, instead of fresh lemon juice. In the form of lime juice it has long been known as an antidote for scurvy. Several of the citrates are much employed as medicines,

the most important being the scale preparations of iron. Of these iron and ammonium citrate is much used as a hæmatinic, and as it has hardly any tendency to cause gastric irritation or constipation it can be taken when the ordinary forms of iron are inadmissible. Iron and quinine citrate is used as a bitter stomachic and tonic. In the blood citrates are oxidized into carbonates; they therefore act as *remote alkalis*, increasing the alkalinity of the blood and thereby the general rate of chemical change within the body (see ACETIC ACID).

CITRON, a species of *Citrus* (*C. medica*), belonging to the tribe *Aurantieae*, of the botanical natural order Rutaceae; the same genus furnishes also the orange, lime and shaddock. The citron is a small evergreen tree or shrub growing to a height of about 10 ft.; it has irregular straggling spiny branches, large pale-green broadly oblong, slightly serrate leaves and generally unisexual flowers purplish without and white within. The large fruit is ovate or oblong, protuberant at the tip, and from 5 to 6 in. long, with a rough, furrowed, adherent rind, the inner portion of which is thick, white and fleshy, the outer, thin, greenish-yellow and very fragrant. The pulp is sub-acid and edible, and the seeds are bitter. There are many varieties of the fruit, some of them of great weight and size. The Madras citron has the form of an oblate sphere; and in the "fingered citron" of China the lobes are separated into finger-like divisions formed by separation of the constituent carpels, as occurs sometimes in the orange.

The citron-tree thrives in the open air in China, Persia, the West Indies, Madeira, Sicily, Corsica, and the warmer parts of Spain and Italy; and in conservatories it is often to be seen in more northerly regions. Sir Joseph Hooker (*Flora of British India*, i. 514) regards it as a native of the valleys at the foot of the Himalaya, and of the Khasia hills and the Western Ghauts; Dr Bonavia, however, considers it to have originated in Cochin China or China, and to have been introduced into India, whence it spread to Media and Persia. It was described by Theophrastus as growing in Media, three centuries before Christ, and was early known to the ancients, and the fruit was held in great esteem by them; but they seem to have been acquainted with no other member of the *Aurantieae*, the introduction of oranges and lemons into the countries of the Mediterranean being due to the Arabs, between the 10th and 15th centuries. Josephus tells us that "the law of the Jews required that at the feast of tabernacles every one should have branches of palm-tree and citron-tree" (*Antiq.* xiii. 13. 5); and the Hebrew word *tappuach*, rendered "apples" and "apple-tree" in Cant. ii. 3, 5, Prov. xxv. 11, &c., probably signifies the citron-tree and its fruit. Oribasius in the 4th century describes the fruit, accurately distinguishing the three parts of it. About the 3rd century the tree was introduced into Italy; and, as Gallesio informs us, it was much grown at Salerno in the 11th century. In China citrons are placed in apartments to make them fragrant. The rind of the citron yields two perfumes, *oil of cedra* and *oil of citron*, isomeric with oil of turpentine; and when candied it is much esteemed as a dessert and in confectionery. The lemon (*q.v.*) is now generally regarded as a subspecies *Limonum* of *Citrus medica*.

Oribasii Sardiiani, *Collectorum Medicinalium Libri XVII.* i. 64 (*De citrio*); Gallesio, *Traité du citrus* (1811); Darwin, *Animals and Plants under Domestication*, i. 334-336 (1868); Brandis, *Forest Flora of North-West and Central India*, p. 51 (1874); E. Bonavia, *The Cultivated Oranges and Lemons, &c., of India and Ceylon* (1890).

CITTADELLA, a town of Venetia, Italy, in the province of Padua, 20 m. N.W. by rail from the town of Padua; 160 ft. above sea-level. Pop. (1901) town, 3616; commune, 9686. The town was founded in 1220 by the Paduans to counterbalance the fortification of Castellfranco, 8 m. to the E., in 1218 by the Trevisans, and retains its well-preserved medieval walls, surrounded by a wet ditch. It was always a fortress of importance, and in modern times is a centre for the agricultural produce of the district, being the junction of the lines from Padua to Bassano and from Vicenza to Treviso.

CITTA DELLA PIEVE, a town and episcopal see of Umbria, Italy, in the province of Perugia, situated 1666 ft. above the sea,

3 m. N.E. of its station on the railway between Chiusi and Orvieto. Pop. (1901) 8381. Etruscan tombs have been found in the neighbourhood, but it is not certain that the present town stands on an ancient site. It was the birthplace of the painter Pietro Vannucci (Perugino), and possesses several of his works, but none of the first rank.

CITTÀ DI CASTELLO, a town and episcopal see of Umbria, Italy, in the province of Perugia, 38 m. E. of Arezzo by rail (18 m. direct), situated on the left bank of the Tiber, 945 ft. above sea-level. Pop. (1901) of town, 6096; of commune, 26,885. It occupies, as inscriptions show, the site of the ancient *Tifernum Tiberinum*, near which Pliny had a villa (*Epist.* v. 6; cf. H. Winnefeld in *Jahrbuch des deutschen archäologischen Instituts*, vi. Berlin, 1891, 203), but no remains exist above ground. The town was devastated by Totila, but seems to have recovered. We find it under the name of *Castrum Felicitatis* at the end of the 8th century. The bishopric dates from the 7th century. The town went through various political vicissitudes in the middle ages, being subject now to the emperor, now to the Church, until in 1468 it came under the Vitelli; but when they died out it returned to the allegiance of the Church. It is built in the form of a rectangle and surrounded by walls of 1518. It contains fine buildings of the Renaissance, especially the palaces of the Vitelli, and the cathedral, originally Romanesque. The 12th-century altar front of the latter in silver is fine. The Palazzo Comunale is of the 14th century. Some of Raphael's earliest works were painted for churches in this town, but none of them remains there. There is, however, a small collection of pictures.

See Magherini Graziani, *L'Arte a Città di Castello* (1897).

CITTÀ VECCHIA, or **CITTÀ NOTABILE**, a fortified city of Malta, 7 m. W. of Valletta, with which it is connected by railway. Pop. (1901) 7515. It lies on high, sharply rising ground which affords a view of a large part of the island. It is the seat of a bishop, and contains an ornate cathedral, overthrown by an earthquake in 1693, but rebuilt, which is said by an acceptable tradition to occupy the site of the house of the governor Publius, who welcomed the apostle Paul. It contains some rich stalls of the 15th century and other objects of interest. In the rock beneath the city there are some remarkable catacombs in part of pre-Christian origin, but containing evidence of early Christian burial; and a grotto, reputed to have given shelter to the apostle, is pointed out below the church of San Paolo. Remains of Roman buildings have been excavated in the town. About 2 m. E. of the town is the residence of the English governor, known as the palace of S. Antonio; and at a like distance to the south is the ancient palace of the grand masters of the order of St John, with an extensive public garden called Il Boschetto. Città Vecchia was called Civitas Melita by the Romans and oldest writers, Medina (*i.e.* the city) by the Saracens, Notabile (*locale notabile, et insigne coronae regiae*, as it is called in a charter by Alphonso, 1428) under the Sicilian rule, and Città Vecchia (old city) by the knights. It was the capital of the island till its supersession by Valletta in 1570. (See also MALTA.)

CITTERN (also CITHERN, CITHRON, CYTHREN, CITHAREN, &c.; Fr. *citre, cistre, cithre, guitare allemande* or *anglaise*; Ger. *Cithar, Zither* (mit Hals, with neck); Ital. *cetera, cetra*), a medieval stringed instrument with a neck terminating in a grotesque and twanged by fingers or plectrum. The popularity of the cittern was at its height in England and Germany during the 16th and

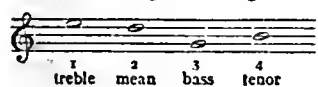

17th centuries. The cittern consisted of a pear-shaped body similar to that of the lute but with a flat back and sound-board

joined by ribs. The neck was provided with a fretted finger-board; the head was curved and surmounted by a grotesque head of a woman or of an animal.¹ The strings were of wire in

¹ See Shakespeare, *Love's Labour's Lost*, act v. sc. 2, where Boyet compares the countenance of Holofernes to a cittern head; John Forde, *Lovers' Melancholy* (1629), act ii. sc. 1, "Barbers shall wear thee on their citterns."

pairs of unisons, known as courses, usually four in number in England. A peculiarity of the cittern lay in the tuning of the courses, the third course known as bass being lower than the fourth styled tenor.

According to Vincentio Galilei (the father of the great astronomer) England was the birthplace of the cittern.² Several lesson books for this popular instrument were published during the 17th century in England. A very rare book (of which the British Museum does not possess a copy), *The Citharn Schoole*, written by Anthony Holborne in 1597, is mentioned in Sir P. Leicester's manuscript commonplace book³ dated 1656, "For the little Instrument called a *Psittyrne* Anthony Holborne and Tho. Robinson were most famous of any before them and have both of them set out a booke of Lessons for this Instrument. Holborne has composed a Basse-partie for the Viole to play unto the *Psittyrne* with those Lessons set out in his booke. These lived about Anno Domini 1600." Thomas Robinson's *New Citharen Lessons with perfect tunings for the same from Four course of strings to Fourtcene course*, &c. (printed London, 1609, by William Barley), contains illustrations of both kinds of instruments. The fourteen-course cittern was also known in England as *Bijuga*; the seven courses in pairs were stretched over the

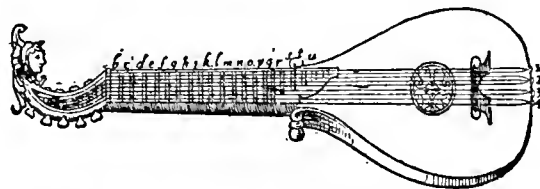

From Thomas Robinson's *New Citharen Lessons*, 1609.
Four-course Cittern.

finger-board, and the seven single strings, fastened to the grotesque head, were stretched as in the lyre *à vide* alongside the neck; all the strings rested on the one flat bridge near the tail-piece. Robinson gives instructions for learning to play the cittern and for reading the tablature. John Playford's *Musick's Delight on the Cithren* (London, 1666) also contains illustrations of the instrument as well as of the viol da Gamba and Pochette; he claims to have revived the instrument and restored it to what it was in the reign of Queen Mary.

The cittern probably owed its popularity at this time to the ease with which it might be mastered and used to accompany the voice; it was one of four instruments generally found in barbers' shops, the others being the gittern, the lute and the virginals. The customers while waiting took down the instrument from its peg and played a merry tune to pass the time.⁴ We read that when Konstantijn Huygens came over to England and was received by James I. at Bagshot, he played to the king on the cittern (cithara), and that his performance was duly appreciated and applauded. He tells us that, although he learnt to play the barbiton in a few weeks with skill, he had lessons from a master for two years on the cittern.⁵ On the occasion of a third visit he witnessed the performance of some fine musicians and was astonished to hear a lady, mother of twelve, singing in divine fashion, accompanying herself on the cittern; one of these artists he calls Lanivius, the British Orpheus, whose performance was really enchanting.

Michael Praetorius⁶ gives various tunings for the cittern as

² *Dialogo della musica* (Florence, 1581), p. 147.

³ The musical extracts from the commonplace book were prepared by Dr Rimbault for the Early English Text Society. Holborne's work is mentioned in his *Bibliotheca Madrigaliana*. The descriptive list of the musical instruments in use in England during Leicester's lifetime (about 1656) has been extracted and published by Dr F. J. Furnivall, in *Captain Cox, his Ballads and Books, or Robert Laneham's Letter* (1575), (London, 1871), pp. 65-68.

⁴ See Knight's *London*, i. 142.

⁵ See *De Vita propria sermonum inter liberos libri duo* (Haarlem, 1817) and E. van der Straeten, *La Musique aux Pays-Bas*, ii. 348-350.

⁶ *Syntagma Musicum* (1618). See also M. Mersenne, *Harmonie universelle* (Paris, 1636), livre ii. prop. xv., who gives different accordances.

well as an illustration (sounded an octave higher than the notation).

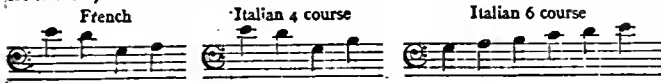

During the 18th century the cittern, citra or English guitar, had twelve wire strings in six pairs of unisons tuned thus:

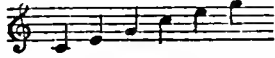

The introduction of the Spanish guitar, which at once leapt into favour, gradually displaced the English variety. The Spanish guitar had gut strings twanged by the fingers. The last development of the cittern before its disappearance was the addition of keys. The keyed cithara¹ was first made by Claus & Co. of London in 1783. The keys, six in number, were placed on the left of the sound-board, and on being depressed they acted on hammers inside the sound-chest, which rising through the rose sound-hole struck the strings. Sometimes the keys were placed in a little box right over the strings, the hammers striking from above. M. J. B. Vuillaume of Paris possessed an Italian cetera (not keyed) by Antoine Stradivarius,² 1700 (now in the Museum of the Conservatoire, Paris), with twelve strings tuned in pairs of unisons to E, D, G, B, C, A, which was exhibited in London in 1871.

The cittern of the 16th century was the result of certain transitions which took place during the evolution of the violin from the Greek kithara (see CITHARA).

Genealogical Table of the Cittern.

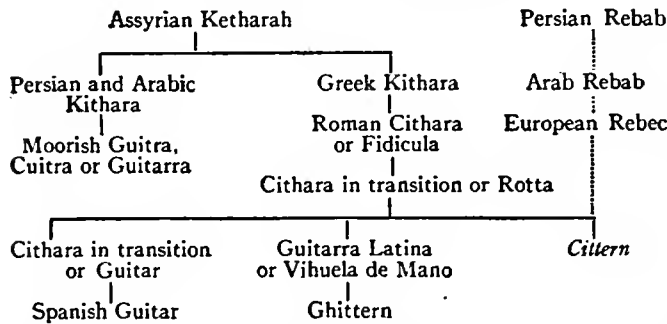

The cittern has retained the following characteristics of the archetype. (1) The derivation of the name, which after the introduction of the bow was used to characterize various instruments whose strings were twanged by fingers or plectrum, such as the harp and the rotta (both known as *cithara*), the citola and the zither. In an interlinear Latin and Anglo-Saxon version of the Psalms, dated A.D. 700 (Brit. Mus., Vesp. A. 1), *cithara* is translated *citran*, from which it is not difficult to trace the English *cithron*, *citteran*, *cittarn*, of the 16th century. (2) The construction of the sound-chest with flat back and sound-board connected by ribs. The pear-shaped outline was possibly borrowed from the Eastern instruments, both bowed as the rebab and twanged as the lute, so common all over Europe during the middle ages, or more probably derived from the *kithara* of the Greeks of Asia Minor, which had the corners rounded. These early steps in the transition from the *cithara* may be seen in the miniatures of the Utrecht Psalter,³ a unique and much-copied Carolingian MS. executed at Reims (9th century), the illustrations of which were undoubtedly adapted from an earlier psalter from the Christian East. The instruments which remained true to the prototype in outline as well as in

construction and in the derivation of the name were the glittern and the guitar, so often confused with the cittern. It is evident that the kinship of cittern and guitar was formerly recognized, for during the 18th century, as stated above, the cittern was known as the English guitar to distinguish it from the Spanish guitar. The grotesque head, popularly considered the characteristic feature of the cittern, was probably added in the 12th century at a time when this style of decoration was very noticeable in other musical instruments, such as the cornet or *Zinck*, the *Platerspiel*, the chaunter of the bagpipe, &c. The cittern of the middle ages was also to be found in oval shape. From the 13th century representations of the pear-shaped instrument abound in miniatures and carvings.⁴

A very clearly drawn cittern of the 14th century occurs in a MS. treatise on astronomy (Sloane MS. 3983, Brit. Mus.) translated from the Persian of Albumazar into Latin by Georgius Zothari Zopari Fenduli, priest and philosopher, with a prologue and numerous illustrations by his own hand; the cittern is here called *giga* in an inscription at the side of the drawing.

References to the cittern are plentiful in the literature of the 16th and 17th centuries. Robert Fludd⁵ describes it thus: "Cistrona quae quatuor tantum chordas duplicatas habet easque cupreas et ferreas de quibus aliquid dicemus quo loco." Others are given in the *New English Dictionary*, "Cittern," and in Godefroy's *Dict. de l'anc. langue franç. du IX^e au XV^e siècle.* (K. S.)

CITY (through Fr. *ciît*, from Lat. *civitas*). In the United Kingdom, strictly speaking, "city" is an honorary title, officially applied to those towns which, in virtue of some pre-eminence (e.g. as episcopal sees, or great industrial centres), have by traditional usage or royal charter acquired the right to the designation. In the United Kingdom the official style of "city" does not necessarily involve the possession of municipal power greater than those of the ordinary boroughs, nor indeed the possession of a corporation at all (e.g. Ely). In the United States and the British colonies, on the other hand, the official application of the term "city" depends on the kind and extent of the municipal privileges possessed by the corporations, and charters are given raising towns to the rank of cities. Both in France and England the word is used to distinguish the older and central nucleus of some of the large towns, e.g. the *Ciît* in Paris, and the "square mile" under the jurisdiction of the lord mayor which is the "City of London."

In common usage, however, the word implies no more than a somewhat vague idea of size and dignity, and is loosely applied to any large centre of population. Thus while, technically, the City of London is quite small, London is yet properly described as the largest city in the world. In the United States this use of the word is still more loose, and any town, whether technically a city or not, is usually so designated, with little regard to its actual size or importance.

It is clear from the above that the word "city" is incapable of any very clear and inclusive definition, and the attempt to show that historically it possesses a meaning that clearly differentiates it from "town" or "borough" has led to some controversy. As the translation of the Greek *pólis* or Latin *civitas* it involves the ancient conception of the state or "city-state," i.e. of the state as not too large to prevent its government through the body of the citizens assembled in the *agora*, and is applied not to the place but to the whole body politic. From this conception both the word and its dignified connotation are without doubt historically derived. On the occupation of Gaul the Gallic states and tribes were called *civitates* by the Romans,

⁴ An oval cittern and a ghittern, side by side, occur in the beautiful 13th-century Spanish MS. known as *Cantigas de Santa Maria* in the Escorial. For a fine facsimile in colours see marquis de Valmar, *Real. Acad. Esq.*, publ. by L. Aguado (Madrid, 1889). Reproductions in black and white in Juan F. Riaño, *Critical and Bibliog. Notes on Early Spanish Music* (London, 1887). See also K. Schlesinger, *op. cit.* fig. 167, p. 223, also boat-shaped citterns, figs. 155 and 156, p. 197. Cittern with woman's head, 15th century, on one of six bas-reliefs on the under parts of the seats of the choir of the Priory church, Great Malvern, reproduced in J. Carter's *Ancient Sculptures*, &c., vol. ii. pl. following p. 12. Another without a head, *ibid.* pl. following p. 16, from a brass monumental plate in St Margaret's, King's Lynn.

⁵ *Historia utriusque Cosmi* (Oppenheim, ed. 1617) i. 226.

¹ See Carl Engel, *Catalogue of the Exhibition of Ancient Musical Instruments* (London, 1872), Nos. 289 and 290.

² See note above. Illustration in A. J. Hipkins, *Musical Instruments; Historic, Rare and Unique* (Edinburgh, 1888).

³ For a résumé of the question of the origin of this famous psalter, and an inquiry into its bearing on the history of musical instruments with illustrations and facsimile reproductions, see Kathleen Schlesinger, *The Instruments of the Orchestra*, part ii. "The Precursors of the Violin Family," pp. 127-166 (London, 1908-1909).

and subsequently the name was confined to the chief towns of the various administrative districts. These were also the seats of the bishops. It is thus affirmed that in France from the 5th to the 15th century the name *civitas* or *cit e* was confined to such towns as were episcopal sees, and Du Cange (*Gloss. s.v. civitas*) defines that word as *urbs episcopalis*; and states that other towns were termed *castra* or *oppida*. How far any such distinction can be sharply drawn may be doubted. With regard to England no definite line can be drawn between those towns to which the name *civitas* or *cit e* is given in medieval documents and those called *burgi* or boroughs (see J. H. Round, *Feudal England*, p. 338; F. W. Maitland, *Domesday Book and After*, p. 183). It was, however, maintained by Coke and Blackstone that a city is a town incorporate which is or has been the see of a bishop. It is true, indeed, that the actual sees in England all have a formal right to the title; the boroughs erected into episcopal sees by Henry VIII. thereby became "cities"; but towns such as Thetford, Sherborne and Dorchester are never so designated, though they are regularly incorporated and were once episcopal sees. On the other hand, it has only been since the latter part of the 19th century that the official style of "city" has, in the United Kingdom, been conferred by royal authority on certain important towns which were not episcopal sees, Birmingham in 1839 being the first to be so distinguished. It is interesting to note that London, besides 27 boroughs, now contains two cities, one (the City of London) outside, the other (the City of Westminster) included in the administrative county.

For the history of the origin and development of modern city government see **BOROUGH** and **COMMUNE: Medieval**.

CIUDAD BOL IVAR, an inland city and river port of Venezuela, capital of the state of Bol ivar, on the right bank of the Orinoco river, 240 m. above its mouth. Pop. (1891) 11,686. It stands upon a small hill about 187 ft. above sea-level, and faces the river where it narrows to a width of less than half a mile. The city is largely built upon the hillside. It is the seat of the bishopric of Guayana (founded in 1790), and is the commercial centre of the great Orinoco basin. Among its noteworthy edifices are the cathedral, federal college, theatre, masonic temple, market, custom-house, and hospital. The mean temperature is 83 . The city has a public water-supply, a tramway line, telephone service, subfluvial cable communication with Soledad near the mouth of the Orinoco, where connexion is made with the national land lines, and regular steamship communication with the lower and upper Orinoco. Previous to the revolution of 1901-3 Ciudad Bol ivar ranked fourth among the Venezuelan custom-houses, but the restrictions placed upon transit trade through West Indian ports have made her a dependency of the La Guaira custom-house to a large extent. The principal exports from this region include cattle, horses, mules, tobacco, cac o, rubber, tonka beans, bitters, hides, timber and many valuable forest products. The town was founded by Mendoza in 1764 as San Tom as de la Nueva Guayana, but its location at this particular point on the river gave to it the popular name of *Angostura*, the Spanish term for "narrows." This name was used until 1849, when that of the Venezuelan liberator was bestowed upon it. Ciudad Bol ivar played an important part in the struggle for independence and was for a time the headquarters of the revolution. The town suffered severely in the struggle for its possession, and the political disorders which followed greatly retarded its growth.

CIUDAD DE CURA, an inland town of the state of Aragua, Venezuela, 55 m. S.W. of Car acas, near the Lago de Valencia. Pop. (1891) 12,108. The town stands in a broad, fertile valley, between the sources of streams running southward to the Gu rico river and northward to the lake, with an elevation above sea-level of 1598 ft. Traffic between Puerto Cabello and the Gu rico plains has passed through this town since early colonial times, and has made it an important commercial centre, from which hides, cheese, coffee, cac o and beans are sent down to the coast for export; it bears a high reputation in Venezuela for commercial enterprise. Ciudad de Cura was founded in 1730, and suffered severely in the war of independence.

CIUDAD JUAREZ, formerly EL PASO DEL NORTE, a northern frontier town of Mexico, in the state of Chihuahua, 1223 m. by rail N.N.W. of Mexico City. Pop. (1895) 6917. Ciudad Juarez stands 3800 ft. above sea-level on the right bank of the R o Grande del Norte, opposite the city of El Paso, Texas, with which it is connected by two bridges. It is the northern terminus of the Mexican Central railway, and has a large and increasing transit trade with the United States, having a custom-house and a United States consulate. It is also a military post with a small garrison. The town has a straggling picturesque appearance, a considerable part of the habitations being small adobe or brick cabins. In the fertile neighbouring district cattle are raised, and wheat, Indian corn, fruit and grapes are grown, wine and brandy being made. The town was founded in 1681-1682; its present importance is due entirely to the railway. It was the headquarters of President Juarez in 1865, and was renamed in 1885 because of its devotion to his cause.

CIUDAD PORFIRIO DIAZ, formerly PIEDRAS NEGRAS, a northern frontier town of Mexico in the state of Coahuila, 1008 m. N. by W. from Mexico City, on the R o Grande del Norte, 720 ft. above sea-level, opposite the town of Eagle Pass, Texas. Pop. (1900, estimate) 5000. An international bridge connects the two towns, and the Mexican International railway has its northern terminus in Mexico at this point. The town has an important transfer trade with the United States, and is the centre of a fertile district devoted to agriculture and stock-raising. Coal is found in the vicinity. The Mexican government maintains a custom-house and military post here. The town was founded in 1849.

CIUDAD REAL, a province of central Spain, formed in 1833 of districts taken from New Castile, and bounded on the N. by Toledo, E. by Albacete, S. by Jaen and Cordova and W. by Badajoz. Pop. (1900) 321,580; area, 7620 sq. m. The surface of Ciudad Real consists chiefly of a level or slightly undulating plain, with low hills in the north-east and south-west; but along the south-western frontier the Sierra de Alcudia rises in two parallel ridges on either side of the river Alcudia, and is continued in the Sierra Madrona on the east. The river Guadiana drains almost the entire province, which it traverses from east to west; only the southernmost districts being watered by tributaries of the Guadalquivir. Numerous smaller streams flow into the Guadiana, which itself divides near Herencia into two branches,—the northern known as the Giguela, the southern as the Zancara. The eastern division of Ciudad Real forms part of the region known as La Mancha, a flat, thinly-peopled plain, clothed with meagre vegetation which is often ravaged by locusts. La Mancha (*q.v.*) is sometimes regarded as coextensive with the whole province. Severe drought is common here, although some of the rivers, such as the Jabalon and Azuer, issue fully formed from the chalky soil, and from their very sources give an abundant supply of water to the numerous mills. Towards the west, where the land is higher, there are considerable tracts of forest.

The climate is oppressively hot in summer, and in winter the plains are exposed to violent and bitterly cold winds; while the cultivation of grain, the vine and the olive is further impeded by the want of proper irrigation, and the general barrenness of the soil. Large flocks of sheep and goats find pasture in the plains; and the swine which are kept in the oak and beech forests furnish bacon and hams of excellent quality. Coal is mined chiefly at Puertollano, lead in various districts, mercury at Almad en. There are no great manufacturing towns. The roads are insufficient and ill-kept, especially in the north-east where they form the sole means of communication; and neither the Guadiana nor its tributaries are navigable. The main railway from Madrid to Lisbon passes through the capital, Ciudad Real, and through Puertollano; farther east, the Madrid-Lin ares line passes through Manzanares and Valdepe as. Branch railways also connect the capital with Manzanares, and Valdepe as with the neighbouring town of La Calzada.

The principal towns, Alc azar de San Juan (11,499), Almad en (7375), Almod ovar del Campo (12,525), Ciudad Real (15,255), Manzanares (11,229) and Valdepe as (21,015), are described in

separate articles. Almagro (7974) and Daimiel (11,825), in the district of La Mancha known as the Campo de Calatrava, belonged in the later middle ages to the knightly Order of Calatrava, which was founded in 1158 to keep the Moors in check. Almagro was long almost exclusively inhabited by monks and knights, and contains several interesting churches and monasteries, besides the castle of the knights, now used as barracks. Almagro is further celebrated for its lace, Daimiel for its medicinal salts. Tomelloso (13,929) is one of the chief market towns of La Mancha. Education is very backward, largely owing to the extreme poverty which has frequently brought the inhabitants to the verge of famine. (See also CASTILE.)

CIUDAD REAL, the capital formerly of La Mancha, and since 1833 of the province described above; 107 m. S. of Madrid, on the Madrid-Badajoz-Lisbon and Ciudad Real-Manzanares railways. Pop. (1900) 15,255. Ciudad Real lies in the midst of a wide plain, watered on the north by the river Guadiana, and on the south by its tributary the Jabalon. Apart from the remnants of its 13th-century fortifications, and one Gothic church of immense size, built without aisles, the town contains little of interest; its public buildings—town-hall, barracks, churches, hospital and schools—being in no way distinguished above those of other provincial capitals. There are no important local manufactures, and the trade of the town consists chiefly in the weekly sales of agricultural produce and live-stock. Ciudad Real was founded by Alphonso X. of Castile (1252-1284), and fortified by him as a check upon the Moorish power. Its original name of *Villarreal* was changed to *Ciudad Real* by John VI. in 1420. During the Peninsular War a Spanish force was defeated here by the French, on the 27th of March 1809.

CIUDAD RODRIGO, a town of western Spain, in the province of Salamanca, situated 8 m. E. of the Portuguese frontier, on the right bank of the river Agueda, and the railway from Salamanca to Coimbra in Portugal. Pop. (1900) 8930. Ciudad Rodrigo is an episcopal see, and was for many centuries an important frontier fortress. Its cathedral dates from 1190, but was restored in the 15th century. The remnants of a Roman aqueduct, the foundations of a bridge across the Agueda, and other remains, seem to show that Ciudad Rodrigo occupies the site of a Roman settlement. It was founded in the 12th century by Count Rodrigo Gonzalez, from whom its name is derived. During the Peninsular War, it was captured by the French under Marshal Ney, in 1810; but on the 19th of January 1812 it was retaken by the British under Viscount Wellington, who, for this exploit, was created earl of Wellington, duke of Ciudad Rodrigo, and marquess of Torres Vedras, in Portugal.

CIVERCHIO, VINCENZO, an early 16th-century Italian painter, born at Crema. There are altar-pieces by him at Brescia, and at Crema the altar-piece at the duomo (1509). His "Birth of Christ" is in the Brera, Milan; and at Lovere are other of his works dating from 1539 and 1540.

CIVET, or properly CIVET-CAT, the designation of the more typical representatives of the mammalian family *Viverridae* (see CARNIVORA). Civets are characterized by the possession of a deep pouch in the neighbourhood of the genital organs, into which the substance known as civet is poured from the glands by which it is secreted. This fatty substance is at first semifluid and yellow, but afterwards acquires the consistency of pomade and becomes darker. It has a strong musky odour, exceedingly disagreeable to those unaccustomed to it, but "when properly diluted and combined with other scents it produces a very pleasing effect, and possesses a much more floral fragrance than musk, indeed it would be impossible to imitate some flowers without it." The African civet (*Viverra civetta*) is from 2 to 3 ft. in length, exclusive of the tail, which is half the length of the body, and stands from 10 to 12 in. high. It is covered with long hair, longest on the middle line of the back, where it is capable of being raised or depressed at will, of a dark-grey colour, with numerous transverse black bands and spots. In habits it is chiefly nocturnal, and by preference carnivorous, feeding on birds and the smaller quadrupeds, in pursuit of which it climbs trees, but it is said also to eat fruits, roots and other

vegetable matters. In a state of captivity the civet is never completely tamed, and only kept for the sake of its perfume, which is obtained in largest quantity from the male, especially when in good condition and subjected to irritation, being scraped from the pouch with a small spoon usually twice a week. The zibeth (*Viverra zibetha*) is a widely distributed species extending from Arabia to Malabar, and throughout several of the larger islands of the Indian Archipelago. It is smaller than the true civet, and wants the dorsal crest. In the wild state it does great damage among poultry, and frequently makes off with the young of swine and sheep. When hunted it makes a determined resistance, and emits a scent so strong as even to sicken the dogs, who nevertheless are exceedingly fond of the sport, and cannot be got to pursue any other game while the stench of the zibeth is in their nostrils. In confinement, it becomes comparatively tame, and yields civet in considerable quantity. In preparing this for the market it is usually spread out on the leaves of the pepper plant in order to free it from the hairs that have become detached from the pouch. On the Malabar coast this species is replaced by *V. civettina*. The small Indian civet or rasse (*Viverricula malaccensis*) ranges from Madagascar through India to China, the Malay Peninsula, and the islands of the Archipelago. It is almost 3 ft. long including the tail, and prettily marked with dark longitudinal stripes, and spots which have a distinctly linear arrangement. The perfume, which is extracted in the same way as in the two preceding species, is highly valued and much used by the Javanese. Although this animal is said to be an expert climber it usually inhabits holes in the ground. It is frequently kept in captivity in the East, and becomes tame. Fossil remains of extinct civets are found in the Miocene strata of Europe.

CIVIDALE DEL FRIULI (anc. *Forum Iulii*), a town of Venetia, Italy, in the province of Udine, 10 m. E. by N. by rail from the town of Udine; 453 ft. above sea-level. Pop. (1901) town, 4143; commune, 9061. It is situated on the river Natissone, which forms a picturesque ravine here. It contains some interesting relics of the art of the 8th century. The cathedral of the 15th century contains an octagonal marble canopy with sculptures in relief, with a font below it belonging to the 8th century, but altered later. The high altar has a fine silver altar front of 1185. The museum contains various Roman and Lombard antiquities, and valuable MSS. and works of art in gold, silver and ivory formerly belonging to the cathedral chapter. The small church of S. Maria in Valle belongs to the 8th century, and contains fine decorations in stucco which probably belong to the 11th or 12th century. The fine 15th-century Ponte del Diavolo leads to the church of S. Martino, which contains an altar of the 8th century with reliefs executed by order of the Lombard king Ratchis. At Cividale were born Paulus Diaconus, the historian of the Lombards in the time of Charlemagne, and the actress Adelaide Ristori (1822-1906).

The Roman town (a *municipium*) of Forum Iulii was founded either by Julius Caesar or by Augustus, no doubt at the same time as the construction of the Via Iulia Augusta, which passed through Utina (Udine) on its way north. After the decay of Aquileia and Iulium Carnicum (Zuglio) it became the chief town of the district of Friuli and gave its name to it. The patriarchs of Aquileia resided here from 773 to 1031, when they returned to Aquileia, and finally in 1238 removed to Udine. This last change of residence was the origin of the antagonism between Cividale and Udine, which was only terminated by their surrender to Venice in 1419 and 1420 respectively.

CIVILIS, CLAUDIUS, or more correctly, JULIUS, leader of the Batavian revolt against Rome (A.D. 69-70). He was twice imprisoned on a charge of rebellion, and narrowly escaped execution. During the disturbances that followed the death of Nero, he took up arms under pretence of siding with Vespasian and induced the inhabitants of his native country to rebel. The Batavians, who had rendered valuable aid under the early emperors, had been well treated in order to attach them to the cause of Rome. They were exempt from tribute, but were obliged to supply a large number of men for the army, and the

burden of conscription and the oppressions of provincial governors were important incentives to revolt. The Batavians were immediately joined by several neighbouring German tribes, the most important of whom were the Frisians. The Roman garrisons near the Rhine were driven out, and twenty-four ships captured. Two legions under Mummius Lupercus were defeated at Castra Vetera (near the modern Xanten) and surrounded. Eight cohorts of Batavian veterans joined their countrymen, and the troops sent by Vespasian to the relief of Vetera threw in their lot with them. The result of these accessions to the forces of Civilis was a rising in Gaul. Hordeonius Flaccus was murdered by his troops (70), and the whole of the Roman forces were induced by two commanders of the Gallic auxiliaries—Julius Classicus and Julius Tutor—to revolt from Rome and join Civilis. The whole of Gaul thus practically declared itself independent, and the foundation of a new kingdom of Gaul was contemplated. The prophetess Velleda predicted the complete success of Civilis and the fall of the Roman Empire. But disputes broke out amongst the different tribes and rendered co-operation impossible; Vespasian, having successfully ended the civil war, called upon Civilis to lay down his arms, and on his refusal resolved to take strong measures for the suppression of the revolt. The arrival of Petillius Cerialis with a strong force awed the Gauls and mutinous troops into submission; Civilis was defeated at Augusta Treverorum (Trier, Trèves) and Vetera, and forced to withdraw to the island of the Batavians. He finally came to an agreement with Cerialis whereby his countrymen obtained certain advantages, and resumed amicable relations with Rome. From this time Civilis disappears from history.

The chief authority for the history of the insurrection is Tacitus, *Historiae*, iv., v., whose account breaks off at the beginning of Civilis's speech to Cerialis; see also Josephus, *Bellum Judaicum*, vii. 4. There is a monograph by E. Meyer, *Der Freiheitskrieg der Bataver unter Civilis* (1856); see also Merivale, *Hist. of the Romans under the Empire*, ch. 58; H. Schiller, *Geschichte der römischen Kaiserzeit*, bk. ii. ch. 2, § 54 (1883).

CIVILIZATION. The word "civilization" is an obvious derivative of the Lat. *civis*, a citizen, and *civilis*, pertaining to a citizen. Etymologically speaking, then, it would be putting no undue strain upon the word to interpret it as having to do with the entire period of human progress since mankind attained sufficient intelligence and social unity to develop a system of government. But in practice "civilization" is usually interpreted in a somewhat narrower sense, as having application solely to the most recent and comparatively brief period of time that has elapsed since the most highly developed races of men have used systems of writing. This restricted usage is probably explicable, in part at least, by the fact that the word, though distinctly modern in origin, is nevertheless older than the interpretation of social evolution that now finds universal acceptance. Only very recently has it come to be understood that primitive societies vastly antedating the historical period had attained relatively high stages of development and fixity, socially and politically. Now that this is understood, however, nothing but an arbitrary and highly inconvenient restriction of meanings can prevent us from speaking of the citizens of these early societies as having attained certain stages of civilization. It will be convenient, then, in outlining the successive stages of human progress here, to include under the comprehensive term "civilization" those long earlier periods of "savagery" and "barbarism" as well as the more recent period of higher development to which the word "civilization" is sometimes restricted.

Adequate proof that civilization as we now know it is the result of a long, slow process of evolution was put forward not long after the middle of the 19th century by the students of palaeontology and of prehistoric archaeology. A recognition of the fact that primitive man used implements of chipped flint, of polished stone, and of the softer metals for successive ages, before he attained a degree of technical skill and knowledge that would enable him to smelt iron, led the Danish archaeologists to classify the stages of human progress under these captions: the Rough

Stone Age; the Age of Polished Stone; the Age of Bronze; and the Age of Iron. These terms acquired almost universal recognition, and they retain popularity as affording a very broad outline of the story of human progress. It is obviously desirable, however, to fill in the outlines of the story more in detail. To some extent it has been possible to do so, largely through the efforts of ethnologists who have studied the social conditions of existing races of savages. A recognition of the principle that, broadly speaking, progress has everywhere been achieved along the same lines and through the same sequence of changes, makes it possible to interpret the past history of the civilized races of to-day in the light of the present-day conditions of other races that are still existing under social and political conditions of a more primitive type. Such races as the Maoris and the American Indians have furnished invaluable information to the student of social evolution; and the knowledge thus gained has been extended and fortified by the ever-expanding researches of the palaeontologist and archaeologist.

Thus it has become possible to present with some confidence a picture showing the successive stages of human development during the long dark period when our prehistoric ancestor was advancing along the toilsome and tortuous but on the whole always uprising path from lowest savagery to the stage of relative enlightenment at which we find him at the so-called "dawnings of history." That he was for long ages a savage before he attained sufficient culture to be termed, in modern phraseology, a barbarian, admits of no question. Equally little in doubt is it that other long ages of barbarism preceded the final ascent to civilization. The precise period of time covered by these successive "Ages" is of course only conjectural; but something like one hundred thousand years may perhaps be taken as a safe minimal estimate. At the beginning of this long period, the most advanced race of men must be thought of as a promiscuous company of pre-troglodytic mammals, at least partially arboreal in habit, living on uncooked fruits and vegetables, and possessed of no arts and crafts whatever—nor even of the knowledge of the rudest implement. At the end of the period, there emerges into the more or less clear light of history a large-brained being, living in houses of elaborate construction, supplying himself with divers luxuries through the aid of a multitude of elaborate handicrafts, associated with his fellows under the sway of highly organized governments, and satisfying aesthetic needs through the practice of pictorial and literary arts of a high order. How was this amazing transformation brought about?

If an answer can be found to that query, we shall have a clue to all human progress, not only during the prehistoric but also during the historic periods; for we may well believe that recent progress has not departed from the scheme of development impressed on humanity during that long apprenticeship. Ethnologists believe that an answer can be found. They believe that the metamorphosis from beast-like savage to cultured civilian may be proximally explained (certain potentialities and attributes of the species being taken for granted) as the result of accumulated changes that found their initial impulses in a half-dozen or so of practical inventions. Stated thus, the explanation seems absurdly simple. Confessedly it supplies only a proximal, not a final, analysis of the forces impelling mankind along the pathway of progress. But it has the merit of tangibility; it presents certain highly important facts of human history vividly; and it furnishes a definite and fairly satisfactory basis for marking successive stages of incipient civilization.

In outlining the story of primitive man's advancement, upon such a basis, we may follow the scheme of one of the most philosophical of ethnologists, Lewis H. Morgan, who made a provisional analysis of the prehistoric period that still remains among the most satisfactory attempts in this direction. Morgan divides the entire epoch of man's progress from bestiality to civilization into six successive periods, which he names respectively the Older, Middle and Later periods of Savagery, and the Older, Middle and Later periods of Barbarism.

*Crucial
develop-
ments.*

*Savagery
and bar-
barism.*

The first of these periods, when mankind was in the lower status of savagery, comprises the epoch when articulate speech was being developed. Our ancestors of this epoch inhabited a necessarily restricted tropical territory, and subsisted upon raw nuts and fruits. They had no knowledge of the uses of fire. All existing races of men had advanced beyond this condition before the opening of the historical period.

The Middle Period of Savagery began with a knowledge of the uses of fire. This wonderful discovery enabled the developing race to extend its habitat almost indefinitely, and to include flesh, and in particular fish, in its regular dietary. Man could now leave the forests, and wander along the shores and rivers, migrating to climates less enervating than those to which he had previously been confined. Doubtless he became an expert fisher, but he was as yet poorly equipped for hunting, being provided, probably, with no weapon more formidable than a crude hatchet and a roughly fashioned spear. The primitive races of Australia and Polynesia had not advanced beyond this middle status of savagery when they were discovered a few generations ago. It is obvious, then, that in dealing with the further progress of nascent civilization we have to do with certain favoured portions of the race, which sought out new territories and developed new capacities while many tribes of their quondam peers remained static and hence by comparison seemed to retrograde.

The next great epochal discovery, in virtue of which a portion of the race advanced to the Upper Status of Savagery, was that of the bow and arrow,—a truly wonderful implement. The possessor of this device could bring down the fleetest animal and could defend himself against the most predatory. He could provide himself not only with food but with materials for clothing and for tent-making, and thus could migrate at will back from the seas and large rivers, and far into inhospitable but invigorating temperate and sub-Arctic regions. The meat diet, now for the first time freely available, probably contributed, along with the stimulating climate, to increase the physical vigour and courage of this highest savage, thus urging him along the paths of progress. Nevertheless many tribes came thus far and no further, as witness the Athapascans of the Hudson's Bay Territory and the Indians of the valley of the Columbia.

We now come to the marvellous discovery that enabled our ancestor to make such advances upon the social conditions of his forbears as to entitle him, in the estimate of his remote descendants, to be considered as putting savagery behind him and as entering upon the Lower Status of Barbarism. The discovery in question had to do with the practice of the art of making pottery (see CERAMICS). Hitherto man had been possessed of no permanent utensils that could withstand the action of fire. He could not readily boil water except by some such cumbersome method as the dropping of heated stones into a wooden or skin receptacle. The effect upon his dietary of having at hand earthen vessels in which meat and herbs could be boiled over a fire must have been momentous. Various meats and many vegetables become highly palatable when boiled that are almost or quite inedible when merely roasted before a fire. Bones, sinews and even hides may be made to give up a modicum of nutriment in this way; and doubtless barbaric man, before whom starvation always loomed threateningly, found the crude pot an almost perennial refuge. And of course its use as a cooking utensil was only one of many ways in which the newly discovered mechanism exerted a civilizing influence.

The next great progressive movement, which carried man into the Middle Status of Barbarism, is associated with the domestication of animals in the Eastern hemisphere, and with the use of irrigation in cultivating the soil and of adobe bricks and stone in architecture in the Western hemisphere. The dog was probably the first animal to be domesticated, but the sheep, the ox, the camel and the horse were doubtless added in relatively rapid succession, so soon as the idea that captive animals could be of service had been

clearly conceived. Man now became a herdsman, no longer dependent for food upon the precarious chase of wild animals. Milk, procurable at all seasons, made a highly important addition to his dietary. With the aid of camel and horse he could traverse wide areas hitherto impassable, and come in contact with distant peoples. Thus commerce came to play an extended rôle in the dissemination of both commodities and ideas. In particular the nascent civilization of the Mediterranean region fell heir to numerous products of farther Asia,—gums, spices, oils, and most important of all, the cereals. The cultivation of the latter gave the finishing touch to a comprehensive and varied diet, while emphasizing the value of a fixed abode. For the first time it now became possible for large numbers of people to form localized communities. A natural consequence was the elaboration of political systems, which, however, proceeded along lines already suggested by the experience of earlier epochs. All this tended to establish and emphasize the idea of nationality, based primarily on blood-relationship; and at the same time to develop within the community itself the idea of property,—that is to say, of valuable or desirable commodities which have come into the possession of an individual through his enterprise or labour, and which should therefore be subject to his voluntary disposal. At an earlier stage of development, all property had been of communal, not of individual, ownership. It appears, then, that our mid-period barbarian had attained—if the verbal contradiction be permitted—a relatively high stage of civilization.

There remained, however, one master craft of which he had no conception. This was the art of smelting iron. When, ultimately, his descendants learned the wonderful secrets of that art, they rose in consequence to the Upper Status of Barbarism. This culminating practical invention, it will be observed, is the first of the great discoveries with which we have to do that was not primarily concerned with the question of man's food supply. Iron, to be sure, has abundant uses in the same connexion, but its most direct and obvious utilities have to do with weapons of war and with implements calculated to promote such arts of peace as house-building, road-making and the construction of vehicles. Wood and stone could now be fashioned as never before. Houses could be built and cities walled with unexampled facility; to say nothing of the making of a multitude of minor implements and utensils hitherto quite unknown, or at best rare and costly. Nor must we overlook the aesthetic influence of edged implements, with which wood and stone could readily be sculptured when placed in the hands of a race that had long been accustomed to scratch the semblance of living forms on bone or ivory and to fashion crude images of clay. In a word, man, the "tool-making animal," was now for the first time provided with tools worthy of his wonderful hands and yet more wonderful brain.

Thus through the application of one revolutionary invention after another, the most advanced races of men had arrived, after long ages of effort, at a relatively high stage of development. A very wide range of experiences had enabled man to evolve a complex body politic, based on a fairly secure social basis, and his brain had correspondingly developed into a relatively efficient and stable organ of thought. But as yet he had devised no means of communicating freely with other people at a distance except through the medium of verbal messages; nor had he any method by which he could transmit his experiences to posterity more securely than by fugitive and fallible oral traditions. A vague symbolization of his achievements was preserved from generation to generation in myth-tale and epic, but he knew not how to make permanent record of his history. Until he could devise a means to make such record, he must remain, in the estimate of his descendants, a barbarian, though he might be admitted to have become a highly organized and even in a broad sense a cultured being.

At length, however, this last barrier was broken. Some race or races devised a method of symbolizing events and ultimately of making even abstruse ideas tangible by means of graphic signs. In other words, a system of writing was developed. Man thus achieved a virtual conquest over time

as he had earlier conquered space. He could now transmit the record of his deeds and his thoughts to remote posterity. Thus he stood at the portals of what later generations would term secure history. He had graduated out of barbarism, and become in the narrower sense of the word a civilized being. Henceforth, his knowledge, his poetical dreamings, his moral aspirations might be recorded in such form as to be read not merely by his contemporaries but by successive generations of remote posterity. The inspiring character of such a message is obvious. The validity of making this great culminating intellectual achievement the test of "civilized" existence need not be denied. But we should ill comprehend the character of the message which the earlier generations of civilized beings transmit to us from the period which we term the "dawning of history" did we not hear constantly in mind the long series of progressive stages of "savagery" and "barbarism" that of necessity preceded the final stage of "civilization" proper. The achievements of those earlier stages afforded the secure foundation for the progress of the future. A multitude of minor arts, in addition to the important ones just outlined, had been developed; and for a long time civilized man was to make no other epochal addition to the list of accomplishments that came to him as a heritage from his barbaric progenitor. Indeed, even to this day the list of such additions is not a long one, nor, judged in the relative scale, so important as might at first thought be supposed. Whoever considers the subject carefully must admit the force of Morgan's suggestion that man's achievements as a barbarian, considered in their relation to the sum of human progress, "transcend, in relative importance, all his subsequent works."

Without insisting on this comparison, however, let us ask what discoveries and inventions man has made within the historical period that may fairly be ranked with the half-dozen great epochal achievements that have been put forward as furnishing the keys to all the progress of the prehistoric periods. In other words, let us sketch the history of progress during the ten thousand years or so that have elapsed since man learned the art of writing, adapting our sketch to the same scale which we have already applied to the unnumbered millenniums of the prehistoric period. The view of world-history thus outlined will be a very different one from what might be expected by the student of national history; but it will present the essentials of the progress of civilization in a suggestive light.

Without pretending to fix an exact date,—which the historical records do not at present permit,—we may assume that the most advanced race of men elaborated a system of writing not less than six thousand years before the beginning of the Christian era. Holding to the terminology already suggested for the earlier periods, we may speak of man's position during the ensuing generations as that of the First or Lowest Status of civilization. If we review the history of this period we shall find that it extends unbroken over a stretch of at least four or five thousand years. During the early part of this period such localized civilizations as those of the Egyptians, the Sumerians, the Babylonians and the Hittites rose, grew strong and passed beyond their meridian. This suggests that we must now admit the word "civilization" to yet another definition, within its larger meaning: we must speak of "a civilization," as that of Egypt, of Babylonia, of Assyria, and we must understand thereby a localized phase of society bearing the same relation to civilization as a whole that a wave bears to the ocean or a tree to the forest. Such other localized civilizations as those of Phoenicia, Carthage, Greece, Rome, Byzantium, the Sassanids, in due course waxed and waned, leaving a tremendous imprint on national history, but creating only minor and transitory ripples in the great ocean of civilization. Progress in the elaboration of the details of earlier methods and inventions took place as a matter of course. Some nation, probably the Phoenicians, gave a new impetus to the art of writing by developing a phonetic alphabet; but this achievement, remarkable as it was in itself, added nothing fundamental to human capacity. Literatures had previously flourished through the use of hiero-

glyphic and syllabic symbols; and the Babylonian syllabics continued in vogue throughout western Asia for a long time after the Phoenician alphabet had demonstrated its intrinsic superiority.

Similarly the art of Egyptian and Assyrian and Greek was but the elaboration and perfection of methods that barbaric man had practised away back in the days when he was a cave-dweller. The weapons of warfare of Greek and Roman were the spear and the bow and arrow that their ancestors had used in the period of savagery, aided by sword and helmet dating from the upper period of barbarism. Greek and Roman government at their best were founded upon the system of *gentes* that barbaric man had profoundly studied,—as witness, for example, the federal system of the barbaric Iroquois Indians existing in America before the coming of Columbus. And if the Greeks had better literature, the Romans better roads and larger cities, than their predecessors, these are but matters of detailed development, the like of which had marked the progress of the more important arts and the introduction of less important ancillary ones in each antecedent period. The axe of steel is no new implement, but a mere perfecting of the axe of chipped flint. The *Iliad* represents the perfecting of an art that unnumbered generations of barbarians practised before their camp-fires.

Thus for six or seven thousand years after man achieved civilization there was rhythmic progress in many lines, but there came no great epochal invention to usher in a new ethnic period. Then, towards the close of what historians of to-day are accustomed to call the middle ages, there appeared in rapid sequence three or four inventions and a great scientific discovery that, taken together, were destined to change the entire aspect of European civilization. The inventions were gunpowder, the mariner's compass, paper and the printing-press, three of which appear to have been brought into Europe by the Moors, whether or not they originated in the remote East. The scientific discovery which must be coupled with these inventions was the Copernican demonstration that the sun and not the earth is the centre of our planetary system. The generations of men that found themselves (1) confronted with the revolutionary conception of the universe given by the Copernican theory; (2) supplied with the new means of warfare provided by gunpowder; (3) equipped with an undreamed-of guide across the waters of the earth; and (4) enabled to promulgate knowledge with unexampled speed and cheapness through the aid of paper and printing-press—such generations of men might well be said to have entered upon a new ethnic period. The transition in their mode of thought and in their methods of practical life was as great as can be supposed to have resulted, in an early generation, from the introduction of iron, or in a yet earlier from the invention of the bow and arrow. So the Europeans of about the 15th century of the Christian era may be said to have entered upon the Second or Middle Status of civilization.

The new period was destined to be a brief one. It had compassed only about four hundred years when, towards the close of the 18th century, James Watt gave to the world the perfected steam-engine. Almost contemporaneously Arkwright and Hargreaves developed revolutionary processes of spinning and weaving by machinery. Meantime James Hutton and William Smith and their successors on the one hand, and Erasmus Darwin, François Lamarck, and (a half-century later) Charles Darwin on the other, turned men's ideas topsy-turvy by demonstrating that the world as the abiding-place of animals and man is enormously old, and that man himself instead of deteriorating from a single perfect pair six thousand years removed, has ascended from bestiality through a slow process of evolution extending over hundreds of centuries. The revolution in practical life and in the mental life of our race that followed these inventions and this new presentation of truth probably exceeded in suddenness and in its far-reaching effects the metamorphosis effected at any previous transition from one ethnic period to another. The men of the 19th century, living now in the period that may be termed the Upper Status

Great inventions of the middle ages.

Civilization proper.

Steam machinery.

of civilization, saw such changes effected in the practical affairs of their everyday lives as had not been wrought before during the entire historical period. Their fathers had travelled in vehicles drawn by horses, quite as their remoter ancestors had done since the time of higher barbarism. It may be doubted whether there existed in the world in the year 1800 a postal service that could compare in speed and efficiency with the express service of the Romans of the time of Caesar; far less was there a telegraph service that could compare with that of the ancient Persians. Nor was there a ship sailing the seas that a Phoenician trireme might not have overhauled. But now within the lifetime of a single man the world was covered with a network of steel rails on which locomotives drew gigantic vehicles, laden with passengers at an hourly speed almost equalling Caesar's best journey of a day; over the land and under the seas were stretched wires along which messages coursed from continent to continent literally with the speed of lightning; and the waters of the earth were made to teem with gigantic craft propelled without sail or oar at a speed which the Phoenician captain of three thousand years ago and the English captain of the 18th century would alike have held incredible.

There is no need to give further details here of the industrial revolutions that have been achieved in this newest period of civilization, since in their broader outlines at least they are familiar to every one. Nor need we dwell upon the revolution in thought whereby man has for the first time been given a clear inkling as to his origin and destiny. It suffices to point out that such periods of fermentation of ideas as this suggests have probably always been concomitant with those outbursts of creative genius that gave the world the practical inventions upon which human progress has been conditioned. The same attitude of receptivity to new ideas is pre-requisite to one form of discovery as to the other. Nor, it may be added, can either form of idea become effective for the progress of civilization except in proportion as a large body of any given generation are prepared to receive it. Doubtless here and there a dreamer played with fire, in a literal sense, for generations before the utility of fire as a practical aid to human progress came to be recognized in practice. And—to seek an illustration at the other end of the scale—we know that the advanced thinkers of Greece and Rome believed in the antiquity of the earth and in the evolution of man two thousand years before the coming of Darwin. We have but partly solved the mysteries of the progress of civilization, then, when we have pointed out that each tangible stage of progress owed its initiative to a new invention or discovery of science. To go to the root of the matter we must needs explain how it came about that a given generation of men was in mental mood to receive the new invention or discovery.

The pursuit of this question would carry us farther into the realm of communal and racial psychology—to say nothing of the realm of conjecture—than comports with the purpose of this article. It must suffice to point out that alertness of mind—that all mentality—is, in the last analysis, a reaction to the influences of the environment. It follows that man may subject himself to new influences and thus give his mind a new stimulus by changing his habitat. A fundamental secret of progress is revealed in this fact. Man probably never would have evolved from savagery had he remained in the Tropics where he doubtless originated. But successive scientific inventions enabled him, as has been suggested, to migrate to distant latitudes, and thus more or less involuntarily to become the recipient of new creative and progressive impulses. After migrations in many directions had resulted in the development of divers races, each with certain capacities and acquirements due to its unique environment, there was opportunity for the application of the principle of environmental stimulus in an indirect way, through the mingling and physical intermixture of one race with another. Each of the great localized civilizations of antiquity appears to have owed its prominence in part at least—perhaps very largely—to such intermingling of two or more races. Each of these civilizations began to decay so soon as the nation had

remained for a considerable number of generations in its localized environment, and had practically ceased to receive accretions from distant races at approximately the same stage of development. There is a suggestive lesson for present-day civilization in that thought-compelling fact. Further evidence of the application of the principle of environmental stimulus, operating through changed habitat and racial intermixture, is furnished by the virility of the colonial peoples of our own day. The receptiveness to new ideas and the rapidity of material progress of Americans, South Africans and Australians are proverbial. No one doubts, probably, that one or another of these countries will give a new stimulus to the progress of civilization, through the promulgation of some great epochal discovery, in the not distant future. Again, the value of racial intermingling is shown yet nearer home in the long-continued vitality of the British nation, which is explicable, in some measure at least, by the fact that the Celtic element held aloof from the Anglo-Saxon element century after century sufficiently to maintain racial integrity, yet mingled sufficiently to give and receive the fresh stimulus of "new blood." It is interesting in this connexion to examine the map of Great Britain with reference to the birthplaces of the men named above as being the originators of the inventions and discoveries that made the close of the 18th century memorable as ushering in a new ethnic era. It may be added that these names suggest yet another element in the causation of progress: the fact, namely, that, however necessary racial receptivity may be to the dynamic upheaval of a new ethnic era, it is after all *individual* genius that applies its detonating spark.

Without further elaboration of this aspect of the subject it may be useful to recapitulate the analysis of the evolution of civilization above given, prior to characterizing it from another standpoint. It appears that the entire period of human progress up to the present may be divided into nine periods which, if of necessity more or less arbitrary, yet are not without certain warrant of logic. They may be defined as follows: (1) The Lower Period of Savagery, terminating with the discovery and application of the uses of fire. (2) The Middle Period of Savagery, terminating with the invention of the bow and arrow. (3) The Upper Period of Savagery, terminating with the invention of pottery. (4) The Lower Period of Barbarism, terminating with the domestication of animals. (5) The Middle Period of Barbarism, terminating with the discovery of the process of smelting iron ore. (6) The Upper Period of Barbarism, terminating with the development of a system of writing meeting the requirements of literary composition. (7) The First Period of Civilization (proper) terminating with the introduction of gunpowder. (8) The Second Period of Civilization, terminating with the invention of a practical steam-engine. (9) The Upper Period of Civilization, which is still in progress, but which, as will be suggested in a moment, is probably nearing its termination.

It requires but a glance at the characteristics of these successive epochs to show the ever-increasing complexity of the inventions that delimit them and of the conditions of life that they connote. Were we to attempt to characterize in a few phrases the entire story of achievement thus outlined, we might say that during the three stages of Savagery man was attempting to make himself master of the geographical climates. His unconscious ideal was, to gain a foothold and the means of subsistence in every zone. During the three periods of Barbarism the ideal of conquest was extended to the beasts of the field, the vegetable world, and the mineral contents of the earth's crust. During the three periods of Civilization proper the ideal of conquest has become still more intellectual and subtle, being now extended to such abstractions as an analysis of speech-sounds, and to such intangibles as expanding gases and still more elusive electric currents: in other words, to the forces of nature, no less than to tangible substances. Hand in hand with this growing complexity of man's relations with the external world has gone a like increase of complexity in the social and political organizations that characterize man's relations with his fellow-

Social and political organization.

Nine periods of progress.

men. In savagery the family expanded into the tribe; in barbarism the tribe developed into the nation. The epoch of civilization proper is aptly named, because it has been a time in which citizenship, in the narrower national significance, has probably been developed to its apogee. Throughout this period, in every land, the highest virtue has been considered to be patriotism,—by which must be understood an instinctive willingness on the part of every individual to defend even with his life the interests of the nation into which he chances to be born, regardless of whether the national cause in which he struggles be in any given case good or bad, right or wrong. The communal judgment of this epoch pronounces any man a traitor who will not uphold his own nation even in a wrong cause—and the word “traitor” marks the utmost brand of ignominy.

But while the idea of nationality has thus been accentuated, there has been a never-ending struggle within the bounds of the nation itself to adjust the relations of one citizen to another. The ideas that might make right, that the strong man must dominate the weak, that leadership in the community properly belongs to the man who is physically most competent to lead—these ideas were a perfectly natural, and indeed an inevitable, outgrowth of the conditions under which man fought his way up through savagery and barbarism. Man in the first period of civilization inherited these ideas, along with the conditions of society that were their concomitants. So throughout the periods when the oriental civilizations of Egypt and Babylonia and Assyria and Persia were dominant, a despotic form of government was accepted as the natural order of things. It does not appear that any other form was even considered as a practicality. A despot might indeed be overthrown, but only to make way for the coronation of another despot. A little later the Greeks and Romans modified the conception of a heaven-sent individual monarch; but they went no further than to substitute a heaven-favoured community, with specially favoured groups (*Patricii*) within the community. With this, national egoism reached its climax; for each people regarded its own citizens as the only exemplars of civilization, openly branding all the rest of the world as “barbarians,” fit subjects for the exaction of tribute or for the imposition of the bonds of actual slavery. During the middle ages there was a reaction towards individualism as opposed to nationalism: but the entire system of feudalism, with its clearly recognized conditions of over-lordship and of vassalage, gave expression, no less clearly than oriental despotism and classical “democracy” had done, to the idea of individual inequality; of divergence of moral and legal status based on natural inheritance. Thus this idea, a reminiscence of barbarism, maintained its dominance throughout the first period of civilization.

But gunpowder, marking the transition to the second period of civilization, came as a great levelling influence. With its aid the weakest peasant might prove more than a match for the most powerful knight. Before its assaults the castle of the lord ceased to be an impregnable fortress. And while gunpowder thus levelled down the power of the mighty, the printing-press levelled up the intelligence, and hence the power and influence of the lowly. Meantime the mariner’s compass opened up new territories beyond the seas, and in due course men of lowly origin were seen to attain to wealth and power through commercial pursuits, thus tending to break in upon the established social order. In the colonial territories themselves all men were subjected more or less to the same perils and dependent upon their own efforts. Success and prominence in the community came not as a birth-right, but as the result of demonstrated fitness. The great lesson that the interests of all members of a community are, in the last analysis, mutual could be more clearly distinguished in these small colonies than in larger and older bodies politic. Through various channels, therefore, in the successive generations of this middle period of civilization, the idea gained ground that intelligence and moral worth, rather than physical prowess, should be the test of greatness; that it is incumbent on the strong in the interests of the body politic to protect the weak; and that, in the long run, the best interests of the community are conserved

if all its members, without exception, are given moral equality before the law. This idea of equal rights and privileges for all members of the community—for each individual “the greatest amount of liberty consistent with a like liberty of every other individual”—first found expression as a philosophical doctrine towards the close of the 18th century; at which time also tentative efforts were made to put it into practice. It may be said therefore to represent the culminating sociological doctrine of the middle period of civilization,—the ideal towards which all the influences of the period had tended to impel the race.

It will be observed, however, that this ideal of individual equality within the body politic in no direct wise influences the status of the body politic itself as the centre of a localized civilization that may be regarded as in a sense antagonistic to all other similarly localized civilizations. If there were any such influence, it would rather operate in the direction of accentuating the patriotism of the member of a democratical community, as against that of the subject of a despot, through the sense of personal responsibility developed in the former. The developments of the middle period of civilization cannot be considered, therefore, to have tended to decrease the spirit of nationality, with its concomitant penalty of what is sometimes called provincialism. The history of this entire period, as commonly presented, is largely made up of the records of international rivalries and jealousies, perennially culminating in bitterly contested wars. It was only towards the close of the epoch that the desirability of free commercial intercourse among nations began to find expression as a philosophical creed through the efforts of Quesnay and his followers; and the doctrine that both parties to an international commercial transaction are gainers thereby found its first clear expression in the year 1776 in the pages of Condillac and of Adam Smith.

But the discoveries that ushered in the third period of civilization were destined to work powerfully from the outset for the breaking down of international barriers, though, of course, their effects would not be at once manifest. Thus the substitution of steam power for water power, besides giving a tremendous impetus to manufacturing in general, mapped out new industrial centres in regions that nature had supplied with coal but not always with other raw materials. To note a single result, England became the manufacturing centre of the world, drawing its raw materials from every corner of the globe; but in so doing it ceased to be self-supporting as regards the production of food-supplies. While growing in national wealth, as a result of the new inventions, England has therefore lost immeasurably in national self-sufficiency and independence; having become in large measure dependent upon other countries both for the raw materials without which her industries must perish and for the foods to maintain the very life of her people.

What is true of England in this regard is of course true in greater or less measure of all other countries. Everywhere, thanks to the new mechanisms that increase industrial efficiency, there has been an increasing tendency to specialization; and since the manufacturer must often find his raw materials in one part of the world and his markets in another, this implies an ever-increasing intercommunication and interdependence between the nations. This spirit is obviously fostered by the new means of transportation by locomotive and steamship, and by the electric communication that enables the Londoner, for example, to transact business in New York or in Tokio with scarcely an hour’s delay; and that puts every one in touch at to-day’s breakfast table with the happenings of the entire world. Thanks to the new mechanisms, national isolation is no longer possible; globe-trotting has become a habit with thousands of individuals of many nations; and Orient and Occident, representing civilizations that for thousands of years were almost absolutely severed and mutually oblivious of each other, have been brought again into close touch for mutual education and betterment. The Western mind has learned with amazement that the aforetime *Terra Incognita* of the far East has nurtured a gigantic civilization having ideals in many ways far different from our own. The Eastern mind has proved itself capable, in

self-defence, of absorbing the essential practicalities of Western civilization within a single generation. Some of the most important problems of world-civilization of the immediate future hinge upon the mutual relations of these two long-severed communities, branched at some early stage of progress to opposite hemispheres of the globe, but now brought by the new mechanisms into daily and even hourly communication.

While the new conditions of the industrial world have thus tended to develop a new national outlook, there has come about, as a result of the scientific discoveries already referred to, a no less significant broadening of the mental and spiritual horizons. Here also the trend is away from the narrowly egoistic and towards the cosmopolitan view. About the middle of the 19th century Dr Pritchard declared that many people debated whether it might not be permissible for the Australian settlers to shoot the natives as food for their dogs; some of the disputants arguing that savages were without the pale of human brotherhood. To-day the thesis that all mankind are one brotherhood needs no defence. The most primitive of existing aborigines are regarded merely as brethren who, through some defect or neglect of opportunity, have lagged behind in the race. Similarly the defective and criminal classes that make up so significant a part of the population of even our highest present-day civilizations, are no longer regarded with anger or contempt, as beings who are suffering just punishment for wilful transgressions, but are considered as pitiful victims of hereditary and environmental influences that they could neither choose nor control. Insanity is no longer thought of as demonic possession, but as the most lamentable of diseases.

The changed attitude towards savage races and defective classes affords tangible illustrations of a fundamental transformation of point of view which doubtless represents the most important result of the operation of new scientific knowledge in the course of the 19th century. It is a transformation that is only partially effected as yet, to be sure; but it is rapidly making headway, and when fully achieved it will represent, probably, the most radical metamorphosis of mental view that has taken place in the entire course of the historical period. The essence of the new view is this: to recognize the universality and the invariability of natural law; stated otherwise, to understand that the word "supernatural" involves a contradiction of terms and has in fact no meaning. Whoever has grasped the full import of this truth is privileged to sweep mental horizons wider by far than ever opened to the view of any thinker of an earlier epoch. He is privileged to forecast, as the sure heritage of the future, a civilization freed from the last ghost of superstition—an Age of Reason in which mankind shall at last find refuge from the hosts of occult and invisible powers, the fearsome galaxies of deities and demons, which have haunted him thus far at every stage of his long journey through savagery, barbarism and civilization. Doubtless here and there a thinker, even in the barbaric eras, may have realized that these ghosts that so influenced the everyday lives of his fellows were but children of the imagination. But the certainty that such is the case could not have come with the force of demonstration even to the most clear-sighted thinker until 19th-century science had investigated with penetrating vision the realm of molecule and atom; had revealed the awe-inspiring principle of the conservation of energy; and had offered a comprehensible explanation of the evolution of one form of life from another, from monad to man, that did not presuppose the intervention of powers more "supernatural" than those that operate about us everywhere to-day.

The stupendous import of these new truths could not, of course, make itself evident to the generality of mankind in a single generation, when opposed to superstitions of a thousand generations' standing. But the new knowledge has made its way more expeditiously than could have been anticipated; and its effects are seen on every side, even where its agency is scarcely recognized. As a single illustration, we may note the familiar observation that the entire complexion of orthodox teaching of religion has been more altered in the past fifty

years than in two thousand years before. This of course is not entirely due to the influence of physical and biological science; no effect has a unique cause, in the complex sociological scheme. Archaeology, comparative philology and textual criticism have also contributed their share; and the comparative study of religions has further tended to broaden the outlook and to make for universality, as opposed to insularity, of view. It is coming to be more and more widely recognized that all theologies are but the reflex of the more or less faulty knowledge of the times in which they originate, that the true and abiding purpose of religion should be the practical betterment of humanity—the advancement of civilization in the best sense of the word; and that this end may perhaps be best subserved by different systems of theology, adapted to the varied genius of different times and divers races. Wherefore there is not the same enthusiastic desire to-day that found expression a generation ago, to impose upon the cultured millions of the East a religion that seems to them alien to their manner of thought, unsuited to their needs and less distinctly ethical in teaching than their own religions.

Such are but a few of the illustrations that might be cited from many fields to suggest that the mind of our generation is becoming receptive to a changed point of view that augurs the coming of a new ethnic era. If one may be permitted to enter very tentatively the field of prophecy, it seems not unlikely that the great revolutionary invention which will close the third period of civilization and usher in a new era is already being evolved. It seems not over-hazardous to predict that the air-ship, in one form or another, is destined to be the mechanism that will give the new impetus to human civilization; that the next era will have as one of its practical ideals the conquest of the air; and that this conquest will become a factor in the final emergence of humanity from the insularity of nationalism to the broad view of cosmopolitanism, towards which, as we have seen, the tendencies of the present era are verging. That the gap to be covered is a vastly wide one no one need be reminded who recalls that the civilized nations of Europe, together with America and Japan, are at present accustomed to spend more than three hundred million pounds each year merely that they may keep armaments in readiness to fly at one another's throats should occasion arise. Formidable as these armaments now seem, however, the developments of the not very distant future will probably make them quite obsolete; and sooner or later, as science develops yet more deadly implements of destruction, the time must come when communal intelligence will rebel at the suicidal folly of the international attitude that characterized, for example, the opening decade of the 20th century. At some time, after the first period of cosmopolitanism shall be ushered in as a tenth ethnic period, it will come to be recognized that there is a word fraught with fuller meanings even than the word patriotism. That word is humanitarianism. The enlightened generation that realizes the full implications of that word will doubtless marvel that their ancestors of the third period of civilization should have risen up as nations and slaughtered one another by thousands to settle a dispute about a geographical boundary. Such a procedure will appear to have been quite as barbarous as the cannibalistic practices of their yet more remote ancestors, and distinctly less rational, since cannibalism might sometimes save its practiser from starvation, whereas warfare of the civilized type was a purely destructive agency.

Equally obvious must it appear to the cosmopolite of some generation of the future that quality rather than mere numbers must determine the efficiency of any given community. Race suicide will then cease to be a bugbear; and it will no longer be considered rational to keep up the census at the cost of propagating low orders of intelligence, to feed the ranks of paupers, defectives and criminals. On the contrary it will be thought fitting that man should become the conscious arbiter of his own racial destiny to the extent of applying whatever laws of heredity he knows or may acquire in the interests of his own species, as he has long applied them in the case of domesticated animals. The survival and procreation of the unfit will then cease to be a menace to the progress of civilization. It does not follow that

all men will be brought to a dead level of equality of body and mind, nor that individual competition will cease; but the average physical mental status of the race will be raised immeasurably through the virtual elimination of that vast company of defectives which to-day constitutes so threatening an obstacle to racial progress. There are millions of men in Europe and America to-day whose whole mental equipment—despite the fact that they have been taught to read and write—is far more closely akin to the average of the Upper Period of Barbarism than to the highest standards of their own time; and these undeveloped or atavistic persons have on the average more offspring than are produced by the more highly cultured and intelligent among their contemporaries. "Race suicide" is thereby prevented, but the progress of civilization is no less surely handicapped. We may well believe that the cosmopolite of the future, aided by science, will find rational means to remedy this strange illogicality. In so doing he will exercise a more consciously purposeful function, and perhaps a more directly potent influence, in determining the line of human progress than he has hitherto attempted to assume, notwithstanding the almost infinitely varied character of the experiments through which he has worked his way from savagery to civilization.

All these considerations tend to define yet more clearly the ultimate goal towards which the progressive civilization of past and present appears to be trending. The contemplation of this goal brings into view the outlines of a vastly suggestive evolutionary cycle. For it appears that the social condition of cosmopolite man, so far as the present-day view can predict it, will represent a state of things, magnified to world-dimensions, that was curiously adumbrated by the social system of the earliest savage. At the very beginning of the journey through savagery, mankind, we may well believe, consisted of a limited tribe, representing no great range or variety of capacity, and an almost absolute identity of interests. Thanks to this community of interests,—which was fortified by the recognition of blood-relationship among all members of the tribe,—a principle which we now define as "the greatest ultimate good to the greatest number" found practical, even if unwitting, recognition; and therein lay the germs of all the moral development of the future. But obvious identity of interests could be recognized only so long as the tribe remained very small. So soon as its numbers became large, patent diversities of interest, based on individual selfishness, must appear, to obscure the larger harmony. And as savage man migrated hither and thither, occupying new regions and thus developing new tribes and ultimately a diversity of "races," all idea of community of interests, as between race and race, must have been absolutely banished. It was the obvious and patent fact that each race was more or less at rivalry, in disharmony, with all the others. In the hard struggle for subsistence, the expansion of one race meant the downfall of another. So far as any principle of "greatest good" remained in evidence, it applied solely to the members of one's own community, or even to one's particular phratry or gens.

Barbaric man, thanks to his conquest of animal and vegetable nature, was able to extend the size of the unified community, and hence to develop through diverse and intricate channels the application of the principle of "greatest good" out of which the idea of right and wrong was elaborated. But quite as little as the savage did he think of extending the application of the principle beyond the bounds of his own race. The laws which he gave expression to his ethical conceptions applied, of necessity, to his own people alone. The gods with which his imagination peopled the world were local in habitat, devoted to the interests of his race only, and at enmity with the gods of rival peoples. As between nation and nation, the only principle of ethics that ever occurred to him was that might makes right. Civilized man for a long time advanced but slowly upon this view of international morality. No Egyptian or Babylonian or Hebrew or Greek or Roman ever hesitated to attack a weaker nation on the ground that it would be wrong to do so. And few indeed are the instances in which even a modern nation has

judged an international question on any other basis than that of self-interest. It was not till towards the close of the 19th century that an International Peace Conference gave tangible witness that the idea of fellowship of nations was finding recognition; and in the same recent period history has recorded the first instance of a powerful nation vanquishing a weaker one without attempting to exact at least an "indemnifying" tribute.

But the citizen of the future, if the auguries of the present prove true, will be able to apply principles of right and wrong without reference to national boundaries. He will understand that the interests of the entire human family are, in the last analysis, common interests. The census through which he attempts to estimate "the greatest good of the greatest number" must include, not his own nation merely, but the remotest member of the human race. On this universal basis must be founded that absolute standard of ethics which will determine the relations of cosmopolite man with his fellows. When this ideal is attained, mankind will again represent a single family, as it did in the day when our primeval ancestors first entered on the pathway of progress; but it will be a family whose habitat has been extended from the narrow glade of some tropical forest to the utmost habitable confines of the globe. Each member of this family will be permitted to enjoy the greatest amount of liberty consistent with the like liberty of every other member; but the interests of the few will everywhere be recognized as subservient to the interests of the many, and such recognition of mutual interests will establish the practical criterion for the interpretation of international affairs.

But such an extension of the altruistic principle by no means presupposes the elimination of egoistic impulses—of individualism. On the contrary, we must suppose that man at the highest stages of culture will be, even as was the savage, a seeker after the greatest attainable degree of comfort for the least necessary expenditure of energy. *Progress and efficiency.* The pursuit of this ideal has been from first to last the ultimate impelling force in nature urging man forward. The only change has been a change in the interpretation of the ideal, an altered estimate as to what manner of things are most worth the purchase-price of toil and self-denial. That the things most worth the having cannot, generally speaking, be secured without such toil and self-denial, is a lesson that began to be inculcated while man was a savage, and that has never ceased to be reiterated generation after generation. It is the final test of progressive civilization that a given effort shall produce a larger and larger modicum of average individual comfort. That is why the great inventions that have increased man's efficiency as a worker have been the necessary prerequisites to racial progress. Stated otherwise, that is why the industrial factor is everywhere the most powerful factor in civilization; and why the economic interpretation is the most searching interpretation of history at its every stage. It is the basal fact that progress implies increased average working efficiency—a growing ratio between average effort and average achievement—that gives sure warrant for such a prognostication as has just been attempted concerning the future industrial unification of our race. The efforts of civilized man provide him, on the average, with a marvellous range of comforts, as contrasted with those that rewarded the most strenuous efforts of savage or barbarian, to whom present-day necessities would have been undreamed-of luxuries. But the ideal ratio between effort and result has by no means been achieved; nor will it have been until the inventive brain of man has provided a civilization in which a far higher percentage of citizens will find the life-vocations to which they are best adapted by nature, and in which, therefore, the efforts of the average worker may be directed with such vigour, enthusiasm and interest as can alone make for true efficiency; a civilization adjusted to such an economic balance that the average man may live in reasonable comfort without heart-breaking strain, and yet accumulate a sufficient surplus to ensure ease and serenity for his declining days. Such, seemingly, should be the normal goal of progressive civilization. Doubtless mankind in advancing towards that goal will institute many changes that could by no possibility be

foretold; but (to summarize the views just presented) it seems a safe augury from present-day conditions and tendencies that the important lines of progress will include (1) the organic betterment of the race through wise application of the laws of heredity; (2) the lessening of international jealousies and the consequent minimizing of the drain upon communal resources that attends a military régime; and (3) an ever-increasing movement towards the industrial and economic unification of the world. (H.S.Wr.)

AUTHORITIES.—A list of works dealing with the savage and barbarous periods of human development will be found appended to the article ANTHROPOLOGY. Special reference may here be made to E. B. Tylor's *Early History of Mankind* (1865), *Primitive Culture* (1871) and *Anthropology* (1881); Lord Avebury's *Prehistoric Times* (new edition, 1900) and *Origin of Civilization* (new edition, 1902); A. H. Keane's *Man Past and Present* (1899); and Lewis H. Morgan's *Ancient Society* (1877). The earliest attempt at writing a history of civilization which has any value for the 20th-century reader was F. Guizot's in 1828-1830, a handy English translation by William Hazlitt being included in Bohn's Standard Library under the title of *The History of Civilization*. The earlier lectures, delivered at the Old Sorbonne, deal with the general progress of European civilization, whilst the greater part of the work is an account of the growth of civilization in France. Guizot's attitude is somewhat antiquated, but this book still has usefulness as a store-house of facts. T. H. Buckle's famous work, *The History of Civilization in England* (1857-1861), though only a gigantic unfinished introduction to the author's proposed enterprise, holds an important place in historical literature on account of the new method which it introduced, and has given birth to a considerable number of valuable books on similar lines, such as Lecky's *History of European Morals* (1869) and *Rise and Influence of Rationalism in Europe* (1865). J. W. Draper's *History of the Intellectual Development of Europe* (1861) undertook, from the American stand-point, "the labour of arranging the evidence offered by the intellectual history of Europe in accordance with physiological principles, so as to illustrate the orderly progress of civilization." Its objective treatment and wealth of learning still give it great value to the student. Since the third quarter of the 19th century it may be said that all serious historical work has been more or less a history of civilization as displayed in all countries and ages, and a bibliography of the works bearing on the subject would be coextensive with the catalogue of a complete historical library. Special mention, however, may be made of such important and suggestive works as C. H. Pearson's *National Life and Character* (1893); Benjamin Kidd's *Social Evolution* (1894) and *Principles of Western Civilization* (1902); Edward Eggleston's *Transit of Civilization* (1901); C. Seignobos's *Histoire de la civilisation* (1887); C. Faulmann's *Illustrirte Culturgeschichte* (1881); G. Ducoudray's *Histoire de la civilisation* (1886); J. von Hellwald's *Kulturgeschichte* (1896); J. Lippert's *Kulturgeschichte der Menschheit* (1886); O. Henne-am-Rhyn's *Die Kultur der Vergangenheit, Gegenwart und Zukunft* (1890); G. Kurth's *Origines de la civilisation moderne* (1886), &c. The vast collection of modern works on sociology, from Herbert Spencer onwards, should also be consulted; see bibliography attached to the article SOCIOLOGY. The historical method on which practically all the articles of the present edition of the *Ency. Brit.* are planned, makes the whole work itself in essentials the most comprehensive history of civilization in existence.

CIVIL LAW, a phrase which, with its Latin equivalent *jus civile*, has been used in a great variety of meanings. *Jus civile* was sometimes used to distinguish that portion of the Roman law which was the proper or ancient law of the city or state of Rome from the *jus gentium*, or the law common to all the nations comprising the Roman world, which was incorporated with the former through the agency of the praetorian edicts. This historical distinction remained as a permanent principle of division in the body of the Roman law. One of the first propositions of the Institutes of Justinian is the following:—"Jus autem civile vel gentium ita dividitur. Omnes populi qui legibus et moribus reguntur partim suo proprio, partim communi omnium hominum jure utuntur; nam quod quisque populus ipsi sibi jus constituit, id ipsius civitatis proprium est, vocaturque jus civile quasi jus proprium ipsius civitatis. Quod vero naturalis ratio inter omnes homines constituit, id apud omnes peraeque custoditur, vocaturque jus gentium quasi quo jure omnes gentes utuntur." The *jus gentium* of this passage is elsewhere identified with *jus naturale*, so that the distinction comes to be one between civil law and natural or divine law. The municipal or private law of a state is sometimes described as civil law in distinction to public or international law. Again, the municipal law of a state may be divided into civil law and criminal law. The phrase, however,

is applied *par excellence* to the system of law created by the genius of the Roman people, and handed down by them to the nations of the modern world (see ROMAN LAW). The civil law in this sense would be distinguished from the local or national law of modern states. The civil law in this sense is further to be distinguished from that adaptation of its principles to ecclesiastical purposes which is known as the canon law (*q.v.*).

CIVIL LIST, the English term for the account in which are contained all the expenses immediately applicable to the support of the British sovereign's household and the honour and dignity of the crown. An annual sum is settled by the British parliament at the beginning of the reign on the sovereign, and is charged on the consolidated fund. But it is only from the reign of William IV. that the sum thus voted has been restricted solely to the personal expenses of the crown. Before his accession many charges properly belonging to the ordinary expenses of government had been placed on the civil list. The history of the civil list dates from the reign of William and Mary. Before the Revolution no distinction had been made between the expenses of government in time of peace and the expenses relating to the personal dignity and support of the sovereign. The ordinary revenues derived from the hereditary revenues of the crown, and from certain taxes voted for life to the king at the beginning of each reign, were supposed to provide for the support of the sovereign's dignity and the civil government, as well as for the public defence in time of peace. Any saving made by the king in the expenditure touching the government of the country or its defence would go to swell his privy purse. But with the Revolution a step forward was made towards the establishment of the principle that the expenses relating to the support of the crown should be separated from the ordinary expenses of the state. The evils of the old system under which no appropriation was made of the ordinary revenue granted to the crown for life had been made manifest in the reigns of Charles II. and James II.; it was their control of these large revenues that made them so independent of parliament. Moreover, while the civil government and the defences suffered, the king could use these revenues as he liked. The parliament of William and Mary fixed the revenue of the crown in time of peace at £1,200,000 per annum; of this sum about £700,000 was appropriated towards the "civil list." But from this the sovereign was to defray the expenses of the civil service and the payment of pensions, as well as the cost of the support of the royal household and his own personal expenses. It was from this that the term "civil list" arose, to distinguish it from the statement of military and naval charges. The revenue voted to meet the civil list consisted of the hereditary revenues of the crown and a part of the excise duties. Certain changes and additions were made in the sources of revenue thus appropriated between the reign of William and Mary and the accession of George III., when a different system was adopted. Generally speaking, however, the sources of revenue remained as settled at the Revolution.

Anne had the same civil list, estimated to produce an annual income of £700,000. During her reign a debt of £1,200,000 was incurred. This debt was paid by parliament and charged on the civil list itself. George I. enjoyed the same revenue by parliamentary grant, in addition to an annual sum of £120,000 on the aggregate fund. A debt of £1,000,000 was incurred, and discharged by parliament in the same manner as Anne's debt had been. To George II. a civil list of £800,000 as a minimum was granted, parliament undertaking to make up any deficiency if the sources of income appropriated to its service fell short of that sum. Thus in 1746 a debt of £456,000 was paid by parliament on the civil list. On the accession of George III. a change was made in the system of the civil list. Hitherto the sources of revenue appropriated to the service of the civil list had been settled on the crown. If these revenues exceeded the sum they were computed to produce annually, the surplus went to the king. George III., however, surrendered the life-interest in the hereditary revenues and the excise duties hitherto voted to defray

History.

Anne,
George I.
and
George II.

George III.

the civil list expenditure, and any claim to a surplus for a fixed amount. The king still retained other large sources of revenue which were not included in the civil list, and were free from the control of parliament. The revenues from which the civil list had been defrayed were henceforward to be carried into, and made part of, the aggregate fund. In their place a fixed civil list was granted—at first of £723,000 per annum, to be increased to £800,000 on the falling in of certain annuities to members of the royal family. From this £800,000 the king's household and the honour and dignity of the crown were to be supported, as well as the civil service offices, pensions and other charges still laid on the list.

During the reign of George III. the civil list played an important part in the history of the struggle on the part of the king to establish the royal ascendancy. From the revenue appropriated to its service came a large portion of the money employed by the king in creating places and pensions for his supporters in parliament, and, under the colour of the royal bounty, bribery was practised on a large scale. No limit was set to the amount applicable to the pensions charged on the civil list, so long as the sum granted could meet the demand; and there was no principle on which the grant was regulated. Secret pensions at the king's pleasure were paid out of it, and in every way the independence of parliament was menaced; and though the more legitimate expenses of the royal household were diminished by the king's penurious style of living, and though many charges not directly connected with the king's personal expenditure were removed, the amount was constantly exceeded, and applications were made from time to time to parliament to pay off debts incurred; and thus opportunity was given for criticism. In 1769 a debt of £513,511 was paid off in arrears; and in spite of the demand for accounts and for an inquiry into the cause of the debt, the

*Indebted-
ness of
civil list.*

ministry succeeded in securing this vote without granting such information. All attempts to investigate the civil list were successfully resisted, though Lord

Chatham went so far as to declare himself convinced that the funds were expended in corrupting members of parliament. Again, in 1777, an application was made to parliament to pay off £618,340 of debts; and in view of the growing discontent Lord North no longer dared to withhold accounts. Yet, in spite of strong opposition and free criticism, not only was the amount voted, but also a further £100,000 per annum, thus raising the civil list to an annual sum of £900,000.

In 1779, at a time when the expenditure of the country and the national debt had been enormously increased by the American War, the general dissatisfaction found voice in parliament, and the abuses of the civil list were specially singled out for attack. Many petitions were presented to the House of Commons praying for its reduction, and a motion was made in the House of Lords in the same sense, though it was rejected. In 1780 Burke brought forward his scheme of economic reform, but his name was already associated with the growing desire to remedy the evils of the civil list by the publication in 1769 of his pamphlet on "The Causes of the Present Discontent." In this scheme Burke freely animadverts on the profusion and abuse of the civil list, criticizing the useless and obsolete offices and the offices performed by deputy. In every department he discovers jobbery, waste and peculation. His proposal was that the many offices should be reduced and consolidated, that the pension list should be brought down to a fixed sum of £60,000 per annum, and that pensions should be conferred only to reward merit or fulfil real public charity. All pensions were to be paid at the exchequer. He proposed also that the civil list should be divided into classes, an arrangement which later was carried into effect. In 1780 Burke succeeded in bringing in his Establishment Bill; but though at first it met with considerable support, and was even read a second time, Lord North's government defeated it in committee. The next year the bill was again introduced into the House of Commons, and Pitt made his first speech in its favour. The bill was, however, lost on the second reading.

In 1782 the Rockingham ministry, pledged to economic

reform, came into power; and the Civil List Act 1782 was introduced and carried with the express object of limiting the patronage and influence of ministers, or, in other words, the ascendancy of the crown over parliament. Not only did the act effect the abolition of a number of useless offices, but it also imposed restraints on the issue of secret service money, and made provision for a more effectual supervision of the royal expenditure. As to the pension list, the annual amount was to be limited to £95,000; no pension to any one person was to exceed £1200, and all pensions were to be paid at the exchequer, thus putting a stop to the secret pensions payable during pleasure. Moreover, pensions were only to be bestowed in the way of royal bounty for persons in distress or as a reward for merit. Another very important change was made by this act: the civil list was divided into classes, and a fixed amount was to be appropriated to each class. The following were the classes:—

1. Pensions and allowances of the royal family.
2. Payment of salaries of lord chancellor, speaker and judges.
3. Salaries of ministers to foreign courts resident at the same.
4. Approved bills of tradesmen, artificers and labourers for any article supplied and work done for His Majesty's service.
5. Menial servants of the household.
6. Pension list.
7. Salaries of all other places payable out of the civil list revenues.
8. Salaries and pensions of treasurer or commissioners of the treasury and of the chancellor of the exchequer.

Yet debt was still the condition of the civil list down to the end of the reign, in spite of the reforms established by the Rockingham ministry, and notwithstanding the removal from the list of many charges unconnected with the king's personal expenses. The debts discharged by parliament between 1782, the date of the passing of the Civil List Act, and the end of George III.'s reign, amounted to £2,300,000. In all, during his reign £3,308,061 of debt owing by the civil list was paid off.

With the regency the civil list was increased by £70,000 per annum, and a special grant of £100,000 was settled on the prince regent. In 1816 the annual amount was settled at £1,083,727, including the establishment of the king, now insane; though the civil list was relieved from some annuities payable to the royal family. Nevertheless, the fund still continued charged with such civil expenses as the salaries of judges, ambassadors and officers of state, and with pensions granted for public services. Other reforms were made as regards the definition of the several classes of expenditure, while the expenses of the royal household were henceforth to be audited by a treasury official—the auditor of the civil list. On the accession of George IV. the civil list, freed from the expenses of the late king, was settled at £845,727. On William IV. coming to the throne a sum of £510,000 per annum was fixed for the service of the civil list. The king at the same time surrendered all the sources of revenue enjoyed by his predecessors, apart from the civil list, represented by the hereditary revenues of Scotland—the Irish civil list, the droits of the crown and admiralty, the 4½% duties, the West India duties, and other casual revenues hitherto vested in the crown, and independent of parliament. The revenues of the duchy of Lancaster were still retained by the crown. In return for this surrender and the diminished sum voted, the civil list was relieved from all the charges relating rather to the civil government than to the support of the dignity of the crown and the royal household. The future expenditure was divided into five classes, and a fixed annual sum was appropriated to each class. The pension list was reduced to £75,000. The king resisted an attempt on the part of the select committee to reduce the salaries of the officers of state on the grounds that this touched his prerogative, and the ministry of Earl Grey yielded to his remonstrance.

The civil list of Queen Victoria was settled on the same principles as that of William IV. A considerable reduction was made in the aggregate annual sum voted, from £510,000 to £385,000, and the pension list was separated from the ordinary civil list. The civil list proper was divided into the following five classes, with a fixed sum appropriated to each:—

*Queen
Victoria's
civil list.*

Privy purse	£60,000
Salaries of household	131,260
Expenses of household	172,500
Royal bounty, &c.	13,200
Unappropriated	8,040

In addition the queen might, on the advice of her ministers, grant pensions up to £1200 per annum, in accordance with a resolution of the House of Commons of February 18th, 1834, "to such persons as have just claims on the royal beneficence or who, by their personal services to the crown, by the performance of duties to the public, or by their useful discoveries in science and attainments in literature and art, have merited the gracious consideration of the sovereign and the gratitude of their country." The service of these pensions increased the annual sum devoted to support the dignity of the crown and the expenses of the household to about £409,000. The list of pensions must be laid before parliament within thirty days of 20th June. Thus the civil list was reduced in amount, and relieved from the very charges which gave it its name as distinct from the statement of military and naval charges. It now really only dealt with the support of the dignity and honour of the crown and the royal household. The arrangement was most successful, and during the last three reigns there was no application to parliament for the discharge of debts incurred on the civil list.

The death of Queen Victoria rendered it necessary that a renewed provision should be made for the civil list; and King Edward VII., following former precedents, placed unreservedly at the disposal of parliament his hereditary revenues. A select committee of the House of Commons was appointed to consider the provisions of the civil list for the crown, and to report also on the question of grants for the honourable support and maintenance of Her Majesty the Queen and the members of the royal family. The committee in their conclusions were guided to a considerable extent by the actual civil list expenditure during the last ten years of the last reign, and made certain recommendations which, without undue interference with the sovereign's personal arrangements, tended towards increased efficiency and economy in the support of the sovereign's household and the honour and dignity of the crown. On their report was based the Civil List Act 1901, which established the new civil list. The system that the hereditary revenues should as before be paid into the exchequer and be part of the consolidated fund was maintained. The amount payable for the civil list was increased from £385,000 to £470,000. In the application of this sum the number of classes of expenditure to which separate amounts were to be appropriated was increased from five to six. The following was the new arrangement of classes:—1st class, Their Majesties' privy purse, £110,000; 2nd class, salaries of His Majesty's household and retired allowances, £125,800; 3rd class, expenses of His Majesty's household, £193,000; 4th class, works (the interior repair and decoration of Buckingham Palace and Windsor Castle), £20,000; 5th class, royal bounty, alms and special services, £13,200; 6th class, unappropriated, £8000. The system relating to civil list pensions, established by the Civil List Act 1837, continued to apply, but the pensions were not regarded as chargeable on the sum paid for the civil list. The committee also advised that the mastership of the Buckhounds should not be continued; and the king, on the advice of his ministers, agreed to accept their recommendation. The maintenance of the royal hunt thus ceased to be a charge on the civil list. The annuities of £20,000 to the prince of Wales, of £10,000 to the princess of Wales, and of £18,000 to His Majesty's three daughters, were not included in the civil list, though they were conferred by the same act. Other grants made by special acts of parliament to members of the royal family were also excluded from it; these were £6000 to the princess Christian of Schleswig-Holstein, £6000 to the princess Louise (duchess of Argyll), £25,000 to the duke of Connaught, £6000 to the duchess of Albany, £6000 to the princess Beatrice (Henry of Battenberg), and £3000 to the duchess of Mecklenburg-Strelitz.

It may be interesting to compare with the British civil list the corresponding figures in other countries. These are as follows,

the figures being those, for convenience, of 1905. Spain, £280,000, exclusive of allowances to members of the royal family; Portugal, £97,333, in addition to £1333 to the queen-consort—total grant to the royal family, £116,700; Italy, £602,000, from which was deducted £16,000 for the children of the deceased Prince Amedeo, duke of Aosta, £16,000 to Prince Tommaso, duke of Genoa, and £40,000 to Queen Margherita; Belgium, £140,000; Netherlands, £50,000, with, in addition, £4000 for the maintenance of the royal palaces; Germany, £770,500 (*Kronrenten Rente*), the sovereign also possessing large private property (*Kronfideikommiss und Schatullgüter*), the revenue from which contributed to the expenditure of the court and the members of the royal family; Denmark, £55,500, in addition to £6600 to the heir-apparent; Norway, £38,888; Sweden, £72,700; Greece, £52,000, which included £4000 each from Great Britain, France and Russia; Austria-Hungary, £941,666, made up of £387,500 as emperor of Austria out of the revenues of Austria, and £554,166 as king of Hungary out of the revenues of Hungary; Japan, £300,000; Rumania, £47,000, in addition to revenues from certain crown lands; Servia, £48,000; Bulgaria, £40,000, besides £30,000 for maintenance of palaces, &c.; Montenegro, £8300; Russia had no civil list, the sovereign having all the revenue from the crown domains (actual amount unknown, but supposed to amount to over £4,000,000); the president of the French Republic had a salary of £24,000 a year, with a further £24,000 for expenses; and the president of the United States had a salary of \$50,000 (from 1909, \$75,000).

Figures in other countries.

CIVIL SERVICE, the generic name given to the aggregate of all the public servants, or paid civil administrators and clerks, of a state. It is the machinery by which the executive, through the various administrations, carries on the central government of the country.

British Empire.—The appointments to the civil service until the year 1855 were made by nomination, with an examination not sufficient to form an intellectual or even a physical test. It was only after much consideration and almost years of discussion that the nomination system was abandoned. Various commissions reported on the civil service, and orders in council were issued. Finally in 1855 a qualifying examination of a stringent character was instituted, and in 1870 the principle of open competition was adopted as a general rule. On the report of the Playfair Commission (1876), an order in council was issued dividing the civil service into an upper and lower division. The order in council directed that a lower division should be constituted, and men and boy clerks holding permanent positions replaced the temporary assistants and writers. The "temporary" assistant was not found to be advantageous to the service. In December 1886 a new class of assistant clerks was formed to replace the men copyists. In 1887 the Ridley Commission reported on the civil service establishment. In 1890 two orders in council were issued based on the reports of the Ridley Commission, which sat from 1886 to 1890. The first order constituted what is now known as the second division of the civil service. The second order in council concerned the officers of the 1st class, and provision was made for the possible promotion of the second division clerks to the first division after eight years' service.

The whole system is under the administration of the civil service commissioners, and power is given to them, with the approval of the treasury, to prescribe the subjects of examination, limits of age, &c. The age is fixed for compulsory retirement at sixty-five. In exceptional cases a prolongation of five years is within the powers of the civil service commissioners. The examination for 1st class clerkships is held concurrently with that of the civil service of India and Eastern cadetships in the colonial service. Candidates can compete for all three or for two. In addition to the intellectual test the candidate must fulfil the conditions of age (22 to 24), must present recommendations as to character, and pass a medical examination. This examination approximates closely to the university type of education. Indeed, there is little chance of success except for candidates who have had a successful university career, and frequently, in addition, special preparation by a private teacher. The subjects include the language and literature of England, France, Germany, Italy, ancient Greece and Rome, Sanskrit and Arabic, mathematics (pure and applied), natural science (chemistry, physics, zoology, &c.), history (English, Greek, Roman and general modern), political economy and

economic history, mental and moral philosophy, Roman and English law and political science. The candidate is obliged to reach a certain standard of knowledge in each subject before any marks at all are allowed him. This rule was made to prevent success by mere cramming, and to ensure competent knowledge on the basis of real study.

The maximum scale of the salaries of clerks of Class I. is as follows:—3rd class, £200 a year, increasing by £20 a year to £500; 2nd class, £600, increasing by £25 a year to £800; 1st class, £850, increasing by £50 a year to £1000. Their pensions are fixed by the Superannuation Act 1859, 22 Vict. c. 26:—

"To any person who shall have served ten years and upwards, and under eleven years, an annual allowance of ten-sixtieths of the annual salary and emoluments of his office:

"For eleven years and under twelve years, an annual allowance of eleven-sixtieths of such salary and emoluments.

"And in like manner a further addition to the annual allowance of one-sixtieth in respect of each additional year of such service, until the completion of a period of service of forty years, when the annual allowance of forty-sixtieths may be granted; and no additions shall be made in respect of any service beyond forty years."

The "ordinary annual holidays allowed to officers" (1st class) "shall not exceed thirty-six week-days during each of their first ten years of service and forty-eight week-days thereafter." Order in Council, 15th August 1890.

"Within that maximum heads of departments have now, as they have hitherto had, an absolute discretion in fixing the annual leave."

Sick leave can be granted on full salary for not more than six months, on half-salary for another six months.

The scale of salary for 2nd division clerks begins at £70 a year, increasing by £5 to £100; then £100 a year, increasing by £7, 10s. to £190; and then £190 a year, increasing by £10 to £250. The highest is £300 to £500. Advancement in the 2nd division to the higher ranks depends on merit, not seniority. The ordinary annual holiday of the 2nd division clerks is 14 working days for the first five years, and 21 working days afterwards. They can be allowed sick leave for six months on full pay and six months on half-pay. The subjects of their examination are: (1) handwriting and orthography, including copying MS.; (2) arithmetic; (3) English composition; (4) *précis*, including indexing and digest of returns; (5) book-keeping and shorthand writing; (6) geography and English history; (7) Latin; (8) French; (9) German; (10) elementary mathematics; (11) inorganic chemistry with elements of physics. Not more than four of the subjects (4) to (11) can be taken. The candidate must be between the ages of 17 and 20. A certain number of the places in the 2nd division were reserved for the candidates from the boy clerks appointed under the old system. The competition is severe, only about one out of every ten candidates being successful. Candidates are allowed a choice of departments subject to the exigencies of the services.

There is also a class of boy copyists who are almost entirely employed in London, a few in Dublin and Edinburgh, and, very seldom, in some provincial towns. The subjects of their examination are. *Obligatory*—handwriting and orthography, arithmetic and English composition. *Optional*—(any two of the following). (1) copying MS.; (2) geography; (3) English history, (4) translation from one of the following languages—Latin, French or German; (5) Euclid, bk. i. and ii., and algebra, up to and including simple equations; (6) rudiments of chemistry and physics. Candidates must be between the ages of 15 and 18. They have no claims to superannuation or compensation allowance. Boy copyists are not retained after the age of 20.

Candidates for the civil service of India take the same examination as for 1st class clerkships. Candidates successful in the examination must subsequently spend one year in England. They receive for that year £150 if they elect to live at one of the universities or colleges approved by the secretary of state for India. They are submitted to a final examination in the following subjects—Indian Penal Code and the Code of Criminal Procedure, the principal vernacular language of the province to which they are assigned, the Indian Evidence Act (these three subjects are compulsory), either Hindu and Mahomedan Law, or Sanskrit, Arabic or Persian, Burmese (for Burma only). A candidate may not take Arabic or Sanskrit both in the first examination and in the final. They must also pass a thorough examination in riding.

On reaching India their salary begins at 400 rupees a month. They may take, as leave, one-fourth of the time on active service in periods strictly limited by regulation. After 25 years' service (of which 21 must be active service) they can retire on a pension of £1000 a year. The unit of administration is the district. At the head of the district is an executive officer called either collector-magistrate or deputy-commissioner. In most provinces he is responsible to the commissioner, who corresponds directly with the provincial government. The Indian civilian after four years' probation in both branches of the service is called upon to elect whether he will enter the revenue or judicial department, and this choice as a rule is held to be final for his future work.

Candidates for the Indian Forest Service have to pass a competitive examination, one of the compulsory subjects being German or French. They have also to pass a severe medical examination, especially in their powers of vision and hearing. They must be between the ages of 18 and 22. Successful candidates are required to pass a three years' course, with a final examination, seven terms of the course at an approved school of forestry, the rest of the time receiving practical instruction in continental European forests. On reaching India they start as assistant conservators at 380 rupees a month. The highest salary, that of inspector-general of forests, in the Indian Forest Service is 2650 rupees a month.

The Indian Police Service is entered by a competitive examination of very much the same kind as for the forest service, except that special subjects such as German and botany are not included. The candidates are limited in age to 19 and 21. They must pass a riding examination. A free passage out is given them. They are allotted as probationers, their wishes being consulted as far as possible as to their province. A probationer receives 300 rupees a month. A district superintendent can rise to 1200 rupees a month, while there are a few posts with a salary of 3000 rupees a month in the police service. The leave and pension in both these departments follow the general rules for Indian services.

The civil service also includes student interpreterships for China, Japan and Siam, and for the Ottoman dominions, Persia, Greece and Morocco. Both these classes of student interpreters are selected by open competition. Their object is to supply the consular service in the above-named countries with persons having a thorough knowledge of the language of the country in which they serve.

In the first case, China, Japan, &c., they learn their language in the country itself, receiving £200 as probationers. Then they become assistants in a consulate. The highest post is that of consul-general. In the case of student interpreters for the Ottoman dominions, Persia, Greece and Morocco, the successful candidates learn their languages at Oxford. Turkish is taught gratuitously, but they pay the usual fees for other languages. At Oxford they receive £200 a year for two years. On leaving Oxford they become assistants under the embassy at Constantinople, the legations at Teheran, Athens or Morocco, or at one of H.B.M. consulates. As assistants they receive £300 a year. The consuls, the highest post to which they can reach, receive in the Levant from £500 to £1600 a year. The civil services of Ceylon, Hong-Kong, the Straits Settlements, and the Malay Peninsula are supplied by the Eastern cadetships. The limits of age for the examination are 18 and 24. The cadets are required to learn the native language of the colony or dependency to which they are assigned. In the case of the Straits Settlements and Malay cadets they may have to learn Chinese or Tamil, as well as the native language. The salaries are: passed cadets, 3500 rupees per annum, gradually increasing until first-class officers receive from 12,000 to 18,000 rupees per annum. They are allowed three months' vacation on full pay in two years, and leave of absence on half-pay after six years' service, or before that if urgently needed. They can retire for ill-health after ten years with fifteen-sixtieths of their annual salary. Otherwise they can add one-sixtieth of their annual salary to their pension for every additional year's service up to thirty-five years' service.

In spite of the general rule of open competition, there are still a few departments where the system of *nomination* obtains, accompanied by a severe test of knowledge, either active or implied. Such are the foreign office, British Museum, and board of education.

The employment of women in the civil service has been principally developed in the post office. Women are employed in the post office as female clerks, counter clerks, telegraphists, returners, sorters and post-mistresses all over the United Kingdom. The board of agriculture, the customs and the India office employ women. The department of agriculture, the board of education generally, the local government board, all to a certain

extent employ women, whilst in the home office there are an increasing number of women inspectors of workshops and factories.

In 1881 the postmaster-general took a decided step in favour of female employment, and with the consent of the treasury instituted female clerkships. Female clerks do not come in contact with the public. Their duties are purely clerical, and entirely in the accountant-general's department at the savings bank. Their leave is one month per annum; their pension is on the ordinary civil service scale. The examination is competitive; the subjects are handwriting and spelling, arithmetic, English composition, geography, English history, French or German. Candidates must be between the ages of 18 and 20. Whether unmarried or widows they must resign on marriage. The class of girl clerks take the same subjects in a competitive examination. They must be between the ages of 16 and 18; they serve only in the Savings Bank department. If competent they can pass on later to female clerkships. The salaries of the female clerkships range from £200 to £500 in the higher grade, £55 to £190 in the 2nd class, whilst girl clerks are paid from £35 to £40, with the chance of advancement to higher posts.

United States.—Civil service reform, like other great administrative reforms, began in America in the latter half of the 19th century. Personal and partisan government, with all the entailed evils of the patronage system, culminated in Great Britain during the reign of George III., and was one of the efficient causes of the American revolution. Trevelyan characterizes the use of patronage to influence legislation, and the giving of colonial positions as sinecures to the privileged classes and personal favourites of the administration, by saying, "It was a system which, as its one achievement of the first order, brought about the American War, and made England sick, once and for all, of the very name of personal government." It was natural that the founders of the new government in America, after breaking away from the mother-country, should strive to avoid the evils which had in a measure brought about the revolution. Their intention that the administrative officers of the government should hold office during good behaviour is manifest, and was given thorough and practical effect by every administration during the first forty years of the life of the government. The constitution fixed no term of office in the executive branch of the government except those of president and vice-president; and Madison, the expounder of the constitution, held that the wanton removal of a meritorious officer was an impeachable offence. Not until nine years after the passage of the Four Years' Tenure of Office Act in 1820 was there any material departure from this traditional policy of the government. This act (suggested by an appointing officer who wished to use the power it gave in order to secure his own nomination for the presidency, and passed without debate and apparently without any adequate conception of its full effect) opened the doors of the service to all the evils of the "spoils system." The foremost statesmen of the time were not slow to perceive the baleful possibilities of this legislation, Jefferson,¹ Webster, Clay, Calhoun, Benton and many others being recorded as condemning and deploring it in the strongest terms. The transition to the "spoils system" was not, however, immediate, and for the next nine years the practice of reappointing all meritorious officers was practically universal; but in 1829 this practice ceased, and the act of 1820 lent the sanction of law to the system of

proscriptions which followed, which was a practical application of the theory that "to the victor belong the spoils of the enemy." In 1836 the provisions of this law, which had at first been confined mainly to officers connected with the collection of revenue, were extended to include also all postmasters receiving a compensation of \$1000 per annum or more. It rapidly became the practice to regard all these four years' tenure offices as agencies not so much for the transaction of the public business as for the advancement of political ends. The revenue service from being used for political purposes merely came to be used for corrupt purposes as well, with the result that in one administration frauds were practised upon the government to the extent of \$75,000,000. The corrupt-

¹ See letter to Monroe, November 29th, 1820, Jefferson's *Writings*, vii. 190. A quotation from this letter is given at p. 454 of the *Fifteenth Report of the U.S. Civil Service Commission*.

ing influences permeated the whole body politic. Political retainers were selected for appointment not on account of their ability to do certain work but because they were followers of certain politicians; these "public servants" acknowledged no obligation except to those politicians, and their public duties, if not entirely disregarded, were negligently and inefficiently performed. Thus grew a saturnalia of spoils and corruption which culminated in the assassination of a president.

Acute conditions, not theories, give rise to reforms. In the congressional election of November 1882, following the assassination of President Garfield as an incident in the operation of the spoils system, the voice of the people commanding reform was unmistakable. Congress assembled in December 1882, and during the same month a bill looking to the improvement of the civil service, which had been pending in the Senate for nearly two years, was finally taken up and considered by that body. In the debate upon this bill its advocates declared that it would "vastly improve the whole civil service of the country," which they characterized as being at that time "inefficient, expensive and extravagant, and in many instances corrupt."² This bill passed the Senate on the 27th of December 1882, and the House on the 4th of January 1883, and was signed by the president on the 16th of January 1883, coming into full operation on the 16th of July 1883. It is now the national civil service law. The fundamental principles of this law are:—(1) selection by competitive examination for all appointments to the "classified service," with a period of probationary service before absolute appointment; (2) apportionment among the states and territories, according to population, of all appointments in the departmental service at Washington; (3) freedom of all the employees of the government from any necessity to contribute to political campaign funds or to render political services. For putting these principles into effect the Civil Service Commission was created, and penalties were imposed for the solicitation or collection from government employees of contributions for political purposes, and for the use of official positions in coercing political action. The commission, in addition to its regular duties of aiding in the preparation of civil service rules, of regulating and holding examinations, and certifying the results thereof for use in making appointments, and of keeping records of all changes in the service, was given authority to investigate and report upon any violations of the act or rules. The "classified" service to which the act applies has grown, by the action of successive presidents in progressively including various branches of the service within it, from 13,924 positions in 1883 to some 80,000 (in round numbers) in 1900, constituting about 40% of the entire civil service of the government and including practically all positions above the grade of mere labourer or workman to which appointment is *not* made directly by the president with the consent of the Senate.³ A very large class to which the act is expressly applicable, and which has been partly brought within its provisions by executive action, is that of fourth-class postmasters, of whom there are between 70,000 and 80,000 (about 15,000 classified in 1909).

In order to provide registers of eligibles for the various grades of positions in the classified service, the United States Civil Service Commission holds annually throughout the country about 300 different kinds of examinations. In the work of preparing these examinations and of marking the papers of competitors in them the commission is authorized by law to avail itself, in addition to its own corps of trained men, of the services of the scientific and other experts in the various executive departments. In the work of holding the examinations it is aided by about 1300 local boards of examiners, which are its local representatives throughout the country and are

² See *Senate Report No. 576*, 47th Congress, 1st session; also *U.S. Civil Service Commission's Third Report*, p. 16 et seq., *Tenth Report*, pp. 136, 137, and *Fifteenth Report*, pp. 483, 484.

³ The progressive classification of the executive civil service, showing the growth of the merit system, is discussed, with statistics, in the *U.S. Civil Service Commission's Sixteenth Report*, pp. 129-137. A revision of this discussion, with important additions, appears in the *Seventeenth Report*.

located at the principal post offices, custom houses and other government offices, being composed of three or more Federal employees in those offices. About 50,000 persons annually compete in these examinations, and about 10,000 of those who are successful receive appointments through regular certification. Persons thus appointed, however, must serve six months "on probation" before their appointment can be made absolute. At the end of this probation, if his service has not been satisfactory, the appointee is simply dropped; and the fact that less than 1% of those appointed prove thus deficient on trial is high testimony to the practical nature of the examinations held by the commission, and to their aptness for securing persons qualified for all classes of positions.

The effects of the Civil Service Act within the scope of its actual operation have amply justified the hopes and promises of its advocates. After its passage, absentee holders of lucrative appointments were required to report for duty or to sever their connexion with the service. Improved methods were adopted in the departments, and superfluous and useless work was no longer devised in order to provide a show of employment and a *locus standi* for the parasites upon the public service. Individual clerks were required, and by reason of the new conditions were enabled, to do more and better work; and this, coupled with the increase in efficiency in the service on account of new blood coming in through the examinations, made possible an actual decrease in the force required in many offices, notwithstanding the natural growth in the amount of work to be done.¹ Experience proves that the desire to create new and unnecessary positions was in direct proportion to the power to control them, for where the act has taken away this power of control the desire had disappeared naturally. There is no longer any desire on the part of heads of departments to increase the number or salaries of classified positions which would fall by law within the civil service rules and be subject to competitive examinations. Thus the promises of improvement and economy in the service have been fulfilled.

The chief drawback to the full success of the act within its intended scope of operation has been the withholding of certain positions in the service from the application of the vital principle of competition. The Civil Service Act contemplated no exceptions, within the limits to which it was made applicable, to the general principle of competition upon merit for entrance to the service. In framing the first civil service rules, however, in 1883, the president, yielding to the pressure of the heads of some of the departments, and against the urgent protest of the Civil Service Commission, excepted from the requirement of examination large numbers of positions in the higher grades of the service, chiefly fiduciary and administrative positions such as cashiers, chief clerks and chiefs of division. These positions being thus continued under the absolute control of the appointing officer, the effect of their exception from examination was to retain just that much of the old or "spoils" system within the nominal jurisdiction of the new or "merit" system. Even more: under the old system, while appointments from the outside had been made regardless of fitness, still those appointments had been made in the lower grades, the higher positions being filled by promotion within the service, usually of the most competent, but under the new system with its exceptions, while appointments to the lower grades were filled on the basis of merit, the pressure for spoils at each change of administration forced inexperienced, political or personal favourites in at the top. This blocked promotions and demoralized the service. Thus, while the general effect of the act was to limit very greatly the number of vicious appointments, at the same time the effect of these exceptions was to confine them to the upper grades, where the demoralizing effect of each upon the service would be a maximum. By constant efforts the Civil Service Commission succeeded in having position after position withdrawn from this excepted class, until by the action of the president, on the 6th of May 1896, it was finally reduced almost to a minimum. By subsequent

¹ For details justifying these statements, see *U.S. Civil Service Commission's Fourteenth Report*, pp. 12-14.

presidential action, however, on the 29th of May 1899, the excepted class was again greatly extended.²

A further obstacle to the complete success of the merit system, and one which prevents the carrying forward of the reform to the extent to which it has been carried in Great Britain, is inherent in the Civil Service Act itself. All postmasters who receive compensation of \$1000 or more per annum, and all collectors of customs and collectors of internal revenue, are appointed by the president and confirmed by the Senate, and are therefore, by express provision of the act, not "required to be classified." The universal practice of treating these offices as political agencies instead of as administrative business offices is therefore not limited by the act. Such officers are active in political work throughout the country, and their official position adds greatly to their power to affect the political prospects of the leaders in their districts. Accordingly the Senate, from being, as originally intended, merely a confirming body as to these officers, has become in a large measure, actually if not formally, a nominating body, and holds with tenacity to the power thus acquired by the individual senators. Thorough civil service reform requires that these positions also, and all those of fourth-class postmasters (partly classified by order of 1st Dec. 1908), be made subject to the merit system, for in them is the real remaining stronghold of the spoils system. Even though all their subordinates be appointed through examination, it will be impossible to carry the reform to ultimate and complete success so long as the officers in charge are appointed mainly for political reasons and are changed with every change of administration.

The purpose of the act to protect the individual employees in the service from the rapacity of the "political barons" has been measurably, if not completely, successful. The power given the Civil Service Commission, to investigate and report upon violations of the law, has been used to bring to light such abuses as the levying of political contributions, and to set the machinery of the law in motion against them. While comparatively few actual prosecutions have been brought about, and although the penalties imposed by the act for this offence have been but seldom inflicted, still the publicity given to all such cases by the commission's investigations has had a wholesome deterrent effect. Before the passage of the act, positions were as a general rule held upon a well-understood lease-tenure, the political contributions for them being as securely and as certainly collected as any rent. Now, however, it can be said that these forced contributions have almost entirely disappeared. The efforts which are still made to collect political funds from government employees in evasion of the law are limited in the main to persuasion to make "voluntary" contributions, and it has been possible so to limit and obstruct these efforts that their practical effect upon the character of the service is now very small.

The same evils that the Federal Civil Service Act was designed to remedy exist to a large degree in many of the state governments, and are especially aggravated in the administration of the local governments of some of the larger cities. The chief, if not the only, test of fitness for office in many cases has been partly loyalty, honesty and capacity being seldom more than secondary considerations. The result has been the fostering of dishonesty and extravagance, which have brought weakness and gross corruption into the administration of the local governments. In consequence of this there has been a constantly growing tendency, among the more intelligent class of citizens, to demand that honest business methods be applied to local public service, and that appointments be made on the basis of intelligence and capacity, rather than of party allegiance. The movement for the reform of the civil service of cities is going hand in hand with the movement for general municipal reform, those reformers regarding the merit

*State
examina-
tion.*

² For the scope of these exceptions, see *Civil Service Rule VI.*, at p. 57 of the *U.S. Civil Service Commission's Fifteenth and Sixteenth Reports*. A statement of the number of positions actually affected by this action of the president appears in the *Seventeenth Report*.

system of appointments as not merely the necessary and only safe bulwark to preserve the results of their labours, but also as the most efficient means for bringing about other reforms. Hence civil service reform is given a leading position in all programmes for the reform of state and municipal governments. This has undoubtedly been due, in the first instance, at least, to the success which attended the application of the merit system to the Federal service, municipal and state legislation following in the wake of the national civil service law. In New York an act similar to the Federal Civil Service Act was passed on the 4th of May 1883, and in 1894 the principles of the merit system were introduced by an amendment into the state constitution, and made applicable to cities and villages as well. In Massachusetts an act was passed on the 3rd of June 1884 which in its general features was based upon the Federal act and the New York act. Similar laws were passed in Illinois and Wisconsin in 1895, and in New Jersey in 1908; the laws provide for the adoption of the merit system in state and municipal government. In New Orleans, La., and in Seattle, Wash., the merit system was introduced by an amendment to the city charter in 1896. The same result was accomplished by New Haven, Conn., in 1897, and by San Francisco, Cal., in 1899. In still other cities the principles of the merit system have been enacted into law, in some cases applying to the entire service and in others to only a part of it.

The application of the merit system to state and municipal governments has proved successful wherever it has been given a fair trial.¹ As experience has fostered public confidence in the system, and at the same time shown those features of the law which are most vulnerable, and the best means for fortifying them, numerous and important improvements upon the pioneer act applying to the Federal service have been introduced in the more recent legislation. This is particularly true of the acts now in force in New York (passed in 1899) and in Chicago. The power of the commission to enforce these acts is materially greater than the power possessed by the Federal commission. In making investigations they are not confined to taking the testimony of voluntary witnesses, but may administer oaths, and compel testimony and the production of books and papers where necessary; and in taking action they are not confined to the making of a report of the findings in their investigations, but may themselves, in many cases, take final judicial action. Further than this, the payment of salaries is made dependent upon the certificate of the commission that the appointments of the recipients were made in accordance with the civil service law and rules. Thus these commissions have absolute power to prevent irregular or illegal appointments by refractory appointing officers. Their powers being so much greater than those of the national commission, their action can be much more drastic in most cases, and they can go more directly to the heart of an existing abuse, and apply more quickly and effectually the needed remedy.

Upon the termination of the Spanish-American War, the necessity for the extension of the principles of the merit system to the new territories, the responsibility for whose government the results of this war had thrown upon the United States, was realized. By the acts providing for civil government in Porto Rico (April 12th, 1900) and Hawaii (April 30th, 1900), the provisions of the Civil Service Act and Rules were applied to those islands. Under this legislation the classification applies to all positions which are analogous to positions in the Federal service, those which correspond to positions in the municipal and state governments being considered as local in character, and not included in the classification.

On the 10th of September 1900 the United States Philippine Commission passed an act "for the establishment and maintenance of an efficient and honest civil service in the Philippine Islands." This act, in its general features, is based upon the national civil service law, but includes also a number of the

¹ In the *U. S. Civil Service Commission's Fifteenth Report*, pp. 489-502, the "growth of the civil service reform in states and cities" is historically treated, briefly, but with some thoroughness.

stronger points to be found in the state and municipal law mentioned above. Among these are the power given the civil service board to administer oaths, summon witnesses, and require the production of official records; and the power to stop payment of salaries to persons illegally appointed. Promotions are determined by competitive examinations, and are made throughout the service, as there are no excepted positions. A just right of preference in local appointments is given to natives. The president of the Philippine commission in introducing this bill said: "The purpose of the United States government . . . in these islands is to secure for the Filipino people as honest and as efficient a government as may be possible. . . . It is the hope of the commission to make it possible for one entering the lowest ranks to reach the highest, under a tenure based solely upon merit." Judging by past experience it is believed that this law is well adapted to accomplish the purpose above stated.

For fuller information upon the details of the present workings of the merit system in the Federal service, recourse should be had to the publications of the U.S. Civil Service Commission, which are to be found in the public libraries in all the principal cities in the United States, or which may be had free of charge upon application to the commission. The *Manual of Examinations*, published semi-annually, gives full information as to the character of the examinations held by the commission, together with the schedule of dates and places for the holding of those examinations. The *Annual Reports* of the commission contain full statistics of the results of its work, together with comprehensive statements as to the difficulties encountered in enforcing the law, and the means used to overcome them. In the *Fifteenth Report*, pp. 443-485, will be found a very valuable historical compilation from original sources, upon the "practice of the presidents in appointments and removals in the executive civil service, from 1789 to 1883." In the same report, pp. 511-517, is a somewhat comprehensive bibliography of "civil service" in periodical literature in the 19th century, brought down to the end of 1898. See also C. R. Fish, *The Civil Service and the Patronage* (New York, 1905).

In most European countries the civil service is recruited on much the same lines as in the United Kingdom and the United States, that is, either by examination or by nomination or by both. In some cases the examination is purely competitive, in other cases, as in France, holders of university degrees get special privileges, such as being put at the head of the list, or going up a certain number of places; or, as in Germany, many departmental posts are filled by nomination, combined with the results of general examinations, either at school or university. In the publications of the United States Department of Labour and Commerce for 1904-1905 will be found brief details of the systems adopted by the various foreign countries for appointing their civil service employees.

CIVITA CASTELLANA (anc. *Falerii, q.v.*), a town and episcopal see of the province of Rome, 45 m. by rail from the city of Rome (the station is 5 m. N.E. of the town). Population (1901) 5265. The cathedral of S. Maria possesses a fine portico, erected in 1210 by Laurentius Romanus, his son Jacobus and his grandson Cosmas, in the cosmatesque style, with ancient columns and mosaic decorations: the interior was modernized in the 18th century, but has some fragments of cosmatesque ornamentation. The citadel was erected by Pope Alexander VI. from the designs of Antonio da Sangallo the elder, and enlarged by Julius II. and Leo X. The lofty bridge by which the town is approached belongs to the 18th century. Mount Soracte lies about 6 m. to the south-east.

CIVITA VECCHIA, a seaport town and episcopal see of Italy, in the province of Rome, 50 m. N.W. by rail and 35 m. direct from the city of Rome. Pop. (1871) 8143; (1901) 17,589. It is the ancient *Centum Cellae*, founded by Trajan. Interesting descriptions of it are given by Pliny the Younger (*Epist.* vi. 31) and Rutilius Namat. i. 237. The modern harbour works rest on the ancient foundations, and near it the cemetery of detachments of the *Classes Misensensis* and *Ravennas* has been found (*Corp. Inscr. Lat.* vol. xi., Berlin, 1888, pp. 3520 seq.). Remains of an aqueduct and other Roman buildings are preserved; the imperial family had a villa here. Procopius mentions it in the 6th century as a strong and populous place, but it was destroyed in 813 by the Saracens. Leo IV. erected a new city for the inhabitants on the site where they had taken refuge, about 8 m. N.N.E. of Civita Vecchia towards the hills, near La Farnesina, where its ruins may still be seen; the city walls and some of the streets and buildings may be traced, and an inscription

(which must have stood over one of the city gates) recording its foundation has been discovered. It continued to exist under the name Cencelle as a feudal castle until the 15th century. In the meantime, however, the inhabitants returned to the old town by the shore in 889 and rebuilt it, giving it the name Civitas Vetus, the modern Civita Vecchia (see O. Marucchi in *Nuovo Bullettino di archeologia cristiana*, vi., 1900, p. 195 seq.). In 1508 Pope Julius II. began the construction of the castle from the designs of Bramante, Michelangelo being responsible for the addition of the central tower. It is considered by Burckhardt the finest building of its kind. Pius IV. added a convict prison. The arsenal was built by Alexander VII. and designed by Bernini. Civita Vecchia was the chief port of the Papal State and has still a considerable trade. There are cement factories in the town, and calcium carbide is an important article of export. The principal imports are coal, cattle for the home markets, and fire-bricks from the United Kingdom. Three miles N.E. were the *Aquae Tauri*, warm springs, now known as *Bagni della Ferrata*: considerable remains of the Roman baths are still preserved. About 1 m. W. of these are other hot springs, those of the *Ficoncella*, also known in Roman times.

CLACKMANNAN, the county town of Clackmannanshire, Scotland. Pop. 1505. It lies near the north bank of the Forth, 2 m. E. of Alloa, with two stations on the North British railway. Among the public buildings are the parish church, the tower of which, standing on a commanding eminence, is a conspicuous landmark. Clackmannan Tower is now a picturesque ruin, but at one time played an important part in Scottish history, and was the seat of a lineal descendant of the Bruce family after the failure of the male line. The old market cross still exists, and close to it stands the stone that gives the town its name (Gaelic, *clach*, stone; Manann, the name of the district). A large spinning-mill and coalpits lend a modern touch in singular contrast with the quaint, old-world aspect of the place. About 1 m. to the S.E. is Kennet House, the seat of Lord Balfour of Burleigh, another member of the Bruce family.

CLACKMANNANSHIRE, the smallest county in Scotland, bounded S.W. by the Forth, W. by Stirlingshire, N.N.E. and N.W. by Perthshire, and E. by Fifeshire. It has an area of 35,160 acres, or about 55 sq. m. An elevated ridge starting on the west, runs through the middle of the county, widening gradually till it reaches the eastern boundary, and skirting the alluvial or carse lands in the valleys of the Forth and Devon. Still farther to the N. the Ochil hills form a picturesque feature in the landscape, having their generally verdant surface broken by bold projecting rocks and deeply indented ravines. The principal summits are within the limits of the shire, among them Ben Cleuch (2363 ft.), King's Seat (2111 ft.), Whitewisp (2110 ft.), the Law (above Tillicoultry, 2094 ft.) and Blairdenon (2072 ft.), on the northern slope, in which the river Devon takes its rise. The rivers of importance are the Devon and the Black or South Devon. The former, noted in the upper parts for its romantic scenery and its excellent trout-fishing, runs through the county near the base of the Ochils, and falls into the Forth at the village of Cambus, after a winding course of 33 m., although as the crow flies its source is only $5\frac{1}{4}$ m. distant. The Black Devon, rising in the Cleish Hills, flows westwards in a direction nearly parallel to that of the Devon, and falls into the Forth near Clackmannan. It supplies motive power to numbers of mills and collieries; and its whole course is over coal strata. The Forth is navigable as far as it forms the boundary of the county, and ships of 500 tons burden run up as far as Alloa. The only lake is Gartmorn, 1 m. long by about $\frac{1}{3}$ of a mile broad, which has been dammed in order to furnish water to Alloa and power to mills. The Ochils are noted for the number of their glens. Though these are mostly small, they are well wooded and picturesque, and those at Menstrie, Alva, Tillicoultry and Dollar are particularly beautiful.

Geology.—This county is divided geologically into two areas, the boundary line skirting the southern margin of the Ochils and running westwards from a point north of Dollar by Alva in the direction of Airthrey in Stirlingshire. The northern portion forms part of the

volcanic range of the Ochils which belongs to the Old Red Sandstone period, and consists of a great succession of lavas—basalts and andesites—with intercalations of tuff and agglomerate. As the rocks dip gently towards the north and form the highest ground in the county they must reach a great thickness. They are pierced by small intrusive masses of diorite, north of Tillicoultry House. The well-marked feature running E. and W. along the southern base of the Ochils indicates a line of fault or dislocation which abruptly truncates the Lower Old Red volcanic rocks and brings down an important development of Carboniferous strata occupying the southern part of the county. These belong mainly to the Coal-measures and comprise a number of valuable coal-seams which have been extensively worked. The Clackmannan field is the northern continuation of the great Lanarkshire basin which extends northwards by Slamannan, Falkirk and the Carron Ironworks to Alloa. Along the eastern margin between Cairnmuir and Brucefield the underlying Millstone Grit, consisting mainly of false-bedded sandstones, comes to the surface. Close to the river Devon south of Dollar the Vicars Bridge Limestone, which there marks the top of the Carboniferous Limestone series, rises from beneath the Millstone Grit. The structure of the Clackmannan field is interesting. The strata are arranged in synclinal form, the highest seams being found near the Devon ironworks, and they are traversed by a series of parallel east and west faults each with a downthrow to the south, whereby the coals are repeated and the field extended. During mining operations evidence has been obtained of the existence of a buried river-channel, filled with boulder clay and stratified deposits along the course of the Devon, which extends below the present sea-level and points to greater elevation of the land in pre-glacial time. An excellent example of a dolerite dyke trending slightly north of west occurs in the north part of the county where it traverses the volcanic rocks of Lower Old Red Sandstone age.

Industries.—The soil is generally productive and well cultivated, though the greater part of the elevated range which is interposed between the carse lands on the Forth and the vale of Devon at the base of the Ochils on the north consists of inferior soils, often lying upon an impervious clay. Oats are the chief crop, but wheat and barley are profitably grown. Sheep-farming is successfully pursued, the Ochils affording excellent pasturage, and cattle, pigs and horses are also raised. There is a small tract of moorland in the east, called the Forest, bounded on its northern margin by the Black Devon. Iron-ore (haematite), copper, silver, lead, cobalt and arsenic have all been discovered in small quantity in the Ochils, between Alva and Dollar. Ironstone—found either in beds, or in oblate balls embedded in slaty clay, and yielded from 25 to 30 % of iron—is mined for the Devon iron-works, near Clackmannan. Coal has been mined for a long period. The strata which compose the field are varieties of sandstone, shale, fire-clay and argillaceous ironstone. There is a heavy continuous output of coal at the mines at Sauchie, Fishcross, Coalsnaughton, Devonside, Clackmannan and other pits. The spinning-mills at Alloa, Tillicoultry and Alva are always busy, Alloa yarns and fingering being widely famous. The distilleries at Glenochil and Carsebridge and the breweries in Alloa and Cambus do a large export business. The minor trades include glass-blowing, pottery, coopering, tanning, iron-founding, electrical apparatus making, ship-building and paper-making.

The north British railway serves the whole county, while the Caledonian has access to Alloa.

Population and Government.—The population was 33,140 in 1891 and 32,029 in 1901, when 170 persons spoke Gaelic and English and one person Gaelic only. The county unites with Kinross-shire in returning one member to parliament. Clackmannan (pop. 1505) is the county town, but Alloa (14,458), Alva (4624), and Tillicoultry (3338) take precedence in population and trade. Menstrie (pop. 898) near Alloa has a large furniture factory and the great distillery of Glenochil. To the north-east of Alloa is the thriving mining village of Sauchie. Clackmannan forms a sheriffdom with Stirling and Dumbarton shires, and a sheriff-substitute sits at Alloa. Most of the schools in the shire are under school-board control, but there are a few voluntary schools, besides an exceptionally well-equipped technical school in Alloa and a well-known academy at Dollar.

See James Wallace, *The Sheriffdom of Clackmannan: a Sketch of its History* (Edinburgh, 1890); D. Beveridge, *Between the Ochils and the Forth* (Edinburgh, 1888); John Crawford, *Memorials of Alloa* (1885); William Gibson, *Reminiscences of Dollar, Tillicoultry,*

CLACTON-ON-SEA, a watering-place in the Harwich parliamentary division of Essex, England; 71 m. E.N.E. from London by a branch from Colchester of the Great Eastern railway; served also by steamers from London in the summer months. Pop. of urban district (1901) 7456. Clay cliffs of slight altitude rise from the sandy beach and face south-eastward. In the neighbourhood, however, marshes fringe the shore. The church of Great Clacton, at the village $1\frac{1}{2}$ m. inland, is Norman and later, and of considerable interest. Clacton is provided with a pier, promenade and marine parade; and is the seat of various convalescent and other homes.

CLADEL, LÉON (1835-1892), French novelist, was born at Montauban (Tarn-et-Garonne) on the 13th of March 1835. The son of an artisan, he studied law at Toulouse and became a solicitor's clerk in Paris. He made a reputation in a limited circle by his first book, *Les Martyrs ridicules* (1862), a novel for which Charles Baudelaire, whose literary disciple Cladel was, wrote a preface. He then returned to his native district of Quercy, where he produced a series of pictures of peasant life in *Eral le dompteur* (1865), *Le Nommé Quœel* (1868) and other volumes. Returning to Paris he published the two novels which are generally acknowledged as his best work, *Le Bouscassié* (1869) and *La Fête votive de Saint Bartholomée Porte-glaive* (1872). *Une Maudite* (1876) was judged dangerous to the public morals and cost its author a month's imprisonment. Other works by Cladel are *Les Va-nu-pieds* (1873), a volume of short stories; *N'a qu'un œil* (1882), *Urbains et ruraux* (1884), *Gueux de marque* (1887), and the posthumous *Juive errante* (1897). He died at Sèvres on the 20th of July 1892.

See *La Vie de Léon Cladel* (Paris, 1905), by his daughter Judith Cladel, containing also an article on Cladel by Edmond Picard, a complete list of his works, and of the critical articles on his work.

CLAFLIN, HORACE BRIGHAM (1811-1885), American merchant, was born in Milford, Massachusetts, on the 18th of December 1811. He was educated at Milford Academy, became a clerk in his father's store in Milford, and in 1831, with his brother Aaron and his brother-in-law Samuel Daniels, succeeded to his father's business. In 1832 the firm opened a branch store in Worcester, Mass., and in 1833 Horace B. Clafin and Daniels secured the sole control of this establishment and restricted their dealing to dry goods. In 1843 Clafin removed to New York City and became a member of the firm of Bulkley & Clafin, wholesaler dry goods merchants. In 1851 and in 1864 the firm was reorganized, being designated in these respective years as Clafin, Mellin & Company and H. B. Clafin & Company. Under Clafin's management the business increased so rapidly that the sales for a time after 1865 probably exceeded those of any other mercantile house in the world. Though the firm was temporarily embarrassed at the beginning of the Civil War, on account of its large business interests in the South, and during the financial panic of 1873, the promptness with which Mr Clafin met these crises and paid every dollar of his liabilities greatly increased his reputation for business ability and integrity. He died at Fordham, New York, on the 14th of November 1885.

CLAIRAULT (or **CLAIRAUT**), **ALEXIS CLAUDE** (1713-1765), French mathematician, was born on the 13th or 7th of May 1713, at Paris, where his father was a teacher of mathematics. Under his father's tuition he made such rapid progress in mathematical studies that in his thirteenth year he read before the French Academy an account of the properties of four curves which he had then discovered. When only sixteen he finished a treatise, *Recherches sur les courbes à double courbure*, which, on its publication in 1731, procured his admission into the Academy of Sciences, although even then he was below the legal age. In 1736, together with Pierre Louis Maupertuis, he took part in the expedition to Lapland, which was undertaken for the purpose of estimating a degree of the meridian, and on his return he published his treatise *Théorie de la figure de la terre* (1743). In this work he promulgated the theorem, known as "Clairault's theorem," which connects the gravity at points on the surface of a rotating ellipsoid with the compression and the centrifugal force at the equator (see **EARTH, FIGURE OF THE**). He obtained

an ingenious approximate solution of the problem of the three bodies; in 1750 he gained the prize of the St Petersburg Academy for his essay *Théorie de la lune*; and in 1759 he calculated the perihelion of Halley's comet. He also detected singular solutions in differential equations of the first order, and of the second and higher degrees. Clairault died at Paris, on the 17th of May 1765.

CLAIRON, LA (1723-1803), French actress, whose real name was **CLAIRE JOSEPH HIPPOLYTE LERIS**, was born at Condé sur l'Escaut, Hainaut, on the 25th of January 1723, the natural daughter of any army sergeant. In 1736 she made her first stage appearance at the Comédie Italienne, in a small part in Marivaux's *Île des esclaves*. After several years in the provinces she returned to Paris. Her life, meanwhile, had been decidedly irregular, even if not to the degree indicated by the libellous pamphlet *Histoire de la demoiselle Cronel, dite Frétilton, actrice de la Comédie de Rouen, écrite par elle-même* (The Hague, 1746), or to be inferred from the disingenuousness of her own *Mémoires d'Hippolyte Clairon* (1798); and she had great difficulty in obtaining an order to make her *début* at the Comédie Française. Succeeding, however, at last, she had the courage to select the title-rôle of *Phèdre* (1743), and she obtained a veritable triumph. During her twenty-two years at this theatre, dividing the honours with her rival Mlle Dumesnil, she filled many of the classical rôles of tragedy, and created a great number of parts in the plays of Voltaire, Marmontel, Saurin, de Belloy and others. She retired in 1766, and trained pupils for the stage, among them Mlle Raucourt. Goldsmith called Mlle Clairon "the most perfect female figure I have ever seen on any stage" (*The Bee*, 2nd No.); and Garrick, while recognizing her unwillingness or inability to make use of the inspiration of the instant, admitted that "she has everything that art and a good understanding with great natural spirit can give her."

CLAIRVAUX, a village of north-eastern France, in the department of Aube, 40 m. E.S.E. of Troyes on the Eastern railway to Belfort. Clairvaux (*Clara Vallis*) is situated in the valley of the Aube on the eastern border of the Forest of Clairvaux. Its celebrity is due to the abbey founded in 1115 by St Bernard, which became the centre of the Cistercian order. The buildings (see **ABBEY**) belong for the most part to the 18th century, but there is a large storehouse which dates from the 12th century. The abbey, suppressed at the Revolution, now serves as a prison, containing on an average 800 inmates, who are employed in agricultural and industrial occupations. Clairvaux has iron-works of some importance.

CLAIRVOYANCE (Fr. for "clear-seeing"), a technical term in psychical research, properly equivalent to lucidity, a supernormal power of obtaining knowledge in which no part is played by (a) the ordinary processes of sense-perception or (b) supernormal communication with other intelligences, incarnate, or discarnate. The word is also used, sometimes qualified by the word *telepathic*, to mean the power of gaining supernormal knowledge from the mind of another (see **TELEPATHY**). It is further commonly used by spiritualists to mean the power of seeing spirit forms, or, more vaguely, of discovering facts by some supernormal means.

Lucidity.—Few experiments have been made to test the existence of this faculty. If communications from discarnate minds are regarded as possible, there are no means of distinguishing facts obtained in this way from facts obtained by independent clairvoyance. In practice no evidence has been obtained pointing to the possession by a discarnate spirit of knowledge not possessed by any living person (see **MEDIUM**). As explanation of the few successful experiments in independent clairvoyance we have the choice of three explanations: (1) lucidity; (2) telepathy from living persons; (3) hyperaesthesia. The second possibility was overlooked in Richet's diagram experiments; it cannot be assumed that a picture put into an envelope and not consciously recalled has been in reality forgotten. Similarly the clairvoyant diagnosis of diseases may depend on knowledge gained telepathically from the patient, who may be subliminally aware of diseased states of the body. The most elaborate experiments are by Prof. Richet with a hypnotized subject who succeeded in

naming twelve cards out of sixty-eight. But no precautions were taken against hyperaesthesia further than enclosing the card in a second envelope. There is a power possessed by a certain number of people, of naming a card drawn by them or held in the hand face downwards, so that there is no normal knowledge of its suit and number. Few thorough trials have been made; but it seems to point to some kind of hyperaesthesia rather than to clairvoyance; in the Richet experiments even if the envelopes excluded hyperaesthesia of touch on the part of the medium, there may have been subliminal knowledge on Prof. Richet's part of the card which he put in the envelope. The experience known as the *déjà vu* has sometimes been explained as due to clairvoyance.

Telepathic Clairvoyance.—For a discussion of this see TELEPATHY and CRYSTAL-GAZING. It may be noted here that some curious relation seems to exist between apparently telepathic acquisition of knowledge and the arrival of a letter, newspaper, &c., from which the same knowledge could be directly gained. We are confronted with a similar problem in attempting an explanation of the power of mediums to state correctly facts relating to objects placed in their hands. Of a somewhat different character is retrocognition (*q.v.*), where the knowledge in many cases, if telepathic, must be derived from a discarnate mind.

Clairvoyance, as a term of spiritualism, with its correlative *clairaudience*, is the name given to the power of seeing and hearing discarnate spirits of dead relatives and others, with whom the living are said to be surrounded. More vaguely it includes the power of gaining knowledge, either through the spirit world or by means of psychometry (*i.e.* the supernormal acquisition of knowledge about owners of objects, writers of letters, &c.). Some evidence for these latter powers has been accumulated by the Society for Psychical Research, but in many cases the piecing together of normally acquired knowledge, together with shrewd guessing, suffices to explain the facts, especially where the investigator has had no special training for his task.

See Richet, *Experimentelle Studien* (1891); also in *Proc. S.P.R.* vi. 66. For a criticism see N. W. Thomas, *Thought Transference*, pp. 44-48. For Clairvoyance in general see F. W. H. Myers, *Human Personality*, and in *Proc. S.P.R.* xi. 334 et seq. For a criticism of the evidence see Mrs Sidgwick in *Proc. S.P.R.* vii. 30, 356. (N. W. T.)

CLAMECY, a town of central France, capital of an arrondissement in the department of Nièvre, at the confluence of the Yonne and Beuvron and on the Canal du Nivernais, 46 m. N.N.E. of Nevers on the Paris-Lyon railway. Pop. (1906) 4455. Its principal building is the church of St Martin, which dates chiefly from the 13th, 14th and 15th centuries. The tower and facade are of the 16th century. The chevet, which is surrounded by an aisle, is rectangular—a feature found in few French churches. Of the old castle of the counts of Nevers, vaulted cellars alone remain. A church in the suburb of Bethlehem, dating from the 12th and 13th centuries, now serves as part of an hotel. The public institutions include the sub-prefecture, tribunals of first instance and of commerce and a communal college. Among the industrial establishments are saw-mills, fulling-mills and flour-mills, tanneries and manufactories of boots and shoes and chemicals, and there is considerable trade in wine and cattle and in wood and charcoal, which is conveyed principally to Paris, by way of the Yonne.

In the early middle ages Clamecy belonged to the abbey of St Julian at Auxerre, in the 11th century it passed to the counts of Nevers, one of whom, Hervé, enfranchised the inhabitants in 1213. After the capture of Jerusalem by Saladin in 1188, Clamecy became the seat of the bishops of Bethlehem, who till the Revolution resided in the hospital of Pantheon, bequeathed by William IV., count of Nevers. On the *coup d'état* of 1851 an insurrection broke out in the town, and was repressed by the new authorities with great severity.

CLAN (Gaelic *clann*, O. Ir. *cland*, connected with Lat. *planta*, shoot or scion, the ancient Gaelic or Goidelic substituting *k* for *p*), a group of people united by common blood, and usually settled in a common habitat. The clan system existed in Ireland and the Highlands of Scotland from early times. In its strictest sense the

system was peculiar to those countries, but, in its wider meaning of a group of kinsmen forming a self-governing community, the system as represented by the village community has been shown by Sir H. Maine and others to have existed at one time or another in all lands.

Before the use of surnames and elaborate written genealogies, a tribe in its definite sense was called in Celtic a *tuath*, a word of wide affinities, from a root *tu*, to grow, to multiply, existing in all European languages. When the tribal system began to be broken up by conquest and by the rise of towns and of territorial government, the use of a common surname furnished a new bond for keeping up a connexion between kindred. The head of a tribe or smaller group of kindred selected some ancestor and called himself his *Ua*, grandson, or as it has been anglicized *O'*, *e.g.* *Ua Conchobair* (O'Conor), *Ua Suilleabhain* (O'Sullivan). All his kindred adopted the same name, the chief using no fore-name however. The usual mode of distinguishing a person before the introduction of surnames was to name his father and grandfather, *e.g.* Owen, son of Donal, son of Dermot. This naturally led some to form their surnames with *Mac*, son, instead of *Ua*, grandson, *e.g.* *Mac Carthaigh*, son of *Carthach* (Mac Carthy), *Mac Ruaidhri*, son of Rory (Macrory). Both methods have been followed in Ireland, but in Scotland *Mac* came to be exclusively used. The adoption of such genealogical surnames fostered the notion that all who bore the same surname were kinsmen, and hence the genealogical term *clann*, which properly means the descendants of some progenitor, gradually became synonymous with *tuath*, tribe. Like all purely genealogical terms, *clann* may be used in the limited sense of a particular tribe governed by a chief, or in that of many tribes claiming descent from a common ancestor. In the latter-sense it was synonymous with *síol*, *siol*, seed *e.g.* *Síol Alpine*, a great clan which included the smaller clans of the Macgregors, Grants, Mackinnons, Macnabs, Macphies, Macquarries and Macaulays.

The clan system in the most archaic form of which we have any definite information can be best studied in the Irish *tuath*, or tribe.¹ This consisted of two classes: (1) tribesmen, and (2) a miscellaneous class of slaves, criminals, strangers and their descendants. The first-class included tribesmen by blood in the male line, including all illegitimate children acknowledged by their fathers, and tribesmen by adoption or sons of tribeswomen by strangers, foster-sons, men who had done some signal service to the tribe, and lastly the descendants of the second class after a certain number of generations. Each *tuath* had a chief called a *ríg*, king, a word cognate with the Gaulish *rig-s* or *rix*, the Latin *reg-s* or *rex*, and the Old Norse *rik-ir*. The tribesmen formed a number of communities, each of which, like the tribe itself, consisted of a head, *ceann fine*, his kinsmen, slaves and other retainers. This was the *fine*, or sept. Each of these occupied a certain part of the tribe-land, the arable part being cultivated under a system of co-tillage, the pasture land grazed according to certain customs, and the wood, bog and mountains forming the marchland of the sept being the unrestricted common land of the sept. The sept was in fact a village community.

What the sept was to the tribe, the homestead was to the sept. The head of a homestead was an *aire*, a representative freeman capable of acting as a witness, compurgator and bail. These were very important functions, especially when it is borne in mind that the tribal homestead was the home of many of the kinsfolk of the head of the family as well as of his own children. The descent of property being according to a gavel-kind custom, it constantly happened that when an *aire* died the share of his property which each member of his immediate family was entitled to receive was not sufficient to qualify him to be an *aire*. In this case the family did not divide the inheritance, but remained together as "a joint and undivided family," one of the members being elected chief of the family or household, and in

¹ The following account of the Irish clan-system differs in some respects from that in the article on BREHON LAWS (*q.v.*), but it is retained here in view of the authority of the writer and the admitted obscurity of the whole subject. (Ed. E.B.)

this capacity enjoyed the rights and privileges of an *aire*. Sir H. S. Maine directed attention to this kind of family as an important feature of the early institutions of all Indo-European nations. Beside the "joint and undivided family," there was another kind of family which we might call "the joint family." This was a partnership composed of three or four members of a sept whose individual wealth was not sufficient to qualify each of them to be an *aire*, but whose joint wealth qualified one of the co-partners as head of the joint family to be one.

So long as there was abundance of land each family grazed its cattle upon the tribe-land without restriction; unequal increase of wealth and growth of population naturally led to its limitation, each head of a homestead being entitled to graze an amount of stock in proportion to his wealth, the size of his homestead, and his-acquired position. The arable land was no doubt apportioned annually at first; gradually, however, some of the richer families of the tribe succeeded in evading this exchange of allotments and converting part of the common land into an estate in severalty. Septs were at first colonies of the tribe which settled on the march-land; afterwards the conversion of part of the common land into an estate in severalty enabled the family that acquired it to become the parent of a new sept. The same process might, however, take place within a sept without dividing it; in other words, several members of the sept might hold part of the land of the sept as separate estate. The possession of land in severalty introduced an important distinction into the tribal system—it created an aristocracy. An *aire* whose family held the same land for three generations was called a *flaith*, or lord, of which rank there were several grades according to their wealth in land and chattels. The *aires* whose wealth consisted in cattle only were called *bó-aires*, or cow-*aires*, of whom there were also several grades, depending on their wealth in stock. When a *bó-aire* had twice the wealth of the lowest class of *flaith* he might enclose part of the land adjoining his house as a lawn; this was the first step towards his becoming a *flaith*. The relations which subsisted between the *flaiths* and the *bó-aires* formed the most curious part of the Celtic tribal system, and throw a flood of light on the origin of the feudal system. Every tribesman without exception owed *ceilsinne* to the *rig*, or chief, that is, he was bound to become his *ceile*, or vassal. This consisted in paying the *rig* a tribute in kind, for which the *ceile* was entitled to receive a proportionate amount of stock without having to give any bond for their return, giving him service, e.g. in building his *dun*, or stronghold, reaping his harvest, keeping his roads clean and in repair, killing wolves, and especially service in the field, and doing him homage three times while seated every time he made his return of tribute. Paying the "*calpe*" to the Highland chiefs represented this kind of vassalage, a *colpdach* or heifer being in many cases the amount of food-rent paid by a free or *saer ceile*. A tribesman might, however, if he pleased, pay a higher rent on receiving more stock together with certain other chattels for which no rent was chargeable. In this case he entered into a contract, and was therefore a bond or *daer ceile*. No one need have accepted stock on these terms, nor could he do so without the consent of his sept, and he might free himself at any time from his obligation by returning what he had received, and the rent due thereon.

What every one was bound to do to his *rig*, or chief, he might do voluntarily to the *flaith* of his sept, to any *flaith* of the tribe, or even to one of another tribe. He might also become a bond *ceile*. In either case he might renounce his *ceile*ship by returning a greater or lesser amount of stock than what he had received according to the circumstances under which he terminated his vassalage. In cases of disputed succession to the chiefship of a tribe the rival claimants were always anxious to get as many as possible to become their vassals. Hence the anxiety of minor chieftains, in later times in the Highlands of Scotland, to induce the clansmen to pay the "*calpe*" where there happened to be a doubt as to who was entitled to be chief.

The effect of the custom of gavel-kind was to equalize the wealth of each and leave no one wealthy enough to be chief.

The "joint and undivided family" and the formation of "joint families," or gilds, was one way of obviating this result; another way was the custom of tanistry. The headship of the tribe was practically confined to the members of one family; this was also the case with the headship of a sept. Sometimes a son succeeded his father, but the rule was that the eldest and most capable member of the *geilfine*, that is, the relatives of the actual chief to the fifth degree,¹ was selected during his lifetime to be his successor—generally the eldest surviving brother or son of the preceding chief. The man selected as successor to a chief of a tribe, or chieftain of a sept, was called the tanist, and should be "the most experienced, the most noble, the most wealthy, the wisest, the most learned, the most truly popular, the most powerful to oppose, the most steadfast to sue for profits and (be sued) for losses." In addition to these qualities he should be free from personal blemishes and deformities and of fit age to lead his tribe or sept, as the case may be, to battle.² So far as selecting the man of the *geilfine* who was supposed to possess all those qualities, the office of chief of a tribe or chieftain of a sept was elective, but as the *geilfine* was represented by four persons, together with the chief or chieftain, the election was practically confined to one of the four. In order to support the dignity of the chief or chieftain a certain portion of the tribe or sept land was attached as an appanage to the office; this land, with the *duns* or fortified residences upon it, went to the successor, but a chief's own property might be gavelled. This custom of tanistry applied at first probably to the selection of the successors of a *rig*, but was gradually so extended that even a *bó-aire* had a tanist.

A sept might have only one *flaith*, or lord, connected with it, or might have several. It sometimes happened, however, that a sept might be so broken and reduced as not to have even one man qualified to rank as a *flaith*. The rank of a *flaith* depended upon the number of his *ceiles*, that is, upon his wealth. The *flaith* of a sept, and the highest when there was more than one, was *ceann fine*, or head of the sept, or as he was usually called in Scotland, the chieftain. He was also called the *flaith geilfine*, or head of the *geilfine*, that is, the kinsmen to the fifth degree from among whom should be chosen the tanist, and who, according to the custom of gavel-kind, were the immediate heirs who received the personal property and were answerable for the liabilities of the sept. The *flaiths* of the different septs were the vassals of the *rig*, or chief of the tribe, and performed certain functions which were no doubt at first individual, but in time became the hereditary right of the sept. One of those was the office of *maer*, or steward of the chief's rents, &c.;³ and another that of *aire tuisi*, leading *aire*, or *taoisech*, a word cognate with the Latin *duc-s* or *dux*, and Anglo-Saxon *here-tog*, leader of the "here," or army. The *taoisech* was leader of the tribe in battle; in later times the term seems to have been extended to several offices of rank. The cadet of a Highland clan was always called the *taoisech*, which has been translated captain; after the conquest of Wales the same term, *tywysaug*, was used for a ruling prince. Slavery was very common in Ireland and Scotland;

¹ The explanation here given of *geilfine* is different from that given in the introduction to the third volume of the *Ancient Laws of Ireland*, which was followed by Sir H. S. Maine in his account of it in his *Early History of Institutions*, and which the present writer believes to be erroneous.

² It should also be mentioned that illegitimacy was not a bar. The issue of "handfast" marriages in Scotland were eligible to be chiefs, and even sometimes claimed under feudal law.

³ This office is of considerable importance in connexion with early Scottish history. In the Irish annals the *rig*, or chief of a great tribe (*mor tuath*), such as of Ross, Moray, Marr, Buchan, &c., is called a *mor maer*, or great *maer*. Sometimes the same person is called king also in these annals. Thus *Findlaec*, or Finlay, son of *Ruadhri*, the father of Shakespeare's *Macbeth*, is called king of Moray in the *Annals of Ulster*, and *mor maer* in the *Annals of Tighernach*. The term is never found in Scottish charters, but it occurs in the Book of the Abbey of Deir in Buchan, now in the library of the university of Cambridge. The Scotch kings and their successors obviously regarded the chiefs of the great tribes in question merely as their *maers*, while their tribesmen only knew them as kings. From these "mor-maerships," which corresponded with the ancient *mor tuatha*, came most, if not all, the ancient Scottish earldoms.

in the former slaves constituted a common element in the stipends or gifts which the higher kings gave their vassal *sub-reguli*. Female slaves, who were employed in the houses of chiefs and *flaiths* in grinding meal with the hand-mill or quern, and in other domestic work, must have been very common, for the unit or standard for estimating the wealth of a *bó-aire*, blood-fines, &c., was called a *cumhal*, the value of which was three cows, but which literally meant a female slave. The descendants of those slaves, prisoners of war, forfeited hostages, refugees from other tribes, broken tribesmen, &c., gathered round the residence of the *rig* and *flaiths*, or squatted upon their marchlands, forming a motley band of retainers which made a considerable element in the population, and one of the chief sources of the wealth of chiefs and *flaiths*. The other principal source of their income was the food-rent paid by *ceiles*, and especially by the *daer* or bond *ceiles*, who were hence called *biathachs*, from *biad*, food. A *flaith*, but not a *rig*, might, if he liked, go to the house of his *ceile* and consume his food-rent in the house of the latter.

Under the influence of feudal ideas and the growth of the modern views as to ownership of land, the chiefs and other lords of clans claimed in modern times the right of best owing the tribe-land as *turcrec*, instead of stock, and receiving rent not for cattle and other chattels as in former times, but proportionate to the extent of land given to them. The *turcrec*-land seems to have been at first given upon the same terms as *turcrec*-stock, but gradually a system of short leases grew up; sometimes, too, it was given on mortgage. In the Highlands of Scotland *ceiles* who received *turcrec*-land were called "taksmen." On the death of the chief or lord, his successor either bestowed the land upon the same person or gave it to some other relative. In this way in each generation new families came into possession of land, and others sank into the mass of mere tribesmen. Sometimes a "taksman" succeeded in acquiring his land in perpetuity, by gift, marriage or purchase, or even by the "streng hand." The universal prevalence of exchangeable allotments, or the rundale system, shows that down to even comparatively modern times some of the land was still recognized as the property of the tribe, and was cultivated in village communities.

The chief governed the clan by the aid of a council called the *sabaid* (*sab*, a prop), but the chief exercised much power, especially over the miscellaneous body of non-tribesmen who lived on his own estate. This power seems to have extended to life and death. Several of the *flaiths*, perhaps, all heads of septs, also possessed somewhat extensive powers of the same kind.

The Celtic dress, at least in the middle ages, consisted of a kind of shirt reaching to a little below the knees called a *lenn*, a jacket called an *inar*, and a garment called a *brat*, consisting of a single piece of cloth. This was apparently the garb of the *aires*, who appear to have been further distinguished by the number of colours in their dress, for we are told that while a slave had clothes of one colour, a *rég tuatha*, or chief of a tribe, had five, and an *ollamh* and a superior king six. The breeches was also known, and cloaks with a cowl or hood, which buttoned up tight in front. The *lenn* is the modern kilt, and the *brat* the plaid, so that the dress of the Irish and Welsh in former times was the same as that of the Scottish Highlander.

By the abolition of the heritable jurisdiction of the Highland chiefs, and the general disarmament of the clans by the acts passed in 1747 after the rebellion of 1745, the clan system was practically broken up, though its influence still lingers in the more remote districts. An act was also passed in 1747 forbidding the use of the Highland garb; but the injustice and impolicy of such a law being generally felt it was afterwards repealed.

(W. K. S.)

CLANRICARDE, ULICK DE BURGH (BOURKE OR BURKE), 1ST EARL OF (d. 1544), styled MacWilliam, and Ne-gan or NagCeann (*i.e.* "of the Heads," "having made a mound of the heads of men slain in battle which he covered up with earth"), was the son of Richard or Rickard de Burgh, lord of Clanricarde, by a daughter of Madden of Portumna, and grandson of Ulick de

Burgh, lord of Clanricarde (1467-1487), the collateral heir male of the earls of Ulster. On the death of the last earl in 1333, his only child Elizabeth had married Lionel, duke of Clarence, and the earldom became merged in the crown, in consequence of which the de Burghs abjured English laws and sovereignty, and chose for their chiefs the sons of Sir William, the "Red" earl of Ulster's brother, the elder William taking the title of MacWilliam Eighter (Uachtar, *i.e.* Upper), and becoming the ancestor of the earls of Clanricarde, and his brother Sir Edmond that of MacWilliam Oughter (Ochtar, *i.e.* Lower), and founding the family of the earls of Mayo. In 1361 the duke of Clarence was sent over as lord-lieutenant to Ireland to enforce his claims as husband of the heir general, but failed, and the chiefs of the de Burghs maintained their independence of English sovereignty for several generations. Ulick de Burgh succeeded to the headship of his clan, exercised a quasi-royal authority and held vast estates in county Galway, in Connaught, including Loughry, Dunkellin, Kiltartan (Hilltaraght) and Athenry, as well as Clare and Leitrim. In March 1541, however, he wrote to Henry VIII., lamenting the degeneracy of his family, "which have been brought to Irish and disobedient rule by reason of marriage and nursing with those Irish, sometime rebels, near adjoining to me," and placing himself and his estates in the king's hands. The same year he was present at Dublin, when the act was passed making Henry VIII. king of Ireland. In 1543, in company with other Irish chiefs, he visited the king at Greenwich, made full submission, undertook to introduce English manners and abandon Irish names, received a regrant of the greater part of his estates with the addition of other lands, was confirmed in the captainship and rule of Clanricarde, and was created on the 1st of July 1543 earl of Clanricarde and baron of Dunkellin in the peerage of Ireland, with unusual ceremony. "The making of McWilliam earl of Clanricarde made all the country during his time quiet and obedient," states Lord Chancellor Cusack in his review of the state of Ireland in 1553.¹ He did not live long, however, to enjoy his new English dignities, but died shortly after returning to Ireland about March 1544. He is called by the annalist of Loch Cé "a haughty and proud lord," who reduced many under his yoke, and by the Four Masters "the most illustrious of the English in Connaught."

Clanricarde married (1) Grany or Grace, daughter of Mulrone O'Carroll, "prince of Ely," by whom he had Richard or Rickard "the Saxon," who succeeded him as 2nd earl of Clanricarde (grandfather of the 4th earl, whose son became marquess of Clanricarde), this alliance being the only one declared valid. After parting with his first wife he married (2) Honora, sister of Ulick de Burgh, from whom he also parted. He married (3) Mary Lynch, by whom he had John, who claimed the earldom in 1568. Other sons, according to Burke's *Peerage*, were Thomas "the Athlete," shot in 1545, Redmond "of the Broom" (d. 1595), and Edmund (d. 1597).

See also *Annals of Ireland by the Four Masters* (ed. by O. Connellan, 1846), p. 132 note, and reign of Henry VIII.; *Annals of Loch Cé (Rerum Brit. Medii Aevi Scriptores)* (54) (1871); *Hist. Mem. of the O'Briens*, by J. O. Donoghue (1860), pp. 159, 519; *Ireland under the Tudors*, by R. Bagwell, vol. i.; *State Papers, Ireland, Carew MSS.* and Gairdner's *Letters and Papers of Henry VIII.*; *Colton MSS.* Brit. Mus., Titus B xi. f. 388. (P. C. Y.)

CLANRICARDE, ULICK DE BURGH (BOURKE OR BURKE), MARQUESS OF (1604-1657 or 1658), son of Richard, 4th earl of Clanricarde, created in 1628 earl of St Albans, and of Frances, daughter and heir of Sir Francis Walsingham, and widow of Sir Philip Sidney and of Robert Devereux, earl of Essex, was born in 1604. He was summoned to the House of Lords as Lord Burgh in 1628, and succeeded his father as 5th earl in 1635. He sat in the Short Parliament of 1640 and attended Charles I. in the Scottish expedition. On the outbreak of the Irish rebellion Clanricarde had powerful inducements for joining the Irish—the ancient greatness and independence of his family, his devotion to the Roman Catholic Church, and strongest of all, the ungrateful treatment meted out by Charles I. and Wentworth to his father, one of Elizabeth's most staunch adherents in Ireland, whose lands were appropriated by the crown and whose death, it was popularly

¹ *Cal. of State Pap., Carew MSS.* 1515-1574, p. 246.

asserted, was hastened by the harshness of the lord-lieutenant. Nevertheless at the crisis his loyalty never wavered. Alone of the Irish Roman Catholic nobility to declare for the king, he returned to Ireland, took up his residence at Portumna, kept Galway, of which he was governor, neutral, and took measures for the defence of the county and for the relief of the Protestants, making "his house and towns a refuge, nay, even a hospital for the distressed English."¹ In 1643 he was one of the commissioners appointed by the king to confer with the Irish confederates, and urged the wisdom of a cessation of hostilities in a document which he publicly distributed. He was appointed commander of the English forces in Connaught in 1644, and in 1646 was created a marquess and a privy councillor. He supported the same year the treaty between Charles I. and the confederates, and endeavoured after its failure to persuade Preston, the general of the Irish, to agree to a peace; but the latter, being advised by Rinuccini, the papal nuncio, refused in December. Together with Ormonde, Clanricarde opposed the nuncio's policy; and the royalist inhabitants of Galway having through the latter's influence rejected the cessation of hostilities, arranged with Lord Inchiquin in 1648, he besieged the town and compelled its acquiescence. In 1649 he reduced Sligo. On Ormonde's departure in December 1650 Clanricarde was appointed deputy lord-lieutenant, but he was not trusted by the Roman Catholics, and was unable to stem the tide of the parliamentary successes. In 1651 he opposed the offer of Charles, duke of Lorraine, to supply money and aid on condition of being acknowledged "Protector" of the kingdom. In May 1652 Galway surrendered to the parliament, and in June Clanricarde signed articles with the parliamentary commissioners which allowed his departure from Ireland. In August he was excepted from pardon for life and estate, but by permits, renewed from time to time by the council, he was enabled to remain in England for the rest of his life, and in 1653 £500 a year was settled upon him by the council of state in consideration of the protection which he had given to the Protestants in Ireland at the time of the rebellion. He died at Somerhill in Kent in 1657 or 1658 and was buried at Tunbridge.

The "great earl," as he was called, supported Ormonde in his desire to unite the English royalists with the more moderate Roman Catholics on the basis of religious toleration under the authority of the sovereign, against the papal scheme advocated by Rinuccini, and in opposition to the parliamentary and Puritan policy. By the author of the *Aphorismical Discovery*, who represents the opinion of the native Irish, he is denounced as the "masterpiece of the treasonable faction," "a foe to his king, nation and religion," and by the duke of Lorraine as "a traitor and a base fellow"; but there is no reason to doubt Clarendon's opinion of him as "a person of unquestionable fidelity . . . and of the most eminent constancy to the Roman Catholic religion of any man in the three kingdoms," or the verdict of Hallam, who describes him "as perhaps the most unsullied character in the annals of Ireland."

He married Lady Anne Compton, daughter of William Compton, 1st earl of Northampton, but had issue only one daughter. On his death, accordingly, the marquessate and the English peerages became extinct, the Irish titles reverting to his cousin Richard, 6th earl, grandson of the 3rd earl of Clanricarde. Henry, the 12th earl (1742-1797), was again created a marquess in 1789, but the marquessate expired at his death without issue, the earldom going to his brother. In 1825 the 14th earl (1802-1874) was created a marquess; he was ambassador at St Petersburg, and later postmaster-general and lord privy seal, and married George Canning's daughter. His son (b. 1832), who achieved notoriety in the Irish land agitation, succeeded him as 2nd marquess.

BIBLIOGRAPHY.—See the article "Burgh, Ulick de," in the *Dict. of Nat. Biography*, and authorities there given; *Hist. of the Irish Confederation*, by R. Bellings, ed. by J. T. Gilbert (1882); *Aphorismical Discovery* (Irish Archaeological Society, 1879); *Memoirs of the Marquis of Clanricarde* (1722, repr. 1744); *Memoirs of Ulick,*

Marquis of Clanricarde, by John, 11th earl (1757); *Life of Ormonde*, by T. Carte (1851); S. R. Gardiner's *Hist. of the Civil War and of the Commonwealth*; *Thomason Tracts* (Brit. Mus.) E 371 (11), 456 (10); *Cal. of State Papers, Irish*, esp. *Introd.* 1633-1647 and *Domestic*; *Hist. MSS. Comm.* *MSS. of Marq. of Ormonde and Earl of Egmont.* (P. C. Y.)

CLANVOWE, SIR THOMAS, the name of an English poet first mentioned in the history of English literature by F. S. Ellis in 1896, when, in editing the text of *The Book of Cupid, God of Love, or The Cuckoo and the Nightingale*, for the Kelmescott Press, he stated that Professor Skeat had discovered that at the end of the best of the MSS. the author was called Clanvowe. In 1897 this information was confirmed and expanded by Professor Skeat in the supplementary volume of his Clarendon Press *Chaucer* (1894-1897). The beautiful romance of *The Cuckoo and the Nightingale* was published by Thynne in 1532, and was attributed by him, and by successive editors down to the days of Henry Bradshaw, to Chaucer. It was due to this error that for three centuries Chaucer was supposed to be identified with the manor of Woodstock, and even painted, in fanciful pictures, as lying

"Under a maple that is fair and green,
Before the chamber-window of the Queen
At Woodstock, upon the green lea."

But this queen could only be Joan of Navarre, who arrived in 1403, three years after Chaucer's death, and it is to the spring of that year that Professor Skeat attributes the composition of the poem. Sir Thomas Clanvowe was of a Herefordshire family, settled near Wigmore. He was a prominent figure in the courts of Richard II. and Henry IV., and is said to have been a friend of Prince Hal. He was one of those who "had begun to mell of Lollardy, and drink the gall of heresy." He was one of the twenty-five knights who accompanied John Beaufort (son of John of Gaunt) to Barbary in 1390.

The date of his birth is unknown, and his name is last mentioned in 1404. The historic and literary importance of *The Cuckoo and the Nightingale* is great. It is the work of a poet who had studied the prosody of Chaucer with more intelligent care than either Occleve or Lydgate, and who therefore forms an important link between the 14th and 15th centuries in English poetry. Clanvowe writes with a surprising delicacy and sweetness, in a five-line measure almost peculiar to himself. Professor Skeat points out a unique characteristic of Clanvowe's versification, namely, the unprecedented freedom with which he employs the suffix of the final *-e*, and rather avoids than seeks elision. *The Cuckoo and the Nightingale* was imitated by Milton in his sonnet to the Nightingale, and was rewritten in modern English by Wordsworth. It is a poem of so much individual beauty, that we must regret the apparent loss of everything else written by a poet of such unusual talent.

See also a critical edition of the *Boke of Cupide* by Dr Erich Vollmer (Berlin, 1898). (E. G.)

CLAPARÈDE, JEAN LOUIS RENÉ ANTOINE ÉDOUARD (1832-1870), Swiss naturalist, was born at Geneva on the 24th of April 1832. He belonged to a French family, some members of which had taken refuge in that city after the revocation of the Edict of Nantes. In 1852 he began to study medicine and natural science at Berlin, where he was greatly influenced by J. Müller and C. G. Ehrenberg, the former being at that period engaged in his important researches on the Echinoderms. In 1855 he accompanied Müller to Norway, and there spent two months on a desolate reef that he might obtain satisfactory observations. The latter part of his stay at Berlin he devoted, along with J. Lachmann, to the study of the Infusoria and Rhizopods. In 1857 he obtained the degree of doctor, and in 1862 he was chosen professor of comparative anatomy at Geneva. In 1859 he visited England, and in company with W. B. Carpenter made a voyage to the Hebrides; and in 1863 he spent some months in the Bay of Biscay. On the appearance of Darwin's work on the *Origin of Species*, he adopted his theories and published a valuable series of articles on the subject in the *Revue Germanique* (1861). During 1865 and 1866 ill-health rendered him incapable of work, and he determined to pass the winter of 1866-1867 in

¹ *Hist. MSS. Comm.*: *MSS. of Earl of Egmont*, i. 223.

Naples. The change of climate produced some amelioration, and his energy was attested by two elaborate volumes on the Annelidae of the gulf. He again visited Naples with advantage in 1868; but in 1870, instead of recovering as before, he grew worse, and on the 31st of May he died at Siena on his way home. His *Recherches sur la structure des annélides sédentaires* were published posthumously in 1873.

CLAPPERTON, HUGH (1788–1827), Scottish traveller in West-Central Africa, was born in 1788 at Annan, Dumfriesshire, where his father was a surgeon. He gained some knowledge of practical mathematics and navigation, and at thirteen was apprenticed on board a vessel which traded between Liverpool and North America. After having made several voyages across the Atlantic he was impressed for the navy, in which he soon rose to the rank of midshipman. During the Napoleonic wars he saw a good deal of active service, and at the storming of Port Louis, Mauritius, in November 1810, he was first in the breach and hauled down the French flag. In 1814 he went to Canada, was promoted to the rank of lieutenant, and to the command of a schooner on the Canadian lakes. In 1817, when the flotilla on the lakes was dismantled, he returned home on half-pay.

In 1820 Clapperton removed to Edinburgh, where he made the acquaintance of Walter Oudney, M.D., who aroused in him an interest in African travel. Lieut. G. F. Lyon, R.N., having returned from an unsuccessful attempt to reach Bornu from Tripoli, the British government determined on a second expedition to that country. Dr Oudney was appointed by Lord Bathurst, then colonial secretary, to proceed to Bornu as consul with the object of promoting trade, and Clapperton and Major Dixon Denham (*q.v.*) were added to the party. From Tripoli, early in 1822, they set out southward to Murzuk, and from this point Clapperton and Oudney visited the Ghat oasis. Kuka, the capital of Bornu, was reached in February 1823, and Lake Chad seen for the first time by Europeans. At Bornu the travellers were well received by the sultan; and after remaining in the country till the 14th of December they again set out for the purpose of exploring the course of the Niger. At Murmur, on the road to Kano, Oudney died (January 1824). Clapperton continued his journey alone through Kano to Sokoto, the capital of the Fula empire, where by order of Sultan Bello he was obliged to stop, though the Niger was only five days' journey to the west. Worn out with his travel he returned by way of Zaria and Katsena to Kuka, where he again met Denham. The two travellers then set out for Tripoli, reached on the 26th of January 1825. An account of the travels was published in 1826 under the title of *Narrative of Travels and Discoveries in Northern and Central Africa in the years 1822–1824*.

Immediately after his return Clapperton was raised to the rank of commander, and sent out with another expedition to Africa, the sultan Bello of Sokoto having professed his eagerness to open up trade with the west coast. Clapperton landed at Badagry in the Bight of Benin, and started overland for the Niger on the 7th of December 1825, having with him his servant Richard Lander (*q.v.*), Captain Pearce, R.N., and Dr Morrison, navy surgeon and naturalist. Before the month was out Pearce and Morrison were dead of fever. Clapperton continued his journey, and, passing through the Yoruba country, in January 1826 he crossed the Niger at Bussa, the spot where Mungo Park had died twenty years before. In July he arrived at Kano. Thence he went to Sokoto, intending afterwards to go to Bornu. The sultan, however, detained him, and being seized with dysentery he died near Sokoto on the 13th of April 1827.

Clapperton was the first European to make known from personal observation the semi-civilized Hausa countries, which he visited soon after the establishment of the Sokoto empire by the Fula. In 1829 appeared the *Journal of a Second Expedition into the Interior of Africa, &c.*, by the late Commander Clapperton, to which was prefaced a biographical sketch of the explorer by his uncle, Lieut.-colonel S. Clapperton. Lander, who had brought back the journal of his master, also published *Records of Captain Clapperton's Last Expedition to Africa . . . with the subsequent Adventures of the Author* (2 vols., London, 1830).

CLAUQUE (Fr. *claque*, to clap the hands), an organized body of professional applauders in the French theatres. The hiring of persons to applaud dramatic performances was common in classical times, and the emperor Nero, when he acted, had his performance greeted by an encomium chanted by five thousand of his soldiers, who were called Angustals. The recollection of this gave the 16th-century French poet, Jean Daurat, an idea which has developed into the modern claque. Buying up a number of tickets for a performance of one of his plays, he distributed them gratuitously to those who promised publicly to express their approbation. It was not, however, till 1820 that a M. Sauton seriously undertook the systematization of the claque, and opened an office in Paris for the supply of *claqueurs*. By 1830 the claque had become a regular institution. The manager of a theatre sends an order for any number of *claqueurs*. These people are usually under a *chef de claque*, whose duty it is to judge where their efforts are needed and to start the demonstration of approval. This takes several forms. Thus there are *commissaires*, those who learn the piece by heart, and call the attention of their neighbours to its good points between the acts. The *rieurs* are those who laugh loudly at the jokes. The *pleureurs*, generally women, feign tears, by holding their handkerchiefs to their eyes. The *chatouilleurs* keep the audience in a good humour, while the *bisseurs* simply clap their hands and cry *bis! bis!* to secure encores.

CLARA, SAINT (1194–1253), foundress of the Franciscan nuns, was born of a knightly family in Assisi in 1194. At eighteen she was so impressed by a sermon of St Francis that she was filled with the desire to devote herself to the kind of life he was leading. She obtained an interview with him, and to test her resolution he told her to dress in penitential sackcloth and beg alms for the poor in the streets of Assisi. Clara readily did this, and Francis, satisfied as to her vocation, told her to come to the Portiuncula arrayed as a bride. The friars met her with lighted candles, and at the foot of the altar Francis shore off her hair, received her vows of poverty, chastity and obedience, and invested her with the Franciscan habit, 1212. He placed her for a couple of years in a Benedictine convent in Assisi, until the convent at St Damian's, close to the town, was ready. Her two younger sisters, and, after her father's death, her mother and many others joined her, and the Franciscan nuns spread widely and rapidly (see CLARES, POOR). The relations of friendship and sympathy between St Clara and St Francis were very close, and there can be no doubt that she was one of the truest heirs of Francis's inmost spirit. After his death Clara threw herself wholly on the side of those who opposed mitigations in the rule and manner of life, and she was one of the chief upholders of St Francis's primitive idea of poverty (see FRANCISCANS). She was the close friend of Brother Leo and the other "Companions of St Francis," and they assisted at her death. For forty years she was abbess at St Damian's, and the great endeavour of her life was that the rule of the nuns should be purged of the foreign elements that had been introduced, and should become wholly conformable to St Francis's spirit. She lived just long enough to witness the fulfilment of her great wish, a rule such as she desired being approved by the pope two days before her death on the 11th of August 1253.

The sources for her life are to be found in the Bollandist *Acta Sanctorum* on the 11th of August, and sketches in such *Lives of the Saints* as Alban Butler's. See also Wetzzer and Welte, *Kirchenlexicon* (2nd ed.), art. "Clara." (E. C. B.)

CLARE, the name of a famous English family. The ancestor of this historic house, "which played," in Freeman's words, "so great a part alike in England, Wales and Ireland," was Count Godfrey, eldest of the illegitimate sons of Richard the Fearless, duke of Normandy. His son, Count Gilbert of Brionne, had two sons, Richard, lord of Bienfaite and Orbec, and Baldwin, lord of Le Sap and Meulles, both of whom accompanied the Conqueror to England. Baldwin, known as "De Meulles" or "of Exeter," received the hereditary shrievalty of Devon with great estates in the West Country, and left three sons, William, Robert and Richard, of whom the first and last were in turn

sheriffs of Devon. Richard, known as "de Bienfaite," or "of Tunbridge," or "of Clare," was the founder of the house of Clare.

Richard derived his English appellation from his strongholds at Tunbridge and at Clare, at both of which his castle-mounds still remain. The latter, on the borders of Essex and Suffolk, was the head of his great "honour" which lay chiefly in the eastern counties. Appointed joint justiciar in the king's absence abroad, he took a leading part in suppressing the revolt of 1075. By his wife, Rohese, daughter of Walter Giffard, through whom great Giffard estates afterwards came to his house, he left five sons and two daughters. Roger was his heir in Normandy, Walter founded Tintern Abbey, Richard was a monk, and Robert, receiving the forfeited fief of the Baynards in the eastern counties, founded, through his son Walter, the house of Fitz-Walter (extinct 1432), of whom the most famous was Robert FitzWalter, the leader of the barons against King John. Of this house, spoken of by Jordan Fantosme as "Clarreus," the Daventrys of Daventry (extinct 1380) and Fawsleys of Fawsley (extinct 1392) were cadets. One of Richard's two daughters married the famous Walter Tirel.

Gilbert, Richard's heir in England, held his castle of Tunbridge against William Rufus, but was wounded and captured. Under Henry I., who favoured the Clares, he obtained a grant of Cardigan, and carried his arms into Wales. Dying about 1115, he left four sons, of whom Gilbert, the second, inherited Chepstow, with Nether-Gwent, from his uncle, Walter, the founder of Tintern, and was created earl of Pembroke by Stephen about 1138; he was father of Richard Strongbow, earl of Pembroke (q.v.). The youngest son Baldwin fought for Stephen at the battle of Lincoln (1141) and founded the priories of Bourne and Deeping on lands acquired with his wife. The eldest son Richard, who was slain by the Welsh on his way to Cardigan in 1135 or 1136, left two sons Gilbert and Roger, of whom Gilbert was created earl of Hertfordshire by Stephen.

It was probably because he and the Clares had no interests in Hertfordshire that they were loosely and usually styled the earls of (de) Clare. Dying in 1152, Gilbert was succeeded by his brother Roger, of whom Fitz-Stephen observes that "nearly all the nobles of England were related to the earl of Clare, whose sister, the most beautiful woman in England, had long been desired by the king" (Henry II.). He was constantly fighting the Welsh for his family possessions in Wales and quarrelled with Becket over Tunbridge Castle. In 1173 or 1174 he was succeeded by his son Richard as third earl, whose marriage with Amicia, daughter and co-heir of William, earl of Gloucester, was destined to raise the fortunes of his house to their highest point. He and his son Gilbert were among the "barons of the Charter," Gilbert, who became fourth earl in 1217, obtained also, early in 1218, the earldom of Gloucester, with its great territorial "Honour," and the lordship of Glamorgan, in right of his mother; "from this time the house of Clare became the acknowledged head of the baronage." Gilbert had also inherited through his father his grandmother's "Honour of St Hilary" and a moiety of the Giffard fief; but the vast possessions of his house were still further swollen by his marriage with a daughter of William (Marshal), earl of Pembroke, through whom his son Richard succeeded in 1245 to a fifth of the Marshall lands including the Kilkenny estates in Ireland. Richard's successor, Gilbert, the "Red" earl, died in 1295, the most powerful subject in the kingdom.

On his death his earldoms seem to have been somewhat mysteriously deemed to have passed to his widow Joan, daughter of Edward I.; for her second husband, Ralph de Monthermer, was summoned to parliament in right of them from 1299 to 1306. After her death, however, in 1307, Earl Gilbert's son and namesake was summoned in 1308 as earl of Gloucester and Hertford, though only sixteen. A nephew of Edward II. and brother-in-law of Gaveston, he played a somewhat wavering part in the struggle between the king and the barons. Guardian of the realm in 1311 and regent in 1313, he fell gloriously at Bannockburn (June 24th, 1314), when only twenty-three, rushing on

the enemy "like a wild boar, making his sword drunk with their blood."

The earl was the last of his mighty line, and his vast possessions in England (in over twenty counties), Wales and Ireland fell to his three sisters, of whom Elizabeth, the youngest, wife of John de Burgh, obtained the "Honour of Clare" and transmitted it to her son William de Burgh, 3rd earl of Ulster, whose daughter brought it to Lionel, son of King Edward III., who was thereupon created duke of Clarence, a title associated ever since with the royal house. The "Honour of Clare," vested in the crown, still preserves a separate existence, with a court and steward of its own.

Clare College, Cambridge, derived its name from the above Elizabeth, "Lady of Clare," who founded it as Clare Hall in 1347.

Clare County in Ireland derives its name from the family, though whether from Richard Strongbow, or from Thomas de Clare, a younger son, who had a grant of Thomond in 1276, has been deemed doubtful.

Clarenceux King of Arms, an officer of the Heralds' College, derives his style, through Clarence, from Clare.

See J. H. Round's *Geoffrey de Mandeville, Feudal England, Commune of London, and Peerage Studies*; also his "Family of Clare" in *Arch. Journ.* lvi., and "Origin of Armorial Bearings" in *Ib.* li.; Parkinson's "Clarence, the origin and bearers of the title," in *The Antiquary*, v.; Clark's "Lords of Glamorgan" in *Arch. Journ.* xxxv.; Planche's "Earls of Gloucester" in *Journ. Arch. Assoc.* xxvi.; Dugdale's *Baronage*, vol. i., and *Monasticon Anglicanum*; G. E. C[o]kayne's *Complete Peerage*. (J. H. R.)

CLARE, JOHN (1795-1864), English poet, commonly known as "the Northamptonshire Peasant Poet," the son of a farm labourer, was born at Helpstone near Peterborough, on the 13th of July 1793. At the age of seven he was taken from school to tend sheep and geese; four years later he began to work on a farm, attending in the winter evenings a school where he is said to have learnt some algebra. He then became a pot-boy in a public-house and fell in love with Mary Joyce, but her father, a prosperous farmer, forbade her to meet him. Subsequently he was gardener at Burghley Park. He enlisted in the militia, tried camp life with gipsies, and worked as a lime burner in 1817, but in the following year he was obliged to accept parish relief. Clare had bought a copy of Thomson's *Seasons* out of his scanty earnings and had begun to write poems. In 1819 a bookseller at Stamford, named Drury, lighted on one of Clare's poems, *The Selling Sun*, written on a scrap of paper enclosing a note to his predecessor in the business. He befriended the author and introduced his poems to the notice of John Taylor, of the publishing firm of Taylor & Hussey, who issued the *Poems Descriptive of Rural Life and Scenery* in 1820. This book was highly praised, and in the next year his *Village Minstrel and other Poems* were published. He was greatly patronized; fame, in the shape of curious visitors, broke the tenor of his life, and the convivial habits that he had formed were indulged more freely. He had married in 1820, and an annuity of 15 guineas from Lord Exeter, in whose service he had been, was supplemented by subscription, and he became possessed of £45 annually, a sum far beyond what he had ever earned, but new wants made his income insufficient, and in 1823 he was nearly penniless. The *Shepherd's Calendar* (1827) met with little success, which was not increased by his hawking it himself. As he worked again on the fields his health temporarily improved; but he soon became seriously ill. Lord Fitzwilliam presented him with a new cottage and a piece of ground, but Clare could not settle in his new home. Gradually his mind gave way. His last and best work, the *Rural Muse* (1835), was noticed by "Christopher North" alone. He had for some time shown symptoms of insanity; and in July 1837 he was removed to a private asylum, and afterwards to the Northampton general lunatic asylum, where he died on the 20th of May 1864. Clare's descriptions of rural scenes show a keen and loving appreciation of nature, and his love-songs and ballads charm by their genuine feeling; but his vogue was no doubt largely due to the interest aroused by his humble position in life.

See the *Life of John Clare*, by Frederick Martin (1865); and *Life and Remains of John Clare*, by J. L. Cherry (1873), which, though not so complete, contains some of the poet's asylum verses and prose fragments.

CLARE, JOHN FITZGIBBON, 1ST EARL OF (1749-1802), lord chancellor of Ireland, was the second son of John Fitzgibbon, who had abandoned the Roman Catholic faith in order to pursue a legal career. He was educated at Trinity College, Dublin, where he was highly distinguished as a classical scholar, and at Christ Church, Oxford, where he graduated in 1770. In 1772 he was called to the Irish bar, and quickly acquired a very lucrative practice; he also inherited his father's large fortune on the death of his elder brother. In 1778 he entered the Irish House of Commons as member for Dublin University, and at first gave a general support to the popular party led by Henry Grattan (*q.v.*). He was, however, from the first hostile to that part of Grattan's policy which aimed at removing the disabilities of the Roman Catholics; he endeavoured to impede the Relief Bill of 1778 by raising difficulties about its effect on the Act of Settlement. He especially distrusted the priests, and many years later explained that his life-long resistance to all concession to the Catholics was based on his "unalterable opinion" that "a conscientious Popish ecclesiastic never will become a well-attached subject to a Protestant state, and that the Popish clergy must always have a commanding influence on every member of that communion." As early as 1780 Fitzgibbon began to separate himself from the popular or national party, by opposing Grattan's declaration of the Irish parliament's right to independence. There is no reason to suppose that in this change of view he was influenced by corrupt or personal motives. His cast of mind naturally inclined to authority rather than to democratic liberty; his hostility to the Catholic claims, and his distrust of parliamentary reform as likely to endanger the connexion of Ireland with Great Britain, made him a sincere opponent of the aims which Grattan had in view. In reply, however, to a remonstrance from his constituents Fitzgibbon promised to support Grattan's policy in the future, and described the claim of Great Britain to make laws for Ireland as "a daring usurpation of the rights of a free people."

For some time longer there was no actual breach between him and Grattan. Grattan supported the appointment of Fitzgibbon as attorney-general in 1783, and in 1785 the latter highly eulogized Grattan's character and services to the country in a speech in which he condemned Flood's volunteer movement. He also opposed Flood's Reform Bill of 1784; and from this time forward he was in fact the leading spirit in the Irish government, and the stiffest opponent of all concession to popular demands. In 1784 the permanent committee of revolutionary reformers in Dublin, of whom Napper Tandy was the most conspicuous, invited the sheriffs of counties to call meetings for the election of delegates to attend a convention for the discussion of reform; and when the sheriff of the county of Dublin summoned a meeting for this purpose Fitzgibbon procured his imprisonment for contempt of court, and justified this procedure in parliament, though Lord Erskine declared it grossly illegal. In the course of the debates on Pitt's commercial propositions in 1785, which Fitzgibbon supported in masterly speeches, he referred to Curran in terms which led to a duel between the two lawyers, when Fitzgibbon was accused of a deliberation in aiming at his opponent that was contrary to etiquette. His antagonism to Curran was life-long and bitter, and after he became chancellor his hostility to the famous advocate was said to have driven the latter out of practice. In January 1787 Fitzgibbon introduced a stringent bill for repressing the Whiteboy outrages. It was supported by Grattan, who, however, procured the omission of a clause enacting that any Roman Catholic chapel near which an illegal oath had been tendered should be immediately demolished. His influence with the majority in the Irish parliament defeated Pitt's proposed reform of the tithe system in Ireland, Fitzgibbon refusing even to grant a committee to investigate the subject. On the regency question in 1789 Fitzgibbon, in opposition to Grattan, supported the doctrine of Pitt in a series of powerful

speeches which proved him a great constitutional lawyer; he intimated that the choice for Ireland might in certain eventualities rest between complete separation from England and legislative union; and, while he exclaimed as to the latter alternative, "God forbid that I should ever see that day!" he admitted that separation would be the worse evil of the two.

In the same year Lord Lifford resigned the chancellorship, and Fitzgibbon was appointed in his place, being raised to the peerage as Baron Fitzgibbon. His removal to the House of Lords greatly increased his power. In the Commons, though he had exercised great influence as attorney-general, his position had been secondary; in the House of Lords and in the privy council he was little less than despotic. "He was," says Lecky, "by far the ablest Irishman who had adopted without restriction the doctrine that the Irish legislature must be maintained in a condition of permanent and unvarying subjection to the English executive." But the English ministry were now embarking on a policy of conciliation in Ireland. The Catholic Relief Bill of 1793 was forced on the Irish executive by the cabinet in London, but it passed rapidly and easily through the Irish parliament. Lord Fitzgibbon, while accepting the bill as inevitable under the circumstances that had arisen, made a most violent though exceedingly able speech against the principle of concession, which did much to destroy the conciliatory effect of the measure; and as a consequence of this act he began persistently to urge the necessity for a legislative union. From this date until the union was carried, the career of Fitzgibbon is practically the history of Ireland. True to his inveterate hostility to the popular claims, he was opposed to the appointment of Lord Fitzwilliam (*q.v.*) as viceroy in 1795, and was probably the chief influence in procuring his recall; and it was Fitzgibbon who first put it into the head of George III. that the king would violate his coronation oath if he consented to the admission of Catholics to parliament. When Lord Camden, Fitzwilliam's successor in the viceroyalty, arrived in Dublin on the 31st of March 1795, Fitzgibbon's carriage was violently assaulted by the mob, and he himself was wounded; and in the riots that ensued his house was also attacked. But as if to impress upon the Catholics the hopelessness of their case, the government who had made Fitzgibbon a viscount immediately after his attack on the Catholics in 1793 now bestowed on him a further mark of honour. In June 1795 he was created earl of Clare. On the eve of the rebellion he warned the government that while emancipation and reform might be the objects aimed at by the better classes, the mass of the disaffected had in view "the separation of the country from her connexion with Great Britain, and a fraternal alliance with the French Republic." Clare advocated stringent measures to prevent an outbreak; but he was neither cruel nor immoderate, and was inclined to mercy in dealing with individuals. He attempted to save Lord Edward Fitzgerald (*q.v.*) from his fate by giving a friendly warning to his friends, and promising to facilitate his escape from the country; and Lord Edward's aunt, Lady Louisa Conolly, who was conducted to his death-bed in prison by the chancellor in person, declared that "nothing could exceed Lord Clare's kindness." His moderation and humanity after the rebellion was extolled by Cornwallis. He threw his great influence on the side of clemency, and it was through his intervention that Oliver Bond, when sentenced to death, was reprieved; and that an arrangement was made by which Arthur O'Connor, Thomas Emmet and other state prisoners were allowed to leave the country.

In October 1798 Lord Clare, who since 1793 had been convinced of the necessity for a legislative union if the connexion between Great Britain and Ireland was to be maintained, and who was equally determined that the union must be unaccompanied by Catholic emancipation, crossed to England and successfully pressed his views on Pitt. In 1799 he induced the Irish House of Lords to throw out a bill for providing a permanent endowment of Maynooth. On the 10th of February 1800 Clare in the House of Lords moved the resolution approving the union in a long and powerful speech, in which he reviewed the history of Ireland since the Revolution, attributing the evils of recent years to the independent constitution of 1782, and speaking of Grattan

in language of deep personal hatred. He was not aware of the assurance which Cornwallis had been authorized to convey to the Catholics that the union was to pave the way for emancipation, and when he heard of it after the passing of the act he bitterly complained that Pitt and Castlereagh had deceived him. After the union Clare became more violent than ever in his opposition to any policy of concession in Ireland. He died on the 28th of January 1802; his funeral in Dublin was the occasion of a riot organized "by a gang of about fourteen persons under orders of a leader." His wife, in compliance with his death-bed request, destroyed all his papers. His two sons, John (1792-1851) and Richard Hobart (1793-1864), succeeded in turn to the earldom, which became extinct on the death of the latter, whose only son, John Charles Henry, Viscount Fitzgibbon (1829-1854), was killed in the charge of the Light Brigade at Balaklava.

Lord Clare was in private life an estimable and even an amiable man; many acts of generosity are related of him; the determination of his character swayed other wills to his purpose, and his courage was such as no danger, no obloquy, no public hatred or violence could disturb. Though not a great orator like Flood or Grattan, he was a skilful and ready debater, and he was by far the ablest Irish supporter of the union. He was, however, arrogant, overbearing and intolerant to the last degree. He was the first Irishman since the Revolution to hold the office of lord chancellor of Ireland. "Except where his furious personal antipathies and his ungovernable arrogance were called into action, he appears to have been," says Lecky, "an able, upright and energetic judge"; but as a politician there can be little question that Lord Clare's bitter and unceasing resistance to reasonable measures of reform did infinite mischief in the history of Ireland, by inflaming the passions of his countrymen, driving them into rebellion, and perpetuating their political and religious divisions.

See W. E. H. Lecky, *History of Ireland in the Eighteenth Century* (5 vols., London, 1892); J. R. O'Flanagan, *The Lives of the Lord Chancellors and Keepers of the Great Seal in Ireland* (2 vols., London, 1870); *Cornwallis Correspondence*, ed. by C. Ross (3 vols., London, 1859); Charles Phillips, *Recollections of Curran and some of his Contemporaries* (London, 1822); Henry Grattan, *Memoirs of the Life and Times of the Right Honble. Henry Grattan* (5 vols., London, 1839-1846); Lord Auckland, *Journal and Correspondence* (4 vols., London, 1861); Charles Coote, *History of the Union of Great Britain and Ireland* (London, 1802). (R. J. M.)

CLARE, a county in the province of Munster, Ireland, bounded N. by Galway Bay and Co. Galway, E. by Lough Derg, the river Shannon, and counties Tipperary and Limerick, S. by the estuary of the Shannon, and W. by the Atlantic Ocean. The area is 852,389 acres, or nearly 1332 sq. m. Although the surface of the county is hilly, and in some parts even mountainous, it nowhere rises to a great elevation. Much of the western baronies of Moyarta and Ibrickan is composed of bog land. Bogs are frequent also in the mountainous districts elsewhere, except in the limestone barony of Burren, the inhabitants of some parts of which supply themselves with turf from the opposite shores of Connemara. Generally speaking, the eastern parts of the county are mountainous, with tracts of rich pasture-land interspersed; the west abounds with bog; and the north is rocky and best adapted for grazing sheep. In the southern part, along the banks of the Fergus and Shannon, are the bands of rich low grounds called corcasses, of various breadth, indenting the land in a great variety of shapes. They are composed of deep rich loam, and are distinguished as the black corcasses, adapted for tillage, and the blue, used more advantageously as meadow land. The coast is in general rocky, and occasionally bold and precipitous in the extreme, as may be observed at the picturesque cliffs of Moher within a few miles of Ennistimon and Lisdoonvarna, which rise perpendicularly at O'Brien's Tower to an elevation of 580 ft. The coast of Clare is indented with several bays, the chief of which are Ballyvaghan, Liscannor and Malbay; but from Black Head to Loop Head, that is, along the entire western boundary of the county formed by the Atlantic, there is no safe harbour except Liscannor Bay. Malbay takes its name from its dangers to navigators, and the whole coast has been the scene of many fatal disasters. The county possesses only one large river,

the Fergus; but nearly 100 m. of its boundary-line are washed by the river Shannon, which enters the Atlantic Ocean between this county and Kerry. The numerous bays and creeks on both sides of this great river render its navigation safe in every wind; but the passage to and from Limerick is often tedious, and the port of Kilrush has from that cause gained in importance. The river Fergus is navigable from the Shannon to the town of Clare, which is the terminating point of its natural navigation, and the port of all the central districts of the county.

There are a great number of lakes and tarns in the county, of which the largest are Loughs Muckanagh, Graney, Atedaun and Dromore; but they are more remarkable for beauty than for size or utility, with the exception of the extensive and navigable Lough Derg, formed by the river Shannon between this county and Tipperary. The salmon fishery of the Shannon, both as a sport and as an industry, is famous; the Fergus also holds salmon, and there is much good trout-fishing in the lakes for which Ennis is a centre, and in the streams of the Atlantic seaboard. Clare is a county which, like all the western counties of Ireland, repays visitors in search of the pleasures of seaside resorts, sport, scenery or antiquarian interest. Yet, again like other western counties, it was long before it was rendered accessible. Communications, however, are now satisfactory.

Geology.—Upper Carboniferous strata cover the county west of Ennis, the coast-sections in them being particularly fine. Shales and sandstones alternate, now horizontal, as in the Cliffs of Moher, now thrown into striking folds. The Carboniferous Limestone forms a barren terraced country, often devoid of soil, through the Burren in the north, and extends to the estuary of the Fergus and the Shannon. On the east, the folding has brought up two bold masses of Old Red Sandstone, with Silurian cores. Slieve Bernagh, the more southerly of these, rises to 1746 ft. above Killaloe, and the hilly country here traversed by the Shannon is in marked contrast with the upper course of the river through the great limestone plain.

Minerals.—Although metals and minerals have been found in many places throughout the county, they do not often show themselves in sufficient abundance to induce the application of capital for their extraction. The principal metals are lead, iron and manganese. The Milltown lead mine in the barony of Tulla is probably one of the oldest mines in Ireland, and formerly, if the extent of the ancient excavations may be taken as a guide, there must have been a very rich deposit. Copper pyrites occurs in several parts of Burren, but in small quantity. Coal exists at Labasheeda on the right bank of the Shannon, but the few and thin seams are not productive. The nodules of clay-ironstone in the strata that overlie the limestone were mined and smelted down to 1750. Within half a mile of the Milltown lead mine are immense natural vaulted passages of limestone, through which the river Ardsullas winds a singular course. The lower limestone of the eastern portion of the county has been found to contain several very large deposits of argentiferous galena. Flags, easily quarried, are procured near Kilrush, and thinner flags near Ennistimon. Slates are quarried in several places, the best being those of Broadford and Killaloe, which are nearly equal to the finest procured in Wales. A species of very fine black marble is obtained near Ennis; it takes a high polish, and is free from the white spots with which the black Kilkenny marble is marked.

The mineral springs, which are found in many places, are chiefly chalybeate. That of Lisdoonvarna, a sulphur spa, about 8 m. from Ennistimon, has been celebrated since the 18th century for its medicinal qualities, and now attracts a large number of visitors annually. It lies 9 m. by road N. of Ennistimon. There are chalybeate springs of less note at Kilkishen, Burren, Broadfoot, Lehinch, Kilkee, Kilrush, Killadysart, and near Milltown Malbay. Springs called by the people "holy" or "blessed" wells, generally mineral waters, are common; but the belief in their power of performing cures in inveterate maladies is nearly extinct.

Watering-places.—The Atlantic Ocean and the estuary of the Shannon afford many situations admirably adapted for summer bathing-places. Among the most frequented of these localities are Milltown Malbay, with one of the best beaches on the western coast; and the neighbouring Spanish Point (named from the scene of the wreck of two ships of the Armada); Lehinch, about

2 m. from Ennistimon on Liscannor Bay, and near the interesting cliffs of Moher, has a magnificent beach. Kilkee is the most fashionable watering-place on the western coast of Ireland; and Kilrush on the Shannon estuary is also favoured.

Industries.—The soil and surface of the county are in general better adapted for grazing than for tillage, and the acreage devoted to the former consequently exceeds three times that of the latter. Agriculture is in a backward state, and not a fifth of the total area is under cultivation, while the acreage shows a decrease even in the principal crops of oats and potatoes. Cattle, sheep, poultry and pigs, however, all receive considerable attention. Owing to the mountainous nature of the county nearly one-seventh of the total area is quite barren.

There are no extensive manufactures, although flannels and friezes are made for home use, and hosiery of various kinds, chiefly coarse and strong, is made around Ennistimon and other places. There are several fishing stations on the coast, and cod, haddock, ling, sole, turbot, ray, mackerel and other fish abound, but the rugged nature of the coast and the tempestuous sea greatly hinder the operations of the fishermen. Near Pooldoody is the great Burren oyster bed called the Red Bank, where a large establishment is maintained, from which a constant supply of the excellent Red Bank oysters is furnished to the Dublin and other large markets. Crabs and lobsters are caught on the shores of the Bay of Galway in every creek from Black Head to Ardfrý. In addition to the Shannon salmon fishery mentioned above, eels abound in every rivulet, and form an important article of consumption.

The Great Southern & Western railway line from Limerick to Sligo intersects the centre of the county from north to south. From Ennis on this line the West Clare railway runs to Ennistimon on the coast, where it turns south and follows the coast by Milltown Malbay to Kilkee and Kilrush. Killaloe in the east of the county is the terminus of a branch of the Great Southern & Western railway.

Population and Administration.—The population (126,244 in 1891; 112,334 in 1901; almost wholly Roman Catholic and rural) shows a decrease among the most serious of the Irish counties, and the emigration returns are proportionately heavy. The principal towns, all of insignificant size, are Ennis (pop. 5093, the county town), Kilrush (4179), Kilkee (1661) and Killaloe (885); but several of the smaller settlements, as resorts, are of more than local importance. The county, which is divided into 11 baronies, contains 79 parishes, and includes the Protestant diocese of Kilfenora, the greater part of Killaloe, and a very small portion of the diocese of Limerick. It is within the Roman Catholic dioceses of Killaloe and Limerick. The assizes are held at Ennis, and quarter sessions here and at Ennistimon, Killaloe, Kilrush and Tulla. The county is divided into the East and West parliamentary divisions, each returning one member.

History.—This county, together with part of the neighbouring district, was anciently called Thomond, that is, North Munster, and formed part of the monarchy of the celebrated Brian Boroihme, who held his court at Kincora near Killaloe, where his palace was situated on the banks of the Shannon. The site is still distinguished by extensive earthen ramparts. Settlements were effected by the Danes, and in the 13th century by the Anglo-Normans, but without permanently affecting the possession of the district by its native proprietors. In 1543 Murrough O'Brien, after dispossessing his nephew and vainly attempting a rebellion against the English rule, proceeded to England and submitted to Henry VIII., resigning his name and possessions. He soon received them back by an English tenure, together with the title of earl of Thomond, on condition of adopting the English dress, manners and customs. In 1565 this part of Thomond (sometimes called O'Brien's country) was added to Connaught, and made one of the six new counties into which that province was divided by Sir Henry Sidney. It was named Clare, the name being traceable either to Richard de Clare (Strongbow), earl of Pembroke, or to his younger brother, Thomas de Clare, who obtained a grant of Thomond

from Edward I. in 1276, and whose family for some time maintained a precarious position in the district. Towards the close of the reign of Elizabeth, Clare was detached from the government of Connaught and given a separate administration; but at the Restoration it was reunited to Munster.

Antiquities.—The county abounds with remains of antiquities, both military and ecclesiastical, especially in the north-western part. There still exist above a hundred fortified castles, several of which are inhabited. They are mostly of small extent, a large portion being fortified dwellings. The chief of them is Bunratty Castle, built in 1277, once inhabited by the earls of Thomond, 10 m. W. of Limerick, on the Shannon. Those of Ballykinvarga, Ballynalackan and Lemaneagh, all in the north-west, should also be mentioned. Rath or encampments are to be found in every part. They are generally circular, composed either of large stones without mortar or of earth thrown up and surrounded by one or more ditches. The list of abbeys and other religious houses formerly flourishing here (some now only known by name, but many of them surviving in ruins) comprehends upwards of twenty. The most remarkable are—Quin, considered one of the finest and most perfect specimens of ancient monastic architecture in Ireland; Corcomroe; Ennis, in which is a very fine window of uncommonly elegant workmanship; and those on Inniscattery or Scattery Island, in the Shannon, said to have been founded by St Senan (see KILRUSH). Kilfenora, 5 m. N.E. of Ennistimon, was until 1752 a separate diocese, and its small cathedral is of interest, with several neighbouring crosses and a holy well. The ruined churches of Kilnaboy, Nouhaval and Teampul Cronan are the most noteworthy of many in the north-west. Five round towers are to be found in various stages of preservation—at Scattery Island, Drumcliffe, Dysert O'Dea, Kilnaboy and Inniscaltra (Lough Derg). The cathedral of the diocese of Killaloe is at the town of that name. Cromlechs are found, chiefly in the rocky limestone district of Burren in the N.W., though there are some in other baronies. That at Ballygannor is formed of a stone 40 ft. long and 10 broad.

See papers by T. J. Westropp in *Proceedings of the Royal Irish Academy*—"Distribution of Cromlechs in County Clare" (1897); and "Churches of County Clare, and Origin of Ecclesiastical Divisions" (1900).

CLAREMONT, a city of Sullivan county, New Hampshire, U.S.A., situated in the W. part of the state, bordering on the Connecticut river. Pop. (1890) 5565; (1900) 6498 (1442 foreign-born); (1910) 7529. Area, 6 sq. m. It is served by two branches of the Boston & Maine railway. In Claremont is the Fiske free library (1873), housed in a Carnegie building (1904). The Stevens high school is richly endowed by the gift of Paran Stevens, a native of Claremont. The city contains several villages, the principal being Claremont, Claremont Junction and West Claremont. Sugar river, flowing through the city into the Connecticut and falling 223 ft. within the city limits, furnishes good water-power. Among the manufactures are woollen and cotton goods, paper, mining and quarrying machinery, rubber goods, linens, shoes, wood trim and pearl buttons. The first settlement here was made in 1762, and a township was organized in 1764; in 1908 Claremont was chartered as a city. It was named from Claremont, Lord Clive's country place.

CLARENCE, DUKES OF. The early history of this English title is identical with that of the family of Clare (*q.v.*), earls of Gloucester, who are sometimes called earls of Clare, of which word Clarence is a later form. The first duke of Clarence was Lionel of Antwerp (see below), third son of Edward III., who was created duke in 1362, and whose wife Elizabeth was a direct descendant of the Clares, the "Honour of Clare" being among the lands which she brought to her husband. When Lionel died without sons in 1368 the title became extinct; but in 1412 it was revived in favour of Thomas (see below), the second son of Henry IV. The third creation of a duke of Clarence took place in 1461, and was in favour of George (see below), brother of the King Edward IV. When this duke, accused by

the king, was attainted and killed in 1478, his titles and estates were forfeited. There appears to have been no other creation of a duke of Clarence until 1789, when William, third son of George III., was made a peer under this title. Having merged in the crown when William became king of Great Britain and Ireland in 1830, the title of duke of Clarence was again revived in 1890 in favour of Albert Victor (1864-1892), the elder son of King Edward VII., then prince of Wales, only to become extinct for the fifth time on his death in 1892.

LIONEL OF ANTWERP, duke of Clarence (1338-1368), third son of Edward III., was born at Antwerp on the 29th of November 1338. Betrothed when a child to Elizabeth (d. 1363), daughter and heiress of William de Burgh, 3rd earl of Ulster (d. 1332), he was married to her in 1352; but before this date he had entered nominally into possession of her great Irish inheritance. Having been named as his father's representative in England in 1345 and again in 1346, Lionel was created earl of Ulster, and joined an expedition into France in 1355, but his chief energies were reserved for the affairs of Ireland. Appointed governor of that country, he landed at Dublin in 1361, and in November of the following year was created duke of Clarence, while his father made an abortive attempt to secure for him the crown of Scotland. His efforts to secure an effective authority over his Irish lands were only moderately successful; and after holding a parliament at Kilkenny, which passed the celebrated statute of Kilkenny in 1367, he threw up his task in disgust and returned to England. About this time a marriage was arranged between Clarence and Violante, daughter of Galeazzo Visconti, lord of Pavia (d. 1378); the enormous dowry which Galeazzo promised with his daughter being exaggerated by the rumour of the time. Journeying to fetch his bride, the duke was received in great state both in France and Italy, and was married to Violante at Milan in June 1368. Some months were then spent in festivities, during which Lionel was taken ill at Alba, where he died on the 7th of October 1368. His only child Philippa, a daughter by his first wife, married in 1368 Edmund Mortimer, 3rd earl of March (1351-1381), and through this union Clarence became the ancestor of Edward IV. The poet Chaucer was at one time a page in Lionel's household.

THOMAS, duke of Clarence (c. 1388-1421), who was nominally lieutenant of Ireland from 1401 to 1413, and was in command of the English fleet in 1405, acted in opposition to his elder brother, afterwards King Henry V., and the Beauforts during the later part of the reign of Henry IV.; and was for a short time at the head of the government, leading an unsuccessful expedition into France in 1412. When Henry V., however, became king in 1413 no serious dissensions took place between the brothers, and as a member of the royal council Clarence took part in the preparations for the French war. He was with the English king at Harfleur, but not at Agincourt, and shared in the expedition of 1417 into Normandy, during which he led the assault on Caen, and distinguished himself as a soldier in other similar undertakings. When Henry V. returned to England in 1421, the duke remained in France as his lieutenant, and was killed at Beaugé whilst rashly attacking the French and their Scottish allies on the 22nd of March 1421. He left no legitimate issue, and the title again became extinct.

GEORGE, duke of Clarence (1449-1478), younger son of Richard, duke of York, by his wife Cicely, daughter of Ralph Neville, 1st earl of Westmorland, was born in Dublin on the 21st of October 1449. Soon after his elder brother became king as Edward IV. in March 1461, he was created duke of Clarence, and his youth was no bar to his appointment as lord-lieutenant of Ireland in the following year. Having been mentioned as a possible husband for Mary, daughter of Charles the Bold, afterwards duke of Burgundy, Clarence came under the influence of Richard Neville, earl of Warwick, and in July 1469 was married at Calais to the earl's elder daughter Isabella. With his father-in-law he then acted in a disloyal manner towards the king. Both supported the rebels in the north of England, and when their treachery was discovered Clarence was deprived of his office as lord-lieutenant and fled to France. Returning to

England with Warwick in September 1470, he witnessed the restoration of Henry VI., when the crown was settled upon himself in case the male line of Henry's family became extinct. The good understanding, however, between Warwick and his son-in-law was not lasting, and Clarence was soon secretly reconciled with Edward. The public reconciliation between the brothers took place when the king was besieging Warwick in Coventry, and Clarence then fought for the Yorkists at Barnet and Tewkesbury. After Warwick's death in April 1471 Clarence appears to have seized the whole of the vast estates of the earl, and in March 1472 was created by right of his wife earl of Warwick and Salisbury. He was consequently greatly disturbed when he heard that his younger brother Richard, duke of Gloucester, was seeking to marry Warwick's younger daughter Anne, and was claiming some part of Warwick's lands. A violent quarrel between the brothers ensued, but Clarence was unable to prevent Gloucester from marrying, and in 1474 the king interfered to settle the dispute, dividing the estates between his brothers. In 1477 Clarence was again a suitor for the hand of Mary, who had just become duchess of Burgundy. Edward objected to the match, and Clarence, jealous of Gloucester's influence, left the court. At length Edward was convinced that Clarence was aiming at his throne. The duke was thrown into prison, and in January 1478 the king unfolded the charges against his brother to the parliament. He had slandered the king; had received oaths of allegiance to himself and his heirs; had prepared for a new rebellion; and was in short incorrigible. Both Houses of Parliament passed the bill of attainder, and the sentence of death which followed was carried out on the 17th or 18th of February 1478. It is uncertain what share Gloucester had in his brother's death; but soon after the event the rumour gained ground that Clarence had been drowned in a butt of malmsey wine. Two of the duke's children survived their father: Margaret, countess of Salisbury (1473-1541), and Edward, earl of Warwick (1475-1499), who passed the greater part of his life in prison and was beheaded in November 1499.

On the last-named see W. Stubbs, *Constitutional History*, vol. iii. (Oxford, 1895); Sir J. H. Ramsay, *Lancaster and York* (Oxford, 1892); C. W. C. Oman, *Warwick the Kingmaker* (London, 1891). On the title generally see G. E. C. (okayne), *Complete Peerage* (1887-1898).

CLARENDON, EDWARD HYDE, 1ST EARL OF (1609-1674), English historian and statesman, son of Henry Hyde of Dinton, Wiltshire, a member of a family for some time established at Norbury, Cheshire; was born on the 18th of February 1609. He entered Magdalen Hall, Oxford, in 1622 (having been refused a demyship at Magdalen College), and graduated B.A. in 1626. Intended originally for holy orders, the death of two elder brothers made him his father's heir, and in 1625 he entered the Middle Temple. At the university his abilities were more conspicuous than his industry, and at the bar his time was devoted more to general reading and to the society of eminent scholars and writers than to the study of law treatises. This wandering from the beaten track, however, was not without its advantages. In later years Clarendon declared "next the immediate blessing and providence of God Almighty" that he "owed all the little he knew and the little good that was in him to the friendships and conversation . . . of the most excellent men in their several kinds that lived in that age."¹ These included Ben Jonson, Selden, Waller, Hales, and especially Lord Falkland; and from their influence and the wide reading in which he indulged, he doubtless drew the solid learning and literary talent which afterwards distinguished him.

In 1629 he married his first wife, Anne, daughter of Sir George Ayliffe, who died six months afterwards; and secondly, in 1634, Frances, daughter of Sir Thomas Aylesbury, Master of Requests. In 1633 he was called to the bar, and obtained quickly a good position and practice. His marriages had gained for him influential friends, and in December 1634 he was made keeper of the writs and rolls of the common pleas; while his able conduct of the petition of the London merchants against Portland earned Laud's approval. He was returned to the Short Parliament

¹ *Life*, i. 25.

in 1640 as member for Wootton Bassett. Respect and veneration for the law and constitution of England were already fundamental principles with Hyde, and the flagrant violations and perversions of the law which characterized the twelve preceding years of absolute rule drove him into the ranks of the popular party. He served on numerous and important committees, and his parliamentary action was directed chiefly towards the support and restoration of the law. He assailed the jurisdiction of the earl marshal's court, and in the Long Parliament, in which he sat for Saltash, renewed his attacks and practically effected its suppression. In 1641 he served on the committees for inquiring into the status of the councils of Wales and of the North, distinguished himself by a speech against the latter, and took an important part in the proceedings against the judges. He supported Strafford's impeachment, and did not vote against the attainder, subsequently making an unsuccessful attempt through Essex to avert the capital penalty.¹ Hyde's allegiance, however, to the church of England was as staunch as his support of the law, and was soon to separate him from the popular faction. In February 1641 he opposed the reception of the London petition against episcopacy, and in May the project for unity of religion with the Scots, and the bill for the exclusion of the clergy from secular office. He showed special energy in his opposition to the Root and Branch Bill, and, though made chairman of the committee on the bill on the 11th of July in order to silence his opposition, he caused by his successful obstruction the failure of the measure. In consequence he was summoned to the king's presence, and encouraged in his attitude, and at the beginning of the second session was regarded as one of the king's ablest supporters in the Commons. He considered the claims put forward at this time by parliament as a violation and not as a guarantee of the law and constitution. He opposed the demand by the parliament to choose the king's ministers, and also the Grand Remonstrance, to which he wrote a reply published by the king.

He now definitely though not openly joined the royal cause, and refused office in January 1642 with Colepeper and Falkland in order to serve the king's interests more effectually. Charles undertook to do nothing in the Commons without their advice. Nevertheless a few days afterwards, without their knowledge and by the advice of Lord Digby, he attempted the arrest of the five members, a resort to force which reduced Hyde to despair, and which indeed seemed to show that things had gone too far for an appeal to the law. He persevered, nevertheless, in his legal policy, to which Charles after the failure of his project again returned, joined the king openly in June, and continued to compose the king's answers and declarations in which he appealed to the "known Laws of the land" against the arbitrary and illegal acts of a seditious majority in the parliament, his advice to the king being "to shelter himself wholly under the law, . . . presuming that the king and the law together would have been strong enough for any encounter." Hyde's appeal had great influence, and gained for the king's cause half the nation. It by no means, however, met with universal support among the royalists, Hobbes jeering at Hyde's love for "mixed monarchy," and the courtiers expressing their disapproval of the "spirit of accommodation" which "wounded the regality." It was destined to failure owing principally to the invincible distrust of Charles created in the parliament leaders, and to the fact that Charles was simultaneously carrying on another and an inconsistent policy, listening to very different advisers, such as the queen and Digby, and resolving on measures (such as the attempt on Hull) without Hyde's knowledge or approval.

War, accordingly, in spite of his efforts, broke out. He was expelled the House of Commons on the 11th of August 1642, and was one of those excepted later from pardon. He showed great activity in collecting loans, was present at Edgehill, though not as a combatant, and followed the king to Oxford, residing at All Souls College from October 1642 till March 1645. On the 22nd of

February he was made a privy councillor and knighted, and on the 3rd of March appointed chancellor of the exchequer. He was an influential member of the "Junto" which met every week to discuss business before it was laid before the council. His aim was to gain over some of the leading Parliamentarians by personal influence and personal considerations, and at the Uxbridge negotiations in January 1645, where he acted as principal manager on the king's side, while remaining firm on the great political questions such as the church and the militia, he tried to win individuals by promises of places and honours. He promoted the assembly of the Oxford parliament in December 1643 as a counterpoise to the influence and status of the Long Parliament. Hyde's policy and measures, however, all failed. They had been weakly and irregularly supported by the king, and were fiercely opposed by the military party, who were jealous of the civil influence, and were urging Charles to trust to force and arms alone and eschew all compromise and concessions. Charles fell now under the influence of persons devoid of all legal and constitutional scruples, sending to Glamorgan in Ireland "those strange powers and instructions inexcusable to justice, piety and prudence."²

Hyde's influence was much diminished, and on the 4th of March 1645 he left the king for Bristol as one of the guardians of the prince of Wales and governors of the west. Here the disputes between the council and the army paralysed the proceedings, and lost, according to Hyde, the finest opportunity since the outbreak of the war of raising a strong force and gaining substantial victories in that part of the country. After Hopton's defeat on the 16th of February 1646, at Torrington, Hyde accompanied the prince, on the 4th of March, to Scilly, and on the 17th of April, for greater security, to Jersey. He strongly disapproved of the prince's removal to France by the queen's order and of the schemes of assistance from abroad, refused to accompany him, and signed a bond to prevent the sale of Jersey to the French supported by Jermyn. He opposed the projected sacrifice of the church to the Scots and the grant by the king of any but personal or temporary concessions, declaring that peace was only possible "upon the old foundations of government in church and state." He was especially averse to Charles's tampering with the Irish Romanists. "Oh, Mr Secretary," he wrote to Nicholas, "those stratagems have given me more sad hours than all the misfortunes in war which have befallen the king and look like the effects of God's anger towards us."³ He refused to compound for his own estate. While in Jersey he resided first at St Helier and afterwards at Elizabeth Castle with Sir George Carteret. He composed the first portion of his *History* and kept in touch with events by means of an enormous correspondence. In 1648 he published *A Full answer to an infamous and traitorous Pamphlet . . .*, a reply to the resolution of the parliament to present no more addresses to the king and a vindication of Charles.

On the outbreak of the second Civil War Hyde left Jersey (26th of June 1648) to join the queen and prince at Paris. He landed at Dieppe, sailed from that port to Dunkirk, and thence followed the prince to the Thames, where Charles had met the fleet, but was captured and robbed by a privateer, and only joined the prince in September after the latter's return to the Hague. He strongly disapproved of the king's concessions at Newport. When the army broke off the treaty and brought Charles to trial he endeavoured to save his life, and after the execution drew up a letter to the several European sovereigns invoking their assistance to avenge it. Hyde strongly opposed Charles II.'s ignominious surrender to the Covenanters, the alliance with the Scots, and the Scottish expedition, desiring to accomplish whatever was possible there through Montrose and the royalists, and inclined rather to an attempt in Ireland. His advice was not followed, and he gladly accepted a mission with Cottington to Spain to obtain money from the Roman Catholic powers, and to arrange an alliance between Owen O'Neill and Ormonde for the recovery of Ireland, arriving at Madrid on the 26th of November 1649. The defeat, however, of Charles at Dunbar, and the confirmation of Cromwell's ascendancy, influenced the Spanish government

¹ *Hist. of the Rebellion*, iii. 164, the account being substantially accepted by Gardiner, in spite of inaccuracies in details (*Hist.* ix. 341, note).

² *Clarendon St. Pap.* ii. 337.

³ *Ibid.*

against them, and they were ordered to leave in December 1650. Hyde arrived at Antwerp in January 1651, and in December rejoined Charles at Paris after the latter's escape from Worcester. He now became one of his chief advisers, accompanying him in his change of residence to Cologne in October 1654 and to Bruges in 1658, and was appointed lord chancellor on the 13th of January 1658. His influence was henceforth maintained in spite of the intrigues of both Romanists and Presbyterians, as well as the violent and openly displayed hostility of the queen, and was employed unremittingly in the endeavour to keep Charles faithful to the church and constitution, and in the prevention of unwise concessions and promises which might estrange the general body of the royalists. His advice to Charles was to wait upon the turn of events, "that all his activity was to consist in carefully avoiding to do anything that might do him hurt and to expect some blessed conjuncture."¹ In 1656, during the war between England and Spain, Charles received offers of help from the latter power provided he could gain a port in England, but Hyde discouraged small isolated attempts. He expected much from Cromwell's death. The same year he made an alliance with the Levellers, and was informed of their plots to assassinate the protector, without apparently expressing any disapproval.² He was well supplied with information from England,³ and guided the action of the royalists with great ability and wisdom during the interval between Cromwell's death and the Restoration, urged patience, and advocated the obstruction of a settlement between the factions contending for power and the fomentation of their jealousies, rather than premature risings.

The Restoration was a complete triumph for Hyde's policy. He lays no stress on his own great part in it, but it was owing to him that the Restoration was a national one, by the consent and invitation of parliament representing the whole people and not through the medium of one powerful faction enforcing its will upon a minority, and that it was not only a restoration of Charles but a restoration of the monarchy. By Hyde's advice concessions to the inconvenient demands of special factions had been avoided by referring the decision to a "free parliament," and the declaration of Breda reserved for parliament the settlement of the questions of amnesty, religious toleration and the proprietorship of forfeited lands.

Hyde entered London with the king, all attempts at effecting his fall having failed, and immediately obtained the chief place in the government, retaining the chancellorship of the exchequer till the 13th of May 1661, when he surrendered it to Lord Ashley. He took his seat as speaker of the House of Lords and in the court of chancery on the 1st of June 1660. On the 3rd of November 1660 he was made Baron Hyde of Hindon, and on the 20th of April 1661 Viscount Combray and earl of Clarendon, receiving a grant from the king of £20,000 and at different times of various small estates and Irish rents. The marriage of his daughter Anne to James, duke of York, celebrated in secret in September 1660, at first alarmed Clarendon on account of the public hostility he expected thereby to incur, but finding his fears unconfirmed he acquiesced in its public recognition in December, and thus became related in a special manner to the royal family and the grandfather of two English sovereigns.⁴

Clarendon's position was one of great difficulties, but at the same time of splendid opportunities. In particular a rare occasion now offered itself of settling the religious question on a broad principle of comprehension or toleration; for the monarchy had been restored not by the supporters of the church alone but largely by the influence and aid of the nonconformists and also of the Roman Catholics, who were all united at that happy

¹ *Hist. of the Rebellion*, xiii. 140.

² *Clarendon State Papers*, iii. 316, 325, 341, 343.

³ *Hist. MSS. Comm.*: *MSS. of F. W. Leyborne-Popham*, 227.

⁴ Anne Hyde (1637-1671), eldest daughter of the chancellor, was the mother by James of Queen Mary and Queen Anne, besides six other children, including four sons who all died in infancy. She became a Roman Catholic in 1670 shortly before her death, and was buried in the vault of Mary, queen of Scots, in Henry VII.'s chapel in Westminster Abbey.

moment by a common loyalty to the throne. Clarendon appears to have approved of comprehension but not of toleration. He had already in April 1660 sent to discuss terms with the leading Presbyterians in England, and after the Restoration offered bishoprics to several, including Richard Baxter. He drew up the royal declaration of October, promising limited episcopacy and a revised prayer-book and ritual, which was subsequently thrown out by parliament, and he appears to have anticipated some kind of settlement from the Savoy Conference which sat in April 1661. The failure of the latter proved perhaps that the differences were too great for compromise, and widened the breach. The parliament immediately proceeded to pass the series of narrow and tyrannical measures against the dissenters known as the Clarendon Code. The Corporations Act, obliging members of corporations to denounce the Covenant and take the sacrament according to the Anglican usage, became law on the 20th of December 1661, the Act of Uniformity enforcing the use of the prayer-book on ministers, as well as a declaration that it was unlawful to bear arms against the sovereign, on the 10th of May 1662, and these were followed by the Conventicle Act in 1664 suppressing conventicles and by the Five-Mile Act in 1665 forbidding ministers who had refused subscription to the Act of Uniformity to teach or reside within 5 m. of a borough. Clarendon appears to have reluctantly acquiesced in these civil measures rather than to have originated them, and to have endeavoured to mitigate their injustice and severity. He supported the continuance of the tenure by presbyterian ministers of livings not held by Anglicans and an amendment in the Lords allowing a pension to those deprived, earning the gratitude of Baxter and the nonconformists. On the 17th of March 1662 he introduced into parliament a declaration enabling the king to dispense with the Act of Uniformity in the case of ministers of merit.⁵ But once committed to the narrow policy of intolerance, Clarendon was inevitably involved in all its consequences. His characteristic respect for the law and constitution rendered him hostile to the general policy of indulgence, which, though the favourite project of the king, he strongly opposed in the Lords, and in the end caused its withdrawal. He declared that he could have wished the law otherwise, "but when it was passed, he thought it absolutely necessary to see obedience paid to it without any connivance."⁶ Charles was greatly angered. It was believed in May 1663 that the intrigues of Bennet and Buckingham, who seized the opportunity of ingratiating themselves with the king by zealously supporting the indulgence, had secured Clarendon's dismissal, and in July Bristol ventured to accuse him of high treason in the parliament; but the attack, which did not receive the king's support, failed entirely and only ended in the banishment from court of its promoter. Clarendon's opposition to the court policy in this way acquired a personal character, and he was compelled to identify himself more completely with the intolerant measures of the House of Commons. Though not the originator of the Conventicle Act or of the Five-Mile Act, he has recorded his approval,⁷ and he ended by taking alarm at plots and rumours and by regarding the great party of nonconformists, through whose co-operation the monarchy had been restored, as a danger to the state whose "faction was their religion."⁸

Meanwhile Clarendon's influence and direction had been predominant in nearly all departments of state. He supported the exception of the actual regicides from the Indemnity, but only ten out of the twenty-six condemned were executed, and Clarendon, with the king's support, prevented the passing of a bill in 1661 for the execution of thirteen more. He upheld the Act of Indemnity against all the attempts of the royalists to upset it. The conflicting claims to estates were left to be decided by the law. The confiscations of the usurping government accordingly were cancelled, while the properly executed transactions

⁵ See *Hist. MSS. Comm.*: *Various Collections*, ii. 118, and *MSS. of Duke of Somerset*, 94.

⁶ *Continuation*, 339.

⁷ *Ib.* 511, 776.

⁸ *Lister's Life of Clarendon*, ii. 295; *Hist. MSS. Comm.*: *Various Collections*, ii. 379.

between individuals were necessarily upheld. There can be little doubt that the principle followed was the only safe one in the prevailing confusion. Great injustice was indeed suffered by individuals, but the proper remedy of such injustice was the benevolence of the king, which there is too much reason to believe proved inadequate and partial. The settlement of the church lands which was directed by Clarendon presented equal difficulties and involved equal hardships. In settling Scotland Clarendon's aim was to make that kingdom dependent upon England and to uphold the Cromwellian union. He proposed to establish a council at Whitehall to govern Scottish affairs, and showed great zeal in endeavouring to restore episcopacy through the medium of Archbishop Sharp. His influence, however, ended with the ascendancy of Lauderdale in 1663. He was, to some extent at least, responsible for the settlement in Ireland, but, while anxious for an establishment upon a solid Protestant basis, urged "temper and moderation and justice" in securing it. He supported Ormonde's wise and enlightened Irish administration, and in particular opposed persistently the prohibition of the import of Irish cattle into England, incurring thereby great unpopularity. He showed great activity in the advancement of the colonies, to whom he allowed full freedom of religion. He was a member of the council for foreign plantations, and one of the eight lords proprietors of Carolina in 1663; and in 1664 sent a commission to settle disputes in New England. In the department of foreign affairs he had less influence. His policy was limited to the maintenance of peace "necessary for the reducing [the king's] own dominions into that temper of subjection and obedience as they ought to be in."¹ In 1664 he demanded, on behalf of Charles, French support, and a loan of £50,000 against disturbance at home, and thus initiated that ignominious system of pensions and dependence upon France which proved so injurious to English interests later. But he was the promoter neither of the sale of Dunkirk on the 27th of October 1662, the author of which seems to have been the earl of Sandwich,² nor of the Dutch War. He attached considerable value to the possession of the former, but when its sale was decided he conducted the negotiations and effected the bargain. He had zealously laboured for peace with Holland, and had concluded a treaty for the settlement of disputes on the 4th of September 1662. Commercial and naval jealousies, however, soon involved the two states in hostilities. Cape Corso and other Dutch possessions on the coast of Africa, and New Amsterdam in America, were seized by squadrons from the royal navy in 1664, and hostilities were declared on the 22nd of February 1665. Clarendon now gave his support to the war, asserted the extreme claims of the English crown over the British seas, and contemplated fresh cessions from the Dutch and an alliance with Sweden and Spain. According to his own account he initiated the policy of the Triple Alliance,³ but it seems clear that his inclination towards France continued in spite of the intervention of the latter state in favour of Holland; and he took part in the negotiations for ending the war by an undertaking with Louis XIV. implying a neutrality, while the latter seized Flanders. The crisis in this feeble foreign policy and in the general official mismanagement was reached in June 1667, when the Dutch burnt several ships at Chatham and when "the roar of foreign guns were heard for the first and last time by the citizens of London."⁴

The whole responsibility for the national calamity and disgrace, and for the ignominious peace which followed it, was unjustly thrown on the shoulders of Clarendon, though it must be admitted that the disjointed state of the administration and want of control over foreign policy were largely the causes of the disaster, and for these Clarendon's influence and obstruction of official reforms were to some extent answerable. According to Sir William Coventry, whose opinion has weight and who acknowledges the chancellor's fidelity to the king, while Clarendon "was

so great at the council board and in the administration of matters, there was no room for anybody to propose any remedy to what was remiss . . . he managing all things with that greatness which will now be removed."⁵ He disapproved of the system of boards and committees instituted during the Commonwealth, as giving too much power to the parliament, and regarded the administration by the great officers of state, to the exclusion of pure men of business, as the only method compatible with the dignity and security of the monarchy. The lowering of the prestige of the privy council, and its subordination first to the parliament and afterwards to the military faction, he considered as one of the chief causes of the fall of Charles I. He aroused a strong feeling of hostility in the Commons by his opposition to the appropriation of supplies in 1665, and to the audit of the war accounts in 1666, as "an introduction to a commonwealth" and as "a new encroachment," and by his high tone of prerogative and authority, while by his advice to Charles to prorogue parliament he incurred their resentment and gave colour to the accusation that he had advised the king to govern without parliaments. He was unpopular among all classes, among the royalists on account of the Act of Indemnity, among the Presbyterians because of the Act of Uniformity. It was said that he had invented the maxim "that the king should buy and reward his enemies and do little for his friends, because they are his already"⁶ Every kind of maladministration was currently ascribed to him, of designs to govern by a standing army, and of corruption. He was credited with having married Charles purposely to a barren queen in order to raise his own grandchildren to the throne, with having sold Dunkirk to France, and his magnificent house in St James's was nicknamed "Dunkirk House," while on the day of the Dutch attack on Chatham the mob set up a gibbet at his gate and broke his windows. He had always been exceedingly unpopular at court, and kept severely aloof from the revels and licence which reigned there. Evelyn names "the buffoons and the misses to whom he was an eyesore."⁷ He was intensely disliked by the royal mistresses, whose favour he did not condescend to seek, and whose presence and influence were often the subject of his reproaches.⁸ A party of younger men of the king's own age, more congenial to his temperament, and eager to drive the old chancellor from power and to succeed him in office, had for some time been endeavouring to undermine his influence by ridicule and intrigue. Surrounded by such general and violent animosity, Clarendon's only hope could be in the support of the king. But the chancellor had early and accurately gauged the nature and extent of the king's attachment to him, which proceeded neither from affection nor gratitude but "from his aversion to be troubled with the intricacies of his affairs," and in 1661 he had resisted the importunities of Ormonde to resign the great seal for the lord treasurership with the rank of "first minister," "a title newly translated out of French into English," on account of the obloquy this position would incur and the further dependence which it entailed upon the inconstant king.⁹ Charles, long weary of the old chancellor's rebukes, was especially incensed at this time owing to his failure in securing Frances Stuart (la Belle Stuart) for his seraglio, a disappointment which he attributed to Clarendon, and was now alarmed by the hostility which his administration had excited. He did not scruple to sacrifice at once the old adherent of his house and fortunes. "The truth is," he wrote Ormonde, "his behaviour and humour was grown so insupportable to myself and all the world else that I could no longer endure it, and it was impossible for me to live with it and do these things with the Parliament that must be done, or the government will be lost."¹⁰ By the direction of Charles, James advised Clarendon to resign before the meeting of parliament, but in an interview with the king on the 26th of August Clarendon refused to deliver up the seal unless dismissed, and urged him not to take a step ruinous to the interests both of the chancellor

⁵ Pepys's *Diary*, Sept. 2, 1667.

⁶ *Hist. MSS. Comm.*, 7th Rep. 162.

⁷ *Diary*, iii. 95, 96.

⁸ *Lives from the Clarendon Gallery*, by Lady Th. Lewis, i. 39.

⁹ Burnet's *Hist. of his own Times*, i. 209.

¹⁰ *Continuation*, 88.

¹¹ Lister's *Life of Clarendon*, li. 416.

¹ *Continuation*, 1170.

² *Hist. MSS. Comm.*: *MSS. of F. W. Leyborne-Popham*, 250.

³ *Continuation*, 1066.

⁴ Macaulay's *Hist. of England*, i. 193.

himself and of the crown.¹ He could not believe his dismissal was really intended, but on the 30th of August he was deprived of the great seal, for which the king received the thanks of the parliament on the 16th of October. On the 12th of November his impeachment, consisting of various charges of arbitrary government, corruption and maladministration, was brought up to the Lords, but the latter refused to order his committal, on the ground that the Commons had only accused him of treason in general without specifying any particular charge. Clarendon wrote humbly to the king asking for pardon, and that the prosecution might be prevented, but Charles had openly taken part against him, and, though desiring his escape, would not order or assist his departure for fear of the Commons. Through the bishop of Hereford, however, on the 29th of November he pressed Clarendon to fly, promising that he should not during his absence suffer in his honour or fortune. Clarendon embarked the same night for Calais, where he arrived on the 2nd of December. The Lords immediately passed an act for his banishment and ordered the petition forwarded by him to parliament to be burnt.

The rest of Clarendon's life was passed in exile. He left Calais for Rouen on the 25th of December, returning on the 21st of January 1668, visiting the baths of Bourbon in April, thence to Avignon in June, residing from July 1668 till June 1671 at Montpellier, whence he proceeded to Moulins and to Rouen again in May 1674. His sudden banishment entailed great personal hardships. His health at the time of his flight was much impaired, and on arriving at Calais he fell dangerously ill; and Louis XIV., anxious at this time to gain popularity in England, sent him peremptory and repeated orders to quit France. He suffered severely from gout, and during the greater part of his exile could not walk without the aid of two men. At Evreux, on the 23rd of April 1668, he was the victim of a murderous assault by English sailors, who attributed to him the non-payment of their wages, and who were on the point of despatching him when he was rescued by the guard. For some time he was not allowed to see any of his children; even correspondence with him was rendered treasonable by the Act of Banishment; and it was not apparently till 1671, 1673 and 1674 that he received visits from his sons, the younger, Lawrence Hyde, being present with him at his death.

Clarendon bore his troubles with great dignity and fortitude. He found consolation in religious duties, and devoted a portion of every day to the composition of his *Contemplations on the Psalms*, and of his moral essays. Removed effectually from the public scene, and from all share in present politics, he turned his attention once more to the past and finished his *History* and his *Autobiography*. Soon after reaching Calais he had written, on the 17th of December 1667, to the university of Oxford, desiring as his last request that the university should believe in his innocence and remember him, though there could be no further mention of him in their public devotions, in their private prayers.² In 1668 he wrote to the duke and duchess of York to remonstrate on the report that they had turned Roman Catholic, to the former urging "You cannot be without zeal for the Church to which your blessed father made himself a sacrifice," adding that such a change would bring a great storm against the Romanists. He entertained to the last hopes of obtaining leave to return to England. He asked for permission in June 1671 and in August 1674. In the dedication of his *Brief View of Mr Hobbes's Book Leviathan* he repeats "the hope which sustains my weak, decayed spirits that your Majesty will at some time call to your remembrance my long and incorrupted fidelity to your person and your service"; but his petitions were not even answered or noticed. He died at Rouen on the 9th of December 1674. He was buried in Westminster Abbey at the foot of the steps at the entrance to Henry VII.'s chapel. He left two sons, Henry, 2nd earl of Clarendon, and Lawrence, earl of Rochester, his daughter Anne, duchess of York, and a third son, Edward, having predeceased him. His male descendants became extinct on the death of the 4th earl of Clarendon and 2nd earl of Rochester in 1753, the title of Clarendon being

¹ *Continuation*, 1137.

² *Clarendon St. Pap.* iii. Suppl. xxxvii.

revived in 1776 in the person of Thomas Villiers, who had married the granddaughter and heir of the last earl.

As a statesman Clarendon had obvious limitations and failings. He brought to the consideration of political questions an essentially legal but also a narrow mind, conceiving the law, "that great and admirable mystery," and the constitution as fixed, unchangeable and sufficient for all time, in contrast to Pym, who regarded them as living organisms capable of continual development and evolution; and he was incapable of comprehending and governing the new conditions and forces created by the civil wars. His character, however, and therefore to some extent his career, bear the indelible marks of greatness. He left the popular cause at the moment of its triumph and showed in so doing a strict consistency. In a court degraded by licence and self-indulgence, he maintained his self-respect and personal dignity regardless of consequences, and in an age of almost universal corruption and self-seeking he preserved a noble integrity and patriotism. At the Restoration he showed great moderation in accepting rewards. He refused a grant of 10,000 acres in the Fens from the king on the ground that it would create an evil precedent, and amused Charles and James by his indignation at the offer of a present of £10,000 from the French minister Fouquet, the only present he accepted from Louis XIV. being a set of books printed at the Louvre. His income, however, as lord chancellor was very large, and Clarendon maintained considerable state, considering it due to the dignity of the monarchy that the high officers should carry the external marks of greatness. The house built by him in St James's was one of the most magnificent ever seen in England, and was filled with a collection of portraits, chiefly those of contemporary statesmen and men of letters. It cost Clarendon £50,000, involved him deeply in debt and was considered one of the chief causes of the "gust of envy" that caused his fall.³ He is described as "a fair, ruddy, fat, middle-statured, handsome man," and his appearance was stately and dignified. He expected deference from his inferiors, and one of the chief charges which he brought against the party of the young politicians was the want of respect with which they treated himself and the lord treasurer. His industry and devotion to public business, of which proofs still remain in the enormous mass of his state papers and correspondence, were exemplary, and were rendered all the more conspicuous by the negligence, inferiority in business, and frivolity of his successors. As lord chancellor Clarendon made no great impression in the court of chancery. His early legal training had long been interrupted, and his political preoccupations probably rendered necessary the delegation of many of his judicial duties to others. According to Speaker Onslow his decrees were always made with the aid of two judges. Burnet praises him, however, as "a very good chancellor, only a little too rough but very impartial in the administration of justice," and Pepys, who saw him presiding in his court, perceived him to be "a most able and ready man."⁴ According to Evelyn, "though no considerable lawyer" he was "one who kept up the fame and substance of things in the nation with . . . solemnity." He made good appointments to the bench and issued some important orders for the reform of abuses in his court.⁵ As chancellor of Oxford University, to which office he was elected on the 27th of October 1660, Clarendon promoted the restoration of order and various educational reforms. In 1753 his manuscripts were left to the university by his great-grandson Lord Cornbury, and in 1868 the money gained by publication was spent in erecting the Clarendon Laboratory, the profits of the *History* having provided in 1713 a building for the university press adjoining the Sheldonian theatre, known since the removal of the press to its present quarters as the Clarendon Building.

Clarendon had risen to high office largely through his literary and oratorical gifts. His eloquence was greatly admired by

³ Evelyn witnessed its demolition in 1683—*Diary*, May 19th, Sept. 18th; *Lives from the Clarendon Gallery*, by Lady Th. Lewis, i. 40.

⁴ *Diary*, July 14th, 1664.

⁵ *Lister*, li. 528.

Evelyn and Pepys, though Burnet criticises it as too copious. He was a great lover of books and collected a large library, was well read in the Roman and in the contemporary histories both foreign and English, and could appreciate Carew, Ben Jonson and Cowley. As a writer and historian Clarendon occupies a high place in English literature. His great work, the *History of the Rebellion*, is composed in the grand style. A characteristic feature is the wonderful series of well-known portraits, drawn with great skill and liveliness and especially praised by Evelyn and by Macaulay. The long digressions, the lengthy sentences, and the numerous parentheses do not accord with modern taste and usage, but it may be observed that these often follow more closely the natural involutions of the thought, and express the argument more clearly, than the short disconnected sentences, now generally employed, while in rhythm and dignity Clarendon's style is immeasurably superior. The composition, however, of the work as a whole is totally wanting in proportion, and the book is overloaded with state papers, misplaced and tedious in the narrative. In considering the accuracy of the history it is important to remember the dates and circumstances of the composition of its various portions. The published *History* is mainly a compilation of two separate original manuscripts, the first being the history proper, written between 1646 and 1648, with the advantage of a fresh memory and the help of various documents and authorities, and ending in March 1644, and the second being the *Life*, extending from 1609 to 1660, but composed long afterwards in exile and without the aid of papers between 1668 and 1670. The value of any statement, therefore, in the published *History* depends chiefly on whether it is taken from the *History* proper or the *Life*. In 1671 these two manuscripts were united by Clarendon with certain alterations and modifications making Books i.-vii. of the published *History*, while Books viii.-xv. were written subsequently, and, being composed for the most part without materials, are generally inaccurate, with the notable exception of Book ix., made up from two narratives written at Jersey in 1646, and containing very little from the *Life*. Sincerity and honest conviction are present on every page, and the inaccuracies are due not to wilful misrepresentation, but to failure of memory and to the disadvantages under which the author laboured in exile. But they lessen considerably the value of his work, and detract from his reputation as chronicler of contemporary events, for which he was specially fitted by his practical experience in public business, a qualification declared by himself to be the "genius, spirit and soul of an historian." In general, Clarendon, like many of his contemporaries, failed signally to comprehend the real issues and principles at stake in the great struggle, laying far too much stress on personalities and never understanding the real aims and motives of the Presbyterian party. The work was first published in 1702-1704 from a copy of a transcript made by Clarendon's secretary, with a few unimportant alterations, and was the object of a violent attack by John Oldmixon for supposed changes and omissions in *Clarendon and Whitlocke compared* (1727) and again in a preface to his *History of England* (1730), repelled and refuted by John Burton in the *Genuineness of Lord Clarendon's History Vindicated* (1744). The history was first published from the original in 1826; the best edition being that of 1888 edited by W. D. Macray and issued by the Clarendon Press. *The Lord Clarendon's History . . . Completed*, a supplement containing portraits and illustrative papers, was published in 1717, and *An Appendix to the History*, containing a life, speeches and various pieces, in 1724. The *Sutherland Clarendon* in the Bodleian library at Oxford contains several thousand portraits and illustrations of the *History*. *The Life of Edward, earl of Clarendon . . . [and the] Continuation of the History . . .*, the first consisting of that portion of the *Life* not included in the *History*, and the second of the account of Clarendon's administration and exile in France, begun in 1672, was published in 1759, the *History of the Reign of King Charles II. from the Restoration . . .*, published about 1755, being a surreptitious edition of this work, of which the latest and best edition is that of the Clarendon Press, of 1857.

Clarendon was also the author of *The Difference and Disparity*

between the Estate and Condition of George, duke of Buckingham and Robert, earl of Essex, a youthful production vindicating Buckingham, printed in *Reliquiae Wottonianae* (1672), i. 184; *Animadversions on a Book entitled Fanaticism* (1673), *A Brief View . . . of the dangerous . . . errors in . . . Mr Hobbes's book entitled "Leviathan."* (1676); *The History of the Rebellion and Civil War in Ireland* (1719); *A Collection of Several Pieces of Edward, earl of Clarendon*, containing reprints of speeches from the journals of the House of Lords and of the *History of the Rebellion in Ireland* (1727); *A Collection of Several Tracts containing his Vindication in answer to his impeachment, Reflections upon several Christian Duties, Two Dialogues on Education and on the want of Respect due to age, and Contemplations on the Psalms* (1727); *Religion and Policy* (1811); *Essays moral and entertaining on the various faculties and passions of the human mind* (1815, and in *British Prose Writers*, 1819, vol. i.); *Speeches in Rushworth's Collections* (1692), pt. iii. vol. i. 230, 333; *Declarations and Manifestos* (Clarendon being the author of nearly all on the king's side between March 1642 and March 1645, the first being the answer to the Grand Remonstrance in January 1642, but not of the answer to the XIX. Propositions or the apology for the King's attack upon Brentford) in the published *History*, *Rushworth's Collections*, *E. Husband's Collections of Ordinances and Declarations* (1646), *Old Parliamentary History* (1751-1762), *Somers Tracts, State Tracts, Harleian Miscellany, Thomasson Tracts* (Brit. Mus.), E. 157 (14); and a large number of anonymous pamphlets aimed against the parliament, including *Transcendent and Multiplied Rebellion and Treason* (1645), *A Letter from a True and Lawful Member of Parliament . . . to one of the Lords of his Highness's Council* (1656), and *Two Speeches made in the House of Peers on Monday 19th Dec. [1642] . . .* (*Somers Tracts*, Scott, vi. 576); *Second Thoughts* (n.d., in favour of a limited toleration) is ascribed to him in the Catalogue in the British Museum; *A Letter . . . to one of the Chief Ministers of the Nonconforming Party . . .* (Saumur, 7th May 1674) has been attributed to him on insufficient evidence.

Clarendon's correspondence, amounting to over 100 volumes, is in the Bodleian library at Oxford, and other letters are to be found in *Additional MSS.* in the British Museum. Selections have been published under the title of *State Papers Collected by Edward, earl of Clarendon* (Clarendon State Papers) between 1767 and 1786, and the collection has been calendared up to 1657 in 1869, 1872, 1876. Other letters of Clarendon are to be found in *Lister's Life of Clarendon*, iii.; *Nicholas Papers* (Camden Soc., 1886); *Diary of J. Evelyn, appendix*; Sir R. Fanshew's *Original Letters* (1724); *Warburton's Life of Prince Rupert* (1849); *Barwick's Life of Barwick* (1724); *Hist. MSS. Comm.* 10th Rep. pt. vi. pp. 193-216, and in the *Harleian Miscellany*.

BIBLIOGRAPHY.—Clarendon's autobiographical works and Letters enumerated above, and the MS. Collection in the Bodleian library. The Lives of Clarendon by T. H. Lister (1838), and by C. H. Firth in the *Dict. of Nat. Biography* (with authorities there collected), completely supersede all earlier accounts including that in *Lives of All the Lord Chancellors* (1708), in Macdiarmid's *Lives of British Statesmen* (1807), and in the different Lives by Wood in *Athenae Oxonienses* (Bliss), iii. 1018; while those in J. H. Browne's *Lives of the Prime Ministers of England* (1858), in *Lodge's Portraits*, in *Lord Campbell's Lives of the Chancellors*, iii. 110 (1845), and in *Foss's Judges*, supply no further information. In *Historical Inquiries respecting the Character of Edward Hyde, earl of Clarendon*, various charges against Clarendon were collected by G. A. Ellis (1827) and answered by Lister, vol. ii. 529, and by Lady Th. Lewis in *Lives of the Contemporaries of Lord Clarendon* (1852), i. preface pt. i. For criticisms of the *History* see Gardiner's *Civil Wars* (1893), iii. 121; Ranke's *Hist. of England*, vi. 3-29; *Die Politik Karls des Ersten . . . und Lord Clarendon's Darstellung*, by A. Buß (1868); article in the *Dict. of Nat. Biog.* by C. H. Firth, and especially a series of admirable articles by the same author in the *Eng. Hist. Review* (1904). For description of the MS., Macray's edition of the *History* (1888), Lady Th. Lewis's *Lives from the Clarendon Gallery*, i. introd. pt. ii.; for list of earlier editions, *Ath. Oxon.* (Bliss) iii. 1017. Lord Lansdowne defends Sir R. Granville against Clarendon's strictures in the *Vindication (Genuine Works of G. Granville, Lord Lansdowne, i. 503 [1732])*, and Lord Ashburnham defends John Ashburnham in *A Narrative by John Ashburnham* (1830). See also *Notes at Meetings of the Privy Council between Charles II. and the Earl of Clarendon* (Roxburghe Club, 1896); *General Orders of the High Court of Chancery*, by J. Beames (1815), 147-221; S. R. Gardiner's

Hist. of England, of the Civil War and of the Commonwealth; Lord Clarendon, by A. Chassant (account of the assault at Evreux) (1891); *Annals of the Bodleian Library*, by W. D. Macray (1868); *Masson's Life of Milton; Life of Sir G. Savile*, by H. C. Foxcroft (1898); *Cal. of St. Pap. Dom.*, esp. 1667-1668, 58, 354, 370; *Hist. MSS. Comm. Series, MSS. of J. M. Heathcote and Various Collections*, vol. ii.; *Add. MSS. in the British Museum; Notes and Queries*, 6 ser. v. 283, 9 ser. xi. 182, 1 ser. ix. 7; *Pepys's Diary; J. Evelyn's Diary and Correspondence*; *Gen. Catalogue in British Museum; Edward Hyde, earl of Clarendon* (1909), a lecture delivered at Oxford during the Clarendon centenary by C. H. Firth. (P. C. Y.)

CLARENDON, GEORGE WILLIAM FREDERICK VILLIERS, 4TH EARL OF (in the Villiers line) (1800-1870), English diplomatist and statesman, was born in London on the 12th of January 1800. He was the eldest son of Hon. George Villiers (1759-1827, youngest son of the 1st earl of Clarendon (second creation), by Theresa, only daughter of the first Lord Boringdon, and granddaughter of the first Lord Grantham. The earldom of the lord chancellor Clarendon became extinct in the Hyde line by the death of the 4th earl, his last male descendant. Jane Hyde, countess of Essex, the sister of that nobleman (she died in 1724), left two daughters; of these the eldest, Lady Charlotte, became heiress of the Hyde family. She married Thomas Villiers (1709-1786), second son of the 2nd earl of Jersey, who served with distinction as English minister in Germany, and in 1776 the earldom of Clarendon was revived in his favour. The connexion with the Hyde family was therefore in the female line and somewhat remote. But a portion of the pictures and plate of the great chancellor was preserved to this branch of the family, and remains at The Grove, their family seat at Hertfordshire. The 2nd and 3rd earls were sons of the 1st, and, neither of them having sons, the title passed, on the death of the 3rd earl (John Charles) in 1838, to their younger brother's son.

Young George Villiers entered upon life in circumstances which gave small promise of the brilliancy of his future career. He was well born; he was heir presumptive to an earldom; and his mother was a woman of great energy, admirable good sense, and high feeling. But the means of his family were contracted; his education was desultory and incomplete; he had not the advantages of a training either at a public school or in the House of Commons. He went up to Cambridge at the early age of sixteen, and entered St John's College on the 29th of June 1816. In 1820, as the eldest son of an earl's brother with royal descent, he was enabled to take his M.A. degree under the statutes of the university then in force. In the same year he was appointed attaché to the British embassy at St Petersburg, where he remained three years, and gained that practical knowledge of diplomacy which was of so much use to him in after-life. He had received from nature a singularly handsome person, a polished and engaging address, a ready command of languages, and a remarkable power of composition.

Upon his return to England in 1823 he was appointed to a commissionership of customs, an office which he retained for about ten years. In 1831 he was despatched to France to negotiate a commercial treaty, which, however, led to no result. On the 16th of August 1833 he was appointed minister at the court of Spain. Ferdinand VII. died within a month of his arrival at Madrid, and the infant queen Isabella, then in the third year of her age, was placed by the old Spanish law of female inheritance on her contested throne. Don Carlos, the late king's brother, claimed the crown by virtue of the Salic law of the House of Bourbon which Ferdinand had renounced before the birth of his daughter. Isabella II. and her mother Christina, the queen regent, became the representatives of constitutional monarchy, Don Carlos of Catholic absolutism. The conflict which had divided the despotic and the constitutional powers of Europe since the French Revolution of 1830 broke out into civil war in Spain, and by the Quadruple Treaty, signed on the 22nd of April 1834, France and England pledged themselves to the defence of the constitutional thrones of Spain and Portugal. For six years Villiers continued to give the most active and intelligent support to the Liberal government of Spain. He was accused, though unjustly, of having favoured the revolution

of La Granja, which drove Christina, the queen mother, out of the kingdom, and raised Espartero to the regency. He undoubtedly supported the chiefs of the Liberal party, such as Espartero, against the intrigues of the French court; but the object of the British government was to establish the throne of Isabella on a truly national and liberal basis and to avert those complications, dictated by foreign influence, which eventually proved so fatal to that princess. Villiers received the grand cross of the Bath in 1838 in acknowledgment of his services, and succeeded, on the death of his uncle, to the title of earl of Clarendon, in the following year, having left Madrid, he married Katharine, eldest daughter of James Walter, first earl of Verulam.

In January 1840 he entered Lord Melbourne's administration as lord privy seal, and from the death of Lord Holland in the autumn of that year Lord Clarendon also held the office of chancellor of the duchy of Lancaster until the dissolution of the ministry in 1841. Deeply convinced that the maintenance of a cordial understanding with France was the most essential condition of peace and of a liberal policy in Europe, he reluctantly concurred in the measures proposed by Lord Palmerston for the expulsion of the pasha of Egypt from Syria; he strenuously advocated, with Lord Holland, a more conciliatory policy towards France; and he was only restrained from sending in his resignation by the dislike he felt to break up a cabinet he had so recently joined.

The interval of Sir Robert Peel's great administration (1841-1846) was to the leaders of the Whig party a period of repose; but Lord Clarendon took the warmest interest in the triumph of the principles of free trade and in the repeal of the corn-laws, of which his brother, Charles Pelham Villiers (*q.v.*), had been one of the earliest champions. For this reason, upon the formation of Lord John Russell's first administration, Lord Clarendon accepted the office of president of the Board of Trade. Twice in his career the governor-generalship of India was offered him, and once the governor-generalship of Canada;—these he refused from reluctance to withdraw from the politics of Europe. But in 1847 a sense of duty compelled him to take a far more laborious and uncongenial appointment. The desire of the cabinet was to abolish the lord-lieutenancy of Ireland, and Lord Clarendon was prevailed upon to accept that office, with a view to transform it ere long into an Irish secretaryship of state. But he had not been many months in Dublin before he acknowledged that the difficulties then existing in Ireland could only be met by the most vigilant and energetic authority, exercised on the spot. The crisis was one of extraordinary peril. Agrarian crimes of horrible atrocity had increased threefold. The Catholic clergy were openly disaffected. This was the second year of the Irish famine, and extraordinary measures were required to regulate the bounty of the government and the nation. In 1848 the revolution in France let loose fresh elements of discord, which culminated in an abortive insurrection, and for a lengthened period Ireland was a prey to more than her wonted symptoms of disaffection and disorder. Lord Clarendon remained viceroy of Ireland till 1852, and left behind him permanent marks of improvement. His services were expressly acknowledged in the queen's speech to both Houses of Parliament on the 5th of September 1848—this being the first time that any *civil* services obtained that honour; and he was made a knight of the Garter (retaining also the grand cross of the Bath by special order) on the 23rd of March 1849.

Upon the formation of the coalition ministry between the Whigs and the Peelites, in 1853, under Lord Aberdeen, Lord Clarendon became foreign minister. The country was already "drifting" into the Crimean War, an expression of his own which was never forgotten. Clarendon was not responsible for the policy which brought war about; but when it occurred he employed every means in his power to stimulate and assist the war departments, and above all he maintained the closest relations with the French. The tsar Nicholas had speculated on the impossibility of the sustained joint action of France and England in council and in the field. It was mainly by Lord Clarendon at Whitehall and by Lord Raglan before Sevastopol

that such a combination was rendered practicable and did eventually triumph over the enemy. The diplomatic conduct of such an alliance for three years between two great nations jealous of their military honour and fighting for no separate political advantage, tried by excessive hardships and at moments on the verge of defeat, was certainly one of the most arduous duties ever performed by a minister. The result was due in the main to the confidence with which Lord Clarendon had inspired the emperor of the French, and to the affection and regard of the empress, whom he had known in Spain from her childhood.

In 1856 Lord Clarendon took his seat at the congress of Paris convoked for the restoration of peace, as first British plenipotentiary. It was the first time since the appearance of Lord Castlereagh at Vienna that a secretary of state for foreign affairs had been present in person at a congress on the continent. Lord Clarendon's first care was to obtain the admission of Italy to the council chamber as a belligerent power, and to raise the barrier which still excluded Prussia as a neutral one. But in the general anxiety of all the powers to terminate the war there was no small danger that the objects for which it had been undertaken would be abandoned or forgotten. It is due entirely to the firmness of Lord Clarendon that the principle of the neutralization of the Black Sea was preserved, that the Russian attempt to trick the allies out of the cession in Bessarabia was defeated, and that the results of the war were for a time secured. The congress was eager to turn to other subjects, and perhaps the most important result of its deliberations was the celebrated Declaration of the Maritime Powers, which abolished privateering, defined the right of blockade, and limited the right of capture to enemy's property in enemy's ships. Lord Clarendon has been accused of an abandonment of what are termed the belligerent rights of Great Britain, which were undoubtedly based on the old maritime laws of Europe. But he acted in strict conformity with the views of the British cabinet, and the British cabinet adopted those views because it was satisfied that it was not for the benefit of the country to adhere to practices which exposed the vast mercantile interests of Britain to depredation, even by the cruisers of a secondary maritime power, and which, if vigorously enforced against neutrals, could not fail to embroil her with every maritime state in the world.

Upon the reconstitution of the Whig administration in 1859, Lord John Russell made it a condition of his acceptance of office under Lord Palmerston that the foreign department should be placed in his own hands, which implied that Lord Clarendon should be excluded from office, as it would have been inconsistent alike with his dignity and his tastes to fill any other post in the government. The consequence was that from 1859 till 1864 Lord Clarendon remained out of office, and the critical relations arising out of the Civil War in the United States were left to the guidance of Earl Russell. But he re-entered the cabinet in May 1864 as chancellor of the duchy of Lancaster; and upon the death of Lord Palmerston in 1865, Lord Russell again became prime minister, when Lord Clarendon returned to the foreign office, which was again confided to him for the third time upon the formation of Mr Gladstone's administration in 1868. To the last moment of his existence, Lord Clarendon continued to devote every faculty of his mind and every instant of his life to the public service; and he expired surrounded by the boxes and papers of his office on the 27th of June 1870. No man owed more to the influence of a generous, unselfish and liberal disposition. If he had rivals he never ceased to treat them with the consideration and confidence of friends, and he cared but little for the ordinary prizes of ambition in comparison with the advancement of the cause of peace and progress.

He was succeeded as 5th earl by his eldest son, EDWARD HYDE VILLIERS (b. 1846), who became lord chamberlain in 1900.

See also the article (by Henry Reeve) in *Fraser's Magazine*. August 1876.

CLARENDON, HENRY HYDE. 2ND EARL OF (1638-1709), English statesman, eldest son of the first earl, was born on the 2nd of June 1638. He accompanied his parents into exile and

assisted his father as secretary, returning with them in 1660. In 1661 he was returned to parliament for Wiltshire as Lord Cornbury. He became secretary in 1662 and lord chamberlain to the queen in 1665. He took no part in the life of the court, and on the dismissal of his father became a vehement opponent of the administration, defended his father in the impeachment; and subsequently made effective attacks upon Buckingham and Arlington. In 1674 he became earl of Clarendon by his father's death, and in 1679 was made a privy councillor. He was not included in Sir W. Temple's council of that year, but was reappointed in 1680. In 1682 he supported Halifax's proposal of declaring war on France. On the accession of James in 1685 he was appointed lord privy seal, but shortly afterwards, in September, was removed from this office to that of lord-lieutenant of Ireland. Clarendon was embarrassed in his estate, and James required a willing agent to carry out his design by upsetting the Protestant government and the Act of Settlement. Clarendon arrived in Dublin on the 9th of January 1686. He found himself completely in the power of Tyrconnel, the commander-in-chief; and though, like his father, a staunch Protestant, elected this year high steward of Oxford University, and detesting the king's policy, he obeyed his orders to introduce Roman Catholics into the government and the army and upon the bench, and clung to office till after the dismissal of his brother, the earl of Rochester, in January 1687, when he was recalled and succeeded by Tyrconnel. He now supported the church in its struggle with James, opposed the Declaration of Indulgence, wrote to Mary an account of the resistance of the bishops,¹ and visited and advised the latter in the Tower. He had no share however, in inviting William to England. He assured James in September that the Church would be loyal, advised the calling of the parliament, and on the desertion of his son, Lord Cornbury, to William on the 14th of November, expressed to the king and queen the most poignant grief. In the council held on the 27th, however, he made a violent and unseasonable attack upon James's conduct, and on the 1st of December set out to meet William, joined him on the 3rd at Berwick near Salisbury, and was present at the conference at Hungerford on the 8th, and again at Windsor on the 16th. His wish was apparently to effect some compromise, saving the crown for James. According to Burnet, he advised sending James to Breda, and according to the duchess of Marlborough to the Tower, but he himself denies these statements.² He opposed vehemently the settlement of the crown upon William and Mary, voted for the regency, and refused to take the oaths of the new sovereigns, remaining a non-juror for the rest of his life. He subsequently retired to the country, engaged in cabals against the government, associated himself with Richard Graham, Lord Preston, and organizing a plot against William, was arrested on the 24th of June 1690 by order of his niece, Queen Mary, and placed in the Tower. Liberated on the 15th of August, he immediately recommenced his intrigues. On Preston's arrest on the 31st of December, a compromising letter from Clarendon was found upon him, and he was named by Preston as one of his accomplices. He was examined before the privy council and again imprisoned in the Tower on the 4th of January 1691, remaining in confinement till the 3rd of July. This closed his public career. In 1702, on Queen Anne's accession, he presented himself at court, "to talk to his niece," but the queen refused to see him till he had taken the oaths. He died on the 31st of October 1709, and was buried in Westminster Abbey.

His public career had been neither distinguished nor useful, but it seems natural to ascribe its failure to small abilities and to the conflict between personal ties and political convictions which drew him in opposite directions, rather than, following Macaulay, to motives of self-interest. He was a man of some literary taste, a fellow of the Royal Society (1684), the author of *The History and Antiquities of the Cathedral Church of Winchester* . . . continued by S. Gale (1715), and he collaborated with his brother Rochester in the publication of his father's *History* (1702-1704). He

¹ *Hist. MSS. Comm.: MSS. of the Duke of Buccleuch*, ii. 31.

² *Correspondence and Diary* (1828), ii. 286.

married (1) in 1660, Theodosia, daughter of Lord Capel, and (2) in 1670, Flower, daughter of William Backhouse of Swallowfield in Berkshire, and widow of William Bishopp and of Sir William Backhouse, Bart. He was succeeded by his only son, Edward (1661-1724), as 3rd earl of Clarendon; and, the latter having no surviving son, the title passed to Henry, 2nd earl of Rochester (1672-1753), at whose death without male heirs it became extinct in the Hyde line.

CLARENDON, CONSTITUTIONS OF, a body of English laws issued at Clarendon in 1164, by which Henry II. endeavoured to settle the relations between Church and State. Though they purported to declare the usages on the subject which prevailed in the reign of Henry I. they were never accepted by the clergy, and were formally renounced by the king at Avranches in September 1172. Some of them, however, were in part at least, as they all purported to be, declaratory of ancient usage and remained in force after the royal renunciation. Of the sixteen provisions the one which provoked the greatest opposition was that which declared in effect that criminous clerks were to be summoned to the king's court, and from there, after formal accusation and defence, sent to the proper ecclesiastical court for trial. If found guilty they were to be degraded and sent back to the king's court for punishment. Another provision, which in spite of all opposition obtained a permanent place in English law, declared that all suits even between clerk and clerk concerning advowsons and presentations should be tried in the king's court. By other provisions appeals to Rome without the licence of the king were forbidden. None of the clergy were to leave the realm, nor were the king's tenants-in-chief and ministers to be excommunicated or their lands interdicted without the royal permission. Pleas of debt, whether involving a question of good faith or not, were to be in the jurisdiction of the king's courts. Two most interesting provisions, to which the clergy offered no opposition, were: (1) if a dispute arose between a clerk and a layman concerning a tenement which the clerk claimed as free-alm (frankalmoign) and the layman as a lay-fee, it should be determined by the recognition of twelve lawful men before the king's justice whether it belonged to free-alm or lay-fee, and if it were found to belong to free-alm then the plea was to be held in the ecclesiastical court, but if to lay-fee, in the court of the king or of one of his magnates; (2) a declaration of the procedure for election to bishoprics and royal abbey, generally considered to state the terms of the settlement made between Henry I. and Anselm in 1107.

AUTHORITIES.—J. C. Robertson, *Materials for History of Thomas Becket*, Rolls Series (1875-1885); Sir F. Pollock and F. W. Maitland, *History of English Law before the Time of Ed. I.* (Cambridge, 1898), and F. W. Maitland, *Roman Canon Law in the Church of England* (1898); the text of the Constitutions is printed by W. Stubbs in *Select Charters* (Oxford, 1895). (G. J. T.)

CLARES, POOR, otherwise *Clarisses*, Franciscan nuns, so called from their foundress, St Clara (q.v.). She was professed by St Francis in the Portiuncula in 1212, and two years later she and her first companions were established in the convent of St Damian's at Assisi. The nuns formed the "Second Order of St Francis," the friars being the "First Order," and the Tertiaries (q.v.) the "Third." Before Clara's death in 1253, the Second Order had spread all over Italy and into Spain, France and Germany; in England they were introduced c. 1293 and established in London, outside Aldgate, where their name of Minoreesses survives in the Minorities; there were only two other English houses before the Dissolution. St Francis gave the nuns no rule, but only a "Form of Life" and a "Last Will," each only five lines long, and coming to no more than an inculcation of his idea of evangelical poverty. Something more than this became necessary as soon as the institute began to spread, and during Francis's absence in the East, 1219, his supporter Cardinal Hugolino composed a rule which made the Franciscan nuns practically a species of unduly strict Benedictines, St Francis's special characteristics being eliminated. St Clara made it her life work to have this rule altered, and to get the Franciscan character of the Second Order restored; in 1247 a "Second Rule" was approved which went a long way towards satisfying

her desires, and finally in 1253 a "Third," which practically gave what she wanted. This rule has come to be known as the "Rule of the Clares"; it is one of great poverty, seclusion and austerity of life. Most of the convents adopted it, but several clung to that of 1247. To bring about conformity, St Bonaventura, while general (1264), obtained papal permission to modify the rule of 1253, somewhat mitigating its austerities and allowing the convents to have fixed incomes,—thus assimilating them to the Conventual Franciscans as opposed to the Spirituals. This rule was adopted in many convents, but many more adhered to the strict rule of 1253. Indeed a counter-tendency towards a greater strictness set in, and a number of reforms were initiated, introducing an appalling austerity of life. The most important of these reforms were the Coletines (St Colette, c. 1400) and the Capucines (c. 1540; see CAPUCHINS). The half-dozen forms of the Franciscan rule for women here mentioned are still in use in different convents, and there are also a great number of religious institutes for women based on the rule of the Tertiaries. By the term "Poor Clares" the Coletine nuns are now commonly understood; there are various convents of these nuns, as of other Franciscans, in England and Ireland. Franciscan nuns have always been very numerous; there are now about 150 convents of the various observances of the Second Order, in every part of the world, besides innumerable institutions of Tertiaries.

See Helyot, *Hist. des ordres religieux* (1792), vii. cc. 25-28 and 38-42; Wetzer and Welte, *Kirchenlexikon* (2nd ed.), art. "Clara"; Max Heimbucher, *Orden und Kongregationen* (1896), i. §§ 47, 48, who gives references to all the literature. For a scientific study of the beginnings see Lempp, "Die Anfänge des Klarissenordens," in *Zeitschrift für Kirchengeschichte*, xiii. (1892), 181 ff. (E. C. B.)

CLARET (from the Fr. *vin claret*, mod. *claircel*, wine of a light clear colour, from Lat. *clarus*, clear), the English name for the red Bordeaux wines. The term was originally used in France for light-yellow or light-red wines, as distinguished from the *vins rouges* and the *vins blancs*; later it was applied to red wines generally, but is rarely used in French, and never with the particular English meaning (see WINE).

CLARETIE, JULES ARSÈNE ARNAUD (1840—), French man of letters and director of the Théâtre Français, was born at Limoges on the 3rd of December 1840. After studying at the lycée Bonaparte in Paris, he became an active journalist, achieving great success as dramatic critic to the *Figaro* and to the *Opinion nationale*. He was a newspaper correspondent during the Franco-German War, and during the Commune acted as staff-officer in the National Guard. In 1885 he became director of the Théâtre Français, and from that time devoted his time chiefly to its administration. He was elected a member of the Academy in 1888, and took his seat in February 1889, being received by Ernest Renan. The long list of his works includes *Histoire de la révolution de 1870-1871* (new ed., 5 vols., 1875-1876); *Cinq ans après; l'Alsace et la Lorraine depuis l'annexion* (1876); some annual volumes of reprints of his articles in the weekly press, entitled *La Vie à Paris; La Vie moderne au théâtre* (1868-1869); *Molière, sa vie et son œuvre* (1871), *Histoire de la littérature française, 900-1900* (2nd ed. 1905); *Candidat* (1887), a novel of contemporary life; *Brichanteau, comédien français* (1896); several plays, some of which are based on novels of his own—*Les Muscadins* (1874), *Le Régiment de Champagne* (1877), *Les Mirabeau* (1879), *Monsieur le ministre* (1883), and others; and the opera, *La Navarraise*, based on his novel *La Cigarette*, and written with Henri Cain to the music of Massenet. *La Navarraise* was first produced at Covent Garden (June 1894) with Mme Calvé in the part of Anita. His *Œuvres complètes* were published in 1897-1904.

CLARI, GIOVANNI CARLO MARIA, Italian musical composer, chapel-master at Pistoia, was born at Pisa about the year 1660. The time of his death is unknown. He was the most celebrated pupil of Colonna, chapel-master of S. Petronio, at Bologna. He became *maestro di cappella* at Pistoia about 1712, at Bologna in 1720, and at Pisa in 1736. He is supposed to have died about 1745. The works by which Clari distinguished himself pre-eminently are his vocal duets and trios, with a *basso continuo*, published between 1740 and 1747. These compositions,

which combine graceful melody with contrapuntal learning, were much admired by Cherubini. They appear to have been admired by Handel also, since he did not hesitate to make appropriations from them. Clari composed one opera, *Il Savio delirante*, produced at Bologna in 1695, and a large quantity of church music, several specimens of which were printed in Novello's *Fitzwilliam Music*.

CLARINA, a comparatively new instrument of the wood-wind class (although actually made of metal), a hybrid possessing characteristics of both oboe and clarinet. The clarina was invented by W. Heckel of Biebrich-am-Rhein, and has been used since 1891 at the Festspielhaus, Bayreuth, in *Tristan und Isolde*, as a substitute for the *Holztrompete* made according to Wagner's instructions. The clarina has been found more practical and more effective in producing the desired tone-colour. The clarina is a metal instrument with the conical bore and fingering of the oboe and the clarinet single-reed mouthpiece. The compass of the

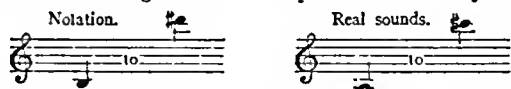

instrument is as shown, and it stands in the key of B \flat . Like the clarinet, the clarina is a transposing instrument, for which the music must be written in a key a tone higher than that of the composition. The timbre resulting from the combination of conical bore and single-reed mouthpiece has in the lowest register affinities with the *cor anglais*, in the middle with the saxophone, and in the highest with the clarinet. Other German orchestras have followed the example of Bayreuth. The clarina has also been found very effective as a solo instrument. (K. S.)

CLARINET, or CLARINET (Fr. *clarinette*; Ger. *Clarinette*, *Klarinett*; Ital. *clarinetto*, *chiarinetto*), a wood-wind instrument having a cylindrical bore and played by means of a single-reed mouthpiece. The word "clarinet" is said to be derived from *clarinetto*, a diminutive of *clarino*, the Italian for (1) the soprano trumpet, (2) the highest register of the instrument, (3) the trumpet played musically without the blare of the martial instrument. The word "clarinet" is similarly derived from "clarion," the English equivalent of *clarino*. It is suggested that the name *clarinet* or *clarinetto* was bestowed on account of the resemblance in timbre between the high registers of the clarino and clarinet. By adding the speaker-hole to the old chalumeau, J. C. Denner gave it an additional compass based on the overblowing of the harmonic twelfth, and consisting of an octave and a half of harmonics, which received the name of *clarino*, while the lower register retained the name of *chalumeau*. There is something to be said also in favour of another suggested derivation from the Italian *chiarina*, the name for reed instruments and the equivalent for tibia and aulos. At the beginning of the 18th century in Italy *clarinetto*, the diminutive of *clarino*, would be masculine, whereas *chiarinetta* or *clarinetta* would be feminine,¹ as in Doppelmayer's account of the invention written in 1730. The word "clarinet" is sometimes used in a generic sense to denote the whole family, which consists of the clarinet, or discant corresponding to the violin, oboe, &c.; the alto clarinet in E; the basset horn in F (*q.v.*); the bass clarinet (*q.v.*), and the pedal clarinet (*q.v.*).

The modern clarinet consists of five (or four) separate pieces: (1) the mouthpiece; (2) the bulb; (3) the upper middle joint, or left-hand joint; (4) the lower middle joint, or right-hand joint²; (5) the bell; which (the bell excepted) when joined together, form a tube with a continuous cylindrical bore, 2 ft. or more in length, according to the pitch of the instrument. The mouthpiece, including the beating or single-reed common to the whole clarinet family, has the appearance of a beak with the point bevelled off and thinned at the edge to correspond with the end of

¹ See Gottfried Weber's objection to this derivation in "Über Clarinette und Basset-horn," *Cæcilia* (Mainz, 1829), vol. xi. pp. 36 and 37. note.

² Nos. 3 and 4 are sometimes made in one, as for instance in Messrs Rudall, Carte & Company's modification, the Klusmann patent.

the reed shaped like a spatula. The under part of the mouthpiece (fig. 2) is flattened in order to form a table for the support of the reed which is adjusted thereon with great nicety, allowing just the amount of play requisite to set in vibration the column of air within the tube.

The mouthpiece, which is subject to continual fluctuations of dampness and dryness, and to changes of temperature, requires to be made of a material having great powers of resistance, such as cocus wood, ivory or vulcanite, which are mostly used for the purpose in England. A longitudinal aperture 1 in. long and $\frac{1}{2}$ in. wide, communicating with the bore, is cut in the table and covered by the reed. The aperture is thus closed except towards the point, where, for the distance of $\frac{1}{3}$ to $\frac{1}{2}$ in., the reed is thinned and the table curves backwards towards the point, leaving a gap between the ends of the mouthpiece and of the reed of 1 mm. or about the thickness of a sixpence for the B flat clarinet. The curve of the table and the size of the gap are therefore of considerable importance. The reed is cut from a joint of the *Arundo donax* or *sativa*, which grows wild in the regions bordering on the Mediterranean. A flat slip of the reed is cut, flattened on one side and thinned to a very delicate edge on the other. At first the reed was fastened to the table by means of many turns of a fine waxed cord. The metal band adjusted by means of two screws, known as the "ligature," was introduced about 1817 by Ivan Müller. The reed is set in vibration by the breath of the performer, and being flexible it beats against the table, opening and closing the gap at a rate depending on the rate of the vibrations it sets up in the air column, this rate varying according to the length of the column as determined by opening the lateral holes and keys. A cylindrical tube played by means of a reed has the acoustic properties of a stopped pipe, *i.e.* the fundamental tone produced by the tube is an octave lower than the corresponding tone of

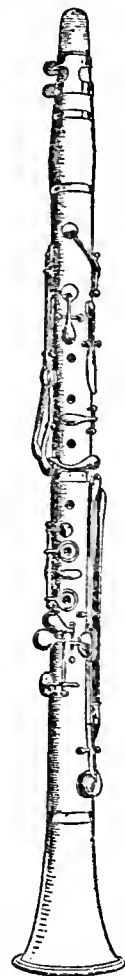

FIG. 1.—Clarinet (Albert Model).

an open pipe of the same length, and overblows a twelfth; whereas tubes having a conical bore like the oboe, and played by means of a reed, speak as open pipes and overblow an octave. This forms the fundamental difference between the instruments of the oboe and clarinet families. Wind instruments depending upon lateral holes for the production of their scale must either have as many holes pierced in the bore as they require notes, or make use of the property possessed by the air-column of dividing into harmonics or partials of the fundamental tones. Twenty to twenty-two holes is the number generally accepted as the practical limit for the clarinet; beyond that number the fingering and mechanism become too complicated. The compass of the clarinet is therefore extended through the medium of the harmonic overtones. In stopped pipes a node is formed near the mouthpiece, and they are therefore only able to produce the uneven harmonics, such as the 1st, 3rd, 5th, 7th, &c., correspond-

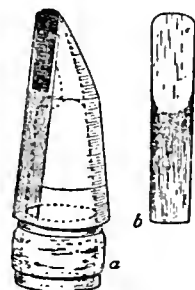

FIG. 2.—Clarinet Mouthpiece. *a*, the mouthpiece showing the position of the bore inside; *b*, the single or beating reed.

ing to the fundamental, and the diatonic intervals of the 5th one octave above, and of the 3rd and 7th two octaves above the fundamental. By pressing the reed with the lip near the base where it is thicker and stiffer, and increasing the pressure of the breath, the air-column is forced to divide and to sound the

harmonics, a principle well understood by the ancient Greeks and Romans in playing upon the aulos and tibia.¹ This is easier to accomplish with the double reed than with the beating reed; in fact with a tube of wide diameter, such as that of the modern clarinet, it would not be possible by this means alone to do justice to the tone of the instrument or to the music now written for it. The bore of the aulos was very much narrower than that of the clarinet.

In order to facilitate the production of the harmonic notes on the clarinet, a small hole, closed by means of a key and called the "speaker," is bored near the mouthpiece. By means of this small hole the air-column is placed in communication with the external atmosphere, a ventral segment is formed, and the air-column divides into three equal parts, producing a triple number of vibrations resulting in the third note of the harmonic series, at an interval of a twelfth above the fundamental.² In a wind instrument with lateral holes the fundamental note corresponding to any particular hole is produced when all the holes below that hole are open and it itself and all above it are closed, the effective length of the resonating tube being shortened as each of the closed holes is successively uncovered. In order to obtain a complete chromatic scale on the clarinet at least eighteen holes are required. This series produces with the bell-note a succession of nineteen semitones, giving the range of a twelfth and known as the fundamental scale or *chalumeau* register, so called, no doubt, because it was the compass (without chromatic semitones) of the more primitive predecessor of the clarinet, known as the *chalumeau*, which must not be confounded with the shawm or schalmey of the middle ages.

The fundamental scale of the modern clarinet in C extends from



The next octave and a half is obtained by opening

the speaker key, whereby each of the fundamental notes is reproduced a twelfth higher; the bell-note thus jumps from E to B \sharp , the first key gives instead of F its twelfth C \sharp , and so on, extending

the compass to , which ends the natural compass of the

instrument, although a skilful performer may obtain another octave by cross-fingering. The names of the holes and keys on the clarinet are derived not from the notes of the fundamental scale, but from the name of the twelfth produced by overblowing with the speaker key open; for instance, the first key near the bell is known not as the E key but as the B \sharp . The use of the speaker key forms the greatest technical difficulty in learning to play the clarinet, on account of the thumb having to do double duty, closing one hole and raising the lever of the speaker key simultaneously. In a clarinet designed by Richard Carte this difficulty was ingeniously overcome by placing the left thumb-hole towards the front, and closing it by a thumb-lever or with a ring action by the first or second finger of the left hand, thus leaving the thumb free to work the speaker key alone.

There is good reason to think that the ancient Greeks understood the advantage of a speaker-hole, which they called *Syrinx*, for facilitating the production of harmonics on the aulos. The credit of the discovery of this interesting fact is due to A. A. Howard,³ of Harvard University; it explains many passages in the classics which before were obscure (see *AULOS*). Plutarch relates⁴ that Telephanes of Megara was so incensed with the syrinx that he never allowed his instrument-makers to place one on any of his auloi; he even went so far as to absent himself, principally on account of the syrinx, from the Pythian games. Telephanes was a great virtuoso who scorned the use of a speaker-hole, being able to obtain his harmonics on the aulos by the mere control of lips and teeth.

The modern clarinet has from thirteen to nineteen keys, some being normally open and others closed. In order to understand why, when once the idea of adding keys to the chalumeau had been conceived, the number rose so slowly, keys being added one or two at a time by makers of various nationalities at long intervals, it is

¹ Aristotle (*de Audib.* 802 b 18, and 804 a) and Porphyry (ed. Wallis, pp. 249 and 252) mention that if the performer presses the *zeuge* (mouthpiece) or the *glottai* (reeds) of the pipes, a sharper tone is produced.

² Cf. V. C. Mahillon, *Éléments d'acoustique musicale et instrumentale* (Brussels, 1874), p. 161; and Fr. Zamminer, *Die Musik und die musikalischen Instrumente in ihrer Beziehung zu den Gesetzen der Akustik* . . . (Giessen, 1855), pp. 297 and 298.

³ "The Aulos or Tibia," *Harvard Studies*, iv. (Boston, 1893).

⁴ *De Musica*, 1138.

necessary to consider the effect of boring holes in the side of a cylindrical tube. If it were possible to proceed from an absolute theoretical basis, there would be but little difficulty; there are, however, practical reasons which make this a matter of great difficulty. According to V. Mahillon,⁵ the theoretical length of a B \flat clarinet (French pitch diapason normal A=435 vibrations), is 39 cm. when the internal diameter of the bore measures exactly 1.4 cm. Any increase in the diameter of the cylindrical bore for a given length of tube raises the pitch proportionally and in the same way a decrease lowers it. A bore narrow in proportion to the length facilitates the production of the harmonics, which is no doubt the reason why the aulos was made with a very narrow diameter, and produced such deep notes in proportion to its length. In determining the position of the holes along the tube, the thickness of the wood to be pierced must be taken into consideration, for the length of the passage from the main bore to the outer air adds to the length of the resonating column; as, however, the clarinet tube is reckoned as a closed one, only half the extra length must be taken into account. When placed in its correct theoretical position, a hole should have its diameter equal to the diameter of the main bore, which is the ideal condition for obtaining a full, rich tone; it is, however, feasible to give the hole a smaller diameter, altering its position by placing it nearer the mouthpiece. These laws, which were likewise known to the Greeks and Romans,⁶ had to be rediscovered by experience in the 18th and 19th centuries, during which the mechanism of the key system was repeatedly improved. Due consideration having been given to these points, it will also be necessary to remember that the stopping of the seven open holes leaves only the two little fingers (the thumb of the right hand being in the ordinary clarinet engaged in supporting the instrument) free at all times for key service, the other fingers doing duty when momentarily disengaged. The fingering of the clarinet is the most difficult of any instrument in the orchestra, for it differs in all four octaves of its compass. Once mastered, however, it is the same for all clarinets, the music being always written in the key of C.

The actual tonality of the clarinet is determined by the diatonic scale produced when, starting with keys untouched and finger and thumb-holes closed, the fingers are raised one by one from the holes. In the B \flat clarinet, the *real sounds* thus produced are



being part of the scale of B \flat major. By the closing of two *open* keys, the lower E \flat and D are added.

The following are the various sizes of clarinets with the key proper to each:

- E \flat , a minor third above the C clarinet.
 - B \flat , a tone below " "
 - The high F, 4 tones above " "
 - The D, 1 tone above " "
 - The low G, a fourth below " "
 - The A, a minor third below " "
 - The B \sharp 1 semitone below " "
 - The alto clarinet in E \flat , a fifth below the B \flat clarinet.
 - The tenor or basset horn, in F, a fifth below the C clarinet.
 - The bass clarinet in B \flat , an 8^{ve} below that in B \flat .
 - The pedal clarinet in B \flat , an 8^{ve} below the bass clarinet.
- The clarinets in B \flat and A are used in the orchestra; those in C and E \flat in military bands.

History.—Although the single beating-reed associated with the instruments of the clarinet family has been traced in ancient Egypt, the double reed, characteristic of the oboe family, being of simpler construction, was probably of still greater antiquity. An ancient Egyptian pipe found in a mummy-case and now preserved in the museum at Turin was found to contain a beating-reed sunk 3 in. below the end of the pipe, which is the principle of the drone. It would appear that the double chalumeau, called arghoul (*q.v.*) by the modern Egyptians, was known in ancient Egypt, although it was not perhaps in common use. The Musée Guimet possesses a copy of a fresco from the tombs at Saqqarah (executed under the direction of Mariette Bey) assigned to the 4th or 5th dynasty, on which is shown a concert with dancing; the instruments used are two harps, the long oblique flute "nay," blown from the end without any mouthpiece or embouchure, and an instrument identified as an arghoul.⁷

⁵ *Op. cit.* pp. 160 et seq.; and Wilhelm Altenburg, *Die Klarinette* (Heilbronn, 1904), p. 9, who refers to Mahillon.

⁶ See Macrobius, *Comm. in somnium Scipionis*, ii. 4. 5 " nec securi probamus in tibiis de quarum foraminibus vicinus inflantis ori sonus acutus emittitur, de longinquis autem et termino proximis, gravior: item acutior per patentiora foramina, gravior per angusta."

⁷ See Victor Loret, *L'Égypte au temps des Pharaons—la vie, la science, et l'art* (Paris, 1889), illustration p. 139 and p. 143. The author gives no information about this fresco except that it is in the

from its resemblance to the modern instrument of the same name. This is believed to be the only illustration of the ancient double chalumeau yet found in Egypt, with the single exception of a hieroglyph occurring also once only, *i.e.* the sign read *As-il*, consisting of a cylindrical pipe with a beak mouthpiece bound round with a cord tied in a bow. The bow is taken to indicate the double parallel pipes bound together; the same sign without the bow occurs frequently and is read *Ma-il*,¹ and is considered to be the generic name for reed wind instruments. The beating-reed was probably introduced into classic Greece from Egypt or Asia Minor. A few ancient Greek instruments are extant, five of which are in the British Museum. They are as nearly cylindrical as would be the natural growing reed itself. The probability is that both single and double reeds were at times used with the Greek aulos and the Roman tibia. V. Mahillon and A. A. Howard of Harvard have both obtained facsimiles of actual instruments, some found at Pompeii and now deposited in the museum at Naples, and others in the British Museum. Experiments made with these instruments, whose original mouthpieces have perished, show that with pipes of such narrow diameter the fundamental scale and pitch are the same whether sounded by means of a single or of a double reed, but the modern combination of single reed and cylindrical tube alone gives the full pure tone quality. The subject is more fully discussed in the article *AULOS*.² The Roman tibia, if monuments can be trusted, sometimes had a beak-shaped mouthpiece, as for instance that attached to a pipe discovered at Pompeii, or that shown in a scene on Trajan's column.³ It is probable that when, at the decline of the Roman empire, instrumental music was placed by the church under a ban—and the tibia more especially from its association with every form of licence and moral depravity—this instrument, sharing the common fate, survived chiefly among itinerant musicians who carried it into western Europe, where it was preserved from complete extinction. An instrument of difficult technique requiring an advanced knowledge of acoustics was not, however, likely to flourish or even to be understood among nations whose culture was as yet in its infancy.

The tide of culture from the Byzantine empire filtered through to the south and west, leaving many traces; a fresh impetus was received from the east through the Arabs; and later, as a result of the Crusades, the prototype of the clarinet, together with the practical knowledge necessary for making the instrument and playing upon it, may have been re-introduced through any one or all of these sources. However this may be, the instrument was during the Carolingian period identified with the tibia of the Romans until such time as the new western civilization ceased to be content to go back to classical Rome for its models, and began to express itself, at first naively and awkwardly, as the 11th century dawned. The name then changed to the derivatives of the Greek *kalamos*, assuming an almost bewildering variety of forms, of which the commonest are chalemie, chalumeau, schalmey, scalmeye, shawm, calmel, kalemele.⁴ The derivation of the name seems to point to a Byzantine rather than an Arab source for the revival of the instruments which formed the prototype of both oboe and clarinet, but it must not be forgotten that the instruments with a conical bore—more especially those played by a reed—are primarily of Asiatic origin. At the beginning of the 13th century Musée Guimet. It is probably identical with the second of the mural paintings described on p. 190 of *Petit guide illustré au Musée Guimet*, par L. de Milloué.

¹ See Victor Loret, "Les flûtes égyptiennes antiques," *Journal asiatique* (Paris, 1889), [8], xiv. pp. 129, 130, 132.

² See also A. A. Howard, "Study on the Aulos or Tibia," *Harvard Studies*, vol. iv. (Boston, 1893); F. C. Gevaert, *Musique de l'antiquité*; Carl von Jan, article "Floete" in August Baumeister's *Denkmäler des klassischen Alterthums* (Leipzig, 1884–1888), vol. i.; Dr Hugo Riemann, *Handbuch der Musikgesch.* vol. i. p. 90, &c. (Leipzig, 1904); all of whom have not come to the same conclusions.

³ Wilhelm Froehner, *La Colonne trajane* (Paris, 1872), t. ii. pl. 76.

⁴ Aavec aus ert vestus Guis
Ki leur cante et Kalemele.
En la muse au grant bourdon."

J. A. U. Scheler's *Trouvères belges*.

in France, where the instrument remained a special favourite until it was displaced by the clarinet, the chalumeau is mentioned in some of the early romances:—"Tabars et chalemiaux et estrumens sonner" (*Aye d'Avignon*, v. 4137); "Grelles et chelimiaus et buisines bruians" (*Gui de Bourgogne*, v. 1374), &c. By the end of the 13th century, the German equivalent *Schalmey* appears in the literature of that country,—"Pusünen und Schalmeyen schal moht niemen da gehoeren wal" (*Frauentdienst*, 492, fol. 5, Ulrich von Lichtenstein). The schalmey or shawm is frequently represented in miniatures from the 13th century, but it must have been known long before, since it was at that period in use as the chaunter of the bag-pipe (*g.*), a fully-developed complex instrument which presupposes a separate previous existence for its component parts.

We have no reason to suppose that any distinction was drawn between the single and double reed instruments during the early middle ages—if indeed the single reed was then known at all—for the derivatives of *kalamos* were applied to a variety of pipes. The first clear and unmistakable drawing yet found of the single reed occurs in Mersenne's *Harmonie universelle* (p. 282), where the primitive reed pipe is shown with the beating-reed detached from the tube of the instrument itself, by making a lateral slit and then splitting back a little tongue of reed towards a knot. Mersenne calls this the simplest form of chalumeau or wheat-stalk (*tuyau de blé*). It is evident that no significance was then attached to the form of the vibrating reed, whether single or double, for Mersenne and other writers of his time call the chaunters of the musette and cornemuse chalumeaux whether they are of cylindrical or of conical bore. The difference in timbre produced by the two kinds of reeds was, however, understood, for Mersenne states that a special kind of cornemuse was used in concert with the *hautbois de Poitou* (an oboe whose double reed was enclosed in an air chamber) and was distinguished from the shepherd's cornemuse by having double reeds throughout, whereas the drones of the latter instrument were furnished with beating reeds. It is therefore evident that as late as 1636 (the date at which Mersenne wrote) in France the word "chalumeau" was not applied to the instrument transformed some sixty years later into the clarinet, nor was it applied exclusively to any one kind of pipe except when acting as the chaunter of the bagpipe, and that independently of any structural characteristics. The chaunter was still called chalumeau in 1737.⁵ Of the instrument which has been looked upon as the chalumeau, there is but little trace in Germany or in France at the beginning of the 17th century. A chalumeau with beak mouthpiece and characteristic short cylindrical tube pierced with six holes figures among the musical instruments used for the triumphal procession of the emperor Maximilian I., commemorated by a fine series of plates,⁶ engraved on wood by Hans Burgkmair, the friend and colleague of A. Dürer. On the same plate (No. 70) are five schalmeycs with double reeds and five chalumeaux with single-reed beak mouthpieces: the latter instruments were in all probability made in the Netherlands, which excelled from the 12th century in the manufacture of all musical instruments. No single-reed instrument, with the exception of the regal (*g.*), is figured by S. Virdung,⁷ M. Agricola⁸ or M. Praetorius.⁹

A good idea of the primitive chalumeau may be gained from a reproduction of one of the few specimens from the 16th or 17th century still extant, which belonged to Césaire Snoeck and was exhibited at the Royal Military Exhibition in London in 1890.¹⁰ The tube is stopped at the mouthpiece end by a natural joint of

⁵ See Ernest Thoinan, *Les Hotteterre et les Chédeville, célèbres facteurs de flûtes, hautbois, bassons et musettes* (Paris, 1894), p. 15 et seq., and *Méthode pour la musette, &c.*, par Hotteterre le Romain (Paris, 1737).

⁶ The whole series of 135 plates has been reproduced in *Jahrb. d. Samml. des Allerh. Kaiserhauses* (Vienna, 1883–1884).

⁷ *Musica getutsch und ausgezogen* (Basel, 1511).

⁸ *Musica Instrumentalis Deudsch* (Nuremberg, 1528 and 1545).

⁹ *Syntagma Musicum* (Wolfenbüttel, 1618). This work and those mentioned in the two previous notes have been reprinted by the Ges. f. Musikforschung in vols. xi., xx. and xiii. of *Publikationen* (Berlin).

¹⁰ See *Descriptive Catalogue*, by Capt. C. R. Day (London, 1891), pl. iv. A and p. 110, No. 221.

the reed, and a tongue has been detached just under the joint; there are six finger-holes and one for the thumb. An instrument almost identical with the above, but with a rudimentary bell, and showing plainly the detached tongue, is figured by Jost Amman in 1589.¹ A plate in Diderot and d'Alembert's *Encyclopédie*² shows a less primitive instrument, outwardly cylindrical and having a separate mouthpiece joint and a clarinet reed but no keys. A chalumeau without keys, but consisting apparently of three joints—mouthpiece, main tube and bell,—is figured on the title-page of a musical work³ dated 1690; it is very similar to the one represented in fig. 3, except that only six holes are visible.



(a)



(b)

(From Diderot and d'Alembert's *Encyclopédie*.)

FIG. 3. Chalumeau, 1767.

(a) Front, (b) Back view.

In his biographical notice of J. Christian Denner (1655–1707), J. G. Doppelmayr⁴ states that at the beginning of the 18th century "Denner invented a new kind of pipe, the so-called clarinet, which greatly delighted lovers of music; he also made great improvements in the stock or rackett-fagottos, known in the olden time and finally also in the chalumeaux." It is probable that the improvements in the chalumeau to which Doppelmayr alludes without understanding them consisted (a) in giving the mouthpiece the shape of a beak and adding a separate reed tongue as in that of the modern clarinet, unless this change had already taken place in the Netherlands, the country which the unremitting labours of E. van der Straeten⁵ have revealed as taking the lead in Europe from the 14th to the 16th century in the construction of musical instruments of all kinds; (b) in the boring of two additional holes for A and B near the mouthpiece and covering them with two keys; (c) in replacing the long cylindrical mouthpiece joint by a bulb, thus restoring one of the characteristic features of the tibia,⁶ known as the *ἄλμος*. There are a few of these improved chalumeaux in existence, two being in the

Bavarian national museum at Munich, the one in high A, in a bad state of preservation, the second in C, marked J. C. Denner, of which V. Mahillon has made a facsimile⁷ for the museum of the Brussels Conservatoire. There are two keys and eight holes; the first consists of two small holes on the same level giving a semitone if only one be closed. If the thumb-key be left open, the sounds of the fundamental scale (shown in the black notes below) rise a twelfth to form the second register (the white notes)



This early clarinet or improved chalumeau has a clarinet mouthpiece, but no bulb; it measures 50 cm. (20 in.), whereas the one in A mentioned above is only 28 cm. in length, the long cylindrical tube between mouthpiece and key-joint, afterwards turned into the bulb, being absent. Mahillon was probably the first to point out that the so-called invention of the clarinet by J. C. Denner consisted in providing a device—the speaker-key—to facilitate the production of the harmonics of the fundamental. Can we be sure that the same result was not obtained on the old chalumeau

before keys were added, by partially uncovering the hole for the thumb?

The Berlin museum possesses an early clarinet with two keys, marked J. B. Oberlender, derived from the Snoeck collection. Paul de Wit's collection has a similar specimen by Enkelmer. The Brussels Conservatoire possesses clarinets with two keys by Flemish makers, G. A. Rottenburgh and J. B. Willems⁸; the latter, with a small bulb and bell, is in G a fifth above the C clarinet. The next improvements in the clarinet, made in 1720, are due to J. Denner, probably a son of J. C. Denner. They consisted in the addition of a bell and in the removal of the speaker-hole and key nearer the mouthpiece, involving the reduction of the diameter of the hole. The effect of this change of position was to turn the B \sharp into B \flat , for J. Denner introduced into the hole, nearly as far as the axis of the bore, a small metal drainage tube⁹ for the moisture of the breath. In the modern clarinet, the same result is attained by raising this little tube slightly above the surface of the main tube, placing a key on the top of it, and bending the lever. In order to produce the missing B \sharp , J. Denner lengthened the tube and pierced another hole, the low E, covered by an open key with a long lever which, when closed, gives the desired B as its twelfth, thus forming a connexion between the two registers. A clarinet with three keys, of similar construction (about 1750), marked J. W. Kenigsperger, is preserved in the Bavarian national museum, at Munich. Another in B \flat marked Lindner¹⁰ belongs to the collection at Brussels. About the middle of the 18th century, the number of keys was raised to five, some say¹¹ by Barthold Fritz of Brunswick

(1697–1766), who added keys for C \sharp and D \sharp .

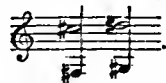

According to Altenburg¹² the E \flat or D \sharp key is due to the virtuoso Joseph Beer (1744–1811). The sixth key was added about 1790 by the celebrated French virtuoso Xavier Lefébure (or Lefèvre),

and produced C \sharp .



Anton Stadler and his brother,

both clarinetists in the Vienna court orchestra and instrument-makers, are said to have lengthened the tube of the B \flat clarinet, extending the compass down to C (real sound B \flat). It was for the Stadler brothers that Mozart wrote his quintet for strings, with a fine obbligato for the clarinet in A (1789), and the clarinet concerto with orchestra in 1791.

This, then, was the state of the clarinet in 1810 when Ivan Müller, then living in Paris, carried the number of keys up to thirteen, and made several structural improvements already mentioned, which gave us the modern instrument and inaugurated a new era in the construction and technique of the clarinet. Müller's system is still adopted in principle by most clarinet makers. The instrument was successively improved during the 19th century by the Belgian makers Bachmann, the elder Sax, Albert and C. Mahillon, whose invention in 1862 of the C \sharp key with double action is now generally adopted. In Paris the labours of Lefébure, Buffet-Crampon, and Goumas are pre-eminent. In 1842 H. E. Klosé conceived the idea of adapting to the clarinet the ingenious mechanism of movable rings, invented by Boehm for the flute, and he entrusted the execution of this innovation to Buffet-Crampon; this is the type of clarinet generally adopted in French orchestras. From this adaptation has sprung the erroneous notion that Klosé's clarinet was constructed according to the Boehm system; Klosé's lateral divisions of the tube do not follow those applied by Boehm to the flute.

In England the clarinet has also passed through several progressive stages since its introduction about 1770, and first of

⁸ For a description with illustration see V. Mahillon's *Catalogue descriptif* (Ghent, 1896), vol. ii. p. 215, No. 916.

⁹ See Wilhelm Altenburg, *op. cit.* p. 6.

¹⁰ See V. Mahillon, *Catal. descriptif* (1896), p. 213, No. 913.

¹¹ H. Welcker von Gontershausen, *Die musikalischen Tonwerkzeuge* (Frankfort-on-Main, 1855), p. 141.

¹² *Op. cit.* p. 6.

¹ *Wappenbuch*, p. 111, "Musica."

² Paris, 1767, vol. v. "Planches," pl. ix. 20, 21, 22.

³ Dr Theofilo Muffat, "Componimenti musicali per il cembalo," in *Denkmäler d. Tonkunst in Österreich*, Bd. iii.

⁴ *Historische Nachricht von den Nürnbergischen Mathematicis u. Künstlern*, &c. (Nuremberg, 1730), p. 305.

⁵ *Histoire de la musique aux Pays Bas avant le XIX^e siècle*.

⁶ For a facsimile of one of the Pompeii tibiæ, see Capt. C. R. Day, *op. cit.* pl. iv. C. and p. 109.

⁷ *Catalogue descriptif* (Ghent, 1896), vol. ii. p. 211, No. 911, where an illustration is given. See also Capt. C. R. Day, *op. cit.* pl. iv. B and *Errata* where the description is printed.

all at the hands of Cornelius Ward. The principal improvements were due to Richard Carte, who took out a patent in 1858 for an improved Boehm clarinet which possessed some claim to the name, since Boehm's principle of boring the holes at theoretically

correct intervals and of venting the holes by means of open holes below was carried out. Carte made several modifications of his original patent, his chief endeavour being to so dispose the key-work as to reduce the difficulties in fingering. By the extension of the principle of the ring action, the work of the third and little fingers of the left hand was simplified and the fingering of certain difficult notes and shakes greatly facilitated. Messrs Rudall, Carte & Company have made further improvements in the clarinet, which are embodied in Klussmann's patent (fig. 4); these consist in the introduction of the duplicate G \sharp key, a note which has hitherto formed a serious obstacle to perfect execution. The duplicate key, operated by the third or second finger of the right hand, releases the fourth finger of the left hand. The old G \sharp is still retained and may be used in the usual way if desired. The body of the instrument is now made in one joint, and the position of the G \sharp hole is mathematically correct, whereby perfect intonation for C \sharp , G \sharp and F \sharp is secured. Other improvements were made in Paris by Messrs Evette & Schaeffer and by M. Paradis,¹ a clarinet-player in the band of the Garde Républicaine, and very great improvements in boring and in key mechanism were effected by Albert of Brussels (see fig. 1).

The clarinet appears to have received appreciation in the Netherlands earlier than in its own native land. According to W. Altenburg (*op. cit.* p. 11),² a MS. is preserved in the cathedral at Antwerp of a mass written by A. J. Faber in 1720, which is scored for a clarinet. Johann Mattheson,³ *Kapellmeister* at Hamburg, mentions clarinet music in 1713, although

FIG. 4. — Clarinet (Boehm model, Klussmann's patent).

Handel, whose rival he was, does not appear to have known the instrument. Joh. Christ. Bach scored for the clarinet in 1763 in his opera *Orione* performed in London, and Rameau had already employed the instrument in 1751 in a theatre for his pastoral entitled *Acante et Céphise*.⁴ The clarinet was formally introduced into the orchestra in Vienna in 1767,⁵ Gluck having contented himself with the use of the chalumeau in *Orfeo* (1762) and in *Alceste* (1767).⁶ The clarinet had already been adopted in military bands in France in 1755, where it very speedily completely replaced the oboe. One of Napoleon Bonaparte's bands is said to have had no less than twenty clarinets.

For further information on the clarinet at the beginning of the 19th century, consult the *Methods* by Ivan Müller and Xavier Lefébure, and Joseph Froehlich's admirable work on the instruments of the orchestra; and Gottfried Weber's articles in Ersch and Gruber's *Encyclopaedia*. See also BASSET HORN; BASS CLARINET and PEDAL CLARINET. (K. S.)

CLARK, SIR ANDREW, Bart. (1826–1893), British physician, was born at Aberdeen on the 28th of October 1826. His father, who also was a medical man, died when he was only a few years

old. After attending school in Aberdeen, he was sent by his guardians to Dundee and apprenticed to a druggist; then returning to Aberdeen he began his medical studies in the university of that city. Soon, however, he went to Edinburgh, where in the extra-academical school he had a student's career of the most brilliant description, ultimately becoming assistant to J. Hughes Bennett in the pathological department of the Royal Infirmary, and assistant demonstrator of anatomy to Robert Knox. But symptoms of pulmonary phthisis brought his academic life to a close, and in the hope that the sea might benefit his health he joined the medical department of the navy in 1848. Next year he became pathologist to the Haslar hospital, where T. H. Huxley was one of his colleagues, and in 1853 he was the successful candidate for the newly-instituted post of curator to the museum of the London hospital. Here he intended to devote all his energies to pathology, but circumstances brought him into active medical practice. In 1854, the year in which he took his doctor's degree at Aberdeen, the post of assistant-physician to the hospital became vacant and he was prevailed upon to apply for it. He was fond of telling how his phthisical tendencies gained him the appointment. "He is only a poor Scotch doctor," it was said, "with but a few months to live; let him have it." He had it, and two years before his death publicly declared that of those who were on the staff of the hospital at the time of his selection he was the only one remaining alive. In 1854 he became a member of the College of Physicians, and in 1858 a fellow, and then went in succession through all the offices of honour the college has to offer, ending in 1888 with the presidency, which he continued to hold till his death. From the time of his selection as assistant physician to the London hospital, his fame rapidly grew until he became a fashionable doctor with one of the largest practices in London, counting among his patients some of the most distinguished men of the day. The great number of persons who passed through his consulting-room every morning rendered it inevitable that to a large extent his advice should become stereotyped and his prescriptions often reduced to mere stock formulae, but in really serious cases he was not to be surpassed in the skill and carefulness of his diagnosis and in his attention to detail. In spite of the claims of his practice he found time to produce a good many books, all written in the precise and polished style on which he used to pride himself. Doubtless owing largely to personal reasons, lung diseases and especially fibroid phthisis formed his favourite theme, but he also discussed other subjects, such as renal inadequacy, anaemia, constipation, &c. He died in London on the 6th of November 1893, after a paralytic stroke which was probably the result of persistent overwork.

CLARK, FRANCIS EDWARD (1851–), American clergyman, was born of New England ancestry at Aylmer, Province of Quebec, Canada, on the 12th of September 1851. He was the son of Charles C. Symmes, but took the name of an uncle, the Rev. E. W. Clark, by whom he was adopted after his father's death in 1853. He graduated at Dartmouth College in 1873 and at Andover Theological Seminary in 1876, was ordained in the Congregational ministry, and was pastor of the Williston Congregational church at Portland, Maine, from 1876 to 1883, and of the Phillips Congregational church, South Boston, Mass., from 1883 to 1887. On the 2nd of February 1881 he founded at Portland the Young People's Society of Christian Endeavor, which, beginning as a small society in a single New England church, developed into a great interdenominational organization, which in 1908 had 70,761 societies and more than 3,500,000 members scattered throughout the United States, Canada, Great Britain, Australia, South Africa, India, Japan and China. After 1887 he devoted his time entirely to the extension of this work, and was president of the United Societies of Christian Endeavor and of the World's Christian Endeavor Union, and editor of the *Christian Endeavor World* (originally *The Golden Rule*). Among his numerous publications are *The Children and the Church* (1882); *Looking Out on Life* (1883); *Young People's Prayer Meetings* (1884); *Some Christian Endeavor Saints* (1889); *World Wide Endeavor* (1895); *A New Way Round an Old World* (1900).

¹ See Capt. C. R. Day, *op. cit.* p. 106.

² V. Mahillon, *Catal. desc.* (1880), p. 182, refers his statement to the Chevalier L. de Burbure.

³ *Das neu-eröffnete Orchester* (Hamburg, 1713).

⁴ Mahillon, *Catal. desc.* (1880), vol. i, p. 182.

⁵ See Chevalier Ludwig von Koechel, *Die kaiserliche Hofmusik-kapelle zu Wien, 1543–1867* (Vienna, 1869).

⁶ In the Italian edition of 1769 the part is scored for clarinet.

See his *The Young People's Christian Endeavor, where it began, &c.* (Boston, 1895); *Christian Endeavor Manual* (Boston, 1903); and *Christian Endeavor in All Lands: Record of Twenty-five Years of Progress* (Philadelphia, 1907).

CLARK, GEORGE ROGERS (1752–1818), American frontier military leader, was born near Charlottesville, in Albemarle county, Virginia, on the 19th of November 1752. Early in life he became a land-surveyor; he took part in Lord Dunmore's War (1774), and in 1775 went as a surveyor for the Ohio Company to Kentucky (then a district of Virginia), whither he removed early in 1776. His iron will, strong passions, audacious courage and magnificent physique soon made him a leader among his frontier neighbours, by whom in 1776 he was sent as a delegate to the Virginia legislature. In this capacity he was instrumental in bringing about the organization of Kentucky as a county of Virginia, and also obtained from Governor Patrick Henry a supply of powder for the Kentucky settlers. Convinced that the Indians were instigated and supported in their raids against the American settlers by British officers stationed in the forts north of the Ohio river, and that the conquest of those forts would put an end to the evil, he went on foot to Virginia late in 1777 and submitted to Governor Henry and his council a plan for offensive operations. On the 2nd of January 1778 he was commissioned lieutenant-colonel, received £1200 in depreciated currency, and was authorized to enlist troops; and by the end of May he was at the falls of the Ohio (the site of Louisville) with about 175 men. The expedition proceeded to Fort Kaskaskia, on the Mississippi, in what is now Illinois. This place and Cahokia, also on the Mississippi, near St Louis, were defended by small British garrisons, which depended upon the support of the French *habitants*. The French being willing to accept the authority of Virginia, both forts were easily taken. Clark gained the friendship of Father Pierre Gibault, the priest at Kaskaskia, and through his influence the French at Vincennes on the Wabash were induced (late in July) to change their allegiance. On the 17th of December Lieut.-Governor Henry Hamilton, the British commander at Detroit, recovered Vincennes and went into winter quarters. Late in February 1779 he was surprised by Clark and compelled to give up Vincennes and its fort, Fort Sackville, and to surrender himself and his garrison of about 80 men, as prisoners of war. With the exception of Detroit and several other posts on the Canadian frontier the whole of the North-West was thus brought under American influence; many of the Indians, previously hostile, became friendly, and the United States was put in a position to demand the cession of the North-West in the treaty of 1783. For this valuable service, in which Clark had freely used his own private funds, he received practically no recompense either from Virginia or from the United States, and for many years before his death he lived in poverty. To him and his men, however, the Virginia legislature granted 150,000 acres of land in 1781, which was subsequently located in what are now Clark, Floyd and Scott counties, Indiana; Clark's individual share was 8049 acres, but from this he realized little. Clark built Fort Jefferson on the Mississippi, 4 or 5 m. below the mouth of the Ohio, in 1780, destroyed the Indian towns Chillicothe and Piqua in the same year, and in November 1782 destroyed the Indian towns on the Miami river. With this last expedition his active military service virtually ended, and in July 1783 he was relieved of his command by Virginia. Thereafter he lived on part of the land granted to him by Virginia or in Louisville for the rest of his life. In 1793 he accepted from Citizen Genet a commission as "major-general in the armies of France, and commander-in-chief of the French Revolutionary Legion in the Mississippi Valley," and tried to raise a force for an attack upon the Spanish possessions in the valley of the Mississippi. The scheme, however, was abandoned after Genet's recall. Disappointed at what he regarded as his country's ingratitude, and broken down by excessive drinking and paralysis, he lost his once powerful influence and lived in comparative isolation until his death, near Louisville, Kentucky, on the 13th of February 1818.

See W. H. English, *Conquest of the Country north-west of the River Ohio, 1778–1783, and Life of George Rogers Clark* (2 vols., Indianapolis and Kansas City, 1896), an accurate and detailed work, which represents an immense amount of research among both printed and manuscript sources. Clark's own accounts of his expeditions, and other interesting documents, are given in the appendix to this work.

CLARK, WILLIAM (1770–1838), the well-known explorer, was the youngest brother of the foregoing. He was born in Caroline county, Virginia, on the 1st of August 1770. At the age of fourteen he removed with his parents to Kentucky, settling at the falls of the Ohio (Louisville). He entered the United States army as a lieutenant of infantry in March 1792, and served under General Anthony Wayne against the Indians in 1794. In July 1796 he resigned his commission on account of ill-health. In 1803–1806, with Meriwether Lewis (*q.v.*), he commanded the famous exploring expedition across the continent to the mouth of the Columbia river, and was commissioned second lieutenant in March 1804 and first lieutenant in January 1806. In February he again resigned from the army. He then served for a few years as brigadier-general of the Louisiana territorial militia, as Indian agent for "Upper Louisiana," as territorial governor of Missouri in 1813–1820, and as superintendent of Indian affairs at St Louis from 1822 until his death there on the 1st of September 1838.

CLARK, SIR JAMES (1788–1870), English physician, was born at Cullen, Banffshire, and was educated at the grammar school of Fordyce and at the universities of Aberdeen and Edinburgh. He served for six years as a surgeon in the army; then spent some time in travelling on the continent, in order to investigate the mineral waters and the climate of various health resorts; and for seven years he lived in Rome. In 1826 he began to practise in London. In 1835 he was appointed physician to the duchess of Kent, becoming physician in ordinary to Queen Victoria in 1837. In 1838 he was created a baronet. He published *The Influence of Climate in Chronic Diseases*, containing valuable meteorological tables (1829), and a *Treatise on Pulmonary Consumption* (1835).

CLARK, JOHN BATES (1847–), American economist, was born at Providence, Rhode Island, on the 26th of January 1847. Educated at Brown University, Amherst College, Heidelberg and Zurich, he was appointed professor of political economy at Carleton College, Minnesota, in 1877. In 1881 he became professor of history and political science in Smith College, Massachusetts; in 1892 professor of political economy in Amherst College. He was appointed professor of political economy at Columbia University in 1895. Among his works are: *The Philosophy of Wealth* (1885); *Wages* (1889); *Capital and its Earnings* (1898); *The Control of Trusts* (1901); *The Problem of Monopoly* (1904); and *Essentials of Economic Theory* (1907).

CLARK, JOSIAH LATIMER (1822–1898), English engineer and electrician, was born on the 10th of March 1822 at Great Marlow, Bucks. His first interest was in chemical manufacturing, but in 1848 he became assistant engineer at the Menai Straits bridge under his elder brother Edwin (1814–1894), the inventor of the Clark hydraulic lift graving dock. Two years later, when his brother was appointed engineer to the Electric Telegraph Company, he again acted as his assistant, and subsequently succeeded him as chief engineer. In 1854 he took out a patent "for conveying letters or parcels between places by the pressure of air and vacuum," and later was concerned in the construction of a large pneumatic despatch tube between the general post office and Euston station, London. About the same period he was engaged in experimental researches on the propagation of the electric current in submarine cables, on which he published a pamphlet in 1855, and in 1859 he was a member of the committee which was appointed by the government to consider the numerous failures of submarine cable enterprises. Latimer Clark paid much attention to the subject of electrical measurement, and besides designing various improvements in method and apparatus and inventing the Clark standard cell, he took a leading part in the movement for the systematization of electrical standards, which was inaugurated by the paper which he and Sir

C. T. Bright read on the question before the British Association in 1861. With Bright also he devised improvements in the insulation of submarine cables. In the later part of his life he was a member of several firms engaged in laying submarine cables, in manufacturing electrical appliances, and in hydraulic engineering. He died in London on the 30th of October 1898. Besides professional papers, he published an *Elementary Treatise on Electrical Measurement* (1868), together with two books on astronomical subjects, and a memoir of Sir W. F. Cooke.

CLARK, THOMAS (1801–1867), Scottish chemist, was born at Ayr on the 31st of March 1801. In 1826 he was appointed lecturer on chemistry at the Glasgow mechanics' institute, and in 1831 he took the degree of M.D. at the university of that city. Two years later he became professor of chemistry in Marischal College, Aberdeen, but was obliged to give up the duties of that position in 1844 through ill-health, though nominally he remained professor till 1860. His name is chiefly known in connexion with his process for softening hard waters, and his water tests, patented in 1841. The last twenty years before his death at Glasgow on the 27th of November 1867 were occupied with the study of the historical origin of the Gospels.

CLARK, WILLIAM GEORGE (1821–1878), English classical and Shakespearian scholar, was born at Barford Hall, Darlington, in March 1821. He was educated at Sedbergh and Shrewsbury schools and Trinity College, Cambridge, where he was elected fellow after a brilliant university career. In 1857 he was appointed public orator. He travelled much during the long vacations, visiting Spain, Greece, Italy and Poland. His *Peloponnesus* (1858) was an important contribution to the knowledge of the country at that time. In 1853 Clark had taken orders, but left the Church in 1870 after the passing of the Clerical Disabilities Act, of which he was one of the promoters. He also resigned the public oratorship in the same year, and in consequence of illness left Cambridge in 1873. He died at York on the 6th of November 1878. He bequeathed a sum of money to his old college for the foundation of a lectureship in English literature. Although Clark was before all a classical scholar, he published little in that branch of learning. A contemplated edition of the works of Aristophanes, a task for which he was singularly fitted, was never published. He visited Italy in 1868 for the express purpose of examining the Ravenna and other MSS., and on his return began the notes to the *Acharnians*, but they were left in too incomplete a state to admit of publication in book form even after his death (see *Journal of Philology*, viii., 1879). He established the *Cambridge Journal of Philology*, and co-operated with B. H. Kennedy and James Riddell in the production of the well-known *Sabrinæ Corolla*. The work by which he is best known is the *Cambridge Shakespeare* (1863–1866), containing a collation of early editions and selected emendations, edited by him at first with John Glover and afterwards with W. Aldis Wright. *Gazpacho* (1853) gives an account of his tour in Spain; his visits to Italy at the time of Garibaldi's insurrection, and to Poland during the insurrection of 1863, are described in *Vacation Tourists*, ed. F. Galton, i. and iii.

H. A. J. Munro in *Journal of Philology* (viii. 1879) describes Clark as "the most accomplished and versatile man he ever met"; see also notices by W. Aldis Wright in *Academy* (Nov. 23, 1878); R. Burn in *Athenæum* (Nov. 16, 1878); *The Times* (Nov. 8, 1878); *Notes and Queries*, 5th series, x. (1878), p. 400.

CLARKE, ADAM (1762?–1832), British Nonconformist divine, was born at Moybeg, Co. Londonderry, Ireland, in 1760 or 1762. After receiving a very limited education he was apprenticed to a linen manufacturer, but, finding the employment uncongenial, he resumed school-life at the institution founded by Wesley at Kingswood, near Bristol. In 1782 he entered on the duties of the ministry, being appointed by Wesley to the Bradford (Wiltshire) circuit. His popularity as a preacher was very great, and his influence in the denomination is indicated by the fact that he was three times (1806, 1814, 1822) chosen to be president of the conference. He served twice on the London circuit, the second period being extended considerably longer than the rule allowed, at the special request of the British and Foreign Bible Society, who had employed him in the preparation

of their Arabic Bible. Though ardent in his pastoral work, he found time for diligent study of Hebrew and other Oriental languages, undertaken chiefly with the view of qualifying himself for the great work of his life, his *Commentary on the Holy Scriptures* (8 vols., 1810–1826). In 1802 he published a *Bibliographical Dictionary* in six volumes, to which he afterwards added a supplement. He was selected by the Records Commission to re-edit Rymer's *Fœdera*, a task which after ten years' labour (1808–1818) he had to resign. He also wrote *Memoirs of the Wesley Family* (1823), and edited a large number of religious works. Honours were showered upon him (he was M.A., LL.D. of Aberdeen), and many distinguished men in church and state were his personal friends. He died in London on the 16th of August 1832.

His *Miscellaneous Works* were published in 13 vols. (1836), and a *Life* (3 vols.) by his son, J. B. B. Clarke, appeared in 1833.

CLARKE, SIR ANDREW (1824–1902), British soldier and administrator, son of Colonel Andrew Clarke, of Co. Donegal, Ireland, governor of West Australia, was born at Southsea, England, on the 27th of July 1824, and educated at King's school, Canterbury. He entered the Royal Military Academy, Woolwich, and obtained his commission in the army in 1844 as second lieutenant in the Royal Engineers. He was appointed to his father's staff in West Australia, but was transferred to be A.D.C. and military secretary to the governor of Tasmania; and in 1847 he went to New Zealand to take part in the Maori War, and for some years served on Sir George Grey's staff. He was then made surveyor-general in Victoria, took a prominent part in framing its new constitution, and held the office of minister of public lands during the first administration (1855–1857). He returned to England in 1857, and in 1863 was sent on a special mission to the West Coast of Africa. In 1864 he was appointed director of works for the navy, and held this post for nine years, being responsible for great improvements in the naval arsenals at Chatham, Portsmouth and Plymouth, and for fortifications at Malta, Cork, Bermuda and elsewhere. In 1873 he was made K.C.M.G., and became governor of the Straits Settlements, where he did most valuable work in consolidating British rule and ameliorating the condition of the people. From 1875 to 1880 he was minister of public works in India; and on his return to England in 1881, holding then the rank of lieutenant-colonel in the army, he was first appointed commandant at Chatham and then inspector-general of fortifications (1882–1886). Having attained the rank of lieutenant-general and been created G.C.M.G., he retired from official life, and in 1886 and 1893 unsuccessfully stood for parliament as a supporter of Mr Gladstone. During his last years he was agent-general for Victoria. He died on the 29th of March 1902. Both as a technical and strategical engineer and as an Imperial administrator Sir Andrew Clarke was one of the ablest and most useful public servants of his time; and his contributions to periodical literature, as well as his official memoranda, contained valuable suggestions on the subjects of imperial defence and imperial consolidation which received too little consideration at a period when the home governments were not properly alive to their importance. He is entitled to remembrance as one of those who first inculcated, from a wide practical experience, the views of imperial administration and its responsibilities, which in his last years he saw accepted by the bulk of his countrymen.

CLARKE, CHARLES COWDEN (1787–1877), English author and Shakespearian scholar, was born at Enfield, Middlesex, on the 15th of December 1787. His father, John Clarke, was a schoolmaster, among whose pupils was John Keats. Charles Clarke taught Keats his letters, and encouraged his love of poetry. He knew Charles and Mary Lamb, and afterwards became acquainted with Shelley, Leigh Hunt, Coleridge and Hazlitt. Clarke became a music publisher in partnership with Alfred Novello, and married in 1828 his partner's sister, Mary Victoria (1809–1898), the eldest daughter of Vincent Novello. In the year after her marriage Mrs Cowden Clarke began her valuable Shakespeare concordance, which was eventually

issued in eighteen monthly parts (1844-1845), and in volume form in 1845 as *The Complete Concordance to Shakespeare, being a Verbal Index to all the Passages in the Dramatic Works of the Poet*. This work superseded the *Copious Index-to . . . Shakespeare* (1790) of Samuel Ayscough, and the *Complete Verbal Index . . .* (1805-1807) of Francis Twiss. Charles Cowden Clarke published many useful books, and edited the text for John Nichol's edition of the British poets; but his most important work consisted of lectures delivered between 1834 and 1856 on Shakespeare and other literary subjects. Some of the more notable series were published, among them being *Shakespeare's Characters, chiefly those subordinate* (1863), and *Molière's Characters* (1865). In 1859 he published a volume of original poems, *Carmina Minima*. For some years after their marriage the Cowden Clarkes lived with the Novellos in London. In 1849 Vincent Novello with his wife removed to Nice, where he was joined by the Clarkes in 1856. After his death they lived at Genoa at the "Villa Novello." They collaborated in *The Shakespeare Key, unlocking the Treasures of his Style . . .* (1879), and in an edition of Shakespeare for Messrs Cassell, which was issued in weekly parts, and completed in 1868. It was reissued in 1886 as *Cassell's Illustrated Shakespeare*. Charles Clarke died on the 13th of March 1877 at Genoa, and his wife survived him until the 12th of January 1898. Among Mrs Cowden Clarke's other works may be mentioned *The Girlhood of Shakespeare's Heroines* (3 vols., 1850-1852), and a translation of Berlioz's *Treatise upon Modern Instrumentation and Orchestration* (1856).

See *Recollections of Writers* (1898), a joint work by the Clarkes containing letters and reminiscences of their many literary friends; and Mary Cowden Clarke's autobiography, *My Long Life* (1896). A charming series of letters (1850-1861), addressed by her to an American admirer of her work, Robert Balmanno, was edited by Anne Upton Nettleton as *Letters to an Enthusiast* (Chicago, 1902).

CLARKE, EDWARD DANIEL (1769-1822), English mineralogist and traveller, was born at Willingdon, Sussex, on the 5th of June 1769, and educated first at Tonbridge. In 1786 he obtained the office of chapel clerk at Jesus College, Cambridge, but the loss of his father at this time involved him in difficulties. In 1790 he took his degree, and soon after became private tutor to Henry Tufton, nephew of the duke of Dorset. In 1792 he obtained an engagement to travel with Lord Berwick through Germany, Switzerland and Italy. After crossing the Alps, and visiting a few of the principal cities of Italy, including Rome, he went to Naples, where he remained nearly two years. Having returned to England in the summer of 1794, he became tutor in several distinguished families. In 1799 he set out with a Mr Cripps on a tour through the continent of Europe, beginning with Norway and Sweden, whence they proceeded through Russia and the Crimea to Constantinople, Rhodes, and afterwards to Egypt and Palestine. After the capitulation of Alexandria, Clarke was of considerable use in securing for England the statues, sarcophagi, maps, manuscripts, &c., which had been collected by the French savants. Greece was the country next visited. From Athens the travellers proceeded by land to Constantinople, and after a short stay in that city directed their course homewards through Rumelia, Austria, Germany and France. Clarke, who had now obtained considerable reputation, took up his residence at Cambridge. He received the degree of LL.D. shortly after his return in 1803, on account of the valuable donations, including a colossal statue of the Eleusinian Ceres, which he had made to the university. He was also presented to the college living of Harlton, near Cambridge, in 1805, to which, four years later, his father-in-law added that of Yeldham. Towards the end of 1808 Dr Clarke was appointed to the professorship of mineralogy in Cambridge, then first instituted. Nor was his perseverance as a traveller otherwise unrewarded. The MSS. which he had collected in the course of his travels were sold to the Bodleian library for £1000; and by the publication of his travels he realized altogether a clear profit of £6595. Besides lecturing on mineralogy and discharging his clerical duties, Dr Clarke eagerly prosecuted the study of chemistry, and made several discoveries, principally by means of the gas blow-pipe, which he had brought to a high

degree of perfection. He was also appointed university librarian in 1817, and was one of the founders of the Cambridge Philosophical Society in 1819. He died in London on the 9th of March 1822. The following is a list of his principal works:—*Testimony of Authors respecting the Colossal Statue of Ceres in the Public Library, Cambridge* (8vo, 1801-1803); *The Tomb of Alexander, a Dissertation on the Sarcophagus brought from Alexandria, and now in the British Museum* (4to, 1805); *A Methodical Distribution of the Mineral Kingdom* (fol., Lewes, 1807); *A Description of the Greek Marbles brought from the Shores of the Euxine, Archipelago and Mediterranean, and deposited in the University Library, Cambridge* (8vo, 1809); *Travels in various Countries of Europe, Asia and Africa* (4to, 1810-1819; 2nd ed., 1811-1823).

See *Life and Remains*, by Rev. W. Otter (1824).

CLARKE, SIR EDWARD GEORGE (1841-), English lawyer and politician, son of J. G. Clarke of Moorgate Street, London, was born on the 15th of February 1841. In 1859 he became a writer in the India office, but resigned in the next year, and became a law reporter. He obtained a Tancred law scholarship in 1861, and was called to the bar at Lincoln's Inn in 1864. He joined the home circuit, became Q.C. in 1880, and a bencher of Lincoln's Inn in 1882. In November 1877 he was successful in securing the acquittal of Chief-Inspector Clarke from the charge brought against certain Scotland Yard officials of conspiracy to defeat justice, and his reputation was assured by his defence of Patrick Staunton in the Penge murder case (1877), and of Mrs Bartlett against the charge of poisoning her husband (1886). Among other notable cases he was counsel for the plaintiff in the libel action brought by Sir William Gordon-Cumming (1890) against Mr and Mrs Lycett Green and others for slander, charging him with cheating in the game of baccarat (in this case the prince of Wales, afterwards Edward VII., gave evidence), and he appeared for Dr Jameson, Sir John Willoughby and others when they were tried (1896) under the Foreign Enlistment Act. He was knighted in 1886. He was returned as Conservative member for Southwark at a by-election early in 1880, but failed to retain his seat at the general election which followed a month or two later; he found a seat at Plymouth, however, which he retained until 1900. He was solicitor-general in the Conservative administration of 1886-1892, but declined office under the Unionist government of 1895 when the law officers of the crown were debarred from private practice. The most remarkable, perhaps, of his speeches in the House of Commons was his reply to Mr Gladstone on the second reading of the Home Rule Bill in 1893. In 1899 differences which arose between Sir Edward Clarke and his party on the subject of the government's South African policy led to his resigning his seat. At the general election of 1906 he was returned at the head of the poll for the city of London, but he offended a large section of his constituents by a speech against tariff reform in the House of Commons on the 12th of March, and shortly afterwards he resigned his seat on grounds of health. He published a *Treatise on the Law of Extradition* (4th ed., 1903), and also three volumes of his political and forensic speeches.

CLARKE, JAMES FREEMAN (1810-1888), American preacher and author, was born in Hanover, New Hampshire, on the 4th of April 1810. He was prepared for college at the public Latin school of Boston, and graduated at Harvard College in 1829, and at the Harvard Divinity School in 1833. He was then ordained as minister of a Unitarian congregation at Louisville, Kentucky, which was then a slave state. Clarke soon threw himself heart and soul into the national movement for the abolition of slavery, though he was never what was then called in America a "radical abolitionist." In 1839 he returned to Boston, where he and his friends established (1841) the "Church of the Disciples." It brought together a body of men and women active and eager in applying the Christian religion to the social problems of the day, and he would have said that the feature which distinguished it from any other church was that they also were ministers of the highest religious life. Ordination could make no distinction between him and them. Of this church he was the minister from 1841 until 1850 and from 1854 until his death. He was also

secretary of the Unitarian Association and, in 1867-1871 professor of natural religion and Christian doctrine at Harvard. From the beginning of his active life he wrote freely for the press. From 1836 until 1839 he was editor of the *Western Messenger*, a magazine intended to carry to readers in the Mississippi Valley simple statements of "liberal religion," involving what were then the most radical appeals as to national duty, especially the abolition of slavery. The magazine is now of value to collectors because it contains the earliest printed poems of Ralph Waldo Emerson, who was Clarke's personal friend. Most of Clarke's earlier published writings were addressed to the immediate need of establishing a larger theory of religion than that espoused by people who were still trying to be Calvinists, people who maintained what a good American phrase calls "hard-shelled churches." But it would be wrong to call his work controversial. He was always declaring that the business of the Church is Eirenic and not Polemic. Such books as *Orthodoxy: Its Truths and Errors* (1866) have been read more largely by members of orthodox churches than by Unitarians. In the great moral questions of his time Clarke was a fearless and practical advocate of the broadest statement of human rights. Without caring much what company he served in, he could always be seen and heard, a leader of unflinching courage, in the front rank of the battle. He published but few verses, but at the bottom he was a poet. He was a diligent and accurate scholar, and among the books by which he is best known is one called *Ten Great Religions* (2 vols., 1871-1883). Few Americans have done more than Clarke to give breadth to the published discussion of the subjects of literature, ethics and religious philosophy. Among his later books are *Every-Day Religion* (1886) and *Sermons on the Lord's Prayer* (1888). He died at Jamaica Plain, Mass., on the 8th of June 1888.

His *Autobiography, Diary and Correspondence*, edited by Edward Everett Hale, was published in Boston in 1891. (E. E. H.)

CLARKE, JOHN SLEEPER (1833-1899), American actor, was born in Baltimore, Maryland, on the 3rd of September 1833, and was educated for the law. He made his first appearance in Boston as Frank Hardy in *Paul Pry* in 1851. In 1859 he married Asia Booth, daughter of Junius Brutus Booth, and he was associated with his brother-in-law Edwin Booth in the management of the Winter Garden theatre in New York, the Walnut Street theatre in Philadelphia and the Boston theatre. In 1867 he went to London, where he made his first appearance at the St James's as Major Wellington de Boots in Stirling Coyne's *Everybody's Friend*, rewritten for him and called *The Widow's Hunt*. His success was so great that he remained in England for the rest of his life, except for four visits to America. Among his favourite parts were Toodles, which ran for 200 nights at the Strand, Dr Pangloss in *The Heir-at-law*, and Dr Ollapod in *The Poor Gentleman*. He managed several London theatres, including the Haymarket, where he preceded the Bancrofts. He retired in 1889, and died on the 24th of September 1899. His two sons also were actors.

CLARKE, MARCUS ANDREW HISLOP (1846-1881), Australian author, was born in London on the 24th of April 1846. He was the only son of William Hislop Clarke, a barrister of the Middle Temple who died in 1863. He emigrated forthwith to Australia, where his uncle, James Langton Clarke, was a county court judge. He was at first a clerk in the bank of Australasia, but showed no business ability, and soon proceeded to learn farming at a station on the Wimmera river, Victoria. He was already writing stories for the *Australian Magazine*, when in 1867 he joined the staff of the Melbourne *Argus* through the introduction of Dr Robert Lewins. He also became secretary (1872) to the trustees of the Melbourne public library and later (1876) assistant librarian. He founded in 1868 the Yorick Club, which soon numbered among its members the chief Australian men of letters. The most famous of his books is *For the Term of his Natural Life* (Melbourne, 1874), a powerful tale of an Australian penal settlement, which originally appeared in serial form in a Melbourne paper. He also wrote *The Peripatetic Philosopher* (1869), a series of amusing papers reprinted from *The Austral-*

asian; Long Odds (London, 1870), a novel; and numerous comedies and pantomimes, the best of which was *Twinkle, Twinkle, Little Star* (Theatre Royal, Melbourne; Christmas, 1873). He married an actress, Marian Dunn. In spite of his popular success Clarke was constantly involved in pecuniary difficulties, which are said to have hastened his death at Melbourne on the 2nd of August 1881.

See *The Marcus Clarke Memorial Volume* (Melbourne, 1884), containing selections from his writings with a biography and list of works, edited by Hamilton Mackinnon.

CLARKE, MARY ANNE (c. 1776-1852), mistress of Frederick duke of York, second son of George III., was born either in London or at Oxford. Her father, whose name was Thompson, seems to have been a tradesman in rather humble circumstances. She married before she was eighteen, but Mr Clarke, the proprietor of a stonemasonry business, became bankrupt, and she left him. After other *liaisons*, she became in 1803 the mistress of the duke of York, then commander-in-chief, maintaining a large and expensive establishment in a fashionable district. The duke's promised allowance was not regularly paid, and to escape her financial difficulties Mrs Clarke trafficked in her protector's position, receiving money from various promotion-seekers, military, civil and even clerical, in return for her promise to secure them the good services of the duke. Her procedure became a public scandal, and in 1809 Colonel Wardle, M.P., brought eight charges of abuse of military patronage against the duke in the House of Commons, and a committee of inquiry was appointed, before which Mrs Clarke herself gave evidence. The result of the inquiry clearly established the charges as far as she was concerned, and the duke of York was shown to have been aware of what was being done, but to have derived no pecuniary benefit himself. He resigned his appointment as commander-in-chief, and terminated his connexion with Mrs Clarke, who subsequently obtained from him a considerable sum in cash and a pension, as the price for withholding the publication of his numerous letters to her. Mrs Clarke died at Boulogne on the 21st of June 1852.

See Taylor, *Authentic Memoirs of Mrs Clarke*; Clarke (? pseud.), *Life of Mrs M. A. Clarke*; *Annual Register*, vol. li.

CLARKE, SAMUEL (1675-1729), English philosopher and divine, son of Edward Clarke, an alderman, who for several years was parliamentary representative of the city of Norwich, was born on the 11th of October 1675, and educated at the free school of Norwich and at Caius College, Cambridge. The philosophy of Descartes was the reigning system at the university; Clarke, however, mastered the new system of Newton, and contributed greatly to its extension by publishing an excellent Latin version of the *Traité de physique* of Jacques Rohault (1620-1675) with valuable notes, which he finished before he was twenty-two years of age. The system of Rohault was founded entirely upon Cartesian principles, and was previously known only through the medium of a rude Latin version. Clarke's translation (1697) continued to be used as a text-book in the university till supplanted by the treatises of Newton, which it had been designed to introduce. Four editions were issued, the last and best being that of 1718. It was translated into English in 1723 by his brother Dr John Clarke (1682-1757), dean of Sarum.

Clarke afterwards devoted himself to the study of Scripture in the original, and of the primitive Christian writers. Having taken holy orders, he became chaplain to John Moore (1646-1714), bishop of Norwich, who was ever afterwards his friend and patron. In 1699 he published two treatises,—one entitled *Three Practical Essays on Baptism, Confirmation and Repentance*, and the other, *Some Reflections on that part of a book called Amyntor, or a Defence of Milton's Life, which relates to the Writings of the Primitive Fathers, and the Canon of the New Testament*. In 1701 he published *A Paraphrase upon the Gospel of St Matthew*, which was followed, in 1702, by the *Paraphrases upon the Gospels of St Mark and St Luke*, and soon afterwards by a third volume upon St John. They were subsequently printed together in two volumes and have since passed through several editions. He intended to treat in the same manner the remaining books of the New Testament, but his design was unfulfilled.

Meanwhile he had been presented by Bishop Moore to the rectory of Drayton, near Norwich. As Boyle lecturer, he dealt in 1704 with the *Being and Attributes of God*, and in 1705 with the *Evidences of Natural and Revealed Religion*. These lectures, first printed separately, were afterwards published together under the title of *A Discourse concerning the Being and Attributes of God, the Obligations of Natural Religion, and the Truth and Certainty of the Christian Revelation, in opposition to Hobbes, Spinoza, the author of the Oracles of Reason, and other Deniers of Natural and Revealed Religion*.

In 1706 he wrote a refutation of Dr Henry Dodwell's views on the immortality of the soul, and this drew him into controversy with Anthony Collins. He also wrote at this time a translation of Newton's *Optics*, for which the author presented him with £500. In the same year through the influence of Bishop Moore, he obtained the rectory of St Benet's, Paul's Wharf, London. Soon afterwards Queen Anne appointed him one of her chaplains in ordinary, and in 1709 presented him to the rectory of St James's, Westminster. He then took the degree of doctor in divinity, defending as his thesis the two propositions: *Nullum fidei Christianae dogma, in Sacris Scripturis traditum, est rectae rationi dissentaneum, et Sine actionum humanarum libertate nulla potest esse religio*. During the same year, at the request of the author, he revised Whiston's English translation of the *Apostolical Constitutions*.

In 1712 he published a carefully punctuated and annotated edition (folio 1712, octavo 1720) of Caesar's *Commentaries*, with elegant engravings, dedicated to the duke of Marlborough. During the same year he published his celebrated treatise on *The Scripture Doctrine of the Trinity*. It is divided into three parts. The first contains a collection and exegesis of all the texts in the New Testament relating to the doctrine of the Trinity; in the second the doctrine is set forth at large, and explained in particular and distinct propositions; and in the third the principal passages in the liturgy of the Church of England relating to the doctrine of the Trinity are considered. Whiston informs us that, some time before the publication of this book, a message was sent to him from Lord Godolphin "that the affairs of the public were with difficulty then kept in the hands of those that were for liberty; that it was therefore an unseasonable time for the publication of a book that would make a great noise and disturbance; and that therefore they desired him to forbear till a fitter opportunity should offer itself,"—a message that Clarke of course entirely disregarded. The ministers were right in their conjectures; and the work not only provoked a great number of replies, but occasioned a formal complaint from the Lower House of Convocation. Clarke, in reply, drew up an apologetic preface, and afterwards gave several explanations, which satisfied the Upper House; and, on his pledging himself that his future conduct would occasion no trouble, the matter dropped.

In 1715 and 1716 he had a discussion with Leibnitz relative to the principles of natural philosophy and religion, which was at length cut short by the death of his antagonist. A collection of the papers which passed between them was published in 1717 (cf. G. v. Leroy, *Die philos. Probleme in dem Briefwechsel Leibniz und Clarke*, Giessen, 1893). In 1719 he was presented by Nicholas 1st Baron Lechmere, to the mastership of Wigston's hospital in Leicester. In 1724 he published seventeen sermons, eleven of which had not before been printed. In 1727, on the death of Sir Isaac Newton, he was offered by the court the place of master of the mint, worth on an average from £1200 to £1500 a year. This secular preferment, however, he absolutely refused. In 1728 was published "A Letter from Dr Clarke to Benjamin Hoadly, F.R.S., occasioned by the controversy relating to the Proportion of Velocity and Force in Bodies in Motion," printed in the *Philosophical Transactions*. In 1729 he published the first twelve books of Homer's *Iliad*. This edition, dedicated to William Augustus, duke of Cumberland, was highly praised by Bishop Hoadly. On Sunday, the 11th of May 1729, when going out to preach before the judges at Serjeants' Inn, he was seized with a sudden illness, which caused his death on the Saturday following (May 17, 1729).

Soon after his death his brother Dr John Clarke, dean of Sarum, published, from his original manuscripts, *An Exposition of the Church Catechism*, and ten volumes of sermons. The *Exposition* is composed of the lectures which he read every Thursday morning, for some months in the year, at St James's church. In the latter part of his life he revised them with great care, and left them completely prepared for the press. Three years after his death appeared also the last twelve books of the *Iliad*, published by his son Samuel Clarke, the first three of these books and part of the fourth having, as he states, been revised and annotated by his father.

In disposition Clarke was cheerful and even playful. An intimate friend relates that he once found him swimming upon a table. At another time Clarke on looking out at the window saw a grave blockhead approaching the house; upon which he cried out, "Boys, boys, be wise; here comes a fool." Dr Warton, in his observations upon Pope's line,

"Unthought-of frailties cheat us in the wise,"

says, "Who could imagine that Locke was fond of romances; that Newton once studied astrology; that Dr Clarke valued himself on his agility, and frequently amused himself in a private room of his house in leaping over the tables and chairs?"

Philosophy.—Clarke, though in no way an original thinker, was eminent in theology, mathematics, metaphysics and philology, but his chief strength lay in his logical power. The materialism of Hobbes, the pantheism of Spinoza, the empiricism of Locke, the determinism of Leibnitz, Collins' necessitarianism, Dodwell's denial of the natural immortality of the soul, rationalistic attacks on Christianity, and the morality of the sensualists—all these he opposed with a thorough conviction of the truth of the principles which he advocated. His fame as theologian and philosopher rests to a large extent on his demonstration of the existence of God and his theory of the foundation of rectitude. The former is not a purely a priori argument, nor is it presented as such by its author. It starts from a fact and it often explicitly appeals to facts. The intelligence, for example, of the self-existence and original cause of all things is, he says, "not easily proved a priori," but "demonstrably proved a posteriori from the variety and degrees of perfection in things, and the order of causes and effects, from the intelligence that created beings are confessedly endowed with, and from the beauty, order, and final purpose of things." The propositions maintained in the argument are—(1) That something has existed from eternity; (2) that there has existed from eternity some one immutable and independent being; (3) that that immutable and independent being, which has existed from eternity, without any external cause of its existence, must be self-existent, that is, necessarily existing; (4) what the substance or essence of that being is, which is self-existent or necessarily existing, we have no idea, neither is it at all possible for us to comprehend it; (5) that though the substance or essence of the self-existent being is itself absolutely incomprehensible to us, yet many of the essential attributes of his nature are strictly demonstrable as well as his existence, and, in the first place, that he must be of necessity eternal; (6) that the self-existent being must of necessity be infinite and omnipresent; (7) must be but one; (8) must be an intelligent being; (9) must be not a necessary agent, but a being endued with liberty and choice; (10) must of necessity have infinite power; (11) must be infinitely wise, and (12) must of necessity be a being of infinite goodness, justice, and truth, and all other moral perfections, such as become the supreme governor and judge of the world."

In order to establish his sixth proposition, Clarke contends that time and space, eternity and immensity, are not substances, but attributes—the attributes of a self-existent being. Edmund Law, Dugald Stewart, Lord Brougham, and many other writers, have, in consequence, represented Clarke as arguing from the existence of time and space to the existence of Deity. This is a serious mistake. The existence of an immutable, independent, and necessary being is supposed to be proved before any reference is made to the nature of time and space. Clarke has been generally supposed to have derived the opinion that time and space are attributes of an infinite immaterial and spiritual being from the *Scholium Generale*, first published in the second edition of Newton's *Principia* (1714). The truth is that his work on the Being and Attributes of God appeared nine years before that *Scholium*. The view propounded by Clarke may have been derived from the Midrash, the Kabbalah, Philo, Henry More, or Cudworth, but not from Newton. It is a view difficult to prove, and probably few will acknowledge that Clarke has conclusively proved it.

His ethical theory of "fitness" (see ETHICS) is formulated on the analogy of mathematics. He held that in relation to the will things possess an objective fitness similar to the mutual consistency of things in the physical universe. This fitness God has given to actions, as he has given laws to Nature; and the fitness is as immutable as the laws. The theory has been unfairly criticized by

Jouffroy, Amédée Jacques, Sir James Mackintosh, Thomas Brown and others. It is said, for example, that Clarke made virtue consist in conformity to the relations of things universally, although the whole tenor of his argument shows him to have had in view conformity to such relations only as belong to the sphere of moral agency. It is true that he might have emphasized the relation of moral fitness to the will, and in this respect J. F. Herbart (*q.v.*) improved on Clarke's statement of the case. To say, however, that Clarke simply confused mathematics and morals by justifying the moral criterion on a mathematical basis is a mistake. He compared the two subjects for the sake of the analogy.

Though Clarke can thus be defended against this and similar criticism, his work as a whole can be regarded only as an attempt to present the doctrines of the Cartesian school in a form which would not shock the conscience of his time. His work contained a measure of rationalism sufficient to arouse the suspicion of orthodox theologians, without making any valuable addition to, or modification of, the underlying doctrine.

AUTHORITIES.—See W. Whiston's *Historical Memoirs*, and the preface by Benjamin Hoadly to Clarke's *Works* (4 vols., London, 1738-1742). See further on his general philosophical position J. Hunt's *Religious Thought in England, passim*, but particularly in vol. ii. 447-457, and vol. iii. 20-29 and 109-115, &c.; Rob. Zimmermann in the *Denkschriften d. k. Akademie der Wissenschaften, Phil.-Hist. Classe* Bd. xix. (Vienna, 1870); H. Sidgwick's *Methods of Ethics* (6th ed., 1901), p. 384; A. Bain's *Moral Science* (1872), p. 562 foll., and *Mental Science* (1872), p. 416; Sir L. Stephen's *English Thought in the Eighteenth Century* (3rd ed., 1902), c. iii.; J. E. le Rossignol, *Ethical Philosophy of S. Clarke* (Leipzig, 1892).

CLARKE, THOMAS SHIELDS (1860—), American artist, was born in Pittsburg, Pennsylvania, on the 25th of April 1860, and graduated at Princeton in 1882. He was a pupil of the Art Students' League, New York, and of the École des Beaux Arts, Paris, under J. L. Gérôme; later he entered the atelier of Dagnan-Bouveret, and, becoming interested in sculpture, worked for a while under Henri M. Chapu. As a sculptor, he received a medal of honour in Madrid for his "The Cider Press," now in the Golden Gate Park, San Francisco, California, and he made four caryatides of "The Seasons" for the Appellate Court House, New York. He designed an "Alma Mater" for Princeton University, and a model is in the library. Among his paintings are his "Night Market in Morocco" (Philadelphia Art Club), for which he received a medal at the International Exposition in Berlin in 1891, and his "A Fool's Fool," exhibited at the Salon in 1887 and now in the collection of the Pennsylvania Academy of Fine Arts, Philadelphia.

CLARKE, WILLIAM BRANWHITE (1798-1878), British geologist, was born at East Bergholt, in Suffolk, on the 2nd of June 1798. He received his early education at Dedham grammar school, and in 1817 entered Jesus College, Cambridge; he took his B.A. in 1821, was ordained and became M.A. in 1824. In 1821 he was appointed curate of Ramsholt in Suffolk, and he acted in his clerical capacity in other places until 1839. Having become interested in geology through the teachings of Sedgwick, he utilized his opportunities and gathered many interesting facts on the geology of East Anglia which were embodied in a paper "On the Geological Structure and Phenomena of Suffolk" (*Trans. Geol. Soc.* 1837). He also communicated a series of papers on the geology of S.E. Dorsetshire to the *Magazine of Nat. Hist.* (1837-1838). In 1839, after a severe illness, he left England for New South Wales, mainly with the object of benefiting by the sea voyage. He remained, however, in that country, and came to be regarded as the "Father of Australian Geology." From the date of his arrival in New South Wales until 1870 he was in clerical charge first of the country from Paramatta to the Hawkesbury river, then of Campbelltown, and finally of Willoughby. He zealously devoted attention to the geology of the country, with results that have been of paramount importance. In 1841 he discovered gold, being the first explorer who had obtained it *in situ* in the country, finding it both in the detrital deposits and in the quartzites of the Blue Mountains, and he then declared his belief in its abundance. In 1849 he made the first actual discovery of tin in Australia and in 1859 he made known the occurrence of the diamond. He was also the first to indicate the presence of Silurian rocks, and to determine the age of the coal-bearing rocks in New South Wales. In 1869 he announced the discovery of remains of *Dinornis* in

Queensland. He was a trustee of the Australian museum at Sydney, and an active member of the Royal Society of New South Wales. In 1860 he published *Researches in the Southern Gold-fields of New South Wales*. He was elected F.R.S. in 1876, and in the following year was awarded the Murchison medal by the Geological Society of London. His contributions to Australian scientific journals were numerous. He died near Sydney, on the 17th of June 1878.

CLARKSON, THOMAS (1760-1846), English anti-slavery agitator, was born on the 28th of March 1760, at Wisbeach, in Cambridgeshire, where his father was headmaster of the free grammar school. He was educated at St Paul's school and at St John's College, Cambridge. Having taken the first place among the middle bachelors as Latin essayist, he succeeded in 1785 in gaining a similar honour among the senior bachelors. The subject appointed by the vice-chancellor, Dr Peckhard, was one in which he was himself deeply interested—*Anne licet invito in servitutem dare?* (Is it right to make men slaves against their will?). In preparing for this essay Clarkson consulted a number of works on African slavery, of which the chief was Benezet's *Historical Survey of New Guinea*; and the atrocities of which he read affected him so deeply that he determined to devote all his energies to effect the abolition of the slave trade, and gave up his intention of entering the church.

His first measure was to publish, with additions, an English translation of his prize essay (June 1786). He then commenced to search in all quarters for information concerning slavery. He soon discovered that the cause had already been taken up to some extent by others, most of whom belonged to the Society of Friends, and among the chief of whom were William Dillwyn, Joseph Wood and Granville Sharp. With the aid of these gentlemen, a committee of twelve was formed in May 1787 to do all that was possible to effect the abolition of the slave trade. Meanwhile Clarkson had also gained the sympathy of Wilberforce, Whitbread, Sturge and several other men of influence. Travelling from port to port, he now commenced to collect a large mass of evidence; and much of it was embodied in his *Summary View of the Slave Trade, and the Probable Consequences of its Abolition*, which, with a number of other anti-slavery tracts, was published by the committee. Pitt, Grenville, Fox and Burke looked favourably on the movement; in May 1788 Pitt introduced a parliamentary discussion on the subject, and Sir W. Dolben brought forward a bill providing that the number of slaves carried in a vessel should be proportional to its tonnage. A number of Liverpool and Bristol merchants obtained permission from the House to be heard by council against the bill, but on the 18th of June it passed the Commons. Soon after Clarkson published an *Essay on the Impolicy of the Slave Trade*; and for two months he was continuously engaged in travelling that he might meet men who were personally acquainted with the facts of the trade. From their lips he collected a considerable amount of evidence; but only nine could be prevailed upon to promise to appear before the privy council. Meanwhile other witnesses had been obtained by Wilberforce and the committee, and on the 12th of May 1789 the former led a debate on the subject in the House of Commons, in which he was seconded by Burke and supported by Pitt and Fox.

It was now the beginning of the French Revolution, and in the hope that he might arouse the French to sweep away slavery with other abuses, Clarkson crossed to Paris, where he remained six months. He found Necker head of the government, and obtained from him some sympathy but little help. Mirabeau, however, with his assistance, prepared a speech against slavery, to be delivered before the National Assembly, and the Marquis de la Fayette entered enthusiastically into his views. During this visit Clarkson met a deputation of negroes from Santo Domingo, who had come to France to present a petition to the National Assembly, desiring to be placed on an equal footing with the whites; but the storm of the Revolution permitted no substantial success to be achieved. Soon after his return home he engaged in a search, the apparent hopelessness of which finely displays his unshrinking labouriousness and his passionate

enthusiasm. He desired to find some one who had himself witnessed the capture of the negroes in Africa; and a friend having met by chance a man-of-war's-man who had done so, Clarkson, though ignorant of the name and address of the sailor, set out in search of him, and actually discovered him. His last tour was undertaken in order to form anti-slavery committees in all the principal towns. At length, in the autumn of 1794, his health gave way, and he was obliged to cease active work. He now occupied his time in writing a *History of the Abolition of the Slave Trade*, which appeared in 1808. The bill for the abolition of the trade became law in 1807; but it was still necessary to secure the assent of the other powers to its principle. To obtain this was, under pressure of the public opinion created by Clarkson and his friends, one of the main objects of British diplomacy at the Congress of Vienna, and in February 1815 the trade was condemned by the powers. The question of concerting practical measures for its abolition was raised at the Congress of Aix-la-Chapelle in 1818, but without result. On this occasion Clarkson personally presented an address to the emperor Alexander I., who communicated it to the sovereigns of Austria and Prussia. In 1823 the Anti-Slavery Society was formed, and Clarkson was one of its vice-presidents. He was for some time blind from cataract; but several years before his death on the 26th of September 1846, his sight was restored.

Besides the works already mentioned, he published the *Portraiture of Quakerism* (1806), *Memoirs of William Penn* (1813), *Researches, Antediluvian, Patriarchal and Historical* (1836), intended as a history of the interference of Providence for man's spiritual good, and *Strictures on several of the remarks concerning himself made in the Life of Wilberforce*, in which his claim as originator of the anti-slavery movement is denied.

See the lives by Thomas Elmes (1876) and Thomas Taylor (1839).

CLARKSVILLE, a city and the county-seat of Montgomery county, Tennessee, U.S.A., situated in the N. part of the state, about 50 m. N.W. of Nashville, on the Cumberland river, at the mouth of the Red river. Pop. (1890) 7924; (1900) 9431, of whom 5094 were negroes; (1910 census) 8548. It is served by the Louisville & Nashville, and the Illinois Central railways, and by passenger and freight steamboat lines on the Cumberland river. The city hall and the public library are among the principal public buildings, and the city is the seat of the Tennessee Odd Fellows' home, and of the South-Western Presbyterian University, founded in 1875. Clarksville lies in the centre of the dark tobacco belt—commonly known as the "Black Patch"—and is an important tobacco market, with an annual trade in that staple of about \$4,000,000, most of the product being exported to France, Italy, Austria and Spain. The city is situated in a region well adapted for the growing of wheat, Indian corn, and vegetables, and for the raising of live-stock; and Clarksville is a shipping point for the lumber—chiefly oak, poplar and birch—and the iron-ore of the surrounding country, a branch of the Louisville & Nashville railway extending into the iron district. The city's principal manufactures are flour and grist mill products, chewing and smoking tobacco and snuff, furniture, lumber, iron, and pearl buttons. The value of the factory product in 1905 was \$2,210,112, being 32% greater than in 1900. The municipality owns its water-works. Clarksville was first settled as early as 1780, was named in honour of General George Rogers Clark, and was chartered as a city in 1850.

CLASSICS. The term "classic" is derived from the Latin epithet *classicus*, found in a passage of Aulus Gellius (xix. 8. 15), where a "scriptor 'classicus'" is contrasted with a "scriptor proletarius." The metaphor is taken from the division of the Roman people into *classes* by Servius Tullius, those in the first class being called *classici*, all the rest *infra classem*, and those in the last *proletarii*.¹ The epithet "classic" is accordingly applied (1) generally to an author of the first rank, and (2) more

¹The above derivation is in accordance with English usage. In the *New English Dictionary* the earliest example of the word "classical" is the phrase "classical and canonical," found in the *Europae Speculum* of Sir Edwin Sandys (1599), and, as applied to a writer, it is explained as meaning "of the first rank or authority." This exactly corresponds with the meaning of *classicus* in the above passage of Gellius. On the other hand, the French word *classique* (in Littré's view) primarily means "used in class."

particularly to a Greek or Roman author of that character. Similarly, "the classics" is a synonym for the choicest products of the literature of ancient Greece and Rome. It is to this sense of the word that the following article is devoted in two main divisions: (A) the general history of classical (*i.e.* Greek and Latin) scholarship, and (B) its place in higher education.

(A) GENERAL HISTORY OF THE STUDY OF THE CLASSICS

We may consider this subject in four principal periods:—

(i.) the *Alexandrian*, c. 300–1 B.C.; (ii.) the *Roman*, A.D. c. 1–530; (iii.) the *Middle Ages*, c. 530–1350; and (iv.) the *Modern Age*, c. 1350 to the present day.

(i.) *The Alexandrian Age.*—The study of the Greek classics begins with the school of Alexandria. Under the rule of Ptolemy Philadelphus (285–247 B.C.), learning found a home in the Alexandrian Museum and in the great Alexandrian Library. The first four librarians were Zenodotus, Eratosthenes, Aristophanes of Byzantium, and Aristarchus. Zenodotus produced before 274 the first scientific edition of the *Iliad* and *Odyssey*, an edition in which spurious lines were marked, at the beginning, with a short horizontal dash called an *obelus* (—). He also drew up select lists of epic and lyric poets. Soon afterwards a classified catalogue of dramatists, epic and lyric poets, legislators, philosophers, historians, orators and rhetoricians, and miscellaneous writers, with a brief biography of each, was produced by the scholar and poet Callimachus (*fl.* 260). Among the pupils of Callimachus was Eratosthenes who, in 234, succeeded Zenodotus as librarian. Apart from his special interest in the history of the Old Attic comedy, he was a man of vast and varied learning; the founder of astronomical geography and of scientific chronology; and the first to assume the name of φιλόλογος. The greatest philologist of antiquity was, however, his successor, Aristophanes of Byzantium (195), who reduced accentuation and punctuation to a definite system, and used a variety of critical symbols in his recension of the *Iliad* and *Odyssey*. He also edited Hesiod and Pindar, Euripides and Aristophanes, besides composing brief introductions to the several plays, parts of which are still extant. Lastly, he established a scientific system of lexicography and drew up lists of the "best authors." Two critical editions of the *Iliad* and *Odyssey* were produced by his successor, Aristarchus, who was librarian until 146 B.C. and was the founder of scientific scholarship. His distinguished pupil, Dionysius Thrax (born c. 166 B.C.), drew up a Greek grammar which continued in use for more than thirteen centuries. The most industrious of the successors of Aristarchus was Didymus (c. 65 B.C.–A.D. 10), who, in his work on the Homeric poems, aimed at restoring the lost recensions of Aristarchus. He also composed commentaries on the lyric and comic poets and on Thucydides and Demosthenes; part of his commentary on this last author was first published in 1904. He was a teacher in Alexandria (and perhaps also in Rome); and his death, about A.D. 10, marks the close of the Alexandrian age. He is the industrious compiler who gathered up the remnants of the learning of his predecessors and transmitted them to posterity. The poets of that age, including Callimachus and Theocritus, were subsequently expounded by Theon, who flourished under Tiberius, and has been well described as "the Didymus of the Alexandrian poets."

The Alexandrian canon of the Greek classics, which probably had its origin in the lists drawn up by Callimachus, Aristophanes of Byzantium and Aristarchus, included the following authors:—

Epic poets (5): Homer, Hesiod, Peisander, Panyasis, Antimachus.

Iambic poets (3): Simonides of Amorgos, Archilochus, Hipponax.

Tragic poets (5): Aeschylus, Sophocles, Euripides, Ion, Achaëus.

Comic poets, Old (7): Epicharmus, Cratinus, Eupolis, Aristophanes, Pherecrates, Crates, Plato.

Middle (2): Antiphanes, Alexis.

New (5): Menander, Philippides, Diphilus, Philemon, Apollodorus.

Elegiac poets (4): Callinus, Mimnermus, Philetas, Callimachus.

Lyric poets (9): Alcman, Alcaeus, Sappho, Stesichorus, Pindar, Bacchylides, Ibycus, Anacreon, Simonides of Ceos.

Orators (10): Demosthenes, Lysias, Hyperides, Isocrates, Aeschines, Lycurgus, Isaeus, Antiphon, Andocides, Deinarchus.

Historians (10): Thucydides, Herodotus, Xenophon, Philistus, Theopompus, Ephorus, Anaximenes, Callisthenes, Hellenicus, Polybius.

The latest name in the above list is that of Polybius, who died about 123 B.C. Apollonius Rhodius, Aratus and Theocritus were subsequently added to the "epic" poets. Philosophers, such as Plato and Aristotle, were possibly classed in a separate "canon."

While the scholars of Alexandria were mainly interested in the *verbal criticism* of the Greek poets, a wider variety of studies was the characteristic of the school of Pergamum, the literary rival of Alexandria. Pergamum was a home of learning for a large part of the 150 years of the Attalid dynasty, 283-133 B.C.

The grammar of the Stoics, gradually elaborated by Zeno, Cleanthes and Chrysippus, supplied a terminology which, in words such as "genitive," "accusative" and "aorist," has become a permanent part of the grammarian's vocabulary; and the study of this grammar found its earliest home in Pergamum.

From about 168 B.C. the head of the Pergamene school was Crates of Mallus, who (like the Stoics) was an adherent of the principle of "anomaly" in grammar, and was thus opposed to Aristarchus of Alexandria, the champion of "analogy." He also opposed Aristarchus, and supported the Stoics, by insisting on an *allegorical* interpretation of Homer. He is credited with having drawn up the classified lists of the best authors for the Pergamene library. His mission as an envoy to the Roman senate, "shortly after the death of Ennius" in 169 B.C., had a remarkable influence on literary studies in Rome. Meeting with an accident while he was wandering on the Palatine, and being detained in Rome, he passed part of his enforced leisure in giving lectures (possibly on Homer, his favourite author), and thus succeeded in arousing among the Romans a taste for the scholarly study of literature. The example set by Crates led to the production of a new edition of the epic poem of Naevius, and to the public recitation of the *Annals* of Ennius, and (two generations later) the *Satires* of Lucilius.

(ii.) *The Roman Age.*—(a) *Latin Studies.*—In the 1st century B.C. the foremost scholar in Rome was L. Aelius Stilo (c. 154-c. 74), who is described by Cicero as profoundly learned in Greek and Latin literature, and as an accomplished critic of Roman antiquities and of ancient authors. Of the plays then passing under the name of Plautus, he recognized twenty-five as genuine. His most famous pupil was Varro (116-27), the six surviving books of whose great work on the Latin language are mainly concerned with the great grammatical controversy on analogy and anomaly—a controversy which also engaged the attention of Cicero and Caesar, and of the elder Pliny and Quintilian. The twenty-one plays of Plautus accepted by Varro are doubtless the twenty now extant, together with the lost *Vidularia*. The influence of Varro's last work on the nine *disciplinae*, or branches of study, long survived in the seven "liberal arts" recognized by St Augustine and Martianus Capella, and in the *trivium* and *quadrivium* of the middle ages.

Part of Varro's treatise on Latin was dedicated to Cicero (106-43), who as an interpreter of Greek philosophy to his fellow-countrymen enlarged the vocabulary of Latin by his admirable renderings of Greek philosophical terms, and thus ultimately gave us such indispensable words as "species," "quality" and "quantity."

The earliest of Latin lexicons was produced about 10 B.C. by Verrius Flaccus in a work, *De Verborum Significatu*, which survived in the abridgment by Festus (2nd century A.D.) and in the further abridgment dedicated by Paulus Diaconus to Charles the Great.

Greek models were diligently studied by Virgil and Horace. Their own poems soon became the theme of criticism and of comment; and, by the time of Quintilian and Juvenal, they shared the fate (which Horace had feared) of becoming text-books for use in schools.

Recensions of Terence, Lucretius and Persius, as well as Horace and Virgil, were produced by Probus (d. A.D. 88), with critical symbols resembling those invented by the Alexandrian scholars. His contemporary Asconius is best known as the author of an extant historical commentary on five of the speeches

of Cicero. In A.D. 88 Quintilian was placed at the head of the first state-supported school in Rome. His comprehensive work on the training of the future orator includes an outline of general education, which had an important influence on the humanistic schools of the Italian Renaissance. It also presents us with a critical survey of the Greek and Latin classics arranged under the heads of poets, historians, orators and philosophers (book x. chap. i.). The lives of Roman poets and scholars were among the many subjects that exercised the literary skill of Hadrian's private secretary, Suetonius. One of his lost works is the principal source of the erudition of Isidore of Seville (d. A.D. 636), whose comprehensive encyclopaedia was a favourite text-book in the middle ages. About the time of the death of Suetonius (A.D. 160) a work entitled the *Noctes Atticae* was begun by Aulus Gellius. The author is an industrious student and a typical scholar, who frequents libraries and is interested in the MSS. of old Latin authors. Early in the 4th century the study of grammar was represented in northern Africa by the Numidian tiro, Nonius Marcellus (fl. 323), the author of an encyclopaedic work in three parts, lexicographical, grammatical and antiquarian, the main value of which lies in its quotations from early Latin literature. About the middle of the same century grammar had a far abler exponent at Rome in the person of Aelius Donatus, the preceptor of St Jerome, as well as the author of a text-book that remained in use throughout the middle ages. The general state of learning in this century is illustrated by Ausonius (c. 310-393), the grammarian and rhetorician of Bordeaux, the author of the *Mosella*, and the probable inspirer of the memorable decree of Gratian (376), providing for the appointment and the payment of teachers of rhetoric and of Greek and Latin literature in the principal cities of Gaul. His distinguished friend, Q. Aurelius Symmachus, the consul of A.D. 391, aroused in his own immediate circle an interest in Livy, the whole of whose history was still extant. Early in the 5th century other aristocratic Romans interested themselves in the textual criticism of Persius and Martial. Among the contemporaries of Symmachus, the devoted adherent of the old Roman religion, was St Jerome (d. 420), the most scholarly representative of Christianity in the 4th century, the student of Plautus and Terence, of Virgil and Cicero, the translator of the *Chronology* of Eusebius, and the author of the Latin version of the Bible now known as the Vulgate. St Augustine (d. 430) confesses to his early fondness for Virgil, and also tells us that he received his first serious impressions from the *Hortensius* of Cicero, an eloquent exhortation to the study of philosophy, of which only a few fragments survive. In his survey of the "liberal arts" St Augustine imitates (as we have seen) the *Disciplinae* of Varro, and in the greatest of his works, the *De Civitate Dei* (426), he has preserved large portions of the *Antiquitates* of Varro and the *De Republica* of Cicero. About the same date, and in the same province of northern Africa, Martianus Capella produced his allegorical work on the "liberal arts," the principal, and, indeed, often the only, text-book of the medieval schools.

In the second half of the 5th century the foremost representative of Latin studies in Gaul was Apollinaris Sidonius (fl. 470), whose *Letters* were modelled on those of the younger Pliny, while his poems give proof of a wide though superficial acquaintance with classical literature. He laments the increasing decline in the classical purity of the Latin language.

An interest in Latin literature lived longest in Gaul, where schools of learning flourished as early as the 1st century at Autun, Lyons, Toulouse, Nîmes, Vienne, Narbonne and Marseilles; and, from the 3rd century onwards, at Trier, Poitiers, Besançon and Bordeaux.

About ten years after the death of Sidonius we find Asterius, the consul of 494, critically revising the text of Virgil in Rome. Boëthius, who early in life formed the ambitious plan of expounding and reconciling the opinions of Plato and Aristotle, continued in the year of his sole consulship (510) to instruct his fellow-countrymen in the wisdom of Greece. He is a link between the ancient world and the middle ages, having been the last of the learned Romans who understood the language and studied the

literature of Greece, and the first to interpret to the middle ages the logical treatises of Aristotle. He thereby gave the signal for the age-long conflict between Nominalism and Realism, which exercised the keenest intellects among the Schoolmen, while the crowning work of his life, the *Consolatio Philosophicæ* (524), was repeatedly expounded and imitated, and reproduced in renderings that were among the earliest literary products of the vernacular languages of modern Europe. His contemporary, Cassiodorus (c. 480-c. 575), after spending thirty years in the service of the Ostrogothic dynasty at Ravenna, passed the last thirty-three years of his long life on the shores of the Bay of Squillace, where he founded two monasteries and diligently trained their inmates to become careful copyists. In his latest work he made extracts for their benefit from the pages of Priscian (fl. 512), a transcript of whose great work on Latin grammar was completed at Constantinople by one of that grammarian's pupils in 527, to be reproduced in a thousand MSS. in the middle ages. More than ten years before Cassiodorus founded his monasteries in the south of Italy, Benedict of Nursia (480-543) had rendered a more permanent service to the cause of scholarship by building, amid the ruins of the temple of Apollo on the crest of Monte Cassino, the earliest of those homes of learning that have lent an undying distinction to the Benedictine order. The learned labours of the Benedictines were no part of the original requirements of the rule of St Benedict; but before the founder's death his favourite disciple had planted a monastery in France, and the name of that disciple is permanently associated with the learned labours of the Benedictines of the Congregation of St Maur (see MAURISTS).

(b) *Greek Studies*.—Meanwhile, the study of the Greek classics was ably represented at Rome in the Augustan age by Dionysius of Halicarnassus (fl. 30-8 B.C.), the intelligent critic of the ancient Attic orators, while the 1st century of our era is the probable date of the masterpiece of literary criticism known as the treatise *On the Sublime* by Longinus (q.v.).

The 2nd century is the age of the two great grammarians, Apollonius Dyscolus (the founder of scientific grammar and the creator of the study of Greek syntax) and his son Herodian, the larger part of whose principal work dealt with the subject of Greek accentuation. It is also the age of the lexicographers of Attic Greek, the most important of whom are Phrynichus, Pollux (fl. A.D. 180) and Harpocration.

In the 4th century Demosthenes was expounded and imitated by the widely influential teacher, Libanius of Antioch (c. 314-c. 393), the pagan preceptor of St Chrysostom. To the same century we may assign the grammarian Theodosius of Alexandria, who, instead of confining himself (like Dionysius Thrax) to the tenses of *ῥίπτω* in actual use, was the first to set forth all the imaginary aorists and futures of that verb, which have thence descended through the Byzantine age to the grammars of the Renaissance and of modern Europe.

In the 5th century we may place Hesychius of Alexandria, the compiler of the most extensive of our ancient Greek lexicons, and Proclus, the author of a chrestomathy, to the extracts from which (as preserved by Photius) we owe almost all our knowledge of the contents of the lost epics of early Greece. In the same century the study of Plato was represented by Synesius of Cyrene (c. 370-c. 413) and by the Neoplatonists of Alexandria and of Athens. The lower limit of the Roman age of classical studies may be conveniently placed in the year 529. In that year the monastery of Monte Cassino was founded in the West, while the school of Athens was closed in the East. The Roman age thus ends in the West with Boëthius, Cassiodorus and St Benedict, and in the East with Priscian and Justinian.

(iii.) *The Middle Ages*.—(a) *In the East*, commonly called the *Byzantine Age*, c. 530-1350. In this age, grammatical learning was represented by Choeroboscus, and lexicography by Photius (d. 891), the patriarch of Constantinople, who is also the author of a *Bibliotheca* reviewing and criticizing the contents of 280 MSS., and incidentally preserving important extracts from the lost Greek historians.

In the time of Photius the poets usually studied at school were Homer, Hesiod, Pindar; certain select plays of Aeschylus (*Prometheus*, *Septem* and *Persæ*), Sophocles (*Ajax*, *Electra* and *Oedipus Tyrannus*), and Euripides (*Hecuba*, *Orestes*, *Phoenissæ*, and, next to these, *Alcestitis*, *Andromachæ*, *Hippolytus*, *Medæa*, *Rhesus*, *Troades*), also Aristophanes (beginning with the *Plutus*), Theocritus, Lycophron, and Dionysius Periegetes. The principal prose authors were Thucydides, parts of Plato and Demosthenes, with Aristotle, Plutarch's *Lives*, and, above all, Lucian, who is often imitated in the Byzantine age.

One of the distinguished pupils of Photius, Arcetas, bishop of Caesarea in Cappadocia (c. 907-932), devoted himself with remarkable energy to collecting and expounding the Greek classics. Among the important MSS. still extant that were copied at his expense are the Bodleian Euclid (888) and the Bodleian Plato (895). To the third quarter of the 10th century we may assign the Greek lexicon of Suidas, a combination of a lexicon and an encyclopaedia, the best articles being those on the history of literature.

Meanwhile, during the "dark age" of secular learning at Constantinople (641-850), the light of Greek learning had spread eastwards to Syria and Arabia. At Bagdad, in the reign of Mamun (813-833), the son of Harun al-Rashid, philosophical works were translated by Syrian Christians from Greek into Syriac and from Syriac into Arabic. It was in his reign that Aristotle was first translated into Arabic, and, shortly afterwards, we have Syriac and Arabic renderings of commentators on Aristotle, and of portions of Plato, Hippocrates and Galen; while in the 10th century new translations of Aristotle and his commentators were produced by the Nestorian Christians.

The Arabic translations of Aristotle passed from the East to the West by being transmitted through the Arab dominions in northern Africa to Spain, which had been conquered by the Arabs in the 8th century. In the 12th century Toledo was the centre of the study of Aristotle in the West, and it was from Toledo that the knowledge of Aristotle spread to Paris and to other seats of learning in western Europe.

The 12th century in Constantinople is marked by the name of Tzetzes (c. 1110-c. 1180), the author of a mythological, literary and historical miscellany called the *Chiliades*, in the course of which he quotes more than four hundred authors. The prolegomena to his scholia on Aristophanes supply us with valuable information on the Alexandrian libraries. The most memorable name, however, among the scholars of this century is that of Eustathius, whose philological studies at Constantinople preceded his tenure of the archbishopric of Thessalonica (1175-1192). The opening pages of his commentaries on the *Iliad* and the *Odyssey* dwell with enthusiasm on the abiding influence of Homer on the literature of Greece.

While the Byzantine MSS. of the 11th century (such as the Laurentian MSS. of Aeschylus and Sophocles, and the Ravenna MS. of Aristophanes) maintain the sound traditions of the Alexandrian and Roman ages, those of the times of the Palaeologi give proof of a frequent tampering with the metres of the ancient poets in order to bring them into conformity with theories recently invented by Moschopolus and Triclinius. The scholars of these times are the natural precursors of the earliest representatives of the Revival of Learning in the West. Of these later Byzantines the first in order of date is the monk Planudes (d. 1330), who devoted his knowledge of Latin to producing excellent translations of Caesar's *Galic War* as well as Ovid's *Metamorphoses* and *Heroides*, and the classic work of Boëthius; he also compiled (in 1302) the only Greek anthology known to scholars before the recovery in 1607 of the earlier and fuller anthology of Cephalas (fl. 917).

The scholars of the Byzantine age cannot be compared with the great Alexandrians, but they served to maintain the continuity of tradition by which the Greek classics selected by the critics of Alexandria were transmitted to modern Europe.

(b) *In the West* (c. 530-c. 1350).—At the portal of the middle ages stands Gregory the Great (c. 540-604), who had little (if any) knowledge of Greek and had no sympathy with the *secular*

side of the study of Latin. A decline in grammatical learning is exemplified in the three Latin historians of the 6th century, Jordanes, Gildas and Gregory of Tours (d. 594), who begins his history of the Franks by lamenting the decay of Latin literature in Gaul. The historian of Tours befriended the Latin poet, Venantius Fortunatus (d. c. 600), who is still remembered as the writer of the three well-known hymns beginning *Salve festa dies*, *Vexilla regis prodeunt*, and *Pange lingua gloriosi prodium certaminis*. The decadence of Latin early in the 7th century is exemplified by the fantastic grammarian Virgilius Maro, who also illustrates the transition from Latin to Provençal, and from quantitative to accentual forms of verse.

While Latin was declining in Gaul, even Greek was not unknown in Ireland, and the Irish passion for travel led to the spread of Greek learning in the west of Europe. The Irish monk Columban, shortly before his death in 615, founded in the neighbourhood of Pavia the monastery of Bobbio, to be the repository of many Latin MSS. which were ultimately dispersed among the libraries of Rome, Milan and Turin. About the same date his fellow-traveller, Gallus, founded above the Lake of Constance the monastery of St Gallen, where Latin MSS. were preserved until their recovery in the age of the Renaissance. During the next twenty-five years Isidore of Seville (d. 636) produced in his *Origines* an encyclopaedic work which gathered up for the middle ages much of the learning of the ancient world.

In Italy a decline in the knowledge of Greek in the 5th and 6th centuries led to an estrangement between the Greek and Latin Churches. The year 690 is regarded as the date of the temporary extinction of Greek in Italy, but, in the first quarters of the 8th and the 9th centuries, the iconoclastic decrees of the Byzantine emperors drove many of the Greek monks and their lay adherents to the south of Italy, and even to Rome itself.

In Ireland we find Greek characters used in the Book of Armagh (c. 807); and, in the same century, a Greek psalter was copied by an Irish monk of Liège, named Sedulius (fl. 850), who had a wide knowledge of Latin literature. In England, some sixty years after the death of Augustine, the Greek archbishop of Canterbury, Theodore of Tarsus (d. 690) founded a school for the study of Greek, and with the help of an African monk named Hadrian made many of the English monasteries schools of Greek and Latin learning, so that, in the time of Bede (d. 735), some of the scholars who still survived were "as familiar with Greek and Latin as with their mother-tongue." Among those who had learned their Greek at Canterbury was Aldhelm (d. 709), "the first Englishman who cultivated classical learning with any success." While Aldhelm is known as "the father of Anglo-Latin verse," Latin prose was the literary medium used by Bede in his celebrated *Ecclesiastical History* of England (731). Nine years after the death of Bede (735), Boniface, "the apostle of Germany," sanctioned the founding of Fulda (744), which soon rivalled St Gallen as a school of learning. Alcuin (d. 804), who was probably born in the year of Bede's death, tells us of the wealth of Latin literature preserved in the library at York. Through the invitation of Charles the Great, he became associated with the revival of learning which marks the reign of that monarch, by presiding over the School of the Palace (782-790), and by exercising a healthy influence as abbot of St Martin's at Tours (796-804). Among the friends of Alcuin and the advisers of Charles was Theodulfus, bishop of Orleans and abbot of Fleury (d. 821), who is memorable as an accomplished Latin poet, and as the initiator of free education. Einhard (d. 840), in his classic life of Charles the Great, models his style on that of Suetonius, and shows his familiarity with Caesar and Livy and Cicero, while Rabanus Maurus (d. 856), who long presided over Einhard's school of Fulda, was the first to introduce Priscian into the schools of Germany. His pupil, Walafrid Strabo, the abbot of Reichenau (d. 849), had a genuine gift for Latin poetry, a gift agreeably exemplified in his poem on the plants in the monastic garden. In the same century an eager interest in the Latin classics is displayed by Servatus Lupus, who was educated at Fulda, and was abbot of Ferrières for the last twenty years of his life (d. 862). In his literary spirit he is a precursor of the

humanists of the Renaissance. Under Charles the Bald (d. 877) there was a certain revival of interest in literature, when John the Scot (Erigena) became, for some thirty years (c. 845-875), the head of the Palace School. He was familiar with the Greek Fathers, and was chosen to execute a Latin rendering of the writings of "Dionysius the Areopagite," the patron saint of France. In the preface the translator praises the king for prompting him not to rest satisfied with the literature of the West, but to have recourse to the "most pure and copious waters of the Greeks." In the next generation Remi of Auxerre was the first to open a school in Paris (900). Virgil is the main authority quoted in Remi's Commentary on Donatus, which remained in use until the Renaissance. During the two centuries after John the Scot, the study of Greek declined in France. In England the 9th century closes with Alfred, who, with the aid of the Welsh monk, Asser, produced a series of free translations from Latin texts, including Boëthius and Orosius and Bede, and the *Cura Pastoralis* of Gregory the Great.

In the 10th century learning flourished at Aachen under Bruno, brother of Otto I. and archbishop of Cologne (953-965), who had himself learned Greek from certain Eastern monks at the imperial court, and who called an Irish bishop from Trier to teach Greek at the imperial capital. He also encouraged the transcription of Latin MSS., which became models of style to Widukind of Corvey, the imitator of Sallust and Livy. In the same century the monastery of Gandersheim, south of Hanover, was the retreat of the learned nun Hroswitha, who celebrated the exploits of Otho in leonine hexameters, and composed in prose six moral and religious plays in imitation of Terence. One of the most prominent personages of the century was Gerbert of Aurillac, who, after teaching at Tours and Fleury, became abbot of Bobbio, archbishop of Reims, and ultimately pope under the name of Silvester II. (d. 1003). He frequently quotes from the speeches of Cicero, and it has been surmised that the survival of those speeches may have been due to the influence of Gerbert. The most original hellenist of this age is Luitprand, bishop of Cremona (d. 972), who acquired some knowledge of Greek during his repeated missions to Constantinople. About the same time in England Oswald of York, who had himself been educated at Fleury, invited Abbo (d. 1004) to instruct the monks of the abbey recently founded at Ramsey, near Huntingdon. At Ramsey he wrote for his pupils a scholarly work dealing with points of prosody and pronunciation, and exhibiting an accurate knowledge of Virgil and Horace. During the same half-century, Ælfric, the abbot of Eynsham (d. c. 1030), aided Bishop Æthelwold in making Winchester famous as a place of education. It was there that he began his *Latin Grammar*, his *Glossary* (the earliest Latin-English dictionary in existence), and his *Colloquium*, in which Latin is taught in a conversational manner.

In France, the most notable teacher in the first quarter of the 11th century was Fulbert, bishop of Chartres (d. 1029). In and after the middle of that century the Norman monastery of Bec flourished under the rule of Lanfranc and Anselm, both of whom had begun their career in northern Italy, and closed it at Canterbury. Meanwhile, in Germany, the styles of Sallust and Livy were being happily imitated in the *Annals* of Lambert of Hersfeld (d. 1077). In Italy, where the study of Latin literature seems never to have entirely died out, young nobles and students preparing for the priesthood were not infrequently learning Latin together, in private grammar schools under liberal clerics, such as Anselm of Bisate (fl. 1050), who describes himself as divided in his allegiance between the saints and the muses. Learning flourished at Monte Cassino under the rule of the Abbot Desiderius (afterwards Pope Victor III.). In this century that famous monastery had its classical chronicler in Leo Marsicanus, and its Latin poet in Alfanus, the future archbishop of Salerno.

The Schoolmen devoted most of their attention to Aristotle, and we may here briefly note the successive stages in their gradually increasing knowledge of his works. Until 1128 only the first two of the five parts of the *Organon* were known, and those solely in Latin translations from the original. After that date two more became known; the whole was familiar to John

of Salisbury in 1159; while the *Physics* and *Metaphysics* came into notice about 1200. Plato was mainly represented by the Latin translation of the *Timaeus*. Abelard (d. 1142) was acquainted with no Greek works except in Latin translations, but he has left his mark on the history of European education. The wide popularity of his brilliant lectures in the "schools" of Paris made this city the resort of the many students who were ultimately organized as a "university" (c. 1170). John of Salisbury attended Abelard's lectures in 1136, and, after spending two years in the study of logic in Paris, passed three more in the scholarly study of Latin literature at Chartres, where a sound and healthy tradition, originally due to Bernard of Chartres (fl. 1120), was still perpetuated by his pupils. In that school the study of "figures of speech" was treated as merely introductory to that of the classical texts. Stress was laid on the sense as well as the style of the author studied. Discussions on set subjects were held, select passages from the classics learned by heart, while written exercises in prose and verse were founded on the best ancient models. In the general scheme of education the authority followed was Quintilian. John of Salisbury (d. 1180), the ripest product of this school, is the most learned man of his time. His favourite author is Cicero, and in all the Latin literature accessible to him he is the best-read scholar of his age. Among Latin scholars of the next generation we have Giraldus Cambrensis (d. c. 1222), the author of topographical and historical writings on Ireland and Wales, and of other works teeming with quotations from the Latin classics. During the middle ages Latin prose never dies out. It is the normal language of literature. In England it is used by many chroniclers and historians, the best known of whom are William of Malmesbury (d. 1142) and Matthew Paris (d. 1259). In Italy Latin verse had been felicitously applied to historic themes by William of Apulia (fl. 1100) and other Latin poets (1088-1247). In the 12th century England claims at least seven Latin poets, one of these being her only Latin epic poet, Joseph of Exeter (d. 1210), whose poem on the Trojan war is still extant. The Latin versifier, John of Garlandia, an Englishman who lived mainly in France (fl. 1204-1252), produced several Latin vocabularies which were still in use in the boyhood of Erasmus. The Latin poets of French birth include Gautier and Alain de Lille (d. c. 1203), the former being the author of the *Alexandreis*, and the latter that of the *Anti-Claudianus*, a poem familiar to Chaucer.

During the hundred and thirty years that elapsed between the early translations of Aristotle executed at Toledo about 1150 and the death in 1281 of William of Moerbeke, the translator of the *Rhetoric* and the *Politics*, the knowledge of Aristotle had been greatly extended in Europe by means of translations, first from the Arabic, and, next, from the original Greek. Aristotle had been studied in England by Grosseteste (d. 1253), and expounded abroad by the great Dominican, Albertus Magnus (d. 1280), and his famous pupil, Thomas Aquinas (d. 1274). Among the keenest critics of the Schoolmen and of the recent translations of Aristotle was Roger Bacon (d. 1294), whose *Opus majus* has been recognized as the *Encyclopédie* and the *Organon* of the 13th century. His knowledge of Greek, as shown in his *Greek Grammar* (first published in 1902), was clearly derived from the Greeks of his own day. The medieval dependence on the authority of Aristotle gradually diminished. This was partly due to the recovery of some of the lost works of ancient literature, and the transition from the middle ages to the revival of learning was attended by a general widening of the range of classical studies and by a renewed interest in Plato.

The classical learning of the middle ages was largely second-hand. It was often derived from glossaries, from books of elegant extracts, or from comprehensive encyclopaedias. Among the compilers of these last were Isidore and Hrabanus, William of Conches and Honorius of Autun, Bartholomæus Anglicus (fl. 1250), Vincent of Beauvais (d. 1264), and, lastly, Brunetto Latini (d. 1290), the earlier contemporary of Dante. For Aristotle, as interpreted by Albertus Magnus and Thomas Aquinas, Dante has the highest regard. To the Latin transla-

tions of Aristotle and to his interpreters he refers in more than three hundred passages, while the number of his references to the Latin translation of the *Timaeus* of Plato is less than ten. His five great pagan poets are Homer, Virgil, Horace, Ovid, Lucan; Statius he regards as a "Christian" converted by Virgil's *Fourth Eclogue*. His standard authors in Latin prose are Cicero, Livy, Pliny, Frontinus and Orosius. His knowledge of Greek was practically nil. Latin was the language of his political treatise, *De Monarchia*, and even that of his defence of the vulgar tongue, *De Vulgari Eloquentia*. He is, in a limited sense, a precursor of the Renaissance, but he is far more truly to be regarded as the crowning representative of the spirit of the middle ages.

(iv.) *The Modern Age.*—(a) Our fourth period is ushered in by the age of the Revival of Learning in Italy (c. 1350-1527). Petrarch (1304-1374) has been well described as *Italy*, "the first of modern men." In contrast with the Schoolmen of the middle ages, he has no partiality for Aristotle. He was interested in Greek, and, a full century before the fall of Constantinople, he was in possession of MSS. of Homer and Plato, though his knowledge of the language was limited to the barest rudiments. For that knowledge, scanty as it was, he was indebted to Leontius Pilatus, with whose aid Boccaccio (1313-1375) became "the first of modern men" to study Greek to some purpose during the three years that Leontius spent as his guest in Florence (1360-1363). It was also at Florence that Greek was taught in the next generation by Chrysoloras (in 1396-1400). Another generation passed, and the scholars of the East and West met at the council of Florence (1439). One of the envoys of the Greeks, Gemistus Pletho, then inspired Cosimo dei Medici with the thought of founding an academy for the study of Plato. The academy was founded, and, in the age of Lorenzo, Plato and Plotinus were translated into Latin by Marsilio Ficino (d. 1499). The *Apology* and *Crito*, the *Phædo*, *Phaedrus* and *Gorgias* of Plato, as well as speeches of Demosthenes and Aeschines, with the *Oeconomicus*, *Ethics* and *Politics* of Aristotle, had already been translated by Leonardo Bruni (d. 1444); the *Rhetoric* by Filelfo (1430), and Plato's *Republic* by Decembrio (1439). A comprehensive scheme for translating the principal Greek prose authors into Latin was carried out at Rome by the founder of the manuscript collections of the Vatican, Nicholas V. (1447-1455), who had belonged to the literary circle of Cosimo at Florence. The translation of Aristotle was entrusted to three of the learned Greeks who had already arrived in Italy, Trapezuntius, Gaza and Bessarion, while other authors were undertaken by Italian scholars such as Guarino, Valla, Decembrio and Perotti. Among the scholars of Italian birth, probably the only one in this age who rivalled the Greeks as a public expositor of their own literature was Politian (1454-1494), who lectured on Homer and Aristotle in Florence, translated Herodian, and was specially interested in the Latin authors of the Silver Age and in the text of the *Pandects* of Justinian. It will be observed that the study of Greek had been resumed in Florence half a century before the fall of Constantinople, and that the principal writers of Greek prose had been translated into Latin before that event.

Meanwhile, the quest of MSS. of the Latin classics had been actively pursued. Petrarch had discovered Cicero's *Speech pro Archia* at Liège (1333) and the *Letters to Atticus* and *Quintus* at Verona (1345). Boccaccio had discovered Martial and Ausonius, and had been the first of the humanists to be familiar with Varro and Tacitus, while Salutati had recovered Cicero's letters *Ad Familiares* (1389). During the council of Constance, Poggio, the papal secretary, spent in the quest of MSS. the interval between May 1415 and November 1417, during which he was left at leisure by the vacancy in the apostolic see.

Thirteen of Cicero's speeches were found by him at Cluny and Langres, and elsewhere in France or Germany; the commentary of Asconius, a complete Quintilian, and a large part of Valerius Flaccus were discovered at St Gallen. A second expedition to that monastery and to others in the neighbourhood led to the recovery of Lucretius, Manilius, Silius, Italicus and Ammianus

Marcellinus, while the *Silvae* of Statius were recovered shortly afterwards. A complete MS. of Cicero, *De Oratore*, *Brutus* and *Orator*, was found by Bishop Landriani at Lodi (1421). Cornelius Nepos was discovered by Traversari in Padua (1434). The *Agricola*, *Germania* and *Dialogue* of Tacitus reached Italy from Germany in 1455, and the early books of the *Annals* in 1508. Pliny's *Panegyric* was discovered by Aurispa at Mainz (1433), and his correspondence with Trajan by Fra Giocondo in Paris about 1500.

Greek MSS. were brought from the East by Aurispa, who in 1423 returned with no less than two hundred and thirty-eight, including the celebrated Laurentian MS. of Aeschylus, Sophocles and Apollonius Rhodius. A smaller number was brought from Constantinople by Filicfo (1427), while Quintus Smyrnaeus was discovered in south Italy by Bessarion, who presented his own collection of MSS. to the republic of Venice and thus led to the foundation of the library of St Mark's (1468). As the emissary of Lorenzo, Janus Lascaris paid two visits to the East, returning from his second visit in 1492 with two hundred MSS. from Mount Athos.

The Renaissance theory of a humanistic education is illustrated by several treatises still extant. In 1392 Vergerio addressed to a prince of Padua the first treatise which methodically maintains the claims of Latin as an essential part of a liberal education. Eight years later, he was learning Greek from Chrysoloras. Among the most distinguished pupils of the latter was Leonardo Bruni, who, about 1405, wrote "the earliest humanistic tract on education expressly addressed to a lady." He here urges that the foundation of all true learning is a "sound and thorough knowledge of Latin," and draws up a course of reading, in which history is represented by Livy, Sallust, Curtius, and Caesar; oratory by Cicero; and poetry by Virgil. The same year saw the birth of Maffeo Vegio, whose early reverence for the muse of Virgil and whose later devotion to the memory of Monica have left their mark on the educational treatise which he wrote a few years before his death in 1458. The authors he recommends include "Aesop" and Sallust, the tragedies of Seneca and the epic poets, especially Virgil, whom he interprets in an allegorical sense. He is in favour of an early simultaneous study of a wide variety of subjects, to be followed later by the special study of one or two. Eight years before the death of Vegio, Aeneas Sylvius Piccolomini (Pius II.) had composed a brief treatise on education in the form of a letter to Ladislaus, the young king of Bohemia and Hungary. The Latin poets to be studied include Virgil, Lucan, Statius, Ovid's *Metamorphoses*, and (with certain limitations) Horace, Juvenal and Persius, as well as Plautus, Terence and the tragedies of Seneca; the prose authors recommended are Cicero, Livy and Sallust. The first great school of the Renaissance was that established by Vittorino da Feltre at Mantua, where he resided for the last twenty-two years of his life (1424-1446). Among the Latin authors studied were Virgil and Lucan, with selections from Horace, Ovid and Juvenal, besides Cicero and Quintilian, Sallust and Curtius, Caesar and Livy. The Greek authors were Homer, Hesiod, Pindar and the dramatists, with Herodotus, Xenophon and Plato, Isocrates and Demosthenes, Plutarch and Arrian.

Meanwhile, Guarino had been devoting five years to the training of the eldest son of the marquis of Ferrara. At Ferrara he spent the last thirty years of his long life (1370-1460), producing textbooks of Greek and Latin grammar, and translations from Strabo and Plutarch. His method may be gathered from his son's treatise, *De Ordine Docendi et Studendi*. In that treatise the essential marks of an educated person are, not only ability to write Latin verse, but also, a point of "at least equal importance," "familiarity with the language and literature of Greece." "Without a knowledge of Greek, Latin scholarship itself is, in any real sense, impossible" (1459).

By the fall of Constantinople in 1453, "Italy (in the eloquent phrase of Carducci) became sole heir and guardian of the ancient civilization," but its fall was in no way necessary for the revival of learning, which had begun a century before. Bessarion, Theodorus Gaza, Georgius Trepezuntius, Argyropulus, Chal-

condyles, all had reached Italy before 1453. A few more Greeks fled to Italy after that date, and among these were Janus Lascaris, Musurus and Callierges. All three were of signal service in devoting their knowledge of Greek to perpetuating and popularizing the Greek classics with the aid of the newly-invented art of printing. That art had been introduced into Italy by the German printers, Sweynheym and Pannartz, who had worked under Fust at Mainz. At Subiaco and at Rome they had produced in 1465-1471 the earliest editions of Cicero, *De Oratore* and the *Letters*, and eight other Latin authors.

The printing of Greek began at Milan with the Greek grammar of Constantine Lascaris (1476). At Florence the earliest editions of Homer (1488) and Isocrates (1493) had been produced by Demetrius Chalcondyles, while Janus Lascaris was the first to edit the Greek anthology, Apollonius Rhodius, and parts of Euripides, Callimachus and Lucian (1494-1496). In 1494-1515 Aldus Manutius published at Venice no less than twenty-seven *editiones principes* of Greek authors and of Greek works of reference, the authors including Aristotle, Theophrastus, Theocritus, Aristophanes, Thucydides, Sophocles, Herodotus, Euripides, Demosthenes (and the minor Attic orators), Pindar, Plato and Athenaeus. In producing Plato, Athenaeus and Aristophanes, the scholar-printer was largely aided by Musurus, who also edited the Aldine Pausanias (1516) and the *Etymologicum* printed in Venice by another Greek immigrant, Callierges (1499).

The Revival of Learning in Italy ends with the sack of Rome (1527). Before 1525 the study of Greek had begun to decline in Italy, but meanwhile an interest in that language had been transmitted to the lands beyond the Alps.

In the study of Latin the principal aim of the Italian humanists was the *imitation* of the style of their classical models. In the case of poetry, this imitative spirit is apparent in Petrarch's *Africa*, and in the Latin poems of Politian, Pontano, Sannazaro, Vida and many others. Petrarch was not only the imitator of Virgil, who had been the leading name in Latin letters throughout the middle ages; it was the influence of Petrarch that gave a new prominence to Cicero. The imitation of Cicero was carried on with varying degrees of success by humanists such as Gasparino da Barzizza (d. 1431), who introduced a new style of epistolary Latin; by Paolo Cortesi, who discovered the importance of a rhythmical structure in the composition of Ciceronian prose (1490); and by the accomplished secretaries of Leo X., Bembo and Sadoletto. Both of these papal secretaries were mentioned in complimentary terms by Erasmus in his celebrated dialogue, the *Ciceronianus* (1528), in which no less than one hundred and six Ciceronian scholars of all nations are briefly and brilliantly reviewed, the slavish imitation of Cicero denounced, and the law laid down that "to speak with propriety we must adapt ourselves to the age in which we live—an age that differs entirely from that of Cicero." One of the younger Ciceronians criticized by Erasmus was Longolius, who had died at Padua in 1522. The cause of the Ciceronians was defended by the elder Scaliger in 1531 and 1536, and by Étienne Dolet in 1535, and the controversy was continued by other scholars down to the year 1610. Meanwhile, in Italy, a strict type of Ciceronianism was represented by Paulus Manutius (d. 1574), and a freer and more original form of Latinity by Muretus (d. 1585).

Before touching on the salient points in the subsequent centuries, in connexion with the leading nations of Europe, we may briefly note the cosmopolitan position of Erasmus (1466-1536), who, although he was a native of the Netherlands, was far more closely connected with France, England, Italy, Germany and Switzerland, than with the land of his birth. He was still a school-boy at Deventer when his high promise was recognized by Rudolf Agricola, "the first (says Erasmus) who brought from Italy some breath of a better culture." Late in 1499 Erasmus spent some two months at Oxford, where he met Colet; it was in London that he met More and Linacre and Grocyn, who had already ceased to lecture at Oxford. At Paris, in 1500, he was fully conscious that "without Greek the amplest

knowledge of Latin was imperfect"; and, during his three years in Italy (1506-1509), he worked quietly at Greek in Bologna and attended the lectures of Musurus in Padua. In October 1511 he was teaching Greek to a little band of students in Cambridge; at Basel in 1516 he produced his edition of the Greek Testament, the first that was actually published; and during the next few years he was helping to organize the college lately founded at Louvain for the study of Greek and Hebrew, as well as Latin. Seven years at Basel were followed by five at Freiburg, and by two more at Basel, where he died. The names of all these places are suggestive of the wide range of his influence. By his published works, his *Colloquies*, his *Adages* and his *Apophthegms*, he was the educator of the nations of Europe. An educational aim is also apparent in his editions of Terence and of Seneca, while his Latin translations made his contemporaries more familiar with Greek poetry and prose, and his *Paraphrase* promoted a better understanding of the Greek Testament. He was not so much a scientific scholar as a keen and brilliant man of letters and a widely influential apostle of humanism.

In France the most effective of the early teachers of Greek was Janus Lascaris (1495-1503). Among his occasional pupils was Budaeus (d. 1540), who prompted Francis I. to found in 1530 the corporation of the Royal Readers in Greek, as well as Latin and Hebrew, afterwards famous under the name of the Collège de France. In the study of Greek one of the earliest links between Italy and Germany was Rudolf Agricola, who had learned Greek under Gaza at Ferrara. It was in Paris that his younger contemporary Reuchlin acquired part of that proficiency in Greek which attracted the notice of Argyropulus, whose admiration of Reuchlin is twice recorded by Melancthon, who soon afterwards was pre-eminent as the "praeceptor" of Germany.

In the age of the revival the first Englishman who studied Greek was a Benedictine monk, William of Selling (d. 1494), who paid two visits to Italy. At Canterbury he inspired with his own love of learning his nephew, Linacre, who joined him on one of those visits, studied Greek at Florence under Politian and Chalcondyles, and apparently stayed in Italy from 1485 to 1499. His translation of a treatise of Galen was printed at Cambridge in 1521 by Siberch, who, in the same year and place, was the first to use Greek type in England. Greek had been first taught to some purpose at Oxford by Grocyn on his return from Italy in 1491. One of the younger scholars of the day was William Lilye, who picked up his Greek at Rhodes on his way to Palestine and became the first high-master of the school founded by Colet at St Paul's (1510).

(b) That part of the *Modern Period* of classical studies which succeeds the age of the Revival in Italy may be subdivided into three periods distinguished by the names of the nations most prominent in each.

1. The first may be designated the *French period*. It begins with the foundation of the Royal Readers by Francis I. in 1530, and it may perhaps be regarded as extending to 1700. This period is marked by a many-sided erudition rather than by any special cult of the form of the classical languages. It is the period of the great polyhistorians of France. It includes Budaeus and the elder Scaliger (who settled in France in 1529), with Turnebus and Lambinus, and the learned printers Robertus and Henricus Stephanus, while among its foremost names are those of the younger (and greater) Scaliger, Casaubon and Salmasius. Of these, Casaubon ended his days in England (1614); Scaliger, by leaving France for the Netherlands in 1593, for a time at least transferred the supremacy in scholarship from the land of his birth to that of his adoption. The last sixteen years of his life (1593-1609) were spent at Leiden, which was also for more than twenty years (1631-1653) the home of Salmasius, and for thirteen (1579-1592) that of Lipsius (d. 1606). In the 17th century the erudition of France is best represented by "Henricus Valesius," Du Cange and Mabillon. In the same period Italy was represented by Muretus, who

had left France in 1563, and by her own sons, Nizolius, Victorius, Robortelli and Sigonius, followed in the 17th century by R. Fabretti. The Netherlands, in the 16th, claim W. Canter as well as Lipsius, and, in the 17th, G. J. Vossius, Johannes Meursius, the elder and younger Heinsius, Hugo Grotius, J. F. Gronovius, J. G. Graevius and J. Perizonius. Scotland, in the 16th, is represented by George Buchanan; England by Sir John Cheke, Roger Ascham, and Sir Henry Savile, and, in the 17th, by Thomas Gataker, Thomas Stanley, Henry Dodwell, and Joshua Barnes; Germany by Janus Gruter, Ezechiel Spanheim and Chr. Cellarius, the first two of whom were also connected with other countries.

We have already seen that a strict imitation of Cicero was one of the characteristics of the Italian humanists. In and after the middle of the 16th century a correct and pure Latinity was promoted by the educational system of the Jesuits; but with the growth of the vernacular literatures Latin became more and more exclusively the language of the learned. Among the most conspicuous Latin writers of the 17th century are G. J. Vossius and the Heinsii, with Salmasius and his great adversary, Milton. Latin was also used in works on science and philosophy, such as Sir Isaac Newton's *Principia* (1687), and many of the works of Leibnitz (1646-1705). In botany the custom followed by John Ray (1627-1705) in his *Historia Plantarum* and in other works was continued in 1760 by Linnaeus in his *Systema Naturae*. The last important work in English theology written in Latin was George Bull's *Defensio Fidei Nicenae* (1685). The use of Latin in diplomacy died out towards the end of the 17th century; but, long after that date negotiations with the German empire were conducted in Latin, and Latin was the language of the debates in the Hungarian diet down to 1825.

2. During the 18th century the classical scholarship of the Netherlands was under the healthy and stimulating influence of Bentley (1662-1742), who marks the beginning of the English and Dutch period, mainly represented in Holland by Bentley's younger contemporary and correspondent, Tiberius Hemsterhuys (1685-1766), and the latter scholar's great pupil David Ruhnken (1723-1798). It is the age of historical and literary, as well as verbal, criticism. Both of these were ably represented in the first half of the century by Bentley himself, while, in the twenty years between 1782 and 1803, the verbal criticism of the tragic poets of Athens was the peculiar province of Richard Porson (1759-1808), who was born in the same year as F. A. Wolf. Among other representatives of England were Jeremiah Markland and Jonathan Toup, Thomas Tyrwhitt and Thomas Twining, Samuel Parr and Sir William Jones; and of the Netherlands, the two Burmanns and L. Küster, Arnold Drakenborch and Wesseling, Lodewyk Valckenaeer and Daniel Wytenbach (1746-1829). Germany is represented by Fabricius and J. M. Gesner, J. A. Ernesti and J. J. Reiske, J. J. Winckelmann and Chr. G. Heyne; France by B. de Montfaucon and J. B. G. D. Villoison; Alsace by French subjects of German origin, R. F. P. Brunck and J. Schweighäuser; and Italy by E. Forcellini and Ed. Corsini.

3. The *German period* begins with F. A. Wolf (1759-1824), whose *Prolegomena* to Homer appeared in 1795. He is the founder of the systematic and encyclopaedic type of scholarship embodied in the comprehensive term *Altertumswissenschaft*, or "a scientific knowledge of the old classical world." The tradition of Wolf was ably continued by August Böckh (d. 1867), one of the leaders of the historical and antiquarian school, brilliantly represented in the previous generation by B. G. Niebuhr (d. 1831).

In contrast with this school we have the critical and grammatical school of Gottfried Hermann (d. 1848). During this period, while Germany remains the most productive of the nations, scholarship has been more and more international and cosmopolitan in its character.

19th Century.—We must here be content with simply recording the names of a few of the more prominent representatives of

Literary
Latin.

The
English
and Dutch
period.

The French
period.

The
German
period.

the 19th century in some of the most obvious departments of classical learning. Among natives of Germany the leading scholars have been, in *Greek*, C. F. W. Jacobs, C. A. **Germany.** Lobeck, L. Dissen, I. Bekker, A. Meineke, C. Lehrs, W. Dindorf, T. Bergk, F. W. Schneidewin, H. Köchly, A. Nauck, H. Usener, G. Kaibel, F. Blass and W. Christ; in *Latin*, C. Lachmann, F. Ritschl, M. Haupt, C. Halm, M. Hertz, A. Fleck-eisen, E. Bährens, L. Müller and O. Ribbeck. *Grammar* and kindred subjects have been represented by P. Buttmann, A. Matthiae, F. W. Thiersch, C. G. Zumpt, G. Bernhardt, C. W. Krüger, R. Kühner and H. L. Ahrens; and *lexicography* by F. Passow and C. E. Georges. Among editors of *Thucydides* we have had F. F. Poppo and J. Classen; among editors of *Demosthenes or other orators*, G. H. Schäfer, J. T. Vömel, G. E. Benseler, A. Westermann, G. F. Schömann, H. Sauppe, and C. Rehdantz (besides Blass, already mentioned). The *Platonists* include F. Schleiermacher, G. A. F. Ast, G. Stallbaum and the many-sided C. F. Hermann; the *Aristotelians*, C. A. Brandis, A. Trendelenburg, L. Spengel, H. Bonitz, C. Prantl, J. Bernays and F. Susemihl. The history of *Greek philosophy* was written by F. Ueberweg, and, more fully, by E. Zeller. *Greek history* was the domain of G. Droysen, Max Duncker, Ernst Curtius, Arnold Schäfer and Adolf Holm; *Greek antiquities* that of M. H. Meier and G. F. Schömann and of G. Gilbert; *Greek epigraphy* that of J. Franz, A. Kirchhoff, W. von Hartel, U. Köhler, G. Hirschfeld and W. Dittenberger; *Roman history and constitutional antiquities* that of Theodor Mommsen (1817-1903), who was associated in *Latin epigraphy* with E. Hübner and W. Henzen. *Classical art and archaeology* were represented by F. G. Welcker, E. Gerhard, C. O. Müller, F. Wieseler, O. Jahn, C. L. Ulrichs, H. Brunn, C. B. Stark, J. Overbeck, W. Helbig, O. Benndorf and A. Furtwängler; *mythology* (with cognate subjects) by G. F. Creuzer, P. W. Forchhammer, L. Preller, A. Kuhn, J. W. Mannhardt and E. Rohde; and *comparative philology* by F. Bopp, A. F. Pott, T. Benfey, W. Corssen, Georg Curtius, A. Schleicher and H. Steinthal. The history of *classical philology* in Germany was written by Conrad Bursian (1830-1883).

In France we have J. F. Boissonade, J. A. Letronne, L. M. Quicherat, M. P. Littré, B. Saint-Hilaire, J. V. Duruy, B. E. Miller, É. Egger, C. V. Daremberg, C. Thurot, L. E. Benoist, O. Riemann and C. Graux; (in archaeology) A. C. Quatremère de Quincy, P. le Bas, C. F. M. Texier, the duc de Luynes, the Lenormants (C. and F.), W. H. Waddington and O. Rayet; and (in comparative philology) Victor **France.** Henry. Greece was ably represented in France by A. Koraes. In Belgium we have P. Willems and the Baron De Witte (long resident in France); in Holland, C. G. Cobet; in Denmark, J. N. Madvig. Among the scholars of Great Britain and Ireland may be mentioned: **England.** P. Elmsley, S. Butler, T. Gaisford, P. P. Dobree, J. H. Monk, C. J. Blomfield, W. Veitch, T. H. Key, B. H. Kennedy, W. Ramsay, T. W. Peile, R. Shilleto, W. H. Thompson, J. W. Donaldson, Robert Scott, H. G. Liddell, C. Badham, G. Rawlinson, F. A. Paley, B. Jowett, T. S. Evans, E. M. Cope, H. A. J. Munro, W. G. Clark, Churchill Babington, H. A. Holden, J. Riddell, J. Conington, W. Y. Sellar, A. Grant, W. D. Geddes, D. B. Monro, H. Nettleship, A. Palmer, R. C. Jebb, A. S. Wilkins, W. G. Rutherford and James Adam; among historians and archaeologists, W. M. Leake, H. Fynes-Clinton, G. Grote and C. Thirlwall, T. Arnold, G. Long and Charles Merivale, Sir Henry Maine, Sir Charles Newton and A. S. Murray, Robert Burn and H. F. Pelham. Among comparative philologists Max Müller belonged to Germany by birth and to England by adoption, while, in the United States, his ablest counterpart was W. D. Whitney. B. L. Gildersleeve, W. W. Goodwin, Henry Drisler, J. B. Greenough and G. M. Lane were prominent American classical scholars.

The 19th century in Germany was marked by the organization of the great series of Greek and Latin inscriptions, and by the foundation of the Archaeological Institute in Rome (1829), which was at first international in its character. The Athenian

Institute was founded in 1874. Schools at Athens and Rome were founded by France in 1846 and 1873, by the United States of America in 1882 and 1895, and by England in 1883 and 1901; and periodicals are published by the schools of all these four nations. An interest in Greek studies (and especially **Schools of Rome and Athens.** in art and archaeology) has been maintained in England by the Hellenic Society, founded in 1879, with its organ the *Journal of Hellenic Studies*. A further interest in Greek archaeology has been awakened in all civilized lands by the excavations of Troy, Mycenae, Tiryns, Epidaurus, Sparta, Olympia, Dodona, Delphi, Delos and of important sites in Crete. The extensive discoveries of papyri in Egypt have greatly extended our knowledge of the administration of that country in the times of the Ptolemics, and have materially added to the existing remains of Greek literature. Scholars have been enabled to realize in their own experience some of the enthusiasm that attended the recovery of lost classics during the Revival of Learning. They have found themselves living in a new age of *editiones principes*, and have eagerly welcomed the first publication of Aristotle's *Constitution of Athens* (1891), Herondas (1891) and Bacchylides (1897), as well as the *Persae* of Timotheus of Miletus (1903), with some of the *Poems* of Pindar (1907) and large portions of the plays of Menander (1898-1899 and 1907). The first four of these were first edited by F. G. Kenyon, Timotheus by von Wilamowitz-Möllendorff, Menander partly by J. Nicole and G. Lefebvre and partly by B. P. Grenfell and A. S. Hunt, who have also produced fragments of the *Poems* of Pindar and many other classic texts (including a Greek continuation of Thucydides and a Latin epitome of part of Livy) in the successive volumes of the *Oxyrhynchus papyri* and other kindred publications.

AUTHORITIES.—For a full bibliography of the history of classical philology, see E. Hübner, *Grundriss zu Vorlesungen über die Geschichte und Encyclopädie der klassischen Philologie* (2nd ed., 1889); and for a brief outline, C. L. Ulrichs in Iwan von Müller's *Handbuch*, vol. i. (2nd ed., 1891), 33-145; S. Reinach, *Manuel de philologie classique* (2nd ed., 1883-1884; *nouveau tirage* 1907), 1-22; and A. Gudemann, *Grundriss* (Leipzig, 1907), pp. 224 seq. For the Alexandrian period, F. Susemihl, *Gesch. der griechischen Litteratur in der Alexandrinerzeit* (2 vols., 1891-1892); cf. F. A. Eckstein, *Nomenclator Philologorum* (1871), and W. Pöckl, *Philologisches Schriftsteller-Lexikon* (1882). For the period ending A.D. 400, see A. Gräfenhan, *Gesch. der klass. Philologie* (4 vols., 1843-1850); for the Byzantine period, C. Krumbacher in Iwan von Müller, vol. ix. (1) (2nd ed., 1897); for the Renaissance, G. Voigt, *Die Wiederbelebung des class. Altertums* (3rd ed., 1894, with bibliography); L. Geiger, *Renaissance und Humanismus in Italien und Deutschland* (1882, with bibliography); J. A. Symonds, *Revival of Learning* (1877, &c.); R. C. Jebb, in *Cambridge Modern History*, i. (1902), 532-584; and J. E. Sandys, *Harvard Lectures on the Revival of Learning* (1905); also P. de Nolhac, *Pétrarque et l'humanisme* (2nd ed., 1907). On the history of Greek scholarship in France, E. Egger, *L'Histoire d'hellénisme en France* (1869); Mark Pattison, *Essays*, i., and *Life of Casaubon*; in Germany, C. Bursian, *Gesch. der class. Philologie in Deutschland* (1883); in Holland, L. Müller, *Gesch. der class. Philologie in den Niederlanden* (1869); in Belgium, L. C. Roersch in E. P. van Bommel's *Patria Belgica*, vol. iii. (1875), 407-432; and in England, R. C. Jebb, "Erasmus" (1890) and "Bentley" (1882), and "Porson" (in *Dict. Nat. Biog.*). On the subject as a whole see J. E. Sandys, *History of Classical Scholarship* (with chronological tables, portraits and facsimiles), vol. i.; *From the Sixth Century B.C. to the end of the Middle Ages* (1903, 2nd ed., 1906); vols. ii. and iii., *From the Revival of Learning to the Present Day* (1908), including the history of scholarship in all the countries of Europe and in the United States of America. See also the separate biographical articles in this Encyclopaedia.

(B) THE STUDY OF THE CLASSICS IN SECONDARY EDUCATION

After the Revival of Learning the study of the classics owed much to the influence and example of Vittorino da Feltre, Budaeus, Erasmus and Melanchthon, who were among the leading representatives of that revival in Italy, France, England and Germany.

1. In *England*, the two great schools of Winchester (1382) and Eton (1440) had been founded during the life of Vittorino, but before the revival had reached Britain. The first **England.** school¹ which came into being under the immediate influence of humanism was that founded at St Paul's by Dean

¹ See also the article SCHOOLS.

Colet (1510), the friend of Erasmus, whose treatise *De pueris instituendis* (1529) has its English counterpart in the *Governor* of Sir Thomas Elyot (1531). The highmaster of St Paul's was to be "learned in good and clean Latin, and also in Greek, if such may be gotten." The master and the second master of Shrewsbury (founded 1551) were to be "well able to make a Latin verse, and learned in the Greek tongue." The influence of the revival extended to many other schools, such as Christ's Hospital (1552), Westminster (1560), and Merchant Taylors' (1561); Repton (1557), Rugby (1567) and Harrow (1571).

At the grammar school of Stratford-on-Avon, about 1571-1577, Shakespeare presumably studied Terence, Horace, Ovid and the *Bucolics* of Baptista Mantuanus (1502). In the early plays he quotes Ovid and Seneca. Similarly, in *Titus Andronicus* (iv. 2) he says, of *Integer vitae*: "'Tis a verse in Horace; I know it well: I read it in the grammar long ago." In *Henry VI.* part ii. sc. 7, when Jack Cade charges Lord Say with having "most traitorously corrupted the youth of the realm in erecting a grammar-school," Lord Say replies that "ignorance is the curse of God, knowledge the wing wherewith we fly to heaven." In the *Taming of the Shrew* (I. i. 157) a line is quoted as from Terence (*Andria*, 74): "*redime te captum quam queas minimo*." This is taken *verbatim* from Lilye's contribution to the *Brevis Institutio*, originally composed by Colet, Erasmus and Lilye for St Paul's School (1527), and ultimately adopted as the *Eton Latin Grammar*. The *Westminster Greek Grammar* of Grant (1575) was succeeded by that of Camden (1595), founded mainly on a Paduan text-book, and apparently adopted in 1596 by Sir Henry Savile at Eton, where it long remained in use as the *Eton Greek Grammar*, while at Westminster itself it was superseded by that of Busby (1663). The text-books to be used at Harrow in 1590 included Hesiod and some of the Greek orators and historians.

In one of the *Paston Letters* (i. 301), an Eton boy of 1458 quotes two Latin verses of his own composition. Nearly a century later, on New Year's Day, 1560, forty-four boys of the school presented Latin verses to Queen Elizabeth. The queen's former tutor, Roger Ascham, in his *Scholemaster* (1570), agrees with his Strassburg friend, J. Sturm, in making the imitation of the Latin classics the main aim of instruction. He is more original when he insists on the value of translation and retranslation for acquiring a mastery over Latin prose composition, and when he protests against compelling boys to converse in Latin too soon. Ascham's influence is apparent in the *Positions* of Mulcaster, who in 1581 insists on instruction in English before admission to a grammar-school, while he is distinctly in advance of his age in urging the foundation of a special college for the training of teachers.

Cleland's *Institution of a Young Nobleman* (1607) owes much to the Italian humanists. The author follows Ascham in protesting against compulsory Latin conversation, and only slightly modifies his predecessor's method of teaching Latin prose. When Latin grammar has been mastered, he bids the teacher lead his pupil "into the sweet fountain and spring of all Arts and Science," that is, Greek learning which is "as profitable for the understanding as the Latin tongue for speaking." In the study of ancient history, "deeds and not words" are the prime interest. "In Plutarch pleasure is so mixed and confounded with profit, that I esteem the reading of him as a paradise for a curious spirit to walk in at all time." Bacon in his *Advancement of Learning* (1605) notes it as "the first distemper of learning when men study words and not matter" (I. iv. 3); he also observes that the Jesuits "have much quickened and strengthened the state of learning" (I. vi. 15). He is on the side of reform in education; he waves the humanist aside with the words: *velustas cessit, ratio vicil*. Milton, in his *Tractate on Education* (1644), advances further on Bacon's lines, protesting against the length of time spent on instruction in language, denouncing merely verbal knowledge, and recommending the study of a large number of classical authors for the sake of their subject-

matter, and with a view to their bearing on practical life. His ideal place of education is an institution combining a school and a university. Sir William Petty, the economist (1623-1687), urged the establishment of *ergastula literaria* for instruction of a purely practical kind. Locke, who had been educated at Winchester and had lectured on Greek at Oxford (1660), nevertheless almost completely eliminated Greek from the scheme which he unfolded in his *Thoughts on Education* (1693). With Locke, the moral and practical qualities of virtue and prudence are of the first consideration. Instruction, he declares, is but the least part of education; his aim is to train, not men of letters or men of science, but practical men armed for the battle of life. Latin was, above all, to be learned through use, with as little grammar as possible, but with the reading of easy Latin texts, and with no repetition, no composition. Greek he absolutely proscribes, reserving a knowledge of that language to the learned and the lettered, and to professional scholars.

Throughout the 18th century and the early part of the 19th, the old routine went on in England with little variety, and with no sign of expansion. The range of studies was widened, however, at Rugby in 1828-1842 by Thomas Arnold, whose interest in ancient history and geography, as a necessary part of classical learning, is attested by his edition of Thucydides; while his influence was still further extended when those who had been trained in his traditions became head masters of other schools.

During the rest of the century the leading landmarks are the three royal commissions known by the names of their chairmen: (1) Lord Clarendon's on nine public schools, Eton, Winchester, Westminster, Charterhouse, Harrow, Rugby, Shrewsbury, St Paul's and Merchant Taylors' (1861-1864), resulting in the Public Schools Act of 1868; (2) Lord Taunton's on 782 endowed schools (1864-1867), followed by the act of 1869; and (3) Mr Bryce's on secondary education (1894-1895).

A certain discontent with the current traditions of classical training found expression in the *Essays on a Liberal Education* (1867). The author of the first essay, C. S. Parker, closed his review of the reforms instituted in Germany and France by adding that in England there had been but little change. The same volume included a critical examination of the "Theory of Classical Education" by Henry Sidgwick, and an attack on compulsory Greek and Latin verse composition by F. W. Farrar. The claims of verse composition have since been judiciously defended by the Hon. Edward Lyttelton (1897), while a temperate and effective restatement of the case for the classics may be found in Sir Richard Jebb's Romanes Lecture on "Humanism in Education" (1899).

The question of the position of Greek in secondary education has from time to time attracted attention in connexion with the requirement of Greek in Responsions at Oxford, and in the Previous Examination at Cambridge.

In the *Cambridge University Reporter* for November 9, 1870, it was stated that, "in order to provide adequate encouragement for the study of Modern Languages and Natural Science," the commissioners for endowed schools had determined on the establishment of modern schools of the first grade in which Greek would be excluded. The commissioners feared that, so long as Greek was a *sine qua non* at the universities, these schools would be cut off from direct connexion with the universities, while the universities would in some degree lose their control over a portion of the higher culture of the nation. On the 9th of March 1871 a syndicate recommended that, in the Previous Examination, French and German (taken together) should be allowed in place of Greek; on the 27th of April this recommendation (which only affected candidates for honours or for medical degrees) was rejected by 51 votes to 48.

All the other proposals and votes relating to Greek in the Previous Examination in 1870-1873, 1878-1880, and 1891-1892 are set forth in the *Cambridge University Reporter* for November 11, 1904, pp. 202-205. In November 1903 a syndicate was

Shakespeare and the grammar-school.

Early text-books.

Ascham.

Cleland.

Bacon, Milton, Petty.

Locke.

Arnold.

Controversy on classical education.

"Compulsory Greek."

appointed to consider the studies and examinations of the university, their report of November 1904 on the Previous Examination was fully discussed, and the speeches published in the *Reporter* for December 17, 1904. In the course of the discussion Sir Richard Jebb drew attention to the statistics collected by the master of Emmanuel, Mr W. Chawner, showing that, out of 86 head masters belonging to the Head Masters' Conference whose replies had been published, "about 56 held the opinion that the exemption from Greek for all candidates for a degree would endanger or altogether extinguish the study of Greek in the vast majority of schools, while about 21 head masters held a different opinion." On the 3rd of March 1905 a proposal for accepting either French or German as an alternative for either Latin or Greek in the Previous Examination was rejected by 1559 to 1052 votes, and on the 26th of May 1906 proposals distinguishing between students in letters and students in science, and (*inter alia*) requiring the latter to take either French or German for either Latin or Greek in the Previous Examination, were rejected by 746 to 241.

Meanwhile, at Oxford a proposal practically making Greek optional with all undergraduates was rejected, in November 1902, by 189 votes to 166; a preliminary proposal permitting students of mathematics or natural science to offer one or more modern languages in lieu of Greek was passed by 164 to 162 in February 1904, but on the 29th of November the draft of a statute to this effect was thrown out by 200 to 164. In the course of the controversy three presidents of the Royal Society, Lord Kelvin, Lord Lister and Sir W. Huggins, expressed the opinion that the proposed exemption was not beneficial to science students.

Incidentally, the question of "compulsory Greek" has stimulated a desire for greater efficiency in classical teaching. In

December 1903, a year before the most important of the public discussions at Cambridge, the Classical Association was founded in London. The aim of that association is "to promote the development, and maintain the well-being, of classical studies, and in particular (a) to impress upon public opinion the claim of such studies to an eminent place in the national scheme of education; (b) to improve the practice of classical teaching by free discussion of its scope and methods; (c) to encourage investigation and call attention to new discoveries; (d) to create opportunities of friendly intercourse and co-operation between all lovers of classical learning in this country."

The question of the curriculum and the time-table in secondary education has occupied the attention of the Classical Association, the British Association and the Education Department of Scotland. The general effect of the recommendations already made would be to begin the study of foreign languages with French, and to postpone the study of Latin to the age of twelve and that of Greek to the age of thirteen. At the Head Masters' Conference of December 1907 a proposal to lower the standard of Greek in the entrance scholarship examinations of public schools was lost by 10 votes to 16, and the "British Association report" was adopted with reservations in 1908. In the case of secondary schools in receipt of grants of public money (about 700 in England and 100 in Wales in 1907-1908), "the curriculum and time-table must be approved by the Board of Education." The Board has also a certain control over the curriculum of schools under the Endowed Schools Acts and the Charitable Trusts Acts, and also over that of schools voluntarily applying for inspection with a view to being recognized as efficient.

Further efficiency in classical education has been the aim of the movement in favour of the reform of Latin pronunciation. In

1871 this movement resulted in Munro and Palmer's *Reform in Latin Syllabus of Latin Pronunciation*. The reform was carried forward at University College, London, by Professor Key and by Professor Robinson Ellis in 1873, and was accepted at Shrewsbury, Marlborough, Liverpool College, Christ's Hospital, Dulwich, and the City of London school. It was taken up anew by the Cambridge Philological Society in 1886, by the Modern Languages Association in 1901, by

the Classical Association in 1904-1905, and the Philological Societies of Oxford and Cambridge in 1906. The reform was accepted by the various bodies of head masters and assistant masters in December 1906-January 1907, and the proposed scheme was formally approved by the Board of Education in February 1907.

See W. H. Woodward, *Studies in Education during the Age of the Renaissance* (1906), chap. xiii.; Acland and Llewellyn Smith, *Studies in Secondary Education*, with introduction by James Bryce (1892); *Essays on a Liberal Education*, ed. F. W. Farrar (1867); R. C. Jebb, "Humanism in Education," Romanes Lecture of 1899, reprinted with other lectures on cognate subjects in *Essays and Addresses* (1907); Foster Watson, *The Curriculum and Practice of the English Grammar Schools up to 1660* (1908); "Greek at Oxford," by a Resident, in *The Times* (December 27, 1904); *Cambridge University Reporter* (November 11 and December 17, 1904); *British Association Report on Curricula of Secondary Schools* (with an independent paper by Professor Armstrong on "The Teaching of Classics"). (December 1907); W. H. D. Rouse in *The Year's Work in Classical Studies* (1907 and 1908), chap. i.; J. P. Postgate, *How to pronounce Latin* (Appendix B, on "Recent Progress"), (1907). For further bibliographical details see pp. 875-890 of Dr Karl Breuf's "Grossbritannien" in Baumeister's *Handbuch*, I. ii. 737-892 (Munich, 1897).

2. In France it was mainly with a view to promoting the study of Greek that the corporation of Royal Readers was founded by Francis I. in 1530 at the prompting of Budaeus. In the university of Paris, which was originally opposed to this innovation, the statutes of 1598 prescribed the study of Homer, Hesiod, Pindar, Theocritus, Plato, Demosthenes and Isocrates (as well as the principal Latin classics), and required the production of three exercises in Greek or Latin in each week.

From the middle of the 16th century the elements of Latin were generally learned from unattractive abridgments of the grammar of the Flemish scholar, van Pauteren or Despautère (d. 1520), which, in its original folio editions of 1537-1538, was an excellent work. The unhappy lot of those who were compelled to learn their Latin from the current abridgments was lamented by a Port-Royalist in a striking passage describing the gloomy forest of *le pays de Despaùère* (Guyot, quoted in Sainte-Beuve's *Port-Royal*, iii. 429). The first Latin grammar written in French was that of Père de Condren of the *Oratoire* (c. 1642), which was followed by the Port-Royal *Méthode latine* of Claude Lancelot (1644), and by the grammar composed by Bossuet for the dauphin, and also used by Fénelon for the instruction of the duc de Bourgogne. In the second half of the 17th century the rules of grammar and rhetoric were simplified, and the time withdrawn from the practice of composition (especially verse composition) transferred to the explanation and the study of authors.

Richelieu, in 1640, formed a scheme for a college in which Latin was to have a subordinate place, while room was to be found for the study of history and science, Greek, and French and modern languages. Bossuet, in educating the dauphin, added to the ordinary classical routine represented by the extensive series of the "Delphin Classics" the study of history and of science. A greater originality in the method of teaching the ancient languages was exemplified by Fénelon, whose views were partially reflected by the Abbé Fleury, who also desired the simplification of grammar, the diminution of composition, and even the suppression of Latin verse. Of the ordinary teaching of Greek in his day, Fleury wittily observed that most boys "learned just enough of that language to have a pretext for saying for the rest of their lives that Greek was a subject easily forgotten."

In the 18th century Rollin, in his *Traité des études* (1726), agreed with the Port-Royalists in demanding that Latin grammars should be written in French, that the rules should be simplified and explained by a sufficient number of examples, and that a more important place should be assigned to translation than to composition. The supremacy of Latin was the subject of a long series of attacks in the same century. Even at the close of the previous century the brilliant achievements of French literature had prompted La Bruyère

France.

Text-books.

Richelieu, Bossuet, Fénelon, Fleury.

Rollin.

to declare in *Des ouvrages de l'esprit* (about 1680), "We have at last thrown off the yoke of *Latinism*"; and, in the same year, Jacques Spon claimed in his correspondence the right to use the French language in discussing points of archaeology.

Meanwhile, in 1563, notwithstanding the opposition of the university of Paris, the Jesuits had succeeded in founding the *Collegium Claromontanum*. After the accession of Henry IV. they were expelled from Paris and other important towns in 1594, and not allowed to return until 1609, when they found themselves confronted once more by their rival, the university of Paris. They opened the doors of their schools to the Greek and Latin classics, but they represented the ancient masterpieces dis severed from their original historic environment, as impersonal models of taste, as isolated standards of style. They did much, however, for the cultivation of original composition modelled on Cicero and Virgil. They have been charged with paying an exaggerated attention to form, and with neglecting the subject-matter of the classics. This neglect is attributed to their anxiety to avoid the "pagan" element in the ancient literature. Intensely conservative in their methods, they kept up the system of using Latin in their grammars (and in their oral instruction) long after it had been abandoned by others.

The use of French for these purposes was a characteristic of the "Little Schools" of the Jansenists of Port-Royal (1643-1660).

The text-books prepared for them by Lancelot included not only the above-mentioned Latin grammar (1644) but also the *Méthode grecque* of 1655 and the *Jardin des racines grecques* (1657), which remained in use for two centuries and largely superseded the grammar of Clenardus (1636) and the *Tirocinium* of Père Labbe (1648). Greek began to decline in the university about 1650, at the very time when the Port-Royalists were aiming at its revival. During the brief existence of their schools their most celebrated pupils were Tillemont and Racine.

The Jesuits, on the other hand, claimed Corneille and Molière, as well as Descartes and Bossuet, Fontenelle, Montesquieu and Voltaire. Of their Latin poets the best-known were Denis Petau (d. 1652), René Rapin (d. 1687) and N. E. Sanadon (d. 1733). In 1762 the Jesuits were suppressed, and more than one hundred schools were thus deprived of their teachers. The university of Paris, which had prompted their suppression, and the parliament, which had carried it into effect, made every endeavour to replace them. The university took possession of the *Collegium Claromontanum*, then known as the *Collège Louis-le-Grand*, and transformed it into an *école normale*. Many of the Jesuit schools were transferred to the congregations of the *Oratoire* and the Benedictines, and to the secular clergy. On the eve of the Revolution, out of a grand total of 562 classical schools, 384 were in the hands of the clergy and 178 in those of the congregations.

The expulsion of the Jesuits gave a new impulse to the attacks directed against all schemes of education in which Latin held a prominent position. At the moment when the university of Paris was, by the absence of its rivals, placed in complete control of the education of France, she found herself driven to defend the principles of classical education against a crowd of assailants. All kinds of devices were suggested for expediting the acquisition of Latin; grammar was to be set aside; Latin was to be learned as a "living language"; much attention was to be devoted to acquiring an extensive vocabulary; and, "to save time," composition was to be abolished. To facilitate the reading of Latin texts, the favourite method was the use of interlinear translations, originally proposed by Locke, first popularized in France by Dumarsais (1722), and in constant vogue down to the time of the Revolution.

Early in the 18th century Rollin pleaded for the "utility of Greek," while he described that language as the heritage of the university of Paris. In 1753 Berthier feared that in thirty years no one would be able to read Greek. In 1768 Rolland declared that the university, which held Greek in high honour,

nevertheless had reason to lament that her students learnt little of the language, and he traced this decline to the fact that attendance at lectures had ceased to be compulsory. Greek, however, was still recognized as part of the examination held for the appointment of schoolmasters.

During the 18th century, in Greek as well as in Latin, the general aim was to reach the goal as rapidly as possible, even at the risk of missing it altogether. On the eve of the Revolution, France was enjoying the study of the institutions of Greece in the attractive pages of the *Voyage du jeune Anacharsis* (1789), but the study of Greek was menaced even more than that of Latin. For fifty years before the Revolution there was a distinct dissatisfaction with the routine of the schools. To meet that dissatisfaction, the teachers had accepted new subjects of study, had improved their methods, and had simplified the learning of the dead languages. But even this was not enough. In the study of the classics, as in other spheres, it was revolution rather than evolution that was loudly demanded.

The Revolution was soon followed by the long-continued battle of the "Programmes." Under the First Republic the schemes of Condorcet (April 1792) and J. Lakanal (February 1795) were superseded by that of P. C. F. Daunou (October 1795), which divided the pupils of the "central schools" into three groups, according to age, with corresponding subjects of study: (1) twelve to fourteen,—drawing, natural history, Greek and Latin, and a choice of modern languages; (2) fourteen to sixteen,—mathematics, physics, chemistry; (3) over sixteen,—general grammar, literature, history and constitutional law.

In July 1801, under the consulate, there were two courses, (1) nine to twelve,—elementary knowledge, including elements of Latin; (2) above twelve,—a higher course, with two alternatives, "humanistic" studies for the "civil," and purely practical studies for the "military" section. The law of the 1st of May 1802 brought the *lycées* into existence, the subjects being, in Napoleon's own phrase, "mainly Latin and mathematics."

At the Restoration (1814) the military discipline of the *lycées* was replaced by the ecclesiastical discipline of the "Royal Colleges." The reaction of 1815-1821 in favour of classics was followed by the more liberal programme of Vatimesnil (1829), including, for those who had no taste for a classical education, certain "special courses" (1830), which were the germ of the *enseignement spécial* and the *enseignement moderne*.

Under Louis Philippe (1830-1848), amid all varieties of administration there was a consistent desire to hold the balance fairly between all the conflicting subjects of study. After the revolution of 1848 the difficulties raised by the excessive number of subjects were solved by H. N. H. Fortoul's expedient of "bifurcation," the alternatives being letters and science. In 1863, under Napoleon III., Victor Duruy encouraged the study of history, and also did much for classical learning by founding the *École des Hautes Études*. In 1872, under the Third Republic, Jules Simon found time for hygiene, geography and modern languages by abolishing Latin verse composition and reducing the number of exercises in Latin prose, while he insisted on the importance of studying the inner meaning of the ancient classics. The same principles were carried out by Jules Ferry (1880) and Paul Bert (1881-1882). In the scheme of 1890 the Latin course of six years began with ten hours a week and ended with four; Greek was begun a year later with two hours, increasing to six and ending with four.

The commission of 1899, under the able chairmanship of M. Alexandre Ribot, published an important report, which was followed in 1902 by the scheme of M. Georges Leygues. The preamble includes a striking tribute to the advantages that France had derived from the study of the classics:—

"L'étude de l'antiquité grecque et latine a donné au génie français une mesure, une clarté et une élégance incomparables. C'est par elle que notre philosophie, nos lettres et nos arts ont brillé d'un si

**The
Jesuits.**

**Port-
Royal.**

**Classical
education
attacked.**

**Eve of the
Revolution.**

**First
Republic.**

Consulate.

**Restora-
tion.**

**Third
Republic.**

vif éclat; c'est par elle que notre influence morale s'est exercée en souveraine dans le monde. Les humanités doivent être protégées contre toute atteinte et fortifiées. Elles font partie du patrimoine national.

"L'esprit classique n'est pas . . . incompatible avec l'esprit moderne. Il est de tous les temps, parce qu'il est le culte de la raison claire et libre, la recherche de la beauté harmonieuse et simple dans toutes les manifestations de la pensée."

By the scheme introduced in these memorable terms the course of seven years is divided into two cycles, the first cycle (of four years) having two parallel courses: (1) without Greek or Latin, and (2) with Latin, and with optional Greek at the beginning of the third year. In the second cycle (of three years) those who have been learning both Greek and Latin, and those who have been learning neither, continue on the same lines as before; while those who have been learning Latin only may either (1) discontinue it in favour of modern languages and science, or (2) continue it with either. As an alternative to the second cycle, which normally ends in the examination for the *baccalauréal*, there is a shorter course, mainly founded on modern languages or applied science and ending in a public examination without the *baccalauréal*. The *baccalauréal*, however, has been condemned by the next minister, M. Briand, who prefers to crown the course with the award of a school diploma (1907).

See H. Lantoiné, *Histoire de l'enseignement secondaire en France au XVII^e siècle* (1874); A. Sicard, *Les Études classiques avant la Révolution* (1887); Sainte-Beuve, *Port-Royal*, vols. i-v. (1840-1859), especially iii. 383-588; O. Gréard, *Éducation et instruction*, 4 vols., especially "Enseignement secondaire," vol. ii. pp. 1-90, with conspectus of programmes in the appendix (1889); A. Ribot, *La Réforme de l'enseignement secondaire* (1900); G. Leygues, *Plan d'études*, &c. (1902); H. H. Johnson, "Present State of Classical Studies in France," in *Classical Review* (December 1907). See also the English Education Department's *Special Reports on Education in France* (1899). The earlier literature is best represented in England by Matthew Arnold's *Schools and Universities in France* (1868; new edition, 1892) and *A French Elton* (1864).

3. The history of education in Germany since 1500 falls into three periods: (a) the age of the Revival of Learning and the Reformation (1500-1650), (b) the age of French influence (1650-1800), and (c) the 19th century.

(a) During the first twenty years of the 16th century the reform of Latin instruction was carried out by setting aside the old medieval grammars, by introducing new manuals of classical literature, and by prescribing the study of classical authors and the imitation of classical models. In all these points the lead was first taken by south Germany, and by the towns along the Rhine down to the Netherlands. The old schools and universities were being quietly interpenetrated by the new spirit of humanism, when the sky was suddenly darkened by the clouds of religious conflict. In 1525-1535 there was a marked depression in the classical studies of Germany. Erasmus, writing to W. Pirckheimer in 1528, exclaims: "Wherever the spirit of Luther prevails, learning goes to the ground." Such a fate was, however, averted by the intervention of Melanchthon (d. 1560), the *praeceptor Germaniae*, who was the embodiment of the spirit of the new Protestant type of education, with its union of evangelical doctrine and humanistic culture.

Under his influence, new schools rapidly rose into being at Magdeburg, Eisleben and Nuremberg (1521-1526). During more than forty years of academic activity he not only provided manuals of Latin and Greek grammar and many other text-books that long remained in use, but he also formed for Germany a well-trained class of learned teachers, who extended his influence throughout the land. His principal ally as an educator and as a writer of text-books was Camerarius (d. 1574). Precepts of style, and models taken from the best Latin authors, were the means whereby a remarkable skill in the imitation of Cicero was attained at Strassburg during the forty-four years of the headmastership of Johannes von Sturm (d. 1589), who had himself been influenced by the *De disciplinis* of J. L. Vivès (1531), and in all his teaching aimed at the formation of a *sapiens atque eloquens pietas*. Latin continued to be the living language of learning and of literature, and a correct and elegant Latin style was regarded as the mark of

an educated person. Greek was taught in all the great schools, but became more and more confined to the study of the Greek Testament. In 1550 it was proposed in Brunswick to banish all "profane" authors from the schools, and in 1589 a competent scholar was instructed to write a sacred epic on the kings of Israel as a substitute for the works of the "pagan" poets. In 1637, when the doubts of Scaliger and Heinsius as to the purity of the Greek of the New Testament prompted the rector of Hamburg to introduce the study of classical authors, any reflection on the style of the Greek Testament was bitterly resented.

The Society of Jesus was founded in 1540, and by 1600 most of the teachers in the Catholic schools and universities of Germany were Jesuits. The society was "dissolved" in 1773, but survived its dissolution. In accordance with the *Ratio Studiorum* of Aquaviva (1599), which long remained unaltered and was only partially revised by J. Roothaan (1832), the main subjects of instruction were the *litterae humaniores diversarum linguarum*. The chief place among these was naturally assigned to Latin, the language of the society and of the Roman Church. The Latin grammar in use was that of the Jesuit rector of the school at Lisbon, Alvarez (1572). As in the Protestant schools, the principal aim was the attainment of *eloquentia*. A comparatively subordinate place was assigned to Greek, especially as the importance attributed to the Vulgate weakened the motive for studying the original text. It was recognized, however, that Latin itself (as Vivès had said) was "in no small need of Greek," and that, "unless Greek was learnt in boyhood, it would hardly ever be learnt at all." The text-book used was the *Institutiones linguae Graecae* of the German Jesuit, Jacob Gretser, of Ingolstadt (c. 1590), and the reading in the highest class included portions of Demosthenes, Isocrates, Plato, Thucydides, Homer, Hesiod, Pindar, Gregory of Nazianzus, Basil and Chrysostom. The Catholic and Protestant schools of the 16th century succeeded, as a rule, in giving a command over a correct Latin style and a taste for literary form and for culture. Latin was still the language of the law-courts and of a large part of general literature. Between Luther and Lessing there was no great writer of German prose.

(b) In the early part of the period 1650-1800, while Latin continued to hold the foremost place, it was ceasing to be Latin of the strictly classical type. Greek fell still further into the background; and Homer and Demosthenes gradually gave way to the Greek Testament. Between 1600 and 1775 there was a great gap in the production of new editions of the principal Greek classics. The spell was only partially broken by J. A. Ernesti's *Homer* (1759 f.) and Chr. G. Heyne's *Pindar* (1773 f.).

The peace of Westphalia (1648) marks a distinct epoch in the history of education in Germany. Thenceforth, education became more modern and more secular. The long wars of religion in Germany, as in France and England, were followed by a certain indifference as to disputed points of theology. But the modern and secular type of education that now supervened was opposed by the pietism of the second half of the 17th century, represented at the newly-founded university of Halle (1694) by A. H. Francke, the professor of Greek (d. 1727), whose influence was far greater than that of Chr. Cellarius (d. 1707), the founder of the first philological *Seminar* (1697). Francke's contemporary, Chr. Thomasius (d. 1728), was never weary of attacking scholarship of the old humanistic type and everything that savoured of antiquarian pedantry, and it was mainly his influence that made German the language of university lectures and of scientific and learned literature. A modern education is also the aim of the general introduction to the *nova methodus* of Leibnitz, where the study of Greek is recommended solely for the sake of the Greek Testament (1666). Meanwhile, Ratichius (d. 1635) had in vain pretended to teach Hebrew, Greek and Latin in the space of six months (1612), but he had the merit of maintaining that the study of a language should begin with the study of an author. Comenius (d. 1671) had proposed to teach Latin by drilling his

The Greek Testament.

The Jesuits.

The age of French influence.

Modern and secular education.

pupils in a thousand graduated phrases distributed over a hundred instructive chapters, while the Latin authors were banished because of their difficulty and their "paganism" (1631). One of the catchwords of the day was to insist on a knowledge of *things* instead of a knowledge of *words*, on "realism" instead of "verbalism."

Under the influence of France the perfect courtier became the ideal in the German education of the upper classes of the 17th and 18th centuries. A large number of aristocratic schools (*Ritter-Akademien*) were founded, beginning with the Collegium Illustre of Tübingen (1589) and ending with the Hohe Karlschule of Stuttgart (1775). In these schools, the subjects of study included mathematics and natural sciences, geography and history, and modern languages (especially French), with riding, fencing and dancing; Latin assumed a subordinate place, and classical composition in prose or verse was not considered a sufficiently courtly accomplishment. The youthful aristocracy were thus withdrawn from the old Latin schools of Germany, but the aristocratic schools vanished with the dawn of the 19th century, and the ordinary public schools were once more frequented by the young nobility.

(c) *The Modern Period.*—In the last third of the 18th century two important movements came into play, the "naturalism" of Rousseau and the "new humanism." While Rousseau sought his ideal in a form of education and of culture that was in close accord with nature, the German apostles of the new humanism were convinced that they had found that ideal completely realized in the old Greek world. Hence the aim of education was to make young people thoroughly "Greek," to fill them with the "Greek" spirit, with courage and keenness in the quest of truth, and with a devotion to all that was beautiful. The link between the

naturalism of Rousseau and the new humanism is to be found in J. G. Herder, whose passion for all that is Greek inspires him with almost a hatred of Latin. The new humanism was a kind of revival of the Renaissance, which had been retarded by the Reformation in Germany and by the Counter-Reformation in Italy, or had at least been degraded to the dull classicism of the schools. The new humanism agreed with the Renaissance in its unreserved recognition of the old classical world as a perfect pattern of culture. But, while the Renaissance aimed at reproducing the Augustan age of Rome, the new humanism found its golden age in Athens. The Latin Renaissance in Italy aimed at recovering and verbally imitating the ancient literature; the Greek Renaissance in Germany sought inspiration from the creative originality of Greek literature with a view to producing an original literature in the German language. The movement had its effect on the schools by discouraging the old classical routine of verbal imitation, and giving a new prominence to Greek and to German. The new humanism found a home in Göttingen (1783) in the days of J. M. Gesner and C. G. Heyne. It was represented at Leipzig by Gesner's successor, Ernesti (d. 1781); and at Halle by F. A. Wolf, who in 1783 was appointed professor of education by Zedlitz, the minister of Frederick the Great. In literature, its leading names were Winckelmann, Lessing and Voss, and Herder, Goethe and Schiller. The tide of the new movement had reached its height about 1800. Goethe and Schiller were convinced that the old Greek world was the highest revelation of humanity; and the universities and schools of Germany were reorganized in this spirit by F. A. Wolf and his illustrious pupil, Wilhelm von Humboldt. In 1809–1810 Humboldt was at the

head of the educational section of the Prussian Home Office, and, in the brief interval of a year and a half, gave to the general system of education the direction which it followed (with slight exceptions) throughout the whole century. In 1810 the *examen pro facultate docendi* first made the profession of a schoolmaster independent of that of a minister of religion. The new scheme drawn up by J. W. Süvern recognized four principal co-ordinated branches of learning: Latin, Greek, German, mathematics. All four were

studied throughout the school, Greek being begun in the fourth of the nine classes, that corresponding to the English "third form." The old Latin school had only one main subject, the study of Latin style (combined with a modicum of Greek). The new gymnasium aimed at a wider education, in which literature was represented by Latin, Greek and German, by the side of mathematics and natural science, history and religion. The uniform employment of the term *Gymnasium* for the highest type of a Prussian school dates from 1812. The leaving examination (*Abgangsprüfung*), instituted in that year, required Greek translation at sight, with Greek prose composition, and ability to speak and to write Latin. In 1818–1840 the leading spirit on the board of education was Johannes Schulze, and a complete and comprehensive system of education continued to be the ideal kept in view. Such an education, however, was found in practice to involve a prolongation of the years spent at school and a correspondingly later start in life. It was also attacked on the ground that it led to "overwork." This attack was partially met by the scheme of 1837. Schulze's period of prominence in Berlin closely corresponded to that of Herbart at Königsberg (1809–1833) and Göttingen (1833–1841), who insisted that for boys of eight to twelve there was no better text-book than the Greek *Odyssey*, and this principle was brought into practice at Hanover by his distinguished pupil, Ahrens.

The Prussian policy of the next period, beginning with the accession of Friedrich Wilhelm IV. in 1840, was to lay a new stress on religious teaching, and to obviate the risk of overwork resulting from the simultaneous study of all subjects by the encouragement of specialization in a few. Ludwig Wiese's scheme of 1856 insisted on the retention of Latin verse as well as Latin prose, and showed less favour to natural science, but it awakened little enthusiasm, while the attempt to revive the old humanistic Gymnasium led to a demand for schools of a more modern type, which issued in the recognition of the *Realgymnasium* (1859).

In the age of Bismarck, school policy in Prussia had for its aim an increasing recognition of modern requirements. In 1875 Wiese was succeeded by Bonitz, the eminent Aristotelian scholar, who in 1849 had introduced mathematics and natural science into the schools of Austria, and had substituted the wide reading of classical authors for the prevalent practice of speaking and writing Latin. By his scheme of 1882 natural science recovered its former position in Prussia, and the hours assigned in each week to Latin were diminished from 86 to 77. But neither of the two great parties in the educational world was satisfied; and great expectations were aroused when the question of reform was taken up by the German emperor, William II., in 1890. The result of the conference of December 1890 was a compromise between the conservatism of a majority of its members and the forward policy of the emperor. The scheme of 1892 reduced the number of hours assigned to Latin from 77 to 62, and laid special stress on the *German* essay; but the modern training given by the *Realgymnasium* was still unrecognized as an avenue to a university education. A conference held in June 1900, in which the speakers included Mommsen and von Wilamowitz, Harnack and Diels, was followed by the "Kiel Decree" of the 26th of November. In that decree the emperor urged the equal recognition of the classical and the modern *Gymnasium*, and emphasized the importance of giving more time to Latin and to English in both. In the teaching of Greek, "useless details" were to be set aside, and special care devoted to the connexion between ancient and modern culture, while, in all subjects, attention was to be paid to the classic precept: *multum, non multa*.

By the scheme of 1901 the pupils of the *Realgymnasium*, the *Oberrealschule* and the *Gymnasium* were admitted to the university on equal terms in virtue of their leaving-certificates, but Greek and Latin were still required for students of classics or divinity.

For the *Gymnasium* the aim of the new scheme is, in Latin, "to supply boys with a sound basis of grammatical training, with a view to their understanding the more important classical

writers of Rome, and being thus introduced to the intellectual life and culture of the ancient world"; and, in *Greek*, "to give them a sufficient knowledge of the language with a view to their obtaining an acquaintance with some of the Greek classical works which are distinguished both in matter and in style, and thus gaining an insight into the intellectual life and culture of Ancient Greece." In consequence of these changes Greek is now studied by a smaller number of boys, but with better results, and a new lease of life has been won for the classical *Gymnasium*.

Lastly, by the side of the classical *Gymnasium*, we now have the "German Reform Schools" of two different types, that of Altona (dating from 1878) and that of Frankfort-on-the-Main (1892). The leading principle in both is the postponement of the time for learning Latin. Schools of the Frankfort type take French as their only foreign language in the first three years of the course, and aim at achieving in six years as much as has been achieved by the *Gymnasia* in nine; and it is maintained that, in six years, they succeed in mastering a larger amount of Latin literature than was attempted a generation ago, even in the best *Gymnasia* of the old style. It may be added that in all the German *Gymnasia*, whether reformed or not, more time is given to classics than in the corresponding schools in England.

See F. Paulsen, *Geschichte des gelehrten Unterrichts vom Ausgang des Mittelalters bis auf die Gegenwart mit besonderer Rücksicht auf den klassischen Unterricht* (2 vols., 2nd ed. 1896); *Das Realgymnasium und die humanistische Bildung* (1889); *Die höheren Schulen und das Universitätsstudium im 20. Jahrhundert* (1901); "Das moderne Bildungswesen" in *Die Kultur der Gegenwart*, vol. i. (1904); *Das deutsche Bildungswesen in seiner geschichtlichen Entwicklung* (1906) (with the literature there quoted, pp. 190-192), translated by Dr T. Lorenz, *German Education, Past and Present* (1908); T. Ziegler, *Notwendigkeit . . . des Realgymnasiums* (Stuttgart, 1894); F. A. Eckstein, *Latcinischer und griechischer Unterricht* (1887); O. Kohl, "Griechischer Unterricht" (Langensalza, 1896) in W. Rein's *Handbuch*; A. Baumeister's *Handbuch* (1895), especially vol. i. 1 (History) and i. 2 (Educational Systems); P. Stötzner, *Das öffentliche Unterrichtswesen Deutschlands in der Gegenwart* (1901); F. Seiler, *Geschichte des deutschen Unterrichtswesens* (2 vols., 1906); *Verhandlungen* of June 1900 (2nd ed., 1902); *Lehrpläne*, &c. (1901); *Die Reform des höheren Schulwesens*, ed. W. Lexis (1902); A. Harnack's *Vortrag* and W. Parow's *Erwiderung* (1905); H. Müller, *Das höhere Schulwesen Deutschlands am Anfang des 20. Jahrhunderts* (Stuttgart, 1904); O. Steinbart, *Durchführung des preussischen Schulreform in ganz Deutschland* (Duisburg, 1904); J. Schipper, *Alte Bildung und moderne Cultur* (Vienna, 1901); Papers by M. E. Sadler: (1) "Problems in Prussian Secondary Education" (Special Reports of Education Dept., 1899); (2) "The Unrest in Secondary Education in Germany and Elsewhere" (Special Reports of Board of Education, vol. 9, 1902); J. L. Paton, *The Teaching of Classics in Prussian Secondary Schools* (on "German Reform Schools") (1907, Wyman, London); J. E. Russell, *German Higher Schools* (New York, 1899); and (among earlier English publications) Matthew Arnold's *Higher Schools and Universities in Germany* (1874, reprinted from *Schools and Universities on the Continent*, 1865).

(4) In the *United States of America* the highest degree of educational development has been subsequent to the Civil War.

The study of Latin begins in the "high schools," the average age of admission being fifteen and the normal course extending over four years. Among classical teachers an increasing number would prefer a longer course extending over six years for Latin, and at least three for Greek, and some of these would assign to the elementary school the first two of the proposed six years of Latin study. Others are content with the late learning of Latin and prefer that it should be preceded by a thorough study of modern languages (see Prof. B. I. Wheeler, in Baumeister's *Handbuch*, 1897, ii. 2, pp. 584-586).

It was mainly owing to a pamphlet issued in 1871 by Prof. G. M. Lane, of Harvard, that a reformed pronunciation of Latin was adopted in all the colleges and schools of the United States. Some misgivings on this reform found expression in a work on the *Teaching of Latin*, published by Prof. C. E. Bennett of Cornell in 1901, a year in which it was estimated that this pronunciation was in use by more than 96% of the Latin pupils in the secondary schools.

Some important statistics as to the number studying Latin and Greek in the secondary schools were collected in 1900 by a committee of twelve educational experts representing all parts of the Union, with a view to a uniform course of instruction being

pursued in all classical schools. They had the advantage of the co-operation of Dr W. T. Harris, the U.S. commissioner of education, and they were able to report that, in all the five groups into which they had divided the states, the number of pupils pursuing the study of Latin and Greek showed a remarkable advance, especially in the most progressive states of the middle west. The number learning Latin had increased from 100,144 in 1890 to 314,856 in 1899-1900, and those learning Greek from 12,869 to 24,869. Thus the number learning Latin at the later date was three times, and the number learning Greek twice, as many as those learning Latin or Greek ten years previously. But the total number in 1900 was 630,048; so that, notwithstanding this proof of progress, the number learning Greek in 1900 was only about one twenty-fifth of the total number, while the number learning Latin was as high as half.

The position of Greek as an "elective" or "optional" subject (notably at Harvard), an arrangement regarded with approval by some eminent educational authorities and with regret by others, probably has some effect on the high schools in the small number of those who learn Greek, and in their lower rate of increase, as compared with those who learn Latin. Some evidence as to the quality of the study of those languages in the schools is supplied by English commissioners in the *Reports of the Mosely Commission*. Thus Mr Papillon considered that, while the teaching of English literature was admirable, the average standard of Latin and Greek teaching and attainment in the upper classes was "below that of an English public school"; he felt, however, that the secondary schools of the United States had a "greater variety of the curriculum to suit the practical needs of life," and that they existed, not "for the select few," but "for the whole people" (pp. 250 f.).

For full information see the "Two volumes of Monographs prepared for the United States Educational Exhibit at the Paris Exposition of 1900," edited by Dr N. Murray Butler; the *Annual Reports* of the U.S. commissioner of education (Washington); and the *Reports of the Mosely Commission to the United States of America* (London, 1904). Cf. statistics quoted in G. G. Ramsay's "Address on Efficiency in Education" (Glasgow, 1902, 17-20), from the *Transactions of the Amer. Philol. Association*, xxx. (1899), pp. lxxvii-cxxii; also Bennett and Bristol, *The Teaching of Latin and Greek in the Secondary School* (New York, 1901). (J. E. S.*)

CLASSIFICATION (Lat. *classis*, a class, probably from the root *cal-*, *cla-*, as in Gr. *καλέω*, *clamo*), a logical process, common to all the special sciences and to knowledge in general, consisting in the collection under a common name of a number of objects which are alike in one or more respects. The process consists in observing the objects and abstracting from their various qualities that characteristic which they have in common. This characteristic constitutes the definition of the "class" to which they are regarded as belonging. It is this process by which we arrive first at "species" and then at "genus," i.e. at all scientific generalization. Individual things, regarded as such, constitute a mere aggregate, unconnected with one another, and so far unexplained; scientific knowledge consists in systematic classification. Thus if we observe the heavenly bodies individually we can state merely that they have been observed to have certain motions through the sky, that they are luminous, and the like. If, however, we compare them one with another, we discover that, whereas all partake in the general movement of the heavens, some have a movement of their own. Thus we arrive at a system of classification according to motion, by which fixed stars are differentiated from planets. A further classification according to other criteria gives us stars of the first magnitude and stars of the second magnitude, and so forth. We thus arrive at a systematic understanding expressed in laws by the application of which accurate forecasts of celestial phenomena can be made. Classification in the strict logical sense consists in discovering the casual interrelation of natural objects; it thus differs from what is often called "artificial" classification, which is the preparation, e.g. of statistics for particular purposes, administrative and the like.

Of the systems of classification adopted in physical science, only one requires treatment here, namely, the classification of

Unltd States.

Latin pronunciation.

the sciences as a whole, a problem which has from the time of Aristotle attracted considerable attention. Its object is to delimit the spheres of influence of the positive sciences and show how they are mutually related. Of such attempts three are specially noteworthy, those of Francis Bacon, Auguste Comte and Herbert Spencer.

Bacon's classification is based on the subjective criterion of the various faculties which are specially concerned. He thus distinguished History (natural, civil, literary, ecclesiastical) as the province of memory, Philosophy (including Theology) as that of reason, and Poetry, Fables and the like, as that of imagination. This classification was made the basis of the *Encyclopédie*. Comte adopted an entirely different system based on an objective criterion. Having first enunciated the theory that all science passes through three stages, theological, metaphysical and positive, he neglects the two first, and divides the last according to the "things to be classified," in view of their real affinity and natural connexions, into six, in order of decreasing generality and increasing complexity—mathematics, astronomy, physics, chemistry, physiology and biology (including psychology), and sociology. This he conceives to be not only the logical, but also the historical, order of development, from the abstract and purely deductive to the concrete and inductive). Sociology is thus the highest, most complex, and most positive of the sciences. Herbert Spencer, condemning this division as both incomplete and theoretically unsound, adopted a three-fold division into (1) *abstract* science (including logic and mathematics) dealing with the universal forms under which all knowledge of phenomena is possible, (2) *abstract-concrete* science (including mechanics, chemistry, physics), dealing with the elements of phenomena themselves, *i.e.* laws of forces as deducible from the persistence of forces, and (3) *concrete* science (*e.g.* astronomy, biology, sociology), dealing with "phenomena themselves in their totalities," the universal laws of the continuous redistribution of Matter and Motion, Evolution and Dissolution.

Beside the above three systems several others deserve brief mention. In Greece at the dawn of systematic thought the physical sciences were few in number; none the less philosophers were not agreed as to their true relation. The Platonic school adopted a triple classification, physics, ethics and dialectics; Aristotle's system was more complicated, nor do we know precisely how he subdivided his three main classes, theoretical, practical and poetical (*i.e.* technical, having to do with *ποίησις*, creative). The second class covered ethics and politics, the latter of which was often regarded by Aristotle as including ethics; the third includes the useful and the imitative sciences; the first includes metaphysics and physics. As regards pure logic Aristotle sometimes seems to include it with metaphysics and physics, sometimes to regard it as ancillary to all the sciences.

Thomas Hobbes (*Leviathan*) drew up an elaborate paradigm of the sciences, the first stage of which was a dichotomy into "Naturall Philosophy" ("consequences from the accidents of bodies naturall") and "Politiques and Civill Philosophy" ("consequences from accidents of Politique bodies"). The former by successive subdivisions is reduced to eighteen special sciences; the latter is subdivided into the rights and duties of sovereign powers, and those of the subject.

Jeremy Bentham and A. M. Ampère both drew up elaborate systems based on the principle of dichotomy, and beginning from the distinction of mind and body. Bentham invented an artificial terminology which is rather curious than valuable. The science of the body was Somatology, that of the mind Pneumatology. The former include Posology (science of quantity, mathematics) and Poiology (science of quality); Posology includes Morphoscopic (geometry) and Alegomorphic (arithmetic). See further Bentham's *Chrestomathia* and works quoted under BENTHAM, JEREMY.

Carl Wundt criticized most of these systems as taking too little account of the real facts, and preferred a classification based on the standpoint of the various sciences towards their subject-matter. His system may, therefore, be described as conceptional. It distinguishes philosophy, which deals with facts in their widest

universal relations, from the special sciences, which consider facts in the light of a particular relation or set of relations.

All these systems have a certain value, and are interesting as throwing light on the views of those who invented them. It will be seen, however, that none can lay claim to unique validity. The *fundamenta divisionis*, though in themselves more or less logical, are quite arbitrarily chosen, generally as being germane to a preconceived philosophical or scientific theory.

CLASTIDIUM (mod. *Casteggio*), a village of the Anamares, in Gallia Cispadana, on the Via Postumia, 5 m. E. of Iria (mod. *Voghera*) and 31 m. W. of Placentia. Here in 222 B.C. M. Claudius Marcellus defeated the Gauls and won the *spolia opima*; in 218 Hannibal took it and its stores of corn by treachery. It never had an independent government, and not later than 190 B.C. was made part of the colony of Placentia (founded 219). In the Augustan division of Italy, however, Placentia belonged to the 8th region, Aemilia, whereas Iria certainly, and Clastidium possibly, belonged to the 9th, Liguria (see Th. Mommsen in *Corp. Inscript. Lat.* vol. v. Berlin, 1877, p. 828). The remains visible at Clastidium are scanty; there is a fountain (the Fontana d'Annibale), and a Roman bridge, which seems to have been constructed of tiles, not of stone, was discovered in 1857, but destroyed.

See C. Giulietti, *Casteggio, notizie storiche II. Avanzi di antichità* (Voghera, 1893).

CLAUBERG, JOHANN (1622–1665), German philosopher, was born at Solingen, in Westphalia, on the 24th of February 1622. After travelling in France and England, he studied the Cartesian philosophy under John Raey at Leiden. He became (1649) professor of philosophy and theology at Herborn, but subsequently (1651), in consequence of the jealousy of his colleagues, accepted an invitation to a similar post at Duisburg, where he died on the 31st of January 1665. Clauberg was one of the earliest teachers of the new doctrines in Germany and an exact and methodical commentator on his master's writings. His theory of the connexion between the soul and the body is in some respects analogous to that of Malebranche; but he is not therefore to be regarded as a true forerunner of Occasionalism, as he uses "Occasion" for the stimulus which directly produces a mental phenomenon, without postulating the intervention of God (H. Müller, *J. Clauberg und seine Stellung im Cartesianismus*). His view of the relation of God to his creatures is held to foreshadow the pantheism of Spinoza. All creatures exist only through the continuous creative energy of the Divine Being, and are no more independent of his will than are our thoughts independent of us,—or rather less, for there are thoughts which force themselves upon us whether we will or not. For metaphysics Clauberg suggested the names *ontosophy* or *ontology*, the latter being afterwards adopted by Wolff. He also devoted considerable attention to the German languages, and his researches in this direction attracted the favourable notice of Leibnitz. His chief works are: *De conjunctione animæ et corporis humani*; *Exercitationes centum de cognitione Dei et nostri*; *Logica vetus et nova*; *Initiatio philosophi, seu Dubitatio Cartesianæ*, a commentary on Descartes' *Meditations*; and *Ars etymologica Teutonum*.

A collected edition of his philosophical works was published at Amsterdam (1691), with life by H. C. Hennin; see also E. Zeller, *Geschichte der deutschen Philosophie seit Leibnitz* (1873).

CLAUDE, JEAN (1619–1687), French Protestant divine, was born at La Sauvetat-du-Dropt near Agen. After studying at Montauban, he entered the ministry in 1645. He was for eight years professor of theology in the Protestant college of Nîmes; but in 1661, having successfully opposed a scheme for re-uniting Catholics and Protestants, he was forbidden to preach in Lower Languedoc. In 1662 he obtained a post at Moutauban similar to that which he had lost; but after four years he was removed from this also. He next became pastor at Charenton near Paris, where he engaged in controversies with Pierre Nicole (*Réponse aux deux traités intitulés la perpétuité de la foi*, 1665), Antoine Arnauld (*Réponse au livre de M. Arnauld*, 1670), and J. B. Bossuet (*Réponse au livre de M. l'évêque de Meaux*, 1683).

On the revocation of the edict of Nantes he fled to Holland, and received a pension from William of Orange, who commissioned him to write an account of the persecuted Huguenots (*Plaines des protestants cruellement opprimés dans le royaume de France*, 1686). The book was translated into English, but by order of James II. both the translation and the original were publicly burnt by the common hangman on the 5th of May 1686, as containing "expressions scandalous to His Majesty the king of France." Other works by him were *Réponse au livre de P. Nouet sur l'eucharistie* (1668); *Œuvres posthumes* (Amsterdam, 1688), containing the *Traité de la composition d'un sermon*, translated into English in 1778.

See biographies by J. P. Nicéron and Abel Rotholf de la Devèze; E. Haag, *La France protestante*, vol. iv. (1884, new edition).

CLAUDE OF LORRAINE, or **CLAUDE GELÉE** (1600-1682), French landscape-painter, was born of very poor parents at the village of Chamagne in Lorraine. When it was discovered that he made no progress at school, he was apprenticed, it is commonly said, to a pastry-cook, but this is extremely dubious. At the age of twelve, being left an orphan, he went to live at Freiburg on the Rhine with an elder brother, Jean Gelée, a wood-carver of moderate merit, and under him he designed arabesques and foliage. He afterwards rambled to Rome to seek a livelihood; but from his clownishness and ignorance of the language, he failed to obtain permanent employment. He next went to Naples, to study landscape painting under Godfrey Waals, a painter of much repute. With him he remained two years; then he returned to Rome, and was domesticated until April 1625 with another landscape-painter, Augustin Tassi, who hired him to grind his colours and to do all the household drudgery.

His master, hoping to make Claude serviceable in some of his greatest works, advanced him in the rules of perspective and the elements of design. Under his tuition the mind of Claude began to expand, and he devoted himself to artistic study with great eagerness. He exerted his utmost industry to explore the true principles of painting by an incessant examination of nature; and for this purpose he made his studies in the open fields, where he very frequently remained from sunrise till sunset, watching the effect of the shifting light upon the landscape. He generally sketched whatever he thought beautiful or striking, marking every tinge of light with a similar colour; from these sketches he perfected his landscapes. Leaving Tassi, he made a tour in Italy, France and a part of Germany, including his native Lorraine, suffering numerous misadventures by the way. Karl Dervent, painter to the duke of Lorraine, kept him as assistant for a year; and he painted at Nancy the architectural subjects on the ceiling of the Carmelite church. He did not, however, relish this employment, and in 1627 returned to Rome. Here, painting two landscapes for Cardinal Bentivoglio, he earned the protection of Pope Urban VIII. and from about 1637 he rapidly rose into celebrity. Claude was acquainted not only with the facts, but also with the laws of nature; and the German painter Joachim von Sandrart relates that he used to explain, as they walked together through the fields, the causes of the different appearances of the same landscape at different hours of the day, from the reflections or refractions of light, or from the morning and evening dews or vapours, with all the precision of a natural philosopher. He elaborated his pictures with great care; and if any performance fell short of his ideal, he altered, erased and repainted it several times over.

His skies are aerial and full of lustre, and every object harmoniously illumined. His distances and colouring are delicate, and his tints have a sweetness and variety till then unexampled. He frequently gave an uncommon tenderness to his finished trees by glazing. His figures, however, are very indifferent; but he was so conscious of his deficiency in this respect, that he usually engaged other artists to paint them for him, among whom were Courtois and Filippo Lauri. Indeed, he was wont to say that he sold his landscapes and gave away his figures. In order to avoid a repetition of the same subject, and also to detect the very numerous spurious copies of his works, he made tinted outline drawings (in six paper books prepared for this purpose) of all

those pictures which were transmitted to different countries; and on the back of each drawing he wrote the name of the purchaser. These books he named *Libri di vendita*. This valuable work (now belonging to the duke of Devonshire) has been engraved and published, and has always been highly esteemed by students of the art of landscape. Claude, who had suffered much from gout, died in Rome at the age of eighty-two, on the 21st (or perhaps the 23rd) of November 1682, leaving his wealth, which was considerable, between his only surviving relatives, a nephew and an adopted daughter (? niece).

Many choice specimens of his genius may be seen in the National Gallery and in the Louvre; the landscapes in the Altieri and Colonna palaces in Rome are also of especial celebrity. A list has been printed showing no less than 92 examples in the various public galleries of Europe. He himself regarded a landscape which he painted in the Villa Madama, being a cento of various views with great abundance and variety of leafage, and a composition of Esther and Ahasuerus, as his finest works; the former he refused to sell, although Clement IX. offered to cover its surface with gold pieces. He etched a series of twenty-eight landscapes, fine impressions of which are greatly prized. Full of amenity, and deeply sensitive to the graces of nature, Claude was long deemed the prince of landscape painters, and he must always be accounted a prime leader in that form of art, and in his day a great enlarger and refiner of its province.

Claude was a man of amiable and simple character, very kind to his pupils, a patient and unwearied worker; in his own sphere of study, his mind was stored (as we have seen) with observation and knowledge, but he continued an unlettered man till his death. Famous and highly patronized though he was in all his later years, he seems to have been very little known to his brother artists, with the single exception of Sandrart. This painter is the chief direct authority for the facts of Claude's life (*Academia Artis Pictoriae*, 1683); Baldinucci, who obtained information from some of Claude's immediate survivors, relates various incidents to a different effect (*Notizie dei professori del disegno*).

See also Victor Cousin, *Sur Claude Gelée* (1853); M. F. Sweetser, *Claude Lorrain* (1878); Lady Dilke, *Claude Lorrain* (1884).

(W. M. R.)

CLAUDET, ANTOINE FRANÇOIS JEAN (1797-1867), French photographer, was born at Lyons on the 12th of August 1797. Having acquired a share in L. J. M. Daguerre's invention, he was one of the first to practise daguerreotype portraiture in England, and he improved the sensitizing process by using chlorine in addition to iodine, thus gaining greater rapidity of action. In 1848 he produced the photophometer, an instrument designed to measure the intensity of photogenic rays; and in 1849 he brought out the focimeter, for securing a perfect focus in photographic portraiture. He was elected a fellow of the Royal Society in 1853, and in 1858 he produced the stereomonoscope, in reply to a challenge from Sir David Brewster. He died in London on the 27th of December 1867.

CLAUDIUS, CLAUDIUS, Latin epic poet and panegyrist, flourished during the reign of Arcadius and Honorius. He was an Egyptian by birth, probably an Alexandrian, but it may be conjectured from his name and his mastery of Latin that he was of Roman extraction. His own authority has been assumed for the assertion that his first poetical compositions were in Greek, and that he had written nothing in Latin before A.D. 395; but this seems improbable, and the passage (*Carm. Min.* xli. 13) which is taken to prove it does not necessarily bear this meaning. In that year he appears to have come to Rome, and made his début as a Latin poet by a panegyric on the consulship of Olybrius and Probinus, the first brothers not belonging to the imperial family who had ever simultaneously filled the office of consul. This piece proved the precursor of the series of panegyric poems which compose the bulk of his writings. In Birt's edition a complete chronological list of Claudian's poems is given, and also in J. B. Bury's edition of Gibbon (iii. app. i. p. 485), where the dates given differ slightly from those in the present article.

In 396 appeared the encomium on the third consulship of the emperor Honorius, and the epic on the downfall of Rufinus, the

unworthy minister of Arcadius at Constantinople. This revolution was principally effected by the contrivance of Stilicho, the great general and minister of Honorius. Claudian's poem appears to have obtained his patronage, or rather perhaps that of his wife Serena, by whose interposition the poet was within a year or two enabled to contract a wealthy marriage in Africa (*Epist.* 2). Previously to this event he had produced (398) his panegyric on the fourth consulship of Honorius, his epithalamium on the marriage of Honorius to Stilicho's daughter, Maria, and his poem on the Gildonic war, celebrating the repression of a revolt in Africa. To these succeeded his piece on the consulship of Manlius Theodorus (399), the unfinished or mutilated invective against the Byzantine prime minister Eutropius in the same year, the epics on Stilicho's first consulship and on his repulse of Alaric (400 and 403), and the panegyric on the sixth consulship of Honorius (404). From this time all trace of Claudian is lost, and he is generally supposed to have perished with his patron Stilicho in 408. It may be conjectured that he must have died in 404, as he could hardly otherwise have omitted to celebrate the greatest of Stilicho's achievements, the destruction of the barbarian host led by Radagaisus in the following year. On the other hand, he may have survived Stilicho, as in the dedication to the second book of his epic on the *Rape of Proserpine* (which Birt, however, assigns to 395-397), he speaks of his disuse of poetry in terms hardly reconcilable with the fertility which he displayed during his patron's lifetime. From the manner in which Augustine alludes to him in his *De civitate Dei*, it may be inferred that he was no longer living at the date of the composition of that work, between 415 and 428.

Besides Claudian's chief poems, his lively Fescennines on the emperor's marriage, his panegyric on Serena, and the *Gigantomachia*, a fragment of an unfinished Greek epic, may also be mentioned. Several poems expressing Christian sentiments are undoubtedly spurious. Claudian's paganism, however, neither prevented his celebrating Christian rulers and magistrates nor his enjoying the distinction of a court laureate. It is probable that he was nominally a Christian, like his patron Stilicho and Ausonius, although at heart attached to the old religion. The very decided statements of Orosius and Augustine as to his heathenism may be explained by the pagan style of Claudian's political poems. We have his own authority for his having been honoured by a bronze statue in the forum, and Pomponius Laetus discovered in the 15th century an inscription (*C.I.L.* vi. 1710) on the pedestal, which, formerly considered spurious, is now generally regarded as genuine.

The position of Claudian—the last of the Roman poets—is unique in literature. It is sufficiently remarkable that, after nearly three centuries of torpor, the Latin muse should have experienced any revival in the age of Honorius, nothing less than amazing that this revival should have been the work of a foreigner, most surprising of all that a just and enduring celebrity should have been gained by official panegyrics on the generally uninteresting transactions of an inglorious epoch. The first of these particulars bespeaks Claudian's taste, rising superior to the prevailing barbarism, the second his command of language, the third his rhetorical skill. As remarked by Gibbon, "he was endowed with the rare and precious talent of raising the meanest, of adorning the most barren, and of diversifying the most similar topics." This gift is especially displayed in his poem on the downfall of Rufinus, where the punishment of a public malefactor is exalted to the dignity of an epical subject by the magnificence of diction and the ostentation of supernatural machinery. The noble exordium, in which the fate of Rufinus is propounded as the vindication of divine justice, places the subject at once on a dignified level; and the council of the infernal powers has afforded a hint to Tasso, and through him to Milton. The inevitable monotony of the panegyrics on Honorius is relieved by just and brilliant expatiation on the duties of a sovereign. In his celebration of Stilicho's victories Claudian found a subject more worthy of his powers, and some passages, such as the description of the flight of Alaric, and of Stilicho's arrival at Rome, and the felicitous parallel between his triumphs

and those of Marius, rank among the brightest ornaments of Latin poetry. Claudian's panegyric, however lavish and regardless of veracity, is in general far less offensive than usual in his age, a circumstance attributable partly to his more refined taste and partly to the genuine merit of his patron Stilicho. He is a valuable authority for the history of his times, and is rarely to be convicted of serious inaccuracy in his facts, whatever may be thought of the colouring he chooses to impart to them. He was animated by true patriotic feeling, in the shape of a reverence for Rome as the source and symbol of law, order and civilization. Outside the sphere of actual life he is less successful; his *Rape of Proserpine*, though the beauties of detail are as great as usual, betrays his deficiency in the creative power requisite for dealing with a purely ideal subject. This denotes the rhetorician rather than the poet, and in general it may be said that his especial gifts of vivid natural description, and of copious illustration, derived from extensive but not cumbrous erudition, are fully as appropriate to eloquence as to poetry. In the general cast of his mind and character of his writings, and especially, in his faculty for bestowing enduring interest upon occasional themes, we may fitly compare him with Dryden, remembering that while Dryden exulted in the energy of a vigorous and fast-developing language, Claudian was cramped by an artificial diction, confined to the literary class.

The editio princeps of Claudian was printed at Vicenza in 1482; the editions of J. M. Gesner (1759) and P. Burmann (1760) are still valuable for their notes. The first critical edition was that of L. Jeep (1876-1879), now superseded by the exhaustive work of T. Birt, with bibliography, in *Monumenta Germaniae Historica* (x., 1892; smaller ed. founded on this by J. Koch, Teubner series, 1893). There is a separate edition with commentary and verse translation of *Il Ratto di Proserpina*, by L. Garces de Diez (1889); the satire *In Eutropium* is discussed by T. Birt in *Zwei politische Satiren des alten Rom* (1888). There is a complete English verse translation of little merit by A. Hawkins (1817). See the articles by Ramsay in Smith's *Classical Dictionary* and Vollmer in Pauly-Wissowa's *Realencyclopädie der classischen Altertumswissenschaft*, iii. 2 (1899); also J. H. E. Crees, *Claudian as an Historian* (1908), the "Cambridge Historical Essay" for 1906 (No. 17); T. Hodgkin, *Claudian, the last of the Roman Poets* (1875).

CLAUDIUS [TIBERIUS CLAUDIUS DRUSUS NERO GERMANICUS], Roman emperor A.D. 41-54, son of Drusus and Antonia, nephew of the emperor Tiberius, and grandson of Livia, the wife of Augustus, was born at Lugdunum (Lyons) on the 1st of August 10 B.C. During his boyhood he was treated with contempt, owing to his weak and timid character and his natural infirmities; the fact that he was regarded as little better than an imbecile saved him from death at the hands of Caligula. He chiefly devoted himself to literature, especially history, and until his accession he took no real part in public affairs, though Caligula honoured him with the dignity of consul. He was four times married: to Plautia Urgulanilla, whom he divorced because he suspected her of designs against his life; to Aelia Petina, also divorced; to the infamous Valeria Messallina (*q.v.*); and to his niece Agrippina.

In A.D. 41, on the murder of Caligula, Claudius was seized by the praetorians, and declared emperor. The senate, which had entertained the idea of restoring the republic, was obliged to acquiesce. One of Claudius's first acts was to proclaim an amnesty for all except Cassius Chacrea, the assassin of his predecessor, and one or two others. After the discovery of a conspiracy against his life in 42, he fell completely under the influence of Messallina and his favourite freedmen Pallas and Narcissus, who must be held responsible for acts of cruelty which have brought undeserved odium upon the emperor. There is no doubt that Claudius was a liberal-minded man of kindly nature, anxious for the welfare of his people. Humane regulations were made in regard to freedmen, slaves, widows and orphans; the police system was admirably organized; commerce was put on a sound footing; the provinces were governed in a spirit of liberality; the rights of citizens and admission to the senate were extended to communities outside Italy. The speech of Claudius delivered (in the year 48) in the senate in support of the petition of the Aeduans that their senators should have the *jus fetendorum honorum* (claim of

admission to the senate and magistracies) at Rome has been partly preserved on the fragment of a bronze tablet found at Lyons in 1524; an imperial edict concerning the citizenship of the Anaunians (15th of March 46) was found in the southern Tirol in 1869 (*C.I.L.* v. 5050). Claudius was especially fond of building. He completed the great aqueduct (Aqua Claudia) begun by Caligula, drained the Lacus Fucinus, and built the harbour of Ostia. Nor were his military operations unsuccessful. Mauretania was made a Roman province; the conquest of Britain was begun; his distinguished general Domitius Corbulo (*q.v.*) gained considerable successes in Germany and the East. The intrigues of Narcissus caused Messalina to be put to death by order of Claudius, who took as his fourth wife his niece Agrippina, a woman as criminal as any of her predecessors. She prevailed upon him to set aside his own son Britannicus in favour of Nero, her son by a former marriage; and in 54, to make Nero's position secure, she put the emperor to death by poison. The apotheosis of Claudius was the subject of a lampoon by Seneca called *apokolokyntosis*, the "pumpkinification" of Claudius.

Claudius was a prolific writer, chiefly on history, but his works are lost. He wrote (in Greek) a history of Carthage and a history of Etruria: (in Latin) a history of Rome from the death of Caesar, an autobiography, and an essay in defence of Cicero against the attacks of Asinius Gallus. He also introduced three new letters into the Latin alphabet: **Ț** for the consonantal V, **Ț** for BS and PS, **Ț** for the intermediate sound between I and U.

AUTHORITIES.—Ancient: the *Annals* of Tacitus, Suetonius and Dio Cassius. Modern: H. Lehmann, *Claudius und seine Zeit*, with introductory chapter on the ancient authorities (1858); Lucien Double, *L'Empereur Claude* (1876); A. Ziegler, *Die politische Seite der Regierung des Kaisers Claudius* (1885); H. F. Pelham in *Quarterly Review* (April 1905), where certain administrative and political changes introduced by Claudius, for which he was attacked by his contemporaries, are discussed and defended; Merivale, *Hist. of the Romans under the Empire*, chs. 49, 50; H. Schiller, *Geschichte der römischen Kaiserzeit*, i., pt. 1; H. Furneaux's ed. of the *Annals* of Tacitus (introduction).

CLAUDIUS, the name of a famous Roman gens. The by-form *Clodius*, in its origin a mere orthographical variant, was regularly used for certain Claudii in late republican times, but otherwise the two forms were used indifferently. The gens contained a patrician and a plebeian family; the chief representatives of the former were the Pulchri, of the latter the Marcelli (see MARCELLUS). The following members of the gens deserve particular mention.

I. APPIUS SABINUS INREGILLENSIS, or REGILLENSIS, CLAUDIUS, so called from Regillum (or Regilli) in Sabine territory, founder of the Claudian gens. His original name was Attus or Attius Clausus. About 504 B.C. he settled in Rome, where he and his followers formed a tribe. In 495 he was consul, and his cruel enforcement of the laws of debtor and creditor, in opposition to his milder colleague, P. Servilius Priscus, was one of the chief causes of the "secession" of the plebs to the Sacred Mount. On several occasions he displayed his hatred of the people, although it is stated that he subsequently played the part of mediator.

Suetonius, *Tiberius*, i.; Livy ii. 16-29; Dion. Halic. v. 40, vi. 23, 24.

2. CLAUDIUS, APPIUS, surnamed CRASSUS, a Roman patrician, consul in 471 and 451 B.C., and in the same and following year one of the decemvirs. At first he was conspicuous for his aristocratic pride and bitter hatred of the plebeians. Twice they refused to fight under him, and fled before their enemies. He retaliated by decimating the army. He was banished, but soon returned, and again became consul. In the same year (451) he was made one of the decemviri who had been appointed to draw up a code of written laws. When it was decided to elect decemvirs for another year, he who had formerly been looked upon as the champion of the aristocracy, suddenly came forward as the friend of the people, and was himself re-elected together with several plebeians. But no sooner was the new body in office, than it treated both patricians and plebeians with equal violence, and refused to resign at the end of the year. Matters

were brought to a crisis by the affair of Virginia. Enamoured of the beautiful daughter of the plebeian centurion Virginius, Claudius attempted to seize her by an abuse of justice. One of his clients, Marcus Claudius, swore that she was the child of a slave belonging to him, and had been stolen by the childless wife of the centurion. Virginius was summoned from the army, and on the day of trial was present to expose the conspiracy. Nevertheless, judgment was given according to the evidence of Marcus, and Claudius commanded Virginia to be given up to him. In despair, her father seized a knife from a neighbouring stall and plunged it in her side. A general insurrection was the result; and the people seceded to the Sacred Mount. The decemvirs were finally compelled to resign and Appius Claudius died in prison, either by his own hand or by that of the executioner. For a discussion of the character of Appius Claudius, see Mommsen's appendix to vol. i. of his *History of Rome*. He holds that Claudius was never the leader of the patrician party, but a patrician demagogue who ended by becoming a tyrant to patricians as well as plebeians. The decemvirate, one of the triumphs of the plebs, could hardly have been abolished by that body, but would naturally have been overthrown by the patricians. The revolution which ruined Claudius was a return to the rule of the patricians represented by the Horatii and Valerii. Livy iii. 32-58; Dion. Halic. x. 59, xi. 3.

3. CLAUDIUS, APPIUS, surnamed CAECUS, Roman patrician and author. In 312 B.C. he was elected censor without having passed through the office of consul. His censorship—which he retained for five years, in spite of the *lex Aemilia* which limited the tenure of that office to eighteen months—was remarkable for the actual or attempted achievement of several great constitutional changes. He filled vacancies in the senate with men of low birth, in some cases even the sons of freedmen (Diod. Sic. xx. 36; Livy ix. 30; Suetonius, *Claudius*, 24). His most important political innovation was the abolition of the old free birth, freehold basis of suffrage. He enrolled the freedmen and landless citizens both in the centuries and in the tribes, and, instead of assigning them to the four urban tribes, he distributed them through all the tribes and thus gave them practical control of the elections. In 304, however, Q. Fabius Rullianus limited the landless and poorer freedmen to the four urban tribes, thus annulling the effect of Claudius's arrangement. Appius Claudius transferred the charge of the public worship of Hercules in the Forum Boarium from the Potitian gens to a number of public slaves. He further invaded the exclusive rights of the patricians by directing his secretary Gnaeus Flavius (whom, though a freedman, he made a senator) to publish the *legis actiones* (methods of legal practice) and the list of *dies fasti* (or days on which legal business could be transacted). Lastly, he gained enduring fame by the construction of a road and an aqueduct, which—a thing unheard of before—he called by his own name (Livy ix. 29; Frontinus, *De Aquis*, 115; Diod. Sic. xx. 36). In 307 he was elected consul for the first time. In 298 he was interrex; in 296, as consul, he led the army in Samnium, and although, with his colleague, he gained a victory over the Etruscans and Samnites, he does not seem to have specially distinguished himself as a soldier (Livy x. 19). Next year he was praetor, and he was once dictator. His character, like his namesake the decemvir's is not easy to define. In spite of his political reforms, he opposed the admission of the plebeians to the consulship and priestly offices; and, although these reforms might appear to be democratic in character and calculated to give preponderance to the lowest class of the people, his probable aim was to strengthen the power of the magistrates (and lessen that of the senate) by founding it on the popular will, which would find its expression in the urban inhabitants and could be most easily influenced by the magistrate. He was already blind and too feeble to walk, when Cineas, the minister of Pyrrhus, visited him, but so vigorously did he oppose every concession that all the eloquence of Cineas was in vain, and the Romans forgot past misfortunes in the inspiration of Claudius's patriotism (Livy x. 13; Justin xviii. 2; Plutarch, *Pyrrhus*, 19). The story of his blindness, however, may be merely a method of

accounting for his cognomen. Tradition regarded it as the punishment of his transference of the cult of Hercules from the Potitii.

Appius Claudius Caecus is also remarkable as the first writer mentioned in Roman literature. His speech against peace with Pyrrhus was the first that was transmitted to writing, and thereby laid the foundation of prose composition. He was the author of a collection of aphorisms in verse mentioned by Cicero (of which a few fragments remain), and of a legal work entitled *De Usurpationibus*. It is very likely also that he was concerned in the drawing up of the *Legis Actiones* published by Flavius. The famous dictum "Every man is the architect of his own fortune" is attributed to him. He also interested himself in grammatical questions, distinguished the two sounds R and S in writing, and did away with the letter Z.

See Mommsen's appendix to his *Roman History* (vol. i.); treatises by W. Siebert (1863) and F. D. Gerlach (1872), dealing especially with the censorship of Claudius.

4. **CLAUDIUS, PUBLIUS**, surnamed **PULCHER**, son of (3). He was the first of the gens who bore this surname. In 249 he was consul and appointed to the command of the fleet in the first Punic War. Instead of continuing the siege of Lilybaeum, he decided to attack the Carthaginians in the harbour of Drepanum, and was completely defeated. The disaster was commonly attributed to Claudius's treatment of the sacred chickens, which refused to eat before the battle. "Let them drink then," said the consul, and ordered them to be thrown into the sea. Having been recalled and ordered to appoint a dictator, he gave another instance of his high-handedness by nominating a subordinate official, M. Claudius Glicia, but the nomination was at once overruled. Claudius himself was accused of high treason and heavily fined. He must have died before 246, in which year his sister Claudia was fined for publicly expressing a wish that her brother Publius could rise from the grave to lose a second fleet and thereby diminish the number of the people. It is supposed that he committed suicide.

Livy, *Epit.*, 19; Polybius i. 49; Cicero, *De Divinatione*, i. 16, ii. 8; Valerius Maximus i. 4, viii. 1.

5. **CLAUDIUS, APPIUS**, surnamed **PULCHER**, Roman statesman and author. He served under his brother-in-law Lucullus in Asia (72 B.C.) and was commissioned to deliver the ultimatum to Tigranes, which gave him the choice of war with Rome or the surrender of Mithradates. In 57 he was praetor, in 56 propraetor in Sardinia, and in 54 consul with L. Domitius Ahenobarbus. Through the intervention of Pompey, he became reconciled to Cicero, who had been greatly offended because Claudius had indirectly opposed his return from exile. In this and certain other transactions Claudius seems to have acted from avaricious motives,—a result of his early poverty. In 53 he entered upon the governorship of Cilicia, in which capacity he seems to have been rapacious and tyrannical. During this period he carried on a correspondence with Cicero, whose letters to him form the third book of the *Epistolae ad Familiares*. Claudius resented the appointment of Cicero as his successor, avoided meeting him, and even issued orders after his arrival in the province. On his return to Rome Claudius was impeached by P. Cornelius Dolabella on the ground of having violated the sovereign rights of the people. This led him to make advances to Cicero, since it was necessary to obtain witnesses in his favour from his old province. He was acquitted, and a charge of bribery against him also proved unsuccessful. In 50 he was censor, and expelled many of the members of the senate, amongst them the historian Sallust on the ground of immorality. His connexion with Pompey brought upon him the enmity of Caesar, at whose march on Rome he fled from Italy. Having been appointed by Pompey to the command in Greece, in obedience to an ambiguous oracle he crossed over to Euboea, where he died about 48, before the battle of Pharsalus. Claudius was of a distinctly religious turn of mind, as is shown by the interest he took in sacred buildings (the temple at Eleusis, the sanctuary of Amphiaras at Oropus). He wrote a work on augury, the first book of which he dedicated to Cicero. He was also extremely

superstitious, and believed in invocations of the dead. Cicero had a high opinion of his intellectual powers, and considered him a great orator (see Orelli, *Onomasticon Tullianum*).

A full account of all the Claudii will be found in Pauly-Wissowa's *Realencyclopädie der classischen Altertumswissenschaft*, iii. 2 (1899).

CLAUDIUS, MARCUS AURELIUS, surnamed **GOthicus**, Roman emperor A.D. 268–270, belonged to an obscure Illyrian family. On account of his military ability he was placed in command of an army by Decius; and Valerian appointed him general on the Illyrian frontier, and ruler of the provinces of the lower Danube. During the reign of Gallienus, he was called to Italy in order to crush Aureolus; and on the death of the emperor (268) he was chosen as his successor, in accordance, it was said, with his express desire. Shortly after his accession he routed the Alamanni on the Lacus Benacus (some doubt is thrown upon this); in 269 a great victory over the Goths at Naissus in Moesia gained him the title of Gothicus. In the following year he died of the plague at Sirmium, in his fifty-sixth year. He enjoyed great popularity, and appears to have been a man of ability and character.

His life was written by Trebellius Pollio, one of the *Scriptores Historiae Augustae*; see also Zosimus i. 40–43, the histories of Th. Bernhardt and H. Schiller, and special dissertations by A. Duncker on the life of Claudius (1868) and the defeat of the Alamanni (*Annalen des Vereins für nassauische Altertumskunde*, 1879); Homo, *De Claudio Gothico* (1900); Pauly-Wissowa, *Realencyclopädie*, ii. 2458 ff. (Henze).

CLAUDIUS, MATTHIAS (1740–1815), German poet, otherwise known by the *nom de plume* of **ASMUS**, was born on the 15th of August 1740 at Reinfeld, near Lübeck, and studied at Jena. He spent the greater part of his life in the little town of Wandsbeck, near Hamburg, where he earned his first literary reputation by editing from 1771 to 1775, a newspaper called the *Wandsbecker Bote* (*Wandsbeck Messenger*), in which he published a large number of prose essays and poems. They were written in pure and simple German, and appealed to the popular taste; in many there was a vein of extravagant humour or even burlesque, while others were full of quiet meditation and solemn sentiment. In his later days, perhaps through the influence of Klopstock, with whom he had formed an intimate acquaintance, Claudius became strongly pietistic, and the graver side of his nature showed itself. In 1814 he removed to Hamburg, to the house of his son-in-law, the publisher Friedrich Christoph Perthes, where he died on the 21st of January 1815.

Claudius's collected works were published under the title of *Asmus omnia sua secum portans, oder Sämmtliche Werke des Wandsbecker Boten* (8 vols., 1775–1812; 13th edition, by C. Redich, 2 vols., 1902). His biography has been written by Wilhelm Herbst (4th ed., 1878). See also M. Schneiderei, *M. Claudius, seine Weltanschauung und Lebensweisheit* (1898).

CLAUSEL (more correctly **CLAUZEL**), **BERTRAND**, **COUNT** (1772–1842), marshal of France, was born at Mirepoix (Ariège) on the 12th of December 1772, and served in the first campaign of the French Revolutionary Wars as one of the volunteers of 1791. In June 1795, having distinguished himself repeatedly in the war on the northern frontier (1792–1793) and the fighting in the eastern Pyrenees (1793–1794), Clausel was made a general of brigade. In this rank he served in Italy in 1798 and 1799, and in the disastrous campaign of the latter year he won great distinction at the battles of the Trebbia and of Novi. In 1802 he served in the expedition to S. Domingo. He became a general of division in December 1802, and after his return to France he was in almost continuous military employment there until in 1806 he was sent to the army of Naples. Soon after this Napoleon made him a grand officer of the Legion of Honour. In 1808–1809 he was with Marmont in Dalmatia, and at the close of 1809 he was appointed to a command in the army of Portugal under Masséna.

Clausel took part in the Peninsular campaigns of 1810 and 1811, including the Torres Vedras campaign, and under Marmont he did excellent service in re-establishing the discipline, efficiency and mobility of the army, which had suffered severely in the retreat from Torres Vedras. In the Salamanca campaign (1812) the result of Clausel's work was shown in the marching powers

of the French, and at the battle of Salamanca, Clausel, who had succeeded to the command on Marmont-being wounded, and had himself received a severe wound, drew off his army with the greatest skill, the retreat on Burgos being conducted by him in such a way that the pursuers failed to make the slightest impression, and had themselves in the end to retire from the siege of Burgos (1812). Early in 1813 Clausel was made commander of the Army of the North in Spain, but he was unable to avert the great disaster of Vittoria. Under the supreme command of Soult he served through the rest of the Peninsular War with unvarying distinction. On the first restoration in 1814 he submitted unwillingly to the Bourbons, and when Napoleon returned to France, he hastened to join him. During the Hundred Days he was in command of an army defending the Pyrenean frontier. Even after Waterloo he long refused to recognize the restored government, and he escaped to America, being condemned to death in absence. He took the first opportunity of returning to aid the Liberals in France (1820), sat in the chamber of deputies from 1827 to 1830, and after the revolution of 1830 was at once given a military command. At the head of the army of Algiers, Clausel made a successful campaign, but he was soon recalled by the home government, which desired to avoid complications in Algeria. At the same time he was made a marshal of France (February 1831). For some four years thereafter he urged his Algerian policy upon the chamber of deputies, and finally in 1835 was reappointed commander-in-chief. But after several victories, including the taking of Mascara in 1835, the marshal met with a severe repulse at Constantine in 1836. A change of government in France was primarily responsible for the failure, but public opinion attributed it to Clausel, who was recalled in February 1837. He thereupon retired from active service, and, after vigorously defending his conduct before the deputies, he ceased to take part in public affairs. He lived in complete retirement up to his death at Secourriou (Garonne) on the 21st of April 1842.

CLAUSEN, GEORGE (1852—), English painter, was born in London, the son of a decorative artist. He attended the design classes at the South Kensington schools from 1867-1873 with great success. He then worked in the studio of Edwin Long, R.A., and subsequently in Paris under Bouguereau and Robert-Fleury. He became one of the foremost modern painters of landscape and of peasant life, influenced to a certain extent by the impressionists with whom he shared the view that light is the real subject of landscape art. His pictures excel in rendering the appearance of things under flecking outdoor sunlight, or in the shady shelter of a barn or stable. His "Girl at the Gate" was acquired for the nation by the Chantrey Trustees and is now at the National Gallery of British Art (Tate Gallery). He was elected associate of the Royal Academy in 1895, and as professor of painting gave a memorable series of lectures to the students of the schools,—published as *Six Lectures on Painting* (1904) and *Aims and Ideals in Art* (1906).

CLAUSEWITZ, KARL VON (1780-1831), Prussian general and military writer, was born at Burg, near Magdeburg, on the 1st of June 1780. His family, originally Polish, had settled in Germany at the end of the previous century. Entering the army in 1792, he first saw service in the Rhine campaigns of 1793-1794, receiving his commission at the siege of Mainz. On his return to garrison duty he set to work so zealously to remedy the defects in his education caused by his father's poverty, that in 1801 he was admitted to the Berlin Academy for young officers, then directed by Scharnhorst. Scharnhorst, attracted by his pupil's industry and force of character, paid special attention to his training, and profoundly influenced the development of his mind. In 1803, on Scharnhorst's recommendation, Clausewitz was made "adjutant" (aide-de-camp) to Prince August, and he served in this capacity in the campaign of Jena (1806), being captured along with the prince by the French at Prenzlau. A prisoner in France and Switzerland for the next two years, he returned to Prussia in 1809; and for the next three years, as a departmental chief in the ministry of war, as a teacher in the military school, and as military instructor to the crown prince,

he assisted Scharnhorst in the famous reorganization of the Prussian army. In 1810 he married the countess Marie von Brühl.

On the outbreak of the Russian war in 1812, Clausewitz, like many other Prussian officers, took service with his country's nominal enemy. This step he justified in a memorial, published for the first time in the *Leben Gneisenaus* by Pertz (Berlin, 1869). At first adjutant to General Phull, who had himself been a Prussian officer, he served later under Pahlen at Witepsk and Smolensk, and from the final Russian position at Kaluga he was sent to the army of Wittgenstein. It was Clausewitz who negotiated the convention of Taugoggen, which separated the cause of Yorck's Prussians from that of the French, and began the War of Liberation (see YORCK VON WARTENBURG; also Blumenthal's *Die Konvention von Taugoggen*, Berlin, 1901). As a Russian officer he superintended the formation of the *Landwehr* of east Prussia (see STEIN, BARON VOM), and in the campaign of 1813 served as chief of staff to Count Wallmoden. He conducted the fight at Göhrde, and after the armistice, with Gneisenau's permission, published an account of the campaign (*Der Feldzug von 1813 bis zum Waffenstillstand*, Leipzig, 1813). This work was long attributed to Gneisenau himself. After the peace of 1814 Clausewitz re-entered the Prussian service, and in the Waterloo campaign was present at Ligny and Wavre as General Thielmann's chief of staff. This post he retained till 1818, when he was promoted major-general and appointed director of the *Allgemeine Kriegsschule*. Here he remained till in 1830 he was made chief of the 3rd Artillery Inspection at Breslau. Next year he became chief of staff to Field-marshal Gneisenau, who commanded an army of observation on the Polish frontier. After the dissolution of this army Clausewitz returned to his artillery duties; but on the 18th of November 1831 he died at Breslau of cholera, which had proved fatal to his chief also, and a little previously, to his old Russian commander Diebitsch on the other side of the frontier.

His collected works were edited and published by his widow, who was aided by some officers, personal friends of the general, in her task. Of the ten volumes of *Hinterlassene Werke über Krieg und Kriegführung* (Berlin, 1832-1837, later edition called *Clausewitz's Gesammte Werke*, Berlin, 1874) the first three contain Clausewitz's masterpiece, *Vom Kriege*, an exposition of the philosophy of war which is absolutely unrivalled. He produced no "system" of strategy, and his critics styled his work "negative" and asked "Qu'a-t-il fondé?" What he had "founded" was that modern strategy which, by its hold on the Prussian mind, carried the Prussian arms to victory in 1866 and 1870 over the "systematic" strategists Krismánic and Bazaine, and his philosophy of war became, not only in Germany but in many other countries, the essential basis of all serious study of the art of war. The English and French translations (Graham, *On War*, London, 1873; Neuens, *La Guerre*, Paris, 1849-1852; or Vatry, *Théorie de la grande guerre*, Paris, 1899), with the German original, place the work at the disposal of students of most nationalities. The remaining volumes deal with military history: vol. 4, the Italian campaign of 1796-97; vols. 5 and 6, the campaign of 1799 in Switzerland and Italy; vol. 7, the wars of 1812, 1813 to the armistice, and 1814; vol. 8, the Waterloo Campaign; vols. 9 and 10, papers on the campaigns of Gustavus Adolphus, Turenne, Luxemburg, Münnich, John Sobieski, Frederick the Great, Ferdinand of Brunswick, &c. He also wrote *Über das Leben und den Charakter von Scharnhorst* (printed in Ranke's *Historisch-politischer Zeitschrift*, 1832). A manuscript on the catastrophe of 1806 long remained unpublished. It was used by v. Höpfner in his history of that war, and eventually published by the Great General Staff in 1888 (French translation, 1903). Letters from Clausewitz to his wife were published in *Zeitschrift für preussische Landeskunde* (1876). His name is borne by the 28th Field Artillery regiment of the German army.

See Schwartz, *Leben des General von Clausewitz und der Frau Marie von Clausewitz* (2 vols., Berlin, 1877); von Meerheimb, *Karl von Clausewitz* (Berlin, 1875), also *Memoir in Allgemeine deutsche Biographie*; Bernhardt, *Leben des Generals von Clausewitz* (10th Supplement, *Militär. Wochenblatt*, 1878).

CLAUSIUS, RUDOLF JULIUS EMMANUEL (1822-1888), German physicist, was born on the 2nd of January 1822 at Köslin, in Pomerania. After attending the Gymnasium at Stettin, he studied at Berlin University from 1840 to 1844. In 1848 he took his degree at Halle, and in 1850 was appointed professor of physics in the royal artillery and engineering school at Berlin. Late in the same year he delivered his inaugural lecture as *Privatdozent* in the university. In 1855 he became an ordinary professor at Zürich Polytechnic, accepting at the same time a professorship in the university of Zürich. In 1867 he moved to Würzburg as professor of physics, and two years later was appointed to the same chair at Bonn, where he died on the 24th of August 1888. During the Franco-German War he was at the head of an ambulance corps composed of Bonn students, and received the Iron Cross for the services he rendered at Vionville and Gravelotte. The work of Clausius, who was a mathematical rather than an experimental physicist, was concerned with many of the most abstruse problems of molecular physics. By his restatement of Carnot's principle he put the theory of heat on a truer and sounder basis, and he deserves the credit of having made thermodynamics a science; he enunciated the second law, in a paper contributed to the Berlin Academy in 1850, in the well-known form, "Heat cannot of itself pass from a colder to a hotter body." His results he applied to an exhaustive development of the theory of the steam-engine, laying stress in particular on the conception of entropy. The kinetic theory of gases owes much to his labours, Clerk Maxwell calling him its principal founder. It was he who raised it, on the basis of the dynamical theory of heat, to the level of a theory, and he carried out many numerical determinations in connexion with it, e.g. of the mean free path of a molecule. To Clausius also was due an important advance in the theory of electrolysis, and he put forward the idea that molecules in electrolytes are continually interchanging atoms, the electric force not causing, but merely directing, the interchange. This view found little favour until 1887, when it was taken up by S.A. Arrhenius, who made it the basis of the theory of electrolytic dissociation. In addition to many scientific papers he wrote *Die Potentialfunktion und das Potential*, 1864, and *Abhandlungen über die mechanische Wärmetheorie*, 1864-1867.

CLAUSTHAL, or **KLAUSTHAL**, a town of Germany, in the Prussian Harz, lying on a bleak plateau, 1860 ft. above sea-level, 50 m. by rail W.S.W. of Halberstadt. Pop. (1905) 8565. Clausthal is the chief mining town of the Upper Harz Mountains, and practically forms one town with Zellerfeld, which is separated from it by a small stream, the Zellbach. The streets are broad, opportunity for improvement having been given by fires in 1844 and 1854; the houses are mostly of wood. There are an Evangelical and a Roman Catholic church, and a gymnasium. Clausthal has a famous mining college with a mineralogical museum, and a disused mint. Its chief mines are silver and lead, but it also smelts copper and a little gold. Four or five sanatoria are in the neighbourhood. The museum of the Upper Harz is at Zellerfeld.

Clausthal was founded about the middle of the 12th century in consequence probably of the erection of a Benedictine monastery (closed in 1431), remains of which still exist in Zellerfeld. At the beginning of the 16th century the dukes of Brunswick made a new settlement here, and under their directions the mining, which had been begun by the monks, was carried on more energetically. The first church was built at Clausthal in 1570. In 1864 the control of the mines passed into the hands of the state.

CLAVECIN, the French for clavisymbol or harpsichord (Ger. *Clavicymbel* or *Dockenklavier*), an abbreviation of the Flemish *clavisinbal* and Ital. *clavicimbalo*, a keyboard musical instrument in which the strings were plucked by means of a plectrum consisting of a quill mounted upon a jack.

See **PIANOFORTE**; **HARPSICHORD**.

CLAVICEMBALO, or **GRAVICEMBALO** (from Lat. *clavis*, key, and *cymbalum*, cymbal; Eng. clavicymbal, clavisymbol; Flemish, *clavisinbal*; Span. *clavisinbanos*), a keyboard musical instrument with strings plucked by means of small quill or leather

plectra. "Cymbal" (Gr. *κύβαλον*, from *κύβη*, a hollow vessel) was the old European term for the dulcimer, and hence its place in the formation of the word.

See **PIANOFORTE**; **SPINET**; **VIRGINAL**.

CLAVICHORD, or **CLARICHORD** (Fr. *manicorde*; Ger. *Clavichord*; Ital. *manicordo*; Span. *manicordio*), a medieval stringed keyboard instrument, a forerunner of the pianoforte (*q.v.*), its strings being set in vibration by a blow from a brass tangent instead of a hammer as in the modern instrument. The clavichord, derived from the dulcimer by the addition of a keyboard, consisted of a rectangular case, with or without legs, often very elaborately ornamented with paintings and gilding. The earliest instruments were small and portable, being placed upon a table or stand. The strings, of finely drawn brass, steel or iron wire, were stretched almost parallel with the keyboard over the narrow belly or soundboard resting on the soundboard bridges, often three in number, and wound as in the piano round wrest or tuning pins set in a block at the right-hand side of the soundboard and attached at the other end to hitch pins. The bridges served to direct the course of the strings and to conduct the sound waves to the soundboard. The scaling, or division of the strings determining their vibrating length, was effected by the position of the tangents. These tangents, small wedge-shaped blades of brass, beaten out at the top, were inserted in the end of the arm of the keys. As the latter were depressed by the fingers the tangents rose to strike the strings and stop them at the proper length from the belly-bridge. Thus the string was set in vibration between the point of impact and the belly-bridge just as long as the key was pressed down. The key being released, the vibrations were instantly stopped by a list of cloth acting as damper and interwoven among the strings behind the line of the tangents.

There were two kinds of clavichords—the fretted or *gebunden* and the fret-free or *bund-frei*. The term "fretted" was applied to those clavichords which, instead of being provided with a string or set of strings in unison for each note, had one set of strings acting for three or four notes, the arms of the keys being twisted in order to bring the contact of the tangent into the acoustically correct position under the string. The "fret-free" were chromatically-scaled instruments. The first *bund-frei* clavichord is attributed to Daniel Faber of Crailsheim in Saxony about 1720. This important change in construction increased the size of the instrument, each pair of unison strings requiring a key and tangent of its own, and led to the introduction of the system of tuning by equal temperament upheld by J. S. Bach. Clavichords were made with pedals.²

The tone of the clavichord, extremely sweet and delicate, was characterized by a tremulous hesitancy, which formed its great charm while rendering it suitable only for the private music room or study. Between 1883 and 1893 renewed attention was drawn to the instrument by A. J. Hipkins's lectures and recitals on keyboard instruments in London, Oxford and Cambridge; and Arnold Dolmetsch reintroduced the art of making clavichords in 1894. (K. S.)

CLAVICYTHERIUM, a name usually applied to an upright spinet (*q.v.*), the soundboard and strings of which were vertical instead of horizontal, being thus perpendicular to the keyboard; but it would seem that the clavicytherium proper is distinct from the upright spinet in that its strings are placed horizontally. In the early clavicytherium there was, as in the spinet, only one string (of gut) to each key, set in vibration by means of a small quill or leather plectrum mounted on a jack which acted as in the spinet and harpsichord (*q.v.*). The clavicytherium or keyed

¹ The words *clavicorde*, *clavicordo* and *clavicordio*, respectively French, Italian and Spanish, were applied to a different type of instrument, the spinet (*q.v.*).

² See Sebastian Virdung, *Musica getutscht und ausgezogen* (Basel, 1511) (facsimile reprint Berlin, 1882, edited by R. Eitner); J. Verschuere Reynvaan, *Musijkaal Kunst-Woordenboek* (Amsterdam, 1795) (a very scarce book, of which the British Museum does not possess a copy); Jacob Adlung, *Musica Mechanica Organoedi* (Berlin, 1768), vol. ii. pp. 158-9; A. J. Hipkins, *The History of the Pianoforte* (London, 1896), pp. 61 and 62.

cythera or cetra, names which in the 14th and 15th centuries had been applied somewhat indiscriminately to instruments having strings stretched over a soundboard and plucked by fingers or plectrum, was probably of Italian¹ or possibly of south German origin. Sebastian Virdung,² writing early in the 16th century, describes the clavicytherium as a new invention, having gut strings, and gives an illustration of it. (See PIANOFORTE.) A certain amount of uncertainty exists as to its exact construction, due to the extreme rarity of unrestored specimens extant, and to the almost total absence of trustworthy practical information.

In a unique specimen with two keyboards dating from the 16th or 17th century, which is in the collection of Baron Alexandre Kraus,³ what appear to be vibrating strings stretched over a soundboard perpendicular to the keyboard are in reality the wires forming part of the mechanism of the action. The arrangement of this mechanism is the distinctive feature of the clavicytherium, for the wires, unlike the strings of the upright spinet, increase in length from *left to right*, so that the upright harp-shaped back has its higher side over the treble of the keyboard instead of over the bass. The vibrating strings of the clavicytherium in the Kraus Museum are stretched horizontally over two kinds of psalteries fixed one over the other. The first, serving for the lower register, is of the well-known trapezoid shape and lies over the keyboards; it has 30 wire strings in pairs of unisons corresponding to the 15 lowest keys. The second psaltery resembles the kanoun of the Arabs, and has 36 strings in courses of 3 unisons corresponding to the next 12 keys, and 88 very thin strings in courses of 4, completing the 49 keys; the compass thus has a range of four octaves from C to C. The quills of the jacks belonging to the two keyboards are of different length and thickness. The jacks, which work as in the spinet, are attached to the perpendicular wires, disposed in two parallel rows, one for each keyboard.

There is a very fine specimen of the so-called clavicytherium (upright spinet) in the Donaldson museum of the Royal College of Music, London, acquired from the Correr collection at Venice in 1885.⁴ The instrument is undated, but A. J. Hipkins⁵ placed it early in the 16th or even at the end of the 15th century. There is German writing on the inside of the back, referring to some agreement at Ulm. The case is of pine-wood, and the natural keys of box-wood. The jacks have the early steel springs, and in 1885 traces were found in the instrument of original brass plectra, all of which point to a very early date.

A learned Italian, Nicolo Vicentino,⁶ living in the 16th century, describes an *archicembalo* of his own invention, at which the performer had to stand, having four rows of keys designed to obtain a complete mesotonic pure third tuning. This was an attempt to reintroduce the ancient Greek musical system. This instrument was probably an upright harpsichord or clavicebalo.

For the history of the clavicytherium considered as a forerunner of the pianoforte see PIANOFORTE. (K. S.)

CLAVIE, BURNING THE, an ancient Scottish custom still observed at Burghhead, a fishing village on the Moray Firth, near Forres. The "clavie" is a bonfire of casks split in two, lighted on the 12th of January, corresponding to the New Year of the old calendar. One of these casks is joined together again by a huge nail (Lat. *clavus*; hence the term). It is then filled with tar, lighted and carried flaming round the village and finally up to a headland upon which stands the ruins of a Roman altar, locally called "the Douro." It here forms the nucleus of the bonfire, which is built up of split casks. When the burning tar-barrel falls in pieces, the people scramble to get a lighted

¹ Mersenne, *Harmonie universelle* (Paris, 1636), p. 113, calls the clavicytherium "une nouvelle forme d'épinette dont on use en Italie," and states that the action of the jacks and levers is parallel from back to front.

² *Musica getuscht und ausgezogen* (Basel, 1511).

³ See "Une Pièce unique du Musée Kraus de Florence" in *Annales de l'Alliance scientifique universelle* (Paris, 1907).

⁴ See illustration by William Gibb in A. J. Hipkins's *Musical Instruments, Historic, Rare and Unique* (1888).

⁵ *History of the Pianoforte*, Novello's Music Primers, No. 52 (1896), p. 75.

⁶ *L'Antica Musica ridotta moderna pratica* (Rome, 1555).

piece with which to kindle the New Year's fire on their cottage hearth. The charcoal of the clavie is collected and is put in pieces up the cottage chimneys, to keep spirits and witches from coming down.

CLAVIÈRE, ÉTIENNE (1735-1793), French financier and politician, was a native of Geneva. As one of the democratic leaders there he was obliged in 1782 to take refuge in England, upon the armed interference of France, Sardinia and Berne in favour of the aristocratic party. There he met other Swiss, among them Marat and Étienne Dumont, but their schemes for a new Geneva in Ireland—which the government favoured—were given up when Necker came to power in France, and Clavière, with most of his comrades, went to Paris. There in 1789 he and Dumont allied themselves with Mirabeau, secretly collaborating for him on the *Courrier de Provence* and also in preparing the speeches which Mirabeau delivered as his own. It was mainly by his use of Clavière that Mirabeau sustained his reputation as a financier. But Clavière also published some pamphlets under his own name, and through these and his friendship with J. P. Brissot, whom he had met in London, he became minister of finance in the Girondist ministry, from March to the 12th of June 1792. After the 10th of August he was again given charge of the finances in the provisional executive council, though with but indifferent success. He shared in the fall of the Girondists, was arrested on the 2nd of June 1793, but somehow was left in prison until the 8th of December, when, on receiving notice that he was to appear on the next day before the Revolutionary Tribunal, he committed suicide.

CLAVIJO, RUY GONZALEZ DE (d. 1412), Spanish traveller of the 15th century, whose narrative is the first important one of its kind contributed to Spanish literature, was a native of Madrid, and belonged to a family of some antiquity and position. On the return of the ambassadors Pelayo de Sotomayor and Hernan Sanchez de Palazuelos from the court of Timur, Henry III. of Castille determined to send another embassy to the new lord of Western Asia, and for this purpose he selected Clavijo, Gomez de Salazar (who died on the outward journey), and a master of theology named Fray Alonzo Paez de Santa Maria. They sailed from St Mary Port near Cadiz on the 22nd of May 1403, touched at the Balearic Isles, Gaeta and Rhodes, spent some time at Constantinople, sailed along the southern coast of the Black Sea to Trebizond, and proceeded inland by Erzerum, the Ararat region, Tabriz, Sultanieh, Teheran and Meshed, to Samarkand, where they were well received by the conqueror. Their return was at last accomplished, in part after Timur's death, and with countless difficulties and dangers, and they landed in Spain on the 1st of March 1406. Clavijo proceeded at once to the court, at that time in Alcalá de Henares, and served as chamberlain till the king's death (in the spring of 1406-1407); he then returned to Madrid, and lived there in opulence till his own death on the 2nd of April 1412. He was buried in the chapel of the monastery of St Francis, which he had rebuilt at great expense.

There are two leading MSS. of Clavijo's narrative—(a) London, British Museum, Additional MSS., 16,613 fols. 1, n.-125, v.; (b) Madrid, National Library, 9218; and two old editions of the original Spanish—(1) by Gonçalo Argote de Molina (Seville, 1582), (2) by Antonio de Sancha (Madrid, 1782), both having the misleading titles, apparently invented by Molina, of *Historia del gran Tamorlan*, and *Vida y hazañas del gran Tamorlan* (the latter at the beginning of the text itself); a better sub-title is added, viz. *Itinerario y enarracion del viage y relacion de la embaxada que Ruy Gonzalez de Clavijo le hizo*. Both editors, and especially Sancha, supply general explanatory dissertations. The Spanish text has also been published, with a Russian translation, in vol. xxviii. (pp. 1-455) of the *Publications of the Russian Imperial Academy of Sciences (Section of Russian Language, &c.)*, edited by I. I. Sreznevski (1881). An English version, by Sir Clements Markham, was issued by the Hakluyt Society in 1859 (*Narrative of the Embassy of R... G... de Clavijo to the Court of Timour*). The identification of a great number of the places mentioned by Clavijo is a matter of considerable difficulty, and has given rise to some discussion (see Khanikof's list in *Geographical Magazine* (1874), and Sreznevski's *Annotated Index* in the Russian edition of 1881). A short account of Clavijo's life is given by Alvarez y Baena in the *Hijos de Madrid*, vol. ix. See also C. R. Beazley, *Dawn of Modern Geography*, iii. 332-56.

CLAVIJO Y FAJARDO, JOSÉ (1730–1806), Spanish publicist, was born at Lanzarote (Canary Islands) in 1730. He settled in Madrid, became editor of *El Pensador*, and by his campaign against the public performance of *autos sacramentales* secured their prohibition in 1765. In 1770 he was appointed director of the royal theatres, a post which he resigned in order to take up the editorship of the *Mercurio histórico y político de Madrid*: at the time of his death in 1806 he was secretary to the Cabinet of Natural History. He had in abundance the courage, perseverance and gift of pungent expression which form the equipment of the aggressive journalist, but his work would long since have been forgotten were it not that it put an end to a peculiarly national form of dramatic exposition, and that his love affair with one of Beaumarchais' sisters suggested the theme of Goethe's first publication, *Clavigo*.

CLAY, CASSIUS MARCELLUS (1810–1903), American politician, was born in Madison county, Kentucky, on the 19th of October 1810. He was the son of Green Clay (1757–1826), a Kentucky soldier of the war of 1812 and a relative of Henry Clay. He was educated at Centre College, Danville, Kentucky, and at Yale, where he graduated in 1832. Influenced to some extent by William Lloyd Garrison, he became an advocate of the abolition of slavery, and on his return to his native state, at the risk of social and political ostracism, he gave utterance to his belief. He studied law, but instead of practising devoted himself to a political career. In 1835, 1837 and 1840 he was elected as a Whig to the Kentucky legislature, where he advocated a system of gradual emancipation, and secured the establishment of a public school system, and a much-needed reform in the jury system. In 1841 he was defeated on account of his abolition views. In 1844 he delivered campaign speeches for Henry Clay throughout the North. In 1845 he established, at Lexington, Kentucky, an anti-slavery publication known as *The True American*, but in the same year his office and press were wrecked by a mob, and he removed the publication office to Cincinnati, Ohio. During this and the earlier period of his career his zeal and hot temper involved him in numerous personal encounters and several duels, in all of which he bore himself with a reckless bravery. In the Mexican War he served as a captain of a Kentucky company of militia, and was taken prisoner, while reconnoitring, during General Scott's advance on the City of Mexico. He left the Whig party in 1850, and as an anti-slavery candidate for governor of Kentucky polled 5000 votes. In 1856 he joined the Republican party, and wielded considerable influence as a Southern representative in its councils. In 1860 he was a leading candidate for the vice-presidential nomination. In 1861 he was sent by President Lincoln as minister to Russia; in 1862 he returned to America to accept a commission as major-general of volunteers, but in March 1863 was reappointed to his former post at St Petersburg, where he remained until 1869. Disapproving of the Republican policy of reconstruction, he left the party, and in 1872 was one of the organizers of the Liberal-Republican revolt, and was largely instrumental in securing the nomination of Horace Greeley for the presidency. In the political campaigns of 1876 and 1880 he supported the Democratic candidate, but rejoined the Republican party in the campaign of 1884. He died at Whitehall, Kentucky, on the 22nd of July 1903.

See his autobiography, *The Life, Memoirs, Writings, and Speeches of Cassius Marcellus Clay* (Cincinnati, 1896); and *The Writings of Cassius Marcellus Clay* (edited with a "Memoir" by Horace Greeley. New York, 1848).

CLAY, CHARLES (1801–1893), English surgeon, was born at Bredbury, near Stockport, on the 27th of December 1801. He began his medical education as a pupil of Kinder Wood in Manchester (where he used to attend John Dalton's lectures on chemistry), and in 1821 went to Edinburgh to continue his studies there. Qualifying in 1823, he began a general practice in Ashton-under-Lyne, but in 1839 removed to Manchester to practise as an operative and consulting surgeon. It was there that, in 1842, he first performed the operation of ovariectomy with which his name is associated. On this occasion it was

perfectly successful, and when in 1865 he published an analysis of 111 cases he was able to show a mortality only slightly above 30%. Although his merits in this matter have sometimes been denied, his claim to the title "Father of Ovariectomy" is now generally conceded, and it is admitted that he deserves the credit not only of having shown how that operation could be made a success, but also of having played an important part in the advance of abdominal surgery for which the 19th century was conspicuous. In spite of the claims of a heavy practice, Clay found time for the pursuit of geology and archaeology. Among the books of which he was the author were a volume of *Geological Sketches of Manchester* (1839) and a *History of the Currency of the Isle of Man* (1849), and his collections included over a thousand editions of the Old and New Testaments and a remarkably complete series of the silver and copper coins of the United States. He died at Poulton-le-Fylde, near Preston, on the 19th of September 1893.

CLAY, FREDERIC (1838–1889), English musical composer, the son of James Clay, M.P., who was celebrated as a player of whist and a writer on that subject, was born in Paris on the 3rd of August 1838. He studied music under W. B. Molique in Paris and Moritz Hauptmann at Leipzig. With the exception of a few songs and two cantatas, *The Knights of the Cross* (1866) and *Lalla Rookh* (1877),—the latter of which contained his well-known song "I'll sing thee songs of Araby,"—his compositions were all written for the stage. Clay's first public appearance was made with an opera entitled *Court and Cottage*, the libretto of which was written by Tom Taylor. This was produced at Covent Garden in 1862, and was followed by *Constance* (1865), *Ages Ago* (1869), and *Princess Toto* (1875), to name only three of many works which have long since been forgotten. The last two, which were written to libretti by W. S. Gilbert, are among Clay's most tuneful and most attractive works. He wrote part of the music for *Babil and Bijou* (1872) and *The Black Crook* (1873), both of which were produced at the Alhambra. He also furnished incidental music for a revival of *Twelfth Night* and for the production of James Albery's *Oriana*. His last works, *The Merry Duchess* (1883) and *The Golden Ring* (1883), the latter written for the reopening of the Alhambra, which had been burned to the ground the year before, showed an advance upon his previous work, and rendered all the more regrettable the stroke of paralysis which crippled his physical and mental energies during the last few years of his life. He died at Great Marlow on the 24th of November 1889.

CLAY, HENRY (1777–1852), American statesman and orator, was born in Hanover county, Virginia, on the 12th of April 1777, and died in Washington on the 29th of June 1852. Few public characters in the United States have been the subject of more heated controversy. His enemies denounced him as a pretender, a selfish intriguer, and an abandoned profligate; his supporters placed him among the sages and sometimes even among the saints. He was an arranger of measures and leader of political forces, not an originator of ideas and systems. His public life covered nearly half a century, and his name and fame rest entirely upon his own merits. He achieved his success despite serious obstacles. He was tall, rawboned and awkward; his early instruction was scant; but he "read books," talked well, and so, after his admission to the bar at Richmond, Virginia, in 1797, and his removal next year to Lexington, Kentucky, he quickly acquired a reputation and a lucrative income from his law practice.

Thereafter, until the end of life, and in a field where he met, as either friend or foe, John Quincy Adams, Gallatin, Madison, Monroe, Webster, Jackson, Calhoun, Randolph and Benton, his political activity was wellnigh ceaseless. At the age of twenty-two (1799), he was elected to a constitutional convention in Kentucky; at twenty-six, to the Kentucky legislature; at twenty-nine, while yet under the age limit of the United States constitution, he was appointed to an unexpired term (1806–1807) in the United States Senate, where, contrary to custom, he at once plunged into business, as though he had been there all his life. He again served in the Kentucky legislature

(1808-1809), was chosen speaker of its lower house, and achieved distinction by preventing an intense and widespread anti-British feeling from excluding the common law from the Kentucky code. A year later he was elected to another unexpired term in the United States Senate, serving in 1810-1811. At thirty-four (1811) he was elected to the United States House of Representatives and chosen speaker on the first day of the session. One of the chief sources of his popularity was his activity in Congress in promoting the war with Great Britain in 1812, while as one of the peace commissioners he reluctantly signed the treaty of Ghent on the 24th of December 1814. During the fourteen years following his first election, he was re-elected five times to the House and to the speakership; retiring for one term (1821-1823) to resume his law practice and retrieve his fortunes. He thus served as speaker in 1811-1814, in 1815-1820 and in 1823-1825. Once he was unanimously elected by his constituents, and once nearly defeated for having at the previous session voted to increase congressional salaries. He was a warm friend of the Spanish-American revolutionists (1818) and of the Greek insurgents (1824). From 1825 to 1829 he served as secretary of state in President John Quincy Adams's cabinet, and in 1831 he was elected to the United States Senate, where he served until 1842, and again from 1849 until his death.

From the beginning of his career he was in favour of internal improvements as a means of opening up the fertile but inaccessible West, and was opposed to the abuse of official patronage known as "the spoils system." The most important of the national questions with which Clay was associated, however, were the various phases of slavery politics and protection to home industries. The most prominent characteristics of his public life were his predisposition to "compromises" and "pacifications" which generally failed of their object, and his passionate patriotic devotion to the Union.

His earliest championship of protection was a resolution introduced by him in the Kentucky legislature (1808) which favoured the wearing by its members of home-made clothes; and one in the United States Senate (April 1810), on behalf of home-grown and home-made supplies for the United States navy, but only to the point of making the nation independent of foreign supply. In 1816 he advocated the Dallas tariff, in which the duties ranged up to 35% on articles of home production, the supply of which could satisfy the home demand; the avowed purpose being to build up certain industries for safety in time of war. In 1824 he advocated high duties to relieve the prevailing distress, which he pictured in a brilliant and effective speech. Although the distress was caused by the reactionary effect of a disordered currency and the inflated prices of the war of 1812, he ascribed it to the country's dependence on foreign supply and foreign markets. Great Britain, he said, was a shining example of the wisdom of a high tariff. No nation ever flourished without one. He closed his principal speech on the subject in the House of Representatives with a glowing appeal in behalf of what he called "The American System." In spite of the opposition of Webster and other prominent statesmen, Clay succeeded in enacting a tariff which the people of the Southern states denounced as a "tariff of abominations." As it overswelled the revenue, in 1832 he vigorously favoured reducing tariff rates on all articles not competing with American products. His speech in behalf of the measure was for years a protection text-book; but the measure itself reduced the revenue so little and provoked such serious threats of nullification and secession in South Carolina, that, to prevent bloodshed and to forestall a free trade measure from the next Congress, Clay brought forward in 1833 a compromise gradually reducing the tariff rates to an average of 20%. To the Protectionists this was "like a crash of thunder in winter"; but it was received with such favour by the country generally, that its author was hailed as "The Great Pacificator," as he had been thirteen years before at the time of the Missouri Compromise (see below). As, however, the discontent with the tariff in the South was only a symptom of the real trouble there—the sensitiveness of the slave-power,—Clay

subsequently confessed his serious doubts of the policy of his interference.

He was only twenty-two, when, as an opponent of slavery, he vainly urged an emancipation clause for the new constitution of Kentucky, and he never ceased regretting that its failure put his state, in improvements and progress, behind its free neighbours. In 1820 he congratulated the new South American republics on having abolished slavery, but the same year the threats of the Southern states to destroy the Union led him to advocate the "Missouri Compromise," which, while keeping slavery out of all the rest of the territory acquired by the "Louisiana Purchase" north of Missouri's southern boundary line, permitted it in that state. Then, greeted with the title of "The Great Pacificator" as a reward for his success, he retired temporarily to private life, with a larger stock of popularity than he had ever had before. Although at various times he had helped to strengthen the law for the recovery of fugitive slaves, declining as secretary of state to aid Great Britain in the further suppression of the slave trade, and demanding the return of fugitives from Canada, yet he heartily supported the colonizing of the slaves in Africa, because slavery was the "deepest stain upon the character of the country," opposition to which could not be repressed except by "blowing out the moral lights around," and "eradicating from the human soul the light of reason and the law of liberty." When the slave power became more aggressive, in and after the year 1831, Clay defended the right of petition for the abolition of slavery in the District of Columbia, and opposed Calhoun's bill forbidding the use of the mails to "abolition" newspapers and documents. He was lukewarm toward recognizing the independence of Texas, lest it should aid the increase of slave territory, and generally favoured the freedom of speech and press as regards the question of slavery; yet his various concessions and compromises resulted, as he himself declared, in the abolitionists denouncing him as a slaveholder, and the slaveholders as an abolitionist. In 1839, only twelve months after opposing the pro-slavery demands, he prepared an elaborate speech, in order "to set himself right with the South," which, before its delivery, received pro-slavery approval. While affirming that he was "no friend of slavery" he held abolition and the abolitionists responsible for the hatred, strife, disruption and carnage that menaced the nation. In response, Calhoun extended to him a most hearty welcome, and assigned him to a place on the bench of the penitents. Being a candidate for the presidency Clay had to take the insult without wincing. It was in reference to this speech that he made the oft-quoted remark that he "would rather be right than be president." While a candidate for president in 1844, he opposed in the "Raleigh letter" the annexation of Texas on many grounds except that of its increasing the slave power, thus displeasing both the men of anti-slavery and those of pro-slavery sentiments. In 1847, after the conquest of Mexico, he made a speech against the annexation of that country or the acquiring of any foreign territory for the spread of slavery. Although in 1849 he again vainly proposed emancipation in Kentucky, he was unanimously elected to the United States Senate, where in 1850 he temporarily pacified both sections of the country by successfully offering, for the sake of the "peace, concord and harmony of these states," a measure or series of measures that became known as the "Compromise of 1850." It admitted California as a free state, organized Utah and New Mexico as Territories without reference to slavery, and enacted a more efficient fugitive slave law. In spite of great physical weakness he made several earnest speeches in behalf of these measures to save the Union.

Another conspicuous feature of Clay's public career was his absorbing and rightful, but constantly ungratified, ambition to be president of the United States. His name in connexion therewith was mentioned comparatively early, and in 1824, with W. H. Crawford, Andrew Jackson, and John Quincy Adams, he was a candidate for that office. There being no choice by the people, and the House of Representatives having elected Adams, Clay was accused by Jackson and his friends of making a corrupt bargain whereby, in payment of his vote and influence

for Adams, he was appointed secretary of state. This made Jackson Clay's lifelong enemy, and ever after kept Clay busy explaining and denying the allegation. In 1832 Clay was unanimously nominated for the presidency by the National Republicans; Jackson, by the Democrats. The main issue was the policy of continuing the United States Bank, which in 1811 Clay had opposed, but in 1816 and always subsequently warmly favoured. A majority of the voters approved of Jackson's fight against what Clay had once denounced as a dangerous and unconstitutional monopoly. Clay made the mistake of supposing that he could arouse popular enthusiasm for a moneyed corporation in its contest with the great military "hero of New Orleans." In 1839 he was a candidate for the Whig nomination, but by a secret ballot his enemies defeated him in the party convention, held in December of that year, and nominated William Henry Harrison. The result threw Clay into paroxysms of rage, and he violently complained that his friends always used him as their candidate when he was sure to be defeated, and betrayed him when he or any one could have been elected. In 1844 he was nominated by the Whigs against James K. Polk, the Democratic candidate. By an audacious fraud that represented him as an enemy, and Polk as a friend of protection, Clay lost the vote of Pennsylvania; and he lost the vote of New York by his own letter abating the force of his previous opposition to the annexation of Texas. Even his enemies felt that his defeat by Polk was almost a national calamity. In 1848, Zachary Taylor, a Mexican War hero, and hardly even a convert to the Whig party, defeated Clay for the nomination, Kentucky herself deserting her "favourite son."

Clay's quick intelligence and sympathy, and his irreproachable conduct in youth, explain his precocious prominence in public affairs. In his persuasiveness as an orator and his charming personality lay the secret of his power. He had early trained himself in the art of speech-making, in the forest, the field and even the barn, with horse and ox for audience. By contemporaries his voice was declared to be the finest musical instrument that they ever heard. His eloquence was in turn majestic, fierce, playful, insinuating; his gesticulation natural, vivid, large, powerful. In public he was of magnificent bearing, possessing the true oratorical temperament, the nervous exaltation that makes the orator feel and appear a superior being, transfusing his thought, passion and will into the mind and heart of the listener; but his imagination frequently ran away with his understanding, while his imperious temper and ardent combativeness hurried him and his party into disadvantageous positions. The ease, too, with which he outshone men of vastly greater learning lured him from the task of intense and arduous study. His speeches were characterized by skill of statement, ingenious grouping of facts, fervent diction, and ardent patriotism; sometimes by biting sarcasm, but also by superficial research, half-knowledge and an unwillingness to reason a proposition to its logical results. In private, his never-failing courtesy, his agreeable manners and a noble and generous heart for all who needed protection against the powerful or the lawless, endeared him to hosts of friends. His popularity was as great and as inexhaustible among his neighbours as among his fellow-citizens generally. He pronounced upon himself a just judgment when he wrote: "If any one desires to know the leading and paramount object of my public life, the preservation of this Union will furnish him the key."

See Calvin Colton, *The Works of Henry Clay* (6 vols., New York, 1857; new ed., 7 vols., New York, 1898), the first three volumes of which are an account of Clay's "Life and Times"; Carl Schurz, *Henry Clay* (2 vols., Boston, 1887), in the "American Statesmen" series; and the life by T. Hart Clay (1910). (C. S.)

CLAY (from O. Eng. *clæg*, a word common in various forms to Teutonic languages, cf. Ger. *Klei*), commonly defined as a fine-grained, almost impalpable substance, very soft, more or less coherent when dry, plastic and retentive of water when wet; it has an "earthy" odour when breathed upon or moistened, and consists essentially of hydrous aluminium silicate with various impurities. Of clay are formed a great number of rocks, which collectively are known as "clay-rocks" or "pelitic rocks"

(from Gr. *πηλός*, clay), e.g. mudstone, shale, slate: these exhibit in greater or less perfection the properties above described according to their freedom from impurities. In nature, clays are rarely free from foreign ingredients, many of which can be detected with the unaided eye, while others may be observed by means of the microscope. The commonest impurities are:—(1) organic matter, humus, &c. (exemplified by clay-soils with an admixture of peat, oil shales, carbonaceous shales); (2) fossils (such as plants in the shales of the Lias and Coal Measures, shells in clays of all geological periods and in fresh water marls); (3) carbonate of lime (rarely altogether absent, but abundant in marls, cement-stones and argillaceous limestones); (4) sulphide of iron, as pyrite or marcasite (when finely diffused, giving the clay a dark grey-blue colour, which weathers to brown—e.g. London Clay; also as nodules and concretions, e.g. Gault); (5) oxides of iron (staining the clay bright red when ferric oxide, red ochre; yellow when hydrous, e.g. yellow ochre); (6) sand or detrital silica (forming loams, arenaceous clays, argillaceous sandstones, &c.). Less frequently present are the following:—rock salt (Triassic clays, and marls of Cheshire, &c.); gypsum (London Clay, Triassic clays); dolomite, phosphate of lime, vivianite (phosphate of iron), oxides of manganese, copper ores (e.g. *Kupferschiefer*), wavellite and amber. As the impurities increase in amount the clay rocks pass gradually into argillaceous sands and sandstones, argillaceous limestones and dolomites, shaly coals and clay ironstones.

Natural clays, even when most pure, show a considerable range of composition, and hence cannot be regarded as consisting of a single mineral; clay is a *rock*, and has that variability which characterizes all rocks. Of the essential properties of clay some are merely physical, and depend on the minute size of the particles. If any rock be taken (even a piece of pure quartz) and crushed to a very fine powder, it will show some of the peculiarities of clays; for example, it will be plastic, retentive of moisture, impermeable to water, and will shrink to some extent if the moist mass be kneaded, and then allowed to dry. It happens, however, that many rocks are not disintegrated to this extreme degree by natural processes, and weathering invariably accompanies disintegration. Quartz, for example, has little or no cleavage, and is not attacked by the atmosphere. It breaks up into fragments, which become rounded by attrition, but after they reach a certain minuteness are borne along by currents of water or air in a state of suspension, and are not further reduced in size. Hence sands are more coarse grained than clays. A great number of rock-forming minerals, however, possess a good cleavage, so that when bruised they split into thin fragments; many of these minerals decompose somewhat readily, yielding secondary minerals, which are comparatively soft and have a scaly character, with eminently perfect cleavages, which facilitate splitting into exceedingly thin plates. The principal substances of this description are kaolin, muscovite and chlorite. Kaolin and muscovite are formed principally after feldspar (and the feldspars are the commonest minerals of all crystalline rocks); also from nepheline, leucite, scapolite and a variety of other rock-forming minerals. Chlorite arises from biotite, augite and hornblende. Serpentine, which may be fibrous or scaly, is a secondary product of olivine and certain pyroxenes. Clays consist essentially of the above ingredients (although serpentine is not known to take part in them to any extent, it is closely allied to chlorite). At the same time other substances are produced as decomposition goes on. They are principally finely divided quartz, epidote, zoisite, rutile, limonite, calcite, pyrites, and very small particles of these are rarely absent from natural clays. These fine-grained materials are at first mixed with broken and more or less weathered rock fragments and coarser mineral particles in the soil and subsoil, but by the action of wind and rain they are swept away and deposited in distant situations. "Loess" is a fine calcareous clay, which has been wind-borne, and subsequently laid down on the margins of dry steppes and deserts. Most clays are water-borne, having been carried from the surface of the land by

rain and transported by the brooks and rivers into lakes or the sea. In this state the fine particles are known as "mud." They are deposited where the currents are checked and the water becomes very still. If temporarily laid down in other situations they are ultimately lifted again and removed. A little clay, stirred up with water in a glass vessel, takes hours to settle, and even after two or three days some remains in suspension; in fact, it has been suggested that in such cases the clay forms a sort of "colloidal solution" in the water. Traces of dissolved salts, such as common salt, gypsum or alum, greatly accelerate deposition. For these reasons the principal gathering places of fine pure clays are deep, still lakes, and the sea bottom at considerable distances from the shore. The coarser materials settle nearer the land, and the shallower portions of the sea floor are strewn with gravel and sand, except in occasional depressions and near the mouths of rivers where mud may gather. Farther out the great mud deposits begin, extending from 50 to 200 m. from the land, according to the amount of sediment brought in, and the rate at which the water deepens. A girdle of mud accumulations encircles all the continents. These sediments are fine and tenacious; their principal components, in addition to clay, being small grains of quartz, zircon, tourmaline, hornblende, feldspar and iron compounds. Their typical colour is blackish-blue, owing to the abundance of sulphuretted hydrogen; when fresh they have a sulphurous odour, when weathered they are brown, as their iron is present as hydrous oxides (limonite, &c.). These deposits are tenanted by numerous forms of marine life, and the sulphur they contain is derived from decomposing organic matter. Occasionally water-logged plant debris is mingled with the mud. In a few places a red colour prevails, the iron being mostly oxidized; elsewhere the muds are green owing to abundant glauconite. Traced landwards the muds become more sandy, while on their outer margins they grade into the abysmal deposits, such as the globigerina ooze (see OCEAN AND OCEANOGRAPHY). Near volcanoes they contain many volcanic minerals, and around coral islands they are often in large part calcareous.

Microscopic sections of some of the more coherent clays and shales may be prepared by saturating them with Canada balsam by long boiling, and slicing the resultant mass in the same manner as one of the harder rocks. They show that clay rocks contain abundant very small grains of quartz (about 0.01 to 0.05 mm. in diameter), with often feldspar, tourmaline, zircon, epidote, rutile and more or less calcite. These may form more than one-third of an ordinary shale; the greater part, however, consists of still smaller scales of other minerals (0.01 mm. in diameter and less than this). Some of these are recognizable as pale yellowish and white mica; others seem to be chlorite, the remainder is perhaps kaolin, but, owing to the minute size of the flakes, they yield very indistinct reactions to polarized light. They are also often stained with iron oxide and organic substances, and in consequence their true nature is almost impossible to determine. It is certain, however, that the finer-grained rocks are richest in alumina, and in combined water; hence the inference is clear that kaolin or some other hydrous aluminium silicate is the dominating constituent. These results are confirmed by the mechanical analysis of clays. This process consists in finely pulverizing the soil or rock, and levigating it in vessels of water. A series of powders is obtained progressively finer according to the time required to settle to the bottom of the vessel. The clay is held to include those particles which have less than 0.005 mm. diameter, and contains a higher percentage of alumina than any of the other ingredients.

As might be inferred from the differences they exhibit in other respects, clay rocks vary greatly in their chemical composition. Some of them contain much iron (yellow, blue and red clays); others contain abundant calcium carbonate (calcareous clays and marls). Pure clays, however, may be found almost quite free from these substances. Their silica ranges from about 60 to 45%, varying in accordance with the amount of quartz and alkali-feldspar present. It is almost always more than would be the case if the rock consisted of kaolin mixed with muscovite.

Alumina is high in the finer clays (18 to 30%), and they are the most aluminous of all sediments, except bauxite. Magnesia is never absent, though its amount may be less than 1%; it is usually contained in minerals of the chlorite group, but partly also in dolomite. The alkalis are very interesting; often they form 5 or 10% of the whole rock; they indicate abundance of white micas or of undecomposed particles of feldspar. Some clays, however, such as fireclays, contain very little potash or soda, while they are rich in alumina; and it is a fair inference that hydrated aluminous silicates, such as kaolin, are well represented in these rocks. There are, in fact, a few clays which contain about 45% of alumina, that is to say, more than in pure kaolin. It is probable that these are related to bauxite and certain kinds of laterite.

A few of the most important clay rocks, such as china-clay, brick-clay, red-clay and shale, may be briefly described here.

China-clay is white, friable and earthy. It occurs in regions of granite, porphyry and syenite, and usually occupies funnel-shaped cavities of no great superficial area, but of considerable depth. It consists of very fine scaly kaolin, larger, shining plates of white mica, grains of quartz and particles of semi-decomposed feldspar, tourmaline, zircon and other minerals, which originally formed part of the granite. These clays are produced by the decomposition of the granite by acid vapours, which are discharged after the igneous rock has solidified ("fumarole or pneumatolytic action"). Fluorine and its compounds are often supposed to have been among the agencies which produce this change, but more probably carbonic acid played the principal rôle. The feldspar decomposes into kaolin and quartz; its alkalis are for the most part set free and removed in solution, but are partly retained in the white mica which is constantly found in crude china-clays. Semi-decomposed varieties of the granite are known as china-stone. The kaolin may be washed away from its original site, and deposited in hollows or lakes to form beds of white clay, such as pipe-clay; in this case it is always more or less impure. Yellow and pinkish varieties of china-clay and pipe-clay contain a small quantity of oxide of iron. The best known localities for china-clay are Cornwall, Limoges (France), Saxony, Bohemia and China; it is found also in Pennsylvania, N. Carolina and elsewhere in the United States.

Fire-clays include all those varieties of clay which are very refractory to heat. They must contain little alkalis, lime, magnesia and iron, but some of them are comparatively rich in silica. Many of the clays which pass under this designation belong to the Carboniferous period, and are found underlying seams of coal. Either by rapid growth of vegetation, or by subsequent percolation of organic solutions, most of the alkalis and the lime have been carried away.

Any argillaceous material, which can be used for the manufacture of bricks, may be called a *brick-clay*. In England, Kimmeridge Clay, Lias clays, London Clay and pulverized shale and slate are all employed for this purpose. Each variety needs special treatment according to its properties. The true brick-clays, however, are superficial deposits of Pleistocene or Quaternary age, and occur in hollows, filled-up lakes and deserted stream channels. Many of them are derived from the glacial boulder-clays, or from the washing away of the finer materials contained in older clay formations. They are always very impure.

The *red-clay* is an abysmal formation, occurring in the sea bottom in the deepest part of the oceans. It is estimated to cover over fifty millions of square miles, and is probably the most extensive deposit which is in course of accumulation at the present day. In addition to the reddish or brownish argillaceous matrix it contains fresh or decomposed crystals of volcanic minerals, such as feldspar, augite, hornblende, olivine and pumiceous or palagonitic rocks. These must either have been ejected by submarine volcanoes or drifted by the wind from active vents, as the fine ash discharged by Krakatoa was wafted over the whole globe. Larger rounded lumps of pumice, found in the clay, have probably floated to their present situations, and sank when decomposed, all their cavities becoming filled

with sea water. Crystals of zeolites (phillipsite) form in the red-clay as radiate, nodular groups. Lumps of manganese oxide, with a black, shining outer surface, are also characteristic of this deposit, and frequently encrust pieces of pumice or animal remains. The only fossils of the clay are radiolaria, sharks' teeth and the ear-bones of whales, precisely those parts of the skeleton of marine creatures which are hardest and can longest survive exposure to sea-water. Their comparative abundance shows how slowly the clay gathers. Small rounded spherules of iron, believed by some to be meteoric dust, have also been obtained in some numbers. Among the rocks of the continents nothing exactly the same as this remarkable deposit is known to occur, though fine dark clays, with manganese nodules, are found in many localities, accompanied by other rocks which indicate deep-water conditions of deposit.

Another type of red-clay is found in caves, and is known as *cave-earth* or *red-earth* (*terra rossa*). It is fine, tenacious and bright red, and represents the insoluble and thoroughly weathered impurities which are left behind when the calcareous matter is removed in solution by carbonated waters. Similar residual clays sometimes occur on the surface of areas of limestone in hollows and fissures formed by weathering.

Boulder-clay is a coarse unstratified deposit of fine clay, with more or less sand, and boulders of various sizes, the latter usually marked with glacial striations.

Some clay rocks which have been laid down by water are very uniform through their whole thickness, and are called *mud-stones*. Others split readily into fine leaflets or laminae parallel to their bedding, and this structure is accentuated by the presence of films of other materials, such as sand or vegetable débris. Laminated clays of this sort are generally known as *shales*; they occur in many formations but are very common in the Carboniferous. Some of them contain much organic débris, and when distilled yield paraffin oil, wax, compounds of ammonia, &c. In these oil-shales there are clear, globular, yellow bodies which seem to be resinous. It has been suggested that the admixture of large quantities of decomposed freshwater algae among the original mud is the origin of the paraffins. In New South Wales, Scotland and several parts of America such oil-shales are worked on a commercial scale. Many shales contain great numbers of ovoid or rounded septarian nodules of clay ironstone. Others are rich in pyrites, which, on oxidation, produces sulphuric acid; this attacks the aluminous silicates of the clay and forms aluminium sulphate (*alum shales*). The lias shales of Whitby contain blocks of semi-mineralized wood, or jet, which is black with a resinous lustre, and a fibrous structure. The laminated structure of shales, though partly due to successive very thin sheets of deposit, is certainly dependent also on the vertical pressure exerted by masses of superincumbent rock; it indicates a transition to the fissile character of clay slates.

(J. S. F.)

CLAY CROSS, an urban district in the Chesterfield parliamentary division of Derbyshire, England, near the river Amber, on the Midland railway, 5 m. S. of Chesterfield. Pop. (1901) 8358. The Clay Cross Colliery and Ironworks Company, whose mines were for a time leased by George Stephenson, employ a great number of hands.

CLAYMORE (from the Gaelic *claidheamh mòr*, "great sword"), the old two-edged broadsword with cross hilt, of which the guards were usually turned down, used by the Highlanders of Scotland. The name is also wrongly applied to the single-edged basket-hilted sword adopted in the 16th century and still worn as the full-dress sword in the Highland regiments of the British army.

CLAYS, PAUL JEAN (1819-1900), Belgian artist, was born at Bruges in 1819, and died at Brussels in 1900. He was one of the most esteemed marine painters of his time, and early in his career he substituted a sincere study of nature for the extravagant and artificial conventionality of most of his predecessors. When he began to paint, the sea was considered by continental artists as worth representing only under its most tempestuous aspects. Artists cared only for the stirring drama of storm and wreck,

and they clung still to the old-world tradition of the romantic school. Clays was the first to appreciate the beauty of calm waters reflecting the slow procession of clouds, the glories of sunset illuminating the sails of ships or gilding the tarred sides of heavy fishing-boats. He painted the peaceful life of rivers, the poetry of wide estuaries, the regulated stir of roadsteads and ports. And while he thus broke away from old traditions he also threw off the trammels imposed on him by his master, the marine painter Theodore Gudin (1802-1880). Endeavouring only to give truthful expression to the nature that delighted his eyes, he sought to render the limpid salt atmosphere, the weight of waters, the transparency of moist horizons, the gem-like sparkle of the sky. A Fleming in his feeling for colour, he set his palette with clean strong hues, and their powerful harmonies were in striking contrast with the rusty, smoky tones then in favour. If he was not a "luminist" in the modern use of the word, he deserves at any rate to be classed with the founders of the modern naturalistic school. This conscientious and healthy interpretation, to which the artist remained faithful, without any important change, to the end of an unusually long and laborious career, attracted those minds which aspired to be bold, and won over those which were moderate. Clays soon took his place among the most famous Belgian painters of his generation, and his pictures, sold at high prices, are to be seen in most public and private galleries. We may mention, among others, "The Beach at Ault," "Boats in a Dutch Port," and "Dutch Boats in the Flushing Roads," the last in the National Gallery, London. In the Brussels gallery are "The Port of Antwerp," "Coast near Ostend," and a "Calm on the Scheldt"; in the Antwerp museum, "The Meuse at Dordrecht"; in the Pinakothek at Munich, "The Open North Sea"; in the Metropolitan Museum of Fine Arts, New York, "The Festival of the Freedom of the Scheldt at Antwerp in 1863"; in the palace of the king of the Belgians, "Arrival of Queen Victoria at Ostend in 1857"; in the Bruges academy, "Port of Feirugudo, Portugal." Clays was a member of several Academies, Belgian and foreign, and of the Order of Leopold, the Legion of Honour, &c.

See Camille Lemonnier, *Histoire des Beaux-Arts* (Brussels, 1887). (O. M.)

CLAYTON, JOHN MIDDLETON (1796-1856), American politician, was born in Dagsborough, Sussex county, Delaware, on the 24th of July 1796. He came of an old Quaker family long prominent in the political history of Delaware. He graduated at Yale in 1815, and in 1819 began to practise law at Dover, Delaware, where for a time he was associated with his cousin, Thomas Clayton (1778-1854), subsequently a United States senator and chief-justice of the state. He soon gained a large practice. He became a member of the state House of Representatives in 1824, and from December 1826 to October 1828 was secretary of state of Delaware. In 1829, by a combination of anti-Jackson forces in the state legislature, he was elected to the United States Senate. Here his great oratorical gifts gave him a high place as one of the ablest and most eloquent opponents of the administration. In 1831 he was a member of the Delaware constitutional convention, and in 1835 he was returned to the Senate as a Whig, but resigned in the following year. In 1837-1839 he was chief justice of Delaware. In 1845 he again entered the Senate, where he opposed the annexation of Texas and the Mexican War, but advocated the active prosecution of the latter once it was begun. In March 1849 he became secretary of state in the cabinet of President Zachary Taylor, to whose nomination and election his influence had contributed. His brief tenure of the state portfolio, which terminated on the 22nd of July 1850, soon after Taylor's death, was notable chiefly for the negotiation with the British minister, Sir Henry Lytton Bulwer, of the Clayton-Bulwer Treaty (*q.v.*). He was once more a member of the Senate from March 1853 until his death at Dover, Delaware, on the 9th of November 1856. By his contemporaries Clayton was considered one of the ablest debaters and orators in the Senate.

See the memoir by Joseph P. Comegys in the *Papers of the Historical Society of Delaware*, No. 4 (Wilmington, 1882).

CLAYTON-BULWER TREATY, a famous treaty between the United States and Great Britain, negotiated in 1850 by John M. Clayton and Sir Henry Lytton Bulwer (Lord Dalling), in consequence of the situation created by the project of an inter-oceanic canal across Nicaragua, each signatory being jealous of the activities of the other in Central America. Great Britain had large and indefinite territorial claims in three regions—Belize or British Honduras, the Mosquito Coast and the Bay Islands.¹ On the other hand, the United States, without territorial claims, held in reserve, ready for ratification, treaties with Nicaragua and Honduras, which gave her a certain diplomatic vantage with which to balance the *de facto* dominion of Great Britain. Agreement on these points being impossible and agreement on the canal question possible, the latter was put in the foreground. The resulting treaty had four essential points. It bound both parties not to "obtain or maintain" any exclusive control of the proposed canal, or unequal advantage in its use. It guaranteed the neutralization of such canal. It declared that, the intention of the signatories being not only the accomplishment of "a particular object"—*i.e.* that the canal, then supposedly near realization, should be neutral and equally free to the two contracting powers—"but also to establish a general principle," they agreed "to extend their protection by treaty stipulation to any other practicable communications, whether by canal or railway, across the isthmus which connects North and South America." Finally, it stipulated that neither signatory would ever "occupy, or fortify, or colonize, or assume or exercise any dominion over Nicaragua, Costa Rica, the Mosquito Coast or any part of Central America," nor make use of any protectorate or alliance, present or future, to such ends.

The treaty was signed on the 19th of April, and was ratified by both governments; but before the exchange of ratifications Lord Palmerston, on the 8th of June, directed Sir H. Bulwer to make a "declaration" that the British government did not understand the treaty "as applying to Her Majesty's settlement at Honduras, or its dependencies." Mr Clayton made a counter-declaration, which recited that the United States did not regard the treaty as applying to "the British settlement in Honduras commonly called British-Honduras . . . nor the small islands in the neighbourhood of that settlement which may be known as its dependencies"; that the treaty's engagements did apply to all the Central American states, "with their just limits and proper dependencies"; and that these declarations, not being submitted to the United States Senate, could of course not affect the legal import of the treaty. The interpretation of the declarations soon became a matter of contention. The phraseology reflects the effort made by the United States to render impossible a physical control of the canal by Great Britain through the territory held by her at its mouth—the United States losing the above-mentioned treaty advantages,—just as the explicit abnegations of the treaty rendered impossible such control politically by either power. But Great Britain claimed that the excepted "settlement" at Honduras was the "Belize" covered by the extreme British claim; that the Bay Islands were a dependency of Belize; and that, as for the Mosquito Coast, the abnegatory clauses being wholly prospective in intent, she was not required to abandon her protectorate. The United States contended that the Bay Islands were not the "dependencies" of Belize, these being the small neighbouring islands mentioned in the same treaties; that the excepted "settlement" was the British-Honduras of definite extent and narrow purpose recognized in British treaties with Spain; that she had not confirmed by recognition the large, indefinite and offensive claims whose dangers the treaty was primarily designed to lessen; and that, as to the Mosquito Coast, the treaty was retrospective, and mutual in the rigour of its requirements, and as the United States had no *de facto* possessions, while Great Britain had, the clause

¹ The claims to a part of the first two were very old in origin, but all were heavily clouded by interruptions of possession, contested interpretations of Spanish-British treaties, and active controversy with the Central American States. The claim to some of the territory was new and still more contestable. See particularly on these claims Travis's book cited below.

binding both not to "occupy" any part of Central America or the Mosquito Coast necessitated the abandonment of such territory as Great Britain was already actually occupying or exercising dominion over; and the United States demanded the complete abandonment of the British protectorate over the Mosquito Indians. It seems to be a just conclusion that when in 1852 the Bay Islands were erected into a British "colony" this was a flagrant infraction of the treaty; that as regards Belize the American arguments were decidedly stronger, and more correct historically; and that as regards the Mosquito question, inasmuch as a protectorate seems certainly to have been recognized by the treaty, to demand its absolute abandonment was unwarranted, although to satisfy the treaty Great Britain was bound materially to weaken it.

In 1859-1860, by British treaties with Central American states, the Bay Islands and Mosquito questions were settled nearly in accord with the American contentions.² But by the same treaties Belize was accorded limits much greater than those contended for by the United States. This settlement the latter power accepted without cavil for many years.

Until 1866 the policy of the United States was consistently for inter-oceanic canals open equally to all nations, and unequivocally neutralized; indeed, until 1880 there was practically no official divergence from this policy. But in 1880-1884 a variety of reasons were advanced why the United States might justly repudiate at will the Clayton-Bulwer Treaty.³ The new policy was based on national self-interest. The arguments advanced on its behalf were quite indefensible in law and history, and although the position of the United States in 1850-1860 was in general the stronger in history, law and political ethics, that of Great Britain was even more conspicuously the stronger in the years 1880-1884. In 1885 the former government reverted to its traditional policy, and the Hay-Pauncefote Treaty of 1902, which replaced the Clayton-Bulwer Treaty, adopted the rule of neutralization for the Panama Canal.

See the collected diplomatic correspondence in I. D. Travis, *History of the Clayton-Bulwer Treaty* (Ann Arbor, Mich., 1899); J. H. Latané, *Diplomatic Relations of the United States and Spanish America* (Baltimore, 1900); T. J. Lawrence, *Disputed Questions of Modern International Law* (2nd ed., Cambridge, England, 1885); Sir E. L. Bulwer in 99 *Quarterly Rev.* 235-286, and Sir H. Bulwer in 104 *Edinburgh Rev.* 280-298.

CLAY-WITH-FLINTS, in geology, the name given by W. Whitaker in 1861 to a peculiar deposit of stiff red, brown or yellow clay containing unworn whole flints as well as angular shattered fragments, also with a variable admixture of rounded flint, quartz, quartzite and other pebbles. It occurs "in sheets or patches of various sizes over a large area in the south of England, from Hertfordshire on the north to Sussex on the south, and from Kent on the east to Devon on the west. It almost always lies on the surface of the Upper Chalk, but in Dorset it passes on to the Middle and Lower Chalk, and in Devon it is found on the Chert-Beds of the Selbourn group" (A. J. Jukes-Browne, "The Clay-with-Flints, its Origin and Distribution," *Q.J.G.S.*, vol. lxii., 1906, p. 132). Many geologists have supposed, and some still hold, that the Clay-with-Flints is the residue left by the slow solution and disintegration of the Chalk by the processes of weathering; on the other hand, it has long been known that the deposit very frequently contains materials foreign to the Chalk, derived either from the Tertiary rocks or from overlying drift. In the paper quoted above, Jukes-Browne ably summarizes

² The islands were ceded to Honduras. The Mosquito Coast was recognized as under Nicaraguan rule limited by an attenuated British protectorate over the Indians, who were given a reservation and certain peculiar rights. They were left free to accept full Nicaraguan rule at will. This they did in 1894.

³ It was argued, *e.g.*, that the "general principle" of that engagement was contingent on the prior realization of its "particular object," which had failed, and the treaty had determined as a special contract; moreover, none of the additional treaties to embody the "general principle" had been negotiated, and Great Britain had not even offered co-operation in the protection and neutrality-guarantee of the Panama railway built in 1850-1855, so that her rights had lapsed; certain engagements of the treaty she had violated, and therefore the whole treaty was voidable, &c.

the evidence against the view that the deposit is mainly a Chalk residue, and brings forward a good deal of evidence to show that many patches of the Clay-with-Flints lie upon the same plane and may be directly associated with Reading Beds. He concludes "that the material of the Clay-with-Flints has been chiefly and almost entirely derived from Eocene clay, with addition of some flints from the Chalk; that its presence is an indication of the previous existence of Lower Eocene Beds on the same site and nearly at the same relative level, and, consequently, that comparatively little Chalk has been removed from beneath it. Finally, I think that the tracts of Clay-with-Flints have been much more extensive than they are now" (*loc. cit.* p. 159).

It is noteworthy that the Clay-with-Flints is developed over an area which is just beyond the limits of the ice sheets of the Glacial epoch, and the peculiar conditions of late Pliocene and Pleistocene times, involving heavy rains, snow and frost, may have had much to do with the mingling of the Tertiary and Chalky material. Besides the occurrence in surface patches, Clay-with-Flints is very commonly to be observed descending in "pipes" often to a considerable depth into the Chalk; here, if anywhere, the residual chalk portion of the deposit should be found, and it is surmised that a thin layer of very dark clay with darkly stained flints, which appears in contact with the sides and bottom of the pipe, may represent all there is of insoluble residue.

A somewhat similar deposit, a "conglomérat de silex" or "argile à silex," occurs at the base of the Eocene on the southern and western borders of the Paris basin, in the neighbourhood of Chartres, Thimerais and Sancerrois. (J. A. H.)

CLAZOMENAE (mod. *Kelismani*), an ancient town of Ionia and a member of the Ionian Dodecapolis (Confederation of Twelve Cities), on the Gulf of Smyrna, about 20 m. W. of that city. Though not in existence before the arrival of the Ionians in Asia, its original founders were largely settlers from Phlius and Cleonae. It stood originally on the isthmus connecting the mainland with the peninsula on which Erythrae stood; but the inhabitants, alarmed by the encroachments of the Persians, removed to one of the small islands of the bay, and there established their city. This island was connected with the mainland by Alexander the Great by means of a pier, the remains of which are still visible. During the 5th century it was for some time subject to the Athenians, but about the middle of the Peloponnesian war (412 B.C.) it revolted. After a brief resistance, however, it again acknowledged the Athenian supremacy, and repelled a Lacedaemonian attack. Under the Romans Clazomenae was included in the province of Asia, and enjoyed an immunity from taxation. The site can still be made out, in the neighbourhood of Vourla, but nearly every portion of its ruins has been removed. It was the birthplace of the philosopher Anaxagoras. It is famous for its painted terra-cotta sarcophagi, which are the finest monuments of Ionian painting in the 6th century B.C. (E. G.R.)

CLEANTHES (c. 301-232 or 252 B.C.), Stoic philosopher, born at Assos in the Troad, was originally a boxer. With but four drachmae in his possession he came to Athens, where he listened first to the lectures of Crates the Cynic, and then to those of Zeno, the Stoic, supporting himself meanwhile by working all night as water-carrier to a gardener (hence his nickname Φρέαντης). His power of patient endurance, or perhaps his slowness, earned him the title of "the Ass"; but such was the esteem awakened by his high moral qualities that, on the death of Zeno in 263, he became the leader of the school. He continued, however, to support himself by the labour of his own hands. Among his pupils were his successor, Chrysippus, and Antigonus, king of Macedon, from whom he accepted 2000 minae. The manner of his death was characteristic. A dangerous ulcer had compelled him to fast for a time. Subsequently he continued his abstinence, saying that, as he was already half-way on the road to death, he would not trouble to retrace his steps.

Cleanthes produced very little that was original, though he

wrote some fifty works, of which fragments have come down to us. The principal is the large portion of the *Hymn to Zeus* which has been preserved in Stobaeus. He regarded the sun as the abode of God, the intelligent providence, or (in accordance with Stoical materialism) the vivifying fire or aether of the universe. Virtue, he taught, is life according to nature; but pleasure is not according to nature. He originated a new theory as to the individual existence of the human soul; he held that the degree of its vitality after death depends upon the degree of its vitality in this life. The principal fragments of Cleanthes's works are contained in Diogenes Laertius and Stobaeus; some may be found in Cicero and Seneca.

See G. C. Mohinke, *Kleanthes der Stoiker* (Greifswald, 1814); C. Wachsmuth, *Commentationes de Zenone Ciliensi et Cleanthe Assio* (Göttingen, 1874-1875); A. C. Pearson, *Fragments of Zeno and Cleanthes* (Camb., 1891); article by E. Wellmann in Ersch and Gruber's *Allgemeine Encyclopädie*; R. Hirzel, *Untersuchungen zu Ciceros philosophischen Schriften*, ii. (1882), containing a vindication of the originality of Cleanthes; A. B. Krische, *Forschungen auf dem Gebiete der alten Philosophie* (1840); also works quoted under Stoics.

CLEARCHUS, the son of Rhamphias, a Spartan general and condottiere. Born about the middle of the 5th century B.C., Clearchus was sent with a fleet to the Hellespont in 411 and became governor (ἀρμοστής) of Byzantium, of which town he was *proxenus*. His severity, however, made him unpopular, and in his absence the gates were opened to the Athenian besieging army under Alcibiades (409). Subsequently appointed by the ephors to settle the political dissensions then rife at Byzantium and to protect the city and the neighbouring Greek colonies from Thracian attacks, he made himself tyrant of Byzantium, and, when declared an outlaw and driven thence by a Spartan force, he fled to Cyrus. In the "expedition of the ten thousand" undertaken by Cyrus to dethrone his brother Artaxerxes Mnemon, Clearchus led the Peloponnesians, who formed the right wing of Cyrus's army at the battle of Cunaxa (401). On Cyrus's death Clearchus assumed the chief command and conducted the retreat, until, being treacherously seized with his fellow-generals by Tissaphernes, he was handed over to Artaxerxes and executed (Thuc. viii. 8. 39, 80; Xen. *Hellenica*, i. 3. 15-19; *Anabasis*, i. ii.; Diodorus xiv. 12. 19-26). In character he was a typical product of the Spartan educational system. He was a warrior to the finger-tips (πολεμικός και φιλοπόλεμος ἑσχάτως. Xen. *Anab.* ii. 6. 1), and his tireless energy, unflinching courage and strategic ability made him an officer of no mean order. But he seems to have had no redeeming touch of refinement or humanity.

CLEARFIELD, a borough and the county-seat of Clearfield county, Pennsylvania, U.S.A., on the W. branch of the Susquehanna river, in the W. central part of the state. Pop. (1890) 2248; (1900) 5081 (310 foreign-born); (1910) 6851. It is served by the New York Central & Hudson River, the Pennsylvania, and the Buffalo, Rochester & Pittsburg railways. The borough is about 1105 ft. above sea-level, in a rather limited space between the hills, which command picturesque views of the narrow valley. The river runs through the borough. Coal and fireclay abound in the vicinity, and these, with leather, iron, timber and the products of the fertile soil, are the bases of its leading industries. Before the arrival of the whites the place had been cleared of timber (whence its name), and in 1805 it was chosen as a site for the county-seat of the newly erected county and laid out as a town; in 1840 it was incorporated as a borough.

CLEARING-HOUSE, the general term for a central institution employed in connexion with large and interrelated businesses for the purpose of facilitating the settlement of accounts.

Banking.—The London Clearing-House was established between 1750 and 1770 as a place where the clerks of the bankers of the city of London could assemble daily to exchange with one another the cheques drawn upon and bills payable at their respective houses. Before the clearing-house existed, each banker had to send a clerk to the places of business of all the other bankers in London to collect the sums payable by them in respect of cheques and bills; and it is obvious that much

time was consumed by this process, which involved the use of an unnecessary quantity of money and corresponding risks of safe carriage. In 1775 a room in Change Alley was settled upon as a common centre of exchange; this was afterwards removed to Post Office Court, Lombard Street. This clearing centre was at first confined to the bankers—at that time and long afterwards exclusively private bankers—doing business within the city, and the bankers in the west end of the metropolis used some one or other of the city banks as their agent in clearing. When the joint-stock banks were first established, the jealousy of the existing banks was powerful enough to exclude them altogether from the use of the Clearing-House; and it was not until 1854 that this feeling was removed so as to allow them to be admitted.

At first the Clearing-House was simply a place of meeting, but it came to be perceived that the sorting and distribution of cheques, bills, &c., could be more expeditiously conducted by the appointment of two or three common clerks to whom each banker's clerk could give all the instruments of exchange he wished to collect, and from whom he could receive all those payable at his own house. The payment of the balance settled the transaction, but the arrangements were afterwards so perfected that the balance is now settled by means of transfers made at the Bank of England between the Clearing-House account and those of the various banks, the Clearing-House, as well as each banker using it, having an account at the Bank of England. The use of the Clearing-House was still further extended in 1858, so as to include the settlement of exchanges between the country bankers of England. Before that time each country banker receiving cheques on other country bankers sent them to those other bankers by post (supposing they were not carrying on business in the same place), and requested that the amount should be paid by the London agent of the banker on whom the cheques were drawn to the London agent of the banker remitting them. Cheques were thus collected by correspondence, and each remittance involved a separate payment in London. Since 1858, accordingly, a country banker sends cheques on other country banks to his London correspondent, who exchanges them at the Clearing-House with the correspondents of the bankers on whom they are drawn.

The Clearing-House consists of one long room, lighted from the roof. Around the walls and down the centre are placed desks, allotted to the various banks, according to the amount of their business. The desks are arranged alphabetically, so that the clerks may lose no time in passing round the room and delivering their "charges" or batches of cheques to the representatives of the various banks. There are three clearings in London each day. The first is at 10.30 A.M., the second at noon, and the third at 2.30 P.M. It is the busiest of all, and continues until five minutes past four, when the last delivery must be made. The three clearings were, in 1907, divided into town, metropolitan and country clearings, each with a definite area. All the clearing banks have their cheques marked with the letters "T," "M" and "C," according to the district in which the issuing bank is situated. Every cheque issued by the clearing banks, even though drawn in the head office of a bank, goes through the Clearing-House.

The amount of business transacted at the Clearing-House varies very much with the seasons of the year, the busiest time being when dividends are paid and stock exchange settlements are made, but the volume of transactions averages roughly from 200 to 300 millions sterling a week, and the yearly clearances amount to something like £12,000,000,000. There are provincial clearing-houses at Manchester, Liverpool, Birmingham, Newcastle-on-Tyne, Leeds, Sheffield, Leicester and Bristol. There are also clearing-houses in most of the large towns of Scotland and Ireland. In New York and the other large cities of the United States there are clearing-houses providing accommodation for the various banking institutions (see BANKS AND BANKING).

The progress of banking on the continent of Europe has been slow in comparison with that of the United Kingdom, and the use of cheques is not so general, consequently the need for clearing-houses is not so great. In France, too, the greater

proportion of the banking business is carried on through three banks only, the Banque de France, the Société Générale and the Crédit Lyonnais, and a great part of their transactions are settled at their own head offices. But at the same time large sums pass through the Paris Chambre de Compensation (the clearing-house), established in 1872.

There are clearing-houses also in Berlin, Hamburg and many other European cities.

Railways.—The British Railway Clearing-House was established in 1842, its purpose, as defined by the Railway Clearing-House Act of 1850, being "to settle and adjust the receipts arising from railway traffic within, or partly within, the United Kingdom, and passing over more than one railway within the United Kingdom, booked or invoiced at throughout rates or fares." It is an independent body, governed by a committee which is composed of delegates (usually the chairman or one of the directors) from each of the railways that belong to it. Any railway company may be admitted a party to the clearing-system with the assent of the committee, may cease to be a member at a month's notice, and may be expelled if such expulsion be voted for by two-thirds of the delegates present at a specially convened meeting. The cost of maintaining it is defrayed by contributions from the companies proportional to the volume of business passed through it by each. It has two main functions. (1) When passengers or goods are booked through between stations belonging to different railway companies at an inclusive charge for the whole journey, it distributes the money received in due proportions between the companies concerned in rendering the service. To this end it receives, in the case of passenger traffic, a monthly return of the tickets issued at each station to stations on other lines, and, in the case of goods traffic, it is supplied by both the sending and receiving stations (when these are on different companies' systems) with abstracts showing the character, weight, &c., of the goods that have travelled between them. By the aid of these particulars it allocates the proper share of the receipts to each company, having due regard to the distance over which the traffic has been carried on each line, to the terminal services rendered by each company, to any incidental expenses to which it may have been put, and to the existence of any special agreements for the division of traffic. (2) To avoid the inconvenience of a change of train at points where the lines of different companies meet, passengers are often, and goods and minerals generally, carried in through vehicles from their starting-point to their destination. In consequence, vehicles belonging to one company are constantly forming part of trains that belong to, and run over the lines of, other companies, which thus have the temporary use of rolling stock that does not belong to them. By the aid of a large staff of "number takers" who are stationed at junctions all over the country, and whose business is to record particulars of the vehicles which pass through those junctions, the Clearing-House follows the movements of vehicles which have left their owners' line, ascertains how far they have run on the lines of other companies, and debits each of the latter with the amount it has to pay for their use. This charge is known as "mileage"; another charge which is also determined by the Clearing-House is "demurrage," that is, the amount exacted from the detaining company if a vehicle is not returned to its owners within a prescribed time. By the exercise of these functions the Clearing-House accumulates a long series of credits to, and debits against, each company; these are periodically added up and set against each other, with the result that the accounts between it and the companies are finally settled by the transfer of comparatively small balances. It also distributes the money paid by the post-office to the railways on account of the conveyance of parcel-post traffic, and through its lost luggage department many thousands of articles left in railway carriages are every year returned to their owners. Its situation in London further renders it a convenient meeting-place for several "Clearing-House Conferences" of railway officials, as of the general managers, the goods managers, and the superintendents of the line, held four times a year for the consideration of questions in which all the companies are interested. The Irish Railway

Clearing-House, established in 1848, has its headquarters in Dublin, and was incorporated by act of parliament in 1860.

General.—The principle of clearing adopted by banks and railways has been applied with considerable success in other businesses.

In 1874 the London Stock Exchange Clearing-House was established for the purpose of settling transactions in stock, the clearing being effected by balance-sheets and tickets; the balance of stock to be received or delivered is shown on a balance-sheet sent in by each member, and the items are then cancelled against one another and tickets issued for the balances outstanding. The New York Stock Exchange Clearing-House was established in 1892. The settlements on the Paris Bourse are cleared within the Bourse itself, through the Compagnie des Agents de Change de Paris.

In 1888 a society was formed in London called the Beetroot Sugar Association for clearing bargains in beetroot sugar. For every 500 bags of sugar of a definite weight which a broker sells, he issues a *filière* (a form something like a dock-warrant), giving particulars as to the ship, the warehouse, trade-marks, &c. The *filière* contains also a series of transfer forms which are filled up and signed by each successive holder, so transferring the property to a new purchaser. The new purchaser also fills up a coupon attached to the transfer, quoting the date and hour of sale. This coupon is detached by the seller and retained by him as evidence to determine any liability through subsequent delay in the delivery of the sugar. Any purchaser requiring delivery of the sugar forwards the *filière* to the clearing-house, and the officials then send on his name to the first seller who tenders him the warrant direct. These *filières* pass from hand to hand within a limit of six days, a stamp being affixed on each transfer as a clearing-house fee. The difference between each of the successive transactions is adjusted by the clearing-house to the profit or loss of the seller.

The London Produce Clearing-House was established in 1888 for regulating and adjusting bargains in foreign and colonial produce. The object of the association is to guarantee both to the buyer and the seller the fulfilment of bargains for future delivery. The transactions on either side are allowed to accumulate during a month and an adjustment made at the end by a settlement of the final balance owing. On the same lines are the Caisse de Liquidation at Havre and the Waaren Liquidations Casse at Hamburg. The Cotton Association also has a clearing-house at Liverpool for clearing the transactions which arise from dealings in cotton.

AUTHORITIES.—W. Howarth, *Our Clearing System and Clearing Houses* (1897); *The Banks in the Clearing House* (1905); J. G. Cannon, *Clearing-houses, their History, Methods and Administration* (1901); H. T. Easton, *Money, Exchange and Banking* (1905); and the various volumes of the *Journal of the Institute of Bankers*. (T. A. I.)

CLEAT (a word common in various forms to many Teutonic languages, in the sense of a wedge or lump, cf. "clod" and "clot"), a wedge-shaped piece of wood fastened to ships' masts and elsewhere to prevent a rope, collar or the like from slipping, or to act as a step; more particularly a piece of wood or metal with double or single horns used for belaying ropes. A "cleat" is also a wedge fastened to a ship's side to catch the shores in a launching cradle or dry dock. "Cleat" is also used in mining for the vertical cleavage-planes of coal.

CLEATOR MOOR, an urban district in the Egremont parliamentary division of Cumberland, England, 4 m. S.E. of Whitehaven, served by the Furness, London & North-Western and Cleator & Workington Junction railways. Pop. (1901) 8120. The town lies between the valleys of the Ehen and its tributary the Dub Beck, in a district rich in coal and iron ore. The mining of these, together with blast furnaces and engineering works, occupies the large industrial population.

CLEAVERS, or GOOSE-GRASS, *Galium Aparine* (natural order Rubiaceae), a common plant in hedges and waste places, with a long, weak, straggling, four-sided, green stem, bearing whorls of 6 to 8 narrow leaves, $\frac{1}{2}$ to 2 in. long, and, like the angles of the stem, rough from the presence of short, stiff, downwardly-pointing,

hooked hairs. The small, white, regular flowers are borne, a few together, in axillary clusters, and are followed by the large, hispid, two-celled fruit, which, like the rest of the plant, readily clings to a rough surface, whence the common name. The plant has a wide distribution throughout the north temperate zone, and is also found in temperate South America.

CLEBURNE, a town and the county-seat of Johnson county, Texas, U.S.A., 25 m. S. of Fort Worth. Pop. (1890) 3278; (1900) 7493, including 611 negroes; (1910) 10,364. It is served by the Gulf, Colorado & Santa Fé, the Missouri, Kansas & Texas; and the Trinity & Brazos Valley railways. It is the centre of a prosperous farming, fruit and stock-raising region, has large railway repair shops, flour-mills, cotton gins and foundries, a canning factory and machine shops. It has a Carnegie library, and St Joseph's Academy (Roman Catholic; for girls). The town was named in honour of Patrick Ronayne Cleburne (1828-1864), a major-general of the Confederate army, who was of Irish birth, practised law in Helena, Arkansas, served at Shiloh, Perryville, Stone River, Chickamauga, Missionary Ridge, Ringgold Gap, Jonesboro and Franklin, and was killed in the last-named battle; he was called the "Stonewall of the West."

CLECKHEATON, an urban district in the Spen Valley parliamentary division of the West Riding of Yorkshire, England, $5\frac{1}{2}$ m. S. by E. of Bradford, on the Lancashire & Yorkshire, Great Northern and London & North-Western railways. Pop. (1901) 12,524. A chamber of commerce has held meetings here since 1878. The industries comprise the manufacture of woollens, blankets, flannel, wire-card and machinery.

CLEETHORPES, a watering-place of Lincolnshire, England; within the parliamentary borough of Great Grimsby, 3 m. S.E. of that town by a branch of the Great Central railway. Pop. of urban district of Cleethorpe with Thrunscoe (1901) 12,578. Cleethorpes faces eastward to the North Sea, but its shore of fine sand, affording good bathing, actually belongs to the estuary of the Humber. There is a pier, and the sea-wall extends for about a mile, forming a pleasant promenade. The suburb of New Clec connects Cleethorpes with Grimsby. The church of the Holy Trinity and St Mary is principally Norman of various dates, but work of a date apparently previous to the Conquest appears in the tower. Cleethorpes is greatly favoured by visitors from the midland counties, Lancashire and Yorkshire.

CLEFT PALATE and **HARE-LIP**, in surgery. *Cleft Palate* is a congenital cleavage, or incomplete development in the roof of the mouth, and is frequently associated with hare-lip. The infant is prevented from sucking, and an operation is necessary. Cleft-palate is often a hereditary defect. The most favourable time for operating is between the age of two weeks and three months, and if the cleft is closed at this early date, not only are the nutrition and general development of the child greatly improved, but the voice is probably saved from much of the unpleasant tone which is usually associated with a defective roof to the mouth and is apt to persist even if a cleft has been successfully operated on later in childhood. The greatest advance which has been made in the operative treatment of cleft palate is due to the teaching of Dr Truman W. Brophy, who adopted the ingenious plan of thrusting together to the middle line of the mouth the halves of the palate which nature had unfortunately left apart. But, as noted above, this operation must, to give the best results, be undertaken in the earliest months of infancy. After the cleft in the palate has been effectually dealt with, the hare-lip can be repaired with ease and success.

Hare-lip.—In the hare the splitting of the lip is in the middle line, but in the human subject it is on one side, or on both sides of the middle line. This is accounted for on developmental grounds: a cleft in the exact middle line is of extremely rare occurrence. Hare-lip is often associated with cleft palate. Though we are at present unable to explain why development should so frequently miss the mark in connexion with the formation of the lip and palate, it is unlikely that maternal impressions have anything to do with it. As a rule, the supposed "fright" comes long after the lips are developed. They are completely formed by the ninth week. Heredity has a powerful influence

in many cases. The best time for operating on a hare-lip depends upon various circumstances. Thus, if it is associated with cleft palate, the palatine cleft has first to be closed, in which case the child will probably be several months old before the lip is operated on. If the infant is in so poor a state of nutrition that it appears unsuitable for surgical treatment, the operation must be postponed until his condition is sufficiently improved. But, assuming that the infant is in fair health, that he is taking his food well and thriving on it, that he is not troubled by vomiting or diarrhoea, and that the hare-lip is not associated with a defective palate, the sooner it is operated on the better. It may be successfully done even within a few hours of birth. When a hare-lip is unassociated with cleft palate, the infant may possibly be enabled to take the breast within a short time of the gap being closed. In such a case the operation may be advisably undertaken within the first few days of birth. The case being suitable, the operation may be conveniently undertaken at any time after the tenth day. (E. O.*)

CLEISTHENES, the name of two Greek statesmen, (1) of Athens, (2) of Sicyon, of whom the first is far the more important.

1. CLEISTHENES, the Athenian statesman, was the son of Megacles and Agariste, daughter of Cleisthenes of Sicyon. He thus belonged, through his father, to the noble family of the Alcmaeonidae (*q.v.*), who bore upon them the curse of the Cylonian massacre, and had been in exile during the rule of the Peisistratids. In the hope of washing out the stigma, which damaged their prestige, they spent the latter part of their exile in carrying out with great splendour the contract given out by the Amphictyons for the rebuilding of the temple at Delphi (destroyed by fire in 548 B.C.). By building the pronaos of Parian marble instead of limestone as specified in the contract, they acquired a high reputation for piety; the curse was consigned to oblivion, and their reinstatement was imposed by the oracle itself upon the Spartan king, Cleomenes (*q.v.*). Cleisthenes, to whom this far-seeing atonement must probably be attributed, had also on his side (1) the malcontents in Athens who were disgusted with the growing severity of Hippias, and (2) the oligarchs of Sparta, partly on religious grounds, and partly owing to their hatred of tyranny. Aristotle's *Constitution of Athens*, however, treats the alliance of the Peisistratids with Argos, the rival of Sparta in the Peloponnese, as the chief ground for the action of Sparta (*c. 19*). In *c. 513 B.C.* Cleisthenes invaded Attica, but was defeated by the tyrant's mercenaries at Leipsydrium (S. of Mt. Parnes). Sparta then, in tardy obedience to the oracle, threw off her alliance with the Peisistratids, and, after one failure, expelled Hippias in 511-510 B.C., leaving Athens once again at the mercy of the powerful families.

Cleisthenes, on his return, was in a difficulty; he realized that Athens would not tolerate a new tyranny, nor were the other nobles willing to accept him as leader of a constitutional oligarchy. It was left for him to "take the people into partnership" as Peisistratus had in a different way done before him. Solon's reforms had failed, primarily because they left unimpaired the power of the great landed nobles, who, in their several districts, doubled the rôles of landlord, priest and patriarch. This evil of local influence Peisistratus had concealed by satisfying the nominally sovereign people that in him they had a sufficient representative. It was left to Cleisthenes to adopt the remaining remedy of giving substance to the form of the Solonian constitution. His first attempts roused the aristocrats to a last effort; Isagoras appealed to the Spartans (who, though they disliked tyranny, had no love for democracy) to come to his aid. Cleisthenes retired on the arrival of a herald from Cleomenes, reviving the old question of the curse; Isagoras thus became all-powerful and expelled seven hundred families. The democrats, however,

rose, and after besieging Cleomenes and Isagoras in the Acropolis, let them go under a safe-conduct, and brought back the exiles.

Apart from the reforms which Cleisthenes was now able to establish, the period of his ascendancy is a blank, nor are we told when and how it came to an end. It is clear, however—and it is impossible in connexion with the Pan-hellenic patriotism to which Athens laid claim, to overrate the importance of the fact—that Cleisthenes, hard pressed in the war with Boeotia, Euboea and Sparta (Herod. v. 73 and foll.), sent ambassadors to ask the help of Persia. The story, as told by Herodotus, that the ambassadors of their own accord agreed to give "earth and water" (*i.e.* submission) in return for Persian assistance, and that the Ecclesia subsequently disavowed their action as unauthorized, is scarcely credible. Cleisthenes (1) was in full control and must have instructed the ambassadors; (2) he knew that any help from Persia meant submission. It is practically certain, therefore, that he (*cf.* the Alcmaeonids and the story of the shield at Marathon) was the first to "medize" (see Curtius, *History of Greece*). Probably he had hoped to persuade the Ecclesia that the agreement was a mere form. Aelian says that he himself was a victim to his own device of ostracism (*q.v.*); this, though apparently inconsistent with the *Constitution of Athens* (*c. 22*), may perhaps indicate that his political career ended in disgrace, a hypothesis which is explicable on the ground of this act of treachery in respect of the attempted Persian alliance. Whether to Cleisthenes are due the final success over Boeotia and Euboea, the planting of the 4000 cleruchs on the Lelantine Plain, and the policy of the Aeginetan War (see AEGINA), in which Athens borrowed ships from Corinth, it is impossible to determine. The eclipse of Cleisthenes in all records is one of the most curious facts in Greek history. It is also curious that we do not know in what official capacity Cleisthenes carried his reforms. Perhaps he was given extraordinary *ad hoc* powers for a specified time; conceivably he used the ordinary mechanism. It seems clear that he had fully considered his scheme in advance, that he broached it before the last attack of Isagoras, and that it was only after the final expulsion of Isagoras and his Spartan allies that it became possible for him to put it into execution.

Cleisthenes aimed at being the leader of a self-governing people; in other words he aimed at making the democracy actual. He realized that the dead-weight which held the democracy down was the influence on politics of the local religious unit. Therefore his prime object was to dissociate the clans and the phratries from politics, and to give the democracy a totally new electoral basis in which old associations and vested interests would be split up and become ineffective. It was necessary that no man should govern a pocket-constituency merely by virtue of his religious, financial or ancestral prestige, and that there should be created a new local unit with administrative powers of a democratic character which would galvanize the lethargic voters into a new sense of responsibility and independence. His first step was to abolish the four Solonian tribes and create ten new ones.² Each of the new tribes was subdivided into "demes" (roughly "townships"); this organization did not, except politically, supersede the system of clans and phratries whose old religious signification remained untouched. The new tribes, however, though geographically arranged, did not represent local interests. Further, the tribe names were taken from legendary heroes (Cecropis, Pandionis, Aegeis recalled the storied kings of Attica), and, therefore, contributed to the idea of a national unity; even Ajax, the eponym of the tribe Aeantis, though not Attic, was famous as an ally (Herod. v. 66) and ranked as a national hero. Each tribe had its shrine and its particular hero-cult, which, however, was free from local association and the dominance of particular

¹ The archonship of Isagoras in 508 is important as showing that Cleisthenes, three years after his return, had so far failed to secure the support of a majority in Athens. There is no sufficient reason for supposing that the election of Isagoras was procured by Cleomenes; all the evidence points to its having been brought about in the ordinary way. Probably, therefore, Cleisthenes did not take the people thoroughly into partnership till after the spring of 508.

² The explanation given for this step by Herodotus (*v. 67*) is an amusing example of his incapacity as a critical historian. To compare Cleisthenes of Sicyon (see below), bent on humiliating the Dorians of Sicyon by giving opprobrious names to the Dorian tribes, with his grandson, whose endeavour was to elevate the very persons whose tribal organization he replaced, is clearly absurd.

Home and foreign policy.

Analysis of his reforms.

The ten tribes.

families. This national idea Cleisthenes further emphasized by setting up in the market-place at Athens a statue of each tribal hero.

The next step was the organization of the deme. Within each tribe he grouped ten demes (see below), each of which had (1) its hero and its chapel, and (2) its census-list kept by the demarch. The demarch (local governor), who

was elected popularly and held office for one year, presided over meetings affecting local administration and the provision of crews for the state-navy, and was probably under a system of scrutiny like the *dokimasia* of the state-magistrates. According to the Aristotelian *Constitution of Athens*, Cleisthenes further divided Attica into three districts, Urban and Suburban, Inland (*Mesogaïos*), and Maritime (*Paralia*), each of which was subdivided into ten *trittyes*; each tribe had three trittyes in each of these districts. The problem of establishing this decimal system in connexion with the demes and trittyes is insoluble. Herodotus says that there were ten¹ demes to each tribe (*δέκα τὰς φυλάς*); but each tribe was composed of three trittyes, one in each of the three districts. Since the deme was, as will be seen, the electoral unit, it is clear that in tribal voting the object of ending the old threefold schism of the Plain, the Hill and the Shore was attained, but the relation of deme and trittys is obviously of an unsymmetrical kind. The *Constitution of Athens* says nothing of the ten-deme-to-each-tribe arrangement, and there is no sufficient reason for supposing that the demes originally were exactly a hundred in number. We know the names of 168 demes, and Polemon (3rd century B.C.) enumerated 73. It has been suggested that the demes did originally number exactly a hundred, and that new demes were added as the population increased. This theory, however, presupposes that the demes were originally equal in numbers. In the 5th and 4th centuries this was certainly not the case; the number of demesmen in some cases was only one hundred or two hundred, whereas the deme Acharnae is referred to as a "great part" of the whole state, and is known to have furnished three thousand hoplites. The theory is fundamentally at fault, inasmuch as it regards the deme as consisting of all those *resident within its borders*. In point of fact membership was hereditary, not residential; Demosthenes "of the Paeanian deme" might live where he would without severing his deme connexion. Thus the increase of population could be no reason for creating new demes. This distinction in a deme between demesmen and residents belonging to another deme (the *ἐγκεκτημένοι*), who paid a deme-tax for their privilege, is an important one. It should further be noted that the demes belonging to a particular tribe do not, as a fact, appear always in three separate groups; the tribe Aeantis consisted of Phalerum and eleven demes in the district of Marathon; other tribes had demes in five or six groups. It must, therefore, be admitted that the problem is insoluble for want of data. Nor are we better equipped to settle the relation between the Cleisthenean division into Urban, Maritime and Inland, and the old divisions of the Plain, the Shore and the Upland or Hill. The "Maritime" of Cleisthenes and the old "Shore" are certainly not coincident, nor is the "Inland" identical with the "Upland."

Lastly, it has been asked whether we are to believe that Cleisthenes invented the demes. To this the answer is in the negative. The demes were undoubtedly primitive divisions of Attica, Herodotus (ix. 73) speaks of the Dioscuri as ravaging the demes of Declea (see R. W. Macan *ad loc.*) and we hear of opposition between the city and the demes. The most logical conclusion perhaps is that Cleisthenes, while he *did* create the demes which Athens itself comprised, did not create the country demes, but merely gave them definition as political divisions. Thus the city itself had six demes in five different tribes, and the other five tribes were represented in the suburbs and the Peiraeus. It is clear that in the Cleisthenean system there was one great source of danger, namely that the residents in and about Athens must always have had more weight in elections than those in

¹ Wilamowitz-Moellendorff (*Arist. und Athen*, pp. 149-150) suggests *δέκατά*, "in ten batches," instead of *δέκα*.

distant demes. There can be little doubt that the preponderating influence of the city was responsible for the unwisdom of the later imperial policy and the Peloponnesian war.

A second problem is the franchise reform of Cleisthenes. Aristotle in the *Politics* (iii. 2. 3 = 1275 b) says that Cleisthenes created new citizens by enrolling in the tribes "many resident aliens and emancipated slaves."² But the Aristotelian *Constitution of Athens* asserts that he gave "citizenship to the masses." These two statements are not compatible. It is perfectly clear that Cleisthenes is to be regarded as a democrat, and it would have been no bribe to the people merely to confer a boon on aliens and slaves. Moreover, a revision of the citizen-roll (*diapsephismos*) had recently taken place (after the end of the tyranny) and a great many citizens had been struck off the roll as being of impure descent (*οἱ τῷ γένει μὴ καθαροί*). This class had existed from the time of Solon, and, through fear of political extinction by the oligarchs, had been favourable to Peisistratus. Cleisthenes may have enfranchised aliens and slaves, but it seems certain that he must have dealt with these free Athenians who had lost their rights. Now Isagoras presumably did not carry out this revision of the roll (*diapsephismos*); as "the friend of the tyrants" (so *Ath. Pol.* 20; by Meyer, Busolt and others contest this) he would not have struck a blow at a class which favoured his own views. A reasonable hypothesis is that Cleisthenes was the originator of the measure of expulsion, and that he now changed his policy, and strengthened his hold on the democracy by reinstating the disfranchised in much larger numbers. The new citizens, whoever they were, must, of course, have been enrolled also in the (hitherto exclusive) phratry lists and the deme-rolls.

The Boulē (*q.v.*) was reorganized to suit the new tribal arrangement, and was known henceforward as the Council of the Five Hundred, fifty from each tribe. Its exact constitution is unknown, but it was certainly more democratic than the Solonian Four Hundred. Further, the system of ten tribes led in course of time to the construction of boards of ten to deal with military and civil affairs, e.g. the Strategi (see STRATEGUS), the Apodectae, and others. Of these the former cannot be attributed to Cleisthenes, but on the evidence of Androton it is certain that it was Cleisthenes who replaced the Colacretae³ by the Apodectae ("receivers"), who were controllers and auditors of the finance department, and, before the council in the council-chamber, received the revenues. The Colacretae, who had done this work before, remained in authority over the internal expenses of the Prytaneum. A further change which followed from the new tribal system was the reconstitution of the army; this, however, probably took place about 501 B.C., and cannot be attributed directly to Cleisthenes. It has been said that the deme became the local political unit, replacing the naucrary (*q.v.*). But the naucraries still supplied the fleet, and were increased in number from forty-eight to fifty; if each naucrary still supplied a ship and two mounted soldiers as before, it is interesting to learn that, only seventy years before the Peloponnesian War, Athens had but fifty ships and a hundred horse.⁴

The device of ostracism is the final stone in the Cleisthenean structure. An admirable scheme in theory, and, at first, in practice, it deteriorated in the 5th century into a mere party

² It should be observed that there are other translations of the difficult phrase *ξένους καὶ δοῦλους μετοίκους*.

³ Colacretae were very ancient Athenian magistrates; either (1) those who "cut up the joints" in the Prytaneum (*κῶλα, κείρω*), or (2) those who "collected the joints" (*κῶλα, ἀγείρω*) which were left over from public sacrifices, and consumed in the Prytaneum. These officials were again important in the time of Aristophanes (*Wasps*, 693. 724; *Birds*, 1541), and they presided over the payment of the dicasts instituted by Pericles. They are not mentioned, though they may have existed, after 403 B.C. At Sicyon also magistrates of this name are found.

⁴ It is, however, more probable that the right reading of the passage is *δέκα ἰππέες* instead of *δύο*, which would give a cavalry force in early Athens of 480, a reasonable number in proportion to the total fighting strength.

weapon, and in the case of Hyperbolus (417) became an absurdity.

In conclusion it should be noticed that Cleisthenes was the founder of the Athens which we know. To him was due the spirit of nationality, the principle of liberty duly apportioned and controlled by centralized and decentralized administration, which prepared the ground for the rich developments of the Golden Age with its triumphs of art and literature, politics and philosophy. It was Cleisthenes who organized the structure which, for a long time, bore the heavy burden of the Empire against impossible odds, the structure which the very different genius of Pericles was able to beautify. He was the first to appreciate the unique power in politics, literature and society of an organized public opinion.

AUTHORITIES.—*Ancient:* Aristotle, *Constitution of Athens* (ed. J. E. Sandys), cc. 20-22, 41, Herodotus v 63-73, vi 131, Aristotle, *Politics*, iii. 2, 3 (= 1275 b, for franchise reforms) *Modern Histories of Greece in general, especially those of Grote and Curtius* (which, of course, lack the information contained in the *Constitution of Athens*), and J. B. Bury. See also E. Meyer, *Geschichte des Altertums* (vol. ii.), G. Busolt, *Griech. Gesch.* (2nd ed., 1893 foll.), Milchhofer, "Über die Demenordnung des Kleisthenes" in appendix to *Abhandlung d. Berl. Akad.* (1892); R. Loeper in *Athen Mitteil.* (1892), pp. 319-433, A. H. J. Greenidge, *Handbook of Greek Constitutional History* (1896), Gilbert, *Greek Constitutional Antiquities* (Eng. trans., 1895), R. W. Macan, *Herodotus iv-vi.*, vol. II (1895), pp. 127-148, U. von Wilamowitz-Moellendorf, *Arist. und Athen.* See also BOULE, ECCLESIA, OSTRACISM, NAUCRARY, SOLON.

2. **CLEISTHENES OF SICYON** (c. 600-570), grandfather of the above, became tyrant of Sicyon as the representative of the conquered Ionian section of the inhabitants. He emphasized the destruction of Dorian predominance by giving ridiculous epithets to their tribal units, which from Hylleis, Dymanes and Pamphyli become Hyatae ("Swine-men"), Choireatae ("Pig men") and Oneatae ("Ass-men"). He also attacked Dorian Argos, and suppressed the Homeric "rhapsodists" who sang the exploits of Dorian heroes. He championed the cause of the Delphic oracle against the town of Crisa (Cirrha) in the Sacred War (c. 590). Crisa was destroyed, and Delphi became one of the meeting-places of the old amphictyony of Anthela, henceforward often called the Delphic amphictyony. The Pythian games, largely on the initiative of Cleisthenes, were re-established with new magnificence, and Cleisthenes won the first chariot race in 582. He founded Pythian games at Sicyon, and possibly built a new Sicyonian treasury at Delphi. His power was so great that when he offered his daughter Agariste in marriage, some of the most prominent Greeks sought the honour, which fell upon Megacles, the Alcmaeonid. The story of the rival wooers with the famous retort, "Hippocleides don't care," is told in Herod. vi. 125; see also Herod. v. 67 and Thuc. i. 18.

CLEISTHENES is also the name of an Athenian, pilloried by Aristophanes (*Clouds*, 354; *Thesm.* 574) as a top and a profligate. (J. M. M.)

CLEITARCHUS, one of the historians of Alexander the Great, son of Deinon, also an historian, was possibly a native of Egypt, or at least spent a considerable time at the court of Ptolemy Lagus. Quintilian (*Instit.* x. i. 74) credits him with more ability than trustworthiness, and Cicero (*Brutus*, 11) accuses him of giving a fictitious account of the death of Themistocles. But there is no doubt that his history was very popular, and much used by Diodorus Siculus, Quintus Curtius, Justin and Plutarch, and the authors of the Alexander romances. His unnatural and exaggerated style became proverbial.

The fragments, some thirty in number, chiefly preserved in Aelian and Strabo, will be found in C. Müller's *Scriptores Rerum Alexandri Magni* (in the Didot *Arrian*, 1846); monographs by C. Raun, *De Clitarcho Diodori, Curtii, Justinii auctore* (1868), and F. Reuss, "Hellenistische Beiträge" in *Rhein. Mus.* lxxiii. (1908), pp. 58-78.

CLEITHRAL (Gr. κλειθρον, an enclosed or shut-up place), an architectural term applied to a covered Greek temple, in contradistinction to *hypaethral*, which designates one that is uncovered; the roof of a cleithral temple completely covers it.

CLEITOR, or **CLITOR**, a town of ancient Greece, in that part of Arcadia which corresponds to the modern eparchy of Kalavryta in the nomos of Elis and Achaea. It stood in a fertile plain to the south of Mt. Chelmos, the highest peak of the Aroanian

Mountains, and not far from a stream of its own name, which joined the Aroanius, or Katzana. In the neighbourhood was a fountain, the waters of which were said to deprive those who drank them of the taste for wine. The town was a place of considerable importance in Arcadia, and its inhabitants were noted for their love of liberty. It extended its territory over several neighbouring towns, and in the Theban war fought against Orchomenus. It joined the other Arcadian cities in the foundation of Megalopolis. As a member of the Achaean league it was besieged by the Aetolians in 220 B.C., and was on several occasions the seat of the federal assemblies. It coined money up to the time of Septimius Severus. The ruins, which bear the common name of Paleopoli, or Old City, are still to be seen about 3 m. from a village that preserves the ancient designation. The greater part of the walls which enclose an area of about a mile and several of the semi-circular towers with which they were strengthened can be clearly made out; and there are also remains of three Doric temples and a small theatre.

CLELAND, WILLIAM (1661?-1689), Scottish poet and soldier, son of Thomas Cleland, gamekeeper to the marquis of Douglas, was born about 1661. He was probably brought up on the marquess of Douglas's estate in Lanarkshire, and was educated at St. Andrews University. Immediately on leaving college he joined the army of the Covenanters, and was present at Drumclog, where, says Robert Wodrow, some attributed to Cleland the manoeuvre which led to the victory. He also fought at Bothwell Bridge. He and his brother James were described in a royal proclamation of the 16th of June 1679 among the leaders of the insurgents. He escaped to Holland, but in 1685 was again in Scotland in connexion with the abortive invasion of the earl of Argyll. He escaped once more, to return in 1688 as agent for William of Orange. He was appointed lieutenant-colonel of the Cameronian regiment raised from the minority of the western Covenanters who consented to serve under William III. The Cameronians were entrusted with the defence of Dunkeld, which they held against the fierce assault of the Highlanders on the 26th of August. The repulse of the Highlanders before Dunkeld ended the Jacobite rising, but Cleland fell in the struggle. He wrote *A Collection of several Poems and Verses* composed upon various occasions (published posthumously, 1697). Of "Hullo, my fancy, whither wilt thou go?" only the last nine stanzas are by Cleland. His poems have small literary merit, and are written, not in pure Lowland Scots, but in English with a large admixture of Scottish words. The longest and most important of them are the "mock poems" "On the Expedition of the Highland Host who came to destroy the western shires in winter 1678" and "On the clergie when they met to consult about taking the Test in the year 1681."

An Exact Narrative of the Conflict of Dunkeld . . . collected from several officers of the regiment . . . appeared in 1689.

CLEMATIS, in botany, a genus of the natural order Ranunculaceae, containing nearly two hundred species, and widely distributed. It is represented in England by *Clematis Vitalba*, "old man's beard" or "traveller's joy," a common plant on chalky or light soil. The plants are shrubby climbers with generally compound opposite leaves, the stalk of which is sensitive to contact like a tendril, becoming twisted round suitable objects and thereby giving support to the plant. The flowers are arranged in axillary or terminal clusters; they have no petals, but white or coloured, often very large sepals, and an indefinite number of stamens and carpels. They contain no honey, and are visited by insects for the sake of the pollen, which is plentiful. The fruit is a head of achenes, each bearing the long-bearded persistent style, suggesting the popular name. This feathery style is an important agent in the distribution of the seed by means of the wind. Several of the species, especially the large-flowered ones, are favourite garden plants, well adapted for covering trellises or walls, or trailing over the ground. Many garden forms have been produced by hybridization; among the best known is *C. Jackmanni*, due to Mr. George Jackman of Woking.

Further information may be obtained from *The Clematis as a Garden Flower*, by Thos. Moore and George Jackman. See also G. Nicholson, *Dictionary of Gardening*, i. (1885) and *Supplements*.

CLEMENCEAU, GEORGES (1841-), French statesman, was born at Mouilleron-en-Pareds, Vendée, on the 28th of September 1841. Having adopted medicine as his profession, he settled in 1869 in Montmartre; and after the revolution of 1870 he had become sufficiently well known to be nominated mayor of the 18th arrondissement of Paris (Montmartre)—an unruly district over which it was a difficult task to preside. On the 8th of February 1871 he was elected as a Radical to the National Assembly for the department of the Seine, and voted against the peace preliminaries. The execution, or rather murder, of Generals Lecomte and Clément Thomas by the communists on 18th March, which he vainly tried to prevent, brought him into collision with the central committee sitting at the hôtel de ville, and they ordered his arrest, but he escaped; he was accused, however, by various witnesses, at the subsequent trial of the murderers (November 29th), of not having intervened when he might have done, and though he was cleared of this charge it led to a duel, for his share in which he was prosecuted and sentenced to a fine and a fortnight's imprisonment.

Meanwhile, on the 20th of March 1871, he had introduced in the National Assembly at Versailles, on behalf of his Radical colleagues, the bill establishing a Paris municipal council of eighty members; but he was not returned himself at the elections of the 26th of March. He tried with the other Paris mayors to mediate between Versailles and the hôtel de ville, but failed, and accordingly resigned his mayoralty and his seat in the Assembly, and temporarily gave up politics; but he was elected to the Paris municipal council on the 23rd of July 1871 for the Clignancourt *quartier*, and retained his seat till 1876, passing through the offices of secretary and vice-president, and becoming president in 1875. In 1876 he stood again for the Chamber of Deputies, and was elected for the 18th arrondissement. He joined the Extreme Left, and his energy and mordant eloquence speedily made him the leader of the Radical section. In 1877, after the *Seize Mai* (see FRANCE: *History*), he was one of the republican majority who denounced the Broglie ministry, and he took a leading part in resisting the anti-republican policy of which the *Seize Mai* incident was a symptom, his demand in 1879 for the indictment of the Broglie ministry bringing him into particular prominence. In 1880 he started his newspaper, *La Justice*, which became the principal organ of Parisian Radicalism; and from this time onwards throughout M. Grévy's presidency his reputation as a political critic, and as a destroyer of ministries who yet would not take office himself, rapidly grew. He led the Extreme Left in the Chamber. He was an active opponent of M. Jules Ferry's colonial policy and of the Opportunist party, and in 1885 it was his use of the Tongking disaster which principally determined the fall of the Ferry cabinet. At the elections of 1885 he advocated a strong Radical programme, and was returned both for his old seat in Paris and for the Var, selecting the latter. Refusing to form a ministry to replace the one he had overthrown, he supported the Right in keeping M. Freycinet in power in 1886, and was responsible for the inclusion of General Boulanger in the Freycinet cabinet as war minister. When Boulanger (*q.v.*) showed himself as an ambitious pretender, Clemenceau withdrew his support and became a vigorous combatant against the Boulangist movement, though the Radical press and a section of the party continued to patronize the general.

By his exposure of the Wilson scandal, and by his personal plain speaking, M. Clemenceau contributed largely to M. Grévy's resignation of the presidency in 1887, having himself declined Grévy's request to form a cabinet on the downfall of that of M. Rouvier; and he was primarily responsible, by advising his followers to vote neither for Floquet, Ferry nor Freycinet, for the election of an "outsider" as president in M. Carnot. He had arrived, however, at the height of his influence, and several factors now contributed to his decline. The split in the Radical party over Boulangism weakened his hands, and its collapse made his help unnecessary to the moderate republicans. A further misfortune occurred in the Panama affair, Clemenceau's relations with Cornelius Herz leading to his being involved

in the general suspicion; and, though he remained the leading spokesman of French Radicalism, his hostility to the Russian alliance so increased his unpopularity that in the election for 1893 he was defeated for the Chamber, after having sat in it continuously since 1876. After his defeat for the Chamber, M. Clemenceau confined his political activities to journalism, his career being further overclouded—so far as any immediate possibility of regaining his old ascendancy was concerned—by the long-drawn-out Dreyfus case, in which he took an active and honourable part as a supporter of M. Zola and an opponent of the anti-Semitic and Nationalist campaign. In 1900 he withdrew from *La Justice* to found a weekly review, *Le Bloc*, which lasted until March 1902. On the 6th of April 1902 he was elected senator for the Var, although he had previously continually demanded the suppression of the Senate. He sat with the Socialist Radicals, and vigorously supported the Combes ministry. In June 1903 he undertook the direction of the journal *L'Aurore*, which he had founded. In it he led the campaign for the revision of the Dreyfus affair, and for the separation of Church and State.

In March 1906 the fall of the Rouvier ministry, owing to the riots provoked by the inventories of church property, at last brought Clemenceau to power as minister of the interior in the Sarrien cabinet. The strike of miners in the Pas de Calais after the disaster at Courrières, leading to the threat of disorder on the 1st of May 1906, obliged him to employ the military; and his attitude in the matter alienated the Socialist party, from which he definitely broke in his notable reply in the Chamber to Jean Jaurès in June 1906. This speech marked him out as the strong man of the day in French politics; and when the Sarrien ministry resigned in October, he became premier. During 1907 and 1908 his premiership was notable for the way in which the new *entente* with England was cemented, and for the successful part which France played in European politics, in spite of difficulties with Germany and attacks by the Socialist party in connexion with Morocco (see FRANCE: *History*). But on July 20th, 1909, he was defeated in a discussion in the Chamber on the state of the navy, in which bitter words were exchanged between him and Delcassé; and he at once resigned, being succeeded as premier by M. Briand, with a reconstructed cabinet.

CLEMENCÍN, DIEGO (1765-1834), Spanish scholar and politician, was born on the 27th of September 1765, at Murcia, and was educated there at the Colegio de San Fulgencio. Abandoning his intention of taking orders, he found employment at Madrid in 1788 as tutor to the sons of the countess-duchess de Benavente, and devoted himself to the study of archaeology. In 1807 he became editor of the *Gaceta de Madrid*, and in the following year was condemned to death by Murat for publishing a patriotic article; he fled to Cadiz, and under the Junta Central held various posts from which he was dismissed by the reactionary government of 1814. During the liberal régime of 1820-1823 Clemencín took office as colonial minister, was exiled till 1827, and in 1833 published the first volume of his edition (1833-1839) of *Don Quixote*. Its merits were recognized by his appointment as royal librarian, but he did not long enjoy his triumph: he died on the 30th of July 1834. His commentary on *Don Quixote* owes something to John Bowle, and is disfigured by a patronizing, carping spirit; nevertheless it is the most valuable work of its kind, and is still unsurpassed. Clemencín is also the author of an interesting *Elogio de la reina Isabel la Católica*, published as the sixth volume of the *Memorias* of the Spanish Academy of History, to which body he was elected on the 12th of September 1800.

CLEMENT (Lat. *Clemens*, *i.e.* merciful; Gr. *Κλήμης*), the name of fourteen popes and two anti-popes.

CLEMENT I., generally known as Clement of Rome, or **CLEMENS ROMANUS** (*flor. c. A.D. 96*), was one of the "Apostolic Fathers," and in the lists of bishops of Rome is given the third or fourth place—Peter, Linus, (Anencletus), Clement. There is no ground for identifying him with the Clement of Phil. iv. 3. He may have been a freedman of T. Flavius Clemens, who was consul

with his cousin, the Emperor Domitian, in A.D. 95. A 9th-century tradition says he was martyred in the Crimea in 102; earlier authorities say he died a natural death; he is commemorated on the 23rd of November.

In *The Shepherd of Hermas* (q.v.) (Vis. 11. iv. 3) mention is made of one Clement whose office it is to communicate with other churches, and this function agrees well with what we find in the letter to the church at Corinth by which Clement is best known. Whilst being on our guard against reading later ideas into the title "bishop" as applied to Clement, there is no reason to doubt that he was one of the chief personalities in the Christian community at Rome, where since the time of Paul the separate house congregations (Rom. xvi.) had been united into one church officered by presbyters and deacons (Clem. 40-42). The letter in question was occasioned by a dispute in the church of Corinth, which had led to the ejection of several presbyters from their office. It does not contain Clement's name, but is addressed by "the Church of God which sojourneth in Rome to the Church of God which sojourneth in Corinth." But there is no reason for doubting the universal tradition which ascribes it to Clement, or the generally accepted date, c. A.D. 96. No claim is made by the Roman Church to interfere on any ground of superior rank; yet it is noteworthy that in the earliest document outside the canon which we can securely date, the church in the imperial city comes forward as a peacemaker to compose the troubles of a church in Greece. Nothing is known of the cause of the discontent; no moral offence is charged against the presbyters, and their dismissal is regarded by Clement as high-handed and unjustifiable, and as a revolt of the younger members of the community against the elder. After a laudatory account of the past conduct of the Corinthian Church, he enters upon a denunciation of vices and a praise of virtues, and illustrates his various topics by copious citations from the Old Testament scriptures. Thus he paves the way for his tardy rebuke of present disorders, which he reserves until two-thirds of his epistle is completed. Clement is exceedingly discursive, and his letter reaches twice the length of the Epistle to the Hebrews. Many of his general exhortations are but very indirectly connected with the practical issue to which the epistle is directed, and it is very probable that he was drawing largely upon the homiletical material with which he was accustomed to edify his fellow-Christians at Rome.

This view receives some support from the long liturgical prayer at the close, which almost certainly represents the intercession used in the Roman eucharists. But we must not allow such a theory to blind us to the true wisdom with which the writer defers his censure. He knows that the roots of the quarrel lie in a wrong condition of the church's life. His general exhortations, courteously expressed in the first person plural, are directed towards a wide reformation of manners. If the wrong spirit can be exorcised, there is hope that the quarrel will end in a general desire for reconciliation. The most permanent interest of the epistle lies in the conception of the grounds on which the Christian ministry rests according to the view of a prominent teacher before the 1st century has closed. The orderliness of nature is appealed to as expressing the mind of its Creator. The orderliness of Old Testament worship bears a like witness; everything is duly fixed by God, high priests, priests and Levites, and the people in the people's place. Similarly in the Christian dispensation all is in order due. "The apostles preached the gospel to us from the Lord Jesus Christ, Jesus Christ was sent from God. Christ then is from God, and the apostles from Christ. . . They appointed their first-fruits, having tested them by the Spirit, as bishops and deacons of those who should believe. . . Our apostles knew through our Lord Jesus Christ that there would be strife about the name of the bishop's office. For this cause therefore, having received perfect foreknowledge, they appointed the aforesaid, and afterwards gave a further injunction (ἐπινομήν) has now the further evidence of the Latin *legem*) that, if these should fall asleep, other approved men should succeed to their ministry. . . It will be no small sin in us if we eject from the bishop's

office those who have offered the gifts blamelessly and holily" (cc. xlii. xliiv.).

Clement's familiarity with the Old Testament points to his being a Christian of long standing rather than a recent convert. We learn from his letter (i. 7) that the church at Rome, though suffering persecution, was firmly held together by faith and love, and was exhibiting its unity in an orderly worship. The epistle was publicly read from time to time at Corinth, and by the 4th century this usage had spread to other churches. We even find it attached to the famous Alexandrian MS. (Codex A) of the New Testament, but this does not imply that it ever reached canonical rank. For the mass of early Christian literature that was gradually attached to his name see CLEMENTINE LITERATURE.

The epistle was published in 1633 by Patrick Young from Cod. Alexandrinus, in which a leaf near the end was missing, so that the great prayer (cc. lv.-lxiv.) remained unknown. In 1875 (six years after J. B. Lightfoot's first edition) Bryennius (q.v.) published a complete text from the MS. in Constantinople (dated 1055), from which in 1883 he gave us the *Didachē*. In 1876 R. L. Bensly found a complete Syriac text in a MS. recently obtained by the University library at Cambridge. Lightfoot made use of these new materials in an Appendix (1877); his second edition, on which he had been at work at the time of his death, came out in 1890. This must remain the standard edition, notwithstanding Dom Morin's most interesting discovery of a Latin version (1894), which was probably made in the 3rd century, and is a valuable addition to the authorities for the text. Its evidence is used in a small edition of the epistle by R. Knopf (Leipzig, 1899). See also W. Wrede, *Untersuchungen zum ersten Clemensbrief* (1891), and the other literature cited in Herzog-Hauck's *Realencyklopadie*, vol. iv. (A. J. G., J. A. R.)

CLEMENT II. (Suidger) became pope on the 25th of December 1046. He belonged to a noble Saxon family, was bishop of Bamberg, and chancellor to the emperor Henry III., to whom he was indebted for his elevation to the papacy upon the abdication of Gregory VI. He was the first pope placed on the throne by the power of the German emperors, but his short pontificate was only signalized by the convocation of a council in which decrees were enacted against simony. He died on the 9th of October 1047, and was buried at Bamberg. (L. D.)*

CLEMENT III. (Paolo Scolari), pope from 1187 to 1191, a Roman, was made cardinal bishop of Palestrina by Alexander III. in 1180 or 1181. On the 19th of December 1187 he was chosen at Pisa to succeed Gregory VIII. On the 31st of May 1188 he concluded a treaty with the Romans which removed difficulties of long standing, and in April 1189 he made peace with the emperor Frederick I. Barbarossa. He settled a controversy with William of Scotland concerning the choice of the archbishop of St Andrews, and on the 13th of March 1188 removed the Scottish church from under the legate jurisdiction of the archbishop of York, thus making it independent of all save Rome. In spite of his conciliatory policy, Clement angered Henry VI. of Germany by bestowing Sicily on Tancred. The crisis was acute when the pope died, probably in the latter part of March 1191.

See "Epistolae et Privilegia," in J. P. Migne, *Patrologiae cursus completus*, tom. 204 (Paris, 1853), 1253 ff., additional material in *Neues Archiv für die ältere deutsche Geschichtskunde*, 2. 219; 6. 293, 14. 178-182. P. Jaffé, *Regesta Pontificum Romanorum*, tom. 2 (2nd edition, Leipzig, 1888), 535 ff. (W. W. R.)*

CLEMENT IV. (Gui Foulques), pope from 1265 to 1268, son of a successful lawyer and judge, was born at St Gilles-sur-Rhône. He studied law, and became a valued adviser of Louis IX of France. He married, and was the father of two daughters, but after the death of his wife took orders. In 1257 he became bishop of Le Puy; in 1259 he was elected archbishop of Narbonne, and on the 24th of December 1261 Urban IV. created him cardinal bishop of Sabina. He was appointed legate in England on the 22nd of November 1263, and before his return was elected pope at Perugia on the 5th of February 1265. On the 26th of February he invested Charles of Anjou with the kingdom of Sicily; but subsequently he came into conflict with Charles, especially after the death of Manfred in February 1266. To the cruelty and avarice of Charles he opposed a generous humanity. When Conradin, the last of the Hohenstaufen, appeared in Italy the pope excommunicated him and his supporters, but it is improbable that he was in the remotest degree

responsible for his execution. At Viterbo, where he spent most of his pontificate, Clement died on the 29th of November 1268, leaving a name unsullied by nepotism. As the benefactor and protector of Roger Bacon he has a special title to the gratitude of posterity.

See A. Potthast, *Regesta Pontificum Romanorum*, vol. ii. (Berlin, 1875), 1542 ff.; E. Jordan, *Les Régistres de Clement IV* (Paris, 1893), 144 f.; Herzog-Hauck, *Realencyklopädie* (3rd ed., vol. iv., Leipzig, 1898), 144 f.; J. Heidemann, *Papst Clemens IV., I. Teil: Das Vorleben des Papstes und sein Legationsregister = Kirchengeschichtliche Studien, herausgegeben von Knöpfler, &c.*, 6. Band, 4. Heft (Münster, 1903), reprints *Processus legationis in Angliam*. (W. W. R.*)

CLEMENT V. (Bertrand de Gouth), pope from 1305 to 1314, was born of a noble Gascon family about 1264. After studying the arts at Toulouse and law at Orleans and Bologna, he became a canon at Bordeaux and then vicar-general to his brother the archbishop of Lyons, who in 1294 was created cardinal bishop of Albano. Bertrand was made a chaplain to Boniface VIII., who in 1295 nominated him bishop of Cominges (Haute Garonne), and in 1299 translated him to the archbishopric of Bordeaux. Because he attended the synod at Rome in 1302 in the controversy between France and the Pope, he was considered a supporter of Boniface VIII., yet was by no means unfavourably regarded at the French court. At Perugia on the 5th of June 1305 he was chosen to succeed Benedict XI.; the cardinals by a vote of ten to five electing one neither an Italian nor a cardinal, in order to end a conclave which had lasted eleven months. The chronicler Villani relates that Bertrand owed his election to a secret agreement with Philip IV., made at St Jean l'Angély in Saintonge; this may be dismissed as gossip, but it is probable that the future pope had to accept certain conditions laid down by the cardinals. At Bordeaux Bertrand was formally notified of his election and urged to come to Italy; but he caused his coronation to take place at Lyons on the 14th of November 1305. From the beginning Clement V. was subservient to French interests. Among his first acts was the creation of nine French cardinals. Early in 1306 he modified or explained away those features of the bulls *Clericis Laicos* and *Unam sanctam* which were particularly offensive to the king. Most of the year 1306 he spent at Bordeaux because of ill-health; subsequently he resided at Poitiers and elsewhere, and in March 1309 the entire papal court settled at Avignon, an imperial fief held by the king of Sicily. Thus began the seventy years "Babylonian captivity of the Church." On the 13th of October 1307 came the arrest of all the Knights Templar in France, the breaking of a storm conjured up by royal jealousy and greed. From the very day of Clement's coronation the king had charged the Templars with heresy, immorality and abuses, and the scruples of the weak pope were at length overcome by apprehension lest the State should not wait for the Church, but should proceed independently against the alleged heretics, as well as by the royal threats of pressing the accusation of heresy against the late Boniface VIII. In pursuance of the king's wishes Clement summoned the council of Vienne (see VIENNE, COUNCIL OF), which was unable to conclude that the Templars were guilty of heresy. The pope abolished the order, however, as it seemed to be in bad repute and had outlived its usefulness. Its French estates were granted to the Hospitallers, but actually Philip IV. held them until his death.

In his relations to the Empire Clement was an opportunist. He refused to use his full influence in favour of the candidacy of Charles of Valois, brother of Philip IV., lest France became too powerful; and recognized Henry of Luxemburg, whom his representatives crowned emperor at the Lateran in 1312. When Henry, however, came into conflict with Robert of Naples, Clement supported Robert and threatened the emperor with ban and interdict. But the crisis passed with the unexpected death of Henry, soon followed by that of the pope on the 20th of April 1314 at Roquemaure-sur-Rhône. Though the sale of offices and oppressive taxation which disgraced his pontificate may in part be explained by the desperate condition of the papal finances and by his saving up gold for a crusade, nevertheless he indulged in unbecoming pomp. Showing favouritism toward

his family and his nation, he brought untold disaster on the Church.

BIBLIOGRAPHY.—See "Clementis V. . . et aliorum epistolae," in S. Baluzius, *Vitae Papatum Avenionensium*, tom. ii. (Paris, 1693), 55 ff.; "Tractatus cum Henrico VII. imp. Germ. anno 1309," in Pertz, *Monumenta Germaniae historica*, legum ii. 1. 492-496; J. F. Rabanis, *Clement V et Philippe le Bel. Suivie du journal de la visite pastorale de Bertrand de Got dans la province ecclésiastique de Bordeaux en 1304 et 1305* (Paris, 1858); "Clementis Papae V. Constitutiones," in *Corpus Iuris Canonici*, ed. Aemilius Friedberg, vol. ii. (Leipzig, 1881), 1125-1200; P. B. Gams, *Series Episcoporum Ecclesiae Catholicae* (Regensburg, 1873); Wetzler und Welte, *Kirchenlexikon*, vol. iii. (2nd ed., Freiburg, 1884), 462-473; *Regestum Clementis Papae V. ex Vaticanis archetypis cura et studio monachorum ord. Ben. (Rome, 1885-1892)*, 9 vols. and appendix; J. Gmelin, *Schuld oder Unschuld des Tempplerordens* (Stuttgart, 1893); Gachon, *Pièces relatives au débat du pape Clément V avec l'empereur Henri VII* (Montpellier, 1894); Lacoste, *Nouvelles Études sur Clément V* (1896); Herzog-Hauck, *Realencyklopädie*, vol. iv. (3rd ed., Leipzig, 1898), 144 f.; J. Loserth, *Geschichte des späteren Mittelalters* (Munich, 1903); and A. Eitel, *Der Kirchenstaat unter Klemens V.* (Berlin, 1907). (W. W. R.*)

CLEMENT VI. (Pierre Roger), pope from the 7th of May 1342 to the 6th of December 1352, was born at Maumont in Limousin in 1291, the son of the wealthy lord of Rosières, entered the Benedictine order as a boy, studied at Paris, and became successively prior of St Baudil, abbot of Fécamp, bishop of Arras, chancellor of France, archbishop of Sens and archbishop of Rouen. He was made cardinal-priest of Sti Nereo ed Achilleo and administrator of the bishopric of Avignon by Benedict XII. in 1338, and four years later succeeded him as pope. He continued to reside at Avignon despite the arguments of envoys and the verses of Petrarch, but threw a sop to the Romans by reducing the Jubilee term from one hundred years to fifty. He appointed Cola di Rienzo to a civil position at Rome, and, although at first approving the establishment of the tribunate, he later sent a legate who excommunicated Rienzo and, with the help of the aristocratic faction, drove him from the city (December 1347). Clement continued the struggle of his predecessors with the emperor Louis the Bavarian, excommunicating him after protracted negotiations on the 13th of April 1346, and directing the election of Charles of Moravia, who received general recognition after the death of Louis in October 1347, and put an end to the schism which had long divided Germany. Clement proclaimed a crusade in 1343, but nothing was accomplished beyond a naval attack on Smyrna (29th of October 1344). He also carried on fruitless negotiations for church unity with the Armenians and with the Greek emperor, John Cantacuzenus. He tried to end the Hundred Years' War between England and France, but secured only a temporary truce. He excommunicated Casimir of Poland for marital infidelity and forced him to do penance. He successfully resisted encroachments on ecclesiastical jurisdiction by the kings of England, Castile and Aragon. He made Prague an archbishopric in 1344, and three years later founded the university there. During the disastrous plague of 1347-1348 Clement did all he could to alleviate the distress, and condemned the Flagellants and Jew-baiters. He tried Queen Joanna of Naples for the murder of her husband and acquitted her. He secured full ownership of the county of Avignon through purchase from Queen Joanna (9th of June 1348) and renunciation of feudal claims by Charles IV. of France, and considerably enlarged the papal palace in that city. To supply money for his many undertakings Clement revived the practice of selling reservations and expectancies, which had been abolished by his predecessor. Oppressive taxation and unblushing nepotism were Clement's great faults. On the other hand, he was famed for his engaging manners, eloquence and theological learning. He died on the 6th of December 1352, and was buried in the Benedictine abbey at Auvergne, but his tomb was destroyed by Calvinists in 1562. His successor was Innocent VI.

The chief sources for the life of Clement VI. are in Baluzius, *Vitae Pap. Avenion.*, vol. i. (Paris, 1693); E. Werunsly, *Excerpta ex registris Clementis VI. et Innocentii VI.* (Innsbruck, 1885); and F. Cerasoli, *Clemente VI. e Giovanni I. di Napoli—Documenti inedite dell' Archivio Vaticano* (1896, &c.).

See L. Pastor, *History of the Popes*, vol. i., trans. by F. I. Antrobus (London, 1899); F. Gregorovius, *Rome in the Middle Ages*, vol. vi. trans. by Mrs G. W. Hamilton (London, 1900-1902); J. B. Christophe,

Histoire de la papauté pendant le XIV^e siècle, vol. ii. (Paris, 1853); also article by L. Küpper in the *Kirchenlexikon* (2nd ed.). (C. H. HA.)

CLEMENT VII. (Robert of Geneva), (d. 1394), antipope, brother of Peter, count of Genevois, was connected by blood or marriage with most of the sovereigns of Europe. After occupying the episcopal sees of Théroanne and Cambrai, he attained to the cardinalate at an early age. In 1377, as legate of Pope Gregory XI. in the Romagna, he directed, or rather assisted in, the savage suppression of the revolt of the inhabitants of Cesena against the papal authority. In the following year he took part in the election of Pope Urban VI. at Rome, and was perhaps the first to express doubts as to the validity of that tumultuous election. After withdrawing to Fondi to reconsider the election, the cardinals finally resolved to regard Urban as an intruder and the Holy See as still vacant, and an almost unanimous vote was given in favour of Robert of Geneva (20th of September 1378), who took the name of Clement VII. Thus originated the Great Schism of the West.

To his high connexions and his adroitness, as well as to the gross mistakes of his rival, Clement owed the immediate support of Queen Joanna of Naples and of several of the Italian barons; and the king of France, Charles V., who seems to have been sounded beforehand on the choice of the Roman pontiff, soon became his warmest protector. Clement eventually succeeded in winning to his cause Scotland, Castile, Aragon, Navarre, a great part of the Latin East, and Flanders. He had adherents, besides, scattered through Germany, while Portugal on two occasions acknowledged him, but afterwards forsook him. From Avignon, however, where he had immediately fixed his residence, his eyes were always turned towards Italy, his purpose being to wrest Rome from his rival. To attain this end he lavished his gold—or rather the gold provided by the clergy in his obedience—without stint, and conceived a succession of the most adventurous projects, of which one at least was to leave a lasting mark on history.

By the bait of a kingdom to be carved expressly out of the States of the Church and to be called the kingdom of Adria, coupled with the expectation of succeeding to Queen Joanna, Clement incited Louis, duke of Anjou, the eldest of the brothers of Charles V., to take arms in his favour. These tempting offers gave rise to a series of expeditions into Italy carried out almost exclusively at Clement's expense, in the first of which Louis lost his life. These enterprises on several occasions planted Angevin domination in the south of the Italian peninsula, and their most decisive result was the assuring of Provence to the dukes of Anjou and afterwards to the kings of France. After the death of Louis, Clement hoped to find equally brave and interested champions in Louis' son and namesake; in Louis of Orleans, the brother of Charles VI.; in Charles VI. himself; and in John III., count of Armagnac. The prospect of his brilliant progress to Rome was ever before his eyes; and in his thoughts force of arms, of French arms, was to be the instrument of his glorious triumph over his competitor.

There came a time, however, when Clement and more particularly his following had to acknowledge the vanity of these illusive dreams; and before his death, which took place on the 16th of September 1394, he realized the impossibility of overcoming by brute force an opposition which was founded on the convictions of the greater part of Catholic Europe, and discerned among his adherents the germs of disaffection. By his vast expenditure, ascribable not only to his wars in Italy, his incessant embassies, and the necessity of defending himself in the Comtat Venaisin against the incursions of the adventurous Raymond of Turenne, but also to his luxurious tastes and princely habits, as well as by his persistent refusal to refer the question of the schism to a council, he incurred general reproach. Unity was the crying need; and men began to fasten upon him the responsibility of the hateful schism, not on the score of insincerity—which would have been very unjust,—but by reason of his obstinate persistence in the course he had chosen.

See N. Valois, *La France et le grand schisme d'occident* (Paris, 1896). (N. V.)

CLEMENT VII. (Giulio de' Medici), pope from 1523 to 1534, was the son of Giuliano de' Medici, assassinated in the conspiracy of the Pazzi at Florence, and of a certain Fioretta, daughter of Antonia. Being left an orphan he was taken into his own house by Lorenzo the Magnificent and educated with his sons. In 1494 Giulio went with them into exile; but, on Giovanni's restoration to power, returned to Florence, of which he was made archbishop by his cousin Pope Leo X., a special dispensation being granted on account of his illegitimate birth, followed by a formal declaration of the fact that his parents had been secretly married and that he was therefore legitimate. On the 23rd of September 1513 the pope conferred on him the title of cardinal and made him legate at Bologna. During the reign of the pleasure-loving Leo, Cardinal Giulio had practically the whole papal government in his hands and displayed all the qualities of a good administrator; and when, on the death of Adrian VI.—whose election he had done most to secure—he was chosen pope (Nov. 18, 1523), his accession was hailed as the dawn of a happier era. It soon became clear, however, that the qualities which had made Clement an excellent second in command were not equal to the exigencies of supreme power at a time of peculiar peril and difficulty.

Though free from the grosser vices of his predecessors, a man of taste, and economical without being avaricious, Clement VII. was essentially a man of narrow outlook and interests. He failed to understand the great spiritual movement which was convulsing the Church; and instead of bending his mind to the problem of the Reformation, he from the first subordinated the cause of Catholicism and of the world to his interests as an Italian prince and a Medici. Even in these purely secular affairs, moreover, his timidity and indecision prevented him from pursuing a consistent policy; and his ill fortune, or his lack of judgment, placed him, as long as he had the power of choice, ever on the losing side.

Clement's accession at once brought about a political change in favour of France; yet he was unable to take a strong line, and wavered between the emperor and Francis I., concluding a treaty of alliance with the French king, and then, when the crushing defeat of Pavia had shown him his mistake, making his peace with Charles (April 1, 1525), only to break it again by countenancing Girolamo Morone's League of Freedom, of which the aim was to assert the independence of Italy from foreign powers. On the betrayal of this conspiracy Clement made a fresh submission to the emperor, only to follow this, a year later, by the Holy League of Cognac with Francis I. (May 22, 1526). Then followed the imperial invasion of Italy and Bourbon's sack of Rome (May 1527) which ended the Augustan age of the papal city in a horror of fire and blood. The pope himself was besieged in the castle of St Angelo, compelled on the 6th of June to ransom himself with a payment of 400,000 scudi, and kept in confinement until, on the 26th of November, he accepted the emperor's terms, which besides money payments included the promise to convene a general council to deal with Lutheranism. On the 6th of December Clement escaped, before the day fixed for his liberation, to Orvieto, and at once set to work to establish peace. After the signature of the treaty of Cambrai on the 3rd of August 1529 Charles met Clement at Bologna and received from him the imperial crown and the iron crown of Lombardy. The pope was now restored to the greater part of his temporal power; but for some years it was exercised in subservience to the emperor. During this period Clement was mainly occupied in urging Charles to arrest the progress of the Reformation in Germany and in efforts to elude the emperor's demand for a general council, which Clement feared lest the question of the mode of his election and his legitimacy should be raised. It was due to his dependence on Charles V., rather than to any conscientious scruples, that Clement evaded Henry VIII.'s demand for the nullification of his marriage with Catherine of Aragon, and so brought about the breach between England and Rome. Some time before his death, however, the dynastic interests of his family led him once more to a rapprochement with France. On the 9th of June 1531 an agreement was

signed for the marriage of Henry of Orleans with Catherine de' Medici; but it was not till October 1533 that Clement met Francis at Marseilles, the wedding being celebrated on the 27th. Before, however, the new political alliance, thus cemented, could take effect, Clement died, on the 25th of September 1534.

See E. Casanova, *Lettere di Carlo V. a Clemente VII.* (Florence, 1893); Hugo Lämmer, *Monumenta Vaticana*, &c. (Freiburg, 1861); P. Balan, *Monumenta saeculi XVI. hist. illustr.* (Innsbruck, 1885); ib. *Mon. Reform. Luther* (Regensburg, 1884); Stefan Ehes, *Röm. Dokum. z. Gesch. der Ehescheidung Heinrichs VIII.* (Paderborn, 1893); *Calendar of State Papers* (London, 1869, &c.); J. J. I. von Döllinger, *Beiträge zur politischen, kirchlichen und Kulturgeschichte* (3 vols., Vienna, 1882); F. Guicciardini, *Istoria d'Italia*; L. von Ranke, *Die römischen Päpste in den letzten vier Jahrhunderten*, and *Deutsche Gesch. im Zeitalter der Reformation*; W. Helliwig, *Die politischen Beziehungen Clement's VII. zu Karl V.*, 1526 (Leipzig, 1889); H. Baumgarten, *Gesch. Karls V.* (Stuttgart, 1888); F. Gregorovius, *Geschichte der Stadt Rom*, vol. viii. p. 414 (2nd ed., 1874); P. Balan, *Clemente VII. e l'Italia de' suoi tempi* (Milan, 1887); E. Armstrong, *Charles the Fifth* (2 vols., London, 1902); M. Creighton, *Hist. of the Papacy during the Period of the Reformation* (London, 1882); and H. M. Vaughan, *The Medici Popes* (1908). Further references will be found in Herzog-Hauck, *Realencyklopädie*, s. *Clemens VII.* See also *Cambridge Modern History*, vol. ii. chap. i. and bibliography. (W. A. P.)

CLEMENT VIII. (Aegidius Muñoz), antipope from 1425 to the 26th of July 1429, was a canon at Barcelona until elected at Peñíscola by three cardinals whom the stubborn antipope Benedict XIII. had named on his death-bed. Clement was immediately recognized by Alphonso V. of Aragon, who was hostile to Pope Martin V. on account of the latter's opposition to his claims to the kingdom of Naples, but abdicated as soon as an agreement was reached between Alphonso and Martin through the exertions of Cardinal Pierre de Foix, an able diplomat and relation of the king's. Clement spent his last years as bishop of Majorca, and died on the 28th of December 1446.

See L. Pastor, *History of the Popes*, vol. i. trans. by F. I. Antrobus (London, 1899); M. Creighton, *History of the Papacy*, vol. ii. (London, 1899); and consult bibliography on MARTIN V. (C. H. HA.)

CLEMENT VIII. (Ippolito Aldobrandini), pope from 1592 to 1605, was born at Fano, in 1535. He became a jurist and filled several important offices. In 1585 he was made a cardinal, and subsequently discharged a delicate mission to Poland with skill. His moderation and experience commended him to his fellow cardinals, and on the 30th of January 1592 he was elected pope, to succeed Innocent IX. While not hostile to Philip II., Clement desired to emancipate the papacy from undue Spanish influence, and to that end cultivated closer relations with France. In 1595 he granted absolution to Henry IV., and so removed the last objection to the acknowledgment of his legitimacy. The peace of Vervins (1598), which marked the end of Philip's opposition to Henry, was mainly the work of the pope. Clement also entertained hopes of recovering England. He corresponded with James I. and with his queen, Anne of Denmark, a convert to Catholicism. But James was only half in earnest, and, besides, dared not risk a breach with his subjects. Upon the failure of the line of Este, Clement claimed the reversion of Ferrara and reincorporated it into the States of the Church (1598). He remonstrated against the exclusion of the Jesuits from France, and obtained their readmission. But in their doctrinal controversy with the Dominicans (see MOLINA, LUIS) he refrained from a decision, being unwilling to offend either party. Under Clement the publication of the revised edition of the Vulgate, begun by Sixtus V., was finished; the Breviary, Missal and Pontifical received certain corrections; the Index was expanded; the Vatican library enlarged; and the Collegium Clementinum founded. Clement was an unblushing nepotist; three of his nephews he made cardinals, and to one of them gradually surrendered the control of affairs. But on the other hand among those whom he promoted to the cardinalate were such men as Baronius, Bellarmine and Toledo. During this pontificate occurred the burning of Giordano Bruno for heresy; and the tragedy of the Cenci (see the respective articles). Clement died on the 5th of March 1605, and was succeeded by Leo XI.

See the contemporary life by Ciaconius, *Vitae et res gestae summorum Pontiff. Rom.* (Rome, 1601-1602); Francolini, *Ippolito*

Aldobrandini, che fu Clemente VIII. (Perugia, 1867); Ranke's excellent sketch, *Popes* (Eng. trans. Austin), ii. 234 seq.; v. Reumont, *Gesch. der Stadt Rom*, iii. 2, 599 seq.; Brosch, *Gesch. des Kirchenstaates* (1880), i. 301 seq. (T. F. C.)

CLEMENT IX. (Giulio Rospigliosi) was born in 1600, became successively auditor of the Rota, archbishop of Tarsus in *partibus*, and cardinal, and was elected pope on the 20th of June 1667. He effected a temporary adjustment of the Jansenist controversy; was instrumental in concluding the peace of Aix-la-Chapelle (1668); healed a long-standing breach between the Holy See and Portugal; aided Venice against the Turks, and laboured unceasingly for the relief of Crete, the fall of which hastened his death on the 9th of October 1669.

See Oldoino, continuator of Ciaconius, *Vitae et res gestae summorum Pontiff. Rom.*; Palazzi, *Gesta Pontiff. Rom.* (Venice, 1687-1688), iv. 621 seq. (both contemporary); Ranke, *Popes* (Eng. trans. Austin), iii. 59 seq.; and v. Reumont, *Gesch. der Stadt Rom*, iii. 2, 634 seq. (T. F. C.)

CLEMENT X. (Emilio Altieri) was born in Rome, on the 13th of July 1590. Before becoming pope, on the 29th of April 1670 he had been auditor in Poland, governor of Ancona, and nuncio in Naples. His advanced age induced him to resign the control of affairs to his adopted nephew, Cardinal Paluzzi, who embroiled the papacy in disputes with the resident ambassadors, and incurred the enmity of Louis XIV., thus provoking the long controversy over the regalia (see INNOCENT XI.). Clement died on the 22nd of July 1676.

See Guarnacci, *Vitae et res gestae Pontiff. Rom.* (Rome, 1751), (contin. of Ciaconius), i. 1 seq.; Palazzi, *Gesta Pontiff. Rom.* (Venice, 1687-1688), iv. 655 seq.; and Ranke, *Popes* (Eng. trans. Austin), iii. 172 seq. (T. F. C.)

CLEMENT XI. (Giovanni Francesco Albani), pope from 1700 to 1721, was born in Urbino, on the 22nd of July 1649, received an extraordinary education in letters, theology and law, filled various important offices in the Curia, and finally, on the 23rd of November 1700, succeeded Innocent XII. as pope. His private life and his administration were blameless, but it was his misfortune to reign in troublous times. In the war of the Spanish Succession he would willingly have remained neutral, but found himself between two fires, forced first to recognize Philip V., then driven by the emperor to recognize the Archduke Charles. In the peace of Utrecht he was ignored; Sardinia and Sicily, Parma and Piacenza, were disposed of without regard to papal claims. When he quarrelled with the duke of Savoy, and revoked his investiture rights in Sicily (1715), his interdict was treated with contempt. The prestige of the papacy had hardly been lower within two centuries. About 1702 the Jansenist controversy broke out afresh. Clement reaffirmed the infallibility of the pope, in matters of *fact* (1705), and, in 1713, issued the bull *Unigenitus*, condemning 101 Jansenistic propositions extracted from the *Moral Reflections* of Pasquier Quesnel. The rejection of this bull by certain bishops led to a new party division and a further prolonging of the controversy (see JANSENISM and QUESNEL, PASQUIER). Clement also forbade the practice of the Jesuit missionaries in China of "accommodating" their teachings to pagan notions or customs, in order to win converts. Clement was a polished writer, and a generous patron of art and letters. He died on the 19th of March 1721.

For contemporary lives see Elci, *The Present State of the Court of Rome*, trans. from the Ital. (London, 1706); Polidoro, *De Vita et Reb. Gest. Clem. XI.* (Urbino, 1727); Reboulet, *Hist. de Clem. XI. Pape* (Avignon, 1752); Guarnacci, *Vitae et res gest. Pontiff. Rom.* (Rome, 1751); Sandini, *Vitae Pontiff. Rom.* (Padua, 1739); Buder, *Leben u. Thaten Clementis XI.* (Frankfort, 1720-1721). See also *Clementis XI. Opera Omnia* (Frankfort, 1729); the detailed "Studi sul pontificato di Clem. XI.," by Pometti in the *Archivio della R. Soc. romana di storia patria*, vols. 21, 22, 23 (1898-1900), and the extended bibliography in Hergenröther, *Allg. Kirchengesch.* (1880), iii. 506. (T. F. C.)

CLEMENT XII. (Lorenzo Corsini), pope from 1730 to 1740, succeeded Benedict XIII. on the 12th of July 1730, at the age of seventy-eight. The rascally Cardinal Coscia, who had deluded Benedict, was at once brought to justice and forced to disgorge his dishonest gains. Politically the papacy had sunk to the level of pitiful helplessness, unable to resist the aggressions of the Powers, who ignored or coerced it at will. Yet Clement

entertained high hopes for Catholicism; he laboured for a union with the Greek Church, and was ready to facilitate the return of the Protestants of Saxony. He deserves well of posterity for his services to learning and art; the restoration of the Arch of Constantine; the enrichment of the Capitoline museum with antique marbles and inscriptions, and of the Vatican library with oriental manuscripts (see ASSEMANI); and the embellishment of the city with many buildings. He died on the 6th of February 1740, and was succeeded by Benedict XIV.

See Guarnacci, *Vitae et res gestae Pontiff. Rom.* (Rome, 1751); Sandini, *Vitae Pontiff. Rom.* (Padua, 1739); Fabroni, *De Vita et Reb. Gest. Clementis XII.* (Rome, 1760); Ranke, *Popes* (Eng. trans. Austin), iii. 191 seq.; v. Reumont, *Gesch. der Stadt Rom*, iii. 2, 653 seq. (T. F. C.)

CLEMENT XIII. (Carlo della Torre Rezzonico), pope from 1758 to 1769, was born in Venice, on the 7th of March 1693, filled various important posts in the Curia, became cardinal in 1737, bishop of Padua in 1743, and succeeded Benedict XIV. as pope on the 6th of July 1758. He was a man of upright, moderate and pacific intentions, but his pontificate of eleven years was anything but tranquil. The Jesuits had fallen upon evil days; in 1758 Pombal expelled them from Portugal; his example was followed by the Bourbon countries—France, Spain, the Two Sicilies and Parma (1764–1768). The order turned to the pope as its natural protector; but his protests (cf. the bull *Apostolicum pascendi munus*, 7th of January 1765) were unheeded (see JESUITS). A clash with Parma occurred to aggravate his troubles. The Bourbon kings espoused their relative's quarrel, seized Avignon, Benevento and Ponte Corvo, and united in a peremptory demand for the suppression of the Jesuits (January 1769). Driven to extremities, Clement consented to call a Consistory to consider the step, but on the very eve of the day set for its meeting he died (2nd of February 1769), not without suspicion of poison, of which, however, there appears to be no conclusive evidence.

A contemporary account of Clement was written by Augustin de Andrés y Sobinas, . . . *el nacimiento, estudios y empleos de . . . Clem. XIII.* (Madrid, 1759). Ravignan's *Clement XIII. e Clement XIV.* (Paris, 1854) is partisan but free from rancour; and appends many interesting documents. See also the bibliographical note under Clement XIV. *infra*; and the extended bibliography in Hergenröther, *Allg. Kirchengesch.* (1880), iii. 509. (T. F. C.)

CLEMENT XIV. (Lorenzo Ganganelli), pope from 1769 to 1774, son of a physician of St Arcangelo, near Rimini, was born on the 31st of October 1705, entered the Franciscan order at the age of seventeen, and became a teacher of theology and philosophy. As regent of the college of S. Bonaventura, Rome, he came under the notice of Benedict XIV., who conceived a high opinion of his talents and made him consulter of the Inquisition. Upon the recommendation of Ricci, general of the Jesuits, Clement XIII. made him a cardinal; but, owing to his disapproval of the pope's policy, he found himself out of favour and without influence. The conclave following the death of Clement XIII. was the most momentous of at least two centuries. The fate of the Jesuits hung in the balance; and the Bourbon princes were determined to have a pope subservient to their hostile designs. The struggle was prolonged three months. At length, on the 19th of May 1769, Ganganelli was chosen, not as a declared enemy of the Jesuits, but as being least objectionable to each of the contending factions. The charge of simony was inspired by Jesuit hatred; there is absolutely no evidence that Ganganelli pledged himself to suppress the order.

The outlook for the papacy was dark; Portugal was talking of a patriarchate; France held Avignon; Naples held Ponte Corvo and Benevento; Spain was ill-affected; Parma, defiant; Venice, aggressive; Poland meditating a restriction of the rights of the nuncio. Clement realized the imperative necessity of conciliating the powers. He suspended the public reading of the bull *In Coena Domini*, so obnoxious to civil authority; resumed relations with Portugal; revoked the *monitorium* of his predecessor against Parma. But the powers were bent upon the destruction of the Jesuits, and they had the pope at their mercy. Clement looked abroad for help, but found none. Even Maria Theresa, his last hope, suppressed the order in Austria.

Temporizing and partial concessions were of no avail. At last, convinced that the peace of the Church demanded the sacrifice, Clement signed the brief *Dominus ac Redemptor*, dissolving the order, on the 21st of July 1773. The powers at once gave substantial proof of their satisfaction; Benevento, Ponte Corvo, Avignon and the Venaissin were restored to the Holy See. But it would be unfair to accept this as evidence of a bargain. Clement had formerly indignantly rejected the suggestion of such an exchange of favours.

There is no question of the legality of the pope's act; whether he was morally culpable, however, continues to be a matter of bitter controversy. On the one hand, the suppression is denounced as a base surrender to the forces of tyranny and irreligion, an act of treason to conscience, which reaped its just punishment of remorse; on the other hand, it is as ardently maintained that Clement acted in full accord with his conscience, and that the order merited its fate by its own mischievous activities which made it an offence to religion and authority alike. But whatever the guilt or innocence of the Jesuits, and whether their suppression were ill-advised or not, there appears to be no ground for impeaching the motives of Clement, or of doubting that he had the approval of his conscience. The stories of his having swooned after signing the brief, and of having lost hope and even reason, are too absurd to be entertained. The decline in health, which set in shortly after the suppression, and his death (on the 22nd of September 1774) proceeded from wholly natural causes. The testimony of his physician and of his confessor ought to be sufficient to discredit the oft-repeated story of slow poisoning (see Duhr, *Jesuiten Fabeln*, 4th ed., 1904, pp. 69 seq.).

The suppression of the Jesuits bulks so large in the pontificate of Clement that he has scarcely been given due credit for his praiseworthy attempt to reduce the burdens of taxation and to reform the financial administration, nor for his liberal encouragement of art and learning, of which the museum Pio-Clementino is a lasting monument.

No pope has been the subject of more diverse judgments than Clement XIV. Zealous defenders credit him with all virtues, and bless him as the instrument divinely ordained to restore the peace of the Church; virulent detractors charge him with ingratitude, cowardice and double-dealing. The truth is at neither extreme. Clement's was a deeply religious and poetical nature, animated by a lofty and refined spirit. Gentleness, equanimity and benevolence were native to him. He cherished high purposes and obeyed a lively conscience. But he instinctively shrank from conflict; he lacked the resoluteness and the sterner sort of courage that grapples with a crisis.

Caraccioli's *Vie de Clément XIV* (Paris, 1775) (freq. translated), is incomplete, uncritical and too laudatory. The middle of the 19th century saw quite a spirited controversy over Clement XIV.; St Priest, in his *Hist. de la école des Jésuites* (Paris, 1846), represented Clement as lamentably, almost culpably, weak; Cretineau-Joly, in his *Hist. . . de la Comp. de Jésus* (Paris, 1844–1845, and his *Clément XIV et les Jésuites* (Paris, 1847), was outspoken and bitter in his condemnation; this provoked Theiner's *Gesch. des Pontificats Clemens' XIV.* (Leipzig and Paris, 1852), a vigorous defence based upon original documents to which, as custodian of the Vatican archives, the author had freest access; Cretineau-Joly replied with *Le Pape Clément XIV; Lettres au P. Theiner* (Paris, 1852). Ravignan's *Clem. XIII. e Clem. XIV.* (Paris, 1854) is a weak, half-hearted apology for Clement XIV. See also v. Reumont, *Ganganelli, Papst Clemens XIV.* (Berlin, 1847); and Reinerding, *Clemens XIV. u. d. Aufhebung der Gesellschaft Jesu* (Augsburg, 1854). The letters of Clement have frequently been printed; the genuineness of Caraccioli's collection (Paris, 1776; freq. translated) has been questioned, but most of the letters are now generally accepted as genuine; see also *Clementis XIV. Epp. ac Brevia*, ed. Theiner (Paris, 1852). An extended bibliography is to be found in Hergenröther, *Allg. Kirchengesch.* (1880), iii. 510 seq. (T. F. C.)

CLEMENT OF ALEXANDRIA (*Clemens Alexandrinus*), Greek Father of the Church. The little we know of him is mainly derived from his own works. He was probably born about A.D. 150 of heathen parents in Athens. The earliest writer after himself who gives us any information with regard to him is Eusebius. The only points on which his works now extant inform us are his date and his instructors. In the *Stromateis*,

while attempting to show that the Jewish Scriptures were older than any writings of the Greeks, he invariably brings down his dates to the death of Commodus, a circumstance which at once suggests that he wrote in the reign of the emperor Severus, from 193 to 211 A.D. (see *Strom.* lib. i. cap. xxi. 140, p. 403, Potter's edition). The passage in regard to his teachers is corrupt, and the sense is therefore doubtful (*Strom.* lib. i. cap. i. 11, p. 322, P.).

"This treatise," he says, speaking of the *Stromateis*, "has not been contrived for mere display, but memoranda are treasured up in it for my old age to be a remedy for forgetfulness,—an image, truly, and an outline of those clear and living discourses, and those men truly blessed and noteworthy I was privileged to hear. One of these was in Greece, the Ionian, the other was in Magna Graecia; the one of them was from Coele Syria, the other from Egypt; but there were others in the East, one of whom belonged to the Assyrians, but the other was in Palestine, originally a Jew. The last of those whom I met was first in power. On falling in with him I found rest, having tracked him while he lay concealed in Egypt. He was in truth the Sicilian bee, and, plucking the flowers of the prophetic and apostolic meadow, he produced a wonderfully pure knowledge in the souls of the listeners."

Some have supposed that in this passage seven teachers are named, others that there are only five, and various conjectures have been hazarded as to what persons were meant. The only one about whom conjecture has any basis for speculating is the last, for Eusebius states (*H.E.* v. 11) that Clement made mention of Pantaeus as his teacher in the *Hypotyposes*. The reference in this passage is plainly to one whom he might well designate as his teacher.

To the information which Clement here supplies subsequent writers add little. By Eusebius and Photius he is called Titus Flavius Clemens, and "the Alexandrian" is added to his name. Epiphanius tells us that some said Clement was an Alexandrian, others that he was an Athenian (*Haer.* xxxii. 6), and a modern writer imagined that he reconciled this discordance by the supposition that he was born at Athens, but lived at Alexandria. We know nothing of his conversion except that he passed from heathenism to Christianity. This is expressly stated by Eusebius (*Praep. Evangel.* lib. ii. cap. 2), though it is likely that Eusebius had no other authority than the works of Clement. These works, however, warrant the inference. They show a singularly minute acquaintance with the ceremonies of pagan religion, and there are indications that Clement himself had been initiated in some of the mysteries (*Protrept.* cap. ii. sec. 14, p. 13, P.). There is no means of determining the date of his conversion. He attained the position of presbyter in the church of Alexandria (*Eus. H.E.* vi. 11, and Jerome, *De Vir. Ill.* 38), and became perhaps the assistant, and certainly the successor of Pantaeus in the catechetical school of that place. Among his pupils were Origen (*Eus. H.E.* vi. 7) and Alexander, bishop of Jerusalem (*Eus. H.E.* vi. 14.). How long he continued in Alexandria, and when and where he died, are all matters of pure conjecture. The only further notice of Clement that we have in history is in a letter written in 211 by Alexander, bishop of Jerusalem, to the Antiochians, and preserved by Eusebius (*H.E.* vi. 11). The words are as follows:—"This letter I sent through Clement the blessed presbyter, a man virtuous and tried, whom ye know and will come to know completely, who being here by the providence and guidance of the Ruler of all strengthened and increased the church of the Lord." A statement of Eusebius in regard to the persecution of Severus in 202 (*H.E.* vi. 3) would render it likely that Clement left Alexandria on that occasion. It is conjectured that he went to his old pupil Alexander, who was at that time bishop of Flaviada in Cappadocia, and that when his pupil was raised to the see of Jerusalem Clement followed him there. The letter implies that he was known to the Antiochians, and that it was likely he would be still better known. Some have conjectured that he returned to Alexandria, but there is not the shadow of evidence for such conjecture. Alexander, writing to Origen (c. 216), mentions Clement as dead (*Eus. H.E.* vi. 14, 9).

Eusebius and Jerome give us lists of the works which Clement left behind him. Photius has also described some of them. They are as follows:—(1) Πρὸς Ἕλληνας λόγος ὁ προτροπικός, *A Hortatory Address to the Greeks*. (2) Ὁ Παιδαγωγός, *The Tutor*, in three books. (3) Στρωματεῖς, or *Patch-work*, in eight books. (4) Τίς ὁ σωζόμενος

πλοῖτος; *Who is the Rich Man that is Saved?* (5) Eight books of Τροπαιῶσαι, *Adumbrations or Outlines*. (6) *On the Passover*. (7) *Discourses on Fasting*. (8) *On Slander*. (9) *Exhortation to Patience, or to the Newly Baptized*. (10) Τὰ Κανὼν ἐκκλησιαστικῶς, *the Rule of the Church, or to those who Judaize*, a work dedicated to Alexander, bishop of Jerusalem.

Of these, the first four have come down to us complete, or nearly complete. The first three form together a progressive introduction to Christianity corresponding to the stages through which the μύστης passed at Eleusis—purification, initiation, revelation. The *Hortatory Address to the Greeks* is an appeal to them to give up the worship of their gods, and to devote themselves to the worship of the one living and true God. Clement exhibits the absurdity and immorality of the stories told with regard to the pagan deities, the cruelties perpetrated in their worship, and the utter uselessness of bowing down before images made by hands. He at the same time shows the Greeks that their own greatest philosophers and poets recognized the unity of the divine Being, and had caught glimpses of the true nature of God, but that fuller light had been thrown on this subject by the Hebrew prophets. He replies to the objection that it was not right to abandon the customs of their forefathers, and points them to Christ as their only safe guide to God.

The *Paedagogue* is divided into three books. In the first Clement discusses the necessity for and the true nature of the Paedagogus, and shows how Christ as the Logos acted as Paedagogus, and still acts. In the second and third books Clement enters into particulars, and explains how the Christian following the Logos or Reason ought to behave in the various circumstances of life—in eating, drinking, furnishing a house, in dress, in the relations of social life, in the care of the body, and similar concerns, and concludes with a general description of the life of a Christian. Appended to the *Paedagogue* are two hymns, which are, in all probability, the production of Clement, though some have conjectured that they were portions of the church service of that time. στρωματεῖς were bags in which bedclothes (στρώματα) were kept. The phrase was used as a book-title by Origen and others, and is equivalent to our "miscellanies." It is difficult to give a brief account of the varied contents of the book. Sometimes Clement discusses chronology, sometimes philosophy, sometimes poetry, entering into the most minute critical and chronological details; but one object runs through all, and this is to show what the true Christian Gnostic is, and what is his relation to philosophy. The work was in eight books. The first seven are complete. The eighth now extant is really an incomplete treatise on logic. Some critics have rejected this book as spurious, since its matter is so different from that of the rest. Others, however, have held to its genuineness, because in a Patch-work or Book of Miscellanies the difference of subject is no sound objection, and because Photius seems to have regarded our present eighth book as genuine (*Phot. cod.* iii. p. 89b, Bekker).

The treatise *Who is the Rich Man that is Saved?* is an admirable exposition of the narrative contained in St Mark's Gospel x. 17-31. Here Clement argues that wealth, if rightly used, is not unchristian.

The *Hypotyposes*¹ in eight books, have not come down to us. Cassiodorus translated them into Latin, freely altering to suit his own ideas of orthodoxy. Both Eusebius and Photius describe the work. It was a short commentary on all the books of Scripture, including some of the apocryphal works, such as the Epistle of Barnabas and the Revelation of Peter. Photius speaks in strong language of the impiety of some opinions in the book (*Bibl. cod.* 109, p. 89 a Bekker), but his statements are such as to prove conclusively that he must have had a corrupt copy, or read very carelessly, or grossly misunderstood Clement. Notes in Latin on the first epistle of Peter, the epistle of Jude, and the first two of John have come down to us; but whether they are the translation of Cassiodorus, or indeed a translation of Clement's work at all, is a matter of dispute.

The treatise on the Passover was occasioned by a work of Melito on the same subject. Two fragments of this treatise were given by Petavius, and are contained in the modern editions.

We know nothing of the work called *The Ecclesiastical Canon* from any external testimony. Clement himself often mentions the ἐκκλησιαστικῶς κανὼν, and defines it as the agreement and harmony of the law and the prophets with the covenant delivered at the appearance of Christ (*Strom.* vi. cap. xv. 125, p. 803, P.). No doubt this was the subject of the treatise. Jerome and Photius call the work *Ecclesiastical Canons*, but this seems to be a mistake.

Of the other treatises mentioned by Eusebius and Jerome nothing is known. A fragment of Clement, quoted by Antonius Melissa, is most probably taken from the treatise on slander.

Besides the treatises mentioned by Eusebius, fragments of treatises on Providence and the Soul have been preserved. Mention is also made of a work by Clement on the Prophet Amos, and another on Definitions.

In addition to these Clement often speaks of his intention to write on certain subjects, but it may well be doubted whether in most cases, if not all, he intended to devote separate treatises to

¹ Zahn thinks we have part of them in the *Adumbrationes Clem. Alex. in epistolas canonicas* (Codex Lindum, 96, sec. ix.). They were perhaps intended as a completion of the preceding course.

them. Some have found an allusion to the treatise on the Soul already mentioned. The other subjects are Marriage (*γαμικός λόγος*), Contenance, the Duties of Bishops, Presbyters, Deacons and Widows, Prophecy, the Soul, the Transmigration of the Soul and the Devil, Angels, the Origin of the World, First Principles and the Divinity of the Logos, Allegorical Interpretations of Statements made with regard to God's anger and similar affections, the Unity of the Church, and the Resurrection.

Two works are incorporated in the editions of Clement which are not mentioned by himself or any ancient writer. They are *Ἐκ τῶν Θεοδοῦτου καὶ τῆς ἀνατολικῆς καλουμένης διδασκαλίας κατὰ τοὺς Οὐαλεντινοῦ χρόνους ἐπιτομαί*, and *Ἐκ τῶν προφητικῶν ἐκλογαί*. The first, if it is the work of Clement, must be a book merely of excerpts, for it contains many opinions which Clement opposed. Mention is made of Pantæus in the second, and some have thought it more worthy of him than the first. Others have regarded it as a work similar to the first, and derived from Theodorus.

Clement occupies a profoundly interesting position in the history of Christianity. He is the first to bring all the culture of the Greeks and all the speculations of the Christian heretics to bear on the exposition of Christian truth. He does not attain to a systematic exhibition of Christian doctrine, but he paves the way for it, and lays the first stones of the foundation. In some respects Justin anticipated him. He also was well acquainted with Greek philosophy, and took a genial view of it; but he was not nearly so widely read as Clement. The list of Greek authors whom Clement has quoted occupies upwards of fourteen of the quarto pages in Fabricius's *Bibliotheca Græca*. He is at home alike in the epic and the lyric, the tragic and the comic poets, and his knowledge of the prose writers is very extensive. Some, however, of the classic poets he appears to have known only from anthologies; hence he was misled into quoting as from Euripides and others verses which were written by Jewish forgers. He made a special study of the philosophers. Equally minute is his knowledge of the systems of the Christian heretics. And in all cases it is plain that he not merely read but thought deeply on the questions which the civilization of the Greeks and the various writings of poets, philosophers and heretics raised. But it was in the Scriptures that he found his greatest delight. He believed them to contain the revelation of God's wisdom to men. He quotes all the books of the Old Testament except Ruth and the Song of Solomon, and amongst the sacred writings of the Old Testament he evidently included the book of Tobit, the Wisdom of Solomon and Ecclesiasticus. He is equally full in his quotations from the New Testament, for he quotes from all the books except the epistle to Philemon, the second epistle of St Peter, and the epistle of St James, and he quotes from *The Shepherd of Hermas*, and the epistles of Clemens Romanus and of Barnabas, as inspired. He appeals also to many of the lost gospels, such as those of the Hebrews, of the Egyptians and of Matthias.

Notwithstanding this adequate knowledge of Scripture, the modern theologian is disappointed to find very little of what he deems characteristically Christian. In fact Clement regarded Christianity as a philosophy. The ancient philosophers sought through their philosophy to attain to a nobler and holier life, and this also was the aim of Christianity. The difference between the two, in Clement's judgment, was that the Greek philosophers had only glimpses of the truth, that they attained only to fragments of the truth, while Christianity revealed in Christ the absolute and perfect truth. All the stages of the world's history were therefore preparations leading up to this full revelation, and God's care was not confined to the Hebrews alone. The worship of the heavenly bodies, for instance, was given to man at an early stage that he might rise from a contemplation of these sublime objects to the worship of the Creator. Greek philosophy in particular was the preparation of the Greeks for Christ. It was the schoolmaster or paedagogue to lead them to Christ. Plato was Moses attizing. Clement varies in his statement how Plato got his wisdom or his fragments of the Reason. Sometimes he thinks that they came direct from God, like all good things, but he is also fond of maintaining that many of Plato's best thoughts were borrowed from the Hebrew prophets; and he makes the same statement in regard to the wisdom of the other philosophers. But however this may be,

Christ was the end to which all that was true in philosophies pointed. Christ himself was the Logos, the Reason. God the Father was ineffable. The Son alone can manifest Him fully. He is the Reason that prevades the universe, that brings out all goodness, that guides all good men. It was through possessing somewhat of this Reason that the philosophers attained to any truth and goodness; but in Christians he dwells more fully and guides them through all the perplexities of life. Photius, probably on a careless reading of Clement, argued that he could not have believed in a real incarnation. But the words of Clement are quite precise and their meaning indisputable. The real difficulty attaches not to the Second Person, but to the First. The Father in Clement's mind becomes the Absolute of the philosophers, that is to say, not the Father at all, but the Monad, a mere point devoid of all attributes. He believed in a personal Son of God who was the Reason and Wisdom of God; and he believed that this Son of God really became incarnate though he speaks of him almost invariably as the Word, and attaches little value to his human nature. The object of his incarnation and death was to free man from his sins, to lead him into the path of wisdom, and thus in the end elevate him to the position of a god. But man's salvation was to be gradual. It began with faith, passed from that to love, and ended in full and complete knowledge. There could be no faith without knowledge. But the knowledge is imperfect, and the Christian was to do many things in simple obedience without knowing the reason. But he has to move upwards continually until he at length does nothing that is evil, and he knows fully the reason and object of what he does. He thus becomes the true Gnostic, but he can become the true Gnostic only by contemplation and by the practice of what is right. He has to free himself from the power of passion. He has to give up all thoughts of pleasure. He must prefer goodness in the midst of torture to evil with unlimited pleasure. He has to resist the temptations of the body, keeping it under strict control, and with the eye of the soul undimmed by corporal wants and impulses, contemplate God the supreme good, and live a life according to reason. In other words, he must strive after likeness to God as he reveals himself in his Reason or in Christ. Clement thus looks entirely at the enlightened moral elevation to which Christianity raises man. He believed that Christ instructed men before he came into the world, and he therefore viewed heathenism with kindly eye. He was also favourable to the pursuit of all kinds of knowledge. All enlightenment tended to lead up to the truths of Christianity, and hence knowledge of every kind not evil was its handmaid. Clement had at the same time a strong belief in evolution or development. The world went through various stages in preparation for Christianity. The man goes through various stages before he can reach Christian perfection. And Clement conceived that this development took place not merely in this life, but in the future through successive grades. The Jew and the heathen had the gospel preached to them in the world below by Christ and his apostles, and Christians will have to pass through processes of purification and trial after death before they reach knowledge and perfect bliss.

The beliefs of Clement have caused considerable difference of opinion among modern scholars. He sought the truth from whatever quarter he could get it, believing that all that is good comes from God, wherever it be found. He belongs therefore to no school of philosophers. He calls himself an Eclectic. He was in the main a Neoplatonist, drawing from that school his doctrines of the Monad and his strong tendency towards mysticism. For his moral doctrine he borrowed freely from Stoicism. Aristotelian features may be found but are quite subordinate. But Clement always regards the articles of the Christian creed as the axioms of a new philosophy. Dæhne had tried to show that he was Neoplatonic, and Reinkens has maintained that he was essentially Aristotelian. His mode of viewing Christianity does not fit into any classification. It is the result of the period in which he lived, of his wide culture and the simplicity and noble purity of his character.

It is needless to say that his books well deserve study; but

the study is not smoothed by simplicity of style. Clement professed to despise rhetoric, but was himself a rhetorician, and his style is turgid, involved and difficult. He is singularly simple in his character. In discussing marriage he refuses to use any but the plainest language. A euphemism is with him a falsehood. But he is temperate in his opinions; and the practical advices in the second and third books of the *Paedagogus* are remarkably sound and moderate. He is not always very critical, and he is passionately fond of allegorical interpretations, but these were the faults of his age.

All early writers speak of Clement in the highest terms of laudation, and he certainly ought to have been a saint in any Church that reveres saints. But Clement is not a saint in the Roman Church. He was a saint up till the time of Benedict XIV., who read Photius on Clement, believed him, and struck the Alexandrian's name out of the calendar. But many Roman Catholic writers, though they yield a practical obedience to the papal decision, have adduced good reason why it should be reversed (Cognat, p. 451).

EDITIONS.—The standard edition of the collected works will be that of O. Stählin (first vol. containing *Protrepticus* and *Paedagogus*, Leipzig, 1905). Separate editions of *Strom.* vii., Hort and Major (1902); *Q.D.S.*, Barnard in *Texts and Studies*, v. 2 (1897); W. Dindorf's edition in 4 vols. (Oxford, 1869) is little more than a reprint of the text of Bishop Potter, 1715. For the *Fragments* see Zahn, *Forschungen zur Gesch. des neut. Kanons*, part iii., or Harnack and Preuschen, *Gesch. der altch. Litt.*, vol. i.

LITERATURE.—A copious bibliography will be found in Harnack, *Chronologie*, vol. ii., or in Bardenhewer, *Gesch. der altch. Lit.* Either of these will supply the names of works upon Clement's biblical text, his use of Stoic writers, his quotations from heathen writers, and his relation to heathen philosophy. A valuable book is de Faye, *Clém. d'Alex.* (1898). For his theological position see Harnack, *Dogmengeschichte*; Hort, *Six Lectures on the Ante-Nicene Fathers*; Westcott, "Clem. of Alex." in *Dict. Christ. Biog.*; Bigg, *Christian Platonists of Alex.* (1886). A book on Clement's relation to Mysticism is wanted. (C. B.: J. D.)

CLÉMENT, FRANÇOIS (1714-1793), French historian, was born at Bèze, near Dijon, and was educated at the Jesuit College at Dijon. At the age of seventeen he entered the society of the Benedictines of Saint Maur, and worked with such intense application that at the age of twenty-five he was obliged to take a protracted rest. He now resided in Paris, where he wrote the 11th and 12th vols. of the *Histoire littéraire de la France*, and edited (with Dom Brial) the 12th and 13th vols. of the *Recueil des historiens des Gaules et de la France*. The king appointed him on the committee which was engaged in publishing charters, diplomas and other documents connected with French history (see Xavier Charmes, *Le Comité des travaux historiques et scientifiques*, vol. i., 1886, *passim*); and the Academy of Inscriptions chose him as a member (1785). Dom Clément also revised the *Art de vérifier les dates*, edited in 1750 by Dom Clémencet. Three volumes with the Indexes appeared from 1783 to 1792. He was engaged in preparing another volume including the period before the Christian era, when he died suddenly of apoplexy, at the age of sixty-nine. The work was afterwards brought down from 1770 to 1827 by Julien de Courcelles and Fortia d'Urban.

CLÉMENT, JACQUES (1567-1589), murderer of the French king Henry III., was born at Sorbon in the Ardennes, and became a Dominican friar. Civil war was raging in France, and Clément became an ardent partisan of the League; his mind appears to have become unhinged by religious fanaticism, and he talked of exterminating the heretics, and formed a plan to kill Henry III. His project was encouraged by some of the heads of the League; he was assured of temporal rewards if he succeeded, and of eternal bliss if he failed. Having obtained letters for the king, he left Paris on the 31st of July 1589, and reached St Cloud, the headquarters of Henry, who was besieging Paris. On the following day he was admitted to the royal presence, and presenting his letters he told the king that he had an important and confidential message to deliver. The attendants then withdrew, and while Henry was reading the letters Clément mortally wounded him with a dagger which had been concealed beneath his cloak. The assassin was at once killed by the attendants who rushed in, and Henry died early on the

following day. Clément's body was afterwards quartered and burned. This deed, however, was viewed with far different feelings in Paris and by the partisans of the League, the murderer being regarded as a martyr and extolled by Pope Sixtus V., while even his canonization was discussed.

See E. Lavisse, *Histoire de France*, tome vi. (Paris, 1904).

CLEMENTI, MUZIO (c. 1751-1832), Italian pianist and composer, was born at Rome between 1750 and 1752. His father, a jeweller, encouraged his son's early musical talent. Buroni and Cordicelli were his first masters, and at the age of nine Clementi's theoretical and practical studies had advanced to such a degree that he was able to win the position of organist at a church. He continued his studies under Santarelli and Carpani, and at the age of fourteen wrote a mass which was performed in public. About 1766 Beckford, the author of *Vathek*, persuaded Clementi to follow him to England, where the young composer lived in retirement at one of the country seats of his protector in Dorsetshire until 1770. In that year he first appeared in London, where his success both as composer and pianist was rapid and brilliant. In 1777 he was for some time employed as conductor of the Italian opera, but he soon afterwards left London for Paris. Here also his concerts were crowded by enthusiastic audiences, and the same success accompanied Clementi on a tour about the year 1780 to southern Germany and Austria. At Vienna, which he visited between 1781 and 1782, he was received with high honour by the emperor Joseph II., in whose presence he met Mozart, and fought a kind of musical duel with him. His technical skill proved to be equal if not superior to that of his rival, who on the other hand infinitely surpassed him by the passionate beauty of his interpretation. It is worth noting that one of the finest of Clementi's sonatas, that in B flat, shows an exactly identical opening theme with Mozart's overture to the *Flauto Magico*.

In May 1782 Clementi returned to London, where for the next twelve years he continued his lucrative occupations of fashionable teacher and performer at the concerts of the aristocracy. He took shares in the pianoforte business of a firm which went bankrupt in 1800. He then established a pianoforte and music business of his own, under the name of Clementi & Co. Other members were added to the firm, including Collard and Davis, and the firm was ultimately taken over by Messrs Collard alone. Amongst his pupils on the pianoforte during this period may be mentioned John Field, the composer of the celebrated *Nocturnes*. In his company Clementi paid, in 1804, a visit to Paris, Vienna, St Petersburg, Berlin and other cities. While he was in Berlin, Meyerbeer became one of his pupils. He also revisited his own country after an absence of more than thirty years. In 1810 Clementi returned to London, but refused to play again in public, devoting the remainder of his life to composition. Several symphonies belong to this time, and were played with much success at contemporary concerts, but none of them seem to have been published. His intellectual and musical faculties remained unimpaired until his death, on the 9th of March 1832, at Evesham, Worcester.

Of Clementi's playing in his youth, Moscheles wrote that it was "marked by a most beautiful *legato*, a supple touch in lively passages, and a most unfailling *technique*." Mozart may be said to have closed the old and Clementi to have founded the newer school of *technique* on the piano. Amongst Clementi's compositions the most remarkable are sixty sonatas for pianoforte, and the great collection of *Études* called *Gradus ad Parnassum*.

CLEMENTINE LITERATURE, the name generally given to the writings which at one time or another were fathered upon Pope Clement I. (*q.v.*), commonly called Clemens Romanus, who was early regarded as a disciple of St Peter. Thus they are for the most part a species of the larger pseudo-Petrine genus. Chief among them are: (1) The so-called Second Epistle; (2) two Epistles on Virginity; (3) the *Homilies and Recognitions*; (4) the *Apostolical Constitutions* (*q.v.*); and (5) five epistles forming part of the Forged Decretals (see *DECRETALS*). The present article deals mainly with the third group, to which the title "Clementine literature" is usually confined, owing to the stress

laid upon it in the famous Tübingen reconstruction of primitive Christianity, in which it played a leading part; but later criticism has lowered its importance as its true date and historical relations have been progressively ascertained. (1) and (2) became "Clementine" only by chance, but (3) was so originally by literary device or fiction, the cause at work also in (4) and (5). But while in all cases the suggestion of Clement's authorship came ultimately from his prestige as writer of the genuine Epistle of Clement (see CLEMENT I.), both (3) and (4) were due to this idea as operative on Syrian soil; (5) is a secondary formation based on (3) as known to the West.

(1) *The "Second Epistle of Clement."*—This is really the earliest extant Christian homily (see APOSTOLIC FATHERS). Its theme is the duty of Christian repentance, with a view to obedience to Christ's precepts as the true confession and homage which He requires. Its special charge is "Preserve the flesh pure and the seal (i.e. baptism) unstained" (viii. 6). But the peculiar way in which it enforces its morals in terms of the Platonic contrast between the spiritual and sensuous worlds, as archetype and temporal manifestation, suggests a special local type of theology which must be taken into account in fixing its *provenance*. This theology, the fact that the preacher seems to quote the *Gospel according to the Egyptians* (in ch. xii. and possibly elsewhere) as if familiar to his hearers, and indeed its literary affinities generally, all point to Alexandria as the original home of the homily, at a date about 120-140 (see *Zeit. f. N. T. Wissenschaft*, vii. 123 ff.). Neither Corinth (as Lightfoot) nor Rome (as Harnack, who assigns it to Bishop Soter, c. 166-174) satisfies all the internal conditions, while the Eastern nature of the external evidence and the homily's quasi-canonical status in the Codex-Alexandrinus strongly favour an Alexandrine origin.

(2) *The Two Epistles to Virgins*, i.e. to Christian celibates of both sexes. These are known in their entirety only in Syriac, and were first published by Wetstein (1752), who held them genuine. This view is now generally discredited, even by Roman Catholics like Funk, their best recent editor (*Patres Apost.*, vol. ii.). External evidence begins with Epiphanius (*Haer.* xxx. 15) and Jerome (*Ad Jovin.* i. 12); and the silence of Eusebius tells heavily against their existence before the 4th century, at any rate as writings of Clement. The Monophysite Timothy of Alexandria (A.D. 457) cites one of them as Clement's, while Antiochus of St Saba (c. A.D. 620) makes copious but unacknowledged extracts from both in the original Greek. There is no trace of their use in the West. Thus their Syrian origin is manifest, the more so that in the Syriac MS. they are appended to the New Testament, like the better-known epistles of Clement in the Codex Alexandrinus. Indeed, judging from another Syriac MS. of earlier date, which includes the latter writings in its canon, it seems that the Epistles on Virginity gradually replaced the earlier pair in certain Syrian churches—even should Lightfoot be right in doubting if this had really occurred by Epiphanius's day (*S. Clement of Rome*, i. 412).

Probably these epistles did not originally bear Clement's name at all, but formed a single epistle addressed to ascetics among an actual circle of churches. In that case they, or rather it, may date from the 3rd century in spite of Eusebius's silence, and are not pseudo-Clementine in any real sense. It matters little whether or not the false ascription was made before the division into two implied already by Epiphanius (c. A.D. 375). Special occasion for such a hortatory letter may be discerned in its polemic against intimate relations between ascetics of opposite sex, implied to exist among its readers, in contrast to usage in the writer's own locality. Now we know that spiritual unions, prompted originally by highstrung Christian idealism as to a religious fellowship transcending the law of nature in relation to sex, did exist between persons living under vows of celibacy during the 3rd century in particular, and not least in Syria (cf. the case of Paul of Samosata, c. 265, and the Synod of Ancyra in Galatia, c. 314). It is natural, then, to see in the original epistle a protest against the dangers of such spiritual boldness (cf. "Subintroductae" in Herzog-Hauck's *Realencyklopädie*), prior perhaps to the famous case at Antioch just noted.

Possibly it is the feeling of south Syria or Palestine that here expresses itself in remonstrance against usages prevalent in north Syria. Such a view finds support also in the New Testament canon implied in these epistles.

(3) [a] *The Epistle of Clement to James* (the Lord's brother). This was originally part of (3) [b], in connexion with which its origin and date are discussed. But as known to the West through Rufinus's Latin version, it was quoted as genuine by the synod of Vaison (A.D. 442) and throughout the middle ages. It became "the starting point of the most momentous and gigantic of medieval forgeries, the Isidorian Decretals," "where it stands at the head of the pontifical letters, extended to more than twice its original length." This extension perhaps occurred during the 5th century. At any rate the letter in this form, along with a "second epistle to James" (on the Eucharist, church furniture, &c.), dating from the early 6th century, had separate currency long before the 9th century, when they were incorporated in the *Decretals* by the forger who raised the Clementine epistles to five (see Lightfoot, *Clement*, i. 414 ff.).

(3) [b] *The "Homilies" and "Recognitions."*—"The two chief extant Clementine writings, differing considerably in some respects in doctrine, are both evidently the outcome of a peculiar speculative type of Judaistic Christianity, for which the most characteristic name of Christ was 'the true Prophet.' The framework of both is a narrative purporting to be written by Clement (of Rome) to St James, the Lord's brother, describing at the beginning his own conversion and the circumstances of his first acquaintance with St Peter, and then a long succession of incidents accompanying St Peter's discourses and disputations, leading up to a romantic recognition of Clement's father, mother and two brothers, from whom he had been separated since childhood. The problems discussed under this fictitious guise are with rare exceptions fundamental problems for every age; and, whatever may be thought of the positions maintained, the discussions are hardly ever feeble or trivial. Regarded simply as mirroring the past, few, if any, remains of Christian antiquity present us with so vivid a picture of the working of men's minds under the influence of the new heaven which had entered into the world" (Hort, *Clem. Recog.*, p. xiv.).

The indispensable preliminary to a really historic view of these writings is some solution of the problem of their mutual relations. The older criticism assumed a dependence of one upon the other, and assigned one or both to the latter part of the 2nd century. Recent criticism, however, builds on the principle, which emerges alike from the external and internal evidence (see Salmon in the *Dict. of Christian Biography*), that both used a common basis. Our main task, then, is to define the nature, origin and date of the parent document, and if possible its own literary antecedents. Towards the solution of this problem two contributions of prime importance have recently been made. The earlier of these is by F. J. A. Hort, and was delivered in the form of lectures as far back as 1884, though issued posthumously only in 1901; the other is the elaborate monograph of Dr Hans Waitz (1904).

Criticism.—(i.) *External Evidence as to the Clementine Romance.* The evidence of ancient writers really begins, not with Origen,¹ but with Eusebius of Caesarea, who in his *Ecd. Hist.* iii. 38, writes as follows: "Certain men have quite lately brought forward as written by him (Clement) other verbose and lengthy writings, containing dialogues of Peter, forsooth, and Apion, whereof not the slightest mention is to be found among the ancients, for they do not even preserve in purity the stamp of the Apostolic orthodoxy." Apion, the Alexandrine grammarian

¹ Dr Armitage Robinson, in his edition of the *Philocalia* (extracts made c. 358 by Basil and Gregory from Origen's writings), proved that the passage cited below is simply introduced as a parallel to an extract of Origen's; while Dom Chapman, in the *Journal of Theol. Studies*, iii. 436 ff., made it probable that the passages in Origen's *Comm. on Matthew* akin to those in the *Opus Imperf. in Matth.* are insertions in the former, which is extant only in a Latin version. Subsequently he suggested (*Zeitsch. f. N. T. Wissenschaft*, ix. 33 f.) that the passage in the *Philocalia* is due not to its authors but to an early editor, since it is the only citation not referred to Origen.

and foe of Judaism, whose criticism was answered by Josephus, appears in this character both in *Homilies* and *Recognitions*, though mainly in the former (iv. 6-vii. 3). Thus Eusebius implies (1) a spurious Clementine work containing matter found also in our *Homilies* at any rate; and (2) its quite recent origin. Next we note that an extract in the *Philocalis* is introduced as follows: "Yea, and Clement the Roman, a disciple of Peter the Apostle, after using words in harmony with these on the present problem, in conversation with his father at Laodicea in the *Circuits*, speaks a very necessary word for the end of arguments touching this matter, viz. those things which seem to have proceeded from *genesis* (=astrological destiny), in the fourteenth book." The extract answers to *Recognitions*, x. 10-13, but it is absent from our *Homilies*. Here we observe that (1) the extract agrees this time with *Recognitions*, not with *Homilies*; (2) its framework is that of the Clementine romance found in both; (3) the tenth and last book of *Recognitions* is here parallel to book xiv. of a work called *Circuits* (*Periodoi*).

This last point leads on naturally to the witness of Epiphanius (c. 375), who, speaking of Ebionites or Judaizing Christians of various sorts, and particularly the Essene type, says (*Haer.* xxx. 15) that "they use certain other books likewise, to wit, the so-called *Circuits* of Peter, which were written by the hand of Clement, falsifying their contents, though leaving a few genuine things." Here Epiphanius simply assumes that the Ebionite *Circuits of Peter* was based on a genuine work of the same scope, and goes on to say that the spurious elements are proved such by contrast with the tenor of Clement's "encyclic epistles" (i.e. those to virgins, (1) above); for these enjoin virginity (celibacy), and praise Elijah, David, Samson, and all the prophets, whereas the Ebionite *Circuits* favour marriage (even in Apostles) and depreciate the prophets between Moses and Christ, "the true Prophet." "In the *Circuits*, then, they adapted the whole to their own views, representing Peter falsely in many ways, as that he was daily baptized for the sake of purification, as these also do; and they say that he likewise abstained from animal food and meat, as they themselves also do." Now all the points here noted in the *Circuits* can be traced in our *Homilies* and *Recognitions*, though toned down in different degrees.

The witness of the Arianizing *Opus Imperfectum in Mattheum* (c. 400) is in general similar. Its usual form of citation is "Peter in Clement" (*apud Clementem*). This points to "Clement" as a brief title for the Clementine *Periodoi*, a title actually found in a Syriac MS. of A.D. 411 which contains large parts of *Recognitions* and *Homilies*, and twice used by Rufinus, e.g. when he proposes to inscribe his version of the *Recognitions* "Rufinus Clemens." Rufinus in his preface to this work—in which for the first time we meet the title *Recognition(s)*—observes that there are two editions to which the name applies, two collections of books differing in some points but in many respects containing the same narrative. This he remarks in explanation of the order of his version in some places, which he feels may strike his friend Gaudentius as unusual, the inference being that the other edition was the better-known one, although it lacked "the transformation of Simon" (i.e. of Clement's father into Simon's likeness), which is common to the close both of our *Recognitions* and *Homilies*, and so probably belonged to the *Circuits*. We may assume, too (e.g. on the basis of our Syriac MS.), that the Greek edition of the *Recognition(s)* actually used by Rufinus was much nearer the text of the *Periodoi* of which we have found traces than we should imagine from its Latin form.

So far we have no sure trace of our *Homilies* at all, apart from the Syriac version. Even four centuries later, Photius, in referring to a collection of books called both *Acts of Peter* and the *Recognition of Clement*, does not make clear whether he means *Homilies* or *Recognitions* or either. "In all the copies which we have seen (and they are not a few) after those different epistles (viz. 'Peter to James' and 'Clement to James,' prefixed, the one in some MSS. the other in others) and titles, we found without variation the same treatise, beginning, I, Clement, &c." But it is not clear that he had read more than the opening of

these MSS. The fact that different epistles are prefixed to the same work leads him to conjecture "that there were two editions made of the *Acts of Peter* (his usual title for the collection), but in course of time the one perished and that of Clement prevailed." This is interesting as anticipating a result of modern criticism, as will appear below. The earliest probable reference to our *Homilies* occurs in a work of doubtful date, the pseudo-Athanasian *Synopsis*, which mentions "Clementines, whence came by selection and rewriting the true and inspired form." Here too we have the first sure trace of an expurgated recension, made with the idea of recovering the genuine form assumed, as earlier by Epiphanius, to lie behind an unorthodox recension of Clement's narrative. As, moreover, the extant *Epitome* is based on our *Homilies*, it is natural to suppose it was also the basis of earlier orthodox recensions, one or more of which may be used in certain Florilegia of the 7th century and later. Nowhere do we find the title *Homilies* given to any form of the Clementine collection in antiquity.

(ii) *The Genesis of the Clementine Literature.* It has been needful to cite so much of the evidence proving that our *Homilies* and *Recognitions* are both recensions of a common basis, at first known as the *Circuits of Peter* and later by titles connecting it rather with Clement, its ostensible author, because it affords data also for the historical problems touching (a) the contents and origin of the primary Clementine work, and (b) the conditions under which our extant recensions of it arose.

(a) *The Circuits of Peter*, as defined on the one hand by the epistle of Clement to James originally prefixed to it and by patristic evidence, and on the other by the common element in our *Homilies* and *Recognitions*, may be conceived as follows. It contained accounts of Peter's teachings and discussions at various points on a route beginning at Caesarea, and extending northwards along the coast-lands of Syria as far as Antioch. During this tour he meets with persons of typically erroneous views, which it was presumably the aim of the work to refute in the interests of true Christianity, conceived as the final form of divine revelation—a revelation given through true prophecy embodied in a succession of persons, the chief of whom were Moses and the prophet whom Moses foretold, Jesus the Christ. The prime exponent of the spurious religion is Simon Magus. A second protagonist of error, this time of Gentile philosophic criticism directed against fundamental Judaism, is Apion, the notorious anti-Jewish Alexandrine grammarian of Peter's day; while the rôle of upholder of astrological fatalism (*Genesis*) is played by Faustus, father of Clement, with whom Peter and Clement debate at Laodicea. Finally, all this is already embedded in a setting determined by the romance of Clement and his lost relatives, "recognition" of whom forms the *dénouement* of the story.

There is no reason to doubt that such, roughly speaking, were the contents of the Clementine work to which Eusebius alludes slightly, in connexion with that section of it which had to his eye least verisimilitude, viz. the dialogues between Peter and Apion. Now Eusebius believed the work to have been of quite recent and suspicious origin. This points to a date about the last quarter of the 3rd century; and the prevailing doctrinal tone of the contents, as known to us, leads to the same result. The standpoint is that of the peculiar Judaizing or Ebionite Christianity due to persistence among Christians of the tendencies known among pre-Christian Jews as Essene. The Essenes, while clinging to what they held to be original Mosaism, yet conceived and practised their ancestral faith in ways which showed distinct traces of syncretism, or the operation of influences foreign to Judaism proper. They thus occupied an ambiguous position on the borders of Judaism. Similarly Christian Essenism was syncretist in spirit, as we see from its best-known representatives, the Elchasaïtes, of whom we first hear about 220, when a certain Alcibiades of Apamea in Syria (some 60 m. south of Antioch) brought to Rome the *Book of Helxai*—the manifesto of their distinctive message (*Hippol., Philos.* ix. 13)—and again some twenty years later, when Origen refers to one of their leaders as having lately arrived at Caesarea (*Euseb.* vi. 38).

The first half of the 3rd century was marked, especially in Syria, by a strong tendency to syncretism, which may well have stirred certain Christian Essenes to fresh propaganda. Other writings than the *Book of Helxai*, representing also other species of the same genus, would take shape. Such may have been some of the pseudo-apostolic *Acts* to which Epiphanius alludes as in use among the Ebionites of his own day: and such was probably the nucleus of our Clementine writings, the *Periodoi* of Peter.

Harnack (*Chronologie*, ii. 522 f.), indeed, while admitting that much (e.g. in *Homilies*, viii. 5-7) points the other way, prefers the view that even the *Circuits* were of Catholic origin (Chapman, as above, says Arian, soon after 325), regarding the syncretistic Jewish-Christian features in it as due either to its earlier basis or to an instinct to preserve continuity of manner (e.g. absence of explicit reference to Paul). Hort, on the contrary, assumes as author "an ingenious Helxaites . . . perhaps stimulated by the example of the many Encratite *Periodoi*" (p. 131), and writing about A.D. 200.

Only it must not be thought of as properly Elchasaite, since it knew no baptism distinct from the ordinary Christian one. It seems rather to represent a later and modified Essene Christianity, already half-Catholic, such as would suit a date after 250, in keeping with Eusebius's evidence. Confirmation of such a date is afforded by the silence of the Syrian *Didascalia*, itself perhaps dating from about 250, as to any visit of Simon Magus to Caesarea, in contrast to the reference in its later form, the *Apostolical Constitutions* (c. 350-400), which is plainly coloured (vi. 9) by the Clementine story. On the other hand, the *Didascalia* seems to have been evoked partly by Judaizing propaganda in north Syria. If, then, it helps to date the *Periodoi* as after 250, it may also suggest as place of origin one of the large cities lying south of Antioch, say Laodicea (itself on the coast about 30 m. from Apamea), where the Clementine story reaches its climax. The intimacy of local knowledge touching this region implied in the narrative common to *Homilies* and *Recognitions* is notable, and tells against an origin for the *Periodoi* outside Syria (e.g. in Rome, as Waitz and Harnack hold, but Lightfoot disproves, *Clem.* i. 55 f., 64, 100, cf. Hort, p. 131). Further, though the curtain even in it fell on Peter at Antioch itself (our one complete MS. of the *Homilies* is proved by the *Epitome*, based on the *Homilies*, to be here abridged), the interest of the story culminates at Laodicea.

If we assume, then, that the common source of our extant Clementines arose in Syria, perhaps c. 265,¹ had it also a written source or sources which we can trace? Though Hort doubts it, most recent scholars (e.g. Waitz, Harnack) infer the existence of at least one source, "Preachings (*Kerygmata*) of Peter," containing no reference at all to Clement. Such a work seems implied by the epistle of Peter to James and its appended adjuration, prefixed in our MSS. to the *Homilies* along with the epistle of Clement to James. Thus the later work aimed at superseding the earlier, much as Photius suggests (see above). It was, then, to these "Preachings of Peter" that the most Ebionite features, and especially the anti-Pauline allusions under the guise of Simon still inhering in the *Periodoi* (as implied by *Homilies* in particular), originally belonged. The fact, however, that these were not more completely suppressed in the later work, proves that it, too, arose in circles of kindred, though largely modified, Judaeo-Christian sentiment (cf. *Homilies*, viii., e.g. ch. 8). The differences of standpoint may be due not only to lapse of time, and the emergence of new problems on the horizon of Syrian Christianity generally, but also to change in locality and in the degree of Greek culture represented by the two works. A probable date for the "Preachings" used in the *Periodoi* is c. 200.²

¹ While Hort and Waitz say c. 200, Harnack says c. 260. The reign of Gallienus (260-268) would suit the tone of its references to the Roman emperor (Waitz, p. 74), and also any polemic against the Neoplatonic philosophy of revelation by visions and dreams which it may contain.

² Even Waitz agrees to this, though he argues back to a yet earlier anti-Pauline (rather than anti-Marcionite) form, composed in Caesarea, c. 135.

If the home of the *Periodoi* was the region of the Syrian Laodicea, we can readily explain most of its characteristics. Photius refers to the "excellences of its language and its learning"; while Waitz describes the aim and spirit of its contents as those of an apology for Christianity against heresy and paganism, in the widest sense of the word, written in order to win over both Jews (cf. *Recognitions*, i. 53-70) and pagans, but mainly the latter. In particular it had in view persons of culture, as most apt to be swayed by the philosophical tendencies in the sphere of religion prevalent in that age, the age of neo-Platonism. It was in fact designed for propaganda among religious seekers in a time of singular religious restlessness and varied inquiry, and, above all, for use by catechumens (cf. *Ep. Clem.* 2, 13) in the earlier stages of their preparation for Christian baptism. To such its romantic setting would be specially adapted, as falling in with the literary habits and tastes of the period; while its doctrinal peculiarities would least give offence in a work of the aim and character just described.

As regards the sources of the narrative part of the *Periodoi*, it is possible that the "recognition" motif was a literary commonplace. The account of Peter's journeyings was no doubt based largely on local Syrian tradition, perhaps as already embodied in written *Acts of Peter* (so Waitz and Harnack), but differing from the Western type, e.g. in bringing Peter to Rome long before Nero's reign. As for the allusions, more or less indirect, to St Paul behind the figure of Simon, as the arch-enemy of the truth—allusions which first directed attention to the Clementines in the last century—there can be no doubt as to their presence, but only as to their origin and the degree to which they are so meant in *Homilies* and *Recognitions*. There is certainly "an application to Simon of words used by or of St Paul, or of claims made by or in behalf of St Paul" (Hort), especially in *Homilies* (iii. 17 f., xi. 35, xvii. 19), where a consciousness also of the double reference must still be present, though this does not seem to be the case in *Recognitions* (in Rufinus's Latin.) Such covert reference to Paul must designedly have formed part of the *Periodoi*, yet as adopted from its more bitterly anti-Pauline basis, the "Preachings of Peter" (cf. *Homilies*, ii. 17 f. with *Ep. Pet. ad Jac.* 2), which probably shared most of the features of Ebionite Essenism as described by Epiphanius xxx. 15 f. (including the qualified dualism of the two kingdoms—the present one of the devil, and the future one of the angelic Christ—which appears also in the *Periodoi*, cf. *Ep. Clem. ad Jac.* 1 *fn.*).

(b) That the *Periodoi* was a longer work than either our *Homilies* or *Recognitions* is practically certain; and its mere bulk may well, as Hort suggests (p. 88), have been a chief cause of the changes of form. Yet *Homilies* and *Recognitions* are abridgments made on different principles and convey rather different impressions to their readers. "The *Homilies* care most for doctrine," especially philosophical doctrine, "and seem to transpose very freely for doctrinal purposes" (e.g. matter in xvi.-xix. is placed at the end for effect, while xx. 1-10 gives additional emphasis to the *Homilies*' theory of evil, perhaps over against Manichaeism). "The *Recognitions* care most for the story," as a means of religious edification. "and have preserved the general framework much more nearly." They arose in different circles: indeed, save the compiler of the text represented by the Syriac MS. of 411 A.D., "not a single ancient writer shows a knowledge of both books in any form." But Hort is hardly right in suggesting that, while *Homilies* arose in Syria, *Recognitions* took shape in Rome. Both probably arose in Syria (so Lightfoot), but in circles varying a good deal in religious standpoint.¹ *Homilies* was a sort of second edition, made largely in the spirit of its original and perhaps in much the same locality, with a view to maintaining and propagating the doctrines of a semi-Judaic Christianity (cf. bk. vii.), as it existed a generation or two after the *Periodoi* appeared. The *Recognitions*, in both recensions, as is shown by the fact that it was read in the original with general admiration not only by Rufinus but also by others in the West, was more Catholic in tone and aimed chiefly at

¹ Dom Chapman maintains that the *Recognitions* (c. 370-390) even attack the doctrine of God in the *Homilies* or their archetype.

commending the Christian religion over against all non-Christian rivals or gnostic perversions. That is, more than one effort of this sort had been made to adapt the story of Clement's *Recognitions* to general Christian use. Later the *Homilies* underwent further adaptation to Catholic feeling even before the *Epitome*, in its two extant forms, was made by more drastic methods of expurgation. One kind of adaptation at least is proved to have existed before the end of the 4th century, namely a selection of certain discourses from the *Homilies* under special headings, following on *Recognitions*, i.-iii., as seen in a Syriac MS. of A.D. 411. As this MS. contains transcriptional errors, and as its archetype had perhaps a Greek basis, the *Recognitions* may be dated c. 350-375¹ (its Christology suggested to Rufinus an Arianism like that of Eunomius of Cyzicus, c. 362), and the *Homilies* prior even to 350. But the different circles represented by the two make relative dating precarious.

Summary.—The Clementine literature throws light upon a very obscure phase of Christian development, that of Judaeo-Christianity, and proves that it embraced more intermediate types, between Ebionism proper and Catholicism, than has generally been realized. Incidentally, too, its successive forms illustrate many matters of belief and usage among Syrian Christians generally in the 3rd and 4th centuries, notably their apologetic and catechetical needs and methods. Further, it discusses, as Hort observes, certain indestructible problems which much early Christian theology passes by or deals with rather perfunctorily; and it does so with a freshness and reality which, as we compare the original 3rd-century basis with the conventional manner of the *Epitome*, we see to be not unconnected with origin in an age as yet free from the trammels of formal orthodoxy. Again it is a notable specimen of early Christian pseudepigraphy, and one which had manifold and far-reaching results. Finally the romance to which it owed much of its popular appeal, became, through the medium of Rufinus's Latin, the parent of the late medieval legend of Faust, and so the ancestor of a famous type in modern literature.

LITERATURE.—For a full list of this down to 1904 see Hans Waitz, "Die Pseudoklementinen" (*Texte u. Untersuchungen zur Gesch. der altchr. Literatur, neue Folge*, Bd. x. Heft 4), and A. Harnack, *Chronologie der altchr. Litteratur* (1904), ii. 518 f. In English, besides Hort's work, there are articles by G. Salmon, in *Dict. of Christ. Biog.*, C. Bigg, *Studia Biblica*, ii., A. C. Headlam, *Journal of Theol. Studies*, iii. (J. V. B.)

CLEOBULUS, one of the Seven Sages of Greece, a native and tyrant of Lindus in Rhodes. He was distinguished for his strength and his handsome person, for the wisdom of his sayings, the acuteness of his riddles and the beauty of his lyric poetry. Diogenes Laërtius quotes a letter in which Cleobulus invites Solon to take refuge with him against Peisistratus; and this would imply that he was alive in 560 B.C. He is said to have held advanced views as to female education, and he was the father of the wise Cleobuline, whose riddles were not less famous than his own (Diogenes Laërtius i. 89-93).

See F. G. Mullach, *Fragmenta Philosophorum Graecorum*, i.

CLEOMENES (Κλεομένης), the name of three Spartan kings of the Agiad line.

CLEOMENES I. was the son of Anaxandridas, whom he succeeded about 520 B.C. His chief exploit was his crushing victory near Tiryns over the Argives, some 6000 of whom he burned to death in a sacred grove to which they had fled for refuge (Herodotus vi. 76-82). This secured for Sparta the undisputed hegemony of the Peloponnese. Cleomenes' interposition in the politics of central Greece was less successful. In 510 he marched to Athens with a Spartan force to aid in expelling the Peisistratidae, and subsequently returned to support the oligarchical party, led by Isagoras, against Cleisthenes (*q.v.*). He expelled seven hundred families and transferred the government from the council to three hundred of the oligarchs, but being blockaded in the Acropolis he was forced to capitulate. On his return home he collected a large force with the intention of

¹ Dom Chapman (*ut supra*, p. 158) says during the Neoplatonist reaction under Julian 361-363, to which period he also assigns the *Homilies*.

making Isagoras despot of Athens, but the opposition of the Corinthian allies and of his colleague Demaratus caused the expedition to break up after reaching Eleusis (Herod. v. 64-76; Aristotle, *Ath. Pol.* 19, 20). In 491 he went to Aegina to punish the island for its submission to Darius, but the intrigues of his colleague once again rendered his mission abortive. In revenge Cleomenes accused Demaratus of illegitimacy and secured his deposition in favour of Leotychides (Herod. vi. 50-73). But when it was discovered that he had bribed the Delphian priestess to substantiate his charge he was himself obliged to flee; he went first to Thessaly and then to Arcadia, where he attempted to foment an anti-Spartan rising. About 488 B.C. he was recalled, but shortly afterwards, in a fit of madness, he committed suicide (Herod. vi. 74, 75). Cleomenes seems to have received scant justice at the hands of Herodotus or his informants, and Pausanias (iii. 3, 4) does little more than condense Herodotus's narrative. In spite of some failures, largely due to Demaratus's jealousy, Cleomenes strengthened Sparta in the position, won during his father's reign, of champion and leader of the Hellenic race; it was to him, for example, that the Ionian cities of Asia Minor first applied for aid in their revolt against Persia (Herod. v. 49-51).

For the chronology see J. Wells, *Journal of Hellenic Studies* (1905), p. 193 ff., who assigns the Argive expedition to the outset of the reign, whereas nearly all historians have dated it in or about 495 B.C.

CLEOMENES II. was the son of Cleombrotus I., brother and successor of Agesipolis II. Nothing is recorded of his reign save the fact that it lasted for nearly sixty-one years (370-309 B.C.).

CLEOMENES III., the son and successor of Leonidas II., reigned about 235-219 B.C. He made a determined attempt to reform the social condition of Sparta along the lines laid down by Agis IV., whose widow Agiatis he married; at the same time he aimed at restoring Sparta's hegemony in the Peloponnese. After twice defeating the forces of the Achaean League in Arcadia, near Mount Lycaeum and at Leuctra, he strengthened his position by assassinating four of the ephors, abolishing the ephorate, which had usurped the supreme power, and banishing some eighty of the leading oligarchs. The authority of the council was also curtailed, and a new board of magistrates, the *patronomi*, became the chief officers of state. He appointed his own brother Euclidas as his colleague in succession to the Eurypontid Archidamus, who had been murdered. His social reforms included a redistribution of land, the remission of debts, the restoration of the old system of training (*ἀγωγή*) and the admission of picked *perioeci* into the citizen body. As a general Cleomenes did much to revive Sparta's old prestige. He defeated the Achaeans at Dyme, made himself master of Argos, and was eventually joined by Corinth, Phlius, Epidaurus and other cities. But Aratus, whose jealousy could not brook to see a Spartan at the head of the Achaean league called in Antigonus Dosis of Macedonia, and Cleomenes, after conducting successful expeditions to Megalopolis and Argos, was finally defeated at Sellasia, to the north of Sparta, in 222 or 221 B.C. He took refuge at Alexandria with Ptolemy Euergetes, but was arrested by his successor, Ptolemy Philopator, on a charge of conspiracy. Escaping from prison he tried to raise a revolt, but the attempt failed and to avoid capture he put an end to his life. Both as general and as politician Cleomenes was one of Sparta's greatest men, and with him perished her last hope of recovering her ancient supremacy in Greece.

See Polybius ii. 45-70, v. 35-39, viii. 1; Plutarch, *Cleomenes*; *Aratus*, 35-46; *Philopoemen*, 5, 6; Pausanias ii. 9; Gehlert, *De Cleomene* (Leipzig, 1883); Holm, *History of Greece*, iv. cc. 10, 15. (M. N. T.)

CLEON (d. 422 B.C.), Athenian politician during the Peloponnesian War, was the son of Cleaenetus, from whom he inherited a lucrative tannery business. He was the first prominent representative of the commercial class in Athenian politics. He came into notice first as an opponent of Pericles, to whom his advanced ideas were naturally unacceptable, and in his opposition somewhat curiously found himself acting in concert with the aristocrats, who equally hated and feared Pericles. During the dark days of 430, after the unsuccessful expedition of Pericles to

Peloponnesus, and when the city was devastated by the plague, Cleon headed the opposition to the Periclean régime. Pericles was accused by Cleon of maladministration of public money, with the result that he was actually found guilty (see Grote's *Hist. of Greece*, abridged ed., 1907, p. 406, note 1). A revulsion of feeling, however, soon took place. Pericles was reinstated, and Cleon now for a time fell into the background. The death of Pericles (429) left the field clear for him. Hitherto he had only been a vigorous opposition speaker, a trenchant critic and accuser of state officials. He now came forward as the professed champion and leader of the democracy, and, owing to the moderate abilities of his rivals and opponents, he was for some years undoubtedly the foremost man in Athens. Although rough and unpolished, he was gifted with natural eloquence and a powerful voice, and knew exactly how to work upon the feelings of the people. He strengthened his hold on the poorer classes by his measure for trebling the pay of the jurymen, which provided the poorer Athenians with an easy means of livelihood. The notorious fondness of the Athenians for litigation increased his power; and the practice of "sycophancy" (raking up material for false charges; see SYCOPHANT), enabled him to remove those who were likely to endanger his ascendancy. Having no further use for his former aristocratic associates, he broke off all connexion with them, and thus felt at liberty to attack the secret combinations for political purposes, the oligarchical clubs to which they mostly belonged. Whether he also introduced a property-tax for military purposes, and even held a high position in connexion with the treasury, is uncertain. His ruling principles were an inveterate hatred of the nobility, and an equal hatred of Sparta. It was mainly through him that the opportunity of concluding an honourable peace (in 425) was lost, and in his determination to see Sparta humbled he misled the people as to the extent of the resources of the state, and dazzled them by promises of future benefits.

In 427 Cleon gained an evil notoriety by his proposal to put to death indiscriminately all the inhabitants of Mytilene, which had put itself at the head of a revolt. His proposal, though accepted, was, fortunately for the credit of Athens, rescinded, although, as it was, the chief leaders and prominent men, numbering about 1000, fell victims. In 425, he reached the summit of his fame by capturing and transporting to Athens the Spartans who had been blockaded in Sphacteria (see PYLOS). Much of the credit was probably due to the military skill of his colleague Demosthenes; but it must be admitted that it was due to Cleon's determination that the Ecclesia sent out the additional force which was needed. It was almost certainly due to Cleon that the tribute of the "allies" was doubled in 425 (see DELIAN LEAGUE). In 422 he was sent to recapture Amphipolis, but was outgeneralled by Brasidas and killed. His death removed the chief obstacle to an arrangement with Sparta, and in 421 the peace of Nicias was concluded (see PELOPONNESIAN WAR).

The character of Cleon is represented by Aristophanes and Thucydides in an extremely unfavourable light. But neither can be considered an unprejudiced witness. The poet had a grudge against Cleon, who had accused him before the senate of having ridiculed (in his *Babylonians*) the policy and institutions of his country in the presence of foreigners and at the time of a great national war. Thucydides, a man of strong oligarchical prejudices, had also been prosecuted for military incapacity and exiled by a decree proposed by Cleon. It is therefore likely that Cleon has had less than justice done to him in the portraits handed down by these two writers.

AUTHORITIES.—For the literature on Cleon see C. F. Hermann, *Lehrbuch der griechischen Antiquitäten*, i. pt. 2 (6th ed. by V. Thumser, 1892), p. 709, and G. Busolt, *Griechische Geschichte*, iii. pt. 2 (1904), p. 988, note 3. The following are the chief authorities:—(a) *Favourable to Cleon.*—C. F. Ranke, *Commentatio de Vita Aristophanis* (Leipzig, 1845); J. G. Droysen, *Aristophanes*, ii., introd. to the *Knights* (Berlin, 1837); G. Grote, *Hist. of Greece*, chs. 50, 54; W. Oncken, *Athen und Hellas*, ii. p. 204 (Leipzig, 1866); H. Müller-Strübing, *Aristophanes und die historische Kritik* (Leipzig, 1873); J. B. Bury, *Hist. of Greece*, i. (1902). (b) *Unfavourable.*—J. F. Kortüm, *Geschichtliche Forschungen* (Leipzig, 1863), and *Zur Geschichte hellenischen Staatsverfassungen* (Heidelberg, 1821); F. Passow,

Vermischte Schriften (Leipzig, 1843); C. Thirlwall, *Hist. of Greece*, ch. 21; E. Curtius, *Hist. of Greece* (Eng. tr. iii. p. 112; J. Schwarcz, *Die Demokratie* (Leipzig, 1882); H. Delbrück, *Die Strategie des Perikles* (Berlin, 1890); E. Meyer, *Forschungen zur alten Geschichte*, ii. p. 333 (Halle, 1899). The balance between the two extreme views is fairly held by J. Beloch, *Die attische Politik seit Perikles* (Leipzig, 1884), and *Griechische Geschichte*, i. p. 537; and by A. Holm, *Hist. of Greece*, ii. (Eng. tr.), ch. 23, with the notes.

CLEOPATRA, the regular name of the queens of Egypt in the Ptolemaic dynasty after Cleopatra, daughter of the Seleucid Antiochus the Great, wife of Ptolemy V., Epiphanes. The best known was the daughter of Ptolemy XIII. Auletes, born 69 (or 68) B.C. At the age of seventeen she became queen of Egypt jointly with her younger brother Ptolemy Dionysus, whose wife, in accordance with Egyptian custom, she was to become. A few years afterwards, deprived of all royal authority, she withdrew into Syria, and made preparation to recover her rights by force of arms. At this juncture Julius Caesar followed Pompey into Egypt. The personal fascinations of Cleopatra induced him to undertake a war on her behalf, in which Ptolemy lost his life, and she was replaced on the throne in conjunction with a younger brother, of whom, however, she soon rid herself by poison. In Rome she lived openly with Caesar as his mistress until his assassination, when, aware of her unpopularity, she returned at once to Egypt. Subsequently she became the ally and mistress of Mark Antony (see ANTONIUS). Their connexion was highly unpopular at Rome, and Octavian (see AUGUSTUS) declared war upon them and defeated them at Actium (31 B.C.). Cleopatra took to flight, and escaped to Alexandria, where Antony joined her. Having no prospect of ultimate success, she accepted the proposal of Octavian that she should assassinate Antony, and enticed him to join her in a mausoleum which she had built in order that "they might die together." Antony committed suicide, in the mistaken belief that she had already done so, but Octavian refused to yield to the charms of Cleopatra who put an end to her life, by applying an asp to her bosom, according to the common tradition, in the thirty-ninth year of her age (29th of August, 30 B.C.). With her ended the dynasty of the Ptolemies, and Egypt was made a Roman province. Cleopatra had three children by Antony, and by Julius Caesar, as some say, a son, called Caesarion, who was put to death by Octavian. In her the type of queen characteristic of the Macedonian dynasties stands in the most brilliant light. Imperious will, masculine boldness, relentless ambition like hers had been exhibited by queens of her race since the old Macedonian days before Philip and Alexander. But the last Cleopatra had perhaps some special intellectual endowment. She surprised her generation by being able to speak the many tongues of her subjects. There may have been an individual quality in her luxurious profligacy, but then her predecessors had not had the Roman lords of the world for wooers.

For the history of Cleopatra see ANTONIUS, MARCUS; CAESAR, GAIUS JULIUS; PTOLEMIES. The life of Antony by Plutarch is our main authority; it is upon this that Shakespeare's *Antony and Cleopatra* is based. Her life is the subject of monographs by Stahr (1879, an *apologia*), and Houssaye, *Aspasie, Cléopâtre, &c.* (1879).

CLEPSYDRA (from Gr. κλέπτειν, to steal, and ὕδωρ, water), the chronometer of the Greeks and Romans, which measured time by the flow of water. In its simplest form it was a short-necked earthenware globe of known capacity, pierced at the bottom with several small holes, through which the water escaped or "stole away." The instrument was employed to set a limit to the speeches in courts of justice, hence the phrases *aquam dare*, to give the advocate speaking time, and *aquam perdere*, to waste time. Smaller clepsydrae of glass were very early used in place of the sun-dial, to mark the hours. But as the length of the hour varied according to the season of the year, various arrangements, of which we have no clear account, were necessary to obviate this and other defects. For instance, the flow of water varied with the temperature and pressure of the air, and secondly, the rate of flow became less as the vessel emptied itself. The latter defect was remedied by keeping the level of the water in the clepsydra uniform, the volume of that discharged being noted. Plato is said to have invented a complicated clepsydra to indicate the

hours of the night as well as of the day. In the clepsydra or hydraulic clock of Ctesibius of Alexandria, made about 135 B.C., the movement of water-wheels caused the gradual rise of a little figure, which pointed out the hours with a little stick on an index attached to the machine. The clepsydra is said to have been known to the Egyptians. There was one in the Tower of the Winds at Athens; and the turret on the south side of the tower is supposed to have contained the cistern which supplied the water.

See Marquardt, *Das Privatleben der Römer*, i. (2nd ed., 1886), p. 792; G. Bülfinger, *Die Zeitmesser der antiken Völker* (1886), and *Die antiken Stundenangaben* (1888).

CLERESTORY, or **CLEARSTORY** (Ital. *chiaro piano*, Fr. *clair-voie*, *claire étage*, Ger. *Lichtgaden*), in architecture, the upper storey of the nave of a church, the walls of which rise above the aisles and are pierced with windows ("clere" being simply "clear," in the sense of "lighted"). Sometimes these windows are very small, being mere quatrefoils or spherical triangles. In large buildings, however, they are important objects, both for beauty and utility. The windows of the clerestories of Norman work, even in large churches, are of less importance than in the later styles. In Early English they became larger; and in the Decorated they are more important still, being lengthened as the triforium diminishes. In Perpendicular work the latter often disappears altogether, and in many later churches, as at Taunton, and many churches in Norfolk and Suffolk, the clerestories are close ranges of windows. The term is equally applicable to the Egyptian temples, where the lighting of the hall of columns was obtained over the stone roofs of the adjoining aisles, through slits pierced in vertical slabs of stone. The Romans also in their baths and palaces employed the same method, and probably derived it from the Greeks; in the palaces at Crete, however, light-wells would seem to have been employed.

CLERFAYT (or **CLAIRFAYT**), **FRANÇOIS SEBASTIEN CHARLES JOSEPH DE CROIX**, COUNT OF (1733-1798), Austrian field marshal, entered the Austrian army in 1753. In the Seven Years' War he greatly distinguished himself, earning rapid promotion, and receiving the decoration of the order of Maria Theresa. At the conclusion of the peace, though still under thirty, he was already a colonel. During the outbreak of the Netherlands in 1787, he was, as a Walloon by birth, subjected to great pressure to induce him to abandon Joseph II., but he resisted all overtures, and in the following year went to the Turkish war in the rank of lieutenant field marshal. In an independent command Clerfayt achieved great success, defeating the Turks at Mehadia and Calafat. In 1792, as one of the most distinguished of the emperor's generals, he received the command of the Austrian contingent in the duke of Brunswick's army, and at Croix-sous-Bois his corps inflicted a reverse on the troops of the French revolution. In the Netherlands, to which quarter he was transferred after Jemappes, he opened the campaign of 1793 with the victory of Aldenhoven and the relief of Maestricht, and on March 18th mainly brought about the complete defeat of Dumouriez at Neerwinden. Later in the year, however, his victorious career was checked by the reverse at Wattignies, and in 1794 he was unsuccessful in West Flanders against Pichegru. In the course of the campaign Clerfayt succeeded the duke of Saxe-Coburg in the supreme command, but was quite unable to make head against the French, and had to recross the Rhine. In 1795, now field marshal, he commanded on the middle Rhine against Jourdan, and this time the fortune of war changed. Jourdan was beaten at Höchst and Mainz brilliantly relieved. But the field marshal's action in concluding an armistice with the French not being approved by Thugut, he resigned the command, and became a member of the Aulic Council in Vienna. He died in 1798. A brave and skilful soldier, Clerfayt perhaps achieved more than any other Austrian commander (except the archduke Charles) in the hopeless struggle of small dynastic armies against a "nation in arms."

See von Vivenot, *Thugut, Clerfayt, und Würmser* (Vienna, 1869).

CLERGY (M.E. *clergie*, O. Fr. *clergie*, from Low Lat. form *clericia* [Skeat], by assimilation with O. Fr. *clergiê*, Fr. *clergé*,

from Low Lat. *clericatus*), a collective term signifying in English strictly the body of "clerks," i.e. men in holy orders (see **CLERK**). The word has, however, undergone sundry modifications of meaning. Its M.E. senses of "clerkship" and "learning" have long since fallen obsolete. On the other hand, in modern times there has been an increasing tendency to depart from its strict application to technical "clerks," and to widen it out so as to embrace all varieties of ordained Christian ministers. While, however, it is now not unusual to speak of "the Nonconformist clergy," the word "clergyman" is still, at least in the United Kingdom, used of the clergy of the Established Church in contradistinction to "minister." As applied to the Roman Catholic Church the word embraces the whole hierarchy, whether its *clerici* be in holy orders or merely in minor orders. The term has also been sometimes loosely used to include the members of the regular orders; but this use is improper, since monks and friars, as such, have at no time been *clerici*. The use of the word "clergy" as a plural, though the *New English Dictionary* quotes the high authority of Cardinal Newman for it, is less rare than wrong; in the case cited "Some hundred Clergy" should have been "Some hundred of the Clergy."

In distinction to the "clergy" we find the "laity" (Gr. *λαός*, people), the great body of "faithful people" which, in nearly every various conception of the Christian Church, stands in relation to the clergy as a flock of sheep to its pastor. This distinction was of early growth, and developed, with the increasing power of the hierarchy, during the middle ages into a very lively opposition (see **ORDER**, **HOLY**; **CHURCH HISTORY**; **PAPACY**; **INVESTITURES**). The extreme claim of the great medieval popes, that the priest, as "ruler over spiritual things," was as much superior to temporal rulers as the soul is to the body (see **INNOCENT III.**), led logically to the vast privileges and immunities enjoyed by the clergy during the middle ages. In those countries where the Reformation triumphed, this triumph represented the victory of the civil over the clerical powers in the long contest. The victory was, however, by no means complete. The Presbyterian model was, for instance, as sacerdotal in its essence as the Catholic; Milton complained with justice that "new presbyter is but old priest writ large," and declared that "the Title of Clergy St Peter gave to all God's people," its later restriction being a papal and prelatical usurpation (i.e. 1 Peter v. 3, for *κλήρος* and *κλήρων*).

Clerical immunities, of course, differed largely at different times and in different countries, the extent of them having been gradually curtailed from a period a little earlier than the close of the middle ages. They consisted mainly in exemption from public burdens, both as regarded person and pocket, and in immunity from lay jurisdiction. This last enormous privilege, which became one of the main and most efficient instruments of the subjection of Europe to clerical tyranny, extended to matters both civil and criminal; though, as Bingham shows, it did not (always and everywhere) prevail in cases of heinous crime (*Origines Eccles.* bk. v.).

This diversity of jurisdiction, and subjection of the clergy only to the sentences of judges bribed by their *esprit de corps* to judge leniently, led to the adoption of a scale of punishments for the offences of clerks avowedly much lighter than that which was inflicted for the same crimes on laymen; and this in turn led to the survival in England, long after the Reformation, of the curious legal fiction of benefit of clergy (see below), used to mitigate the extreme harshness of the criminal law.

CLERGY, BENEFIT OF, an obsolete but once very important feature in English criminal law. Benefit of clergy began with the claim on the part of the ecclesiastical authorities in the 12th century that every *clericus* should be exempt from the jurisdiction of the temporal courts and be subject to the spiritual courts alone. The issue of the conflict was that the common law courts abandoned the extreme punishment of death assigned to some offences when the person convicted was a *clericus*, and the church was obliged to accept the compromise and let a secondary punishment be inflicted. The term "clerk" or *clericus* always included a large number of persons in what

were called minor orders, and in 1350 the privilege was extended to secular as well as to religious clerks; and, finally, the test of being a clerk was the ability to read the opening words of verse 1 of Psalm li., hence generally known as the "neck-verse." Even this requirement was abolished in 1705. In 1487 it was enacted that every layman, when convicted of a clergyable felony, should be branded on the thumb, and disabled from claiming the benefit a second time. The privilege was extended to peers, even if they could not read, in 1547, and to women, partially in 1622 and fully in 1692. The partial exemption claimed by the Church did not apply to the more atrocious crimes, and hence offences came to be divided into clergyable and unclergyable. According to the common practice in England of working out modern improvements through antiquated forms, this exemption was made the means of modifying the severity of the criminal law. It became the practice to claim and be allowed the benefit of clergy; and when it was the intention by statute to make a crime really punishable with death, it was awarded "without benefit of clergy." The benefit of clergy was abolished by a statute of 1827, but as this statute did not repeal that of 1547, under which peers were given the privilege, a further statute was passed in 1841 putting peers on the same footing as commons and clergy.

For a full account of benefit of clergy see Pollock and Maitland, *History of English Law*, vol. i. 424-440; also Stephen, *History of the Criminal Law of England*, vol. i.; E. Friedberg, *Corpus juris canonici* (Leipzig, 1879-1881).

CLERGY RESERVES, in Canada. By the act of 1791, establishing the provinces of Upper and Lower Canada, the British government set apart one-eighth of all the crown lands for the support of "a Protestant clergy." These reservations, after being for many years a stumbling-block to the economic development of the province, and the cause of much bitter political and ecclesiastical controversy, were secularized by the Canadian parliament in 1854, and the proceeds applied to other purposes, chiefly educational. Owing to the wording of the imperial act, the amount set apart is often stated as one-seventh, and was sometimes claimed as such by the clergy.

CLERK¹ (from A.S. *cleric* or *clerc*, which, with the similar Fr. form, comes direct from the Lat. *clericus*), in its original sense, as used in the civil law, one who had taken religious orders of whatever rank, whether "holy" or "minor." The word *clericus* is derived from the Greek *κληρικός*, "of or pertaining to an inheritance," from *κληρος*, "lot," "allotment," "estate," "inheritance"; but the authorities are by no means agreed in which sense the root is connected with the sense of the derivative, some conceiving that the original idea was that the clergy received the service of God as their lot or portion; others that they were the portion of the Lord; while others again, with more reason as Bingham (*Orig. Eccl. lib. i. cap. 5, sec. 9*) seems to think, maintain that the word has reference to the choosing by lot, as in early ages was the case of those to whom public offices were to be entrusted.

In the primitive times of the church the term canon was used as synonymous with clerk, from the names of all the persons in the service of any church having been inscribed on a roll, or *κανών*, whence they were termed *canonici*, a fact which shows that the practice of the Roman Catholic Church of including all persons of all ranks in the service of the church, ordained or unordained, in the term clerks, or clergy, is at least in conformity with the practice of antiquity. Thus, too, in English ecclesiastical law, a clerk was any one who had been admitted to the ecclesiastical state, and had taken the tonsure. The application of the word in this sense gradually underwent a change, and "clerk" became more especially the term applied to those in minor orders, while those in "major" or "holy" orders were designated in full "clerks in holy orders," which in English law still remains the designation of clergymen of the Established Church. After the Reformation the word "clerk"

¹The accepted English pronunciation, "clark," is found in southern English as early as the 15th century; but northern dialects still preserve the *c* sound ("clurk"), which is the common pronunciation in America.

was still further extended to include laymen who performed duties in cathedrals, churches, &c., e.g. the choirmen, who were designated "lay clerks." Of these lay clerks or choirmen there was always one whose duty it was to be constantly present at every service, to sing or say the responses as the leader or representative of the laity. His duties were gradually enlarged to include the care of the church and precincts, assisting at baptisms, marriages, &c., and he thus became the precursor of the later *parish clerk*. In a somewhat similar sense we find *bible clerk*, *singing clerk*, &c. The use of the word "clerk" to denote a person ordained to the ministry is now mainly legal or formal.

The word also developed in a different sense. In medieval times the pursuit of letters and general learning was confined to the clergy, and as they were practically the only persons who could read and write all notarial and secretarial work was discharged by them, so that in time the word was used with special reference to secretaries, notaries, accountants or even mere penmen. This special meaning developed into what is now one of the ordinary senses of the word. We find, accordingly, the term applied to those officers of courts, corporations, &c., whose duty consists in keeping records, correspondence, and generally managing business, as *clerk of the market*, *clerk of the petty bag*, *clerk of the peace*, *town clerk*, &c. Similarly, a clerk also means any one who in a subordinate position is engaged in writing, making entries, ordinary correspondence, or similar "clerkly" work. In the United States the word means also an assistant in a commercial house, a retail salesman.

CLERKE, AGNES MARY (1842-1907), English astronomer and scientific writer, was born on the 10th of February 1842, and died in London on the 20th of January 1907. She wrote extensively on various scientific subjects, but devoted herself more especially to astronomy. Though not a practical astronomer in the ordinary sense, she possessed remarkable skill in collating, interpreting and summarizing the results of astronomical research, and as a historian her work has an important place in scientific literature. Her chief works were *A Popular History of Astronomy during the 19th Century*, first edition 1885, fourth 1902; *The System of the Stars*, first edition 1890, second 1905; and *Problems in Astrophysics*, 1903. In addition she wrote *Familiar Studies in Homer* (1892), *The Herschels and Modern Astronomy* (1895), *Modern Cosmogonies* (1906), and many valuable articles, such as her contributions to the *Encyclopaedia Britannica*. In 1903 she was elected an honorary member of the Royal Astronomical Society.

CLERKENWELL, a district on the north side of the city of London, England, within the metropolitan borough of Finsbury (*q.v.*). It is so called from one of several wells or springs in this district, near which miracle plays were performed by the parish clerks of London. This well existed until the middle of the 19th century. Here was situated a priory, founded in 1100, which grew to great wealth and fame as the principal institution in England of the Knights Hospitallers of the Order of St John of Jerusalem. Its gateway, erected in 1504, and remaining in St John's Square, served various purposes after the suppression of the monasteries, being, for example, the birthplace of the *Gentleman's Magazine* in 1731, and the scene of Dr Johnson's work in connexion with that journal. In modern times the gatehouse again became associated with the Order, and is the headquarters of the St John's Ambulance Association. An Early English crypt remains beneath the neighbouring parish church of St John, where the notorious deception of the "Cock Lane Ghost," in which Johnson took great interest, was exposed. Adjoining the priory was St Mary's Benedictine nunnery, St James's church (1792) marking the site, and preserving in its vaults some of the ancient monuments. In the 17th century Clerkenwell became a fashionable place of residence. A prison erected here at this period gave place later to the House of Detention, notorious as the scene of a Fenian outrage in 1867, when it was sought to release certain prisoners by blowing up part of the building. Clerkenwell is a centre of the watch-making and jeweller's industries, long established here; and the Northampton

Polytechnic Institute, Northampton Square, a branch of the City Polytechnic, has a department devoted to instruction in these trades.

CLERMONT-EN-BEAUVAISIS, or **CLERMONT-DE-L'OISE**, a town of northern France, capital of an *arrondissement* in the department of Oise, on the right bank of the Brèche, 41 m. N. of Paris on the Northern railway to Amiens. Pop. (1906) 4014. The hill on which the town is built is surmounted by a keep of the 14th century, the relic of a fortress the site of which is partly occupied by a large penitentiary for women. The church dates from the 14th to the 16th centuries. The *hôtel-de-ville*, built by King Charles IV., who was born at Clermont in 1294, is the oldest in the north of France. The most attractive feature of the town is the Promenade du Châtelier on the site of the old ramparts. Clermont is the seat of a sub-prefect and has a tribunal of first instance, a communal college and a large lunatic asylum. It manufactures felt and corsets, and carries on a trade in horses, cattle and grain.

The town was probably founded during the time of the Norman invasions, and was an important military post during the middle ages. It was several times taken and retaken by the contending parties during the Hundred Years' War, and the Wars of Religion, and in 1615 Henry II., prince of Condé, was besieged and captured there by the marshal d'Ancre.

COUNTS OF CLERMONT. Clermont was at one time the seat of a countship, the lords of which were already powerful in the 11th century. Raoul de Clermont, constable of France, died at Acre in 1191, leaving a daughter who brought Clermont to her husband, Louis, count of Blois and Chartres. Theobald, count of Blois and Clermont, died in 1218 without issue, and King Philip Augustus, having received the countship of Clermont from the collateral heirs of this lord, gave it to his son Philip Hurepel, whose daughter Jeanne, and his widow, Mahaut, countess of Dammartin, next held the countship. It was united by Saint Louis to the crown, and afterwards given by him (1269) to his son Robert, from whom sprang the house of Bourbon. In 1524 the countship of Clermont was confiscated from the constable de Bourbon, and later (1540) given to the duke of Orleans, to Catherine de' Medici (1562), to Eric, duke of Brunswick (1569), from whom it passed to his brother-in-law Charles of Lorraine (1596), and finally to Henry II., prince of Condé (1611). In 1641 it was again confiscated from Louis de Bourbon, count of Soissons, then in 1696 sold to Louis Thomas Amadeus of Savoy, count of Soissons, in 1702 to Françoise de Brancas, princesse d'Harcourt, and in 1719 to Louis-Henry, prince of Condé. From a branch of the old lords of Clermont were descended the lords of Nesle and Chantilly.

CLERMONT-FERRAND, a city of central France, capital of the department of Puy-de-Dôme, 113 m. W. of Lyons on the Paris-Lyon railway. Pop. (1906) town, 44,113; commune, 58,363. Clermont-Ferrand is situated on an eminence on the western border of the fertile plain of Limagne. On the north, west and south it is surrounded by hills, with a background of mountains amongst which the Puy-de-Dôme stands out prominently. A small river, the Tiretaine, borders the town on the north. Since 1731 it has been composed of the two towns of Clermont and Montferrand, now connected by a fine avenue of walnut trees and willows, 2 m. in length, bordered on one side by barracks. The watering-place of Royat lies a little more than a mile to the west. Clermont has several handsome squares ornamented with fountains, the chief of which is a graceful structure erected by Bishop Jacques d'Amboise in 1515. The streets of the older and busier quarter of Clermont in the neighbourhood of the cathedral and the Place de Jaude, the principal square, are for the most part narrow, sombre and bordered by old houses built of lava; boulevards divide this part from more modern and spacious quarters, which adjoin it. To the south lies the fine promenade known as the Jardin Lecoq.

The principal building is the cathedral, a Gothic edifice begun in the 13th century. It was not completed, however, till the 19th century, when the west portal and towers and two bays of the nave were added, according to the plans of Viollet-le-Duc. The fine stained glass of the windows dates from the

13th to the 15th centuries. A monument of the Crusades with a statue of Pope Urban II. stands in the Cathedral square. The church of Notre-Dame du Port is a typical example of the Romanesque style of Auvergne, dating chiefly from the 11th and 12th centuries. The exterior of the choir, with its four radiating chapels, its jutting cornices supported by modillions and columns with carved capitals, and its mosaic decoration of black and white stones, is the most interesting part of the exterior. The rest of the church comprises a narthex surmounted by a tower, three naves and a transept, over which rises another tower. There are several churches of minor importance in the town. Among the old houses one, dating from the 16th century, was the birthplace of Blaise Pascal, whose statue stands in a neighbouring square. There is a statue of General Louis Charles Desaix de Veygoux in the Place de Jaude. Montferrand has several interesting houses of the 15th and 16th centuries, and a church of the 13th, 14th and 15th centuries.

Clermont-Ferrand is the seat of a bishopric and a prefecture and headquarters of the XIII. army corps; it has tribunals of first instance and of commerce, a board of trade-arbitrators, a chamber of commerce, an exchange and a branch of the Bank of France. The town is the centre of an educational division (*académie*), and has faculties of science and of literature. It also has lycées and training colleges for both sexes, ecclesiastical seminaries, a preparatory school of medicine and pharmacy, schools of architecture, music, commerce and industry, museums of art and antiquities and natural history and a library. A great variety of industries is carried on, the chief being the manufacture of semolina and other farinaceous foods, confectionery, preserved fruit and jams, chemicals and rubber goods. Liqueurs, chicory, chocolate, candles, hats, boots and shoes, and woollen and linen goods are also made, and tanning is practised. Clermont is the chief market for the grain and other agricultural produce of Auvergne and Velay. Its waters are in local repute. On the bank of the Tiretaine there is a remarkable calcareous spring, the fountain of St Allyre, the copious deposits of which have formed a curious natural bridge over the stream.

Clermont is identified with the ancient *Augustonemetum*, the chief town of the Arverni, and it still preserves some remains of the Roman period. The present name, derived from *Clarus Mons* and originally applied only to the citadel, was used of the town as early as the 9th century. During the disintegration of the Roman empire Clermont suffered as much perhaps from capture and pillage as any city in the country; its history during the middle ages chiefly records the struggles between its bishops and the counts of Auvergne, and between the citizens and their overlord the bishop. It was the seat of seven ecclesiastical councils, held in the years 535, 549, 587, 1095, 1110, 1124 and 1130; and of these the council of 1095 is for ever memorable as that in which Pope Urban II. proclaimed the first crusade. In the wars against the English in the 14th and 15th centuries and the religious wars of the 16th century the town had its full participation; and in 1665 it acquired a terrible notoriety by the trial and execution of many members of the nobility of Auvergne who had tyrannized over the neighbouring districts. The proceedings lasted six months, and the episode is known as *les Grands Jours de Clermont*. Before the Revolution the town possessed several monastic establishments, of which the most important were the abbey of Saint Allyre, founded, it is said, in the 3rd century by St Austremonius (St Stremoine), the apostle of Auvergne and first bishop of Clermont, and the abbey of St André, where the counts of Clermont were interred.

CLERMONT-GANNEAU, CHARLES SIMON (1846-), French Orientalist, the son of a sculptor of some repute, was born in Paris on the 19th of February 1846. After an education at the *École des Langues Orientales*, he entered the diplomatic service as dragoman to the consulate at Jerusalem, and afterwards at Constantinople. He laid the foundation of his reputation by his discovery (in 1870) of the "stele" of Mesha (Moabite Stone), which bears the oldest Semitic inscription known. In 1874 he was employed by the British government to take charge of an archaeological expedition to Palestine, and was

subsequently entrusted by his own government with similar missions to Syria and the Red Sea. He was made chevalier of the Legion of Honour in 1875. After serving as vice-consul at Jaffa from 1880 to 1882, he returned to Paris as "secrétaire-interprète" for oriental languages, and in 1886 was appointed consul of the first class. He subsequently accepted the post of director of the École des Langues Orientales and professor at the Collège de France. In 1889 he was elected a member of the Académie des Inscriptions et Belles Lettres, of which he had been a correspondent since 1880. In 1896 he was promoted to be consul-general, and was minister plenipotentiary in 1906. He was the first in England to expose the famous forgeries of Hebrew texts offered to the British Museum by M. W. Shapira (*q.v.*) in 1883, and in 1903 he took a prominent part in the investigation of the so-called "tiara of Saitapharnes." This tiara had been purchased by the Louvre for 400,000 francs, and exhibited as a genuine antique. Much discussion arose as to the perpetrators of the fraud, some believing that it came from southern Russia. It was agreed, however, that the whole object, except perhaps the band round the tiara, was of modern manufacture.

His chief publications, besides a number of contributions to journals, are:—*Palestine inconnue* (1886), *Études d'archéologie orientale* (1880, &c.), *Les Fraudes archéologiques* (1885), *Recueil d'archéologie orientale* (1885, &c.), *Album d'antiquités orientales* (1897, &c.).

CLERMONT-L'HERAULT, or **CLERMONT DE LODÈVE**, a town of southern France in the department of Hérault, 10 m. S.S.E. by rail of Lodève. Pop. (1906) 4731. The town is built on the slope of a hill which is crowned by an ancient castle and skirted by the Rhonel, a tributary of the Lergue. It has an interesting church of the 13th and 14th centuries. The chief manufacture is that of cloth for military clothing, and woollen goods, an industry which dates from the latter half of the 17th century. Tanning and leather-dressing are also carried on, and there is trade in wine, wool and grain. Among the public institutions are a tribunal of commerce, a chamber of arts and manufactures, a board of trade-arbitration and a communal college. The town was several times taken and retaken in the religious wars of the 16th century.

CLERMONT-TONNERRE, the name of a French family, members of which played some part in the history of France, especially in Dauphiné, from about 1100 to the Revolution. Sibaud, lord of Clermont in Viennois, who first appears in 1080, was the founder of the family. His descendant, another Sibaud, commanded some troops which aided Pope Calixtus II. in his struggle with the anti-pope Gregory VIII.; and in return for this service it is said that the pope allowed him to add certain emblems—two keys and a tiara—to the arms of his family. A direct descendant, Ainard (d. 1349), called vicomte de Clermont, was granted the dignity of captain-general and first baron of Dauphiné by his suzerain Humbert, dauphin of Viennois, in 1340; and in 1547 Clermont was made a county for Antoine (d. 1578), who was governor of Dauphiné and the French king's lieutenant in Savoy. In 1572 Antoine's son Henri was created a duke, but as this was only a "brevet" title it did not descend to his son. Henri was killed before La Rochelle in 1573. In 1596 Henri's son, Charles Henri, count of Clermont (d. 1640), added Tonnerre to his heritage; but in 1648 this county was sold by his son and successor, François (d. 1679).

A member of a younger branch of Charles Henri's descendants was Gaspard de Clermont-Tonnerre (1688–1781). This soldier served his country during a long period, fighting in Bohemia and Alsace, and then distinguishing himself greatly at the battles of Fontenoy and Lawfeldt. In 1775 he was created duke of Clermont-Tonnerre, and made a peer of France; as the senior marshal (cr. 1747) of France he assisted as constable at the coronation of Louis XVI. in 1774. His son and successor, Charles Henri Jules, governor of Dauphiné, was guillotined in July 1794, a fate which his grandson, Gaspard Charles, had suffered at Lyons in the previous year. A later duke, Aimé Marie Gaspard (1779–1865), served for some years as a soldier, afterwards becoming minister of marine and then minister of war under Charles X.,

and retiring into private life after the revolution of 1830. Aimé's grandson, Roger, duke of Clermont-Tonnerre, was born in 1842.

Among other distinguished members of this family was Catherine (c. 1545–1603), only daughter of Claude de Clermont-Tonnerre. This lady, *dame d'honneur* to Henry II.'s queen, Catherine de' Medici, and afterwards wife of Albert de Gondi, duc de Retz, won a great reputation by her intellectual attainments, being referred to as the "tenth muse" and the "fourth grace." One of her grandsons was the famous cardinal de Retz. Other noteworthy members of collateral branches of the family were: François (1629–1701), bishop of Noyon from 1661 until his death, a member of the French Academy, notorious for his inordinate vanity; Stanislas M. A., comte de Clermont-Tonnerre (*q.v.*); and Anne Antoine Jules (1749–1830), cardinal and bishop of Châlons, who was a member of the states-general in 1789, afterwards retiring into Germany, and after the return of the Bourbons to France became archbishop of Toulouse.

CLERMONT-TONNERRE, STANISLAS MARIE ADELAIDE, COMTE DE (1757–1792), French politician, was born at Pont-à-Mousson on the 10th of October 1757. At the beginning of the Revolution he was a colonel, with some reputation as a free-mason and a Liberal. He was elected to the states-general of 1789 by the noblesse of Paris, and was the spokesman of the minority of Liberal nobles who joined the Third Estate on the 25th of June. He desired to model the new constitution of France on that of England. He was elected president of the Constituent Assembly on the 17th of August 1789; but on the rejection by the Assembly of the scheme elaborated by the first constitutional committee, he attached himself to the party of moderate royalists, known as *monarchiens*, led by P. V. Malouet. His speech in favour of reserving to the crown the right of absolute veto under the new constitution drew down upon him the wrath of the advanced politicians of the Palais Royal; but in spite of threats and abuse he continued to advocate a moderate liberal policy, especially in the matter of removing the political disabilities of Jews and Protestants and of extending the system of trial by jury. In January 1790 he collaborated with Malouet in founding the Club des Impartiaux and the *Journal des Impartiaux*, the names of which were changed in November to the Société des Amis de la Constitution Monarchique and *Journal de la Société, &c.* in order to emphasize their opposition to the Jacobins (Société des Amis de la Constitution). This club was denounced by Barnave in the Assembly (January 21st, 1791), and on the 28th of March it was attacked by a mob, whereupon it was closed by order of the Assembly. Clermont-Tonnerre was murdered by the populace during the rising of the 9th and 10th of August 1792. He was an excellent orator, having acquired practice in speaking, before the Revolution, in the masonic lodges. He is a good representative of the type of the *grands seigneurs* holding advanced and liberal ideas, who helped to bring about the movement of 1789, and then tried in vain to arrest its course.

See *Recueil des opinions de Stanislas de Clermont-Tonnerre* (4 vols., Paris, 1791), the text of his speeches as published by himself; A. Aulard, *Les Orateurs de la Constituante* (2nd ed., Paris, 1905).

CLERUCHY (Gr. κληρουχία, from κλήρος, a lot, ἔχειν, to have), in ancient Greek history a kind of colony composed of Athenian¹ citizens planted, practically as a garrison, in a conquered country. Strictly, the settlers (cleruchs) were not colonists, inasmuch as they retained their status as citizens of Athens (e.g. ὁ δῆμος δ' ἐν Ἰφαιστία), and their allotments were politically part of Attic soil. These settlements were of three kinds: (1) where the earlier inhabitants were extirpated or expatriated, and the settlers occupied the whole territory; (2) where the settlers occupied allotments in the midst of a conquered people; and (3) where the inhabitants gave up portions of land to settlers in return for certain pecuniary concessions. The primary object (cf. the 4000 cleruchs settled in 506 B.C. upon the lands of the conquered oligarchs of Euboea, known as the Hippobotae) was unquestionably military, and in the later days of the Delian

¹ It seems (Strabo, p. 635) that similar colonies were sent out by the Milesians, e.g. to Leros.

League the system was the simplest precaution against disaffection on the part of the allies, the strength of whose resentment may be gathered from an inscription (Hicks and Hill, 101 [81]), which, in setting forth the terms of the second Delian Confederacy, expressly forbids the holding of land by Athenians in allied territory.

A secondary object of the cleruchies was social or agrarian, to provide a source of livelihood to the poorer Athenians. Plutarch (*Pericles*, 11) suggests that Pericles by this means rid the city of the idle and mischievous loafers; but it would appear that the cleruchs were selected by lot, and in any case a wise policy would not deliberately entrust important military duties to recognized wastrels. When we remember that in 50 years of the 5th century some 10,000 cleruchs went out, it is clear that the drain on the citizen population was considerable.

It is impossible to decide precisely how far the state retained control over the cleruchs. Certainly they were liable to military service and presumably to that taxation which fell upon Athenians at home. That they were not liable for the tribute which members of the Delian League paid is clear from the fact that the assessments of places where cleruchs were settled immediately went down considerably (cf. the Periclean cleruchies, 450-445); indeed, this follows from their status as Athenian citizens, which is emphasized by the fact that they retained their membership of deme and tribe. In internal government the cleruchs adopted the Boulê and Assembly system of Athens itself; so we read of Polemarchs, Archons Eponymi, Agoranomi, Strategi, in various places. With a measure of local self-government there was also combined a certain central authority (e.g. in the matter of jurisdiction, some case being tried by the Nautodicae at Athens); in fact we may assume that the more important cases, particularly those between a cleruch and a citizen at home, were tried before the Athenian dicasts. In a few cases, the cleruchs, e.g. in the case of Lesbos (427), were apparently allowed to remain in Athens receiving rent for their allotments from the original Lesbian owners (Thuc. iii. 50); but this represents the perversion of the original idea of the cleruchy to a system of reward and punishment.

See G. Gilbert, *Constitutional Antiquities of Athens and Sparta* (Eng. trans., London, 1895), but note that Brea, wrongly quoted as an example, is not a cleruchy but a colony (Hicks and Hill, 41 [29]); A. H. J. Greenidge, *Handbook of Greek Constitutional Antiquities* (London, 1896); for the Periclean cleruchs see PERICLES; DELIAN LEAGUE.

CLERVAUX (*clara vallis*), a town in the northern province of Oesling, grand-duchy of Luxemburg, on the Clerf, a tributary of the Sûre. Pop. (1905) 866. In old days it was the fief of the de Lannoy family, and the present proprietor is the bearer of a name not less well known in Belgian history, the count de Berlaymont. The old castle of the de Lannoys exists, and might easily be restored, but its condition is now neglected and dilapidated. In 1798 the people of Clervaux specially distinguished themselves against the French in an attempt to resist the institution of the conscription. The survivors of what was called the Kloppel-krieg (the "cudgel war") were shot, and a fine monument commemorates the heroism of the men of Clervaux.

CLETUS, formerly regarded as the name of one of the early successors of St Peter in the see of Rome, or, according to Epiphanius and Rufinus, as sharing the direction of the Roman Church with Linus during Peter's lifetime. He has been identified beyond doubt with Anencletus (*q.v.*). See Père Colombier, in *Rev. des questions hist.* Ap. 1st, 1876, p. 413.

CLEVEDON, a watering-place in the northern parliamentary division of Somersetshire, England, on the Bristol Channel, 15½ m. W. of Bristol on a branch of the Great Western railway. Pop. of urban district (1901) 5900. The cruciform church of St Andrew has Norman and later portions; it is the burial-place of Henry Hallam the historian, and members of his family, including his sons Arthur and Henry. Clevedon Court is a remarkable medieval mansion, dating originally from the early part of the 14th century, though much altered in the Elizabethan and other periods. The house is considered to be the original

of "Castlewood" in Thackeray's *Esmond*; the novelist was acquainted with the place through his friendship with the Rev. William Brookfield and his wife, the daughter of Sir Charles Elton of Clevedon Court.

CLEVELAND, BARBARA VILLIERS, DUCHESS OF (1641-1709), mistress of the English king Charles II., was the daughter of William Villiers, 2nd Viscount Grandison (d. 1643), by his wife Mary (d. 1684), daughter of Paul, 1st Viscount Bayning. In April 1659 Barbara married Roger Palmer, who was created earl of Castlemaine two years later, and soon after this marriage her intimacy with Charles II. began. The king was probably the father of her first child, Anne, born in February 1661, although the paternity was also attributed to one of her earliest lovers, Philip Stanhope, 2nd earl of Chesterfield (1633-1713). Mistress Palmer, as Barbara was called before her husband was made an earl, was naturally much disliked by Charles's queen, Catherine of Braganza, but owing to the insistence of the king she was made a lady of the bedchamber to Catherine, and began to mix in the political intrigues of the time, showing an especial hatred towards Edward Hyde, earl of Clarendon, who reciprocated this feeling and forbade his wife to visit her. Her house became a rendezvous for the enemies of the minister, and according to Pepys she exhibited a wild paroxysm of delight when she heard of Clarendon's fall from power in 1667. Whilst enjoying the royal favour Lady Castlemaine formed *liaisons* with various gentlemen, which were satirized in public prints, and a sharp quarrel which occurred between her and the king in 1667 was partly due to this cause. But peace was soon made, and her influence, which had been gradually rising, became supreme at court in 1667 owing to the marriage of Frances Stuart (la belle Stuart) (1648-1702) with Charles Stuart, 3rd duke of Richmond (1640-1672). Accordingly Louis XIV. instructed his ambassador to pay special attention to Lady Castlemaine, who had become a Roman Catholic in 1663.

In August 1670 she was created countess of Southampton and duchess of Cleveland, with remainder to her first and third sons, Charles and George Palmer, the king at this time not admitting the paternity of her second son Henry; and she also received many valuable gifts from Charles. An annual income of £4700 from the post office was settled upon her, and also other sums chargeable upon the revenue from the customs and the excise, whilst she obtained a large amount of money from seekers after office, and in other ways. Nevertheless her extravagance and her losses at gaming were so enormous that she was unable to keep up her London residence, Cleveland House, St James's, and was obliged to sell the contents of her residence at Cheam. About 1670 her influence over Charles began to decline. She consoled herself meanwhile with lovers of a less exalted station in life, among them John Churchill, afterwards duke of Marlborough, and William Wycherley; by 1674 she had been entirely supplanted at court by Louise de Kéroualle, duchess of Portsmouth. Soon afterwards the duchess of Cleveland went to reside in Paris, where she formed an intrigue with the English ambassador, Ralph Montagu, afterwards duke of Montagu (d. 1709), who lost his position through some revelations which she made to the king. She returned to England just before Charles's death in 1685. In July 1705 her husband, the earl of Castlemaine, whom she had left in 1662, died; and in the same year the duchess was married to Robert (Beau) Feilding (d. 1712), a union which was declared void in 1707, as Feilding had a wife living. She died at Chiswick on the 9th of October 1709.

Bishop Burnet describes her as "a woman of great beauty, but most enormously vicious and ravenous, foolish but imperious, ever uneasy to the king, and always carrying on intrigues with other men, while yet she pretended she was jealous of him." Dryden addressed Lady Castlemaine in his fourth poetical *Epistle* in terms of great adulation, and Wycherley dedicated to her his first play, *Love in a Wood*. Her portrait was frequently painted by Sir Peter Lely and others, and many of these portraits are now found in various public and private collections. By Charles II. she had three sons and either one or two daughters.

She had also in 1686 a son by the actor Cardonnell Goodman (d. 1699), and one or two other daughters.

Her eldest son, Charles Fitzroy (1662-1730), was created in 1675 earl of Chichester and duke of Southampton, and became duke of Cleveland and earl of Southampton on his mother's death. Her second son, Henry (1663-1690), was created earl of Euston in 1672 and duke of Grafton in 1675; by his wife Isabella, daughter of Henry Bennet, earl of Arlington, he was the direct ancestor of the later dukes of Grafton; he was the most popular and the most able of the sons of Charles II., saw a considerable amount of military service, and met his death through a wound received at the storming of Cork. Her third son, George (1665-1716), was created duke of Northumberland in 1683, and died without issue, after having served in the army. Her daughters were Anne (1661-1722), married in 1674 to Thomas Lennard, Lord Dacre (d. 1715), who was created earl of Sussex in 1684; Charlotte (1664-1718), married in 1677 to Edward Henry Lee, earl of Lichfield (d. 1716); and Barbara (1672-1737), the reputed daughter of John Churchill, who entered a nunnery in France, and became by James Douglas, afterwards 4th duke of Hamilton (1658-1712), the mother of an illegitimate son, Charles Hamilton (1691-1754).

The first husband of the duchess, Roger Palmer, earl of Castlemaine (1634-1705), diplomatist and author, was an ardent Roman Catholic, who defended his co-religionists in several publications. Having served in the war against Holland in 1665-67, he wrote in French an account of this struggle, which was translated into English and published by T. Price in London in 1671. Having been denounced by Titus Oates as a Jesuit, he was tried and acquitted, afterwards serving James II. as ambassador to Pope Innocent XI., a mission which led to a brief imprisonment after the king's flight from England. Subsequently his Jacobite sympathies caused him to be suspected by the government, and his time was mainly spent either in prison or in exile. The earl died at Oswestry on the 21st of July 1705.

The title of duke of Cleveland, which had descended in 1709 to Charles Fitzroy, together with that of duke of Southampton, became extinct when Charles's son William, the 2nd duke, died without issue in 1774. One of the first duke's daughters, Grace, was married in 1725 to Henry Vane, 3rd Baron Barnard, afterwards earl of Darlington (d. 1758), and their grandson William Henry Vane (1766-1842) was created duke of Cleveland in 1833. The duke was succeeded in the title in turn by three of his sons, who all died without male issue; and consequently when Harry George, the 4th duke, died in 1891 the title again became extinct.

Previous to the creation of the dukedom of Cleveland there was an earldom of Cleveland which was created in 1626 in favour of Thomas, 4th Baron Wentworth (1591-1667), and which became extinct on his death.

See the article CHARLES II. and the bibliography thereto; G. S. Steinmann, *Memoir of Barbara, duchess of Cleveland* (London, 1871), and *Addenda* (London, 1874); and the articles ("Villiers, Barbara" and "Palmer, Roger") in the *Dictionary of National Biography*, vols. xliii. and lviii. (London, 1895-1899).

CLEVELAND (or **CLEIVELAND**), **JOHN** (1613-1658), English poet and satirist, was born at Loughborough, where he was baptized on the 20th of June 1613. His father was assistant to the rector and afterwards vicar of Hinckley. John Cleveland was educated at Hinckley school under Richard Vines, who is described by Fuller as a champion of the Puritan party. In his fifteenth year he was entered at Christ's College, Cambridge, and in 1634 was elected to a fellowship at St John's. He took his M.A. degree in 1635, and was appointed college tutor and reader in rhetoric. His Latin and oratorical powers were warmly praised by Fuller, who also commends the "lofty fancy" of his verse. He eagerly opposed the candidature of Oliver Cromwell as M.P. for Cambridge, and when the Puritan party triumphed there Cleveland, like many other Cambridge students, found his way (1643) to Oxford. His gifts as a satirist were already known, and he was warmly received by the king, whom he followed (1645) to Newark. In that year he was formally deprived of his

Cambridge fellowship as a "malignant." He was judge-advocate in the garrison at Newark, and under the governor defended the town until in 1646 Charles I. ordered the surrender of the place to Leslie; when there is a curious story that the Scottish general contemptuously dismissed him as a mere ballad-monger. He saw Charles's error in giving himself into the hands of the Scots, and his indignation when they surrendered the king to the Parliament is expressed in the vigorous verses of "The Rebel Scot," the sting of which survives even now. Cleveland wandered over the country depending on the alms of the Royalists for bread. He at length found a refuge at Norwich in the house of Edward Cooke, but in 1655 he was arrested as being of no particular occupation, and moreover a man whose great abilities "rendered him able to do the greater disservice." He spent three months in prison at Yarmouth, but was released by order of Cromwell, to whom he addressed a manly appeal, in which he declared his fidelity to the royal house, pointing out at the same time that his poverty and inoffensiveness were sufficient assurance that his freedom was no menace to Cromwell's government. He was released early in 1656, and seems to have renewed his wanderings, finding his way eventually to Gray's Inn, where Aubrey says he and Samuel Butler had a "club" every night. There he died on the 29th of April 1658.

Cleveland's poems were more highly esteemed than Milton's by his contemporaries, and his popularity is attested by the very numerous editions of his works. His poems are therefore of great value as an index to the taste of the 17th century. His verse is frequently obscure and full of the far-fetched conceits of the "metaphysical" poets, none of whom surpassed the ingenuity of "Fusara, or the Bee Errant." His satires are vigorous personal attacks, the interest of which is, from the nature of the subject, often ephemeral; but the energy of his invective leaves no room for obscurity in such pieces as "Smectymnuus, or the Club Divines," "Rupertismus" and "The Rebel Scot."

Cleveland's works are: "Character of a London Diurnal," a broadside; *Monumentum regale*. . . (1649), chiefly by Cleveland, containing three of his elegies on the king; "The King's Disguise" (1646); "On the Memory of Mr Edward King," in the collection of verse which also included Milton's "Lycidas," and many detached poems.

For a bibliographical account of Cleveland's poems see J. M. Berdan, *The Poems of John Cleveland* (New York, 1903), in which there is a table of the contents of twenty-three editions, of which the chief are: *The Character of a London Diurnal, with Several Select Poems* (1647); *Poems. By John Cleveland. With additions, never before printed* (1659); *J. Cleaveland Revived*. . . (1659), in which the editor, E. Williamson, says he inserted poems by other authors, trusting to the critical faculty of the readers to distinguish Cleveland's work from the rest; *Cleavelandi Vindiciae*. . . (1677), edited by two of Cleveland's former pupils, Bishop Lake and S. Drake, who profess to take out the spurious pieces; and a careless compilation, *The Works of John Cleveland*. . . (1687), containing poems taken from all these sources. A prefatory note by Williamson makes it clear that only a small proportion of Cleveland's political poems have survived, many of them having been dispersed in MS. among his friends and so lost, and that he refused to authenticate an edition of his works, although most of the earlier collections were genuine.

CLEVELAND, STEPHEN GROVER (1837-1908), president of the United States from 1885 to 1889, and again from 1893 to 1897, was born, the fifth in a family of nine children, in the village of Caldwell, Essex county, New Jersey, on the 18th of March 1837. His father, Richard F. Cleveland, a clergyman of the Presbyterian Church, was of good colonial stock, a descendant of Moses Cleveland, who emigrated from Ipswich, England, to Massachusetts in 1635. The family removed to Fayetteville, N.Y., and afterwards to Clinton, N.Y. It was intended that young Grover should be educated at Hamilton College, but this was prevented by his father's death in 1852. A few years later he drifted westward with twenty-five dollars in his pocket, and the autumn of 1855 found him in a law office in the city of Buffalo. At the end of four years (1859), he was admitted to the bar.

In 1863 he was appointed assistant district attorney of Erie county, of which Buffalo is the chief city. This was his first

public office, and it came to him, like all later preferments, without any solicitation of his own. Two years later (1865) he was the Democratic candidate for district attorney, but was defeated. In 1869 Cleveland was nominated by the Democratic party for the office of sheriff, and, despite the fact that Erie county was normally Republican by a decisive majority, was elected. The years immediately succeeding his retirement from the office of sheriff in 1873 he devoted exclusively to the practice of law, coming to be generally recognized as one of the leaders of the western New York bar. In the autumn of 1881 he was nominated by the Democrats for mayor of Buffalo. The city government had been characterized by extravagance and maladministration, and a revolt of the independent voters at the polls overcame the usual Republican majority and Cleveland was elected. As mayor he attracted wide attention by his independence and business-like methods, and under his direction the various departments of the city government were thoroughly reorganized. His ability received further recognition when in 1882 he was nominated by his party as its candidate for governor. The Republican party in the state was at that time weakened by the quarrels between the "Stalwart" and "Halfbreed" factions within its ranks; and the Democrats were thus given an initial advantage which was greatly increased by the Republicans' nomination for governor of Charles J. Folger (1818-1884), then secretary of the treasury. Secretary Folger was a man of high character and ability, who had been chief justice of the New York supreme court when placed in control of the treasury department by President Arthur in 1881. But the cry of Federal interference was raised as a result of the methods employed in securing his nomination, and this, together with the party division and the popularity of Cleveland, brought about Cleveland's election by the unprecedented plurality of 192,854. As governor Cleveland's course was marked by the sterling qualities that he had displayed in his other public positions. His appointees were chosen for their business qualifications. The demands of party leaders were made subordinate to public interests. He promoted the passage of a good civil service law. All bills passed by the legislature were subjected to the governor's laborious personal scrutiny, and the veto power was used without fear or favour.

In 1884 the Democratic party had been out of power in national affairs for twenty-three years. In this year, however, the generally disorganized state of the Republican party seemed to give the Democrats an unusual opportunity. Upon a platform which called for radical reforms in the administrative departments, the civil service, and the national finances, Cleveland was nominated for president, despite the opposition of the strong Tammany delegation from his own state. The nominee of the Republican party, James G. Blaine (*q. v.*) of Maine, had received the nomination only after a contest in which violent personal animosities were aroused. The campaign that followed was one of the bitterest political contests in American history. The Republican party was still further weakened by the defection of a large body of independents, known as "Mugwumps." The result was close, but Cleveland carried New York, and was elected, obtaining a majority in the electoral college of 219 to 182.

Cleveland's first term was uneventful, but was marked by firmness, justice and steady adherence on his part to the principles which he deemed salutary to the nation. He was especially concerned in promoting a non-partisan civil service. Congress in 1883 had passed the "Pendleton Bill" (introduced by Senator George H. Pendleton) to classify the subordinate places in the service, and to make entrance to it, and promotion therein, depend upon competitive examination of applicants, instead of mere political influence. The first test of the efficiency and permanence of this law came with the shifting of political power at Washington. The new president stood firmly by the new law. It applied only to places of the rank of clerkships, but the president was authorized to add others to the classified service from time to time. He added 11,757 during his first term.

President Cleveland made large use of the veto power upon bills passed by Congress, vetoing or "pocketing" during his first term 413 bills, more than two-thirds of which were private

pension bills. The most important bill vetoed was the Dependent Pension Bill, a measure of extreme profligacy, opening the door, by the vagueness of its terms, to enormous frauds upon the treasury. In 1887 there was a large and growing surplus in the treasury. As this money was drawn from the channels of business and locked up in the public vaults, the president looked upon the condition as fraught with danger to the commercial community and he addressed himself to the task of reducing taxation. About two-thirds of the public revenue was derived from duties on imports, in the adjustment of which the doctrine of protection to native industry had a large place. Cleveland attacked the system with great vigour in his annual message of 1887. He did not propose the adoption of free trade, but the administration tariff measure, known as the Mills Bill, from its introducer Congressman Roger Q. Mills (b. 1832) of Texas, passed the House, and although withdrawn owing to amendments in the Republican Senate, it alarmed and exasperated the protected classes, among whom were many Democrats, and spurred them to extraordinary efforts to prevent his re-election.

In the following year (1888), however, the Democrats re-nominated Cleveland, and the Republicans nominated Benjamin Harrison of Indiana. The campaign turned on the tariff issue, and Harrison was elected, receiving 233 electoral votes to 168 for Cleveland, who however received a popular plurality of more than 100,000. Cleveland retired to private life and resumed the practice of the law in New York. He had married on the 2nd of June 1886 Miss Frances Folsom, a daughter of a former law partner in Buffalo.

Congress had passed a law in 1878 requiring the treasury department to purchase a certain amount of silver bullion each month and coin it into silver dollars to be full legal tender. As no time had been fixed for this operation to cease, it amounted to an unlimited increase of a kind of currency that circulated at a nominal value much above its real value. Both political parties were committed to this policy, and strong passions were aroused whenever it was called in question. Cleveland had written a letter for publication before he became president, saying that a financial crisis of great severity must result if this coinage were continued, and expressing the hope that Congress would speedily put an end to it. In 1890 Congress, now controlled by the Republican party, passed the McKinley Bill, by which the revenues of the government were reduced by more than \$60,000,000 annually, chiefly through a repeal of the sugar duties. At the same time expenditures were largely increased by liberal pension legislation, and the government's purchase of silver bullion almost doubled by the provisions of the new Sherman Silver Purchase Act of 1890.

In 1892 Cleveland was nominated for president a third time in succession. President Harrison was nominated by the Republicans. Cleveland received 277 electoral votes and Harrison 145, and 22 were cast for James B. Weaver (b. 1833) of Iowa, the candidate of the "People's" party. Cleveland's second term embraced some notable events. The most important was the repeal of the silver legislation, which had been a growing menace for fifteen years. Nearly \$600,000,000 of "fiat money" had been thrust into the channels of commerce in addition to \$346,000,000 of legal tender notes that had been issued during the Civil War. A reserve of \$100,000,000 of gold had been accumulated for the redemption of these notes. In April 1893 the reserve fell below this sum. President Cleveland called an extra session of Congress to repeal the Silver Law. The House promptly passed the repealing act. In the Senate there was a protracted struggle. The Democrats now had a majority of that body and they were more decidedly pro-silver than the Republicans. The president had undertaken to coerce his own party to do something against its will, and it was only by the aid of the Republican minority that the passage of the repealing bill was at last made possible (October 30th). The mischief, however, was not ended. The deficit in the treasury made it inevitable that the gold reserve should be used to meet current expenses. Holders of the government's legal tender notes anticipating this fact presented them for redemption. Borrowing was

resorted to by the government. Bonds were issued and sold to the amount of \$162,000,000. The business world was in a state of constant agitation. Bank failures were numerous and commercial distress widespread. Among the consequences of the panic was a reduction of wages in many employments, accompanied by labour troubles more or less serious. The centre of disturbance was the Pullman strike at Chicago (*q.v.*), whence the disorder extended to the Pacific coast, causing riot and bloodshed in many places. President Cleveland waited a reasonable time, as he conceived, for Governor Altgeld of Illinois to put an end to the disorder in that state. On the 6th of July 1894, despite Governor Altgeld's protest, he directed the military forces of the United States to clear the way for trains carrying the mails. The rioters in and around Chicago were dispersed in a single day, and within a week the strike was broken.

Another important event was the action of the government as regards the question of arbitration between Great Britain and Venezuela (*q.v.*), in which Richard Olney, the secretary of state, played a somewhat aggressive part. On the 17th of December 1895 President Cleveland sent to Congress a special message calling attention to Great Britain's action in regard to the disputed boundary line between British Guiana and Venezuela, and declaring the necessity of action by the United States to prevent an infringement of the Monroe Doctrine. Congress at once appropriated funds for an American commission to investigate the matter. The diplomatic situation became for the moment very acute, but after a short period of bellicose talk the common-sense of both countries prevailed. Negotiations with Great Britain ensued, and before the American special commission finished its work, Great Britain had agreed, November 1896, to arbitrate on terms which safeguarded the national dignity on both sides.

Cleveland's independence was nowhere more strikingly shown during his second term than in his action in regard to the tariff legislation of his party in Congress. A tariff bill introduced in the House by William Lyne Wilson (1843-1900), of West Virginia, chairman of the Committee of Ways and Means, was so amended in the Senate, through the instrumentality of Senator Arthur Pue Gorman and a coterie of anti-administration democratic senators, that when the bill eventually came before him, although unwilling to veto it, the president signified his dissatisfaction with its too high rates by allowing it to become a law without his signature. Cleveland's second administration began by vigorous action in regard to Hawaii; he at once withdrew from the Senate the annexation treaty which President Harrison had negotiated.

During his second term Cleveland added 44,004 places in the civil service to the classified list, bringing them within the rules of the merit system. This was a greater number than all that had been placed in the list before, and brought the whole number up to 86,932. Toward the end of his second term the president became very much out of accord with his party on the free-silver question, in consequence of which the endorsement of the administration was withheld by the Democratic national convention at Chicago in 1896. In the ensuing campaign the president and his cabinet, with the exception of Hoke Smith (*b.* 1855), secretary of the interior, who resigned, gave their support to Palmer and Buckner, the National, or "Sound Money" Democratic nominees.

Cleveland's second term expired on the 4th of March 1897, and he then retired into private life, universally respected and constantly consulted, in the university town of Princeton, New Jersey, where he died on the 24th of June 1908. He was a trustee of Princeton University and Stafford Little lecturer on public affairs. Chosen in 1905 as a member of a committee of three to act as trustees of the majority of the stock of the Equitable Life Assurance Company, he promoted the reorganization and the mutualization of that company, and acted as rebate referee for it and for the Mutual and New York Life insurance companies. He published *Presidential Problems* (New York, 1904), made up in part of lectures at Princeton University, and *Fishing and Hunting Sketches* (1906).

A large amount of magazine literature has been devoted to President Cleveland's career. W. O. Stoddard's *Grover Cleveland* (1888; "Lives of the Presidents" series) and J. Lowry Whittle's *Grover Cleveland* (1896; "Public Men of To-day" series) are judicious volumes; and "Campaign Biographies" (1884) were written by W. Dorsheimer, F. E. Goodrich, P. King and D. Welch. See articles by Woodrow Wilson (*Atlantic Monthly*, vol. 79; "Cleveland as President"); Carl Schurz (*McClure's Magazine*, vol. ix.; "Second Administration of Grover Cleveland"); William Allen White (*McClure's*, vol. 18, "Character Sketch of Cleveland"), and Henry L. Nelson (*North American Review*, vol. 188). Also Jesse L. Williams, *Mr Cleveland: A Personal Impression* (1909). (H. WH.)

CLEVELAND, a city and port of entry in the state of Ohio, U.S.A., and the county-seat of Cuyahoga county, the sixth largest city in the United States. It is on Lake Erie at the mouth of Cuyahoga river, about 260 m. N.E. of Cincinnati, 357 m. E. of Chicago, and 623 m. W. by N. of New York. Pop. (1890) 261,353; (1900) 381,768, of whom 124,631 were foreign-born, 288,591 were of foreign parentage (*i.e.* having one or both parents foreign-born), and 5988 were negroes; (1910) 560,663. Of the 124,631, who in 1900 were foreign-born, Germans were greatly predominant (40,648, or 32.6%), with the Bohemians (13,599, or 10.9%) and Irish (13,120, or 10.6%) next in importance, the Bohemians being later comers than the Irish.

The city commands pleasant views from its position on a plateau, which, at places on bluffs along the shore, has elevations of about 75 ft. above the water below, and rises gradually toward the S.E. to 115 ft. and on the extreme E. border to more than 200 ft. above the lake, or about 800 ft. above sea-level; the surface has, however, been cut deeply by the Cuyahoga, which here pursues a meandering course through a valley about $\frac{1}{2}$ m. wide, and is also broken by several smaller streams. The city's shore-line is more than 12 m. long. The city varies considerably in width, and occupies a total area of about 41 sq. m., much the greater part of which is E. of the river. The streets are of unusual width (varying from 60 ft. to 132 ft.); are paved chiefly with Medina dressed stone, brick and asphalt; and, like the parks, are so well shaded by maples, elms and other trees, that Cleveland has become known as the "Forest City." The municipality maintains an efficient forestry department. About $\frac{1}{2}$ m. from the lake and the same distance E. of the river is the Public Square, or Monumental Park, in the business centre of the city. Thence the principal thoroughfares radiate. The river is spanned with bridges, and its valley by two viaducts, the larger of which (completed in 1878 at a cost of more than \$2,000,000), 3211 ft. long, 64 ft. wide, and 68 ft. above water, connects Superior Avenue on the E. with Detroit Avenue on the W. The Central Viaduct, finished in 1888, extends from Central Avenue to W. 14th Street, and there connects with a smaller viaduct across Walworth Run, the combined length of the two being about 4000 ft. Another viaduct (about 830 ft. long) crosses Kingsbury Run a short distance above its mouth. Lower Euclid Avenue (the old country road to Euclid, O., and Erie, Pa.) is given up to commercial uses; the eastern part of the avenue has handsome houses with spacious and beautifully ornamented grounds, and is famous as one of the finest residence streets in the country. Sections of Prospect Avenue, E. 40th, E. 93rd, E. 75th, E. 55th, W. 44th and E. 79th streets also have many fine residences. The principal business thoroughfares are Superior Avenue (132 ft. wide), the W. part of Euclid Avenue, and Ontario St. The manufacturing quarters are chiefly in the valley of the Cuyahoga, and along the railway tracks entering the city, chiefly on the E. side. In 1902 the city arranged for grouping its public buildings—in the so-called "Group Plan"—at a cost of \$25,000,000. The court-house and city hall are on the bluff overlooking Lake Erie; 1000 ft. south are the Federal post-office and the public library. The Mall connecting the court-house and city hall with the post-office and library is 600 ft. wide; on one side of it is the grand music-hall, on the other a fine art gallery. The six granite buildings forming this quadrangle were built under the supervision of Arnold Brunner, a government architect, and of John M. Carrere and D. H. Burnham,

who planned the buildings at the Pan-American Exposition and the Chicago World's Fair respectively. The city has, besides, numerous fine office buildings, including that of the Society for Savings (an institution in which each depositor is virtually a stockholder), the Citizens', Rose, Williamson, Rockefeller, New England and Garfield buildings; and several beautiful churches, notably the Roman Catholic and Trinity cathedrals, the First Presbyterian ("Old Stone"), the Second Presbyterian, the First Methodist and Plymouth (Congregational) churches. The Arcade, between Euclid and Superior avenues, and the Colonial Arcade, between Euclid and Prospect avenues, are office and retail store buildings worthy of mention. The former, finished in 1889, is 400 ft. long, 180 ft. wide, and 140 ft. high, with a large interior court, overlooked by five balconies. The Colonial Arcade contains a hotel as well; it was finished in 1898. In the Public Square is a soldiers' and sailors' monument consisting of a granite shaft rising from a memorial room to a height of 125 ft., and surmounted with a figure of Liberty; in the same park, also, is a bronze statue of Moses Cleaveland, the founder of the city. On a commanding site in Lake View Cemetery is the Garfield Memorial (finished in 1890) in the form of a tower (165 ft. high), designed by George Keller and built mostly of Ohio sandstone; in the base is a chapel containing a statue of Garfield and several panels on which are portrayed various scenes in his life; his remains are in the crypt below the statue. A marble statue of Commodore Oliver H. Perry, erected in commemoration of his victory on Lake Erie in 1813, is in Wade Park, where there is also a statue of Harvey Rice (1800-1891), who reformed the Ohio public school system and wrote *Pioneers of the Western Reserve* (1882) and *Sketches of Western Life* (1888).

The parks contain altogether more than 1500 acres. A chain of parks connected by driveways follows the picturesque valley of Doan Brook on the E. border of the city. At the mouth of the brook and on the lake front is the beautiful Gordon Park of 122 acres, formerly the private estate of William J. Gordon but given by him to the city in 1893; from this extends up the Doan Valley the large Rockefeller Park, which was given to the city in 1896 by John D. Rockefeller and others, and which extends to and adjoins Wade Park (85 acres; given by J. H. Wade) in which are a zoological garden and a lake. Lake View Park along the lake shore contains only 10½ acres, but is a much frequented resting-place near the business centre of the city, and affords pleasant views of the lake and its commerce. Monumental Park is divided into four sections (containing about 1 acre each) by Superior Avenue and Ontario Street. Of the several cemeteries, Lake View (about 300 acres), on an elevated site on the E. border, is by far the largest and most beautiful, its natural beauty having been enhanced by the landscape gardener. Besides Garfield, John Hay and Marcus A. Hanna are buried here.

Education.—Cleveland has an excellent public school system. A general state law enacted in 1904 placed the management of school affairs in the hands of an elective council of seven members, five chosen at large and two by districts. This board has power to appoint a school director and a superintendent of instruction. The superintendent appoints the teaching force, the director all other employes; appointments are subject to confirmation by the board, and all employes are subject to removal by the executive officials alone. The "Cleveland plan," in force in the public schools, minimizes school routine, red tape and frequent examinations, puts great stress on domestic and manual training courses, and makes promotion in the grammar schools depend on the general knowledge and development of the pupil, as estimated by a teacher who is supposed to make a careful study of the individual. In 1909 there were 8 high schools and 90 grammar schools in the city; more than \$2,500,000 is annually expended by Cleveland on its public schools. Besides the public school system there are many parochial schools; the University school, with an eight years' course; the Western Reserve University, with its medical school (opened in 1843), the Franklin T. Backus Law School (1892), the dental department (1892), Adelbert College (until 1882 the Western Reserve College, founded in 1826, at Hudson, Ohio), the College for Women (1888), and the

Library school (1904); St Ignatius College (Roman Catholic, conducted by the Fathers of the Society of Jesus; incorporated 1890), which has an excellent meteorological observatory; St Mary's theological seminary (Roman Catholic); the Case School of Applied Science, founded in 1880 by Leonard Case (1820-1880), and opened in 1881; the Cleveland College of Physicians and Surgeons (founded in 1863; from 1869 until 1896 the medical department of the University of Wooster; since 1896 a part of Ohio Wesleyan University, Delaware, Ohio), the Cleveland Homeopathic Medical College, the Cleveland School of Pharmacy, the Cleveland Art School, and a school for the deaf, dumb and blind. In 1907-1908 Western Reserve University had 193 instructors and 914 students (277 in Adelbert College; 269 in College for Women; 20 in graduate department; and 102 in medical, 133 in law, 75 in dental and 51 in Library school); and the Case School of Applied Science 40 instructors and 440 students. The public library contained 330,000 volumes in 1908, the Case library (subscription) 65,000 volumes, the Hatch library of Adelbert College about 56,000 volumes, the library of the Western Reserve Historical Society 22,500 volumes, and the Cleveland law library, in the court house, 20,000 volumes.

The city has a highly developed system of charitable and corrective institutions. A farm of more than 1600 acres, the Cleveland Farm Colony, 11 m. from the city, takes the place of workhouses, and has many cottages in which live those of the city's poor who were formerly classed as paupers and were sent to poorhouses, and who now apply their labour to the farm and are relieved from the stigma that generally attaches to inmates of poorhouses. On the "farm" the city maintains an "infirmary village," a tuberculosis sanatorium, a detention hospital, a convalescent hospital and houses of correction. On a farm 22 m. from the city is the Boyville Home (maintained in connexion with the juvenile court) for "incurable" boys. The "cottage" plan has been adopted; each cottage is presided over by a man and wife whom the boys call father and mother. The boys have a government of their own, elect their officials from among themselves, and inflict such punishment on any of their number as the boys deem merited. Besides the city, there are the Northern Ohio (for the insane, founded in 1855), the Cleveland general, Lake Side (endowed), St Alexis and the Charity hospitals (the last managed by Sisters of Charity). The Goodrich House (1897), the Hiram House and the Alta House are among the best equipped and most efficient social settlements in the country. Cleveland has also its orphan asylums, homes for the aged, homes for incurables, and day nurseries, besides a home for sailors, homes for young working women, and retreats for unfortunate girls. The various charity and benevolent institutions are closely bound together on a co-operative basis by the agency of the associated charities.

The principal newspapers of the city are the *Plain Dealer* (1841, independent), the *Press* (1878, independent), the *Leader* (1847, Republican), and the *News* (1889, Republican). Bohemian, Hungarian and German dailies are published.

Municipal Enterprise.—Municipal ownership has been a greater issue in Cleveland than in any other large city in the United States, chiefly because of the advocacy of Tom Loftin Johnson (born 1854), a street-railway owner, iron manufacturer, an ardent single-taxer, who was elected mayor of the city in 1901, 1903, 1905 and 1907. The municipality owns the water-works, a small electric-light plant, the garbage plant and bath houses. The city water is pumped to reservoirs, through a tunnel 9 ft. in diameter 60 ft. below the bottom of the lake, from an intake situated a distance of 26,500 ft. from the shore. The system has a delivery capacity of 80,000,000 gallons daily. The department serves about 70,000 consumers. All water is metered and sells for 40 cents per thousand cub. ft., or 5 barrels for 1 cent. The municipal electric-lighting plant does not seriously compete with the private lighting company. The municipal garbage plant (destructor) collects and reduces to fertilizer 100 tons of garbage per day. The sale of the fertilizer more than pays for the cost of reduction, and the only expense the city has is in collecting it. In the city's six bath houses the average number of baths per day,

per house, in 1906, was 1165. The municipal street cleaning department cleans all streets by the wet process. To do this the city maintained (1906) 24 flushing wagons working 2 shifts of 8 hours each per day. A new street car company began operations on the 1st of November 1906, charging a 3 cent fare. The grants of this company were owned by the Forest City Railway Company and the property was leased to the Municipal Traction Company (on behalf of the public—the city itself not being empowered to own and operate street railways). In 1908 the Cleveland Electric Street Railway Corporation (capital \$23,000,000), which owned most of the electric lines in the city, was forced to lease its property to the municipality's holding company, receiving a "security franchise," providing that under certain circumstances (e.g. if the holding company should default in its payment of interest) the property was to revert to the corporation, which was then to charge not more than twenty-five cents for six tickets. In October 1908, at a special election, the security franchise was invalidated, and the entire railway system was put in the hands of receivers. In 1909 Johnson was defeated. In 1910 a 25-year franchise was granted to the Cleveland Railway Company, under which a 3-cent fare is required if the company can earn 6% on that basis, and 4 cents (7 tickets for 25 cents) is the maximum fare, with a cent transfer charge, returned when the transfer is used.

Commerce.—To meet the demands of the rapidly increasing commerce the harbour has been steadily improved. In 1908 it consisted of two distinct parts, the outer harbour being the work of the federal government, and the inner harbour being under the control of the city. The outer harbour was formed by two breakwaters enclosing an area of 2 m. long and 1700 ft. wide; the main entrance, 500 ft. wide, lying opposite the mouth of the Cuyahoga river, 1350 ft. distant. The depth of the harbour ranges from 21 to 26 ft.; and by improving this entrance, so as to make it 700 ft. wide, and 1000 ft. farther from the shore, and extending the east breakwater 3 m., the capacity of the outer harbour has been doubled. The inner harbour comprises the Cuyahoga, the old river bed, and connecting slips. The channel at the mouth of the river (325 ft. wide) is lined on the W. side by a concrete jetty 1054 ft. long, and on the E. side by commercial docks. The river and old river bed furnish about 13 m. of safe dock frontage, the channel having been dredged for 6 m. to a depth of 21 ft. The commerce of the harbour of Cleveland in 1907 was 12,872,448 tons.

Cleveland's rapid growth both as a commercial and as a manufacturing city is due largely to its situation between the iron regions of Lake Superior and the coal and oil regions of Pennsylvania and Ohio. Cleveland is a great railway centre and is one of the most important ports on the Great Lakes. The city is served by the Lake Shore & Michigan Southern; the New York, Chicago & St Louis; the Cleveland, Cincinnati, Chicago & St Louis; the Pennsylvania; the Erie; the Baltimore & Ohio; and the Wheeling & Lake Erie railways; by steamboat lines to the principal ports on the Great Lakes; and by an extensive system of inter-urban electric lines. Cleveland is the largest ore market in the world, and its huge ore docks are among its most interesting features; the annual receipts and shipments of coal and iron ore are enormous. It is also the largest market for fresh-water fish in America, and handles large quantities of lumber and grain. The most important manufactures are iron and steel, carriage hardware, electrical supplies, bridges, boilers, engines, car wheels, sewing machines, printing presses, agricultural implements, and various other commodities made wholly or chiefly from iron and steel. Other important manufactures are automobiles (value, 1905, \$4,256,979) and telescopes. More steel wire, wire nails, and bolts and nuts are made here than in any other city in the world (the total value for iron and steel products as classified by the census was, in 1905, \$42,930,995, and the value of foundry and machine-shop products in the same year was \$18,832,487), and more merchant vessels than in any other American city. Cleveland is the headquarters of the largest shoddy mills in the country (value of product, 1905, \$1,084,594), makes much clothing (1905, \$10,426,535), manu-

factures a large portion of the chewing gum made in the United States, and is the site of one of the largest refineries of the Standard Oil Company. The product of Cleveland breweries in 1905 was valued at \$3,986,059, and of slaughtering and meat-packing houses in the same year at \$10,426,535. The total value of factory products in 1905 was \$172,115,101, an increase of 36.4% since 1900; and between 1900 and 1905 Cleveland became the first manufacturing city in the state.

Government.—Since Cleveland became a city in 1836 it has undergone several important changes in government. The charter of that year placed the balance of power in a council composed of three members chosen from each ward and as many aldermen as there were wards, elected on a general ticket. From 1852 to 1891 the city was governed under general laws of the state which entrusted the more important powers to several administrative boards. Then, from 1891 to 1903, by what was practically a new charter, that which is known as the "federal plan" of government was tried; this centred power in the mayor by making him almost the only elective officer, by giving to him the appointment of his cabinet of directors—one for the head of each of the six municipal departments—and to each director the appointment of his subordinates. The federal plan was abandoned in 1903, when a new municipal code went into effect, which was in operation until 1909, when the Paine Law established a board of control, under a government resembling the old federal plan. (For laws of 1903 and 1909 see OHIO.) Few if any cities in the Union have, in recent years, been better governed than Cleveland, and this seems to be due largely to the keen interest in municipal affairs which has been shown by her citizens. Especially has this been manifested by the Cleveland Chamber of Commerce and by the Municipal Association, an organization of influential professional and business men, which, by issuing bulletins concerning candidates at the primaries and at election time, has done much for the betterment of local politics. The Cleveland Chamber of Commerce, an organization of 1600 leading business men, is a power for varied good in the city; besides its constant and aggressive work in promoting the commercial interests of the city, it was largely influential in the federal reform of the consular service; it studied the question of overcrowded tenements and secured the passage of a new tenement law with important sanitary provisions and a set minimum of air space; it urges and promotes home-gardening, public baths and play-grounds, and lunch-rooms, &c., for employes in factories; and it was largely instrumental in devising and carrying out the so-called "Group Plan" described above.

History.—A trading post was established at the mouth of the Cuyahoga river as early as 1786, but the place was not permanently settled until 1796, when it was laid out as a town by Moses Cleaveland (1754-1806), who was then acting as the agent of the Connecticut Land Company, which in the year before had purchased from the state of Connecticut a large portion of the Western Reserve. In 1800 the entire Western Reserve was erected into the county of Trumbull and a township government was given to Cleveland; ten years later Cleveland was made the seat of government of the new county of Cuyahoga, and in 1814 it was incorporated as a village. Cleveland's growth was, however, very slow until the opening of the Ohio canal as far as Akron in 1827; about the same time the improvement of the harbour was begun, and by 1832 the canal was opened to the Ohio river. Cleveland thus was connected with the interior of the state, for whose mineral and agricultural products it became the lake outlet. The discovery of iron ore in the Lake Superior region made Cleveland the natural meeting-point of the iron ore and the coal from the Ohio, Pennsylvania and West Virginia mines; and it is from this that the city's great commercial importance dates. The building of railways during the decade 1850-1860 greatly increased this importance, and the city grew with great rapidity. The growth during the Civil War was partly due to the rapid development of the manufacturing interests of the city, which supplied large quantities of iron products and of clothing to the Federal government.

The population of 1076 in 1830 increased to 6071 in 1840, to 17,034 in 1850, to 43,417 in 1860, to 92,829 in 1870 and to 160,146 in 1880. Until 1853 the city was confined to the E. side of the river, but in that year Ohio City, which was founded in 1807, later incorporated as the village of Brooklyn, and in 1836 chartered as a city (under the name Ohio City), was annexed. Other annexations followed: East Cleveland in 1872, Newburg in 1873, West Cleveland and Brooklyn in 1893, and Glenville and South Brooklyn in 1905. In recent history the most notable events not mentioned elsewhere in this article were the elaborate celebration of the centennial of the city in 1896 and the street railway strike of 1899, in which the workers attempted to force a redress of grievances and a recognition of their union. Mobs attacked the cars, and cars were blown up by dynamite. The strikers were beaten, but certain abuses were corrected. There was a less violent street car strike in 1908, after the assumption of control by the Municipal Traction Company, which refused to raise wages according to promises made (so the employees said) by the former owner of the railway; the strikers were unsuccessful.

AUTHORITIES.—*Manual of the City Council* (1879); *Annals of the Cleveland Chamber of Commerce* (1894-); E. M. Avery, *Cleveland in a Nutshell: An Historical and Descriptive Ready-reference Book* (Cleveland, 1893); James H. Kennedy, *A History of the City of Cleveland* (Cleveland, 1896); C. A. Urann, *Centennial History of Cleveland* (Cleveland 1896); C. Whittlesey, *The Early History of Cleveland* (Cleveland, 1867); C. E. Bolton, *A Few Civic Problems of Greater Cleveland* (Cleveland, 1897); "Plan of School Administration," by S. P. Orth, in vol. xix. *Political Science Quarterly* (New York, 1904); Charles Snively, *A History of the City Government of Cleveland* (Baltimore, 1902); C. C. Williamson, *The Finances of Cleveland* (New York, 1907); "The Government of Cleveland, Ohio," by Lincoln Steffens, in *McClure's Magazine*, vol. xxv. (New York, 1905); and C. F. Thwing, "Cleveland, the Pleasant City," in *Powell's Historic Towns of the Western States* (New York, 1901).

CLEVER, an adjective implying dexterous activity of mind or body, and ability to meet emergencies with readiness and adroitness. The etymology and the early history of the word are obscure. The earliest instance quoted by the *New English Dictionary* is in the *Bestiary* of c. 1200 (*An Old English Miscellany*, ed. R. Morris, 1872, E.E.T.S. 49)—"On the clothed the neddre (adder) is cof (quick) and the devel cliver on sinnes," i.e. quick to seize hold of; this would connect the word with a M. Eng. "cliver" or "clivre," a talon or claw (so H. Wedgwood, *Dict. of Eng. Elym.*). The ultimate original would be the root appearing in "claw," "cleave," "cling," "clip," &c., meaning to "stick to." This original sense probably survives in the frequent use of the word for nimble, dexterous, quick and skilful in the use of the hands, and so it is often applied to a horse, "clever at his fences." The word has also been connected with O. Eng. *gléaw*, wise, which became in M. Eng. *gleu*, and is cognate with Scottish *gleg*, quick of eye. As to the use of the word, Sir Thomas Browne mentions it among "words of no general reception in English but of common use in Norfolk or peculiar to the East Angle countries" (*Tract.* viii. in Wilkins's ed. of *Works*, iv. 205). The earlier uses of the word seem to be confined to that of bodily dexterity. In this sense it took the place of a use of "deliver" as an adjective, meaning nimble, literally "free in action," a use taken from Fr. *delivre* (Late Lat. *delibcrare*, to set free), cf. Chaucer, *Prologue to Cant. Tales*, 84, "wonderly deliver and grete of strength," and *Romaunt of the Rose*, 831, "Deliver, smert and of gret might." It has been suggested that "clever" is a corruption of "deliver" in this sense, but this is not now accepted. The earliest use of the word for mental quickness and ability in the *New English Dictionary* is from Addison in No. 22 of *The Freeholder* (1716).

CLEVES (Ger. *Cleve* or *Kleve*), a town of Germany in the kingdom of Prussia, formerly the capital of the duchy of its own name, 46 m. N.W. of Düsseldorf, 12 m. E. of Nijmegen, on the main Cologne-Amsterdam railway. Pop. (1900) 14,678. The town is neatly built in the Dutch style, lying on three small hills in a fertile district near the frontier of Holland, about 2 m. from the Rhine, with which it is connected by a canal (the Spoykanal). The old castle of Schwanenburg (formerly the residence of the

dukes of Cleves), has a massive tower (Schwanenturm) 180 ft. high. With it is associated the legend of the "Knights of the Swan," immortalized in Wagner's *Lohengrin*. The building has been restored in modern times to serve as a court of justice and a prison. The collegiate church (Stiftskirche) dates from about 1340, and contains a number of fine ducal monuments. Another church is the Annexkirche, formerly a convent of the Minorites; this dates from the middle of the 15th century. The chief manufactures are boots and shoes, tobacco and machinery; there is also some trade in cattle. To the south and west of the city a large district is laid out as a park, where there is a statue to the memory of John Maurice of Nassau-Siegen (1604-1679), who governed Cleves from 1650 to 1679, and in the western part there are mineral wells with a pump room and bathing establishment. Owing to the beautiful woods which surround it and its medicinal waters Cleves has become a favourite summer resort.

The town was the seat of the counts of Cleves as early as the 11th century, but it did not receive municipal rights until 1242. The duchy of Cleves, which lay on both banks of the Rhine and had an area of about 850 sq. m., belonged before the year 1000 to a certain Rutger, whose family became extinct in 1368. It then passed to the counts of La Marck and was made a duchy in 1417, being united with the neighbouring duchies of Jülich and Berg in 1521. The Reformation was introduced here in 1533, but it was not accepted by all the inhabitants. The death without direct heirs of Duke John William in 1609 led to serious complications in which almost all the states of Europe were concerned; however, by the treaty of Xanten in 1614, Cleves passed to the elector of Brandenburg, being afterwards incorporated with the electorate by the great elector, Frederick William. The French held Cleves from 1757 to 1762 and in 1795 the part of the duchy on the left bank of the Rhine was ceded to France; the remaining portion suffered a similar fate in 1805. After the conclusion of peace in 1815 it was restored to Prussia, except some small portions which were given to the kingdom of Holland.

See Char, *Geschichte des Herzogtums Kleve* (Cleves, 1845); Velsen, *Die Stadt Kleve* (Cleves, 1846); R. Scholten, *Die Stadt Kleve* (Cleves, 1879-1881). For ANNE OF CLEVES see that article.

CLEYNARTS (CLENARDUS or CLÉNARD), **NICOLAS** (1495-1542), Belgian grammarian and traveller, was born at Diest, in Brabant, on the 5th of December 1495. Educated at the university of Louvain, he became a professor of Latin, which he taught by a conversational method. He applied himself to the preparation of manuals of Greek and Hebrew grammar, in order to simplify the difficulties of learners. His *Tabulae in grammaticen hebraicam* (1529), *Institutiones in linguam graecam* (1530), and *Meditationes graecanicae* (1531) appeared at Louvain. The *Institutiones* and *Meditationes* passed through a number of editions, and had many commentators. He maintained a principle revived in modern teaching, that the learner should not be puzzled by elaborate rules until he has obtained a working acquaintance with the language. A desire to read the Koran led him to try to establish a connexion between Hebrew and Arabic. These studies resulted in a scheme for proselytism among the Arabs, based on study of the language, which should enable Europeans to combat the errors of Islam by peaceful methods. In prosecution of this object he travelled in 1532 to Spain, and after teaching Greek at Salamanca was summoned to the court of Portugal as tutor to Don Henry, brother of John III. He found another patron in Louis Mendoza, marquis of Mondexas, governor-general of Granada. There with the help of a Moorish slave he gained a knowledge of Arabic. He tried in vain to gain access to the Arabic MSS. in the possession of the Inquisition, and finally, in 1540, set out for Africa to seek information for himself. He reached Fez, then a flourishing seat of Arab learning, but after fifteen months of privation and suffering was obliged to return to Granada, and died in the autumn of 1542. He was buried in the Alhambra palace.

See his Latin letters to his friends in Belgium, *Nicolai Clenardi, Peregrinationum ac de rebus machometicis epistolae elegantissimae* (Louvain, 1550), and a more complete edition, *Nic. Clenardi*

Epistolarum libri duo (Antwerp, 1561), from the house of Plantin; also Victor Chauvin and Alphonse Roersch, "Étude sur la vie et les travaux de Nicolas Clénard" in *Mémoires couronnés* (vol. lx., 1900-1901) of the Royal Academy of Belgium, which contains a vast amount of information on Cleynaerts and an extensive bibliography of his works, and of notices of him by earlier commentators.

CLICHTOVE, JOSSE VAN (d. 1543), Belgian theologian, received his education at Louvain and at Paris under Jacques Lefèvre d'Étaples. He became librarian of the Sorbonne and tutor to the nephews of Jacques d'Amboise, bishop of Clermont and abbot of Cluny. In 1519 he was elected bishop of Tournai, and in 1521 was translated to the see of Chartres. He is best known as a distinguished antagonist of Martin Luther, against whom he wrote a good deal. When Cardinal Duprat convened his Synod of Paris in 1528 to discuss the new religion, Clichtove was summoned and was entrusted with the task of collecting and summarizing the objections to the Lutheran doctrine. This he did in his *Compendium veritatum . . . contra erroneas Lutheranorum assertiones* (Paris, 1529). He died at Chartres on the 22nd of September 1543.

CLICHY, or **CLICHY-LA-GARENNE**, a town of northern France, in the department of Seine, on the right bank of the Seine, immediately north of the fortifications of Paris, of which it is a manufacturing suburb. Pop. (1906) 41,516. Its church was built in the 17th century under the direction of St Vincent de Paul, who had previously been curé of Clichy. Its industries include the manufacture of starch, rubber, oil and grease, glass, chemicals, soap, &c. Clichy, under the name of *Clippiacum*, was a residence of the Merovingian kings.

CLIFF-DWELLINGS, the general archaeological term for the habitations of primitive peoples, formed by utilizing niches or caves in high cliffs, with more or less excavation or with additions in the way of masonry. Two special sorts of cliff-dwelling are distinguished by archaeologists, (1) the cliff-house, which is actually built on levels in the cliff, and (2) the cavate house, which is dug out, by using natural recesses or openings. A great deal of attention has been given to the North American cliff-dwellings, particularly among the canyons of the south-west, in Arizona, New Mexico, Utah and Colorado, some of which are still used by Indians. There has been considerable discussion as to their antiquity, but modern research finds no definite justification for assigning them to a distinct primitive race, or farther back than the ancestors of the modern Pueblo Indians. The area in which they occur coincides with that in which other traces of the Pueblo tribes have been found. The niches which were utilized are often of considerable size, occurring in cliffs of a thousand feet high, and approached by rock steps or log-ladders.

See the article, with illustrations and bibliography, in the *Handbook of American Indians* (Washington, 1907).

CLIFFORD, the name of a famous English family and barony, taken from the village of Clifford in Herefordshire, although the family were mainly associated with the north of England.

Robert de Clifford (c. 1275-1314), a son of Roger de Clifford (d. 1282), inherited the estates of his grandfather, Roger de Clifford, in 1286; then he obtained through his mother part of the extensive land of the Viponts, and thus became one of the most powerful barons of his age. A prominent soldier during the reigns of Edward I. and Edward II., Clifford was summoned to parliament as a baron in 1299, won great renown at the siege of Carlaverock Castle in 1300, and after taking part in the movement against Edward II.'s favourite, Piers Gaveston, was killed at Bannockburn. His son Roger, the 2nd baron (1299-1322), shared in the rebellion of Thomas, earl of Lancaster, and was probably executed at York on the 23rd of March 1322. Robert's grandson Roger, the 5th baron (1333-1389), and the latter's son Thomas, the 6th baron (c. 1363-c. 1391), served the English kings on the Scottish borders and elsewhere. The same is true of Thomas, the 8th baron (1414-1455), who was killed at the first battle of St Albans in May 1455.

Thomas's son John, the 9th baron (c. 1435-1461), was more famous. During the Wars of the Roses he fought for Henry VI., earning by his cruelties the name of the "butcher"; after the

battle of Wakefield in 1460 he murdered Edmund, earl of Rutland, son of Richard, duke of York, exclaiming, according to the chronicler Edward Hall, "By God's blood thy father slew mine; and so will I do thee and all thy kin." Shakespeare refers to this incident in *King Henry VI.*, and also represents Clifford as taking part in the murder of York. It is, however, practically certain that York was slain during the battle, and not afterwards like his son. Clifford was killed at Ferrybridge on the 28th of March 1461, and was afterwards attainted. His young son Henry, the 10th baron (c. 1454-1523), lived disguised as a shepherd for some years, hence he is sometimes called the "shepherd lord." On the accession of Henry VII. the attainder was reversed and he received his father's estates. He spent a large part of his time at Barden in Lancashire, being interested in astronomy and astrology. Occasionally, however, he visited London, and he fought at the battle of Flodden in 1513. This lord, who died on the 23rd of April 1523, is celebrated by Wordsworth in the poems "The white doe of Rylstone" and "Song at the feast of Brougham Castle." Henry, the 11th baron, was created earl of Cumberland in 1525, and from this time until the extinction of the title in 1643 the main line of the Cliffords was associated with the earldom of Cumberland (*q.v.*).

Richard Clifford, bishop of Worcester and London under Henry IV. and Henry V., was probably a member of this family. This prelate, who was very active at the council of Constance, died on the 20th of August 1421.

On the death of George, 3rd earl of Cumberland, in 1605, the barony of Clifford, separated from the earldom, was claimed by his daughter Anne, countess of Dorset, Pembroke and Montgomery; and in 1628 a new barony of Clifford was created in favour of Henry, afterwards 5th and last earl of Cumberland. After Anne's death in 1676 the claim to the older barony passed to her daughter Margaret (d. 1676), wife of John Tufton, 2nd earl of Thanet, and her descendants, whose title was definitely recognized in 1691. After the Tuftons the barony was held with intervening abeyances by the Southwells and the Russells, and to this latter family the present Lord De Clifford belongs.¹

When the last earl of Cumberland died in 1643 the newer barony of Clifford passed to his daughter Elizabeth, wife of Richard Boyle, 2nd earl of Cork, and from the Boyles it passed to the Cavendishes, falling into abeyance on the death of William Cavendish, 6th duke of Devonshire, in 1858.

The barony of Clifford of Lanesborough was held by the Boyles from 1644 to 1753, and the Devonshire branch of the family still holds the barony of Clifford of Chudleigh, which was created in 1672.

See G. E. C(okayne), *Complete Peerage* (1887-1898); and T. D. Whitaker, *History of Craven* (1877).

CLIFFORD, JOHN (1836-), British Nonconformist minister and politician, son of a warp-machinist at Sawley, Derbyshire, was born on the 16th of October 1836. As a boy he worked in a lace factory, where he attracted the notice of the leaders of the Baptist community, who sent him to the academy at Leicester and the Baptist college at Nottingham to be educated for the ministry. In 1858 he was called to Praed Street chapel, Paddington (London), and while officiating there he attended University College and pursued his education by working at the British Museum. He matriculated at London University (1859), and took its B.A. degree (1861), B.Sc. (1862), M.A. (1864), and LL.B. (1866), and in 1883 he was given the honorary degree of D.D. by Bates College, U.S.A., being known therefrom as Dr Clifford. This degree, from an American college of minor academic status, afterwards led to sarcastic allusions, but Dr Clifford had not courted it, and his London University achievements were evidence enough of his intellectual equipment. At Praed Street chapel he gradually obtained a

¹ The original writ of summons (1299) was addressed in Latin, *Roberto domino de Clifford*, i.e. Robert, lord of Clifford, and subsequently the barons styled themselves indifferently Lords Clifford or de Clifford, until in 1777 the 11th lord definitively adopted the latter form. The "De" henceforth became part of the name, having quite lost its earliest significance, and with unconscious tautology the barony is commonly referred to as that of De Clifford.

large following, and in 1877 Westbourne Park chapel was opened for him. As a preacher, writer, propagandist and ardent Liberal politician, he became a power in the Nonconformist body. He was president of the London Baptist Association in 1879, of the Baptist Union in 1888 and 1899, and of the National Council of Evangelical Churches in 1898. His chief prominence in politics, however, dates from 1903 onwards in consequence of his advocacy of "passive resistance" to the Education Act of 1902. Into this movement he threw himself with militant ardour, his own goods being distrainted upon, with those of numerous other Nonconformists, rather than that any contribution should be made by them in taxation for the purpose of an Education Act which in their opinion was calculated to support denominational religious teaching in the schools. The "passive resistance" movement, with Dr Clifford as its chief leader, had a large share in the defeat of the Unionist government in January 1906, and his efforts were then directed to getting a new act passed which should be undenominational in character. The rejection of Mr Birrell's bill in 1906 by the House of Lords was accordingly accompanied by denunciations of that body from Dr Clifford and his followers; but as year by year went by, up to 1909, with nothing but failure on the part of the Liberal ministry to arrive at any solution of the education problem,—failure due now not to the House of Lords but to the inherent difficulties of the subject (see EDUCATION),—it became increasingly clear to the public generally that the easy denunciations of the act of 1902, which had played so large a part in the elections of 1906, were not so simple to carry into practice, and that a compromise in which the denominationalists would have their say would have to be the result. Meanwhile "passive resistance" lost its interest, though Dr Clifford and his followers continued to protest against their treatment.

CLIFFORD, WILLIAM KINGDON (1845–1879), English mathematician and philosopher, was born on the 4th of May 1845 at Exeter, where his father was a prominent citizen. He was educated at a private school in his native town, at King's College, London, and at Trinity College, Cambridge, where he was elected fellow in 1868, after being second wrangler in 1867 and second Smith's prizeman. In 1871 he was appointed professor of mathematics at University College, London, and in 1874 became fellow of the Royal Society. In 1875 he married Lucy, daughter of John Lane of Barbados. In 1876 Clifford, a man of high-strung and athletic, but not robust, physique, began to fall into ill-health, and after two voyages to the South, died during the third of pulmonary consumption at Madeira, on the 3rd of March 1879, leaving his widow with two daughters. Mrs W. K. Clifford soon earned for herself a prominent place in English literary life as a novelist, and later as a dramatist. Her best-known story, *Mrs Keith's Crime* (1885), was followed by several other volumes, the best of which is *Aunt Anne* (1893); and the literary talent in the family was inherited by her daughter Ethel (Mrs Fisher Dilke), a writer of some charming verse.

Owing to his early death, Professor Clifford's abilities and achievements cannot be fairly judged without reference to the opinion formed of him by his contemporaries. He impressed every one as a man of extraordinary acuteness and originality; and these solid gifts were set off to the highest advantage by quickness of thought and speech, a lucid style, wit and poetic fancy, and a social warmth which made him delightful as a friend and companion. His powers as a mathematician were of the highest order. It harmonizes with the concrete visualizing turn of his mind that, to quote Professor Henry Smith, "Clifford was above all and before all a geometer." In this he was an innovator against the excessively analytic tendency of Cambridge mathematicians. In his theory of graphs, or geometrical representations of algebraic functions, there are valuable suggestions which have been worked out by others. He was much interested, too, in universal algebra, non-Euclidean geometry and elliptic functions, his papers "Preliminary Sketch of Bi-quaternions" (1873) and "On the Canonical Form and Dissection of a Riemann's Surface" (1877) ranking as classics. Another important paper

is his "Classification of Loci" (1878). He also published several papers on algebraic forms and projective geometry.

As a philosopher Clifford's name is chiefly associated with two phrases of his coining, "mind-stuff" and the "tribal self." The former symbolizes his metaphysical conception, which was suggested to him by his reading of Spinoza. "Briefly put," says Sir F. Pollock, "the conception is that mind is the one ultimate reality; not mind as we know it in the complex forms of conscious feeling and thought, but the simpler elements out of which thought and feeling are built up. The hypothetical ultimate element of mind, or atom of mind-stuff, precisely corresponds to the hypothetical atom of matter, being the ultimate fact of which the material atom is the phenomenon. Matter and the sensible universe are the relations between particular organisms, that is, mind organized into consciousness, and the rest of the world. This leads to results which would in a loose and popular sense be called materialist. But the theory must, as a metaphysical theory, be reckoned on the idealist side. To speak technically, it is an idealist monism." The other phrase, "tribal self," gives the key to Clifford's ethical view, which explains conscience and the moral law by the development in each individual of a "self," which prescribes the conduct conducive to the welfare of the "tribe." Much of Clifford's contemporary prominence was due to his attitude towards religion. Animated by an intense love of truth and devotion to public duty, he waged war on such ecclesiastical systems as seemed to him to favour obscurantism, and to put the claims of sect above those of human society. The alarm was greater, as theology was still unreconciled with the Darwinian theory; and Clifford was regarded as a dangerous champion of the anti-spiritual tendencies then imputed to modern science.

His works, published wholly or in part since his death, are *Elements of Dynamic* (1879–1887); *Seeing and Thinking*, popular science lectures (1879); *Lectures and Essays*, with an introduction by Sir F. Pollock (1879); *Mathematical Papers*, edited by R. Tucker, with an introduction by Henry J. S. Smith (1882); and *The Common Sense of the Exact Sciences*, completed by Professor Karl Pearson (1885).

CLIFFORD OF CHUDLEIGH, THOMAS CLIFFORD, 1ST BARON (1630–1673), English lord treasurer, a member of the ancient family of Clifford, descended from Walter de Clifford of Clifford Castle in Herefordshire, was the son of Hugh Clifford of Ugbrook near Exeter, and of Mary, daughter of Sir George Chudleigh of Ashton, Devonshire. He was born on the 1st of August 1630, matriculated in 1647 at Exeter College, Oxford, where he showed distinguished ability, supplicated for the B.A. degree in 1650, and entered the Middle Temple in 1648. He represented Totnes in the convention parliament and in that of 1661; and he joined the faction of young men who spoke "confidently and often," and who sought to rise to power by attacking Clarendon. The chancellor, according to Burnet, had repulsed his advances on account of his Romanism, and Clifford accordingly offered his services to Arlington, whose steady supporter he now became.

On the 16th of February 1663 Clifford obtained the reversion of a tellership in the exchequer, and in 1664, on the outbreak of the Dutch war, was appointed commissioner for the care of the sick, wounded and prisoners, with a salary of £1200. He was knighted, and was present with James at the victory off Lowestoft over the Dutch on the 3rd of June 1665, was rewarded with the prize-ship "Patriarch Isaac," and in August, under the earl of Sandwich, took a prominent part in the unsuccessful attempt to capture the Dutch East India fleet in Bergen harbour. In August he was appointed by Arlington's influence ambassador with Henry Coventry to the north of Europe. Subsequently he served again with the fleet, was present with Albemarle at the indecisive fight on the 1st to the 4th of June 1666, and at the victory on the 25th of July. In October 1667 he was one of those selected by the Commons to prepare papers concerning the naval operations. He showed great zeal and energy in naval affairs, and he is described by Pepys as "a very fine gentleman, and much set by at court for his activity in going to sea and stoutness everywhere and stirring up and down." He became the same year controller of the household and a privy councillor,

in 1667 a commissioner for the treasury, and in 1668 treasurer of the household. In the Commons he supported the court, opposing the bill for frequent parliaments in 1668 and the Coventry Act (see COVENTRY, SIR JOHN) in 1670.

Clifford was an ardent Roman Catholic, a supporter of the royal prerogative and of the French alliance. He regarded with favour the plan of seeking French assistance in order to force Romanism and absolute government upon the country, and his complete failure to understand the real political position and the interests of the nation is reflected in the advice he was said to have given to Charles, to accept the pension from Louis, and "be the slave of one man rather than of 500." As one of the Cabal ministry, therefore, he co-operated very zealously with the king in breaking through the Triple Alliance and in effecting the understanding with France. He was the only minister besides Arlington entrusted with the secret treaty of Dover of 1670, signing both this agreement and also the ostensible treaty imparted to all the members of the Cabal, and did his utmost to urge Charles to join France in the attack upon the Dutch, whom he detested as republicans and Protestants. In 1672, during the absence of Arlington and Coventry abroad, Clifford acted as principal secretary of state, and was chiefly responsible for the "stop of the exchequer," and probably also for the attack upon the Dutch Smyrna fleet. He was appointed this year a commissioner to inquire into the settlement of Ireland. On the 22nd of April he was raised to the peerage as Baron Clifford of Chudleigh, and on the 28th of November, by the duke of York's interest, he was made lord treasurer; his conduct to Arlington, whose claims to the office he had pretended to press, was, according to Evelyn, the only act of "real ingratitude" in his career. Arlington, however, quickly discovered a means of securing Clifford's fall. The latter was strongly in favour of Charles's policy of indulgence, and supported the declaration of this year, urging the king to overcome the resistance of parliament by a dissolution. Arlington advocated the contrary policy of concession, and after Charles's withdrawal of the declaration gave his support to the Test Act of 1673. Clifford spoke with great vehemence against the measure, describing it as "monstrum horrendum ingens," but his speech only increased the anti-Roman Catholic feeling in parliament and ensured the passing of the bill. In consequence Clifford, as a Roman Catholic, followed the duke of York into retirement. His resignation caused considerable astonishment, since he had never publicly professed his religion, and in 1671 had even built a new Protestant chapel at his home at Ugbrook. According to Evelyn, however, his conduct was governed by a promise previously given to James. He gave up the treasuryship and his seat in the privy council in June. On the 3rd of July 1673 he received a general pardon from the king. In August he said a last farewell to Evelyn, and in less than a month he died at Ugbrook. In Evelyn's opinion the cause of death was suicide, but his suspicions do not appear to have received any contemporary support. Clifford was one of the worst advisers of Charles II., but a sincere and consistent one. Evelyn declares him "a valiant, uncorrupt gentleman, ambitious, not covetous, generous, passionate, a most constant, sincere friend." He married Elizabeth, daughter of William Martin of Lindridge, Devonshire, by whom he had fifteen children, four sons and seven daughters surviving him. He was succeeded as 2nd baron by Hugh, his fifth, but eldest surviving son, the ancestor of the present Lord Clifford of Chudleigh. (P. C. Y.)

CLIFTON, a suburb and residential district of Bristol, England, adjoining it on the west; 122 m. W. of London by the Great Western railway. The river Avon (*q.v.*) here runs in a gorge, followed closely by a railway on either side, and having several quarries, which have in a measure spoiled the beauty of its hanging woods. At a height of 245 ft. above high water Isambard Brunel's famous suspension bridge bestrides this gorge. It was begun in 1832 and completed in 1864. It has a span of 702 ft., and its total weight is 1500 tons, and it is calculated to bear a burden of 9 tons per sq. in. The long famous hot springs of Clifton, to which, in fact, the town was indebted for its rise, issue from an aperture at the foot of St Vincent's Rock, in the

portion of Clifton known as Hotwells. The water has a temperature of about 76° F. A hydropathic establishment is attached to them. Immediately above the suspension bridge the Clifton Rocks railway ascends from the quays by the river-side to the heights above. The Clifton and Durdham Downs (both on the Gloucestershire side of the river), form the principal pleasure-grounds of Bristol. They lie high above the river, extend for some 5000 acres, and command a beautiful prospect over the city, with its picturesque irregular site and many towers, and over the surrounding well-wooded country.

Three ancient British earthworks bear witness to an early settlement on the spot, and a church was in existence as far back as the time of Henry II., when it was bestowed by William de Clyfton on the abbot of the Austin canons in Bristol; but there are no longer any architectural vestiges of an earlier date than the 18th century. Clifton gives name to a Roman Catholic bishopric. Of the churches the most important are St Andrew's parish church; All Saints, erected in 1863 after the designs of G. E. Street, and remarkable for the width of its nave and the narrowness of its aisles; and the Roman Catholic pro-cathedral church of the Holy Apostles, with a convent and schools attached. Clifton College, a cluster of buildings in Gothic style, was founded in 1862 by a limited liability company, and takes rank among the principal modern English public schools. Down the river from Clifton is Shirehampton, a favourite resort from Bristol.

CLIM (or **CLYM**) **OF THE CLOUGH**, a legendary English archer, a supposed companion of the Robin Hood band. He is commemorated in the ballad *Adam Bell, Clym of the Cloughe and Wyllyam of Cloudeslee*. The three were outlaws who had many adventures of the Robin Hood type. The oldest printed copy of this ballad is dated 1550.

CLIMACTERIC (from the Gr. *κλιμακτήρ*, the rung or step of a *κλίμαξ* or ladder), a critical period in human life; in a medical sense, the period known as the "change of life," marked in women by the menopause. Certain ages, especially those which are multiples of seven or nine, have been superstitiously regarded as particularly critical; thus the sixty-third and the eighty-first year of life have been called the "grand climacteric." The word is also used, generally, of any turning-point in the history of a nation, a career or the like.

CLIMATE AND CLIMATOLOGY. The word *clima* (from Gr. *κλίνειν*, to lean or incline; whence also the English "clime," now a poetical term for this or that region of the earth, regarded as characterized by climate), as used by the Greeks, probably referred originally either to the supposed slope of the earth towards the pole, or to the inclination of the earth's axis. It was an astronomical or a mathematical term, not associated with any idea of physical climate. A change of *clima* then meant a change of latitude. The latter was gradually seen to mean a change in atmospheric conditions as well as in length of day, and *clima* thus came to have its present meaning. "Climate" is the average condition of the atmosphere. "Weather" denotes a single occurrence, or event, in the series of conditions which make up climate. The climate of a place is thus in a sense its average weather. Climatology is the study or science of climates.

Relation of Meteorology and Climatology.—Meteorology and climatology are interdependent. It is impossible to distinguish sharply between them. In a strict sense, meteorology deals with the physics of the atmosphere. It considers the various atmospheric phenomena individually, and seeks to determine their physical causes and relations. Its view is largely theoretical. When meteorology (*q.v.*) is considered in its broadest meaning, climatology is a subdivision of it. Climatology is largely descriptive. It aims at giving a clear picture of the interaction of the various atmospheric phenomena at any place on the earth's surface. Climatology may almost be defined as geographical meteorology. Its main object is to be of practical service to man. Its method of treatment lays most emphasis on the elements which are most important to life. Climate and crops, climate and industry, climate and health, are subjects of vital interest to man.

The Climatic Elements and their Treatment.—Climatology has

to deal with the same groups of atmospheric conditions as those with which meteorology is concerned, viz. temperature (including radiation); moisture (including humidity, precipitation and cloudiness); wind (including storms); pressure; evaporation, and also, but of less importance, the composition and chemical, optical and electrical phenomena of the atmosphere. The characteristics of each of these so-called *climatic elements* are set forth in a standard series of numerical values, based on careful, systematic, and long-continued meteorological records, corrected and compared by well-known methods. Various forms of graphic presentation are employed to emphasize and simplify the numerical results. In Hann's *Handbuch der Klimatologie*, vol. i., will be found a general discussion of the methods of presenting the different climatic elements. The most complete guide in the numerical, mathematical and graphic treatment of meteorological data for climatological purposes is Hugo Meyer's *Anleitung zur Bearbeitung meteorologischer Beobachtungen für die Klimatologie* (Berlin, 1891).

Climate deals first of all with *average* conditions, but a satisfactory presentation of a climate must include more than mere averages. It must take account, also, of regular and irregular daily, monthly and annual changes, and of the departures, mean and extreme, from the average conditions which may occur at the same place in the course of time. The mean minimum and maximum temperatures or rainfalls of a month or a season are important data. Further, a determination of the frequency of occurrence of a given condition, or of certain values of that condition, is important, for periods of a day, month or year, as for example the frequency of winds according to direction or velocity; or of different amounts of cloudiness; or of temperature changes of a certain number of degrees; the number of days with and without rain or snow in any month, or year, or with rain of a certain amount, &c. The probability of occurrence of any condition, as of rain in a certain month; or of a temperature of 32° , for example, is also a useful thing to know.

Solar Climate.—Climate, in so far as it is controlled solely by the amount of solar radiation which any place receives by reason of its latitude, is called *solar climate*. Solar climate alone would prevail if the earth had a homogeneous land surface, and if there were no atmosphere. For under these conditions, without air or ocean currents, the distribution of temperature at any place would depend solely on the amount of energy received from the sun and upon the loss of heat by radiation. And these two factors would have the same value at all points on the same latitude circle.

The relative amounts of insolation received at different latitudes and at different times have been carefully determined. The values all refer to conditions at the upper limit of the earth's atmosphere, i.e. without the effect of absorption by the atmosphere. The accompanying figure (fig. 1), after Davis, shows the distribution of insolation in both hemispheres at different latitudes and at different times in the year. The latitudes are given at the left margin and the time of year at the right margin. The values of insolation are shown by the vertical distance above the plane of the two margins.

At the equator, where the day is always twelve hours long, there are two maxima of insolation at the equinoxes, when the sun is vertical at noon, and two minima at the solstices when the sun is farthest off the equator. The values do not vary much through the year because the sun is never very far from the zenith, and day and night are always equal. As latitude increases, the angle of insolation becomes more oblique and the intensity decreases, but at the same time the length of day rapidly increases during the summer, and towards the pole of the hemisphere which is having its summer the gain in insolation from the latter cause more than compensates for the loss by the former. The double period of insolation above noted for the equator prevails as far as about lat. 12° N. and S.; at lat. 15° the two maxima have united in one, and the same is true of the minima. At the pole there is one maximum at the summer solstice, and no insolation at all while the sun is below the horizon.

On the 21st of June the equator has a day twelve hours long, but the sun does not reach the zenith, and the amount of insolation is therefore less than at the equinox. On the northern tropic, however, the sun is vertical at noon, and the day is more than twelve hours long. Hence the amount of insolation received at this latitude is greater than that received on the equinox at the equator. From the tropic to the pole the sun stands lower and lower at noon, and the value of insolation would steadily decrease with latitude if it were not for the increase in the length of day. Going polewards from the northern tropic on the 21st of June, the value of insolation increases for a time, because, although the sun is lower, the number of hours during which it shines is greater. A maximum value is reached at about lat. $43\frac{1}{2}^{\circ}$ N. The decreasing altitude of the sun then more than compensates for the increasing length of day, and the value of insolation diminishes, a minimum being reached at about lat. 62° . Then the rapidly increasing length of day towards the pole again brings about an increase in the value of insolation, until a maximum is reached at the pole which is greater than the value received at the equator at any time. The length of day is the same on the Arctic circle as at the pole itself, but while the altitude of the sun varies during the day on the former, the altitude at the pole remains $23\frac{1}{2}^{\circ}$ throughout the 24 hours. The result is to

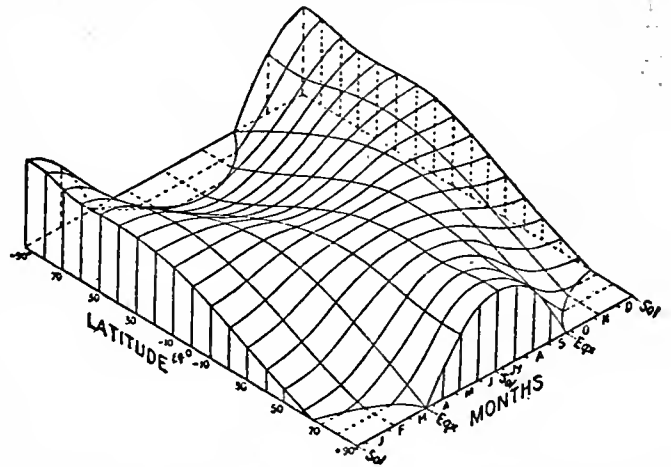

From Davis's *Elementary Meteorology*.

FIG. 1.—Distribution of Insolation over the Earth's Surface.

give the pole a maximum. On the 21st of June there are therefore two maxima of insolation, one at lat. $43\frac{1}{2}^{\circ}$ and one at the north pole. From lat. $43\frac{1}{2}^{\circ}$ N., insolation decreases to zero on the Antarctic circle, for sunshine falls more and more obliquely, and the day becomes shorter and shorter. Beyond lat. $66\frac{1}{2}^{\circ}$ S. the night lasts 24 hours. On the 21st of December the conditions in southern latitudes are similar to those in the northern hemisphere on the 21st of June, but the southern latitudes have higher values of insolation because the earth is then nearer the sun.

At the equinox the days are equal everywhere, but the noon sun is lower and lower with increasing latitude in both hemispheres until the rays are tangent to the earth's surface at the poles (except for the effect of refraction). Therefore, the values of insolation diminish from a maximum at the equator to a minimum at both poles.

The effect of the earth's atmosphere is to weaken the sun's rays. The more nearly vertical the sun, the less the thickness of atmosphere traversed by the rays. The values of insolation at the earth's surface, after passage through the atmosphere, have been calculated. They vary much with the condition of the air as to dust, clouds, water vapour, &c. As a rule, even when the sky is clear, about one-half of the solar radiation is lost during the day by atmospheric absorption. The great weakening of insolation at the pole, where the sun is very low, is especially noticeable. The following table (after Angot) shows the effect of the earth's atmosphere (co-efficient of transmission 0.7) upon the value of insolation received at sea-level.

Values of Daily Insolation at the Upper Limit of the Earth's Atmosphere and at Sea-Level.

Lat.	Upper Limit of Atmosphere.			Earth's Surface.		
	Equator.	40°.	N. Pole.	Equator.	40°.	N. Pole.
Winter solstice	948	360	0	552	124	0
Equinoxes	1000	773	0	612	411	0
Summer solstice	888	1115	1210	517	660	494

The following table gives, according to W. Zenker, the relative thickness of the atmosphere at different altitudes of the sun, and also the amount of transmitted insolation:—

Relative Distances traversed by Solar Rays through the Atmosphere, and Intensities of Radiation per Unit Areas.

Altitude of sun	0°	5°	10°	20°	30°	40°	50°	60°	70°	80°	90°
Relative lengths of path through the atmosphere	44.7	10.8	5.7	2.92	2.00	1.56	1.31	1.15	1.06	1.02	1.00
Intensity of radiation on a surface normal to the rays	0.0	0.15	0.31	0.51	0.62	0.68	0.72	0.75	0.76	0.77	0.78
Intensity of radiation on a horizontal surface	0.0	0.01	0.05	0.17	0.31	0.44	0.55	0.65	0.72	0.76	0.78

Physical Climate.—The distribution of insolation explains many of the large facts of temperature distribution, for example, the decrease of temperature from equator to poles; the double maximum of temperature on and near the equator; the increasing seasonal contrasts with increasing latitude, &c. But the regular distribution of solar climate between equator and poles which would exist on a homogeneous earth, whereby similar conditions prevail along each latitude circle, is very much modified by the unequal distribution of land and water; by differences of altitude; by air and ocean currents, by varying conditions of cloudiness, and so on. Hence the climates met with along the same latitude circle are no longer alike. Solar climate is greatly modified by atmospheric conditions and by the surface features of the earth. The uniform arrangement of solar climatic belts, arranged latitudinally, is interfered with, and what is known as *physical climate* results. According to the dominant control we have solar, continental and marine, and mountain climates. In the first-named, latitude is the essential; in the second and third, the influence of land or water; in the fourth, the effect of altitude.

Classification of the Zones by Latitude Circles.—It is customary to classify climates roughly into certain broad belts. These are the climatic zones. The five zones with which we are most familiar are the so-called torrid, the two temperate, and the two frigid zones. The torrid, or better, the tropical zone, naming it by its boundaries, is limited on the north and south by the two tropics of Cancer and Capricorn, the equator dividing the zone into two equal parts. The temperate zones are limited towards the equator by the tropics, and towards the poles by the Arctic and Antarctic circles. The two polar zones are caps covering both polar regions, and bounded on the side towards the equator by the Arctic and Antarctic circles.

These five zones are classified on purely astronomical grounds. They are really zones of solar climate. The tropical zone has the least annual variation of insolation. It has the maximum annual amount of insolation. Its annual range of temperature is very slight. It is the summer zone. Beyond the tropics the contrasts between the seasons rapidly become more marked. The polar zones have the greatest variation in insolation between summer and winter. They also have the minimum amount of insolation for the whole year. They may well be called the winter zones, for their summer is so short and cool that the heat is insufficient for most forms of vegetation, especially for trees. The temperate zones are intermediate between the tropical and the polar in the matter of annual amount and of annual variation of insolation. Temperate conditions do not characterize these zones as a whole. They are rather the seasonal belts of the world.

Temperature Zones.—The classification of the zones on the basis of the distribution of sunshine serves very well for purposes of simple description, but a glance at any isothermal chart shows that the isotherms do not coincide with the latitude lines. In

fact, in the higher latitudes, the former sometimes follow the meridians more closely than they do the parallels of latitude. Hence it has been suggested that the zones be limited by isotherms rather than by parallels of latitude, and that a closer approach be thus made to the actual conditions of climate. Supan¹ (see fig. 2) has suggested limiting the hot belt, which corresponds to, but is slightly greater than, the old torrid zone, by the two mean annual isotherms of 68°—a temperature which approximately coincides with the polar limit of the trade-winds and with the polar limit of palms. The hot belt widens somewhat over the

continents, chiefly because of the mobility of the ocean waters, whereby there is a tendency towards an equalization of the temperature between equator and poles in the oceans, while the stable lands acquire a temperature suitable to their own latitude. Furthermore, the unsymmetrical distribution of land in the low latitudes of the northern and southern hemispheres results in an unsymmetrical position of the hot belt with reference to the equator, the belt extending farther north than south of the equator. The polar limits of the temperate zones are fixed by the isotherm of 50° for the warmest month. Summer heat is more important for vegetation than winter cold, and where the warmest month has a temperature below 50°, cereals and forest trees do not grow, and man has to adjust himself to the peculiar climatic conditions in a very special way. The two polar caps are not symmetrical as

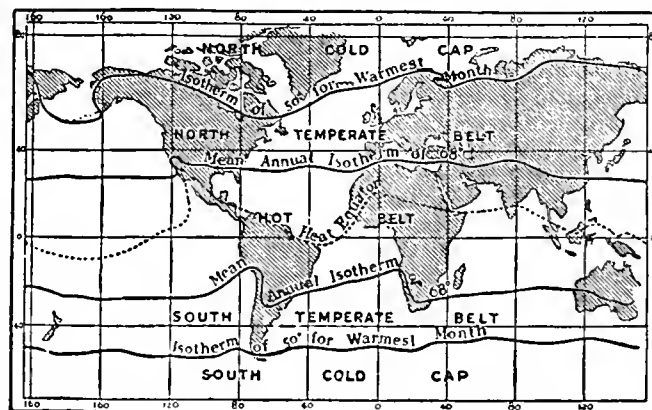

From *Grundzüge der physischen Erdkunde*, by permission of Veit & Co. FIG. 2.—Supan's Temperature Zones.

regards the latitudes which they occupy. The presence of extended land masses in the high northern latitudes carries the temperature of 50° in the warmest month farther poleward there than is the case in the corresponding latitudes occupied by the oceans of the southern hemisphere, which warm less easily and are constantly in motion. Hence the southern cold cap, which has its equatorial limits at about lat. 50° S., is of much greater extent than the northern polar cap. The northern temperate belt, in which the great land areas lie, is much broader than the southern, especially over the continents. These temperature zones emphasize the natural conditions of climate more than is the case in any subdivision by latitude circles, and they bear a fairly close resemblance to the old zonal classification of the Greeks.

Classification of the Zones by Wind Belts.—The heat zones however, emphasize the temperature to the exclusion of such

¹ A. Supan, *Grundzüge der physischen Erdkunde* (Leipzig, 1896), 88-89. Also *Atlas of Meteorology*, Pl. 1.

important elements as wind and rainfall. So distinctive are the larger climatic features of the great wind belts of the world, that a classification of climates according to wind systems has been suggested.¹ As the rain-belts of the world are closely associated with these wind systems, a classification of the zones by winds also emphasizes the conditions of rainfall. In such a scheme the tropical zone is bounded on the north and south by the margins of the trade-wind belts, and is therefore larger than the classic torrid zone. This trade-wind zone is somewhat wider on the eastern side of the oceans, and properly includes within its limits the equable marine climates of the eastern margins of the ocean basins, even as far north as latitude 30° or 35°. Most of the eastern coasts of China and of the United States are thus left in the more rigorous and more variable conditions of the north temperate zone. Through the middle of the trade-wind zone extends the sub-equatorial belt, with its migrating calms, rains and monsoons. On the polar margins of the trade-wind zone lie the sub-tropical belts, of alternating trades and westerlies. The temperate zones embrace the latitudes of the stormy westerly winds, having on their equatorward margins the subtropical belts, and being somewhat narrower than the classic temperate zones. Towards the poles there is no obvious limit to the temperate zones, for the prevailing westerlies extend beyond the polar circles. These circles may, however, serve fairly well as boundaries, because of their importance from the point of view of insolation. The polar zones in the wind classification, therefore, remain just as in the older scheme.

Need of a Classification of Climates.—A broad division of the earth's surface into zones is necessary as a first step in any systematic study of climate, but it is not satisfactory when a more detailed discussion is undertaken. The reaction of the physical features of the earth's surface upon the atmosphere complicates the climatic conditions found in each of the zones, and makes further subdivision desirable. The usual method is to separate the *continental* (near sea-level) and the *marine*. An extreme variety of the continental is the *desert*; a modified form, the *littoral*; while altitude is so important a control that *mountain* and *plateau* climates are always grouped by themselves.

Marine or Oceanic Climate.—Land and water differ greatly in their behaviour regarding absorption and radiation. The former warms and cools readily, and to a considerable degree; the latter, slowly and but little. The slow changes in temperature of the ocean waters involve a retardation in the times of occurrence of the maxima and minima, and a marine climate, therefore, has a cool spring and a warm autumn, the seasonal changes being but slight. Characteristic, also, of marine climates is a prevailing higher relative humidity, a larger amount of cloudiness, and a heavier rainfall than is found over continental interiors. All of these features have their explanation in the abundant evaporation from the ocean surfaces. In the middle latitudes the oceans have distinctly rainy winters, while over the continental interiors the colder months have a minimum of precipitation. Ocean air is cleaner and purer than land air, and is generally in more active motion.

Continental Climate.—Continental climate is severe. The annual temperature ranges increase, as a whole, with increasing distance from the oceans. The coldest and warmest months are usually January and July, the times of maximum and minimum temperatures being less retarded than in the case of marine climates. The greater seasonal contrasts in temperature over the continents than over the oceans are furthered by the less cloudiness over the former. Diurnal and annual changes of nearly all the elements of climate are greater over continents than over oceans; and this holds true of irregular as well as of regular variations. Fig. 3 illustrates the annual march of temperature in marine and continental climates. Bagdad, in Asia Minor (Bd.), and Funchal on the island of Madeira (M.) are representative continental and marine stations for a low latitude. Nerchinsk in eastern Siberia (N.) and Valentia in south-western Ireland (V.) are good examples of continental

and marine climates of higher latitudes in the northern hemisphere. The data for these and the following curves were taken from Hann's *Lehrbuch der Meteorologie* (1901).

Owing to the distance from the chief source of supply of water vapour—the oceans—the air over the larger land areas is naturally drier and dustier than that over the oceans. Yet even in the arid continental interiors in summer the absolute vapour content is surprisingly large, and in the hottest months the percentages of relative humidity may reach 20% or 30%. At the low temperatures which prevail in the winter of the higher latitudes the absolute humidity is very low, but, owing to the cold, the air is often damp. Cloudiness, as a rule, decreases inland, and with this lower relative humidity, more abundant sunshine and higher temperature, the evaporating power of a continental climate is much greater than that of the more humid, cloudier and cooler marine climate.

Both amount and frequency of rainfall, as a rule, decrease inland, but the conditions are very largely controlled by local topography and by the prevailing winds. Winds average somewhat lower in velocity, and calms are more frequent, over continents than over oceans. The seasonal changes of pressure over the former give rise to systems of inflowing and outflowing, so-called continental, winds, sometimes so well developed as to become true monsoons. The extreme temperature changes which occur over the continents are the more easily borne because of the dryness of the air; because the minimum temperatures of winter occur when there is little or no wind, and because during the warmer hours of the summer there is the most air-movement.

Desert Climate.—An extreme type of continental climate is found in deserts. Desert air is notably free from micro-organisms. The large diurnal temperature ranges of inland regions, which are most marked where there is little or no vegetation, give rise to active convectional currents during the warmer hours of the day. Hence high winds are common by day, while the nights are apt to be calm and relatively cool. Travelling by day is unpleasant under such conditions. Diurnal cumulus clouds, often absent because of the excessive dryness of the air, are replaced by clouds of blowing dust and sand. Many geological phenomena, and special physiographic types of varied kinds, are associated with the peculiar conditions of desert climate. The excessive diurnal ranges of temperature cause rocks to split and break up. Wind-driven sand erodes and polishes the rocks. When the separate fragments become small enough they, in their turn, are transported by the winds and further eroded by friction during their journey. Curious conditions of drainage result from the deficiency in rainfall. Rivers "wither" away, or end in sinks or brackish lakes.

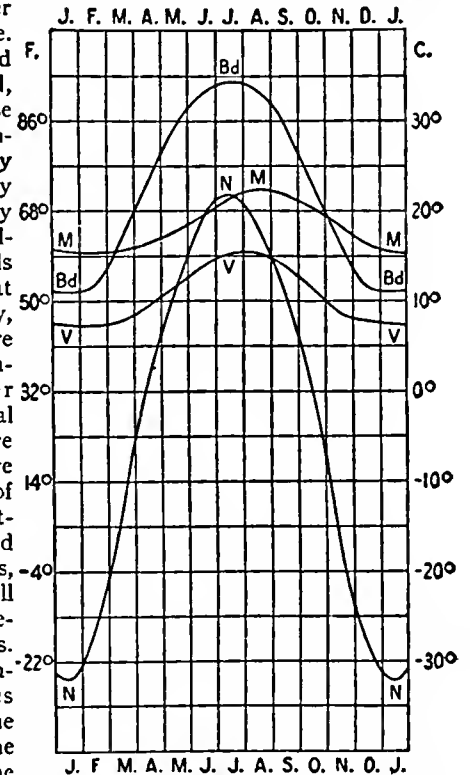
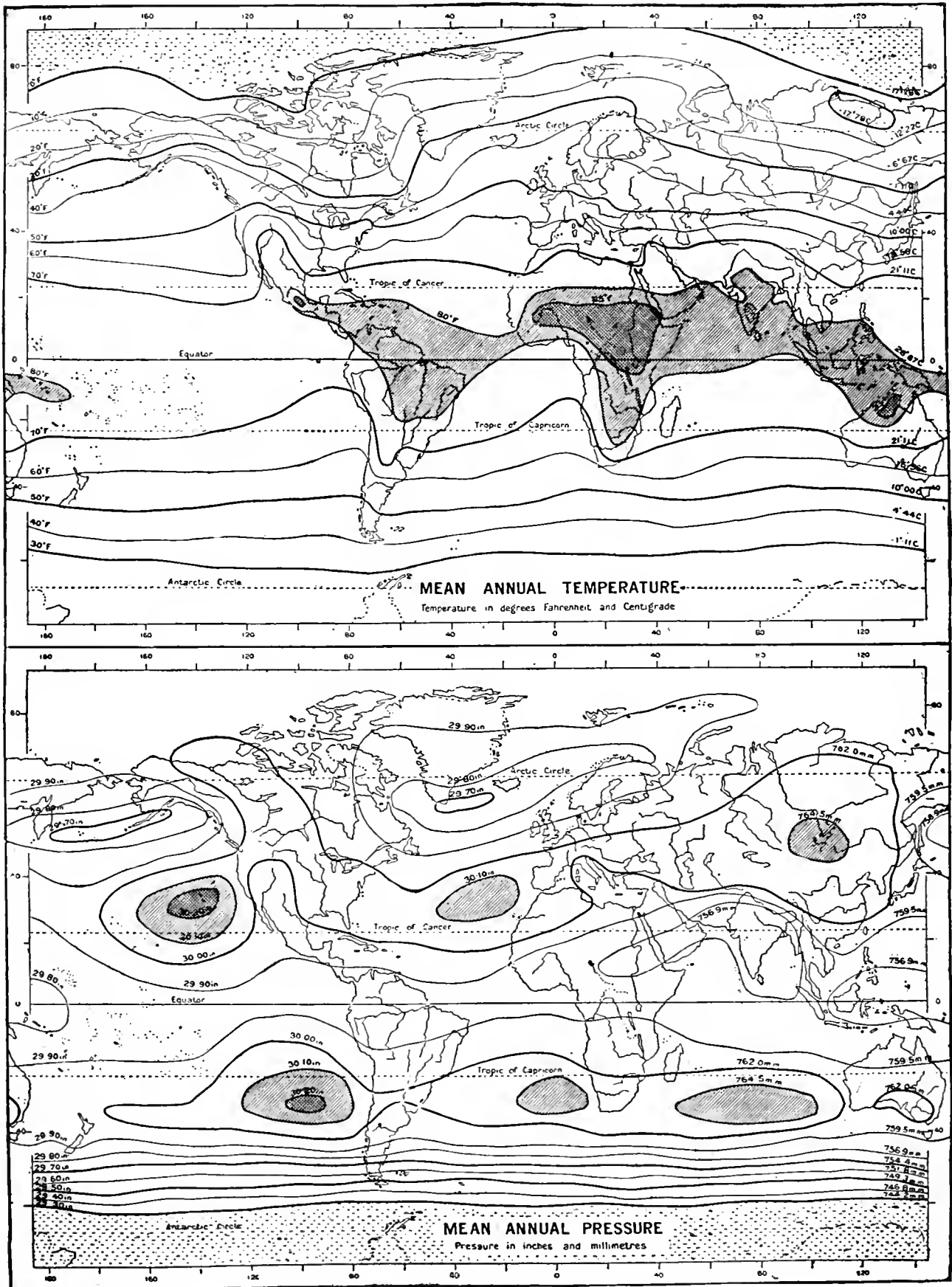
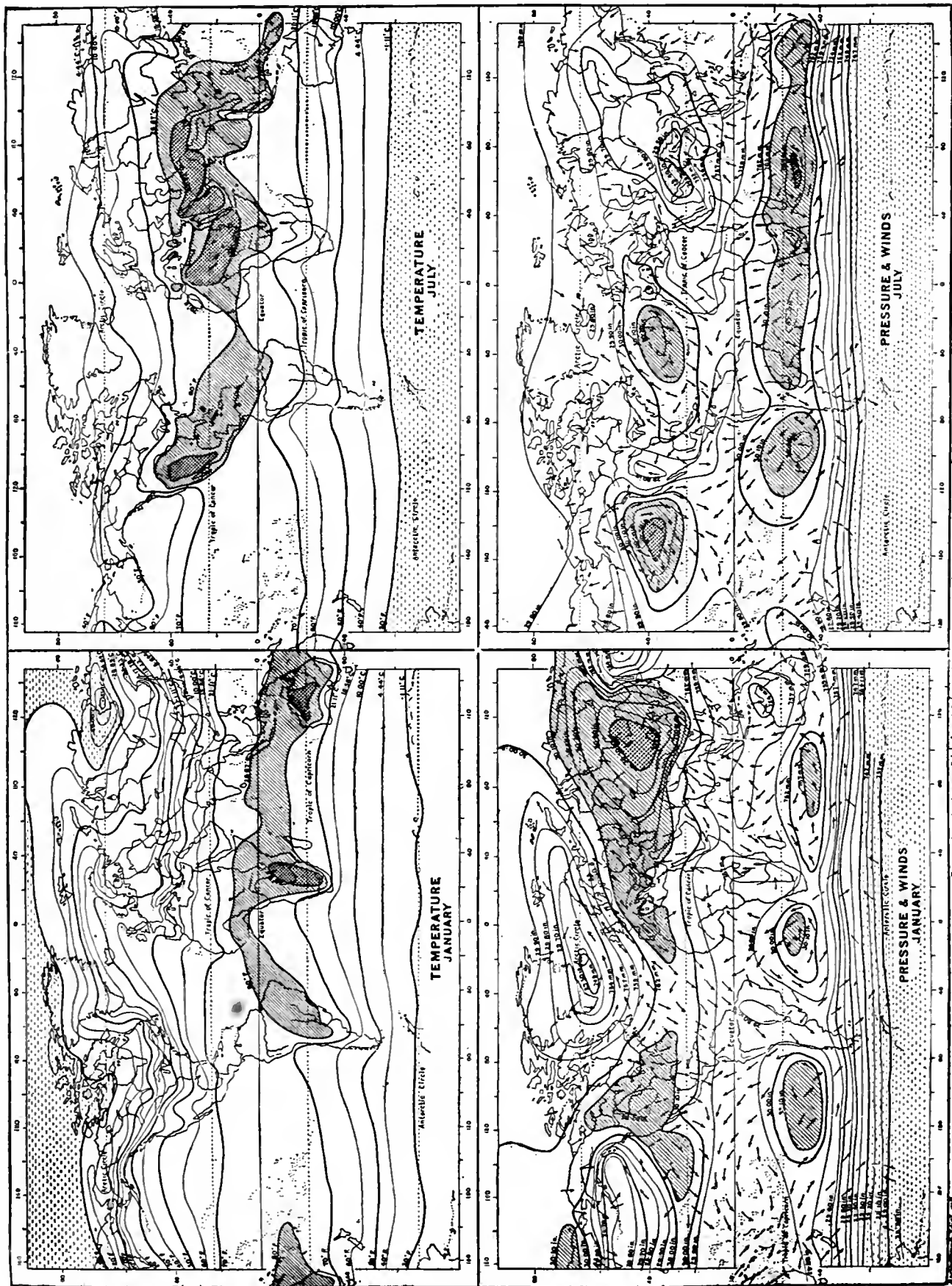

FIG. 3.—Annual March of Air Temperature. Influence of Land and Water. (After Angot.)
M, Madeira. V, Valentia.
Bd, Bagdad. N, Nerchinsk.

¹ W.M. Davis, *Elementary Meteorology* (Boston, 1894), pp. 334-335.



Annual Distribution of Temperature and Pressure.



Temperature in degrees Fahrenheit & Centigrade Pressure in inches & millimetres

Seasonal Distribution of Temperature and Pressure.

Desert plants protect themselves against the attacks of animals by means of thorns, and against evaporation by means of hard surfaces and by a diminished leaf surface. The life of man in the desert is likewise strikingly controlled by the climatic peculiarities of strong sunshine, of heat, and of dust.

Coast or Littoral Climate.—Between the pure marine and the pure continental types the coasts furnish almost every grade of transition. Prevailing winds are here important controls. When these blow from the ocean, the climates are marine in character, but when they are off-shore, a somewhat modified type of continental climate prevails, even up to the immediate sea-coast. Hence the former have a smaller range of temperature; their summers are more moderate and their winters milder; extreme temperatures are rare; the air is damp, and there is much cloud. All these marine features diminish with increasing distance from the ocean, especially when there are mountain ranges near the coast. In the tropics, windward coasts are usually well supplied with rainfall, and the temperatures are modified by sea breezes. Leeward coasts in the trade-wind belts offer special conditions. Here the deserts often reach the sea, as on the western coasts of South America, Africa and Australia. Cold ocean currents, with prevailing winds along-shore rather than on-shore, are here hostile to rainfall, although the lower air is often damp, and fog and cloud are not uncommon.

Monsoon Climate.—Exceptions to the general rule of rainier eastern coasts in trade-wind latitudes are found in the monsoon regions, as in India, for example, where the western coast of the peninsula is abundantly watered by the wet south-west monsoon. As monsoons often sweep over large districts, not only coast but interior, a separate group of monsoon climates is desirable. In India there are really three seasons—one cold, during the winter monsoon; one hot, in the transition season; and one wet, during the summer monsoon. Little precipitation occurs in winter, and that chiefly in the northern provinces. In low latitudes, monsoon and non-monsoon climates differ but little, for summer monsoons and regular trade-winds may both give rains, and wind direction has slight effect upon temperature.

The winter monsoon is off-shore and the summer monsoon on-shore under typical conditions, as in India. But exceptional cases are found where the opposite is true. In higher latitudes the seasonal changes of the winds, although not truly monsoonal, involve differences in temperature and in other climatic elements. The only well-developed monsoons on the coast of the continents of higher latitudes are those of eastern Asia. These are off-shore during the winter, giving dry, clear and cold weather; while the on-shore movement in summer gives cool, damp and cloudy weather.

Mountain and Plateau Climate.—Both by reason of their actual height and because of their obstructive effects, mountains influence climate similarly in all the zones. Mountains as contrasted with lowlands are characterized by a decrease in pressure, temperature and absolute humidity; an increased intensity of insolation and radiation; usually a greater frequency of, and up to a certain altitude more, precipitation. At an altitude of 16,000 ft., more or less, pressure is reduced to about one-half of its sea-level value. The highest human habitations are found under these conditions. On high mountains and plateaus the pressure is lower in winter than in summer, owing to the fact that the atmosphere is compressed to lower levels in the winter and is expanded upwards in summer.

The intensity of insolation and of radiation both increase aloft in the cleaner, purer, drier and thinner air of mountain climates. The great intensity of the sun's rays attracts the attention of mountain-climbers at great altitudes. The vertical decrease of temperature, which is also much affected by local conditions, is especially rapid during the warmer months and hours; mountains are then cooler than lowlands. The inversions of temperature characteristic of the colder months, and of the night, give mountains the advantage of a higher temperature than—a fact of importance in connexion with the use of mountains as winter resorts. At such times the cold air flows down the mountain sides and collects in the valleys below, being replaced

by warmer air aloft. Hence diurnal and annual ranges of temperature on the mountain tops of middle and higher latitudes are lessened, and the climate in this respect resembles a marine condition. The times of occurrence of the maximum and minimum temperature are also much influenced by local conditions. Elevated enclosed valleys, with strong sunshine, often resemble continental conditions of large temperature range, and plateaus, as compared with mountains at the same altitude, have relatively higher temperatures and larger temperature ranges. Altitude tempers the heat of the low latitudes. High mountain peaks, even on the equator, can remain snow-covered all the year round.

No general law governs the variations of relative humidity with altitude, but on the mountains of Europe the winter is the driest season, and the summer the dampest. At well-exposed stations there is a rapid increase in the vapour content soon after noon, especially in summer. The same is true of cloudiness, which is often greater on mountains than at lower levels, and is usually at a maximum in summer, while the opposite is true of the lowlands in the temperate latitudes. One of the great advantages of the higher Alpine valleys in winter is their small amount of cloud. This, combined with their low wind velocity and strong insolation, makes them desirable winter health resorts. Latitude, altitude, topography and winds are the determining factors in controlling the cloudiness on mountains. In the rare, often dry, air of mountains and plateaus evaporation is rapid, the skin dries and cracks, and thirst is increased.

Rainfall usually increases with increasing altitude up to a certain point, beyond which, owing to the loss of water vapour, this increase stops. The zone of maximum rainfall averages about 6000 to 7000 ft. in altitude, more or less, in intermediate latitudes, being lower in winter and higher in summer. Mountains usually have a rainy and a drier side; the contrast between the two is greatest when a prevailing damp wind crosses the mountain, or when one slope faces seaward and the other landward. Mountains often provoke rainfall, and local "islands," or better, "lakes," of heavier precipitation result.

Mountains resemble marine climates in having higher wind velocities than continental lowlands. Mountain summits have a nocturnal maximum of wind velocity, while plateaus usually have a diurnal maximum. Mountains both modify the general, and give rise to local winds. Among the latter the well-known mountain and valley winds are often of considerable hygienic importance in their control of the diurnal period of humidity, cloudiness and rainfall, the ascending wind of daytime tending to give clouds and rain aloft, while the opposite conditions prevail at night.

Supan's Climatic Provinces.—The broad classification of climates into the three general groups of marine, continental and mountain, with the subordinate divisions of desert, littoral and monsoon, is convenient for purposes of summarizing the interaction of the climatic elements under the controls of land, water and altitude. But in any detailed study some scheme of classification is needed in which similar climates in different parts of the world are grouped together, and in which their geographic distribution receives particular consideration. An almost infinite number of classifications might be proposed; or we may take as the basis of subdivision either the special conditions of one climatic element, or similar conditions of a combination of two or more elements. Or we may take a botanical or a zoological basis. Of the various classifications which have been suggested, that of Supan gives a very rational, simple and satisfactory scheme of grouping. In this scheme there are thirty-five so-called climatic provinces.¹ It emphasizes the essentials of each climate, and serves to impress these essentials upon the mind by means of a compact, well-considered verbal summary in the case of each province described. Obviously, no classification of climates which is at all complete can approach the simplicity of the ordinary classification of the zones.

¹ A. Supan, *Grundzüge der physischen Erdkunde* (3rd ed., Leipzig, 1903), pp. 211-214. Also *Atlas of Meteorology*, Pl. 1.

The Characteristics of the Torrid Zone.

General: Climate and Weather.—The dominant characteristic of the torrid zone is the simplicity and uniformity of its climatic features. The tropics lack the proverbial uncertainty and changeableness of the weather of higher latitudes. Weather and climate are essentially synonymous terms. Periodic phenomena, depending upon the daily and annual march of the sun, are dominant. Non-periodic weather changes are wholly subordinate. In special regions only, and at special seasons, is the regular sequence of weather temporarily interrupted by an occasional tropical cyclone. These cyclones, although comparatively infrequent, are notable features of the climate of the areas in which they occur, generally bringing very heavy rains. The devastation produced by one of these storms often affects the economic condition of the people in the district of its occurrence for many years.

Temperature.—The mean temperature is high, and very uniform over the whole zone. There is little variation during the year. The mean annual isotherm of 68° is a rational limit at the polar margins of the zone, and the mean annual isotherm of 80° encloses the greater portion of the land areas, as well as much of the tropical oceans. The warmest latitude circle for the year is not the equator, but latitude 10° N. The highest mean annual temperatures, shown by the isotherm of 85°, are in Central Africa, in India, the north of Australia and Central America, but, with the exception of the first, these areas are small. The temperatures average highest where there is little rain. In June, July and August there are large districts in the south of Asia and north of Africa with temperatures over 90°.

Over nearly all of the zone the mean annual range of temperature is less than 10°, and over much of it, especially on the oceans, it is less than 5°. Even near the margins of the zone the ranges are less than 25°, as at Calcutta, Hong-Kong, Rio de Janeiro and Khartum. The mean daily range is usually larger than the mean annual. It has been well said that "night is the winter of the tropics." Over an area covering parts of the Pacific and Indian Oceans from Arabia to the Caroline Islands and from Zanzibar to New Guinea, as well as on the Guiana coast, the minimum temperatures do not normally fall below 68°. Towards the margins of the zone, however, the minima on the continents fall to or even below 32°. Maxima of 115° and even over 120° occur over the deserts of northern Africa. A district where the mean maxima exceed 113° extends from the western Sahara to north-western India, and over Central Australia. Near the equator the maxima are therefore not as high as those in many so-called "temperate" climates. The tropical oceans show remarkably small variations in temperature. The "Challenger" results on the equator showed a daily range of hardly 0.7° in the surface water temperature, and P. G. Schott determined the annual range as 4.1° on the equator, 4.3° at latitude 10°, and 6.5° at latitude 20°.

The Seasons.—In a true tropical climate the seasons are not classified according to temperature, but depend on rainfall and the prevailing winds. The life of animals and plants in the tropics, and of man himself, is regulated very largely, in some cases almost wholly, by rainfall. Although the tropical rainy season is characteristically associated with a vertical sun, that season is not necessarily the hottest time of the year. It often goes by the name of winter for this reason. Towards the margins of the zone, with increasing annual ranges of temperature, seasons in the extra-tropical sense gradually appear.

Physiological Effects of Heat and Humidity.—Tropical heat is associated with high relative humidity except over deserts and in dry seasons. The air is therefore muggy and oppressive. The high temperatures are disagreeable and hard to bear. The "hot-house air" has an enervating effect. Energetic physical and mental action are often difficult or even impossible. The tonic effect of a cold winter is lacking. The most humid districts in the tropics are the least desirable for persons from higher latitudes; the driest are the healthiest. The most energetic natives are the desert-dwellers. The monotonously enervating

heat of the humid tropics makes man sensitive to slight temperature changes. The intensity of direct insolation, as well as of radiation from the earth's surface, may produce heat prostration and sunstroke. "Beware of the sun" is a good rule in the tropics.

Pressure.—The uniform temperature distribution in the tropics involves uniform pressure distribution. Pressure gradients are weak. The annual fluctuations are slight, even on the continents. The diurnal variation of the barometer is so regular and so marked that, as von Humboldt said, the time of day can be told within about twenty minutes if the reading of the barometer be known.

Winds and Rainfall.—Along the barometric equator, where the pressure gradients are weakest, is the equatorial belt of calms, variable winds and rains—the doldrums. This belt offers exceptionally favourable conditions for abundant rainfall, and is one of the rainiest regions of the world, averaging probably about 100 in. Here the sky is prevailingly cloudy; the air is hot and oppressive; heavy showers and thunderstorms are frequent, chiefly in the afternoon and evening. Here are the dense tropical forests of the Amazon and of equatorial Africa. This belt of calms and rains shifts north and south of the equator after the sun. In striking contrast are the easterly trade winds, blowing between the tropical high pressure belts and the equatorial belt of low pressure. Of great regularity, and contributing largely to the uniformity of tropical climates, the trades have long been favourite sailing routes because of the steadiness of the wind, the infrequency of storms, the brightness of the skies and the freshness of the air. The trades are subject to many variations. Their northern and southern margins shift north and south after the sun; at certain seasons they are interrupted, often over wide areas near their equatorward margins, by the migrating belt of equatorial rains and by monsoons; near lands they are often interfered with by land and sea breezes; in certain regions they are invaded by violent cyclonic storms. The trades, except where they blow on to windward coasts or over mountains, are drying winds. They cause the deserts of northern Africa and of the adjacent portions of Asia; of Australia, South Africa and southern South America. The monsoons on the southern and eastern coasts of Asia are the best known winds of their class. In the northern summer the south-west monsoon, warm and sultry, blows over the latitudes from about 10° N. to and beyond the northern tropic, between Africa and the Philippines, giving rains over India, the East Indian archipelago and the eastern coasts of China. In winter, the north-east monsoon, the normal cold-season outflow from Asia combined with the north-east trade, and generally cool and dry, covers the same district, extending as far north as latitude 30°. Crossing the equator, these winds reach northern Australia and the western islands of the South Pacific as a north-west rainy monsoon, while this region in the opposite season has the normal south-east trade. Other monsoons are found in the Gulf of Guinea and in equatorial Africa. Wherever they occur, they control the seasonal changes.

Tropical rains are in the main summer rains, coming when the normal trade gives way to the equatorial belt of rains, or when the summer monsoon sets in. There are, however, many cases of a rainy season when the sun is low, especially on windward coasts in the trades. Tropical rains come usually in the form of heavy downpours and with a well-marked diurnal period, the maximum varying with the locality between noon and midnight. Local influences are, however, very important, and in many places night rainfall maxima are found.

Land and Sea Breezes.—The sea breeze is an important climatic feature on many tropical coasts. With its regular occurrence, and its cool, clean air, it serves to make many districts habitable for white settlers, and has deservedly won the name of "the doctor." On not a few coasts, the sea breeze is a true prevailing wind. The location of dwellings is often determined by the exposure of a site to the sea breeze.

Thunderstorms.—Local thunderstorms are frequent in the humid portions of the tropics. They have a marked diurnal periodicity, find their best opportunity in the equatorial belt

of weak pressure gradients and high temperature, and are commonly associated with the rainy season, being most common at the beginning and end of the regular rains. In many places, thunderstorms occur daily throughout their season, with extraordinary regularity and great intensity.

Cloudiness.—Taken as a whole, the tropics are not favoured with such clear skies as is often supposed. Cloudiness varies about as does the rainfall. The maximum is in the equatorial belt of calms and rains, where the sky is always more or less cloudy. The minimum is in the trade latitudes, where fair skies as a whole prevail. The equatorial cloud belt moves north and south after the sun. Wholly clear days are very rare in the tropics generally, especially near the equator, and during the rainy season heavy clouds usually cover the sky. Wholly overcast, dull days, such as are common in the winter of the temperate zone, occur frequently only on tropical coasts in the vicinity of cold ocean currents, as on the coast of Peru and on parts of the west coast of Africa.

Intensity of Sky-Light and Twilight.—The light from tropical skies by day is trying, and the intense insolation, together with the reflection from the ground, increases the general dazzling glare under a tropical sun. During much of the time smoke from forest and prairie fires (in the dry season), dust (in deserts), and water-vapour give the sky a pale whitish appearance. In the heart of the trade-wind belts at sea the sky is of a deeper blue. Twilight within the tropics is shorter than in higher latitudes, but the coming on of night is less sudden than is generally assumed.

Climatic Subdivisions.—The rational basis for a classification of the larger climatic provinces of the torrid zone is found in the general wind systems, and in their control over rainfall. Following this scheme there are: (1) the equatorial belt; (2) the trade-wind belts; (3) the monsoon belts. In each of these subdivisions there are modifications due to marine and continental influences. In general, both seasonal and diurnal phenomena are more marked in continental interiors than on the oceans, islands and windward coasts. Further, the effect of altitude is so important that another group should be added to include (4) mountain climates.

1. **The Equatorial Belt.**—Within a few degrees of the equator, and when not interfered with by other controls, the annual curve

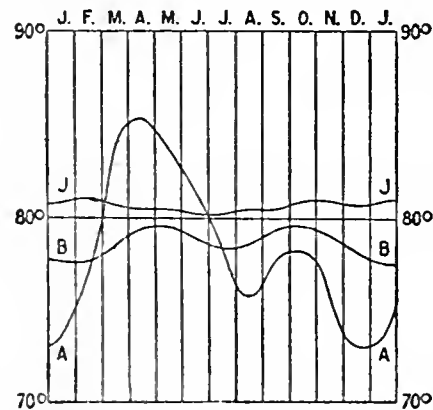

FIG. 4.—Annual march of temperature: equatorial type. A, Africa, interior; B, Batavia; J, Jaluit, Marshall Islands.

of temperature has two maxima following the two zenithal positions of the sun, and two minima at about the time of the solstices. This equatorial type of annual march of temperature is illustrated in the three curves for the interior of Africa, Batavia and Jaluit (fig. 4). The greatest range is shown in the curve for the interior of Africa; the curve for Batavia illustrates insular conditions with less range, and the oceanic type for Jaluit, Marshall Islands, gives the least range. This double maximum is not a universal phenomenon, there being many cases where but a single maximum occurs.

As the belt of rains swings back and forth across the equator after the sun, there should be two rainy seasons with the sun vertical, and two dry seasons when the sun is farthest from the zenith, and while the trades blow. These conditions prevail on the equator, and as far north and south of the equator (about 10°-12°) as sufficient time elapses between the two zenithal positions of the sun for the two rainy seasons to be distinguished

from one another. In this belt, under normal conditions, there is therefore no dry season of any considerable duration. The double rainy season is clearly seen in equatorial Africa and in parts of equatorial South America. The maxima lag somewhat behind the vertical sun, coming in April and November, and are unsymmetrically developed, the first maximum being the principal one. The minima are also unsymmetrically developed, and the so-called "dry seasons" are seldom wholly rainless. This rainfall type with double maxima and minima has been called the equatorial type, and is illustrated in the following curves for South Africa and Quito (fig. 5). The monthly rainfalls are given in thousandths of the

annual mean. The mean annual rainfall at Quito is 42.12 in. These double rainy and dry seasons are easily modified by other conditions, as by the monsoons of the Indo-Australian area, so that there is no rigid belt of equatorial rains extending around the world. In South America, east of the Andes, the distinction between rainy and dry seasons is often much confused. In this equatorial belt the cloudiness is high throughout the year, averaging .7 to .8, with a relatively small annual period. The curve following, E (fig. 6), is fairly typical, but the annual period varies greatly under local controls.

At greater distances from the equator than about 10° or 12° the sun is still vertical twice a year within the tropics, but the interval between these two dates is so short that the two rainy seasons merge into one, in summer, and there is also but one dry season, in winter. This is the so-called tropical type of rainfall, and is found where the trade belts are encroached upon by the equatorial rains during the migration of these rains into each hemisphere. It is illustrated in the curves for São Paulo, Brazil and for the city of Mexico (fig. 5). The mean annual rainfall at São Paulo is 54.13 in. and at Mexico 22.99 in. The districts of tropical rains of this type lie along the equatorial margins of the torrid zone, outside of the latitudes of the equatorial type of rainfall. The rainy season becomes

shorter with increasing distance from the equator. The weather of the opposite seasons is strongly contrasted. The single dry season lasts longer than either dry season in the equatorial belt, reaching eight months in typical cases, with the wet season lasting four months. The lowlands often become dry and parched during the long dry trade-wind season (winter)

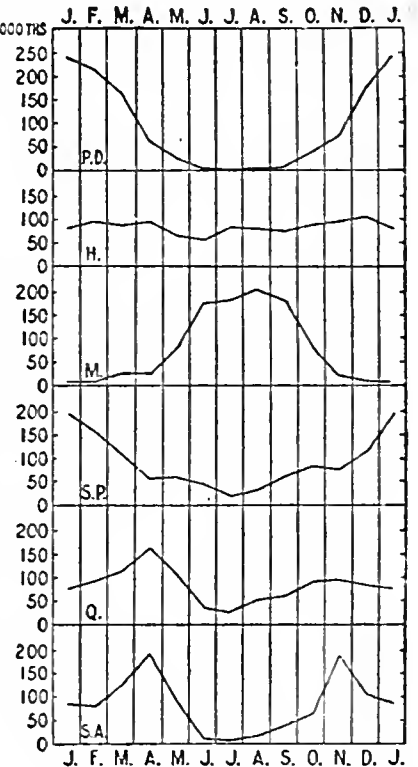

FIG. 5.—Annual march of rainfall in the tropics.

S.A, South Africa. M, Mexico.
Q, Quito. H, Hilo.
S.P, São Paulo. P.D, Port Darwin.

shorter with increasing distance from the equator. The weather of the opposite seasons is strongly contrasted. The single dry season lasts longer than either dry season in the equatorial belt, reaching eight months in typical cases, with the wet season lasting four months. The lowlands often become dry and parched during the long dry trade-wind season (winter)

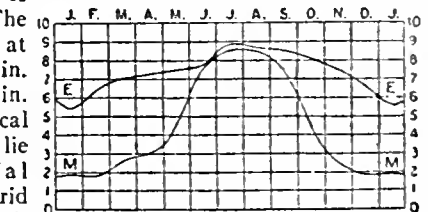

FIG. 6.—Annual march of cloudiness in the tropics. E, Equatorial type; M, Monsoon type.

and vegetation withers away, while grass and flowers grow in great abundance and all life takes on new activity during the time when the equatorial rainy belt with its calms, variable winds and heavy rains is over them (summer). The Sudan lies between the Sahara and the equatorial forests of Africa. It receives rains, and its vegetation grows actively, when the doldrum belt is north of the equator (May-August). But when the trades blow (December-March) the ground is parched and dusty. The Venezuelan llanos have a dry season in the northern winter, when the trade blows. The rains come in May-October. The campos of Brazil, south of the equator, have their rains in October-April, and are dry the remainder of

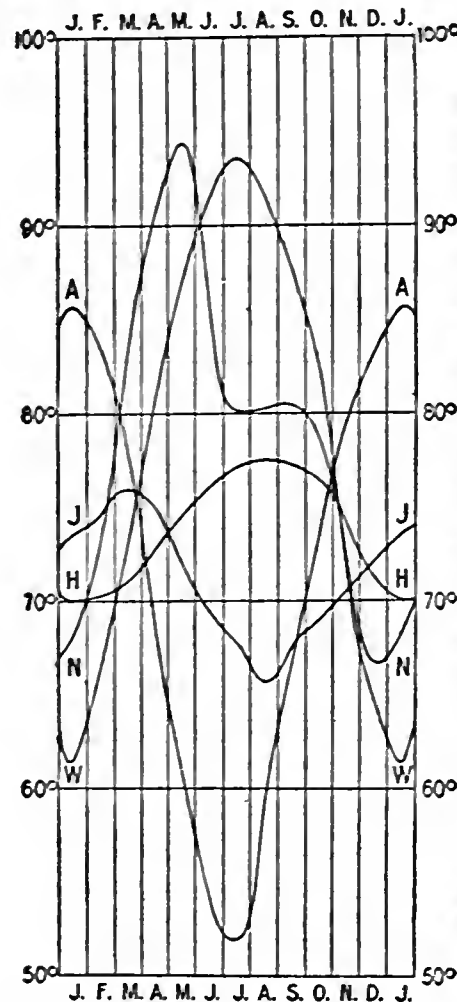

FIG. 7.—Annual march of temperature: tropical type. W, Wadi Halfa; A, Alice Springs; H, Honolulu; J, Jamestown, St Helena; N, Nagpur.

temperature, and a constancy and regularity of weather. The climate of the ocean areas in the trade-wind belts is indeed the simplest and most equable in the world, the greatest extremes over these oceans being found to leeward of the larger lands. On the lowlands swept over by the trades, beyond the polar limits of the equatorial rain belt (roughly between 40° and 30°), are most of the great deserts of the world. These deserts extend directly to the water's edge on the leeward western coasts of Australia, South Africa and South America.

The ranges and extremes of temperature are much greater over the continental interiors than over the oceans of the trade-wind belts. Minima of 32° or less occur during clear, quiet nights, and daily ranges of over 50° are common. The mid-summer mean temperature rises above 90° , with noon maxima of 110° or more in the non-cloudy, dry air of a desert day. The days, with high, dry winds, carrying dust and sand, with extreme

heat, accentuated by the absence of vegetation, are disagreeable, but the calmer nights, with active radiation under clear skies, are much more comfortable. The nocturnal temperatures are even not seldom too low for comfort in the cooler season, when thin sheets of ice may form.

While the trades are drying winds as long as they blow strongly over the oceans, or over lowlands, they readily become rainy if they are cooled by ascent over a mountain or highland. Hence the windward (eastern) sides of mountains or bold coasts in the trade-wind belts are well watered, while the leeward sides, or interiors, are dry. Mountainous islands in the trades, like the Hawaiian islands, many of the East and West Indies, the Philippines, Borneo, Ceylon, Madagascar, Teneriffe, &c., show marked differences of this sort. The eastern coasts of Guiana, Central America, south-eastern Brazil, south-eastern Africa, and eastern Australia are well watered, while the interiors are dry. The eastern highland of Australia constitutes a more effective barrier than that in South Africa; hence the Australian interior has a more extended desert. South America in the south-east trade belt is not well enclosed on the east, and the most arid portion is an interior district close to the eastern base of the Andes where the land is low. Even far inland the Andes again provoke precipitation along their eastern base, and the narrow Pacific coastal strip, to leeward of the Andes, is a very pronounced desert from near the equator to about 30° S. The cold ocean waters, with prevailing southerly (drying) winds alongshore, are additional factors causing this aridity. Highlands in the trade belts are therefore moist on their windward slopes, and become oases of luxuriant plant growth, while close at hand, on the leeward sides, dry savannas or deserts may be found. The damp, rainy and forested windward side of Central America was from the earliest days of European occupation left to the natives, while the centre of civilization was naturally established on the more open and sunny south-western side.

The rainfall associated with the conditions just described is known as the *trade type*. These rains have a maximum in winter, when the trades are most active. In cases where the trade blows steadily throughout the year against mountains or bold coasts, as on the Atlantic coast of Central America, there is no real dry season. The curve for Hilo (mean annual rainfall 145.24 in.) on the windward side of the Hawaiian Islands, shows typical conditions (see fig. 5). The trade type of rainfall is often much complicated by the combination with it of the *tropical* type and of the *monsoon* type. In the Malay archipelago there are also complications of equatorial and trade rains; likewise in the West Indies.

3. *Monsoon Belts*.—In a typical monsoon region the rains follow the vertical sun, and therefore have a simple annual period much like that of the tropical type above described. This monsoon type of rainfall is well illustrated in the curve for Port Darwin (mean annual rainfall 62.72 in.), in Australia (see fig. 5). This summer monsoon rainfall results from the inflow of a body of warm, moist air from the sea upon a land area; there is a consequent retardation of the velocity of the air currents, as the result of friction, and an ascent of the air, the rainfall being particularly heavy where the winds have to climb over high lands. In India, the precipitation is heaviest at the head of the Bay of Bengal (where Cherrapunji, at the height of 4455 ft. in the Khasi Hills, has a mean annual rainfall of between 400 and 500 in.), along the southern base of the Himalayas (60 to 160 in.), on the bold western coast of the peninsula (80 to 120 in. and over), and on the mountains of Burma (up to 160 in.). In the rain-shadow of the Western Ghats, the Deccan often suffers from drought and famine unless the monsoon rains are abundant and well distributed. The prevailing direction of the rainy monsoon wind in India is south-west; on the Pacific coast of Asia, it is south-east. This monsoon district is very large, including the Indian Ocean, Arabian Sea, Bay of Bengal, and adjoining continental areas; the Pacific coast of China, the Yellow and Japan seas, and numerous islands from Borneo to Sakhalin on the north and to the Ladrone Islands on the east. A typical temperature curve for a monsoon

district is that for Nagpur, in the Indian Deccan (fig. 7), and a typical monsoon cloudiness curve is given in fig. 6, the maximum coming near the time of the vertical sun, in the rainy season, and the minimum in the dry season.

In the Australian monsoon region, which reaches across New Guinea and the Sunda Islands, and west of Australia, in the Indian Ocean, over latitudes 0° - 10° S., the monsoon rains come with north-west winds in the period between November and March or April.

The general rule that eastern coasts in the tropics are the rainiest finds exceptions in the case of the rainy western coasts in India and other districts with similar monsoon rains. On the coast of the Gulf of Guinea, for example, there is a small rainy monsoon area during the summer; heavy rains fall on the seaward slopes of the Cameroon Mountains. Gorée, lat. 15° N., on the coast of Senegambia, gives a fine example of a rainy (summer) and a dry (winter) monsoon. Numerous combinations of equatorial, trade and monsoon rainfalls are found, often creating great complexity. The islands of the East Indian archipelago furnish many examples of such curious complications.

4. *Mountain Climate.*—In the torrid zone altitude is chiefly important because of its effect in tempering the heat of the lowlands, especially at night. If tropical mountains are high enough, they carry snow all the year round, even on the equator, and the zones of vegetation may range from the densest tropical forest at their base to the snow on their summits. The highlands and mountains within the tropics are thus often sharply contrasted with the lowlands, and offer more agreeable and more healthy conditions for white settlement. They are thus often sought by residents from colder latitudes as the most attractive resorts. In India, the hill stations are crowded during the hot months by civilian and military officials. The climate of many tropical plateaus and mountains has the reputation of being a "perpetual spring." Thus on the interior plateau of the tropical Cordilleras of South America, and on the plateaus of tropical Africa, the heat is tempered by the altitude, while the lowlands and coasts are very hot. The rainfall on tropical mountains and highlands often differs considerably in amount from that on the lowlands, and other features common to mountain climates the world over are also noted.

The Characteristics of the Temperate Zones.

General.—As a whole, the "temperate zones" are temperate only in that their mean temperatures and their physiological effects are intermediate between those of the tropics and those of the polar zones. A marked changeableness of the weather is a striking characteristic of these zones. Apparently irregular and haphazard, these continual weather changes, although they are essentially non-periodic, nevertheless run through a fairly systematic series. Climate and weather are by no means synonymous over most of the extra-tropical latitudes.

Temperature.—The mean annual temperatures at the margins of the north temperate zone differ by more than 70° . The ranges between the mean temperatures of hottest and coldest months reach 120° at their maximum in north-eastern Siberia, and 80° in North America. A January mean of -60° and a July mean of 95° , and maxima of over 120° and minima of -90° , occur in the same zone. Such great ranges characterize the extreme land climates. Under the influence of the oceans, the windward coasts have much smaller ranges. The annual ranges in middle and higher latitudes exceed the diurnal, the conditions of much of the torrid zone thus being exactly reversed. Over much of the oceans of the temperate zones the annual range is less than 10° . In the south temperate zone there are no extreme ranges, the maxima, slightly over 30° , being near the margin of the zone in the interior of South America, South Africa and Australia. In these same localities the diurnal ranges rival those of the north temperate zone.

The north-eastern Atlantic and north-western Europe are about 35° too warm for their latitude in January, while north-eastern Siberia is 30° too cold. The lands north of Hudson Bay are 25° too cold, and the waters of the Alaskan Bay 20° too

warm. In July, and in the southern hemisphere, the anomalies are small. The lands which are the centre of civilization in Europe average too warm for their latitudes. The diurnal variability of temperature is greater in the north temperate zone than elsewhere in the world, and the same month may differ greatly in its character in different years. The annual temperature curve has one maximum and one minimum. In the continental type the times of maximum and minimum are about one month behind the dates of maximum and minimum insolation. In the marine type the retardation may amount to nearly two months. Coasts and islands have a tendency to a cool spring and warm autumn; continents, to similar temperatures in both spring and fall.

Pressure and Winds.—The prevailing winds are the "westerlies," which are much less regular than the trades. They vary greatly in velocity in different regions and in different seasons, and are stronger in winter than in summer. They are much interfered with, especially in the higher northern latitudes, by seasonal changes of temperature and pressure over the continents, whereby the latter establish, more or less successfully, a system of obliquely outflowing winds in winter and of obliquely inflowing winds in summer. In summer, when the lands have low pressure, the northern oceans are dominated by great oval areas of high pressure, with outflowing spiral eddies, while in winter, when the northern lands have high pressure, the northern portions of the oceans develop cyclonic systems of inflowing winds over their warm waters. All these great continental and oceanic systems of spiralling winds are important climatic controls.

The westerlies are also much confused and interrupted by storms, whence their designation of *stormy westerlies*. So common are such interruptions that the prevailing westerly wind direction is often difficult to discern without careful observation. Cyclonic storms are most numerous and best developed in winter. Although greatly interfered with near sea-level by continental changes of pressure, by cyclonic and anticyclonic whirls, and by local inequalities of the surface, the eastward movement of the atmosphere remains very constant aloft. The south temperate zone being chiefly water, the westerlies are but little disturbed there by continental effects. Between latitudes 40° and 60° S. the "brave west winds" blow with a constancy and velocity found in the northern hemisphere only on the oceans, and then in a modified form. Storms, frequent and severe, characterize these southern hemisphere westerlies, and easterly wind directions are temporarily noted during their passage. Voyages to the west around Cape Horn against head gales, and in cold wet weather, are much dreaded. South of Africa and Australia, also, the westerlies are remarkably steady and strong. The winter in these latitudes is stormier than the summer, but the seasonal difference is less than north of the equator.

Rainfall.—Rainfall is fairly abundant over the oceans and also over a considerable part of the lands (30-50 in. and more). It comes chiefly in connexion with the usual cyclonic storms, or in thunderstorms. So great are the differences, geographic and periodic, in rainfall produced by differences in temperature, topography, cyclonic conditions, &c., that only the most general rules can be laid down. The equatorward margin of the temperate zone rains is clearly defined on the west coasts, at the points where the coast deserts are replaced by belts of light or moderate rainfall. Bold west coasts, on the polar side of lat. 40° , are very rainy (100 in. and more a year in the most favourable situations). The hearts of the continents, far from the sea, and especially when well enclosed by mountains, or when blown over by cool ocean winds which warm while crossing the land, have light rainfall (less than 10-20 in.). East coasts are wetter than interiors, but drier than west coasts. Winter is the season of maximum rainfall over oceans, islands and west coasts, for the westerlies are then most active, cyclonic storms are most numerous and best developed, and the cold lands chill the inflowing damp air. At this season, however, the low temperatures, high pressures, and tendency to outflowing winds over the continents are unfavourable to rainfall, and the interior land areas as a rule

then have their minimum. The warmer months bring the maximum rainfall over the continents. Conditions are then favourable for inflowing damp winds from the adjacent oceans; there is the best opportunity for convection; thunder-showers readily develop on the hot afternoons; the capacity of the air for water vapour is greatest. The marine type of rainfall, with a winter maximum, extends in over the western borders of the continents, and is also found in the winter rainfall of the sub-tropical belts. Rainfalls are heaviest along the tracks of most frequent cyclonic storms.

For continental stations the typical daily march of rainfall shows a chief maximum in the afternoon, and a secondary maximum in the night or early morning. The chief minimum comes between 10 A.M. and 2 P.M. Coast stations generally have a night maximum and a minimum between 10 A.M. and 4 P.M.

Humidity and Cloudiness.—S. A. Arrhenius gives the mean cloudiness for different latitudes as follows:—

70° N.	60°	50°	40°	30°	20°	10°	Eq.	10°	20°	30°	40°	50°	60° S.
59	61	48	49	42	40	50	58	57	48	46	56	66	75

The higher latitudes of the temperate zones thus have a mean cloudiness which equals and even exceeds that of the equatorial belt. The amounts are greater over the oceans and coasts than inland. The belts of minimum cloudiness are at about lat. 30° N. and S. Over the continental interiors the cloudiest season is summer, but the amount is never very large. Otherwise, winter is generally the cloudiest season and with a fairly high mean annual amount.

The absolute humidity as a whole decreases as the temperature falls. The relative humidity averages 90%, more or less, over the oceans, and is high under the clouds and rain of cyclonic storms, but depends, on land, upon the wind direction, winds from an ocean or from a lower latitude being damper, and those from a continent or from a colder latitude being drier.

Seasons.—Seasons in the temperate zones are classified according to temperature, not, as in the tropics, by rainfall. The four seasons are important characteristics, especially of the middle latitudes of the north temperate zone. Towards the equatorial margins of the zones the difference in temperature between summer and winter becomes smaller, and the transition seasons weaken and even disappear. At the polar margins the change from winter to summer, and vice versa, is so sudden that there also the transition seasons disappear.

These seasonal changes are of the greatest importance in the life of man. The monotonous heat of the tropics and the continued cold of the polar zones are both depressing. Their tendency is to operate against man's highest development. The seasonal changes of the temperate zones stimulate man to activity. They develop him, physically and mentally. They encourage higher civilization. A cold, stormy winter necessitates forethought in the preparation during the summer of clothing, food and shelter. Development must result from such conditions. In the warm, moist tropics life is too easy; in the cold polar zones it is too hard. Near the poles, the growing season is too short; in the moist tropics it is so long that there is little inducement to labour at any special time. The regularity, and the need, of outdoor work during a part of the year are important factors in the development of man in the temperate zones.

Weather.—An extreme changeableness of the weather, depending on the succession of cyclones and anticyclones, is another characteristic. For most of the year, and most of the zone, settled weather is unknown. The changes are most rapid in the northern portion of the north temperate zone, especially on the continents, where the cyclones travel fastest. The nature of these changes depends on the degree of development, the velocity of progression, the track, and other conditions of the disturbance which produces them. The particular weather types resulting from this control give the climates their distinctive character.

The types vary with the season and with the geographical position. They result from a combination, more or less irregular,

of periodic diurnal elements, under the regular control of the sun, and of non-periodic cyclonic and anticyclonic elements. In summer, on land, when the cyclonic element is weakest and the solar control is the strongest, the dominant types are associated with the regular changes from day to night. Daytime cumulus clouds; diurnal variation in wind velocity; afternoon thunderstorms, with considerable regularity, characterize the warmest months over the continents and present an analogy with tropical conditions. Cyclonic and anticyclonic spells of hotter or cooler, rainy or dry, weather, with varying winds differing in the temperatures and the moisture which they bring, serve to break the regularity of the diurnal types. In winter the non-periodic, cyclonic control is strongest. The irregular changes from clear to cloudy, from warmer to colder, from dry air to snow or rain, extend over large areas, and show little diurnal control. Spring and fall are transition seasons, and have transition weather types.

The south temperate zone oceans have a constancy of non-periodic cyclonic weather changes through the year which is only faintly imitated over the oceans of the northern hemisphere.

Winter types differ little from summer. The diurnal control is never very strong. Stormy weather prevails throughout the year although the weather changes are more frequent and stronger in the colder months.

Climatic Subdivisions.—There are fundamental differences between the north and south temperate zones. The latter zone is sufficiently individual to be given a place by itself. The marginal sub-tropical belts must also be considered as a separate group by themselves. The north temperate zone as a whole includes large areas of land, stretching over many degrees of latitude, as well as of water. Hence it embraces so remarkable a diversity of climates that no single district can be taken as typical of the whole. The simplest and most rational scheme for a classification of these climates is based on the fundamental differences which depend upon land and water, upon the prevailing winds, and upon altitude. Thus there are the ocean areas and the land areas. The latter are then subdivided into western (windward) and eastern (leeward) coasts, and interiors. Mountain climates remain as a separate group.

South Temperate Zone.—Because of the large ocean surface, the whole meteorological régime in the south temperate zone is more uniform than in the northern. The south temperate zone may properly be called "temperate." Its temperature changes are small; its prevailing winds are stronger and steadier than in the northern hemisphere; its seasons are more uniform; its weather is prevailingly stormier, more changeable, and more under cyclonic control. The uniformity of the climatic conditions over the far southern oceans is monotonously unattractive. The continental areas are small, and develop to a limited degree only the more marked seasonal and diurnal changes which are characteristic of lands in general. The summers are less stormy than the winters, but even the summer temperatures are not high. Such an area as that of New Zealand, with its mild climate and fairly regular rains, is really at the margins of the zone, and has much more favourable conditions than the islands farther south. These islands, in the heart of this zone, have dull, cheerless and inhospitable climates. The zone enjoys a good reputation for healthfulness, which fact has been ascribed chiefly to the strong and active air movement, the relatively drier air than in corresponding northern latitudes, and the cool summers. It must be remembered, also, that the lands are mostly in the sub-tropical belt, which possesses peculiar climatic advantages, as will be seen.

Sub-tropical Belts: Mediterranean Climates.—At the tropical margins of the temperate zones are the so-called sub-tropical belts. Their rainfall régime is alternately that of the westerlies and of the trades. They are thus associated, now with the temperate and now with the torrid zones. In winter the equatorward migration of the great pressure and wind systems brings these latitudes under the control of the westerlies, whose frequent irregular storms give a moderate winter precipitation.

These winter rains are not steady and continuous, but are separated by spells of fine sunny weather. The amounts vary greatly.¹ In summer, when the trades are extended polewards by the out-flowing equatorward winds on the eastern side of the ocean anticyclones, mild, dry and nearly continuous fair weather prevails, with general northerly winds.

The sub-tropical belts of winter rains and dry summers are not very clearly defined. They are mainly limited to the western coasts of the continents, and to the islands off these coasts in latitudes between about 28° and 40°. The sub-tropical belt is exceptionally wide in the old world, and reaches far inland there, embracing the countries bordering on the Mediterranean in southern Europe and northern Africa, and then extending eastward across the Dalmatian coast and the southern part of the Balkan peninsula into Syria, Mesopotamia, Arabia north of the tropic, Persia and the adjacent lands. The fact that the Mediterranean countries are so generally included has led to the use of the name "Mediterranean climate." Owing to the great irregularity of topography and outline, the Mediterranean province embraces many varieties of climate, but the dominant characteristics are the mild temperatures, except on the higher elevations, and the sub-tropical rains.

On the west coasts of the two Americas the sub-tropical belt of winter rains is clearly seen in California and in northern Chile, on the west of the coast mountain ranges. Between the region which has rain throughout the year from the stormy westerlies, and the districts which are permanently arid under the trades, there is an indefinite belt over which rains fall in winter. In southern Africa, which is controlled by the high pressure areas of the South Atlantic and south Indian oceans, the south-western coastal belt has winter rains, decreasing to the north, while the east coast and adjoining interior have summer rains, from the south-east trade. Southern Australia is climatically similar to South Africa. In summer the trades give rainfall on the eastern coast, decreasing inland. In winter the westerlies give moderate rains, chiefly on the south-western coast.

The sub-tropical climates follow the tropical high pressure belts across the oceans, but they do not retain their distinctive character far inland from the west coasts of the continents (except in the Mediterranean case), nor on the east coasts. On the latter, summer monsoons and the occurrence of general summer rains interfere, as in eastern Asia and in Florida.

Strictly winter rains are typical of the coasts and islands of this belt. The more continental areas have a tendency to spring and autumn rains. The rainy and dry seasons are most marked at the equatorward margins of the belt. With increasing latitude, the rain is more evenly distributed through the year, the summer becoming more and more rainy until, in the continental interiors of the higher latitudes, the summer becomes the season of maximum rainfall. The monthly distribution of rainfall in two sub-tropical regions is shown in the accompanying curves for Malta and for Western Australia (fig. 8). In Alexandria the dry season lasts nearly eight months; in Palestine, from six to seven months; in Greece, about four months. The sub-tropical rains are peculiarly well developed on the eastern coast of the Atlantic Ocean.

The winter rains which migrate equatorward are separated by the Sahara from the equatorial rains which migrate poleward. An unusually extended migration of either of these rain belts may bring them close together, leaving but a small part, if any,

¹ Approximately Lisbon has 28.60 in.; Madrid, 16.50; Algiers, 28.15; Nice, 33.00; Rome, 29.90; Ragusa, 63.90.

These winter rains are not steady and continuous, but are separated by spells of fine sunny weather. The amounts vary greatly.¹ In summer, when the trades are extended polewards by the out-flowing equatorward winds on the eastern side of the ocean anticyclones, mild, dry and nearly continuous fair weather prevails, with general northerly winds.

The sub-tropical belts of winter rains and dry summers are not very clearly defined. They are mainly limited to the western coasts of the continents, and to the islands off these coasts in latitudes between about 28° and 40°. The sub-tropical belt is exceptionally wide in the old world, and reaches far inland there, embracing the countries bordering on the Mediterranean in southern Europe and northern Africa, and then extending eastward across the Dalmatian coast and the southern part of the Balkan peninsula into Syria, Mesopotamia, Arabia north of the tropic, Persia and the adjacent lands. The fact that the Mediterranean countries are so generally included has led to the use of the name "Mediterranean climate." Owing to the great irregularity of topography and outline, the Mediterranean province embraces many varieties of climate, but the dominant characteristics are the mild temperatures, except on the higher elevations, and the sub-tropical rains.

¹ Approximately Lisbon has 28.60 in.; Madrid, 16.50; Algiers, 28.15; Nice, 33.00; Rome, 29.90; Ragusa, 63.90.

of the intervening desert actually rainless. The Arabian desert occupies a somewhat similar position. Large variations in the annual rainfall may be expected towards the equatorial margins of the sub-tropical belts.

The main features of the sub-tropical rains east of the Atlantic are repeated on the Pacific coasts of the two Americas. In North America the rainfall decreases from Alaska, Washington and northern Oregon southwards to lower California, and the length of the summer dry season increases. At San Diego, six months (May-October) have each less than 5% of the annual precipitation, and four of these have 1%. The southern extremity of Chile, from about latitude 38° S. southward, has heavy rainfall throughout the year from the westerlies, with a winter maximum. Northern Chile is persistently dry. Between these two there are winter rains and dry summers. Neither Africa nor Australia extends far enough south to show the different members of this system well. New Zealand is almost wholly in the prevailing westerly belt. Northern India is unique in having summer monsoon rains and also winter rains, the latter from weak cyclonic storms which correspond with the sub-tropical winter rains.

From the position of the sub-tropical belts to leeward of the oceans, and at the equatorial margins of the temperate zones, it follows that their temperatures are not extreme. Further, the protection afforded by mountain ranges, as by the Alps in Europe and the Sierra Nevada in the United States, is an important factor in keeping out extremes of winter cold. The annual march and ranges of temperature depend upon position with reference to continental or marine influences. This is seen in the accompanying data and curves for Bagdad, Cordoba (Argentina), Bermuda and Auckland (fig. 9). The Mediterranean basin is particularly favoured in winter, not only in the protection against cold afforded by the mountains but also in the high temperature of the sea itself. The southern Alpine valleys and the Riviera are well situated, having good protection and a southern exposure. The coldest month usually has a mean temperature well above 32°. Mean minimum temperatures of about, and somewhat below, freezing occur in the northern portion of the district, and in the more continental localities minima a good deal lower have been observed. Mean maximum temperatures of about 95° occur in northern Italy, and of still higher degrees in the southern portions. Somewhat similar conditions obtain in the sub-tropical district of North America. Under the control of passing cyclonic storm areas, hot or cold winds, which often owe some of their special characteristics to the topography, bring into the sub-tropical belts, from higher or lower latitudes, unseasonably high or low temperatures. These winds have been given special names (mistral, sirocco, bora, &c.).

FIG. 9.—Annual March of Temperature for selected Sub-tropical Stations. C, Cordoba; A, Auckland; Ba, Bermuda; Bd, Bagdad.

These belts are among the least cloudy districts in the world. The accompanying curve, giving an average for ten stations, shows the small annual amount of cloud, the winter maximum and the marked summer minimum, in a typical sub-tropical

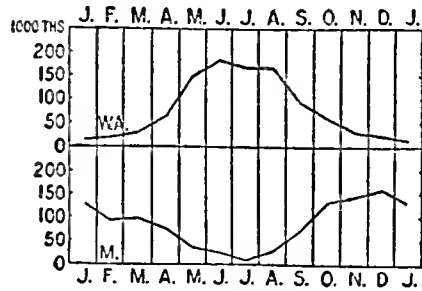
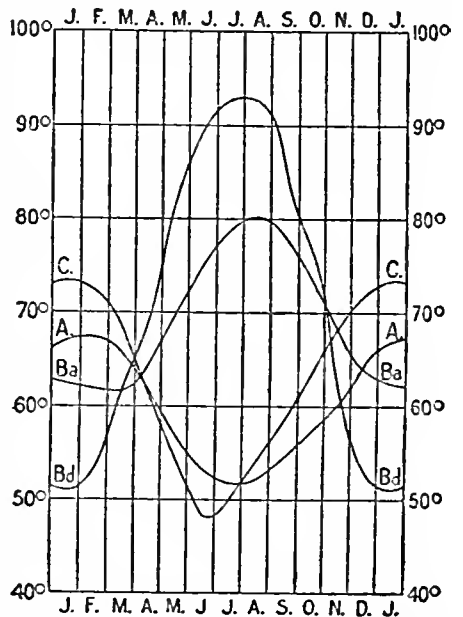

FIG. 8.—Annual March of Rainfall: Sub-tropical Type. W.A., Western Australia; M, Malta.

climate (fig. 10). The winter rains do not bring continuously overcast skies, and a summer month with a mean cloudiness of 10% is not exceptional in the drier parts of the sub-tropics.

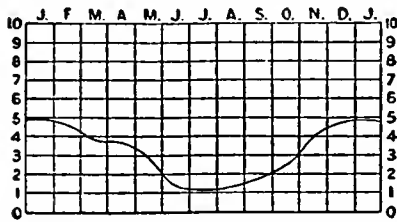

FIG. 10.—Annual March of Cloudiness in a Sub-tropical Climate (Eastern Mediterranean).

With prevailing fair skies, even temperatures, and moderate rainfall, the sub-tropical belts possess many climatic advantages which fit them for health resorts. The long list of well-known resorts on the Mediterranean coast, and the shorter list for California, bear witness to this fact.

North Temperate Zone: West Coasts.—Marine climatic types are carried by the prevailing westerlies on to the western coasts of the continents, giving them mild winters and cool summers, abundant rainfall, and a high degree of cloudiness and relative humidity. North-western Europe is particularly favoured because of the remarkably high temperatures of the North Atlantic Ocean. January means of 40° to 50° in the British Isles and on the northern French coast occur in the same latitudes as those of 0° and 10° in the far interior of Asia. In July means 60° to 70° in the former contrast with 70° to 80° in the latter districts. The conditions are somewhat similar in North America. Along the western coasts of North America and of Europe the mean annual ranges are under 25°—actually no greater than some of those within the tropics. Irregular cyclonic temperature changes are, however, marked in the temperate zone, while absent in the tropics. The curves for the Scilly Isles and for Thorshavn, Farøe Islands, illustrate the insular type of temperature on the west coasts (fig. 11). The annual march of rainfall, with the marked maximum in the fall and winter which is characteristic of the marine régime, is illustrated in the curve for north-western Europe (fig. 12). On the northern Pacific coast of North America

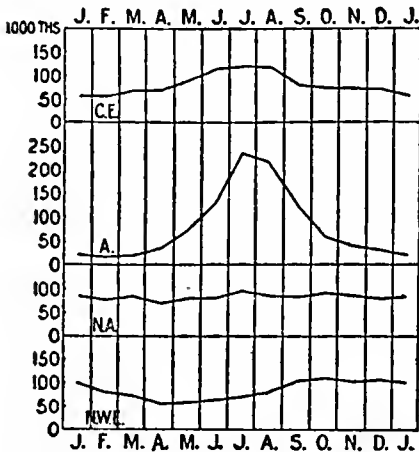

FIG. 12.—Annual March of Rainfall; Temperate Zone. C.E., Central Europe; A., Northern Asia; N.A., Atlantic coast of North America; N.W.E., North-west Europe.

the distribution is similar, and in the southern hemisphere the western coasts of southern South America, Tasmania and New Zealand show the same type. The cloudiness and relative humidity average high on western coasts, with the maximum in the colder season.

The west coasts therefore, including the important climatic province of western Europe, and the coast provinces of north-western North America, New Zealand and southern Chile, have as a whole mild winters, equable temperatures, small ranges, and abundant rainfall, fairly well distributed through the year. The summers are relatively cool.

Continental Interiors.—The equable climate of the western coasts changes, gradually or suddenly, into the more extreme climates of the interiors. In Europe, where no high mountain ranges intervene, the transition is gradual, and broad stretches of country have the benefits of the tempering influence of the

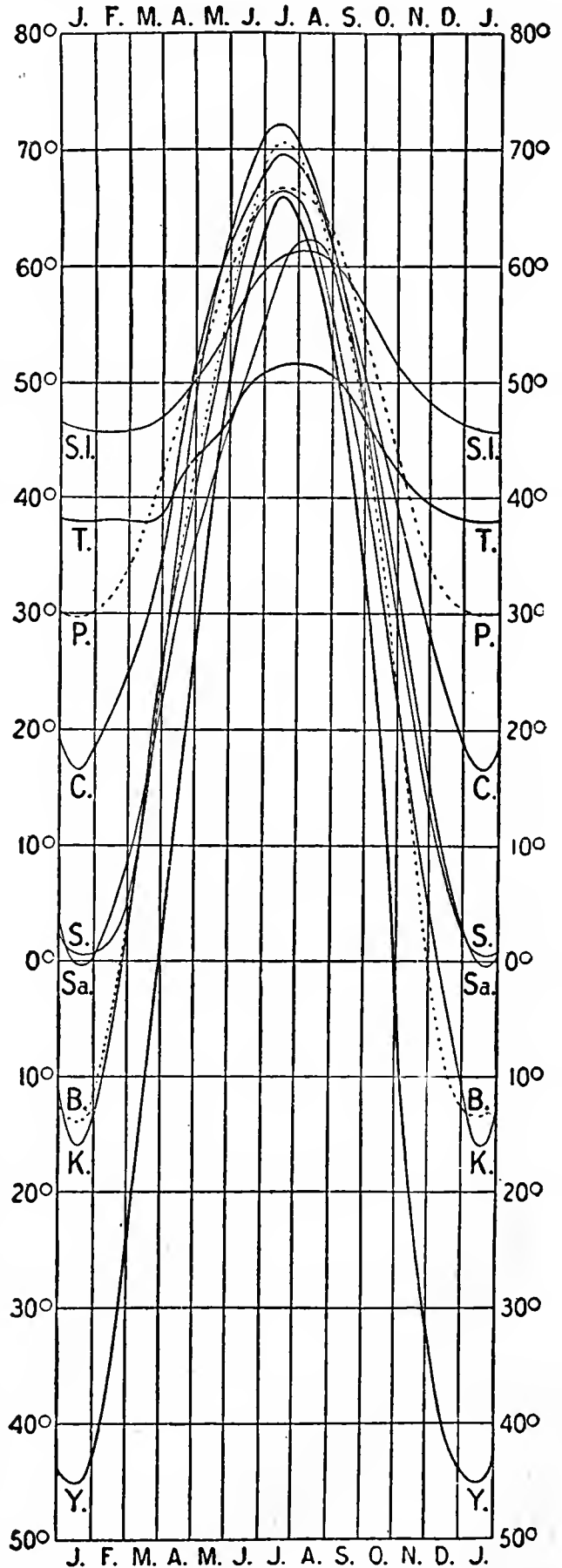

FIG. 11.

- S. I., Scilly Isles.
- P., Prague.
- C., Charkow.
- S., Semipalatinsk.
- K., Kiakta.
- B., Blagoveshchensk.
- Sa., Sakhalin.
- T., Thorshavn.
- Y., Yakutsk.

Atlantic. In North America the change is abrupt, and comes on crossing the lofty western mountain barrier. The curves in fig. 11 illustrate well the gradually increasing continentality of the climate with increasing distance inland in Eurasia.

The continental interiors of the north temperate zone have the greatest extremes in the world. Towards the Arctic circle the winters are extremely severe, and January mean temperatures of -10° and -20° occur over considerable areas. At the cold pole of north-eastern Siberia a January mean of -60° is found. Mean minimum temperatures of -40° occur in the area from eastern Russia, over Siberia and down to about latitude 50° N. Over no small part of Siberia minimum temperatures below -70° may be looked for every winter. Thorshavn and Yakutsk are excellent examples of the temperature differences along the same latitude line (see fig. 11). The winter in this interior region is dominated by a marked high pressure. The weather is prevailing clear and calm. The ground is frozen all the year round below a slight depth over wide areas. The extremely low temperatures are most trying when the steppes are swept by icy storm winds (*buran*, *purga*), carrying loose snow, and often resulting in loss of life. In the North American interior the winter cold is somewhat less severe. North American winter weather in middle latitudes is often interrupted by cyclones, which, under the steep poleward temperature gradient then prevailing, cause frequent, marked and sudden changes in wind direction and temperature over the central and eastern United States. Cold waves and warm waves are common, and blizzards resemble the buran or purga of Russia and Siberia. With cold northerly winds, temperatures below freezing are carried far south towards the tropic.

The January mean temperatures in the southern portions of the continental interiors average about 50° or 60° . In summer the northern continental interiors are warm, with July means of 60° and thereabouts. These temperatures are not much higher than those on the west coasts, but as the northern interior winters are much colder than those on the coasts, the interior ranges are very large. Mean maximum temperatures of 86° occur beyond the Arctic circle in north-eastern Siberia, and beyond latitude 60° in North America. In spite of the extreme winter cold, agriculture extends remarkably far north in these regions, because of the warm, though short, summers, with favourable rainfall distribution. The summer heat is sufficient to thaw the upper surface of the frozen ground, and vegetation prospers for its short season. At this time great stretches of flat surface become swamps. The southern interiors have torrid heat in summer, temperatures of over 90° being recorded in the south-western United States and in southern Asia. In these districts the diurnal ranges of temperature are very large, often exceeding 40° , and the mean maxima exceed 110° .

The winter maximum rainfall of the west coasts becomes a summer maximum in the interiors. The change is gradual in Europe, as was the change in temperature, but more sudden in North America. The curves for central Europe and for northern Asia illustrate these continental summer rains (see fig. 12). The summer maximum becomes more marked with the increasing continental character of the climate. There is also a well-marked decrease in the amount of rainfall inland. In western Europe the rainfall averages 20 to 30 in., which much larger amounts (reaching 80-100 in. and even more) on the bold west coasts, as in the British Isles and Scandinavia, where the moist Atlantic winds are deflected upwards, and also locally on mountain ranges, as on the Alps. There are small rainfalls (below 20 in.) in eastern Scandinavia and on the Iberian peninsula. Eastern Europe has generally less than 20 in., western Siberia about 15 in., and eastern Siberia about 10 in. In the southern part of the great overgrown continent of Asia an extended region of steppes and deserts, too far from the sea to receive sufficient precipitation, shut in, furthermore, by mountains, controlled in summer by drying northerly winds, receives less than 10 in. a year, and in places less than 5 in. In this interior district of Asia population is inevitably small and suffers under a condition of hopeless aridity.

The North American interior has more favourable rainfall conditions than Asia, because the former continent is not overgrown. The heavy rainfalls on the western slopes of the Pacific coast mountains correspond, in a general way, with those on the west coast of Europe, although they are heavier (over 100 in. at a maximum). The close proximity of the mountains to the Pacific, however, involves a much more rapid decrease of rainfall inland than is the case in Europe, as may be seen by comparing the isohyetal lines¹ in the two cases. A considerable interior region is left with deficient rainfall (less than 10 in.) in the south-west. The eastern portion of the continent is freely open to the Atlantic and the Gulf of Mexico, so that moist cyclonic winds have access, and rainfalls of over 20 in. are found everywhere east of the rooth meridian. These conditions are much more favourable than those in eastern Asia. The greater part of the interior of North America has the usual warm-season rains. In the interior basin, between the Rocky and Sierra Nevada mountains, the higher plateaus and mountains receive much more rain than the desert lowlands. Forests grow on the higher elevations, while irrigation is necessary for agriculture on the lowlands. The rainfall here comes largely from thunderstorms.

In South America the narrow Pacific slope has heavy rainfall (over 80 in.). East of the Andes the plains are dry (mostly less than 10 in.). The southern part of the continent is very narrow, and is open to the east, as well as more open to the west owing to the decreasing height of the mountains. Hence the rainfall increases somewhat to the south, coming in connexion with passing cyclones. Tasmania and New Zealand have most rain on their western slopes.

In a typical continental climate the winter, except for radiation fogs, is very clear, and the summer the cloudiest season, as is well shown in the accompanying curve for eastern Asia (A, fig. 13).

In a more moderate continental climate, such as that of central Europe (E, fig. 13), and much of the United States, the winter is the cloudiest season. In the first case the mean cloudiness is small; in the second there is a good deal of cloud all the year round.

East Coasts.—The prevailing winds carry the continental climates of the interiors off over the eastern coasts of the temperate zone lands, and even for some distance on to the adjacent oceans. The east coasts therefore have continental climates, with modifications resulting from the presence of the oceans to leeward, and are necessarily separated from the west coasts, with which they have little in common. On the west coasts of the north temperate lands the isotherms are far apart. On the east coasts they are crowded together. The east coasts share with the interiors large annual and cyclonic ranges of temperature. A glance at the isothermal maps of the world will show at once how favoured, because of its position to leeward of the warm North Atlantic waters, is western Europe as compared with eastern North America. A similar contrast, less marked, is seen in eastern Asia and western North America. In eastern Asia there is some protection, by the coast mountains, against the extreme cold of the interior, but in North America there is no such barrier, and severe cold winds sweep across the Atlantic coast states, even far to the south. Owing to the prevailing offshore winds, the oceans to leeward have relatively little effect.

As already noted, the rainfall increases from the interiors towards the east coasts. In North America the distribution through the year is very uniform, with some tendency to a summer maximum, as in the interior (N.A., fig. 12).

In eastern Asia the winters are relatively dry and clear, under

¹ *i.e.* lines drawn on a map to connect all places having an equal rainfall.

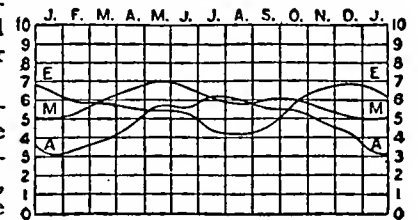

FIG. 13.—Annual March of Cloudiness; Temperate Zones. E, Central Europe; A, Eastern Asia; M, mountain.

the influence of the cold offshore monsoon, and the summers are warm and rainy. Rainfalls of 40 in. are found on the east coasts of Korea, Kamchatka and Japan, while in North America, which is more open, they reach farther inland. Japan, although occupying an insular position, has a modified continental rather than a marine climate. The winter monsoon, after crossing the water, gives abundant rain on the western coast, while the winter is relatively dry on the lee of the mountains, on the east. Japan has smaller temperature ranges than the mainland.

Mountain Climates.—The mountain climates of the temperate zone have the usual characteristics which are associated with altitude everywhere. If the altitude is sufficiently great the decreased temperature gives mountains a polar climate, with the difference that the summers are relatively cool while the winters are mild owing to inversions of temperature in anticyclonic weather. Hence the annual ranges are smaller than over lowlands. At such times of inversion the mountain-tops often appear as local areas of higher temperature in a general region of colder air over the valleys and lowlands. The increased intensity of insolation aloft is an important factor in giving certain mountain resorts their deserved popularity in winter (e.g. Davos and Meran). Of Meran it has been well said that from December to March the nights are winter, but the days are mild spring. The diurnal ascending air currents of summer usually give mountains their maximum cloudiness and highest relative humidity in the warmer months, while winter is the drier and clearer season. This is shown in curve M, fig. 13. The clouds of winter are low, those of summer are higher. Hence the annual march of cloudiness on mountains is usually the opposite of that on lowlands.

Characteristics of the Polar Zones.

General.—The temperate zones merge into the polar zones at the Arctic and Antarctic circles, or, if temperature be used as the basis of classification, at the isotherms of 50° for the warmest month, as suggested by Supan. The longer or shorter absence of the sun gives the climate a peculiar character, not found elsewhere.

Beyond the isotherm of 50° for the warmest month forest trees and cereals do not grow. In the northern hemisphere this line is well north of the Arctic circle in the continental climate of Asia, and north of it also in north-western North America and in northern Scandinavia, but falls well south in eastern British America, Labrador and Greenland, and also in the North Pacific Ocean. In the southern hemisphere this isotherm crosses the southern extremity of South America, and runs fairly east and west around the globe there. The conditions of life are necessarily very specialized for the peculiar climatic features which are met with in these zones. There is a minimum of life, but more in the north polar than the south polar zone. Plants are few and lowly. Land animals which depend upon plant food must therefore likewise be few in number. Farming and cattle-raising cease. Population is small and scattered. There are no permanent settlements at all within the Antarctic circle. Life is a constant struggle for existence. Man seeks his food by the chase on land, but chiefly in the sea. He lives along, or near, the sea-coast. The interior lands, away from the sea, are deserted. Gales and snow and cold cause many deaths on land, and, especially during fishing expeditions, at sea. Under such hard conditions of securing food, famine is a likely occurrence.

In the arctic climate vegetation must make rapid growth in the short, cool summer. In the highest latitudes the summer temperatures are not high enough to melt snow on a level. Exposure is therefore of the greatest importance. Arctic plants grow and blossom with great rapidity and luxuriance where the exposure is favourable, and where the water from the melting snow can run off. The soil then dries quickly, and can be effectively warmed. Protection against cold winds is another important factor in the growth of vegetation. Over great stretches of the northern plains the surface only is thawed out in the warmer months, and swamps, mosses and lichens are

found above eternally frozen ground. Direct insolation is very effective in high latitudes. Where the exposure is favourable, snow melts in the sun when the temperature of the air in the shade is far below freezing.

Arctic and antarctic zones differ a good deal in the distribution and arrangement of land and water around and in them. The southern zone is surrounded by a wide belt of open sea; the northern, by land areas. The northern is therefore much affected by the conditions of adjacent continental masses. Nevertheless, the general characteristics are apparently much the same over both, so far as is now known, the antarctic differing from the arctic chiefly in having colder summers and in the regularity of its pressure and winds. Both zones have the lowest mean annual temperatures in their respective hemispheres, and hence may properly be called the *cold zones*.

Temperature.—At the solstices the two poles receive the largest amounts of insolation which any part of the earth's surface ever receives. It would seem, therefore, that the temperatures at the poles should then be the highest in the world, but as a matter of fact they are nearly or quite the lowest. Temperatures do not follow insolation in this case because much of the latter never reaches the earth's surface; because most of the energy which does reach the surface is expended in melting the snow and ice of the polar areas; and because the water areas are large, and the duration of insolation is short.

A set of monthly isothermal charts of the north polar area, based on all available observations, has been prepared by H. Mohn and published in the volume on Meteorology of the Nansen expedition. In the winter months there are three cold poles, in Siberia, in Greenland and at the pole itself. In January the mean temperatures at these three cold poles are -49°, -40° and -40° respectively. The Siberian cold pole becomes a maximum of temperature during the summer, but the Greenland and polar minima remain throughout the year. In July the temperature distribution shows considerable uniformity; the gradients are relatively weak. A large area in the interior of Greenland, and one of about equal extent around the pole, are within the isotherm of 32°. For the year a large area around the pole is enclosed by the isotherm of -4°, with an isotherm of the same value in the interior of Greenland, but a local area of -7.6° is noted in Greenland, and one of -11.2° is centred at lat. 80° N. and long. 170° E.

The north polar chart of annual range of temperature shows a maximum range of about 120° in Siberia; of 80° in North America; of 75.6° at the North Pole, and of 72° in Greenland. The North Pole obviously has a continental climate. The minimum ranges are on the Atlantic and Pacific Oceans. The mean annual isanomalies show that the interior of Greenland has a negative anomaly in all months. The Norwegian sea area is 45° too warm in January and February. Siberia has +10.8° in summer, and -45° in January. Between Bering Strait and the pole there is a negative anomaly in all months. The influence of the Gulf Stream drift is clearly seen on the chart, as it is also on that of mean annual ranges.

For the North Pole Mohn gives the following results, obtained by graphic methods:—

Mean Temperatures at the North Pole.

Jan.	Feb.	Mar.	Apr.	May.	June.	July.	Aug.	Sept.	Oct.	Nov.	Dec.	Year.
-41.8°	-41.8°	-31.0°	-18.4°	8.6°	28.4°	30.2°	26.6°	8.6°	-11.2°	-27.4°	-36.4°	-8.9°

It appears that the region about the North Pole is the coldest place in the northern hemisphere for the mean of the year, and that the interior ice desert of Greenland, together with the inner polar area, are together the coldest parts of the northern hemisphere in July. In January, however, Verkhoyansk, in north-eastern Siberia, just within the Arctic circle, has a mean temperature of about -60°, while the inner polar area and the northern interior of Greenland have only -40°. Thus far no minima as low as those of north-eastern Siberia have been recorded in the Arctic.

For the Antarctic our knowledge is still very fragmentary,

and relates chiefly to the summer months. Hann has determined the mean temperatures of the higher southern latitudes as follows:—

Mean Temperatures of High Southern Latitudes.

S. Lat.	50°	60°	70°	80°
Mean Annual	41.9	28.4	11.3	-3.6
January	46.9	37.8	30.6	20.3
July	37.2	18.3	-8.0	-24.7

From lat. 70° S. polewards, J. Hann finds that the southern hemisphere is colder than the northern. Antarctic summers are decidedly cold. The mean annual temperatures experienced have been in the vicinity of 10°, and the minima of an ordinary antarctic winter go down to -40° and below, but so far no minima of the severest Siberian intensity have been noted. The maxima have varied between 35° and 50°.

The temperatures at the South Pole itself furnish an interesting subject for speculation. It is likely that near the South Pole will prove to be the coldest point on the earth's surface for the year, as the distribution of insolation would imply, and as the conditions of land and ice and snow there would suggest. The lowest winter and summer temperatures in the southern hemisphere will almost certainly be found in the immediate vicinity of the pole. It must not be supposed that the isotherms in the antarctic region run parallel with the latitude lines. They bend polewards and equatorwards at different meridians, although much less so than in the Arctic.

The annual march of temperature in the north polar zone, for which we have the best comparable data, is peculiar in having a much-retarded minimum in February or even in March—the result of the long, cold winter. The temperature rises rapidly towards summer, and reaches a maximum in July. Autumn is warmer than spring.

The continents do not penetrate far enough into the arctic zone to develop a pure continental climate in the highest latitudes. Verkhojansk, in lat. 67° 6' N., furnishes an excellent example of an exaggerated continental type for the margin of the zone, with an annual range of 120°. One-third as large a range is found on Novaya Zemlya. Polar climate as a whole has large annual and small diurnal ranges, but sudden changes of wind may cause marked irregular temperature changes within twenty-four hours, especially in winter. The smaller ranges are associated with greater cloudiness, and vice versa. The mean diurnal variability is very small in summer, and reaches its maximum in winter, about 7° in February, according to Mohr.

Pressure and Winds.—Owing to the more symmetrical distribution of land and water in the southern than in the northern polar area, the pressures and winds have a simpler arrangement in the former, and may be first considered. The rapid southward decrease of pressure, which is so marked a feature of the higher latitudes of the southern hemisphere on the isobaric charts of the world, does not continue all the way to the South Pole. Nor do the prevailing westerly winds, constituting the "circumpolar whirl," which are so well developed over the southern portions of the southern hemisphere oceans, blow all the way home to the South Pole. The steep poleward pressure gradients of these southern oceans end in a trough of low pressure, girdling the earth at about the Antarctic circle. From here the pressure increases again towards the South Pole, where a permanent inner polar anticyclonic area is found, with outflowing winds deflected by the earth's rotation into easterly and south-easterly directions. These easterly winds have been observed by the recent expeditions which have penetrated far enough south to cross the low-pressure trough. The limits between the prevailing westerlies and the outflowing winds from the pole ("easterlies") vary with the longitude and migrate with the seasons. The change in passing from one wind system to the other is easily observed. This south polar anticyclone, with its surrounding low-pressure girdle, migrates with the season, the centre apparently shifting polewards in summer and towards the eastern hemisphere in winter. The outflowing winds from the polar anticyclones sweep down across the inland ice. Under certain topographic

conditions, descending across mountain ranges, as in the case of the Admiralty Range in Victoria Land, these winds may develop high velocity and take on typical *föhn* characteristics, raising the temperature to an unusually high degree. *Föhn* winds are also known on both coasts of Greenland, when a passing cyclonic depression draws the air down from the icy interior. These Greenland *föhn* winds are important climatic elements, for they blow down warm and dry, raising the temperature even 30° or 40° above the winter mean, and melting the snow.

In the Arctic area the wind systems are less clearly defined and the pressure distribution is much less regular, on account of the irregular distribution of land and water. The isobaric charts published in the report of the Nansen expedition show that the North Atlantic low-pressure area is more or less well developed in all months. Except in June, when it lies over southern Greenland, this tongue-shaped trough of low pressure lies in Davis strait, to the south-west or west of Iceland, and over the Norwegian Sea. In winter it greatly extends its limits farther east into the inner Arctic Ocean, to the north of Russia and Siberia. The Pacific minimum of pressure is found south of Bering Strait and in Alaska. Between these two regions of lower pressure the divide extends from North America to eastern Siberia. This divide has been called by Supan the "Arktische Wind-scheide." The pressure gradients are steepest in winter. At the pole itself pressure seems to be highest in April and lowest from June to September. The annual range is only about 0.20 in.

The prevailing westerlies, which in the high southern latitudes are so symmetrically developed, are interfered with to such an extent by the varying pressure controls over the northern continents and oceans in summer and winter that they are often hardly recognizable on the wind maps. The isobaric and wind charts show that on the whole the winds blow out from the inner polar basin, especially in winter and spring.

Rain and Snow.—Rainfall on the whole decreases steadily from equator to poles. The amount of precipitation must of necessity be comparatively slight in the polar zones, chiefly because of the small capacity of the air for water vapour at the low temperatures there prevailing; partly also because of the decrease, or absence, of local convectional storms and thunder-showers. Locally, under exceptional conditions, as in the case of the western coast of Norway, the rainfall is a good deal heavier. Even cyclonic storms cannot yield much precipitation. The extended snow and ice fields tend to give an exaggerated idea of the actual amount of precipitation. It must be remembered, however, that evaporation is slow at low temperatures, and melting is not excessive. Hence the polar store of fallen snow is well preserved: interior snowfields, ice sheets and glaciers are produced.

The commonest form of precipitation is naturally snow, the summer limit of which, in the northern hemisphere, is near the Arctic circle, with the exception of Norway. So far as exploration has yet gone into the highest latitudes, rain falls in summer, and it is doubtful whether there are places where *all* the precipitation falls as snow. The snow of the polar regions is characteristically fine and dry. At low polar temperatures flakes of snow are not found, but precipitation is in the form of ice spicules. The finest glittering ice needles often fill the air, even on clear days, and in calm weather, and gradually descending to the surface, slowly add to the depth of snow on the ground. Dry snow is also blown from the snowfields on windy days, interfering with the transparency of the air.

Humidity, Cloudiness and Fog.—The absolute humidity must be low in polar latitudes, especially in winter, on account of the low temperatures. Relative humidity varies greatly, and very low readings have often been recorded. Cloudiness seems to decrease somewhat towards the inner polar areas, after passing the belt of high cloudiness in the higher latitudes of the temperate zones. In the marine climates of high latitudes the summer, which is the calmest season, has the maximum cloudiness; the winter, with more active wind movement, is clearer. The

¹ *Nature*, lxxi. (Jan. 5, 1905), p. 221.

curve here given illustrates these conditions (fig. 14). The summer maximum is largely due to fogs, which are produced where warm, damp air is chilled by coming in contact with ice. They are also formed over open waters, as among the Faeroe Islands, for example, and open water spaces, in the midst of an ice-covered sea, are commonly detected at a distance by means of the "steam fog" which rises from them. Fogs are less

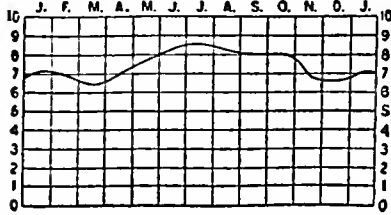

FIG. 14.—Annual March of Cloudiness in Polar Latitudes (marine type).

common in winter, when they occur as radiation fogs, of no great thickness. The small winter cloudiness, which is reported also from the antarctic zone, corresponds with the low absolute humidity and small precipitation. The coasts and islands bathed by the warm waters of the Gulf Stream drift usually have a higher cloudiness in winter than in summer. The place of fog is in winter taken by the fine snow crystals, which often darken the air like fog when strong winds raise the dry snow from the surfaces on which it is lying. Cumulus cloud forms are rare, even in summer, and it is doubtful whether the cloud occurs at all in its typical development. Stratus is probably the commonest cloud of high latitudes, often covering the sky for days without a break. Cirrus cloud forms probably decrease polewards.

Cyclones and Weather.—The prevailing westerlies continue up into the margins of the polar zones. Many of their cyclonic storms also continue on to the polar zones, giving sudden and irregular pressure and weather changes. The inner polar areas seem to be beyond the reach of frequent and violent cyclonic disturbance. Calms are more common; the weather is quieter and fairer; precipitation is less. Most of the observations thus far obtained from the Antarctic come from this marginal zone of great cyclonic activity, violent winds, and wet, disagreeable, inhospitable weather, and therefore do not show the features of the actual south polar climate.

During the three years of the "Fram's" drift depressions passed on all sides of her, with a preponderance on the west. The direction of progression averaged nearly due east, and the hourly velocity 27 to 34 m., which is about that in the United States. For the higher latitudes, most of the cyclones must pass by on the equatorial side of the observer, giving "backing" winds in the northern hemisphere. The main cyclonic tracks are such that the wind characteristically backs in Iceland, and still more so in Jan Mayen and on the eastern coast of Greenland, these districts lying on the north and west of the path of progression. Frightful winter storms occasionally occur along the east coast of Greenland and off Spitzbergen.

For much of the year in the polar zones the diurnal control is weak or absent. The successive spells of stormy or of fine weather are wholly cyclonically controlled. Extraordinary records of storm and gale have been brought back from the far south and the far north. Wind direction and temperature vary in relation to the position of the cyclone. During the long dreary winter night the temperature falls to very low readings. Snowstorms and gales alternate at irregular short intervals with calmer spells of more extreme cold and clearer skies. The periods of greatest cold in winter are calm. A wind from any direction will bring a rise in temperature. This probably results from the fact that the cold is the result of local radiation, and a wind interferes with these conditions by importing higher temperatures, or by mixing upper and lower strata. During the long summer days the temperature rises well above the winter mean, and under favourable conditions certain phenomena, such as the diurnal variation in wind velocity, for example, give evidence of the diurnal control. But the irregular cyclonic weather changes continue, in a modified form. There is no really warm season. Snow still falls frequently. The summer is essentially only a modified winter, especially in the Antarctic. In summer clear spells are relatively warm, and winds bring

lower temperatures. In spite of its lack of high temperatures, the northern polar summer, near the margins of the zone, has many attractive qualities in its clean, pure, crisp, dry air, free from dust and impurities; its strong insolation; its slight precipitation.

Twilight and Optical Phenomena.—The monotony and darkness of the polar night are decreased a good deal by the long twilight. Light from moon and stars, and from the aurora, also relieves the darkness. Optical phenomena of great variety, beauty and complexity are common. Solar and lunar haloes, and coronae, and mock suns and moons are often seen. Auroras seem to be less common and less brilliant in the Antarctic than in the Arctic. Sunset and sunrise colours within the polar zones are described as being extraordinarily brilliant and impressive.

Physiological Effects.—The north polar summer, as has been pointed out, in spite of its drawbacks, is in some respects a pleasant and healthful season. But the polar night is monotonous, depressing, repelling. Sir W. E. Parry said that it would be difficult to conceive of two things which are more alike than two polar winters. An everlasting uniform snow covering; rigidity; lifelessness; silence—except for the howl of the gale or the cracking of the ice. Small wonder that the polar night has sometimes unbalanced men's minds. The first effects are often a strong desire for sleep, and indifference. Later effects have been sleeplessness and nervousness, tending in extreme cases to insanity; anaemia, digestive troubles. Extraordinarily low winter temperatures are easily borne if the air be dry and still. Zero weather seems pleasantly refreshing if clear and calm. But high relative humidity and wind—even a light breeze—give the same degree of cold a penetrating feeling of chill which may be unbearable. Large temperature ranges are endured without danger in the polar winter when the air is dry. When exposed to direct insolation the skin burns and blisters; the lips swell and crack. Thirst has been much complained of by polar explorers, and is due to the active evaporation from the warm body into the dry, relatively cold air. There is no doubt that polar air is singularly free from micro-organisms—a fact which is due chiefly to lack of communication with other parts of the world. Hence many diseases which are common in temperate zones, "colds" among them, are rare.

Changes of Climate.

Popular Belief in Climatic Change.—Belief in a change in the climate of one's place of residence, within a few generations, and even within the memory of living men, is widespread. Evidence is constantly being brought forward of apparent climatic variations of greater or less amount which are now taking place. Thus we have many accounts of a gradual desiccation which seems to have been going on over a large region in Central Asia during historical times. In northern Africa certain ancient historical records have been taken by different writers to indicate a general decrease of rainfall during the last 3000 or more years. In his crossing of the Sahara between Algeria and the Niger, E. F. Gautier found evidence of a former large population. A gradual desiccation of the region is therefore believed to have taken place, but to-day the equatorial rain belt seems to be again advancing farther north, giving an increased rainfall. Farther south, several lakes have been reported as decreasing in size, e.g. Chad and Victoria; and wells and springs as running dry. In the Lake Chad district A. J. B. Chevalier reports the discovery of vegetable and animal remains which indicate an invasion of the Sudan by a Saharan climate. It is often held that a steady decrease in rainfall has taken place over Greece, Syria and other eastern Mediterranean lands, resulting in a gradual and inevitable deterioration and decay of their people.

What Meteorological Records show.—As concerns the popular impression regarding change of climate, it is clear at the start that no definite answer can be given on the basis of tradition or of general impression. The only answer of real value must be based on the records of accurate instruments, properly exposed and carefully read. When such instrumental records

are carefully examined, from the time when they were first kept, which in a few cases goes back about 150 years, there is found no good evidence of any progressive change in temperature, or in the amount of rain and snow. Even when the most accurate instrumental records are available, care must be taken to interpret them correctly. Thus, if a rainfall or snowfall record of several years at some station indicates an apparent increase or decrease in the amount of precipitation, it does not necessarily follow that this means a permanent, progressive change in climate, which is to continue indefinitely. It may simply mean that there have been a few years of somewhat more precipitation, and that a period of somewhat less precipitation is to follow.

Value of Evidence concerning Changes of Climate.—The body of facts which has been adduced as evidence of progressive changes of climate within historical times is not yet sufficiently large and complete to warrant any general correlation and study of these facts as a whole. But there are certain considerations which should be borne in mind in dealing with this evidence before any conclusions are reached. In the first place, changes in the distribution of certain fruits and cereals, and in the dates of the harvest, have often been accepted as undoubted evidence of changes in climate. Such a conclusion is by no means inevitable, for many changes in the districts of cultivation of various crops have naturally resulted from the fact that these same crops are in time found to be more profitably grown, or more easily prepared for market, in another locality. In France, C. A. Angot has made a careful compilation of the dates of the vintage from the 14th century down to the present time, and finds no support for the view so commonly held there that the climate has changed for the worse. At the present time, the average date of the grape harvest in Aubonne is exactly the same as at the close of the 16th century. After a careful study of the conditions of the date tree, from the 4th century, B.C., D. Eginis concludes that the climate of the eastern portion of the Mediterranean basin has not changed appreciably during twenty-three centuries.

Secondly, a good many of the reports by explorers from little-known regions are contradictory. This shows the need of caution in jumping at conclusions of climatic change. An increased use of water for irrigation may cause the level of water in a lake to fall. Periodic oscillations, giving higher and then lower water, do not indicate progressive change in one direction. Many writers have seen a law in what was really a chance coincidence.

Thirdly, where a progressive desiccation seems to have taken place, it is often a question whether less rain is actually falling, or whether the inhabitants have less capacity and less energy than formerly. Is the change from a once cultivated area to a barren expanse the result of decreasing rainfall, or of the emigration of the former inhabitants to other lands? The difference between a country formerly well irrigated and fertile, and a present-day sandy, inhospitable waste may be the result of a former compulsion of the people, by a strong governing power, to till the soil and to irrigate, while now, without that compulsion, no attempt is made to keep up the work. A region of deficient rainfall, once thickly settled and prosperous, may readily become an apparently hopeless desert, even without the intervention of war and pestilence, if man allows the climate to master him. In many cases the reports of increasing dryness really concern only the decrease in the water supply from rivers and springs, and it is well known that a change in the cultivation of the soil, or in the extent of the forests, may bring about marked changes in the flow of springs and rivers without any essential change in the actual amount of rainfall.

Lastly, a region whose normal rainfall is at best barely sufficient for man's needs may be abandoned by its inhabitants during a few years of deficient precipitation, and not again occupied even when, a few years later, normal or excessive rainfall occurs.

Periodic Oscillations of Climate: Sun-spot Period.—The discovery of a distinct eleven-year periodicity in the magnetic phenomena of the earth naturally led to investigations of similar periods in meteorology. The literature on this subject has assumed large proportions. The results, however, have not been

satisfactory. The problem is difficult and obscure. Fluctuations in temperature and rainfall, occurring in an eleven-year period, have been made out for certain stations but the variations are slight, and it is not yet clear that they are sufficiently marked, uniform and persistent over large areas to make practical application of the periodicity in forecasting possible. In some cases the relation to sun-spot periodicity is open to debate; in others, the results are contradictory.

W. P. Köppen has brought forward evidence of a sun-spot period in the mean annual temperature, especially in the tropics, the maximum temperatures coming in the years of sun-spot minima. The whole amplitude of the variation in the mean annual temperatures, from sun-spot minimum to sun-spot maximum, is, however, only 1.3° in the tropics and a little less than 1° in the extra-tropics. More recently Nordmann (for the years 1870-1900) has continued Köppen's investigation.

In 1872 C. Meldrum, then Director of the Meteorological Observatory at Mauritius, first called attention to a sun-spot periodicity in rainfall and in the frequency of tropical cyclones in the South Indian Ocean. The latter are most numerous in years of sun-spot maxima, and decrease in frequency with the approach of sun-spot minima. Poëy found later a similar relation in the case of the West Indian hurricanes. Meldrum's conclusions regarding rainfall were that, with few exceptions, there is more rain in years of sun-spot maxima. S. A. Hill found it to be true of the Indian summer monsoon rains that there seems to be an excess in the first half of the cycle, after the sun-spot maximum. The winter rains of northern India, however, show the opposite relation; the minimum following, or coinciding with, the sun-spot maximum. Particular attention has been paid to the sun-spot cycle of rainfall in India, because of the close relation between famines and the summer monsoon rainfall in that country. Sir Norman Lockyer and Dr W. J. S. Lockyer have recently studied the variations of rainfall in the region surrounding the Indian Ocean in the light of solar changes in temperature. They find that India has two pulses of rainfall, one near the maximum and the other near the minimum of the sun-spot period. The famines of the last fifty years have occurred in the intervals between these two pulses, and these writers believe that if as much had been known in 1836 as is now known, the probability of famines at all the subsequent dates might have been foreseen.

Relations between the sun-spot period and various other meteorological phenomena than temperature, rainfall and tropical cyclones have been made the subject of numerous investigations, but on the whole the results are still too uncertain to be of any but a theoretical value. Some promising conclusions seem, however, to have been reached in regard to pressure variations, and their control over other climatic elements.

Brückner's 35-Year Cycle.—Of more importance than the results thus far reached for the sun-spot period are those which clearly establish a somewhat longer period of slight fluctuations or oscillations of climate, known as the Brückner cycle, after Professor Brückner of Bern, who has made a careful investigation of the whole subject of climatic changes and finds evidence of a 35-year periodicity in temperature and rainfall. In a cycle whose average length is 35 years, there comes a series of years which are somewhat cooler and also more rainy, and then a series of years which are somewhat warmer and drier. The interval in some cases is twenty years; in others it is fifty. The average interval between two cool and moist, or warm and dry, periods is about 35 years. The mean amplitude of the temperature fluctuation, based on large numbers of data, is a little less than 2° . The fluctuations in rainfall are more marked in interiors than on coasts. The general mean amplitude is 12%, or, excluding exceptional districts, 24%. Regions whose normal rainfall is small are most affected.

The following table shows the dates and characters of Brückner's periods:—

Warm	1746-1755	1791-1805	1821-1835	1851-1870	..
Dry	1756-1770	1781-1805	1826-1840	1856-1870	..
Cold	1731-1745	1756-1790	1806-1820	1836-1850	1871-1885
Wet	1736-1755	1771-1780	1806-1825	1841-1855	1871-1885

Interesting confirmation of Brückner's 35-year period has been found by E. Richter in the variations of the Swiss glaciers, but as these glaciers differ in length, they do not all advance and retreat at the same time. The advance is seen during the cold and damp periods. Brückner has found certain districts in which the phases and epochs of the climatic cycle are exactly reversed. These exceptional districts are almost altogether limited to marine climates. There is thus a sort of compensation between oceans and continents. The rainier periods on the continents are accompanied by relatively low pressures, while the pressures are high and the period dry over the oceans and vice versa. The cold and rainy periods are also marked by a decrease in all pressure differences. It is obvious that changes in the general distribution of atmospheric pressures, over extended areas, are closely associated with fluctuations in temperature and rainfall. These changes in pressure distribution must in some way be associated with changes in the general circulation of the atmosphere, and these again must depend upon some external controlling cause or causes. W. J. S. Lockyer has called attention to the fact that there seems to be a periodicity of about 35 years in solar activity, and that this corresponds with the Brückner period.

It is clear that the existence of a 35-year period will account for many of the views that have been advanced in favour of a progressive change of climate. A succession of a few years wetter or drier than the normal is likely to lead to the conclusion that the change is permanent. Accurate observations extending over as many years as possible, and discussed without prejudice, are necessary before any conclusions are drawn. Observations for one station during the wetter part of a cycle should not be compared with observations for another station during the drier part of the same, or of another cycle.

There are evidences of longer climatic cycles than eleven or 35 years. Brückner calls attention to the fact that sometimes two of his periods seem to merge into one. E. Richter shows much the same thing for the Alpine glaciers. Evidence of considerable climatic changes since the last glacial period is not lacking. But as yet nothing sufficiently definite to warrant general conclusions has been brought forward.

Geological Changes in Climate.—Changes of climate in the geological past are known with absolute certainty to have taken place: periods of glacial invasion, as well as periods of more genial conditions. The evidence, and the causes of these changes have been discussed and re-discussed, by writers almost without number, and from all points of view. Changes in the intensity of insolation; in the sun itself; in the conditions of the earth's atmosphere; in the astronomical relations of earth and sun; in the distribution of land and water; in the position of the earth's axis; in the altitude of the land; in the presence of volcanic dust;—now cosmic, now terrestrial conditions—have been suggested, combated, put forward again. None of these hypotheses has prevailed in preference to others. No actual proof of the correctness of this or that theory has been brought forward. No general agreement has been reached.

Conclusion.—Without denying the possibility, or even the probability, of the establishment of the fact of secular changes, there is as yet no sufficient warrant for believing in considerable permanent changes over large areas. Dufour, after a thorough study of all available evidence, has concluded that a change of climate has not been proved. There are periodic oscillations of slight amount. A 35-year period is fairly well established, but is nevertheless of considerable irregularity, and cannot as yet be practically applied in forecasting. Longer periods are suggested, but not made out. As to causes, variations in solar activity are naturally receiving attention, and the results thus far are promising. But climate is a great complex, and complete and satisfactory explanations of all the facts will be difficult, perhaps impossible, to reach. At present, indeed, the facts which call for explanation are still in most cases but poorly determined, and the processes at work are insufficiently understood. Climate is not absolutely a constant. The pendulum swings to the right and to the left. And its swing is as far to the right as to the left. Each generation lives through a part of

one, or two, or even three oscillations. A snapshot view of these oscillations makes them seem permanent. As Supan has well said, it was formerly believed that climate changes locally, but progressively and permanently. It is now believed that oscillations of climate are limited in time, but occur over wide areas.

LITERATURE.—Scientific climatology is based upon numerical results, obtained by systematic, long continued, accurate meteorological observations. The essential part of its literature is therefore found in the collections of data published by the various meteorological services. The only comprehensive text-book of climatology is the *Handbuch der Klimatologie* of Professor Julius Hann, of the university of Vienna (Stuttgart, 1897). This is the standard book on the subject, and upon it is based much of the present article, and of other recent discussions of climate. The first volume deals with general climatology, and has been translated into English (London and New York, 1903). Reference should be made to this book for further details than are here given. The second and third volumes are devoted to the climates of the different countries of the world. Voeikof's *Die Klimate der Erde* (Jena, 1887) is also a valuable reference book. The standard meteorological journal of the world, the *Meteorologische Zeitschrift* (Braunschweig, monthly), is indispensable to any one who wishes to keep in touch with the latest publications. The *Quarterly Journal of the Royal Meteorological Society* (London), *Symons's Monthly Meteorological Magazine* (London), and the *Monthly Weather Review* (Washington, D.C.) are also valuable. The newest and most complete collection of charts is that in the *Atlas of Meteorology* (London, 1899), in which also there is an excellent working bibliography. For the titles of more recent publications reference may be made to the *International Catalogue of Scientific Literature (Meteorology)*. (R. DE C. W.)

CLIMATE IN THE TREATMENT OF DISEASE.—The most important qualities of the atmosphere in relation to health are (i.) the chemical composition, (ii.) the solids floating in it, (iii.) the mean and extreme temperatures, (iv.) the degree of humidity, (v.) the diathermancy, (vi.) the intensity of light, (vii.) the electrical conditions, (viii.) the density and pressure, and (ix.) the prevailing winds. Generally speaking, the relative purity of the air—i.e. absence of septic solid particles—is an important consideration; while cold acts as a stimulant and tonic, increasing the amount of carbon dioxide exhaled in the twenty-four hours. Different individuals, however, react both to heat and cold very differently. At health resorts, where the temperature may vary between 55° and 70° F., strong individuals gradually lose strength and begin to suffer from various degrees of lassitude; whereas a delicate person under the same conditions gains vigour both of mind and body, puts on weight, and is less liable to disease. And a corresponding intensity of cold acts in the reverse manner in each case. Thus a health resort with a moderate degree of heat is very valuable for delicate or elderly people, and those who are temporarily weakened by illness. Cold, however, when combined with wind and damp must be specially avoided by the aged, the delicate, and those prone to gouty and rheumatic affections. The moisture of the atmosphere controls the distribution of warmth on the earth, and is closely bound up with the prevailing winds, temperature, light and pressure. In dry air the evaporation from both skin and lungs is increased, especially if the sunshine be plentiful and the altitude high. In warm moist air strength is lost and there is a distinct tendency to intestinal troubles. In moist cold air perspiration is checked, and rheumatic and joint affections are very common. The main differences between mountain air and that of the plains depend on the former being more rarefied, colder, of a lower absolute humidity, and offering less resistance to the sun's rays. As the altitude is raised, circulation and respiration are quickened, probably as an effort on the part of the organism to compensate for the diminished supply of oxygen, and somewhat more gradually the number of red blood corpuscles increases, this increase persisting for a considerable time after a return to lower ground. In addition to these changes there is a distinct tendency to diminished proteid metabolism, resulting in an increase of weight owing to the storage of proteid in the tissues. Thus children and young people whose development is not yet complete are especially likely to benefit by the impetus given to growth and the blood-forming organs, and the therapeutic value in their case rarely fails. For older people, however, the benefit depends on whether their organs of circulation and respiration

are sufficiently vigorous to respond to the increased demands on them. For anaemia, pulmonary tuberculosis, pleural thickening, deficient expansion of the lungs, neurasthenia, and the debility following fever and malaria, mountain air is invaluable. But where there is valvular disease of the heart, or rapidly advancing disease of the lungs, it is to be avoided. Light, especially direct sunlight, is of primary importance, the lack of it leading to depression and dyspeptic troubles. Probably its germicidal power accounts for the aseptic character of the air of the Alps, the desert and other places.

Sir Hermann Weber has defined a "good" climate as that in which all the organs and tissues of the body are kept evenly at work in equilibrium with rest. Thus a climate with constant moderate variations in its principal factors is the best for the maintenance of health. But the best climate for an invalid depends on the particular weakness from which he may suffer. Pulmonary tuberculosis stands first in the importance of the effects of climate. The continuous supply of pure fresh air is the main desideratum, a cool climate being greatly superior to a congenial one. Exposure to strong winds is harmful, since it increases the tendency to cough and thus leads to loss of body temperature, which is in its turn made up at the expense of increased metabolism. A high altitude, above the pumox and stimulating properties of the air, is of value to many mild or very early cases, but where the disease is extensive, where the heart is weak, or where there is any tendency to anæmia, high altitudes are contra-indicated, and no such patient should be sent higher than some 5000 ft. Where the disease is of long standing, with much expectoration, or accompanied by albuminuria, the patient appears to do best in a humid atmosphere but little above the sea-level. The climate of Egypt is especially suitable for cases complicated with anæmia or bronchitis, but is contra-indicated where there is attendant diarrhoea. Madder and the Canaries are useful when emphysema is present or where there is much irritability of consumption. Bronchitis in young people is best treated by high altitudes, but in older patients by a moist mild climate, except where much expectoration is present.

The influence of atmospheric conditions on the functions of the nose is very marked. Within the ordinary ranges of humidity and temperature the nasal mucous membrane completely saturates the air with aqueous vapour before it reaches the pharynx. In cold and dry mountain climates there is a very free nasal secretion, far beyond what is needed for the saturation of the air, and at low levels the reverse action takes place, the nose becoming "stuffy." The mechanism on which this depends is found in the erectile tissue, and anything favouring the engorgement of the veins, such as weak heart action, chronic bronchitis or kidney troubles, &c., leads to a corresponding rigidity of the nose and sinuses. In addition to barometric and other influences, it has been found that light produces collapse of this tissue, smoke having a similar effect. On this latter effect probably depends the fact that many asthmatics are better in a dry like London than elsewhere, the smoke relieving the congestion of the inferior turbinates of the nose. In the treatment of pathological nasal conditions, all cases of obstruction from whatsoever cause are best in a dry atmosphere, and where there is atrophy and a deficient flow of mucus in a moist atmosphere. If the mucous membrane is irritable a dry sheltered spot on a sandy soil and in the neighbourhood of pine trees is by far the best.

Sensituous children, namely, those in whom the resistance to micro-organisms and their products is low, pre-eminently require sea air, and had better be educated in some seaside place. Where the child is very delicate, with small power of reaction, the winter should be passed on some mild coast resort. Gouty and rheumatic affections require a dry soil and warm dry climate, cold and moist winds being especially injurious.

For heart affections high altitudes are to be avoided, though some physicians make an exception of mineral cases where the compensation is good. Moderate elevations of 500 to 1500 ft. are preferable to the sea-level.

In diseases of the kidneys, a warm dry climate, by stimulating the action of the skin, lessens the work to be done by these organs, and thus is the most beneficial. Extremes of heat and cold and elevated regions are all to be avoided.

CLIMAX, MOEN (c. 555-600 A.D.), ascetic and mystic, also called Scholasticus and Simates. After having spent forty years in a cave at the foot of mount Sinai, he became abbot of the monastery. His life has been written by Daniel, a monk belonging to the monastery of Knithu, on the Red Sea. He derives his name Climax (or Climacus) from his work of the same name (*Κλίμαξ τοῦ Παπαδοῦτου*, ladder to Paradise), in thirty sections, corresponding to the thirty years of the life of Christ. It is written in a simple and popular style. The first part treats of the vices that hinder the attainment of holiness, the second of the virtues of a Christian.

EDITIONS.—J. P. Migne, *Patrologia graeca*, lxxxviii. (including the biography by Daniel; S. Eremites (Constantinople, 1883); see also C. Jerumbacher, *Geschichte der byzantinischen Literatur* (1897); Gas-Striger in Herzog-Hauck, *Realencyklopädie für protestantische Theologie*, Bd. 9 (1900). The *Ladder* has been translated into several foreign languages—into English by Father Robert, Mount St Bernard's Abbey, Leicestershire (1856).

CLIMBING FERN, the botanical genus *Lygodium*, with about twenty species, chiefly in the warmer parts of the Old World, of interest from its climbing habit. The plants have a creeping stem, on the upper face of which is borne a row of leaves. Each leaf has a slender stem-like axis, which twines round a support and bears leaflets at intervals; it goes on growing indefinitely. It is a favourite warm greenhouse plant.

CLINCHANT, JUSTIN (1822-1881), French soldier, entered the army from St Cyr in 1841. From 1847 to 1850 he was employed in the Algerian campaigns, and in 1854 and 1855 in the Crimea. At the assault on the Malakof (Sept. 8th, 1855) he greatly distinguished himself at the head of a battalion. During the 1859 campaign he won promotion to the rank of lieutenant-colonel, and as a colonel he served in the Mexican War. He was made general of brigade in 1866, and led a brigade of the Army of the Rhine in 1870. His troops were amongst those shut up in Metz, and he passed into captivity, but soon escaped. The government of national defence made him general of division and put him at the head of the 20th corps of the Army of the East. He was under Bourbaki during the campaign of the Jura, and when Bourbaki attempted to commit suicide he succeeded to the command (Jan. 23rd, 1871), only to be driven with 50,000 men over the Swiss frontier at Pontarlier. In 1871 Clinchant commanded the 5th corps operating against the Commune. He was military governor of Paris when he died in 1881.

CLINIC; CLINICAL (Gr. *κλινη*, a bed), an adjective strictly connoting association with the bedside, and so used in ecclesiology of baptism of the sick or dying, but more particularly in medicine to characterize its aspect as associated with practice on the living patient. Thus clinical experience is opposed to what is learnt from laboratory research or theoretical considerations. The substantive "clinic" is technically employed for a medical school or class where instruction is given in practical work as illustrated by the examination and treatment of actual cases of disease.

CLINKER. (1) (From an old Dutch word *klinkaard*, from *klinken*, to ring), a hard paving brick, a brick with a vitrified surface, or a fused mass of brick; also the incombustible residue of coal, which occurs, half-fused into hard masses, in grates or furnaces; a fused mass of lava. (2) (From *clinch*, or *clench*, a common Teutonic word, meaning "to fasten together"), a term appearing usually in the form "clinker-built" as opposed to "cravel-built," for a boat whose strakes overlap and are not fastened "flush."

CLINOCLASITE, a rare mineral consisting of the basic copper arsenate $(\text{CuOH})_2\text{AsO}_4$. It crystallizes in the monoclinic form. The word "climb" (O.E. *climban*), meaning strictly to ascend (or similarly descend) by progressive self-impulsion, with some apparent degree of laborious effort and by means of contact with the surface traversed, is connected with the same root as in "cleave" and "cling." For Alpine climbing, &c., see MOUNTAINEERING.

system and possesses a perfect cleavage parallel to the basal plane; this cleavage is obliquely placed with respect to the prism-faces of the crystal, hence the name clinoclase or clinoclasite, from Gr. κλίνειν, to incline, and κλάω, to break. The crystals are deep blue in colour, and are usually radially arranged in hemispherical groups. Hardness 2½-3; specific gravity 4.36. The mineral was formerly found with other copper arsenates in the mines of the St Day district of Cornwall. It has also been found near Tavistock in Devonshire, near Sayda (or Saida) in Saxony, and in the Tintic district of Utah. It is a mineral of secondary origin, having resulted by the decomposition of copper ores and mispickel in the upper part of mineral veins. The corresponding basic copper phosphate, (CuOH)₂PO₄, is the mineral pseudomalachite, which occurs as green botryoidal masses resembling malachite in appearance.

CLINTON, DE WITT (1769-1828), American political leader, was born on the 2nd of March 1769 at Little Britain, Orange county, New York. His father, James Clinton (1736-1812), served as a captain of provincial troops in the French and Indian War, and as a brigadier-general in the American army in the War of Independence, taking part in Montgomery's attack upon Quebec in 1775, unsuccessfully resisting at Fort Montgomery, along the Hudson, in 1777 the advance of Sir Henry Clinton, accompanying General John Sullivan in 1779 in his expedition against the Iroquois in western New York, and in 1781 taking part in the siege of Yorktown, Virginia. De Witt Clinton graduated at Columbia College in 1786, and in 1790 was admitted to the bar. From 1790 to 1795 he was the private secretary of his uncle, George Clinton, governor of New York and a leader of the Republican party. He was a member of the New York assembly from January to April 1798, and in August of that year entered the state senate, serving until April 1802. He at once became a dominant factor in New York politics, and for the next quarter of a century he played a leading rôle in the history of the commonwealth. From 1801 to 1802 and from 1806 to 1807 he was a member of the Council of Appointment, and realizing the power this body possessed through its influence over the selection of a vast number of state, county and municipal officers, he secured in 1801, while his uncle was governor, the removal of a number of Federalist office-holders, in order to strengthen the Republican organization by new appointments. On this account Clinton has generally been regarded as the originator of the "spoils system" in New York; but he was really opposed to the wholesale proscription of opponents that became such a feature of American politics in later years. It was his plan to fill the more important offices with Republicans, as they had been excluded from appointive office during the Federalist ascendancy, and to divide the smaller places between the parties somewhat in accordance with their relative strength.¹ In counties where the Federalists had a majority very few removals were made.

In 1802 Clinton became a member of the United States Senate, but resigned in the following year to become mayor of New York city, an office he held from 1803 to 1807, from 1808 to 1810, and from 1811 to 1815. During his mayoralty he also held other offices, being a member of the state senate from 1806 to 1811 and lieutenant-governor from 1811 to 1813. In 1812, after a congressional caucus at Washington had nominated Madison for a second term, the Republicans of New York, desiring to break up the so-called Virginia dynasty as well as the system of congressional nominations, nominated Clinton for the presidency by a legislative caucus. Opponents of a second war with Great Britain had revived the Federalist organization, and Federalists from eleven states met in New York and agreed to support Clinton, not on account of his war views, which were not in accord with their own, but as a protest against the policy of Madison. In the election Clinton received 89 electoral votes and Madison 128.

As a member of the legislature Clinton was active in securing

¹ In 1801 a state convention adopted an amendment to the constitution giving the council an equal voice with the governor in the matter of appointments; but Clinton, who is often represented as the father of this movement, though chosen as a member of the convention, did not attend its meetings.

the abolition of slavery and of imprisonment for debt, and in perfecting a system of free public schools. In 1810 he was a member of a commission to explore a route for a canal between Lake Erie and the Hudson river, and in 1811 he and Gouverneur Morris were sent to Washington to secure Federal aid for the undertaking, but were unsuccessful. The second war with Great Britain prevented any immediate action by the state, but in 1816 Clinton was active in reviving the project, and a new commission was appointed, of which he became president. His connexion with this work so enhanced his popularity that he was chosen governor by an overwhelming majority and served for two triennial terms (1817-1823). As governor he devoted his energies to the construction of the canal, but the opposition to his administration, led by Martin Van Buren and Tammany Hall, became so formidable by 1822 that he declined to seek a third term. His successful opponents, however, overreached themselves when in 1824 they removed him from the office of canal commissioner. This partisan action aroused such indignation that at the next election he was again chosen governor, by a large majority, and served from 1825 until his death. As governor he took part in the formal ceremony of admitting the waters of Lake Erie into the canal in October 1825, and thus witnessed the completion of a work which owed more to him than to any other man. Clinton died at Albany, N.Y., on the 11th of February 1828. In addition to his interest in politics and public improvements, he devoted much study to the natural sciences; among his published works are a *Memoir on the Antiquities of Western New York* (1818), and *Letters on the Natural History and Internal Resources of New York* (1822).

See J. Renwick's *Life of De Witt Clinton* (New York, 1845); D. Hosack's *Memoir of De Witt Clinton* (New York, 1829); W. W. Campbell's *Life and Writings of De Witt Clinton* (New York, 1849); and H. L. McBain's *De Witt Clinton and the Origin of the Spoils System in New York* (New York, 1907).

CLINTON, GEORGE (1739-1812), American soldier and political leader, was born at Little Britain, Ulster (now Orange) county, New York, on the 26th of July 1739. His father, Charles Clinton (1690-1773), who was born of English parents in Co. Longford, Ireland, emigrated to America in 1729, and commanded a regiment of provincial troops in the French and Indian War. The son went to sea at the age of sixteen, but, finding the sailor's life distasteful, joined his father's regiment and accompanied him as lieutenant in the expedition against Fort Frontenac in 1758. After the war he practised law in his native town and held a number of minor civil offices in Ulster county. From 1768 to 1775 he sat in the New York provincial assembly, and in the controversies with Great Britain zealously championed the colonial cause. In 1774 he was a member of the New York committee of correspondence, and in 1775 was chosen a member of the second Continental Congress. In December of this year he was appointed a brigadier-general of militia by the New York provincial congress, and in the following summer, being ordered by Washington to assist in the defence of New York, he left Philadelphia shortly after voting for the Declaration of Independence, but too soon to attach his signature to that document. He had also been chosen a deputy to the provincial congress (later the state convention) for 1776-1777, but his various other duties prevented his attendance.

General Clinton took part in the battle of White Plains (October 28th, 1776), and later was charged with the defence of the Highlands of the Hudson, where, with De Witt Clinton, in October 1777, he offered a firm but unsuccessful resistance to the advance of Sir Henry Clinton. In March of this year he had been appointed by Congress a brigadier-general in the Continental army, and he thus held two commissions, as the state convention refused to accept his resignation as brigadier-general of militia. So great was Clinton's popularity at this time that at the first election under the new state constitution he was chosen both governor and lieutenant-governor; he declined the latter office, and on the 30th of July 1777 entered upon his duties as governor, which were at first largely of a military nature. In 1780 he took the field and checked the advance of Sir John Johnson and the

Indians in the Mohawk Valley. In his administration Clinton was energetic and patriotic, and though not possessing the intellectual attainments of some of his New York contemporaries, he was more popular than any of them, as is attested by his service as governor for eighteen successive years (1777-1795), and for another triennial term from 1801 to 1804. In the elections of 1780, 1783 and 1786 he had no opponent. In 1800-1801 he was a member of the assembly. In the struggle in New York over the adoption of the Federal Constitution he was one of the leaders of the opposition, but in the state convention of 1788, over which he presided, his party was defeated, and the constitution was ratified. In national politics he was a follower of Thomas Jefferson, and in state politics he led the faction known as "Clintonians," which was for a long time dominant. In 1789, 1792 and 1796 Clinton received a number of votes in the electoral college, but not a sufficient number to secure him the vice-presidency, which was then awarded to the recipient of the second highest number of votes. In 1804, however, after the method of voting had been changed, he was nominated for the vice-presidency by a Congressional caucus, and was duly elected. In 1808 he sought nomination for the presidency, and was greatly disappointed when this went to Madison. He was again chosen as vice-president, however, and died at Washington before the expiration of his term, on the 20th of April 1812. He was buried in the Congressional Cemetery, from which in May 1908 his remains were transferred to Kingston, N.Y. His casting vote in the Senate in 1811 defeated the bill for the renewal of the charter of the Bank of the United States.

The *Public Papers of George Clinton* (6 vols., New York, 1899-1902) have been published by the state of New York.

CLINTON, SIR HENRY (c. 1738-1795), British general, was the son of admiral George Clinton (governor of Newfoundland and subsequently of New York), and grandson of the 6th earl of Lincoln. After serving in the New York militia, he came to England and joined the Coldstream Guards. In 1758 he became captain and lieutenant-colonel in the Grenadier Guards, and in 1760-62 distinguished himself very greatly as an aide-de-camp to Ferdinand of Brunswick in the Seven Years' War. He was promoted colonel in 1762, and after the peace received the colonelcy of a regiment of foot, becoming major-general in 1772. From 1772 to 1784, thanks to the influence of his cousin, the 2nd duke of Newcastle, he had a seat in parliament, first for Boroughbridge and subsequently for Newark, but for the greater part of this time he was on active service in America in the War of Independence. He took part in the battles of Bunker Hill and Long Island, subsequently taking possession of New York. For his share in the battle of Long Island he was made a lieutenant-general and K.B. After Saratoga he succeeded Sir William Howe as commander-in-chief in North America. He had already been made a local general. He at once concentrated the British forces at New York, pursuing a policy of foraying expeditions in place of regular campaigns. In 1779 he invaded South Carolina, and in 1780 in conjunction with Admiral M. Arbuthnot won an important success in the capture of Charleston. Friction, however, was constant between him and Lord Cornwallis, his second in command, and in 1782, after the capitulation of Cornwallis at Yorktown, he was superseded by Sir Guy Carleton. Returning to England, he published in 1783 his *Narrative of the Campaign of 1781 in North America*, which provoked an acrimonious reply from Lord Cornwallis. He was elected M.P. for Launceston in 1790, and in 1794 was made governor of Gibraltar, where he died on the 23rd of December 1795.

His elder son, Sir WILLIAM HENRY CLINTON (1769-1846), entered the British army in 1784, and served in the campaigns of 1793-94 in the Low Countries. In 1796 he became aide-de-camp to the duke of York, and in 1799 he was entrusted with a mission to the Russian army in Italy, returning to the duke in time for the Dutch expedition of 1799. He was promoted colonel in 1801, and took part in the expedition which took possession of Madeira, which he governed up to 1802. His next important service was in 1807, when he went to Sweden on a military mission. Promoted major-general in 1808, he served from 1812 to 1814 in the

Mediterranean and in Catalonia, and in the latter year he commanded against Marshal Suchet. He had become a lieutenant-general in 1813, and in 1815 he was made a G.C.B. He commanded the British troops in Portugal, 1826-28, and was promoted full general in 1830. He died at Cocken hatch, near Royston, Herts, on the 15th of February 1846.

The younger son, Sir HENRY CLINTON (1771-1829), entered the army in 1787 and saw some service with the Prussians in Holland in 1789. He served on the staff of the duke of York in 1793-94, becoming brevet-major in 1794, and lieutenant-colonel of a line regiment in 1796. In 1797-98 he was aide-de-camp to Lord Cornwallis in the Irish rebellion, and in 1799 he was sent with Lord William Bentinck to the Russian headquarters in Italy, being present at the Trebbia, at Novi, and in the fighting about the St Gotthard. During a short period of service in India Clinton distinguished himself at Laswari. He accompanied the Russian headquarters in the Austerlitz campaign, and was adjutant-general to his intimate friend, Sir John Moore, in the Corunna campaign of 1808-9. Promoted major-general in 1810, he returned to the Peninsula to fill a divisional command under Wellington in 1811. His division played a notable part in the capture of the forts at Salamanca and in the battle of Salamanca (1812), and he was given the local rank of lieutenant-general early in 1813. For his conduct at Vitoria he was made a K.B., and he took his part in the subsequent victories of the Nive, Orthes and Toulouse. At the end of the war he was made a lieutenant-general and inspector-general of infantry. Clinton commanded a division with distinction at Waterloo. He died on the 11th of December 1829.

CLINTON, HENRY FYNES (1781-1852), British classical scholar and chronologist, was born at Gamston in Nottinghamshire on the 14th of January 1781. He was descended from Henry, second earl of Lincoln; for some generations his family bore the name of Fynes, but his father resumed the older family name of Clinton in 1821. He was educated at Westminster school and Christ Church, Oxford, where he studied classical literature and history. From 1806 to 1826 he was M.P. for Aldborough. He died at Welwyn, Herts, where he had purchased the residence and estate of the poet Young, on the 24th of October 1852. His reading was extraordinarily methodical (see his *Literary Remains*). The value of his *Fasti*, which set classical chronology on a scientific basis, can scarcely be over-estimated, even though subsequent research has corrected some of his conclusions.

His chief works are: *Fasti Hellenici, the Civil and Literary Chronology of Greece from the 55th to the 124th Olympiad* (1824-1851), including dissertations on points of Greek history and Scriptural chronology; and *Fasti Romani, the Civil and Literary Chronology of Rome and Constantinople from the Death of Augustus to the Death of Heraclius* (1845-1850). In 1851 and 1853 respectively he published epitomes of the above. *The Literary Remains of H. F. Clinton* (the first part of which contains an autobiography written in 1818) were edited by C. J. F. Clinton in 1854.

CLINTON, a city and the county-seat of Clinton county, Iowa, U.S.A., on the Mississippi river, in the extreme eastern part of the state. Pop. (1890) 13,619; (1900) 22,698 (5434 being foreign-born); (1905) 22,756; (1910) 25,577. The great increase during the decade 1890-1900 was partly due to the absorption by Clinton in 1895 of the city of Lyons (pop. in 1890, 5700). Clinton is served by the Chicago & North-Western (which has machine-shops here), the Chicago, Burlington & Quincy, the Chicago, Milwaukee & St Paul, and the Chicago, Rock Island & Pacific railways, and is connected with Davenport by an electric line. The river is spanned here by a railway bridge. A large portion of the city stands between the river and a series of bluffs. Clinton is the seat of Wartburg College (1869), a German Evangelical Lutheran institution, and of the Clinton Business College. Among the public buildings are the city hall, the court-house, the Federal building and the Carnegie library. As a manufacturing centre Clinton has considerable importance; among its manufactures are furniture, blinds, wire-cloth, papier-mâché goods, gas-engines, farm wagons, harness and saddlery, door locks, pressed brick, flour, and glucose products. There is also

a large sugar refinery. The value of the factory product in 1900 was \$6,203,316; in 1905, \$4,906,355. The American Protective Association (A.P.A.), a secret order opposed to Roman Catholicism, was formed here in 1887. The city was founded in 1855 by the Iowa Land Company, and was incorporated first in 1857, and again in 1867, this time under a general law of the state for the incorporation of cities. The county, from which the city took its name, was named in honour of De Witt Clinton.

CLINTON, a township of Worcester county, Massachusetts, U.S.A., in the central part of the state, on the Nashua river, about 15 m. N.N.E. of Worcester. Pop. (1890) 10,424; (1900) 13,667, of whom 5504 were foreign-born; (1910, U. S. census) 13,075. The township is traversed by the Boston & Maine and New York, New Haven & Hartford railways. It contains 7 sq. m. of varied and picturesque hilly country on the E. slope of the highland water-parting between the Connecticut river and the Atlantic. There is charming scenery along the Nashua river, the chief stream. The S.W. corner of the township is now part of an immense water reservoir, the Wachusett dam and reservoir (excavated 1896-1905; circumference, 35.2 m.), on the S. branch of the Nashua, which will hold 63,000 million gallons of water for the supply of the metropolitan region around Boston. On this is situated the village of Clinton, which has large manufactories, among whose products are cotton and woollen fabrics, carpets, wire-cloth, iron and steel, and combs. The textile and carpet mills are among the most famous in the United States. In 1905 the total factory product of the township was valued at \$5,457,865, the value of cotton goods, carpets and wire-work constituting about nine-tenths of the total. The prominence of the township as a manufacturing centre is due to Erastus Brigham Bigelow (1814-1879), one of the incorporators of the Massachusetts Institute of Technology, who devised power-looms for the weaving of a variety of figured fabrics,—coach-lace, counterpanes, gingham, silk brocatel, tapestry carpeting, ingrain and Brussels carpets,—and revolutionized their manufacture. In 1843 he and his brother Horatio N. Bigelow established in Clinton the Lancaster Mills for the manufacture of gingham. From 1845 to 1851 he perfected his loom for the weaving of Brussels and Wilton carpets, the greatest of his inventions; and he established the Bigelow Carpet Mills here. He also invented the loom for the weaving of wire-cloth. It is claimed that the first production in the United States of finished cotton cloths under one roof and under the factory system was not at Waltham in 1816, but at Clinton in 1813; neither place was the first to spin by power, nor the first to produce finished cloths without the factory system. The comb industry dates from the eighteenth century. The first of the modern textile mills were established in 1838 for the manufacture of coach-lace. Clinton was a part of Lancaster, now a small farming township (pop. in 1910, 2464), until 1850, when it was set off as an independent township. The earliest settlement goes back to 1645.

See A. E. Ford, *History of the Origin of the Town of Clinton, Massachusetts, 1653-1865* (Clinton, 1896).

CLINTON, a city and the county-seat of Henry county, Missouri, U.S.A., on the Grand river, 87 m. S.E. of Kansas City. Pop. (1890) 4737; (1900) 5061 (470 being negroes); (1910) 4992. It is served by the St Louis & San Francisco, the Missouri, Kansas & Texas, and the Kansas City, Clinton & Springfield railways. The city is situated on the border of a rolling prairie about 770 ft. above the sea. The vicinity abounds in coal, but is principally agricultural, and Clinton's chief interest is in trade with it. The principal manufactures are flour and pottery. Clinton was laid out in 1836 and was incorporated in 1865.

CLINTON, a village of Oneida county, New York, U.S.A., on the Oriskany Creek, about 9 m. S.W. of Utica. Pop. (1890) 1269; (1900) 1340; (1905) 1315; (1910) 1236. It is served by the New York, Ontario & Western railway, and is connected with Utica by an electric line. Several fine mineral springs in the vicinity have given Clinton some reputation as a health resort. There are iron mines, blast furnaces, and iron smelters. Clinton is the seat of Hamilton College (non-sectarian), which

was opened as the Hamilton Oneida Academy in 1798, and was chartered under its present name in 1812. It was founded by the Rev. Samuel Kirkland (1741-1808), a missionary among the Oneida Indians; its corner-stone was laid by Baron Steuben; its shade trees were furnished by Thomas Jefferson; and its name was received from Alexander Hamilton, one of its early trustees. It had in 1907-1908 20 instructors, 178 students, and a library of 47,000 volumes and 30,000 pamphlets. At Clinton are also excellent minor schools. Litchfield Observatory is connected with the college, and was long in charge of the well-known astronomer, Christian H. F. Peters (1813-1890), who discovered here more than 40 asteroids and made extensive investigations concerning comets. The village was settled about 1786 by pioneers from New England, was named in honour of George Clinton, and was incorporated in 1842.

CLINTONITE, a group of micaceous minerals known as the "brittle micas." Like the micas and chlorites, they are monoclinic in crystallization and have a perfect cleavage parallel to the flat surface of the plates or scales, but differ markedly from these in the brittleness of the laminae; they are also considerably harder, the hardness of chloritoid being as high as 6½ on Mohs' scale. They differ chemically from the micas in containing less silica and no alkalis, and from the chlorites in containing much less water; in many respects they are intermediate between the micas and chlorites.

The following species are distinguished:—

Margarite is a basic calcium aluminium silicate, $H_2CaAl_4Si_2O_{12}$, and is classed by some authors as a lime-mica. It forms white pearly scales, and was at first known as pearl-mica and afterwards as margarite, from *μαργαρίτης*, a pearl. It is a characteristic associate of corundum, of which it is frequently an alteration product (facts which suggested the synonymous names corundellite and emerylite), and is found in the emery deposits of Asia Minor and the Grecian Archipelago, and with corundum at several localities in the United States.

Seybertite, *Brandisite* and *Xanthophyllite* are closely allied species consisting of basic magnesium, calcium and aluminium silicate, and have been regarded as isomorphous mixtures of a silicate ($H_2CaMg_4Si_2O_{12}$) and an aluminate ($H_2CaMg_4Al_2O_{12}$). *Seybertite* (the original clintonite) occurs as reddish-brown to copper-red, brittle, foliated masses in metamorphic limestone at Amity, New York; *brandisite* as yellowish-green hexagonal prisms in metamorphic limestone in the Fassathal, Tirol; *xanthophyllite* as yellow folia and as distinct crystals (waluewite) in chloritic schists in the Urals.

Chloritoid has the formula $H_2(Fe,Mg)Al_2SiO_7$. It forms tabular crystals and scales, with indistinct hexagonal outlines, which are often curved or bent and aggregated in rosettes. The colour is dark grey or green; a characteristic feature is the pleochroism, the pleochroic colours varying from yellowish-green to indigo-blue. Hardness, 6½; specific gravity, 3.4-3.6. It occurs as isolated scales scattered through schistose rocks and phyllites of dynamo-metamorphic origin. The ottrelites of the phyllites and ottrelite-schists of Otterez and other localities in the Belgian Ardennes is a manganiferous variety of chloritoid, but owing to enclosed impurities the analyses differ widely from those of typical chloritoid. (L. J. S.)

CLISSON, OLIVIER DE (1336-1407), French soldier, was the son of the Olivier de Clisson who was put to death in 1343 on the suspicion of having wished to give up Nantes to the English. He was brought up in England, where his mother, Jeanne de Belleville, had married her second husband. On his return to Brittany he took arms on the side of de Montfort, distinguishing himself at the battle of Auray (1364), but in consequence of differences with Duke John IV. went over to the side of Blois. In 1370 he joined Bertrand du Guesclin, who had lately become constable of France, and followed him in all his campaigns against the English. On the death of du Guesclin Clisson received the constable's sword (1380). He fought with the citizens of Ghent, defeating them at Roosebeke (1382), later on commanded the army in Poitou and Flanders (1389), and made an unsuccessful attempt to invade England. On his return to Paris, in 1392,

an attempt was made to assassinate him by Pierre de Craon, at the instigation of John IV. of Brittany. In order to punish the latter, Charles VI., accompanied by the constable, marched on Brittany, but it was on this expedition that the king was seized with madness. The uncles of Charles VI. took proceedings against Clisson, so that he had to take refuge in Brittany. He was reconciled with John IV., and after the duke's death, in 1399, he became protector of the duchy, and guardian of the young princes. He had gathered vast wealth before his death on the 23rd of April 1407.

CLISSON, a town of western France, in the department of Loire-Inférieure, prettily situated at the confluence of the Sèvre Nantaise and the Moine 17 m. S.E. of Nantes by rail. Pop. (1906) 2244. The town gave its name to the celebrated family of Clisson, of which the most famous member was Olivier de Clisson. It has the imposing ruins of their stronghold, parts of which date from the 13th century. The town and castle were destroyed in 1792 and 1793 during the Vendean wars. The sculptor F. F. Lemont afterwards bought the castle, and the town was rebuilt in the early part of the 19th century according to his plans. There are picturesque parks on the banks of the rivers. The Moine is crossed by an old Gothic bridge and by a fine modern viaduct.

CLITHEROE, a market town and municipal borough in the Clitheroe parliamentary division of Lancashire, England, 220 m. N.N.W. from London and 35 m. N. by W. from Manchester, on the Lancashire & Yorkshire railway. Pop. (1901) 11,414. It is finely situated in the valley of the Ribble, at the foot of Pendle Hill, a steep plateau-like mass rising to 1831 ft. The church of St Mary Magdalene, though occupying an ancient site, is wholly modernized. There are a grammar school, founded in 1554, and a technical school. On a rocky elevation commanding the valley stands the keep and other fragments of a Norman castle, but part of the site is occupied by a modern mansion. The industrial establishments comprise cotton-mills, print-works, paper-mills, foundries, and brick and lime works. The corporation consists of a mayor, 4 aldermen and 12 councillors. Area, 2385 acres.

Stonyhurst College, 5 m. S.W. of Clitheroe, is the principal establishment in England for Roman Catholic students. The Jesuits of St Omer, after emigrating to Bruges and Liège, were disorganized by the revolutionary troubles at the close of the 18th century, and a large body came to England, when Thomas Weld, in 1795, conferred his property of Stonyhurst upon them. The fine and extensive buildings, of which the nucleus is a mansion of the 17th century, contain a public school for boys and a house of studies for Jesuit ecclesiastics, while there is a preparatory school at a short distance. Every branch of study is prosecuted, the college including such institutions as an observatory, laboratories and farm buildings.

The Honour of Clitheroe, the name of which is also written Clyderhow and Cletherwoode, was first held by Roger de Poitou, who was almost certainly the builder of the castle, which was dismantled in 1649. He granted it to Robert de Lacy, in whose family it remained with two short intervals until it passed by marriage to Thomas, earl of Lancaster, in 1310. It formed part of the duchy of Lancaster till Charles II. at the Restoration bestowed it on General Monk, from whose family it descended through the house of Montague to that of Buccleuch. The Clitheroe Estate Company are the present lords of the Honour. The first charter was granted about 1283 to the burgesses by Henry de Lacy, second earl of Lincoln, confirming the liberties granted by the first Henry de Lacy, who is therefore sometimes said, although probably erroneously, to have granted a charter about 1147. The 1283 charter was confirmed by Edward III. in 1346, Henry V. in 1413-1414, Henry VIII. in 1542, and James I. in 1604. Of the fairs, those on December 7th to 9th and March 24th to 26th are held under a charter of Henry IV. in 1409. A weekly market has been held on Saturday since the Conqueror's days. In 1558 the borough was granted two members of parliament, and continued to return them till 1832, when the number was reduced to one. Under the Redistribution Act of 1885 the

borough was disfranchised. The municipal government was formerly vested in an in-bailiff and an out-bailiff elected annually from the in and out burgesses. A court-leet and court-baron used to be held half-yearly, but both are now obsolete. The present corporation governs under the Municipal Corporation Act (1837). There was a church or chapel here in early times, and a chaplain is mentioned in Henry II.'s reign.

CLITOMACHUS, Greek philosopher, was a Carthaginian originally named Hasdrubal, who came to Athens about the middle of the 2nd century B.C. at the age of twenty-four. He made himself well acquainted with Stoic and Peripatetic philosophy; but he studied principally under Carneades, whose views he adopted, and whom he succeeded as chief of the New Academy in 129 B.C. He made it his business to spread the knowledge of the doctrines of Carneades, who left nothing in writing himself. Clitomachus' works were some four hundred in number; but we possess scarcely anything but a few titles, among which are *De sustinendis assensionibus* (*Περὶ ἐποχῆς*, "on suspension of judgment") and *Περὶ αἰδέσεων* (an account of various philosophical sects). In 146 he wrote a treatise to console his countrymen after the ruin of their city, in which he insisted that a wise man ought not to feel grieved at the destruction of his country. Cicero highly commends his works and admits his own debt in the *Academics* to the treatise *Περὶ ἐποχῆς*. Parts of Cicero's *De Natura* and *De Divinatione*, and the treatise *De Fato* are also in the main based upon Clitomachus.

See E. Wellmann in Ersch and Gruber's *Allgemeine Encyclopädie*; R. Hirzel, *Untersuchungen zu Ciceros philosophischen Schriften*, i. (1877); Diog. Laërt. iv. 67-92; Cicero, *Acad. Pr.* ii. 31, 32, and *Tusc.* iii. 22; and article ACADEMY, GREEK.

CLITUMNUS, a river in Umbria, Italy, which rises from a very abundant spring by the road between the ancient Spoletium and Trebia, 8 m. from the former, 4 m. from the latter, and after a short course through the territory of the latter town joins the Tinea, a tributary of the Tiber. The spring is well described by Pliny (*Epist.* viii. 8): it was visited by Caligula and by Honorius, and is still picturesque—a clear pool surrounded by poplars and weeping willows. The stream was personified as a god, whose ancient temple lay near the spring, and close by other smaller shrines; the place, therefore, occurs under the name *Sacraria* (the shrines) as a Roman post station. The building generally known as the Tempio di Clitunno, close to the spring, is, however, an ancient tomb, converted into a Christian church in the early middle ages, the decorative sculptures, which are obviously contemporary with those of S. Salvatore at Spoleto, belonging to the 4th or 6th century according to some authorities, to the 12th according to others.

See H. Grisar, *Nuovo bullettino di archeologia cristiana* (Rome, 1895) i. 127; A. Venturi, *Storia dell' arte italiana* (Milan, 1904), iii. 903.

CLIVE, CAROLINE (1801-1873), English authoress, was born in London on the 24th of June 1801, the daughter of Mr Meyssey-Wigley, M.P. for Worcester. She married, in 1840, the Rev. Archer Clive. She published, over the signature "V.," eight volumes of poetry, but is best known as the author of *Paul Ferroll* (1855), a sensational novel, and *Why Paul Ferroll killed his Wife* (1860). She died on the 13th of July 1873, at Whitfield, Herefordshire.

CLIVE, CATHERINE [KITTY] (1711-1785), British actress, was born, probably in London, in 1711. Her father, William Raftor, an Irishman of good family but small means, had held a captain's commission in the French army under Louis XIV. From her earliest years she showed a talent for the stage, and about 1728 became a member of the company at Drury Lane, of which Colley Cibber was then manager. Her first part was that of the page Ismenes ("with a song") in the tragedy *Mithridates*. Shortly afterwards she married George Clive, a barrister and a relative of the 1st Lord Clive, but husband and wife soon separated by mutual consent. In 1731 she definitely established her reputation as a comic actress and singer in Charles Coffey's farce-opera adaptation, *The Devil to Pay*, and from this time she was always a popular favourite. She acted little outside Drury Lane, where in 1747 she became one of the original

members of Garrick's company. She took part, however, in some of the oratorios of Handel, whose friend she was. In 1769, having been a member of Garrick's company for twenty-two years, she quitted the stage, and lived for sixteen years in retirement at a villa at Twickenham, which had been given her some time previously by her friend Horace Walpole. Mrs Clive had small claim to good looks, but as an actress of broad comedy she was unreservedly praised by Goldsmith, Johnson and Garrick. She had a quick temper, which on various occasions involved her in quarrels, and at times sorely tried the patience of Garrick, but her private life remained above suspicion, and she regularly supported her father and his family. She died at Twickenham on the 6th of December 1785. Horace Walpole placed in his garden an urn to her memory, bearing an inscription, of which the last two lines run:

"The comic muse with her retired
And shed a tear when she expired."

See Percy Fitzgerald, *Life of Mrs Catherine Clive* (1888); W. R. Chetwood, *General History of the Stage* (1749); Thomas Davies, *Memoirs of the Life of David Garrick* (1784).

CLIVE, ROBERT CLIVE, BARON (1725-1774), the statesman and general who founded the empire of British India, was born on the 29th of September 1725 at Styche, the family estate, in the parish of Moreton Say, Market Drayton, Shropshire. We learn from himself, in his second speech in the House of Commons in 1773, that as the estate yielded only £500 a year, his father followed the profession of the law also. The Clives, or Clyves, were one of the oldest families in the county of Shropshire, having held the manor of that name in the reign of Henry II. One Clive was Irish chancellor of the exchequer under Henry VIII.; another was a member of the Long Parliament; Robert's father for many years represented Montgomeryshire in parliament. His mother, to whom he was tenderly attached, and who had a powerful influence on his career, was a daughter, and with her sister Lady Sempill co-hired, of Nathaniel Gaskell of Manchester. Robert was their eldest son. With his five sisters, all of whom were married in due time, he ever maintained the most affectionate relations. His only brother survived to 1825.

Young Clive was the despair of his teachers. Sent from school to school, and for only a short time at the Merchant Taylors' school, which then as now had a high reputation, he neglected his books for perilous adventures. But he was not so ignorant as his biographers represent. He could read Horace in after life; and he must have laid in his youth the foundation of that clear and vigorous English style which marked all his despatches, and made Lord Chatham declare of one of his speeches in the House of Commons that it was the most eloquent he had ever heard. From his earliest years, however, his ambition was to lead his fellows; but he never sacrificed honour, as the word was then understood, even to the fear of death. At eighteen he was sent out to Madras as a "factor" or "writer" in the civil service of the East India Company. The detention of the ship in Brazil for nine months enabled him to acquire the Portuguese language, which, at a time when few or none of the Company's servants learned the vernaculars of India, he often found of use. For the first two years of his residence he was miserable. He felt keenly the separation from home; he was always breaking through the restraints imposed on young "writers"; and he was rarely out of trouble with his fellows, with one of whom he fought a duel. Thus early, too, the effect of the climate on his health began to show itself in those fits of depression during one of which he afterwards prematurely ended his life. The story is told of him by his companions, though he himself never spoke of it, that he twice snapped a pistol at his head in vain. His one solace was found in the governor's library, where he sought to make up for past carelessness by a systematic course of study. He was just of age, when in 1746 Madras was forced to capitulate to Labourdonnais during the War of the Austrian Succession. The breach of that capitulation by Dupleix, then at the head of the French settlements in India, led Clive, with others, to escape from the town to the subordinate Fort St David, some 20 m. to the south. There, disgusted with the state of affairs and the purely com-

mercial duties of an East Indian civilian, as they then were, Clive obtained an ensign's commission.

At this time India was ready to become the prize of the first conqueror who to the dash of the soldier added the skill of the administrator. For the forty years since the death of the emperor Aurangzeb, the power of the Great Mogul had gradually fallen into the hands of his provincial viceroys or *subadhar*s. The three greatest of these were the nawab of the Deccan, or south and central India, who ruled from Hyderabad, the nawab of Bengal, whose capital was Murshidabad, and the nawab or wazir of Oudh. The prize lay between Dupleix, who had the genius of an administrator, or rather intriguer, but was no soldier, and Clive, the first of a century's brilliant succession of those "soldier-politicals," as they are called in the East, to whom Great Britain owes the conquest and consolidation of its greatest dependency. Clive successively established British ascendancy against French influence in the three great provinces under these nawabs. But his merit lies especially in the ability and foresight with which he secured for his country, and for the good of the natives, the richest of the three, Bengal. First, as to Madras and the Deccan, Clive had hardly been able to commend himself to Major Stringer Lawrence, the commander of the British troops, by his courage and skill in several small engagements, when the peace of Aix-la-Chapelle (1748) forced him to return to his civil duties for a short time. An attack of the malady which so severely affected his spirits led him to visit Bengal, where he was soon to distinguish himself. On his return he found a contest going on between two sets of rival claimants for the position of viceroy of the Deccan, and for that of nawab of the Carnatic, the greatest of the subordinate states under the Deccan. Dupleix, who took the part of the pretenders to power in both places, was carrying all before him. The British had been weakened by the withdrawal of a large force under Admiral Boscawen, and by the return home, on leave, of Major Lawrence. But that officer had appointed Clive commissary for the supply of the troops with provisions, with the rank of captain. More than one disaster had taken place on a small scale, when Clive drew up a plan for dividing the enemy's forces, and offered to carry it out himself. The pretender, Chanda Sahib, had been made nawab of the Carnatic with Dupleix's assistance, while the British had taken up the cause of the more legitimate successor, Mahommed Ali. Chanda Sahib had left Arcot, the capital of the Carnatic, to reduce Trichinopoly, then held by a weak English battalion. Clive offered to attack Arcot in order to force Chanda Sahib to raise the siege of Trichinopoly. But Madras and Fort St David could supply him with only 200 Europeans and 300 sepoy. Of the eight officers who led them, four were civilians like Clive himself, and six had never been in action. His force had but three field-pieces. The circumstances that Clive, at the head of this handful, had been seen marching during a storm of thunder and lightning, frightened the enemy into evacuating the fort, which the British at once began to strengthen against a siege. Clive treated the great population of the city with so much consideration that they helped him, not only to fortify his position, but to make successful sallies against the enemy. As the days passed on, Chanda Sahib sent a large army under his son and his French supporters, who entered Arcot and closely besieged Clive in the citadel.

Macaulay gives the following brilliant account of the siege:—

"Raja Sahib proceeded to invest the fort, which seemed quite incapable of sustaining a siege. The walls were ruinous, the ditches dry, the ramparts too narrow to admit the guns, and the battlements too low to protect the soldiers. The little garrison had been greatly reduced by casualties. It now consisted of 120 Europeans and 200 sepoy. Only four officers were left, the stock of provisions was scanty, and the commander who had to conduct the defence under circumstances so discouraging was a young man of five and twenty, who had been bred as a book-keeper. During fifty days the siege went on, and the young captain maintained the defence with a firmness, vigilance and ability which would have done honour to the oldest marshal in Europe. The breach, however, increased day by day. Under such circumstances, any troops so scantily provided with officers might have been expected to show signs of insubordination; and the danger was peculiarly great in a force composed of men differing widely from each other in extraction, colour, language.

manners and religion. But the devotion of the little band to its chief surpassed anything that is related of the Tenth Legion of Caesar, or the Old Guard of Napoleon. The sepoys came to Clive, not to complain of their scanty fare, but to propose that all the grain should be given to the Europeans, who required more nourishment than the natives of Asia. The thin gruel, they said, which was strained away from the rice would suffice for themselves. History contains no more touching instance of military fidelity, or of the influence of a commanding mind. An attempt made by the governor of Madras to relieve the place had failed; but there was hope from another quarter. A body of 3000 Mahrattas, half soldiers, half robbers, under the command of a chief named Murari Rao had been hired to assist Mahommed Ali; but thinking the French power irresistible, and the triumph of Chanda Sahib certain, they had hitherto remained inactive on the frontiers of the Carnatic. The fame of the defence of Arcot roused them from their torpor; Murari Rao declared that he had never before believed that Englishmen could fight, but that he would willingly help them since he saw that they had spirit to help themselves. Raja Sahib learned that the Mahrattas were in motion, and it was necessary for him to be expeditious. He first tried negotiations—he offered large bribes to Clive, which were rejected with scorn; he vowed that if his proposals were not accepted, he would instantly storm the fort, and put every man in it to the sword. Clive told him, in reply, with characteristic haughtiness, that his father was a usurper, that his army was a rabble, and that he would do well to think twice before he sent such poltroons into a breach defended by English soldiers. Raja Sahib determined to storm the fort. The day was well suited to a bold military enterprise. It was the great Mahommedan festival, the Muharram, which is sacred to the memory of Husain, the son of Ali. Clive had received secret intelligence of the design, had made his arrangements, and, exhausted by fatigue, had thrown himself on his bed. He was awakened by the alarm, and was instantly at his post. The enemy advanced, driving before them elephants whose foreheads were armed with iron plates. It was expected that the gates would yield to the shock of these living battering-rams. But the huge beasts no sooner felt the English musket balls than they turned round and rushed furiously away, trampling on the multitude which had urged them forward. A raft was launched on the water which filled one part of the ditch. Clive perceiving that his gunners at that post did not understand their business, took the management of a piece of artillery himself, and cleared the raft in a few minutes. Where the moat was dry, the assailants mounted with great boldness; but they were received with a fire so heavy and so well directed, that it soon quelled the courage even of fanaticism and of intoxication. The rear ranks of the English kept the front ranks supplied with a constant succession of loaded muskets, and every shot told on the living mass below. The struggle lasted about an hour; 400 of the assailants fell; the garrison lost only five or six men. The besieged passed an anxious night, looking for a renewal of the attack. But when day broke, the enemy were no more to be seen. They had retired, leaving to the English several guns and a large quantity of ammunition."

In India, we might say in all history, there is no parallel to this exploit of 1751 till we come to the siege of Lucknow in 1857. Clive, now reinforced, followed up his advantage, and Major Lawrence returned in time to carry the war to a successful issue. In 1754 the first of the Carnatic treaties was made provisionally, between T. Saunders, the Company's resident at Madras, and M. Godeheu, the French commander, in which the English protégé, Mahommed Ali, was virtually recognized as nawab, and both nations agreed to equalize their possessions. When war again broke out in 1756, and the French, during Clive's absence in Bengal, obtained successes in the northern districts, his efforts helped to drive them from their settlements. The Treaty of Paris in 1763 formally confirmed Mahommed Ali in the position which Clive had won for him. Two years after, the Madras work of Clive was completed by a firman from the emperor of Delhi, recognizing the British possessions in southern India.

The siege of Arcot at once gave Clive a European reputation. Pitt pronounced the youth of twenty-seven who had done such deeds a "heaven-born general," thus endorsing the generous appreciation of his early commander, Major Lawrence. When the court of directors voted him a sword worth £700, he refused to receive it unless Lawrence was similarly honoured. He left Madras for home, after ten years' absence, early in 1753, but not before marrying Miss Margaret Maskelyne, the sister of a friend, and of one who was afterwards well known as astronomer royal. All his correspondence proves him to have been a good husband and father, at a time when society was far from pure, and scandal made havoc of the highest reputations. In after days, when Clive's uprightness and stern reform of the Company's

civil and military services made him many enemies, a biography of him appeared under the assumed name of *Charles Carraccioli, Gent.* All the evidence is against the probability of its scandalous stories being true. Clive as a young man occasionally indulged in loose or free talk among intimate friends, but beyond this nothing has been proved to his detriment. After he had been two years at home the state of affairs in India made the directors anxious for his return. He was sent out, in 1756, as governor of Fort St David, with the reversion of the government of Madras, and he received the commission of lieutenant colonel in the king's army. He took Bombay on his way, and there commanded the land force which captured Gheria, the stronghold of the Mahratta pirate, Angria. In the distribution of prize money which followed this expedition he showed no little self-denial. He took his seat as governor of Fort St David on the day on which the nawab of Bengal captured Calcutta, and thither the Madras government at once sent him, with admiral Watson. He entered on the second period of his career.

Since, in August 1690, Job Charnock had landed at the village of Sutanati with a guard of one officer and 30 men, the infant capital of Calcutta had become a rich centre of trade. The successive nawabs or viceroys of Bengal had been friendly to it, till, in 1756, Suraj-ud-Dowlah succeeded his uncle at Murshidabad. His predecessor's financial minister had fled to Calcutta to escape the extortion of the new nawab, and the English governor refused to deliver up the refugee. Enraged at this, Suraj-ud-Dowlah captured the old fort of Calcutta on the 20th of June, and plundered it of more than two millions sterling. Many of the English fled to ships and dropped down the river. The 146 who remained were forced into "the Black Hole" in the stifling heat of the sultriest period of the year. Only 23 came out alive. The fleet was as strong, for those days, as the land force was weak. Disembarking his troops some miles below the city, Clive marched through the jungles, where he lost his way owing to the treachery of his guides, but soon invested Fort William, while the fire of the ships reduced it, on the 2nd of January 1757. On the 4th of February he defeated the whole army of the nawab, which had taken up a strong position just beyond what is now the most northerly suburb of Calcutta. The nawab hastened to conclude a treaty, under which favourable terms were conceded to the Company's trade, the factories and plundered property were restored, and an English mint was established. In the accompanying agreement, offensive and defensive, Clive appears under the name by which he was always known to the natives of India, Sabut Jung, or "the daring in war." The hero of Arcot had, at Angria's stronghold, and now again under the walls of Calcutta, established his reputation as the first captain of the time. With 600 British soldiers, 800 sepoys, 7 field-pieces and 500 sailors to draw them, he had routed a force of 34,000 men with 40 pieces of heavy cannon, 50 elephants, and a camp that extended upwards of four miles in length. His own account, in a letter to the archbishop of Canterbury, gives a modest but vivid description of the battle, the importance of which has been overshadowed by Plassey. In spite of his double defeat and the treaty which followed it, the madness of the nawab burst forth again. As England and France were once more at war, Clive sent the fleet up the river against Chandernagore, while he besieged it by land. After consenting to the siege, the nawab sought to assist the French, but in vain. The capture of their principal settlement in India, next to Pondicherry, which had fallen in the previous war, gave the combined forces prize to the value of £130,000. The rule of Suraj-ud-Dowlah became as intolerable to his own people as to the British. They formed a confederacy to depose him, at the head of which was Jafar Ali Khan, his commander-in-chief. Associating with himself Admiral Watson, Governor Drake and Mr Watts, Clive made a treaty in which it was agreed to give the office of viceroy of Bengal, Behar and Orissa to Jafar, who was to pay a million sterling to the Company for its losses in Calcutta and the cost of its troops, half a million to the British inhabitants of Calcutta, £200,000 to the native inhabitants, and £70,000 to its Armenian merchants. Up to this point all is clear. Suraj-ud-Dowlah was

hopeless as a ruler. His relations alike to his master, the merely titular emperor of Delhi, and to the people left the province open to the strongest. After "the Black Hole," the battle of Calcutta, and the treachery at Chandernagore in spite of the treaty which followed that battle, the East India Company could treat the nawab only as an enemy. Clive, it is true, might have disregarded all native intrigue, marched on Murshidabad, and at once held the delta of the Ganges in the Company's name. But the time was not ripe for this, and the consequences, with so small a force, might have been fatal. The idea of acting directly as rulers, or save under native charters and names, was not developed by events for half a century. The political morality of the time in Europe, as well as the comparative weakness of the Company in India, led Clive not only to meet the dishonesty of his native associate by equal dishonesty, but to justify his conduct by the declaration, years after, in parliament, that he would do the same again. It became necessary to employ the richest Bengali trader, Omichund, as an agent between Jafar Ali and the British officials. Master of the secret of the confederacy against Suraj-ud-Dowlah, the Bengali threatened to betray it unless he was guaranteed, in the treaty itself, £300,000. To dupe the villain, who was really paid by both sides, a second, or fictitious treaty, was shown him with a clause to this effect. This Admiral Watson refused to sign; "but," Clive deponed to the House of Commons, "to the best of his remembrance, he gave the gentleman who carried it leave to sign his name upon it; his lordship never made any secret of it; he thinks it warrantable in such a case, and would do it again a hundred times; he had no interested motive in doing it, and did it with a design of disappointing the expectations of a rapacious man." Such is Clive's own defence of the one act which, in a long career of abounding temptations, was of questionable honesty.

The whole hot season of 1757 was spent in these negotiations, till the middle of June, when Clive began his march from Chandernagore, the British in boats, and the sepoy along the right bank of the Hugli. That river above Calcutta is, during the rainy season, fed by the overflow of the Gauges to the north through three streams, which in the hot months are nearly dry. On the left bank of the Bhagirathi, the most westerly of these, 100 m. above Chandernagore, stands Murshidabad, the capital of the Mogul viceroys of Bengal, and then so vast that Clive compared it to the London of his day. Some miles farther down is the field of Plassey, then an extensive grove of mango trees, of which enough yet remains, in spite of the changing course of the stream, to enable the visitor to realize the scene. On the 21st of June Clive arrived on the bank opposite Plassey, in the midst of that outburst of rain which ushers in the south-west monsoon of India. His whole army amounted to 1100 Europeans and 2100 native troops, with 9 field-pieces. The nawab had drawn up 18,000 horse, 50,000 foot and 53 pieces of heavy ordnance, served by French artillerymen. For once in his career Clive hesitated, and called a council of sixteen officers to decide, as he put it, "whether in our present situation, without assistance, and on our own bottom, it would be prudent to attack the nawab, or whether we should wait till joined by some country power?" Clive himself headed the nine who voted for delay; Major (afterwards Sir) Eyre Coote led the seven who counselled immediate attack. But, either because his daring asserted itself, or because, also, of a letter that he received from Jafar Ali, as has been said, Clive was the first to change his mind and to communicate with Major Eyre Coote. One tradition, followed by Macaulay, represents him as spending an hour in thought under the shade of some trees, while he resolved the issues of what was to prove one of the decisive battles of the world. Another, turned into verse by Sir Alfred Lyall, pictures his resolution as the result of a dream. However that may be, he did well as a soldier to trust to the dash and even rashness that had gained Arcot and triumphed at Calcutta, and as a statesman, since retreat, or even delay, would have put back the civilization of India for years. When, after the heavy rain, the sun rose brightly on the 22nd, the 3200 men and the 9 guns crossed the river and took possession of the grove and its tanks of water, while Clive established his head-

quarters in a hunting lodge. On the 23rd the engagement took place and lasted the whole day. Except the 40 Frenchmen and the guns which they worked, the enemy did little to reply to the British cannonade which, with the 30th Regiment, scattered the host, inflicting on it a loss of 500 men. Clive restrained the ardour of Major Kilpatrick, for he trusted to Jafar Ali's abstinence, if not desertion to his ranks, and knew the importance of sparing his own small force. He lost hardly a white soldier; in all 22 sepoys were killed and 50 wounded. His own account, written a month after the battle to the secret committee of the court of directors, is not less unaffected than that in which he had announced the defeat of the nawab at Calcutta. Suraj-ud-Dowlah fled from the field on a camel, secured what wealth he could, and came to an untimely end. Clive entered Murshidabad, and established Jafar Ali in the position which his descendants have ever since enjoyed, as pensioners, but have not infrequently abused. When taken through the treasury, amid a million and a half sterling's worth of rupees, gold and silver plate, jewels and rich goods, and besought to ask what he would, Clive was content with £160,000, while half a million was distributed among the army and navy, both in addition to gifts of £24,000 to each member of the Company's committee, and besides the public compensation stipulated for in the treaty. It was to this occasion that he referred in his defence before the House of Commons, when he declared that he marvelled at his moderation: He sought rather to increase the shares of the fleet and the troops at his own expense, as he had done at Gheria, and did more than once afterwards, with prize of war. What he did take from the grateful nawab for himself was less than the circumstances justified from an Oriental point of view, was far less than was pressed upon him, not only by Jafar Ali, but by the hundreds of native nobles whose gifts Clive steadily refused, and was openly acknowledged from the first. He followed a usage fully recognized by the Company, although the fruitful source of future evils which he himself was again sent out to correct. The Company itself acquired a revenue of £100,000 a year, and a contribution towards its losses and military expenditure of a million and a half sterling. Such was Jafar Ali's gratitude to Clive that he afterwards presented him with the quit-rent of the Company's lands in and around Calcutta, amounting to an annuity of £27,000 for life, and left him by will the sum of £70,000, which Clive devoted to the army.

While busy with the civil administration, the conqueror of Plassey continued to follow up his military success. He sent Major Coote in pursuit of the French almost as far as Benares. He despatched Colonel Forde to Vizagapatam and the northern districts of Madras, where that officer gained the battle of Condore, pronounced by Broome "one of the most brilliant actions on military record." He came into direct contact, for the first time, with the Great Mogul himself, an event which resulted in the most important consequences during the third period of his career. Shah Alam, when *shahzada*, or heir-apparent, quarrelled with his father Alam Gir II., the emperor, and united with the viceroys of Oudh and Allahabad for the conquest of Bengal. He advanced as far as Patna, which he besieged with 40,000 men. Jafar Ali, in terror, sent his son to its relief, and implored the aid of Clive. Major Caillaud defeated the prince's army and dispersed it. Finally, at this period, Clive repelled the aggression of the Dutch, and avenged the massacre of Amboyna, on that occasion when he wrote his famous letter, "Dear Forde, fight them immediately; I will send you the order of council to-morrow." Meanwhile he never ceased to improve the organization and drill of the sepoy army, after a European model, and enlisted into it many Mahomedans of fine physique from upper India. He refortified Calcutta. In 1760, after four years of labour so incessant and results so glorious, his health gave way and he returned to England. "It appeared," wrote a contemporary on the spot, "as if the soul was departing from the government of Bengal." He had been formally made governor of Bengal by the court of directors at a time when his nominal superiors in Madras sought to recall him to their help there. But he had discerned the importance of the province

even during his first visit to its rich delta, mighty rivers and teeming population. It should be noticed, also, that he had the kingly gift of selecting the ablest subordinates, for even thus early he had discovered the ability of young Warren Hastings, destined to be his great successor, and, a year after Plassey, made him resident at the nawab's court.

In 1760, at thirty-five years of age, Clive returned to England with a fortune of at least £300,000 and the quit-rent of £27,000 a year, after caring for the comfort of his parents and sisters, and giving Major Lawrence, his old commanding officer, who had early encouraged his military genius, £500 a year. The money had been honourably and publicly acquired, with the approval of the Company. The amount might have been four times what it was had Clive been either greedy after wealth or ungenerous to the colleagues and the troops whom he led to victory. In the five years of his conquests and administration in Bengal, the young man had crowded together a succession of exploits which led Lord Macaulay, in what that historian termed his "flashy" essay on the subject, to compare him to Napoleon Bonaparte. But there was this difference in Clive's favour, due not more to the circumstances of the time than to the object of his policy—he gave peace, security, prosperity and such liberty as the case allowed of to a people now reckoned at nearly three hundred millions, who had for centuries been the prey of oppression, while Napoleon's career of conquest was inspired only by personal ambition, and the absolutism he established vanished with his fall. During the three years that Clive remained in England he sought a political position, chiefly that he might influence the course of events in India, which he had left full of promise. He had been well received at court, had been made Baron Clive of Plassey, in the peerage of Ireland, had bought estates, and had got not only himself, but his friends returned to the House of Commons after the fashion of the time. Then it was that he set himself to reform the home system of the East India Company, and began a bitter warfare with Mr Sullivan, chairman of the court of directors, whom in the end he defeated. In this he was aided by the news of reverses in Bengal. Vansittart, his successor, having no great influence over Jafar Ali Khan, had put Kasim Ali Khan, the son-in-law, in his place in consideration of certain payments to the English officials. After a brief tenure Kasim Ali had fled, had ordered Walter Reinhardt (known to the Mahommedans as Sumru), a Swiss mercenary of his, to butcher the garrison of 150 English at Patna, and had disappeared under the protection of his brother viceroy of Oudh. The whole Company's service, civil and military, had become demoralized by gifts, and by the monopoly of the inland as well as export trade, to such an extent that the natives were pauperized, and the Company was plundered of the revenues which Clive had acquired for them. The court of proprietors, accordingly, who elected the directors, forced them, in spite of Sullivan, to hurry out Lord Clive to Bengal with the double powers of governor and commander-in-chief.

What he had done for Madras, what he had accomplished for Bengal proper, and what he had effected in reforming the Company itself, he was now to complete in less than two years, in this the third period of his career, by putting his country politically in the place of the emperor of Delhi, and preventing for ever the possibility of the corruption to which the British in India had been driven by an evil system. On the 3rd of May 1765 he landed at Calcutta to learn that Jafar Ali Khan had died, leaving him personally £70,000, and had been succeeded by his son, though not before the government had been further demoralized by taking £100,000 as a gift from the new nawab; while Kasim Ali had induced not only the viceroy of Oudh, but the emperor of Delhi himself, to invade Behar. After the first mutiny in the Bengal army, which was suppressed by blowing the sepoy ringleader from a gun, Major Munro, "the Napier of those times," scattered the united armies on the hard-fought field of Buxar. The emperor, Shah Alam, detached himself from the league, while the Oudh viceroy threw himself on the mercy of the British. Clive had now an opportunity of repeating in Hindustan, or Upper India, what he had accom-

plished for the good of Bengal. He might have secured what are now called the United Provinces, and have rendered unnecessary the campaigns of Wellesley and Lake. But he had other work in the consolidation of rich Bengal itself, making it a base from which the mighty fabric of British India could afterwards steadily and proportionally grow. Hence he returned to the Oudh viceroy all his territory save the provinces of Allahabad and Kora, which he made over to the weak emperor. But from that emperor he secured the most important document in the whole of British history in India up to that time, which appears in the records as "firmaund from the King Shah Aalum, granting the dewany of Bengal, Behar and Orissa to the Company, 1765." The date was the 12th of August, the place Benares, the throne an English dining-table covered with embroidered cloth and surmounted by a chair in Clive's tent. It is all pictured by a Mahommedan contemporary, who indignantly exclaims that so great a "transaction was done and finished in less time than would have been taken up in the sale of a jackass." By this deed the Company became the real sovereign rulers of thirty millions of people, yielding a revenue of four millions sterling. All this had been accomplished by Clive in the few brief years since he had avenged "the Black Hole" of Calcutta. This would be a small matter, or might even be a cause of reproach, were it not that the Company's undisputed sovereignty proved, after a sore period of transition, the salvation of these millions. The lieutenant-governorship of Bengal since Clive's time has grown so large and prosperous that in 1905 it was found advisable to divide it into two separate provinces. But Clive, though thus moderate and even generous to an extent which called forth the astonishment of the natives, had all a statesman's foresight. On the same date he obtained not only an imperial charter for the Company's possession in the Carnatic also, thus completing the work he began at Arcot, but a third firman for the highest of all the lieutenantancies of the empire, that of the Deccan itself. This fact is mentioned in a letter from the secret committee of the court of directors to the Madras government, dated the 27th of April 1768. Still so disproportionate did the British force seem, not only to the number and strength of the princes and people of India, but to the claims and ambition of French, Dutch and Danish rivals, that Clive's last advice to the directors, as he finally left India in 1767, was this: "We are sensible that, since the acquisition of the dewany, the power formerly belonging to the soubah of those provinces is totally, in fact, vested in the East India Company. Nothing remains to him but the name and shadow of authority. This name, however, this shadow, it is indispensably necessary we should seem to venerate." On a wider arena, even that of the Great Mogul himself, the shadow was kept up till it obliterated itself in the massacre of English people in the Delhi palace in 1857; and Queen Victoria was proclaimed, first, direct ruler on the 1st of November 1858, and then empress of India on the 1st of January 1877.

Having thus founded the empire of British India, Clive's painful duty was to create a pure and strong administration, such as alone would justify its possession by foreigners. The civil service was de-orientalized by raising the miserable salaries which had tempted its members to be corrupt, by forbidding the acceptance of gifts from natives, and by exacting covenants under which participation in the inland trade was stopped. Not less important were his military reforms. With his usual tact and nerve he put down a mutiny of the English officers, who chose to resent the veto against receiving presents and the reduction of batta at a time when two Mahratta armies were marching on Bengal. His reorganization of the army, on the lines of that which he had begun after Plassey, and which was neglected during his second visit to England, has since attracted the admiration of the ablest Indian officers. He divided the whole into three brigades, so as to make each a complete force, in itself equal to any single native army that could be brought against it. He had not enough British artillerymen, however, and would not make the mistake of his successors, who trained natives to work the guns, which were turned against the British

with such effect in 1857. It is sufficient to say that after the Mutiny the government returned to his policy, and not a native gunner is now to be found in the Indian army.

Clive's final return to England, a poorer man than he went out, in spite of still more tremendous temptations, was the signal for an outburst of his personal enemies, exceeded only by that which the malice of Sir Philip Francis afterwards excited against Warren Hastings. Every civilian whose illicit gains he had cut off, every officer whose conspiracy he had foiled, every proprietor or director, like Sullivan, whose selfish schemes he had thwarted, now sought their opportunity. He had, with consistent generosity, at once made over the legacy of £70,000 from the grateful Jafar Ali, as the capital of what has since been known as "the Clive Fund," for the support of invalided European soldiers, as well as officers, and their widows, and the Company had allowed 8% on the sum for an object which it was otherwise bound to meet. General John Burgoyne, of Saratoga memory, did his best to induce the House of Commons, in which Lord Clive was now member for Shrewsbury, to impeach the man who gave his country an empire, and the people of that empire peace and justice, and that, as we have seen, without blot on the gift, save in the matter of Omichund. The result, after the brilliant and honourable defences of his career which will be found in Almon's *Debates* for 1773, was a compromise that saved England this time from the dishonour which, when Warren Hastings had to run the gauntlet, put it in the same category with France in the treatment of its public benefactors abroad. On a division the House, by 155 to 95, carried the motion that Lord Clive "did obtain and possess himself" of £234,000 during his first administration of Bengal; but, refusing to express an opinion on the fact, it passed unanimously the second motion, at five in the morning, "that Robert, Lord Clive, did at the same time render great and meritorious services to his country." The one moral question, the one questionable transaction in all that brilliant and tempted life—the Omichund treaty—was not touched.

Only one who can personally understand what Clive's power and services had been will rightly realize the effect on him, though in the prime of life, of the discussions through which he had been dragged. In the greatest of his speeches, in reply to Lord North, he said,—“My situation, sir, has not been an easy one for these twelve months past, and though my conscience could never accuse me, yet I felt for my friends who were involved in the same censure as myself. . . . I have been examined by the select committee more like a sheep-stealer than a member of this House.” Fully accepting that statement, and believing him to have been purer than his accusers in spite of temptations unknown to them, we see in Clive's end the result merely of physical suffering, of chronic disease which opium failed to abate, while the worry and chagrin caused by his enemies gave it full scope. This great man, who did more for his country than any soldier till Wellington, and more for the people and princes of India than any statesman in history, died by his own hand on the 22nd of November 1774 in his fiftieth year.

The portrait of Clive, by Dance, in the council chamber of Government House, Calcutta, faithfully represents him. He was slightly above middle-size, with a countenance rendered heavy and almost sad by a natural fulness above the eyes. Reserved to the many, he was beloved by his own family and friends. His encouragement of scientific undertakings like Major James Rennell's surveys, and of philological researches like Francis Gladwin's, gained him to two honorary distinctions of F.R.S. and LL.D.

His son and successor Edward (1754–1839) was created earl of Powis in 1804, his wife being the sister and heiress of George Herbert, earl of Powis (1755–1801). He is thus the ancestor of the later earls of Powis, who took the name of Herbert instead of that of Clive in 1807.

See Sir A. J. Arbuthnot, *Lord Clive* ("Builders of Great Britain" series) (1899); Sir C. Wilson, *Lord Clive* ("English Men of Action" series) (1890); G. B. Malleson, *Lord Clive* ("Rulers of India" series) (1890); F. M. Holmes, *Four Heroes of India* (1892); C. Caraccioli, *Life of Lord Clive* (1775).

CLOACA, the Latin term given to the sewers laid to drain the low marshy grounds between the hills of Rome. The most important, which drained the forum, is known as the Cloaca Maxima and dates from the 6th century B.C. This was 10 ft. 6 in. wide, 14 ft. high, and was vaulted with three consecutive rings of voussoirs in stone, the floor being paved with polygonal blocks of lava.

CLOCK. The measurement of time has always been based on the revolution of the celestial bodies, and the period of the apparent revolution of the sun, *i.e.* the interval between two consecutive crossings of a meridian, has been the usual standard for a day. By the Egyptians the day was divided into 24 hours of equal length. The Greeks adopted a different system, dividing the day, *i.e.* the period from sunrise to sunset, into 12 hours, and also the night. Whence it followed that it was only at two periods in the year that the length of the hours during the day and night were uniform (see *CALENDAR*). In consequence, those who adopted the Greek system were obliged to furnish their water-clocks (see *CLEPSYDRA*) with a compensating device so that the equal hours measured by those clocks should be rendered unequal, according to the exigencies of the season. The hours were divided into minutes and seconds, a system derived from the sexagesimal notation which prevailed before the decimal system was finally adopted. Our mode of computing time, and our angular measure, are the only relics of this obsolete system.

The simplest measure of time is the revolution of the earth round its axis, which so far as we know is uniform, perfectly regular, and has not varied in speed during any period of human observation. The time of such a revolution is called a sidereal day, and is divided into hours, minutes and seconds. The period of rotation of the earth is practically measured by observations of the fixed stars (see *TIME*), the period between two successive transits of the same star across a meridian constituting the sidereal day. But as the axis of the earth slowly revolves round in a cone, whereby the phenomenon known as the precession of the equinoxes is produced, it follows that the astronomical sidereal day is not the true period of the earth's rotation on its axis, but varies from it by less than a twenty millionth part, a fraction so small as to be inappreciable. But the civil day depends not on the revolution of the earth with regard to the stars, but on its revolution as compared with the position of the sun. Therefore each civil day is on the average longer than a sidereal one by nearly four minutes, or, to be exact, each sidereal day is to an average civil day as .99727 to 1, and the sidereal hour, minute and second are also shorter in like proportion. Hence a sidereal clock has a shorter, quicker-moving pendulum than an ordinary clock.

Ordinary civil time thus depends on the apparent revolution of the sun round the earth. As, however, this is not uniform, it is needful for practical convenience to give it an artificial uniformity. For this purpose an imaginary sun, moving round the earth with the average velocity of the real sun, and called the "mean" sun, is taken as the measure of civil time. The day is divided into 24 hours, each hour into 60 minutes, and each minute into 60 seconds. After that the sexagesimal division system is abandoned, and fractions of seconds are estimated in decimals.

A clock consists of a train of wheels, actuated by a spring or weight, and provided with a governing device which so regulates the speed as to render it uniform. It also has a mechanism by which it strikes the hours on a bell or gong (cp. Fr. *cloche*, Ger. *Glocke*, a bell; Dutch *klok*, bell, clock), whereas, strictly, a *timepiece* does not strike, but simply shows the time.

The earliest clocks seem to have come into use in Europe during the 13th century. For although there is evidence that they may have been invented some centuries sooner, yet until that date they were probably only curiosities. The first form they took was that of the balance clock, the invention of which is ascribed, but on very insufficient grounds, to Pope Sylvester II. in A.D. 996. A clock was put up in a former clock tower at Westminster with some great bells in 1288, out of a fine imposed on a chief-justice who had offended the government, and the motto *Discite justitiam, monili*, inscribed upon it. The bells were sold,

or rather, it is said, gambled away, by Henry VIII. In 1292 a clock in Canterbury cathedral is mentioned as costing £30, and another at St Albans, by R. Wallingford, the abbot in 1326, is said to have been such as there was not in all Europe, showing various astronomical phenomena. A description of one in Dover Castle with the date 1348 on it was published by Admiral W. H. Smyth (1788-1865) in 1851, and the clock itself was exhibited going, in the Scientific Exhibition of 1876. A very similar one, made by Henry de Vick for the French king Charles V. in 1379 was much like the common clocks of the 18th century, except that it had a vibrating balance instead of a pendulum. The works of one of these old clocks still exist in a going condition at the Victoria and Albert Museum. It came from Wells cathedral, having previously been at Glastonbury abbey.

These old clocks had what is called a verge escapement, and a balance. The train of wheels ended with a crown wheel, that is, a wheel serrated with teeth like those of a saw, placed parallel with its axis (fig. 1). These teeth, D, engaged with pallets CB, CA, mounted on a verge or staff placed parallel to the face of the crown wheel. As the crown wheel was turned round the teeth pushed the pallets alternately until one or the other slid past a tooth, and thus let the crown wheel rotate. When one pallet had slipped over a tooth, the other pallet caught a corresponding tooth on the opposite side of the wheel. The verge was terminated by a balance rod placed at right angles to it with a ball at each end. It is evident that when the force of any tooth on the crown wheel began to act on a pallet, it communicated motion to the balance and thus caused it to rotate. This motion would of course be accelerated, not uniformly, but according to some law dependent on the shape of the teeth and pallets. When the motion had reached its maximum, the tooth slipped past the pallet. The other pallet now engaged another tooth on the opposite side of the wheel. The motion of the balls, however, went on and they continued to swing round, but this time they were opposed by the pressure of the tooth. For a time they overcame that pressure, and drove the tooth back, causing a recoil. As, however, every motion if subjected to an adverse acceleration (*i.e.* a retardation) must come to rest, the balls stopped, and then the tooth, which had been forced to recoil, advanced in its turn, and the swing was repeated. The arrangement was thus very like a huge watch balance wheel in which the driving weight acted in a very irregular manner, not only as a driving force, but also as a regulating spring. The going of such clocks was influenced greatly by friction and by the oil on the parts, and never could be satisfactory, for the time varied with every variation in the swing of the balls, and this again with every variation of the effective driving force.

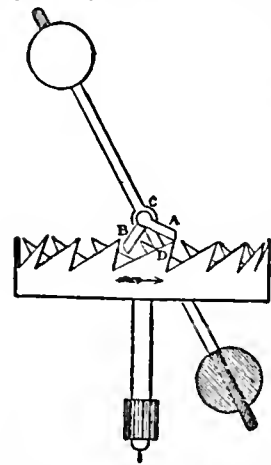

FIG. 1.—Verge Escapement.

The first great step in the improvement of the balance clock was a very simple one. In the 17th century Galileo had discovered the isochronism of the pendulum, but he made no practical use of it, except by the invention of a little instrument for enabling doctors to count their patients' pulse-beats. His son, however, is supposed to have applied the pendulum to clocks. There is at the Victoria and Albert Museum a copy of an early clock, said to be Galileo's, in which the pins on a rotating wheel kick a pendulum outwards, remaining locked after having done so till the pendulum returns and unlocks the next pin, which then administers another kick to the pendulum (fig. 2). The interest of the specimen is that it contains the germ of the

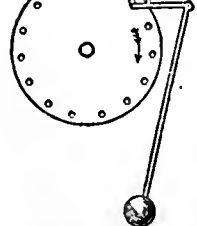

FIG. 2.—Galileo's Escapement.

rotating wheel kick a pendulum outwards, remaining locked after having done so till the pendulum returns and unlocks the next pin, which then administers another kick to the pendulum (fig. 2). The interest of the specimen is that it contains the germ of the

chronometer escapement and free pendulum, which is possibly destined to be the escapement of the future.

The essential component parts of a clock are:—

1. The pendulum or time-governing device;
2. The escapement, whereby the pendulum controls the speed of going;
3. The train of wheels, urged round by the weight or mainspring, together with the recording parts, *i.e.* the dial, hands and hour motion wheels;
4. The striking mechanism.

The general construction of the going part of all clocks, except large or turret clocks, is substantially the same, and fig. 3 is a

section of any ordinary house clock. B is the barrel with the cord coiled round it, generally 16 times for the 8 days; the barrel is fixed to its arbor K, which is prolonged into the winding square coming up to the face or dial of the clock; the dial is here shown as fixed either by small screws *x*, or by a socket and pin *z*, to the prolonged pillars *p*, *p*, which (4 or 5 in number) connect the plates or frame of the clock together, though the dial is commonly set on to the front plate by another set of pillars of its own. The great wheel G rides on the arbor, and is connected with the barrel by the ratchet R, the action of which is shown more fully in fig. 25. The intermediate wheel *r* in this drawing is for a purpose which will be described hereafter, and for the present it may be considered as omitted, and the click of the ratchet R as fixed to the great wheel. The great wheel drives the pinion *c* which is called the centre pinion, on the arbor of the *centre wheel* C, which goes through to the dial, and carries the long, or minute-hand; this wheel always turns in an hour, and the great wheel generally in 12 hours, by having 12 times as many teeth as the centre pinion. The centre wheel drives the "second wheel" D by its pinion *d*, and that again drives the scape-wheel E by its pinion *e*. If the pinions *d* and *e* have each 8 teeth or *leaves* (as the teeth of pinions are usually called), C will have 64 teeth and D 60, in a clock of which the scape-wheel turns in a minute, so that the seconds hand may be set on its arbor prolonged to the dial. A represents the pallets of the escapement, which will be described presently, and their arbor *a* goes through a large hole in the back plate near F, and its back pivot turns in a cock OFQ screwed on to the back plate. From the pallet arbor at F descends the *crutch* Ff, ending in the *fork* f, which embraces the pendulum P, so that as the pendulum vibrates, the crutch and the pallets necessarily vibrate with it. The pendulum is hung by a thin spring S from the cock Q, so that the bending point of the spring may be just opposite the end of the pallet arbor, and the edge of the spring as close to the end of that arbor as possible.

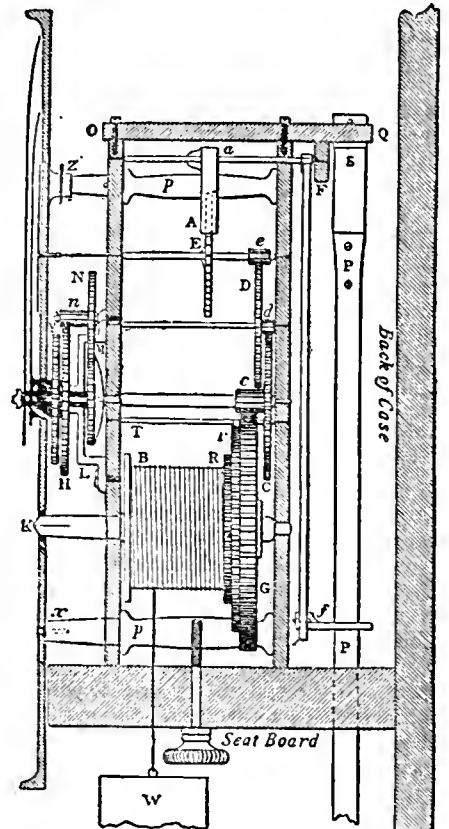

FIG. 3.—Section of House Clock.

We may now go to the front (or left hand) of the clock, and

describe the dial or "motion-work." The minute hand fits on to a squared end of a brass socket, which is fixed to the wheel M, and fits close, but not tight, on the prolonged arbor of the centre wheel. Behind this wheel is a bent spring which is (or ought to be) set on the same arbor with a square hole (not a round one as it sometimes is) in the middle, so that it must turn with the arbor; the wheel is pressed up against this spring, and kept there, by a cap and a small pin through the end of the arbor. The consequence is, that there is friction enough between the spring and the wheel to carry the hand round, but not enough to resist a moderate push with the finger for the purpose of altering the time indicated. This wheel M, which is sometimes called the minute-wheel, but is better called the *hour-wheel* as it turns in an hour, drives another wheel N, of the same number of teeth, which has a pinion attached to it; and that pinion drives the *twelve-hour wheel* H, which is also attached to a large socket or pipe carrying the hour hand, and riding on the former socket, or rather (in order to relieve the centre arbor of that extra weight) on an intermediate socket fixed to the *bridge* L, which is screwed to the front plate over the hour-wheel M. The weight W, which drives the train and gives the impulse to the pendulum through the escapement, is generally hung by a catgut line passing through a pulley attached to the weight, the other end of the cord being tied to some convenient place in the clock frame or *seat-board*, to which it is fixed by screws through the lower pillars.

Pendulum.—Suppose that we have a body P (fig. 4) at rest, and that it is material, that is to say, has "mass." And for simplicity let us consider it a ball of some heavy matter. Let it be free to move horizontally, but attached to a fixed point A by means of a spring.

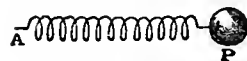

FIG. 4.

As it can only move horizontally and not fall, the earth's gravity will be unable to impart any motion to it. Now it is a law first discovered by Robert Hooke (1635-1703) that if any elastic spring be pulled by a force, then, within its elastic limits, the amount by which it will be extended is proportional to the force. Hence then, if a body is pulled out against a spring, the restitutive force is proportional to the displacement. If the body be released it will tend to move back to its initial position with an acceleration proportioned to its mass and to its distance from rest. A body thus circumstanced moves with harmonic motion, vibrating like a stretched piano string, and the peculiarity of its motion is that it is isochronous. That is to say, the time of returning to its initial position is the same, whether it makes a large movement at a high velocity under a strong restitutive force, or a small movement at a lower velocity under a smaller restitutive force (see MECHANICS). In consequence of this fact the balance wheel of a watch is isochronous or nearly so, notwithstanding variations in the amplitude of its vibrations. It is like a piano string which sounds the same note, although the sound dies away as the amplitude of its vibrations diminishes.

A pendulum is isochronous for similar reasons. If the bob be drawn aside from D to C (fig. 5), then the restitutive force tending to bring it back to rest is approximately the force which gravitation would exert along the tangent CA, i.e.

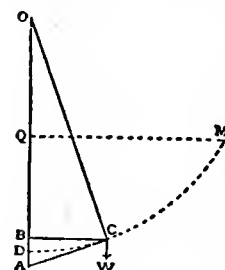

FIG. 5.

$$g \cos ACW = \frac{BC}{OC} = \frac{\text{displacement } BC}{\text{length of pendulum}}$$

Since g is constant, and the length of the pendulum does not vary, it follows that when a pendulum is drawn aside through a small arc the force tending to bring it back to rest is proportional to the displacement (approximately). Thus the pendulum bob under the influence of gravity, if the arc of swing is small, acts as though instead of being acted on by gravity it was acted on by a spring tending to drag it towards D, and therefore is isochronous. The qualification "If the arc of swing is small" is introduced because, as was discovered by Christiaan Huygens, the arc of vibration of a truly isochronous pendulum should

not be a circle with centre O, but a cycloid DM, generated by the rolling of a circle with diameter $DQ = \frac{1}{2}OD$, upon a straight line QM. However, for a short distance near the bottom, the circle so nearly coincides with the cycloid that a pendulum swinging in the usual circular path is, for small arcs, isochronous for practical purposes.

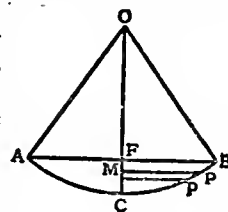

FIG. 6.

The formula representing the time of oscillation of a pendulum, in a circular arc, is thus found:—Let OB (fig. 6) be the pendulum, B be the position from which the bob is let go, and P be its position at some period during its swing. Put $FC = h$, and $MC = x$, and $OB = l$. Now when a body is allowed to move under the force of gravity in any path from a height h , the velocity it attains is the same as a body would attain falling freely vertically through the distance h . Whence if v be the velocity of the bob at P, $v = \sqrt{2gFM} = \sqrt{2g(h-x)}$. Let $Pp = ds$, and the vertical distance of p below P = dx , then $Pp = \text{velocity at P} \times dt$;

$$\text{that is, } dt = ds/v. \text{ Also } \frac{ds}{dx} = \frac{l}{MP} = \frac{l}{\sqrt{x(2l-x)}}$$

$$\text{whence } dt = \frac{ds}{v} = \frac{l dx}{\sqrt{x(2l-x)} \cdot \sqrt{2g(h-x)}} = \frac{l}{2} \sqrt{\frac{l}{g}} \cdot \frac{dx}{\sqrt{x(2l-x)}} \cdot \frac{1}{\sqrt{1-x/2l}}$$

Expanding the second part we have

$$dt = \frac{l}{2} \sqrt{\frac{l}{g}} \cdot \frac{dx}{\sqrt{x(2l-x)}} \cdot \left(1 + \frac{x}{4l} + \dots\right)$$

If this is integrated between the limits of 0 and h , we have

$$t = \pi \sqrt{\frac{l}{g}} \left(1 + \frac{h}{8l} + \dots\right)$$

where t is the time of swing from B to A. The terms after the second may be neglected. The first term, $\pi \sqrt{l/g}$, is the time of swing in a cycloid. The second part represents the addition necessary if the swing is circular and not cycloidal, and therefore expresses the "circular error." Now $h = BC^2/l = 2\pi^2\theta^2/360^2$, where θ is half the angle of swing expressed in degrees; hence $h/8l = \theta^2/52520$, and the formula becomes $t = \pi \sqrt{\frac{l}{g}} \left(1 + \frac{\theta^2}{52520}\right)$.

Hence the ratio of the time of swing of an ordinary pendulum of any length, with a semiarc of swing = θ degrees is to the time of swing of a corresponding cycloidal pendulum as $1 + \theta^2/52520 : 1$. Also the difference of time of swing caused by a small increase θ' in the semiarc of swing = $2\theta\theta'/52520$ second per second, or $3 \cdot 3\theta\theta'$ seconds per day. Hence in the case of a seconds pendulum whose semiarc of swing is 2° an increase of 1° in this semiarc of 2° would cause the clock to lose $3 \cdot 3 \times 2 \times 0 \cdot 1 = \cdot 66$ second a day.

Huygens proposed to apply his discovery to clocks, and since the evolute of a cycloid is an equal cycloid, he suggested the use of a flexible pendulum swinging between cycloidal cheeks. But this was only an example of theory pushed too far, because the friction on the cycloidal cheeks involves more error than they correct, and other disturbances of a higher degree of importance are left uncorrected. In fact the application of pendulums to clocks, though governed in the abstract by theory, has to be modified by experiment.

Neglecting the circular error, if L be the length of a pendulum and g the acceleration of gravity at the place where the pendulum is, then T , the time of a single vibration = $\pi \sqrt{L/g}$. From this formula it follows that the times of vibration of pendulums are directly proportional to the square root of their lengths, and inversely proportional to the square root of the acceleration of gravity at the place where the pendulum is swinging. The value of g for London is $32 \cdot 2$ ft. per second per second, whence it results that the length of a pendulum for London to beat seconds of mean solar time = $39 \cdot 14$ in. nearly, the length of an astronomical pendulum to beat seconds of sidereal time being $38 \cdot 87$ in.

This length is calculated on the supposition that the arc of swing is cycloidal and that the whole mass of the pendulum is concentrated at a point whose distance, called the radius of oscillation, from the point of suspension of the pendulum is $39 \cdot 14$ in. From this it might be imagined that if a sphere, say of iron, were suspended from a light rod, so that its centre were $39 \cdot 14$ in. below its point of support, it would vibrate once per second. This, however, is not the case. For as the pendulum swings, the ball also tends to turn in space to and fro round a horizontal axis perpendicular to the direction of its motion. Hence the force stored up in the pendulum is expended, not only in making it swing, but also in causing the ball to oscillate to and fro through a small angle about a horizontal axis. We have therefore to consider not merely the vibrations of the rod, but the oscillations of the bob. The moment of the momentum of the system round the point of suspension, called its moment of inertia, is composed of the sum of the mass of each particle multiplied into the square of its distance from the axis of rotation. Hence the moment

of inertia of the body $I = \Sigma(ma^2)$. If k be defined by the relation $\Sigma(ma^2) = \Sigma(m) \times k^2$, then k is called the radius of gyration. If k be the radius of gyration of a bob round a horizontal axis through its centre of gravity, h the distance of its centre of gravity below its point of suspension, and k' the radius of gyration of the bob round the centre of suspension, then $k'^2 = h^2 + k^2$. If l be the length of a simple pendulum that oscillates in the same time, then $lh = k'^2 = h^2 + k^2$. Now k can be calculated if we know the form of the bob, and l is the length of the simple pendulum = 39.14 in.; hence h , the distance of the centre of gravity of the bob below the point of suspension, can be found.

In an ordinary pendulum, with a thin rod and a bob, this distance h is not very different from the theoretical length, $l = 39.14$ in., of a simple theoretical pendulum in which the rod has no weight and the bob is only a single heavy point. For the effect of the weight of the rod is to throw the centre of oscillation a little above the centre of gravity of the bob, while the effect of the size of the bob is to throw the centre of oscillation a little down. In ordinary practice it is usual to make the pendulum so that the centre of gravity is about 39 in. below the upper free end of the suspension spring and leave the exact length to be determined by trial.

Since $T = \pi\sqrt{L/g}$, we have, by differentiating, $dL/L = 2dT/T$, that is, any small percentage of increase in L will correspond to double the percentage of increase in T . Therefore with a seconds pendulum, in order to make a second's difference in a day, equivalent to $1/86,400$ of the pendulum's rate of vibration, since there are 86,400 seconds in 24 hours, we must have a difference of length amounting to $2/86,400 = 1/43,200$ of the length of the rod. This is $39.138/43,200 = .000906$ in. Hence if under the pendulum bob be put a nut working a screw of 32 threads to the inch and having its head divided into 30 parts, a turn of this nut through one division will alter the length of the pendulum by .0009 in. and change the rate of the clock by about a second a day. To accelerate the clock the nut has always to be turned to the right, or as you would drive in a corkscrew and vice versa. But in astronomical and in large turret clocks, it is desirable to avoid stopping or in any way disturbing the pendulum; and for the finer adjustments other methods of regulation are adopted. The best is that of fixing a collar, as shown in fig. 7 at C, about midway down the rod, capable of having very small weights laid upon it, this being the place where the addition of any small weight produces the greatest effect, and where, if it may be added, any moving of that weight up or down on the rod produces the least effect. If M is the weight of the pendulum and l its length (down to the centre of oscillation), and m a small weight added at the distance n below the centre of suspension or above the c.o. (since they are reciprocal), t the time of vibration, and $-dt$ the acceleration due to adding m ; then

$$\frac{-dt}{t} = \frac{m}{2M} \left(\frac{n}{l} - \frac{n^2}{l^2} \right)$$

FIG. 7.—Section of Westminster Clock Pendulum.

from which it is evident that if $n = l/2$, then $-dt/t = m/8M$. But as there are 86,400 seconds in a day, $-dT$, the daily acceleration, = $86,400 dt$, or $10800 m/M$, or if m is the 10800th of the weight of the pendulum it will accelerate the clock a second a day, or 10 grains will do that on a pendulum of 15 lb weight (7000 gr. being = 1 lb.), or an ounce on a pendulum of 6 cwt. In like manner if $n = l/3$ from either top or bottom, m must = $M/7200$ to accelerate the clock a second a day. The higher up the collar the less is the risk of disturbing the pendulum in putting on or taking off the regulating weights, but the bigger the weight required to produce the effect. The weights should be made in a series, and marked $\frac{1}{2}$, 1, 2, according to the number of seconds a day by which they will accelerate; and the pendulum adjusted at first to lose a little, perhaps a second a day, when there are no weights on the collar, so that it may always have some weight on, which can be diminished or increased from time to time with certainty, as the rate may vary.

The length of pendulum rods is also affected by temperature and also, if they are made of wood, by damp. Hence, to ensure good time-keeping qualities in a clock, it is necessary (1) to make the rods of materials that are as little affected by such influences as possible, and (2) to provide means of compensation by which the effective length of the rod is kept constant in spite of expansion or contraction in the material of which it is composed. Fairly good pendulums for ordinary use may be made out of very well dried wood, soaked in a thin solution of shellac in spirits of wine, or in melted paraffin wax; but wood shrinks in

so uncertain a manner that such pendulums are not admissible for clocks of high exactitude. Steel is an excellent material for pendulum rods, for the metal is strong, is not stretched by the weight of the bob, and does not suffer great changes in molecular structure in the course of time. But a steel rod expands on the average linearly by .000064 of its length for each degree F. by which its temperature rises; hence an expansion of .00009 in. on a pendulum rod of 39.14 in., that is .000023 of its length, will be caused by an increase of temperature of about 4° F., and that is sufficient to make the clock lose a second a day. Since the summer and winter temperatures of a room may differ by as much as 50° F., the going of a clock may thus be affected by an error of 12 seconds a day. With a pendulum rod of brass, which has a coefficient of expansion of .00001, a clock might gain one-third of a minute daily in winter as compared with its rate in summer. The coefficients of linear expansion per degree F. of some other materials used in making pendulums are as follows: white clay, .0000024; flint glass, .0000048; iron, .000007; lead, .000016; zinc, .000016; and mercury, .000033. The solid or cubical expansions of these bodies are three times the above quantities respectively.

The first method of compensating a pendulum was invented in 1722 by George Graham, who proposed to use a bob of mercury, taking advantage of the high coefficient of expansion of that metal. As now employed, the mercurial pendulum consists of a rod of steel terminating in a stirrup of the same metal on which rests a glass vessel full of mercury, having its centre of gravity about 39 in. below the point of suspension of the pendulum. For each Fahrenheit degree of temperature the centre of gravity of the bob is lowered by the expansion of the rod about $\frac{1}{1000}$ of an inch. The glass vessel and the mercury in it have therefore to be so contrived, that their centre of gravity will rise $\frac{1}{1000}$ in. per degree F. The glass having a small coefficient of expansion, the lateral expansion of the mercury will be checked by it, and this will help to raise the column. For the linear coefficient of expansion of glass is .0000048 per degree F., whence the sectional area of a glass vessel increases by .0000096 per degree F., and therefore the coefficient of vertical expansion of a column of mercury whose volumetric expansion coefficient is .0001 per degree F. is $(.0001 - .0000096) = .0000904$. Let x be the height of the vessel necessary to compensate a steel rod upon the bottom of which it rests. Then, the coefficient of expansion of steel being .000066 per degree F., we have

$$\frac{x}{2} (.0000904 - .0000066) = .000066 \times 39.14, \text{ whence } x = 6\frac{1}{2} \text{ in.}$$

It must, however, be remembered that the glass jar has some weight and that it does not rise by anything like the amount of the mercury. This tends to keep the centre of gravity down. So that the height of mercury of $6\frac{1}{2}$ in. will not be sufficient to effect the compensation, and about $6\frac{1}{2}$ to 7 in. will be required. Some authors specify 7 in.; this is when the diameter of the jar is small. A certain amount of negative compensation must also be deducted to allow for the changes of temperature in the air, as will presently be seen; this amounts in the case of mercury to about $\frac{1}{4}$ in.

In consequence of the complication of all these calculations it is usual to allow about $6\frac{1}{2}$ to 7 in. of mercury in the glass vessel and to adjust the exact amount of mercury by trial.

Another very good form of mercurial pendulum was proposed by E. J. Dent; it consists of a cast-iron jar into the top of which the steel pendulum rod is screwed, having its end plunged into the mercury contained in the jar. By this means the mercury, jar and rod rapidly acquire the same temperature. This pendulum is less likely to break than the form just described. The depth of mercury required in an iron jar is stated by Lord Grimthorpe to be $8\frac{1}{2}$ to 9 in. The reason why it is greater than it is when a glass jar is employed is that iron has a larger coefficient of expansion than glass, and that it is also heavier. In all cases, however, of mercury pendulums experiment seems to be the only ultimate test of the quantity of mercury required, for the results are so complicated by the behaviour of the oil and the barometric errors that at its best the regulation of a clock can only be ultimately a matter of scientifically guided compromise. A small amount of compensation of a purely experimental character is also allowed to compensate the changes which temperature effects on the suspension spring. This is sometimes made as much as $\frac{1}{4}$ of the length correction.

As an alternative to the mercurial pendulum other systems have been employed. The "gridiron" pendulum consists of a group of alternate rods of steel and brass, so arranged that the expansion of the brass acts upwards and counteracts that of the steel downwards. It was invented in 1726 by John Harrison. Assuming that 9 rods are used—5 of steel and 4 of brass—their lengths may be as follows from pin to pin:—Centre steel rod 31.5 in.; 2 steel rods next the centre 24.5 in.; 2 steel rods farthest from centre 29.5 in.; from the lower end of outside steel rods to centre of bob 3 in.; total 89.5 in. Of the 4 brass rods the 2 outside ones are 26.87 in.; and the two inside ones 22.25 in.; total 49.12 in. Thus the expansion of $89\frac{1}{2}$ in. of steel is counteracted by the expansion of $49\frac{1}{2}$ in. of brass. Everything depends, however, on the expansion coefficient of the steel and brass employed, the requirement in every case being that of total lengths of the brass and iron should be in proportion to the linear coefficients of expansion of those metals. The above figures

are for a very soft brass and steel. Thos. Reid, with more ordinary steel and brass, prescribed a ratio of 112 to 71, Lord Grimthorpe a ratio of 100 to 61. It is absolutely necessary to put the actual rods to be used for making the pendulum in a hot water bath, and measure their expansions with a microscope.

John Smeaton, taking advantage of a far greater expansion coefficient of zinc as compared with brass, proposed to use a steel rod with a collar at the bottom, on which rested a hard drawn zinc rod. From this rod hung a steel tube to which the bob was attached. The total length of the steel rod and of the steel tube down to the centre of the bob was made to the total length of the zinc tube, in the ratio of 5 to 2 (being the ratio of the expansions of zinc and steel); for a 39.14 in. pendulum we should therefore want a zinc tube equal in length to $\frac{2}{3}(39.14) = 26\frac{1}{3}$ in. In practice the zinc tube is made about 27 in. long, and then gradually cut down by trial. In fact the weight of a heavy pendulum squeezes the zinc, and it is impossible by mere theory to determine what will be its behaviour. The zinc tube must be of rolled zinc, hard drawn through a die, and must not be cast. Ventilating holes must be made in suitable places in the steel tube and the collar on which it rests, to ensure that changes of temperature are rapidly communicated throughout the system.

A pendulum with a rod of dry varnished deal is tolerably compensated by a bob of lead or of zinc $10\frac{1}{2}$ to 13 in. in height, resting on a nut at the bottom of the rod.

The old methods of pendulum compensation for heat may now be considered as superseded by the invention of "invar," a combination of nickel and steel, due to Charles E. Guillaume, of the International Office of Weights and Measures at Sèvres near Paris.

This alloy has a linear coefficient of expansion on the average of .000001 per degree centigrade, that is to say, only about $\frac{1}{10}$ that of ordinary steel. Hence it can be easily compensated by means of brass, lead or any other suitable metal. Brass is usually employed. In the invar pendulum introduced into Great Britain by Mr Agar Baugh a departure is made from the previous practice of merely calculating the length of the compensator, fastening it to the lower part of the pendulum, and attaching it to the centre of the bob. In the case of these pendulums, accurate computations are made of the moments of inertia of every separate individual part. Thus, for instance, since an addition of volume due to the effect of heat to the upper part of the bob has a different effect upon the moment of inertia from that of an equal quantity added to the lower part of the bob, the bob is suspended not from its centre, but from a point about $\frac{1}{10}$ in. below it, the distance varying according to the shape of the bob, so that the heat expansion of the bob may cause its centre of gravity to rise and compensate the effect of its increased moment of inertia. Again the suspension spring is measured for isochronism, and an alloy of steel prepared for it which does not alter its elasticity with change of temperature. Moreover, since rods of invar steel subjected to strain do not acquire their final coefficients of expansion and elasticity for some time, the invar is artificially "aged" by exposure to strain and heat.

These considerations serve as a guide in arranging for the compensation of the expansion of the rod and bob due to change of temperature. But they are not the only ones required; we have also to deal with changes due to the density of the air in which the pendulum is moving. A body suspended in a fluid loses in weight by an amount equal to the weight of the fluid displaced, whence it follows that a pendulum suspended in air has not the weight which ought truly to correspond to its mass. M remains constant while Mg is less than in a vacuum. If the density of the air remained constant, this loss of weight, being constant, could be allowed for and would make no difference to the time-keeping. The period of swing would only be a little increased over what it would be *in vacuo*. But the weight of a given volume of air varies both with the barometric pressure and also with temperature. If the bob be of type metal it weighs less in air than in a vacuum by about .000103 part, and for each 1° F. rise in temperature (the barometer remaining constant and therefore the pressure remaining the same), the variation of density causes the bob to gain .00000024 of its weight. This, of course, makes the pendulum go quicker. Since the time of vibration varies as the inverse square root of g , it follows that a small increment of weight, the mass remaining constant, produces a diminution of one half that increment in time of swing. Hence, then, a rise of temperature of 1° F. will produce a diminution in the time of swing of .00000012th part or .0104 second in a day. But in making this calculation it has been assumed that the mass moved remains unaltered by the temperature. This is not so. A pendulum when swinging sets in motion a volume of air dependent on the size of the bob, but in a 10 lb bob nearly equal to its own volume. Hence while the rise of 1° of temperature increases the weight by .00000012th part, it also decreases the mass by about the same proportion, and therefore the increase of period due to a rise of temperature of 1° F. will, instead of being .0104 second a day, be about .02 second. This must be compensated negatively by

lengthening the pendulum by about $\frac{.02}{1000}$ in. for each degree of rise of temperature, which will require a piece of brass about 2 in. long. It follows, therefore, that with an invar rod having a linear expansion coefficient of .000002 per degree F., which requires a piece of brass about .8 in. long to compensate it, the compensation which

is to regulate both the expansion of the rod and also that of the air must be .8 in. - 2 in., or -1.2 in.; so that the bob must be hung downwards from a piece of brass nearly $1\frac{1}{2}$ in. in length. If the coefficient of expansion of the invar were .0000053 per degree F., then the two corrections, one for the expansion of the rod and the other for the expansion of the air, would just neutralize one another, and the pendulum rod would require no compensator at all. There are a number of other refinements which might be added, but which are too long for insertion here. By taking in all the sources of error of higher orders, it has been possible to calculate a pendulum so accurately that, when the clock is loaded with the weight sufficient to give the pendulum the arc of swing for which it is designed, a rate of error has been produced of only half a minute in a year. These refinements, however, are only required for clocks of precision; for ordinary clocks an invar pendulum with a lead bob and brass compensator is quite sufficient.

Invar pendulum rods are often made of steel with coefficients of expansion of about .000012 linear per 1° C.; such a bob as this would require about 6.7 cm. of brass to compensate it, and, deducting 5 cm. of brass for the air compensation, this leaves about 1.7 cm. of positive compensation for the pendulum. But as has been said, the exact deduction depends on the shape and size of the bob, and the metal of which it is made. The diameters of the rods are 8 mm. for a 15 lb bob, 5 mm. for a 4 lb bob, and 12 to 15 mm. for a 60 lb bob. The bob is either a single cylinder or two cylinders with the rod between them. Lenticular and spherical bobs are not used. The great object is to allow the air ready access to all parts of the rod and compensator, so that they are all heated or cooled simultaneously. The bobs are usually made of a compound of lead, antimony, and tin, which forms a hard metal, free from bubbles and with a specific gravity of about 10. The usual weight of the bobs of the best pendulums for an ordinary astronomical clock is about 15 lb. A greater weight than this is found liable to make the support of the pendulum rock and to put an undue strain on the parts, without any corresponding advantage. The rods used are all artificially aged, and have their heat expansion measured. No adjusting screw at the bottom is provided, the regulation being done by the addition of weights half way up the rod. An adjusting screw at the bottom has the disadvantage that it is impossible to know on which of the threads the rod is really resting; hence extra compensation may be introduced when not required. It is considered better that the supports of the bob should be rigid and invariable.

The effect of changes in the pressure of the air as shown by a barometer is too important to be omitted in the design of a good clock. But we do not propose to give more than a mere indication of the principles which govern compensation for this effect, since the full discussion of the problem would be too protracted. We have seen that the action of the air in affecting the time of oscillation of a pendulum depends chiefly on the fact that its buoyancy makes the pendulum lighter, so that while the mass of the bob which has to be moved remains the same or nearly the same, the acceleration of gravity on it has less effect. A volume of air at ordinary temperature and pressure has, as has been said, .000103 the weight of an equal volume of type metal, whence it follows that the acceleration of gravity on a type metal bob in air is .999897 of the acceleration of gravity on the bob *in vacuo*. If, therefore, we diminish the value of g in the formula $T = \pi\sqrt{L/g}$ by .000103, we shall have the difference of time of vibration of a type metal bob in air, as compared with its time *in vacuo*, and this, by virtue of the principle used when discussing the increase of time of oscillation due to increased pendulum lengths, is $\frac{1}{2}(.000103)$ second in one second, or about $4\frac{1}{2}$ seconds in a day of 86,400 seconds. It follows that a barometric pressure of 30 in. causes a loss of $4\frac{1}{2}$ seconds in the day, equivalent to .15 second per day for each inch of difference of the barometer. But, as has already been explained, the effect of the mass of the air transported with the pendulum must also be taken into account and therefore the above figures must be doubled or nearly doubled. A difference of 30 in. of barometric pressure would thus make a difference of 9 seconds per day in the rate of the pendulum, and the clock would lose about $\frac{1}{2}$ of a second a day for each inch of rise of the barometer, the result being of the same magnitude as would be produced by a fall of temperature of 15° F. in the air. Either of these effects would require a shortening of the pendulum of $\frac{1}{5000}$ in. This estimate is not far from the truth, for observations taken at various European observatories on various clocks, and collected by Jakob Hilfiker, give a mean of .15 second of retardation per day per centimetre of barometric pressure, or .37 second per day for each inch rise of the barometer.

In order to counteract variations in going which must thus obviously be produced by variations of barometrical pressure, attempts have been made purposely to disturb the isochronism of the pendulum, by making the arcs of vibration abnormally large. Again, the bob has been fitted with a piece of iron, which is subjected to the attraction of a piece of magnetized steel floating on the mercury in the open end of a barometer tube, so that when the barometer falls the attraction is increased and the pendulum retarded. Again, mercury barometers have been attached to pendulums. A simple method is to fix an aneroid barometer with about seven compartments on the pendulum about 5 to 6 in. below the suspension spring,

Barometrical error.

and to attach to the top of it a suitable weight which is lowered as the barometric pressure increases. One of the best methods of neutralizing the effects of variations of barometric pressure is to enclose the whole clock in an air-tight case, which may either be a large glass cylinder or a square case with a stout plate-glass front. This renders it independent of outside variations, whether of temperature or pressure, and keeps the density of the air inside the case uniform. If the case could be completely, or almost completely, exhausted of air, and kept so exhausted, of course the pendulum would experience the minimum of resistance and would have to be lengthened a little. But in practice it is impossible to secure the maintenance of a good vacuum without sealing up the case in such a way as to render repairs very difficult, and this plan is therefore rarely resorted to. What is usually done is to put the clock in a metal case covered with a thick sheet of plate glass bedded in india-rubber strips, and held down by an iron flanged lid or frame firmly fixed by means of small bolts. An air-pump is attached to the case, a turn-off tap being inserted, and by a few strokes the pressure of the air inside the case can be lowered to (say) 29 in., or a little below the usual barometric height at the place where the clock is. The difference of pressure being small, the tendency of air from outside to leak in is also small, and if the workmanship is good the inside pressure will remain unaltered for many days. In any case the difference produced by leakage will be small, and will not greatly affect the going of the clock. With care, and a daily or weekly touch of the pump, the pressure inside can be kept practically constant, and hence the atmospheric error will be eliminated. The cover has also incidentally the effect of keeping damp and fumes from the clock and thus preserving it from rust, especially if a vessel with quicklime or some hygroscopic material be put in the case.

Cases have considerable effect on the air, which moves with a pendulum and is flung off from it at each vibration; the going rate of a chronometer can be altered by removing the case. It is therefore desirable that cases enclosing pendulums should be roomy. Many people prefer to omit the air-tight case, and to keep a record of barometric, thermometric and hygrometric changes, applying corrections based on these to the times shown by the clock.

It was formerly usual to suspend pendulums by means of a single spring about $\frac{1}{2}$ in. wide riveted with chops of metal. The upper chop had a pin driven through it, which rested in grooves so as to allow the pendulum to hang vertically. The best modern pendulums are now made with two parallel springs put a little less than an inch apart. The edges of the chops where the springs enter are slightly rounded so as to avoid too sharp bending of the springs. Suspension of pendulums on knife edges was tried by B. L. Vulliamy and others, but did not prove a success.

It was once thought that lenticular pendulum bobs resisted the air less than those of other shapes, but it was forgotten that their large surface offered more "skin friction." They are now no longer used, nor are spheres on account of difficulty of construction. A cylinder is the best form of bob; it is sometimes rounded at the top and bottom.

Escapements.—The term escapement is applied to any arrangement by which, as the wheels rotate, periodic impulses are given to the pendulum, while at the same time the motion of the wheels is arrested until the vibration of the pendulum has been completed. It thus serves as a mechanism for both counting and impelling. Since the vibrations of a pendulum through small arcs are performed in times independent of the length of the arc, it follows that if a pendulum hanging at rest receive an impulse it will swing out and in again, and the time of its excursion outwards and of its return will remain the same whatever (within limits) be the arc of the swing, and whatever be the impulse given to it. If the impulse is big, it starts with a high velocity, but makes a larger excursion outwards, and the distance it has to travel counteracts its increase of speed, so that its time remains the same. Hence a pendulum, if free to swing outwards and in again, without impediment, will adapt the length of its swing to the impulse it has received, and any interference with it, as by the locking or unlocking of the escapement, will be far less deleterious to its isochronism when such interference occurs at the middle of its path rather than at the ends. It follows that the best escapement will be one which gives an impulse to the pendulum for a short period at the lowest point of its path, and then leaves it quite free to move as it chooses until the time comes for the next impulse.

But a pendulum is not quite truly isochronous, and has its time slightly affected by an increase of its arc; it is therefore desirable that the impulses given to it shall always be equal. If the escapement forms the termination of a clock-train impelled by a weight, the driving force of the escapement is apt to vary

according to the friction of the wheels, while every change in temperature causes a difference in the thickness of the oil. It is therefore desirable, if possible, to secure uniformity of impulse—say, by causing the train of wheels to lift up a certain specified weight, and let it drop on the pendulum at regular intervals, or by some equivalent method.

The two requirements above stated have given rise respectively to what are known as detached escapements, and remontoires, which will be described presently. In the first place, however, it is desirable to describe the principal forms of escapement in ordinary use.

The balance escapement, which has been already mentioned, was in use before the days of pendulums. It was to a balance escapement that Huygens applied the pendulum, by removing the weight from one arm and increasing the length of the other arm.

Balance escapement.

Very shortly afterwards R. Hooke invented the anchor or recoil escapement. This is represented in fig. 8, where a tooth of the escape-wheel is just escaping from the right pallet, and another tooth at the same time falls upon the left-hand pallet at some distance from its point. As the pendulum moves on in the same direction, the tooth slides farther up the pallet, thus producing a recoil, as in the crown-wheel escapement. The acting faces of the pallets should be convex. For when they are flat, and of course still more when they are concave, the points of the teeth always wear a hole in the pallets at the extremity of their usual swing, and the motion is obviously easier and therefore better when the pallets are made convex; in fact, they then approach more nearly to the "dead" escapement, which will be described presently. The effect of some escapements is not only to counteract the circular error, or the natural increase of the time of a pendulum as the arc increases, but to over-balance it by an error of the contrary kind. The recoil escapement does so; for it is almost invariably found that whatever may be the shape of these pallets, the clock loses as the arc of the pendulum falls off, and vice versa. It is unfortunately impossible so to arrange the pallets that the circular error may be thus exactly neutralized, because the escapement error depends, in a manner reducible to no law, upon variations in friction of the pallets themselves and of the clock train, which produce different effects; and the result is that it is impossible to obtain very accurate time-keeping from any clock of this construction. The point in which the anchor escapement was superior to all that had gone before, was that it would work well with a small arc of swing of the pendulum. The balance escapement, even when adapted to a pendulum, necessitated a swing of some 20°, and hence the circular error, that is to say, the deviation of the path from a true cycloid, was considerable. But with an anchor escapement the pendulum swing need be only 3° or 4°. On the other hand, it violates the conditions above laid down for a perfect escapement, inasmuch as the pendulum is never free, but at the end of its swing is still operated on by the escapement, which it causes to recoil.

Anchor escapement.

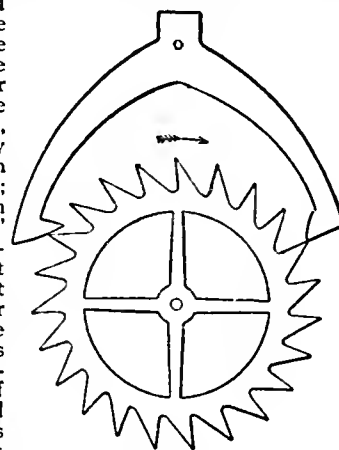

FIG. 8.—Anchor or Recoil Escapement.

It is unfortunately impossible so to arrange the pallets that the circular error may be thus exactly neutralized, because the escapement error depends, in a manner reducible to no law, upon variations in friction of the pallets themselves and of the clock train, which produce different effects; and the result is that it is impossible to obtain very accurate time-keeping from any clock of this construction. The point in which the anchor escapement was superior to all that had gone before, was that it would work well with a small arc of swing of the pendulum. The balance escapement, even when adapted to a pendulum, necessitated a swing of some 20°, and hence the circular error, that is to say, the deviation of the path from a true cycloid, was considerable. But with an anchor escapement the pendulum swing need be only 3° or 4°. On the other hand, it violates the conditions above laid down for a perfect escapement, inasmuch as the pendulum is never free, but at the end of its swing is still operated on by the escapement, which it causes to recoil.

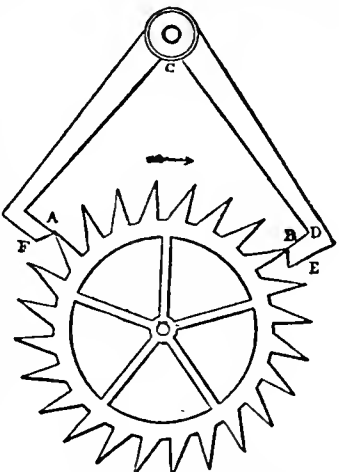

FIG. 9.—Dead Escapement.

To get rid of this defect the dead escapement, or, as the French call it, *l'échappement à repos*, was invented by G. Graham. It is represented in fig. 9. It will be observed that the teeth of the scape-wheel have their points set the opposite way to those of the recoil escapement. The tooth B is here represented in the act of dropping on to the right-hand pallet as the

Dead escapements.

tooth A escapes from the left pallet. But instead of the pallet having a continuous face as in the recoil escapement, it is divided into two, of which BE on the right pallet, and FA on the left, are called the impulse faces, and BD, FG, the dead faces. The dead faces are portions of circles (not necessarily of the same circle), having the axis of the pallets C for their centre; and the consequence evidently is, that as the pendulum goes on, carrying the pallet still nearer to the wheel than the position in which a tooth falls on to the corner A or B of the impulse and the dead faces, the tooth still rests on the dead faces without any recoil, until the pendulum returns and lets the tooth slide down the impulse face, giving the impulse to the pendulum as it goes. In order to diminish the friction and the necessity for using oil as far as possible, the best clocks are made with jewels (sapphires are the best for the purpose) let into the pallets.

The pallets are generally made to embrace about one-third of the circumference of the wheel, and it is not at all desirable that they should embrace more; for the longer they are, the longer is the run of the teeth upon them, and the greater the friction. In some clocks the seconds hand moves very slowly and rests a very short time; this shows that the impulse is long in proportion to the arc of swing. In others the contrary is the case. A not uncommon proportion is that out of a total arc of swing of 3° , 2° , or about one degree on each side of the vertical, are occupied in receiving the impulse. In other words, the points F and A should subtend an angle of 2° at the centre C. It is not to be forgotten that the scape-wheel tooth does not overtake the face of the pallet immediately, on account of the moment of inertia of the wheel. The wheels of astronomical clocks, and indeed of all English house clocks, are generally made too heavy, especially the scape-wheel, which, by increasing the moment of inertia, causes a part of the work to be lost in giving blows, instead of being all used up in gentle pushes.

A very useful form of the dead escapement, which is adopted in many of the best turret clocks, is called the "pin-wheel escapement." Fig. 10 will sufficiently explain its action and construction. Its advantages are—that it does not require so much accuracy as the other; if a pin gets broken it is easily replaced, whereas in the other the wheel is ruined if the point of a tooth is injured; a wheel of given size will work with more pins than teeth, and therefore a train of less velocity will do, and that sometimes amounts to a saving of one wheel in the train, and a good deal of friction; and the blow on both pallets being downwards, instead of one up and the other down, the action is more steady; all which things are of more consequence in the heavy and rough work of a turret clock than in an astronomical one. It has been found expedient to make the dead faces not quite dead, but with a very slight recoil, which rather tends to check the variations of arc, and also the general disposition to lose time if the arc is increased; when so made the escapement is generally called "half-dead."

FIG. 10.—Pin-Wheel Escapement.

In the dead escapement, during each excursion of the pendulum the repose surface of the pallets rubs against the points of the teeth of the scape-wheel. Thus the pendulum is subject to a constant retardation by friction. Curiously enough, this friction, which at first sight might appear a defect, is an advantage, and to a large extent accounts for the excellence of the escapement. For if the driving force of the clock is increased so that the impulse on the pallets is greater, the velocity of the pendulum is increased. But this very increase of the driving force causes a greater pressure of the teeth of the scape-wheel on the rest-faces of the pallets, and hence counteracts the increased drive of the pendulum by an increased frictional retardation. If the clock weight be enormously increased, the frictional retardation becomes increased relatively in a greater proportion than the drive, so that as the weight of the clock is increased the pendulum's time of vibration is first diminished, until at last a neutral point is reached and finally the increased loading of the clock weight begins to make the time of vibration increase again. It is the neutral point which it is desirable to arrange for, and only trial and experience can so fit the shape and size of the pallets, scape-wheel and clock weight to one another, as to secure that a moderate variation of the driving power neither accelerates nor retards the motion of the pendulum, while at the same time such an arc of vibration is secured as shall be least subject to barometric error, and not have too great a circular error. The celebrated clockmaker B. L. Vulliamy (1780–1854) greatly improved Graham's escapement by careful experiment, and other makers introduced further improvements into the shape of the scape-wheel and pallets, so that the best form of the deadbeat escapement is now fairly well determined and is given in books upon horology. For small clocks a little slope is given to the rest-faces so as to

diminish the friction retardation. This is known as the half-dead escapement. The pin-wheel escapement, if properly constructed, is also "dead," that is to say, the outward swing of the pendulum is unfettered except by the slight friction of the teeth against the dead faces of the pallets.

In order to diminish the effect of the impact of the scape-wheel on the pallets, and of the crutch on the pendulum rod, the plan has been tried of making the crutch into an elastic spring. In theory this of course would not destroy the isochronism of the pendulum, for it would only be to apply upon the pendulum a force at right angles to the rod, and varying as the displacement. Hence any acceleration given by such a spring would, like the action of gravity, be harmonic, and it is an analytical principle that harmonic motions superposed on one another still remain harmonic. Hence, then, the action of a spring superadded upon the action of gravity on a pendulum still leaves the motion harmonic. But changes of temperature would affect the spring considerably. In the case of such a spring the repose faces of Graham's escapement might be minimized and the escapement checked each side by a stop, so as to prevent the pallets from rubbing on the points of the scape-wheel. Graham's escapement can, if well made, be arranged so as not to vary more than an average of $\frac{1}{10}$ of a second from its mean daily rate, and this is so good a result that many people doubt whether further effort in the direction of inventing new escapements will result in any better form. Two adaptations of Graham's escapement have been made,

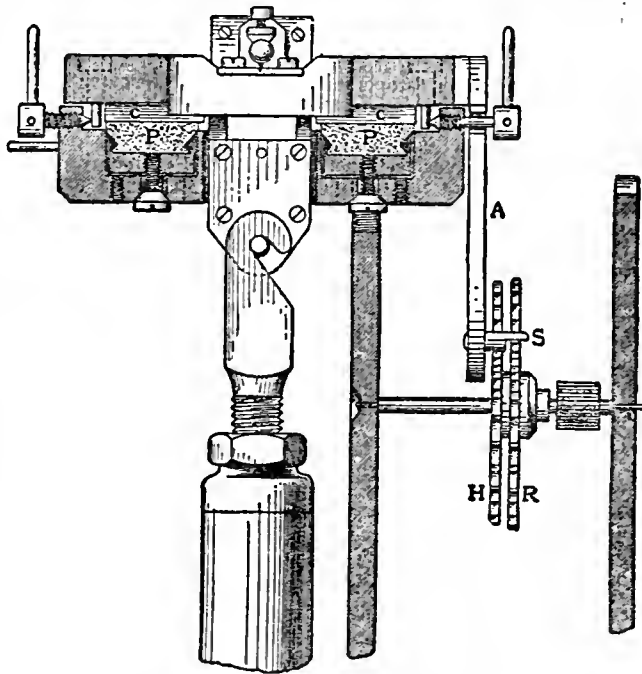

FIG. 11.—Riefler's Escapement.

one by Clemens Riefler of Nesselwang, and the other by L. Strasser of Glashütte, Saxony, which give good results in practice. Riefler's scheme is to mount the upper block, into which the suspension spring is fastened, upon knife edges, and rock it to and fro by the action of a modified Graham's escapement, thus giving impulses to the pendulum. Fig. 11 shows the arrangement. PP are the agates upon which the knife edges CC rest. A is the anchor, RH the scape-wheels, and S the pallets.

Strasser's clock is arranged on the same idea as that of Riefler, only that the rocking motion is given, not to the springs that carry the pendulum, but to a second pair of springs placed outside of them and parallel to them. The weight of the pendulum is therefore carried by an upper stationary block, but above that a second block is subjected to the rocking motion of the anchor. The general design is shown in fig. 12. The pallets are each formed of two stones, so contrived as to minimize the banging of the teeth of the scape-wheel. Both Riefler's and Strasser's clocks aim at having a virtually free pendulum; in fact, they are in reality adaptations of the principle of the spring-clutch to Graham's escapement. The weak point in both is the tampering with the suspension.

The dead escapement is not, however, truly free. In order to make a free escapement it would be necessary to provide that as soon as the pendulum approached its centre position, some pin or projecting point upon it should free the escapement wheel, a tooth of which should thus be enabled to leap upon the back of the pendulum, give it a short push, and then be locked until the pendulum had returned and again swung forward. An arrangement of this kind is shown in fig. 13. Let A be a block of metal fixed on the lower end of a pendulum rod. On the block let a small pall B be fastened, free to move round a

*Detached
escape-
ment.*

centre C and resting against a stop D. Let E be a 4-leaved scape-wheel, the teeth of which as they come round rest against the bent pall GFL at G. The pall is prevented from flying too far back by a pin H, and kept up to position by a very delicate spring K. As soon

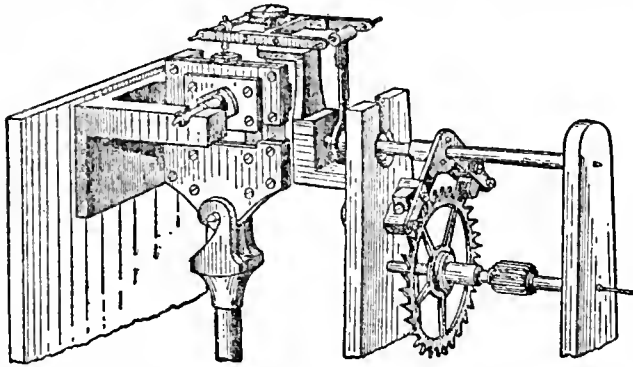

FIG. 12.—Strasser's Escapement (Strasser & Rohde).

as the pendulum rod, moving from left to right, has arrived at the position shown in the figure, the pall B will engage the arm FL, force it forwards, and by raising G will liberate the scape-wheel, a tooth of which, M, will thus close upon the heel N of the block A, and urge it forward. As soon, however, as N has arrived at G the tooth M will slip off the block A and rest on the pall G, and the impulse will cease. The pendulum is now perfectly free or "detached," and can swing on unimpeded as far as it chooses. On its return from right to left, the pall B slips over the pall L without disturbing it, and the pendulum is still free to make an excursion towards the left. On its return journey from left to right the process is again repeated. Such an escapement operates once every 2 seconds. One made on a somewhat similar plan was applied to a clock by Robert-Houdin, about 1830, and afterwards by Mr Haswell, and another by Sir George Airy.

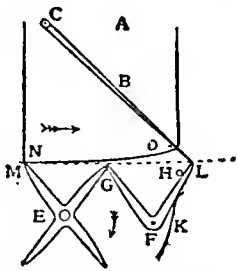

FIG. 13.—Free Escapement.

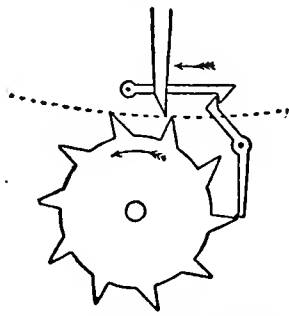

FIG. 14.—Free Escapement (old form).

But the principle was already an old one, as maybe seen from fig. 14, which was the work of an anonymous maker in the 18th century. A consideration of this escapement will show that it is only the application of the detached chronometer escapement to a clock.

Even detached escapements, however, are not perfect. In order that an escapement should be perfect, the impulse given to the pendulum should be always exactly the same. It may be asked why, if the time of oscillation of the pendulum be independent of the amplitude of the arc of vibration, and hence of the impulse, it is necessary that the impulse should be uniform. The answer is that the arc of vibration not being a true cycloid, as it should be if true isochronism is to be secured, but being the arc of a circle, any change of amplitude of vibration produces a change of time in the swing given by the formula $\frac{2}{3}(a^2 - b^2) = \text{loss in seconds per day}$, where a and b are the semi-arcs of vibration estimated in degrees. Thus 10' increase of arc in a swing of 4° , that is to say, .1 in. increase of arc in a total arc of $2\frac{1}{2}$ in., produces an error of about a second a day. Now cold weather, by making the oil thick and thus clogging the wheels, will easily produce such a change of arc; dust will also make a change even though the clock weight, acted on by gravity, still exerts a uniform pull. Besides, if the clock has work to do of a varying amount—as when the hands of a turret clock are acted on by a heavy wind pressure tending sometimes to retard them, sometimes to drive them on—then it is clear that the impulses given by the scape-wheel to the pendulum may be very unequal, and that the arc of vibration of the pendulum may thus be seriously affected and its isochronism disturbed.

To abolish errors arising from the changes in the force driving the escapement, what is known as the "remontoire" system was adopted. It first came into use for watches, which was perhaps natural, seeing that the driving force of a watch is not a uniform weight like that of a clock, but depends on springs, which are far less trustworthy. The idea of a remontoire

is to disconnect the escapement from the clock train, and to give the escapement a driving power of its own, acting as directly as possible on the pallets without the intervention of a clock-train containing many wheels. The escapement is thus as it were made into a separate clock, which of course needs repeated winding, and this winding is effected by the clock-train. From this it results that variations in the force transmitted by the clock-train merely affect the speed at which the "rewinding" of the escapement is effected, but do not affect the force exerted by the driving power of the escapement.

There are several modes of carrying out this plan. The first of them is simply to provide the scape-wheel with a weight or spring of its own, which spring is wound up by the clock-train as often as it runs down. Contrivances of this kind are called train remontoires. In arranging such a remontoire it is obvious that the clock-train must be provided with a stop to prevent it from overwinding the scape-wheel weight or spring, and further, that there must be on the scape-wheel some sort of stud or other contrivance to release the clock-train as soon as the scape-wheel weight or spring has run down and needs rewinding. We believe the first maker of a large clock with a train remontoire was Thomas Reid of Edinburgh, who described his apparatus in his book on *Horology* (1819). The scape-wheel was driven by a small weight hung by a Huygens's endless chain, of which one of the pulleys was fixed to the arbor, and the other rode upon the arbor, with the pinion attached to it, and the pinion was driven and the weight wound up by the wheel below (which we will call the third wheel), as follows. Assuming the scape-wheel to turn in a minute, its arbor has a notch cut half through it on opposite sides in two places near to each other; on the arbor of the wheel, which turns in ten minutes, suppose, there is another wheel with 20 spikes sticking out of its rim, but alternately in two different planes, so that one set of spikes can only pass through one of the notches in the scape-wheel arbor, and the other set only through the other. Whenever, then, the scape-wheel completes a half-turn, one spike is let go, and the third wheel is able to move, and with it the whole clock-train and the hands, until the next spike of the other set is stopped by the scape-wheel arbor; at the same time the pinion on that arbor is turned half round, winding up the remontoire weight, but without taking its pressure off the scape-wheel. Reid says that, so long as this apparatus was kept in good order, the clock went better than it did after it was removed in consequence of its getting out of order from the constant banging of the spikes against the arbor.

Train remontoires.

A clock at the Royal Exchange, London, was made in 1844 on the same principle, except that, instead of the endless chain, an internal wheel was used, with the spikes set on it externally, which is one of the modes by which an occasional secondary motion may be given to a wheel without disturbing its primary and regular motion. The following is a more simple arrangement of a gravity train remontoire, much more frequently used in principle. Let E in fig. 15 be the scape-wheel turning in a minute, and e its pinion, which is driven by the wheel D having a pinion d driven by the wheel C, which we may suppose to turn in an hour. The arbors of the scape-wheel and hour-wheel are distinct, their pivots meeting in a bush fixed somewhere between the wheels. The pivots of the wheel D are set in the frame AP, which rides on the arbors of the hour-wheel and scape-

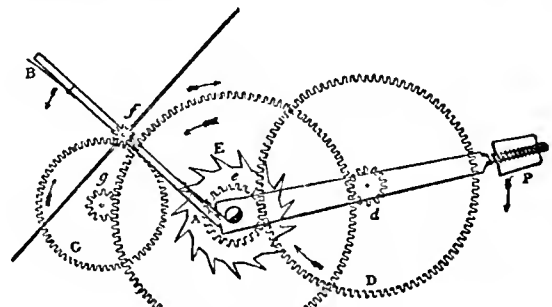

FIG. 15.—Gravity Train Remontoire.

wheel, or on another short arbor between them. The hour-wheel also drives another wheel G, which again drives the pinion f on the arbor which carries the two arms f A, f B; and on the same arbor is set a fly with a ratchet, like a common striking fly, and the numbers of the teeth are so arranged that the fly will turn once for each turn of the scape-wheel. The ends of the remontoire arms f A, f B are capable of alternately passing the notches cut half through the arbor of the scape-wheel, as those notches successively come into the proper position at the end of every half-minute; as soon as that happens the hour-wheel raises the movable wheel D and its frame through a small angle; but, nevertheless, that wheel keeps pressing on the scape-wheel as if it were not moving, the point of contact of the wheel C and the pinion d being the fulcrum or centre of motion of the lever A d P. It will be observed that the remontoire arms f A,

f B have springs set on them to diminish the blow on the scape-wheel arbor, as it is desirable not to have the fly so large as to make the motion of the train, and consequently of the hands, too slow to be distinct.

Another kind of remontoire is on the principle of one bevelled wheel lying between two others at right angles to it. The first of the bevelled wheels is driven by the train, and the third is fixed to the arbor of the scape-wheel; and the intermediate bevelled wheel, of any size, rides on its arbor at right angles to the other two arbors which are in the same line. The scape-wheel will evidently turn with the same average velocity as the first bevelled wheel, though the intermediate one may move up and down at intervals. The transverse arbor which carries it is let off and lifted a little at half-minute intervals, as in the remontoire just now described; and it gradually works down as the scape-wheel turns under its pressure, until it is freed again and lifted by the clock-train.

In all these gravity remontoires, however, only the friction of the heavy parts of the train and the dial-work is got rid of, and the scape-wheel is still subject to the friction of the remontoire wheels, which, though much less than the other, is still something considerable. Accordingly, attempts have frequently been made to drive the scape-wheel by a spiral spring, like the mainspring of a watch. One of these was described in the 7th edition of this encyclopaedia; and Sir G. Airy invented another on the same principle, of which one specimen is still going well. One of the best forms of such a remontoire is shown in fig. 16, in which A, B, D, E, *e*, *f* are the same things as in fig. 15. But *e*, the scape-wheel pinion, is no longer fixed to the arbor, nor does it ride on the arbor, as had been the case in all the previous spring remontoires, thereby producing probably more friction than was saved in other respects; but it rides on a stud *k*, which is set in the clock frame. On the face of the pinion is a plate, of which the only use is to carry a pin *h* (and consequently its shape is immaterial), and in front of the plate is set a bush *b*, with a hole through it, of which half is occupied by the end of the stud *k*, to which the bush is fixed by a small pin, and the other half is the pivot-hole for the scape-wheel arbor. On the arbor is set the remontoire spring *s* (a moderate-sized musical-box spring is generally used), of which the outer end is bent into a loop to take hold of the pin *h*. In fact, there are two pins at *h*, one a little behind the other, to keep the coils of the spring from touching each other. Now, it is evident that the spring may be wound up half or a quarter of a

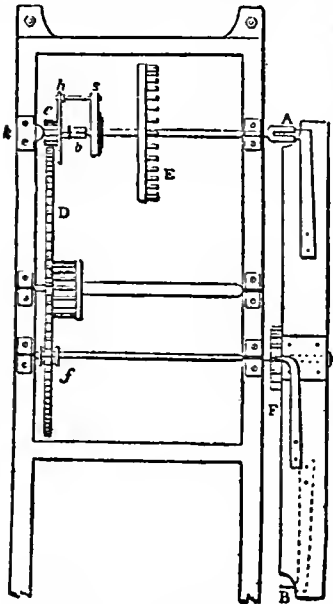

FIG. 16.—Spring Remontoire.

turn at the proper intervals without taking the force off the scape-wheel, and also without affecting it by any friction whatever. When the scape-wheel turns in a minute, the letting-off would be done as before described, by a couple of notches in the scape-wheel arbor, through which the spikes A, B, as in fig. 15, would pass alternately. During the half-minute that the spring is running down the impulse on the pendulum constantly diminishes; but this error is small if the spring be properly shaped, and besides, being periodic, does not affect the average time-keeping of the clock. It would be inadmissible in astronomical clocks where each particular second has always to be true. In clocks with only three wheels in the train it is best to make the scape-wheel turn in two minutes. In that case four notches and four remontoire arms are required, and the fly makes only a quarter of a turn. Lord Grimthorpe made the following provision for diminishing the friction of the letting-off work. The fly pinion *f* has only half the number of teeth of the scape-wheel pinion, being a lantern pinion of 7 or 8, while the other is a leaved pinion of 14 or 16, and therefore the same wheel D will properly drive both, as will be seen hereafter. The scape-wheel arbor ends in a cylinder about $\frac{3}{8}$ in. in diameter, with two notches at right angles cut in its face, one of them narrow and deep, and the other broad and shallow, so that a long and thin pin B can pass only through one, and a broad and short pin A through the other. Consequently, at each quarter of a turn of the scape-wheel, the remontoire fly, on which the pins A, B are set on springs, as in fig. 15, can turn half round. It is set on its arbor *f* by a square ratchet and click, which enables the spring to be adjusted to the requisite tension to obtain the proper vibration of the pendulum. A better construction, afterwards introduced, is to make the fly separate from the letting-off arms, whereby the blow on the cylinder is diminished, the fly being allowed to go on as in the gravity escapement. It should be observed, however, that even a spring remontoire requires a larger

weight than the same clock without one; but as none of that additional force reaches the pendulum, that is of no consequence. The variation of force of the remontoire spring from temperature, as it only affects the pendulum through the medium of the dead escapement, is far too small to produce any appreciable effect; and it is found that clocks of this kind, with a compensated pendulum 8 ft. long, and weighing about 2 cwt., will not vary above a second a month, if the pallets are kept clean and well oiled. No turret clock without either a train remontoire or a gravity escapement will approach that degree of accuracy.

The introduction of this remontoire led to another very important alteration in the construction of large clocks. Hitherto it had always been considered necessary, with a view to diminish the friction as far as possible, to make the wheels of brass or gun-metal, with the teeth cut in an engine. The French clockmakers had begun to use cast iron striking parts, and cast iron wheels had been occasionally used in the going part of inferior clocks for the sake of cheapness; but they had never been used in any clock making pretensions to accuracy. But in consequence of the success of a clock shown in the 1851 Exhibition, it was determined by Sir G. Airy and Lord Grimthorpe (then E. Denison), who were jointly consulted by the Board of Works about the great Westminster clock in 1852, to alter the original requisition for gun-metal wheels there to cast iron. But cast iron wheels must drive cast iron pinions, for they will wear out steel.

The next kind of remontoire still leaves the scape-wheel linked up with the clock-train, but makes it wind up the pallets which are held raised up till their action is wanted, when they are allowed to drop gently on the crutch or the pendulum rod. In this case the two arms of the anchor are usually divided and mounted on separate shafts so as to act independently. This idea was first started by Thomas Mudge (1717-1794) and Alexander Cumming (1733-1814). Mudge's escapement is shown in fig. 17. The tooth A of the scape-wheel is resting against the stop or detent *a* at the end of the pallet CA, from the axis or arbor of which descends the half-fork CP to touch the pendulum. From the other pallet CB descends the other half-fork CO. The two arbors are set as near the point of suspension, or top of the pendulum spring, as possible. The pendulum, as here represented, must be moving to the right, and just leaving contact with the left pallet and going to take up the right one; as soon as it has raised that pallet a little it will evidently unlock the wheel and let it turn, and then the tooth B will raise the left pallet until it is caught by the stop *b* on that pallet, and then it will stay until the pendulum returns and releases it by raising that pallet still higher. Each pallet therefore descends with the pendulum to a lower point than that where it is taken up, and the difference between them is supplied by the lifting of each pallet by the clock, which does not act on the pendulum at all; so that the pendulum is independent of all variations of force and friction in the train. This escapement is said by Lord Grim-

Gravity
escapement.

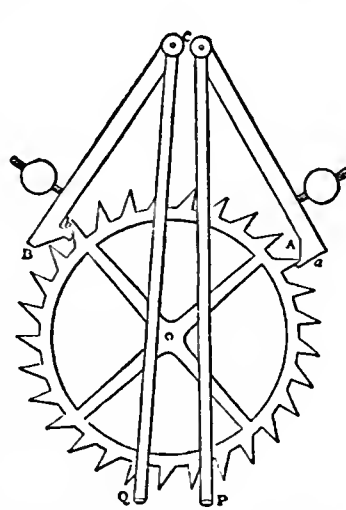

FIG. 17.—Mudge's Gravity Escapement.

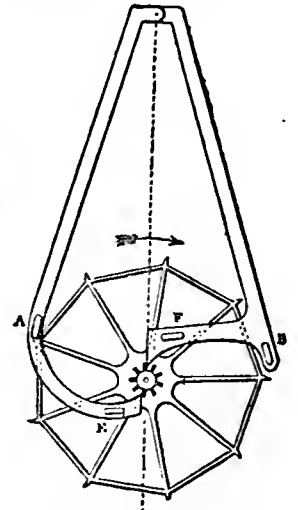

FIG. 18.—Bloxam's Gravity Escapement.

thorpe, in his *Rudimentary Treatise on Clocks*, first published in 1850, to be liable to trip, the pallets being apt to be jerked by the pendulum, so that the teeth slip past the hook, and the wheel flies round. This, however, appears entirely a matter of construction. The really weak point is that while the impulses on the pendulum due to the gravitational fall of the arms are uniform, the force which has to be exercised by the pendulum in unlocking them from the scape-wheel varies with the pressure of the clock-train. Hence we miss the compensation which is so beautiful a result of Graham's escapement. To avoid this, J. M. Bloxam, a barrister, proposed about the middle of the 19th century his legged gravity escapement (fig. 18). By this arrangement the parts of the scape-wheel which

lifted the gravity arms were brought as near to the axis of the scape-wheel as possible, while the locking arms were brought as far from the axis as possible so that the pressure should be light. The pallet arbors were cranked, to embrace the pendulum-spring, so that their centres of motion might coincide with that of the pendulum as nearly as possible—perhaps an unnecessary refinement; at least the three-legged and four-legged gravity escapements answer very well with the pallet arbors set on each side of the top of the spring. The size of the wheel determines the length of the pallets, as they must be at such an angle to each other that the radii of the wheel when in contact with each stop may be at right angles to the pallet arm; and therefore, for a wheel of this size, the depth of locking can only be very small. The pinion in Bloxam's clock only raises the pallet through 40° at each beat; i.e. the angle which we call γ , viz. the amplitude of the pendulum when it begins to lift the pallet, is only $20'$; and probably, if it were increased to anything like $a/\sqrt{2}$, where a is the semiarc of swing, the escapement would trip immediately. The two broad pins marked E, F, are the fork-pins, and A and B are the stops. The clock which Bloxam had went very well; but it had an extremely fine train, with pinions of 18; and nobody else appears to have been able to make one to answer.

Bloxam's escapement was modified in form by Lord Grimthorpe, his chief improvement being the addition of a fly vane, which, however, had previously been used for remontoires to steady the motion. He tried various modifications of construction, but finally adopted the "four-legged" and "double-three-legged" forms as being the most satisfactory, the former for regulators and the latter for large clocks. Fig. 19 is a back view of the escapement part of an astronomical clock with the four-legged wheel; seen from the front the

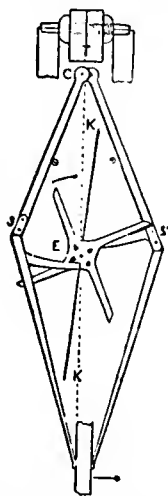

FIG. 19.—Four-legged Gravity Escapement.

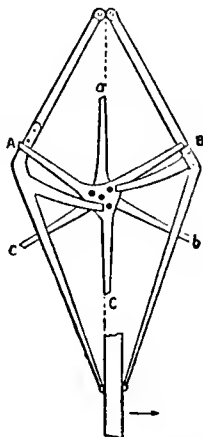

FIG. 20.—Double Three-legged Escapement.

wheel would turn the other way. The long locking teeth are made about 2 in. long from the centre, and the lifting pins, of which four point forwards while four other intermediate ones point backwards, are at not more than $\frac{1}{3}$ of the distance between the centres EC, of the scape-wheel and pallets; or rather C is the top of the pendulum spring to which the pallets Cs, Cs' converge, though the resultant of their action is a little below C. It is not worth while to crank them as Bloxam did, in order to make them coincide exactly with the top of the pendulum, as the friction of the beat pins on the pendulum is insignificant, and even then would not be quite destroyed. The pallets are not in the same plane, but one is behind and the other in front of the wheel, with one stop pointing backwards and the other forwards to receive the teeth alternately—it does not matter which; in this figure the stop s is behind and the stop s' forward. The pendulum is now going to the right, and just beginning to lift the right pallet and free the stop s'; then the wheel will begin to turn and lift the other pallet by one of the pins which is now lowest, and which moves through 45° across the line of centres, and therefore lifts with very little friction. It goes on till the tooth now below s reaches s and is stopped there. Meanwhile the pallet Cs' goes on with the pendulum as far as it may go, to the end of the arc which we have called α , starting from γ ; but it falls with the pendulum again, not only to γ but to $-\gamma$ on the other side of α , so that the impulse is due to the weight of each pallet alternately falling through 2γ ; and the magnitude of the impulse also depends on the obliqueness of the pallet on the whole, i.e. on the distance of its centre of gravity from the vertical through C. The fly KK' is set on with a friction spring like the common striking-part fly, and should be as long as there is room for, length being much more effective than width.

The double three-legged gravity escapement, which was first used in the Westminster clock, is shown in fig. 20. The principle of it is the same as of the four-legs; but instead of the pallets being one behind and the other in front of the wheel, with two sets of lifting

pins, there are two wheels ABC, abc, with the three lifting pins and the two pallets between them like a lantern pinion. One stop B points forward and the other A backward. The two wheels have their teeth set intermediately or 60° apart, though that is not essential, and the angle of 120° may be divided between them in any other proportions, as 70° and 50° , and in that way the pallets may be still more oblique than 30° from the vertical, which, however, is found enough to prevent tripping even if the fly gets loose, which is more likely to happen from carelessness in large clocks than in astronomical ones.

Of course the fly for those escapements in large clocks, with weights heavy enough to drive the hands in all weather, must be much larger than in small ones. For average church clocks with $1\frac{1}{2}$ sec. pendulum the legs of the scape-wheels are generally made 4 in. long and the fly from 6 to 7 in. long in each vane by $1\frac{1}{4}$ or $1\frac{1}{2}$ wide. For $1\frac{1}{2}$ sec. pendulums the scape-wheels are generally made $4\frac{1}{2}$ radius. At Westminster they are 6 in.

Lord Grimthorpe considered that these escapements act better, especially in regulators, if the pallets do not fall quite on the lifting pins, but on a banking, or stop at any convenient place, so as to leave the wheel free at the moment of starting; just as the striking of a common house clock will sometimes fail to start unless the wheel with the pins has a little run before a pin begins to lift the hammer. The best way to manage the banking is to make the beat-pins long enough to reach a little way behind the pendulum, and let the banking be a thin plate of any metal screwed adjustably to the back of the case. This plate cannot well be shown in the drawings together with the pendulum, which, it may be added, should take up one pallet just when it leaves the other.

In chronometer spring remontoires the pendulum, as it goes by, flips a delicate spring and releases a small weight or spring which has been wound up in readiness by the action of the scape-wheel and which by leaping on to the pendulum gives it a push. One on this principle made about the middle of the 19th century by Robert Houdin is to be seen at the Conservatoire des Arts et Métiers. It is very complicated. The following is more simple. In fig. 21 a scape-wheel AB has 30 pins and 360 teeth. It is engaged with a fly vane EP mounted on a pinion of 12 teeth. Each pin as it passes raises an impulse arm CD which is hooked upon a detent K. A pall NM then engages the fly vane and prevents the scape-wheel from moving farther. The impulse arm being now set, as the plate F attached to the lower end of the pendulum flies past from left to right a pall

Chronometer spring remontoire.

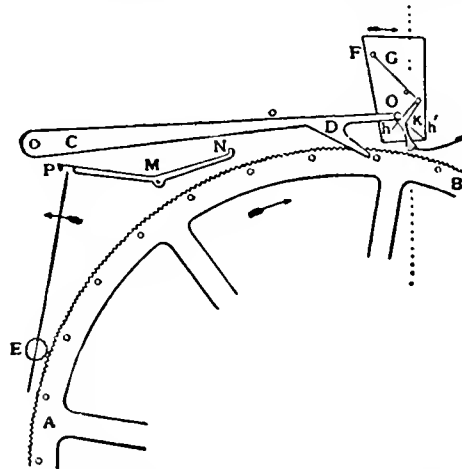

FIG. 21.—Chronometer Spring Remontoire.

G knocks aside the detent K, and allows a pin O projecting from the end of the impulse arm to fall upon an inclined pallet h, which is thus urged forward. As soon as the pallet has left the pin, the impulse arm in its further fall strikes N, which disengages the pall at P and allows the scape-wheel to move on and again wind up the impulse arm CD, which is then again locked by the detent K. On the return journey of the pendulum the light pall G, which acts the part of a chronometer spring, flips over the detent. The pallet is double sided, h and h', so that if by chance the clock runs down while the pendulum swings from left to right the impulse arm will be simply raised and not smashed. It has a flat apex, on which the pin falls before descending. The impulse given depends on the weight of the impulse arm and may be varied at pleasure. The work done in unlocking the detent is invariable, as it depends on the pressure of the fly vane at P and is independent of the clock-train. The duration of the impulse is very short—only about $\frac{1}{10}$ of the arc of swing. It is given exactly at the centre of the swing, and when not under impulse the pendulum is detached.

Clock Wheels.—Since, as we have seen, any increase in the arc of a pendulum is accompanied by a change in its going rate,

it is very desirable to keep the force which acts on the pendulum uniform. This in fact is the great object of the best escapements. Inasmuch as the impulse on the pendulum, derived from the work done by a falling weight or an unwinding spring, is transmitted through a train of wheels, it is desirable that that transmission should be as free from friction and as regular as possible. This involves care in the shaping of the teeth. The object to be aimed at is that as the wheel turns round the ratio of the power of the driver to that of the driven wheel ("runner" or "follower") should never vary. That is to say, whether the back part of the tooth of the driver is acting on the tip of the tooth of the follower, or the tip of the driver is acting on the back part of the tooth of the follower, the leverage ratio shall always be uniform. For simplicity of manufacture the pinion wheels are always constructed with radial leaves, so that the surface of each tooth is a plane passing through the axis of the wheel. The semicircular rounding of the end of the tooth is merely ornamental. The question therefore is, suppose that it is desired by means of a tooth on a wheel to push a plane round an axis, what is the shape that must be given to that tooth in order that the leverage ratio may remain unaltered?

If a curved surface, known as a "cam," press upon a plane one, both being hinged or centred upon pivots A and B respectively (fig. 22), then the line of action and reaction at D, the point where they touch, will be perpendicular to their surfaces at the point of contact—that is perpendicular to BD, and the ratio of leverage will obviously be AE : BD, or AC : CB. Hence to cause the leverage ratio of the cam to the plane always to remain unaltered, the cam must

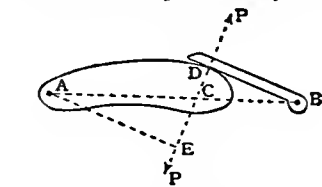

FIG. 22.—Cam and Plane.

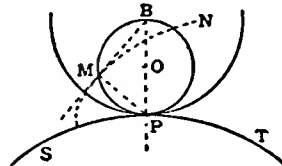

FIG. 23.

be so shaped that in any position the ratio AC : CB will remain unchanged. In other words the shape of the cam must be such that, as it moves and pushes BD before it, the normal at the point of contact must always pass through the fixed point C.

If a circle PMB roll upon another circle SPT (fig. 23) any point M on it will generate an epicycloid MN. The radius of curvature of the curve at M will always be MP, for the part at M is being produced by rotation round the point P. It follows that a line from B to M will always be tangential to the epicycloid. If the epicycloid be a cam moving as a centre round the centre R (not shown in the figure) of the circle SPT, the leverage it will exert upon a plane surface BM moving round a parallel axis at B, will always be as BP to PR, that is, a constant; whence MN is the proper shape of a tooth to act on a pinion with radial arms and centred at B. In designing a pair of wheels to transmit motion, which is to be multiplied say 6 times in the transmission (about the usual ratio for clock wheels), if we take two circles (called the "pitch circles") touching one

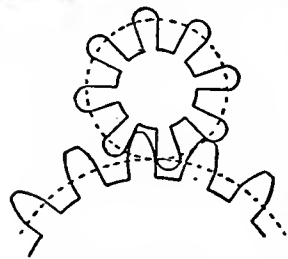

FIG. 24.

whose diameter is the radius of the pitch circle of the pinion. Points of the teeth so formed are cut off, so as to allow of the pinion having a solid core to support it, and gaps are made into the pitch circle to admit the rounded

ends of the leaves of the pinion wheel. Thus a cog-wheel is shaped out.

Clock wheels are made of hard hammered brass cut out by a wheel cutting machine. This machine consists of a vertical spindle on the top of which the wheel to be cut is fixed on a firmly resisting plate of metal of slightly smaller diameter, so as to allow the wheel to overlap. A cutter with the edges most delicately ground to the exact shape of the gap between two teeth is caused to rotate 3000-4000 times a minute, and brought down upon the edge of the wheel. The shavings that come off are like fine dust, but the cutter is pushed on so as to plunge right through the rim of the wheel in a direction parallel to the axis. In this way one gap is cut. The vertical spindle is now rotated one division, by means of a dividing plate, and another tooth is cut, and so the operation goes on round the wheel.

It is not desirable in clocks that the pinion wheels which are driven should have too few teeth, for this throws all the work on a pair of surfaces before the centres and is apt to produce a grinding motion. Theoretically the more leaves a pinion has the better. Pinions can be made with leaves of thin steel watch-spring. In this case quite small pinions can have 20 leaves or more. The teeth in the driving wheels then become mere notches for which great accuracy of shape is not necessary. Such wheels are easy to make and run well. Lantern pinions are also excellent and are much used in American clocks. They are easy to make in an ordinary lathe. The cog-wheels must, however, be specially shaped to fit them. They consist of a number of round pins arranged in a circle round the axis of the wheel and parallel to it. The ends are secured in flanges like the wires of a squirrel cage. The teeth of cog-wheels engage them and thus drive the wheel round. They were much used at one time but are now falling out of favour again.

It is possible to make toothed wheels that drive with perfect uniformity by using for the curve of the teeth involutes of circles. These involutes are traced out by a point on a string that is gradually unwound from a circle. They are in fact epicycloids traced by a rolling circle of infinite radius, *i.e.* a straight line. Involute teeth have the advantage that they roll on one another instead of sliding. When badly made they put considerable strain on the axes or shafts that carry them. Hence they have not been regarded with great favour by clockmakers.

By the pitch of a wheel is meant the number of teeth to the inch of circumference or diameter of the wheel; the former is called the circumferential pitch, the latter the diametral pitch. Thus if we say that a wheel has 40 diametral pitch we mean that it has 40 teeth to each inch of diameter. The circumferential pitch is of course got by dividing the diametral pitch by π . Wheel-cutters are made for all sizes of pitches. If it were needed to make a pair of wheels the ratio of whose motion was say 6 : 1 and we determined to use a diametral pitch of 30 to the inch, that is teeth about $\frac{1}{10}$ in. wide at the base, and if the smaller circle were to have 20 teeth, we should need a blank of a diameter of $\frac{20}{30} + \frac{20}{30} = \frac{40}{30}$ in. for the smaller wheel, and one of $\frac{120}{30} + \frac{20}{30} = \frac{140}{30}$ in. for the larger wheel which would have 120 teeth to the inch and be 4.06 in diameter to the tips of the teeth. The smaller toothed wheel would be .73 of an inch in diameter over all. The pitch circles of the wheels would be $\frac{2}{3}$ and 4 in. respectively. For fine wheel work, where the driver is always much larger than the driven wheel, the epicycloidal tooth appears preferable, as it is generally considered to put less side strain on the pinion wheel. But the relative merits of the two systems have never been properly tested for clock work.

Going Barrels.—A clock which is capable of going accurately must have some contrivance to keep it going while it is being wound up. In the old-fashioned house clocks, which were wound up by merely pulling one of the strings, and in which one such winding served for both the going and striking parts, this was done by what is called the endless chain of Huygens, which consists of a string or chain with the ends joined together, and passing over two pulleys on the arbors of the great wheels,

with deep grooves and spikes in them, to prevent the chain from slipping. In one of the two loops or festoons which hang from the upper pulleys is a loose pulley without spikes, carrying the clock-weight, and in the other a small weight only heavy enough to keep the chain close to the upper pulleys. Now, suppose one of those pulleys to be on the arbor of the great wheel of the striking part, with a ratchet and click, and the other pulley fixed to the arbor of the great wheel of the going part; then (whenever the clock is not striking) the weight may be pulled up by pulling down that part of the string which hangs from the other side of the striking part; and yet the weight will be acting on the going part all the time. It would be just the same if the striking part and its pulley were wound up with a key, instead of the string being pulled, and also the same, if there were no striking part at all, but the second pulley were put on a blank arbor, except that in that case the weight would take twice as long to run down, supposing that the striking part generally requires the same weight \times fall as the going part.

This kind of going barrel, however, is evidently not suited to the delicacy of an astronomical clock; and Harrison's going ratchet is now universally adopted in such clocks, and also in chronometers and watches for keeping the action of the train on the escapement during the winding. Fig. 25 (in which the same letters are used as in the corresponding parts of fig. 3)

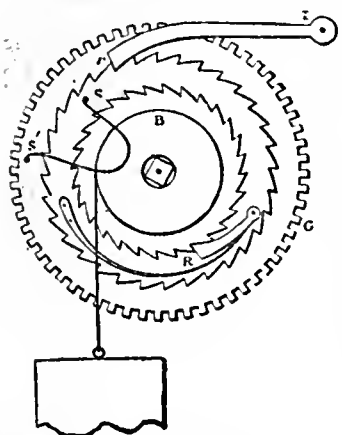

FIG. 25.—Harrison's Going-Ratchet.

The click of the barrel-ratchet R is set upon another larger ratchet-wheel with its teeth pointing the opposite way, and its click T is set in the clock frame. That ratchet is connected with the great wheel by a spring ss' pressing against the two pins s in the ratchet and s' in the wheel. When the weight is wound up (which is equivalent to taking it off), the click T prevents that ratchet from turning back or to the right; and as the spring ss' is kept by the weight in a state of tension equivalent to the weight itself it will drive the wheel to the left for a short distance, when its end s is held fast, with the same force as if that end was pulled forward by the weight; and as the great wheel has to move very little during the short time the clock is winding, the spring will keep the clock going long enough.

In the commoner kind of turret clocks a more simple apparatus is used, which goes by the name of the *bolt and shutter*, because it consists of a weighted lever with a broad end, which shuts up the winding-hole. When it is lifted a spring-bolt attached to the lever, or its arbor, runs into the teeth of one of the wheels, and the weight of the lever keeps the train going until the bolt has run itself out of gear. Clocks are not always driven by weights. When accuracy is not necessary, but portability is desirable, springs are used. The old form of spring became weaker as it was unwound and necessitated the use of a device called a fusee or spiral drum. This apparatus will be found described in the article WATCH.

Striking Mechanism.—There are two kinds of striking work used in clocks. The older of them, the *locking-plate* system, which is still used in most foreign clocks, and in turret clocks in England also, will not allow the striking of any hour to be either omitted or repeated, without making the next hour strike wrong; whereas in the *rack* system, which is used in all English house clocks, the number of blows to be struck depends merely on the position of a wheel attached to the going part, and therefore the striking of any hour may be omitted or repeated without deranging the following ones. We shall only describe the second of these, which is the more usual in modern timepieces.

Fig. 26 is a front view of a common English house clock with the face taken off, showing the repeating or rack striking movement. Here, as in fig. 3, M is the hour-wheel, on the pipe of which the minute-hand is set, N the reversed hour-wheel, and n its pinion, driving the 12-hour wheel H, on whose socket is fixed what is called the snail Y, which belongs to the striking work exclusively. The hammer is raised by the eight pins in the rim of the second wheel in the striking train, in the manner which is obvious.

The hammer does not quite touch the bell, as it would jar in striking if it did, and prevent the full sound. The form of the hammer-shank at the arbor where the spring S acts upon it is such that the spring both drives the hammer against the bell when the tail T is raised, and also checks it just before it reaches the bell, the blow on the bell thus being given by the hammer having acquired momentum enough to go a little farther than its place of rest. Sometimes two springs are used, one for impelling

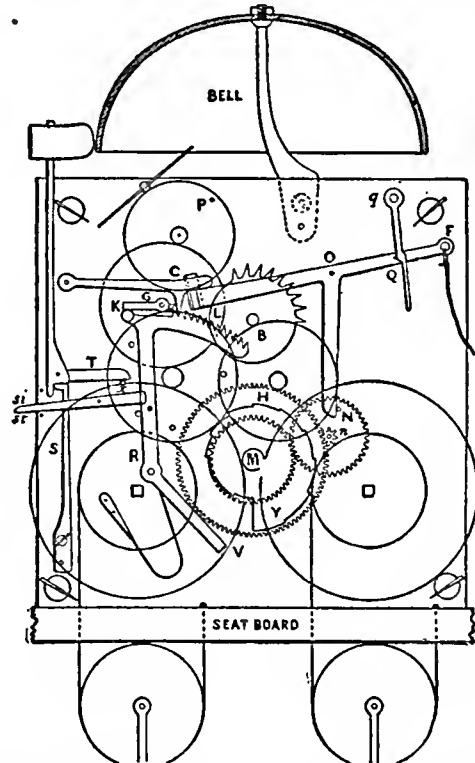

FIG. 26.—Front view of common English House Clock.

the hammer, and the other for checking it. But nothing will check the chattering of a heavy hammer, except making it lean forward so as to act, partially at least, by its weight. The pinion of the striking-wheel generally has eight leaves, the same number as the pins; and as a clock strikes 78 blows in 12 hours, the great wheel will turn in that time if it has 78 teeth instead of 96, which the great wheel of the going part has for a centre pinion of eight. The striking-wheel drives the wheel above it once round for each blow, and that wheel drives a fourth (in which there is a single pin P), six, or any other integral number of turns, for one turn of its own, and that drives a fan-fly to moderate the velocity of the train by the resistance of the air, an expedient at least as old as De Vick's clock in 1370.

The wheel N is so adjusted that, within a few minutes of the hour, the pin in it raises the *lifting-piccc* LONF so far that that piece lifts the click C out of the teeth of the *rack* BKR V, which immediately falls back (helped by a spring near the bottom) as far as its tail V can go by reason of the snail Y, against which it falls; and it is so arranged that the number of teeth which pass the click is proportionate to the depth of the snail; and as there is one step in the snail for each hour, and it goes round with the hour-hand, the rack always drops just as many teeth as the

number of the hour to be struck. This drop makes the noise of "giving warning." But the clock is not yet ready to strike till the lifting-piece has fallen again; for, as soon as the rack was let off, the tail of the *gathering pallet* G, on the prolonged arbor of the third wheel, was enabled to pass the pin K of the rack on which it was pressing before, and the striking train began to move; but before the fourth wheel had got half round, its pin P was caught by the end of the lifting-piece, which is bent back and goes through a hole in the plate, and when raised stands in the way of the pin P, so that the train cannot go on till the lifting-piece drops, which it does exactly at the hour, by the pin N then slipping past it. Then the train is free; the striking wheel begins to lift the hammer, and the gathering pallet gathers up the rack, a tooth for each blow, until it has returned to the place at which the pallet is stopped by the pin K coming under it. In this figure the lifting-piece is prolonged to F, where there is a string hung to it, as this is the proper place for such a string when it is wanted for the purpose of learning the hour in the dark, and not (as it is generally put) on the click C; for if it is put there and the string is held a little too long, the clock will strike too many; and if the string accidentally sticks in the case, it will go on striking till it is run down—neither of which things can happen when the string is put on the lifting-piece.

The snail is sometimes set on a separate stud with the apparatus called a *star-wheel* and *jumper*. On the left side of the frame we have placed a lever *x*, with the letters *st* below it, and *si* above. If it is pushed up to *si*, the other end will come against a pin in the rack, and prevent it from falling, and will thus make the clock silent; and this is much more simple than the old-fashioned "strike and silent" apparatus, which we shall therefore not describe, especially as it is seldom used now.

If the clock is required to strike quarters, a third "part" or train of wheels is added on the right hand of the going part; and its general construction is the same as the hour-striking part; only there are two more bells, and two hammers so placed that one is raised a little after the other. If there are more quarter-bells than two, the hammers are generally raised by a chime-barrel, which is merely a cylinder set on the arbor of the striking-wheel (in that case generally the third in the train), with short pins stuck into it in the proper places to raise the hammers in the order required for the tune of the chimes. The quarters are usually made to let off the hour, and this connexion may be made in two ways. If the chimes are different in tune for each quarter, and not merely the same tune repeated two, three and four times, the repetition movement must not be used for them, as it would throw the tunes into confusion, but the old locking-plate movement, as in turret clocks; and therefore, if we conceive the hour lifting-piece connected with the quarter locking-plate, as it is with the wheel N, in fig. 26, it is evident that the pin will discharge the hour striking part as the fourth quarter finishes.

But where the repetition movement is required for the quarters, the matter is not quite so simple. The principle of it may shortly be described thus. The quarters themselves have a rack and snail, &c., just like the hours, except that the snail is fixed on one of the hour-wheels M or N, instead of on the twelve-hour wheel, and has only four steps in it. Now suppose the quarter-rack to be so placed that when it falls for the fourth quarter (its greatest drop), it falls against the hour lifting-piece somewhere between O and N, so as to raise it and the click C. Then the pin Q will be caught by the click Qg, and so the lifting-piece will remain up until all the teeth of the quarter-rack are gathered up; and as that is done, it may be made to disengage the click Qg, and so complete the letting off the hour striking part. This click Qg has no existence except where there are quarters.

The method in which an alarm is struck may be understood by reference to either of the recoil escapements (figs. 1 and 7). If a short hammer instead of a long pendulum be attached to the axis of the pallets, and the wheel be driven with sufficient force, it will evidently swing the hammer rapidly backwards and forwards; and the position and length of the hammer-head may be so adjusted as to strike a bell inside, first on one side and then on the other. As to the mode of letting off the alarm

at the time required: if it was always to be let off at the same time all that would be necessary would be to set a pin in the twelve-hour wheel at the proper place to raise the lifting-piece which lets off the alarm at that time. But as the time must be capable of alteration, this discharging pin must be set in another wheel (without teeth), which rides with a friction-spring on the socket of the twelve-hour wheel, with a small movable dial attached to it, having figures so arranged with reference to the pin that whatever figure is made to come to a small pointer set as a tail to the hour hand, the alarm shall be let off at that hour.

The *watchman's* or *tell-tale* clock, used when it is desired to make sure of a watchman being on the spot and awake all the night, is a clock with a set of spikes, generally 48 or 96, sticking out all round the dial, and a handle somewhere in the case, by pulling which one of the spikes which is opposite to it, or to some lever connected with it is pressed in. This wheel of spikes is carried round with the hour-hand, which in these clocks is generally a twenty-four hour one. It is evident that every spike which is seen still sticking out in the morning indicates that at the particular time to which that spike belongs the watchman was not there to push it in—or at any rate, that he did not. At some other part of their circuit, the inner ends of the pins are carried over a roller or an inclined plane which pushes them out again ready for business the next night. The time at which workmen arrive at their work may be recorded by providing each of them with a numbered key with which he stamps his number on a moving tape, on which also the time is marked by a clock.

Church and Turret Clocks.—Seeing that a clock—at least the going part of it—is a machine in which the only work to be done is the overcoming of its own friction and the resistance of the air, it is evident that when the friction and resistance are much increased it may become necessary to resort to expedients for neutralizing their effects, which are not required in a smaller machine with less friction. In a turret clock the friction is enormously increased by the great weight of all the parts; and the resistance of the wind, and sometimes snow, to the motion of the hands, further aggravates the difficulty of maintaining a constant force on the pendulum; and besides that, there is the exposure of the clock to the dirt and dust which are always found in towers, and of the oil to a temperature which nearly or quite freezes it all through the usual cold of winter. This last circumstance alone will generally make the arc of the pendulum at least half a degree more in summer than in winter, and inasmuch as the time is materially affected by the force which arrives at the pendulum, as well as the friction on the pallets when it does arrive there, it is evidently impossible for any turret clock of the ordinary construction, especially with large dials, to keep any constant rate through the various changes of temperature, weather and dirt to which it is exposed. Hence special precautions, such as the use of remontoires and gravity escapements, have to be observed in the design of large clocks that have any pretensions to accuracy, in order to ensure that the arc of the pendulum is not affected by external circumstances, such as wind-pressure on the hands or dirt in the wheel-train. But such have been the improvements effected in electric clocks, that rather than go to the trouble and expense required by such precautions, it appears far preferable to keep an accurate time-piece in some sheltered position and use it with a source of electricity to drive the hands of the large dial.

Electrical Clocks.—One of the first attempts to apply electricity to clocks was made by Alexander Bain in 1840–1850. About the same time Sir C. Wheatstone, R. L. Jones, C. Shepherd, Paul Garnier and Louis Bréguet invented various forms of electrical time-keepers. It is not proposed here to go into the history of these abortive attempts. Those who desire to follow them may consult Bain, *An Account of Some Applications of the Electric Fluid to the Useful Arts* (1843), and *Short History of Electric Clocks* (1852); Sir Charles Wheatstone, *Trade Circular of the British Telegraph Manufactory*; C. Shepherd, *On the Application of Electro-magnetism as a Motor for Clocks* (1851), and a list of

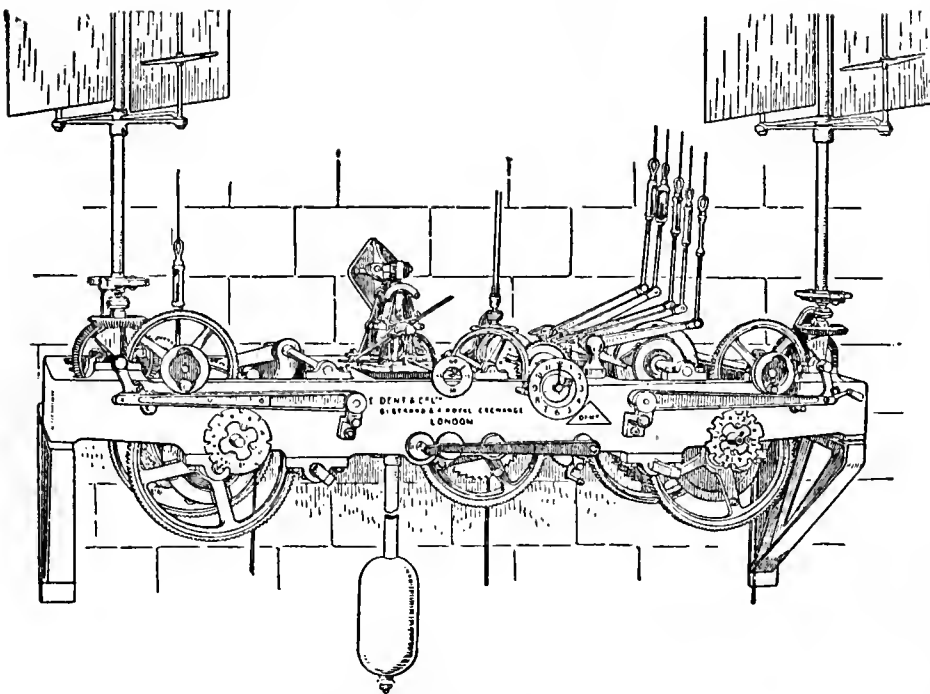

FIG. 27.—Turret Clock for Hidalgo, Mexico, driving four 8 ft. dials.

references in the Appendix to Tobler's *Die elektrischen Uhren* (Leipzig, 1883), and a list of books given by F. Hope Jones, *Proc. Inst. Elec. Eng.*, 1900, vol. 29. The history of electrical clocks is a long and complicated matter, for there are some 600 or 700 patents for these clocks in Europe and America, some containing the germs of valuable ideas but most pure rubbish. All that can be done is to select one or two prominent types of each class and give a brief description of their general construction.

It is in the apparently simple matter of making and keeping the electrical contact that most of the systems of electrical time-keeping have failed, for want of attention to the essential conditions of the problem. In practice every metal is covered with a thin film of non-conducting oxide over which is another film of moisture, oil, dirt or air. Hence what is wanted is a good vigorous push of a blunted point or edge preferably obliquely upon a more or less yielding surface so as to get a rubbing action. Thus if the stiff spring *a b* (fig. 28) were stabbed down on the oblique surface *C D* a good contact would invariably result, provided that the metals employed were gold, platinum or some not easily oxidizable metal. Or again, if a mercury surface be simply touched with a pin, the slight sparking that is produced on making the current will soon form a little pile of dirty oxide at the point of entry, and the contact will frequently fail. If it be necessary to have a mercury contact, the pin must be well driven in below the surface of the mercury or else swept through it as an oar is swept through the water. Another form of electrical contact that acts well is a knife edge brought into contact with a series of fine elastic strips of metal laid parallel to one another like the fingers of a hand. The best metal for contacts, if they are to bear hard usage, is either silver or gold or a mixture of 40% iridium with 60% of platinum. A pressure of some 15 grammes, at least, is needful to secure a good contact.

As to the source of current for driving electrical clocks, if Leclanché cells be used they should preferably be kept in the open air under cover so as not to dry up. If direct electric current is available from electric light mains or the accumulators used for lighting a private house, so much the better. Of course the pressure of 50 or 100 volts used for lighting would be far too great for clock-driving, where only the pressure of a few volts is required. But it is easy by the insertion of suitable resistances, as for instance one or more incandescent lamps, to weaken down

the pressure of the lighting system and make it available for electric clocks, bells or other similar purposes.

Electricity is applied to clocks in three main ways:—(1) in actuating timepieces which measure their own time and must therefore be provided with pendulums or balance wheels; (2) in reproducing on one or more dials the movements of the hands of a master clock, by the aid of electric impulses sent at regular intervals, say of a minute or a half-minute; and (3) in synchronizing ordinary clocks by occasional impulses sent from some accurate regulator at a distance.

Electrically driven timepieces may be divided under two heads:—(a) those in which the electric current drives either the pendulum or some lever which operates upon it, which lever or pendulum in turn drives the clock hands; and (b) those timepieces which are driven by a weight or spring which is periodically wound up by electricity—in fact electrical remontoires.

The simplest clock of the first character that could be imagined

would be constructed by fastening an electromagnet with a soft iron core to the bottom of a pendulum, and causing it to be attracted as the pendulum swings by another electromagnet fixed vertically under it (fig. 29). As the pendulum approached the vertical and was say half an inch from its lowest point, the current would be switched on, and switched off as soon as the pendulum got to its lowest point. A very small attraction with this arrangement, probably about a grain weight, acting through the $\frac{1}{2}$ in. would drive a heavy pendulum. A switch would have to be worked in connexion with the pendulum. A strip of ebonite with a small face of metal on the end of one side, such as *a b* (fig. 29) might be pivoted at one end on the pendulum with a weak spring to keep it where free along the rod. As the pendulum swung by this would be swept on its journey from left to right against a fixed pin *P*. This would complete the electric circuit down through the pendulum rod, round the coil on the bottom of the pendulum, through the switch into the pin *P*, thence through the fixed electromagnet, and so back to the battery. On the return journey no contact would be made because only the ebonite face of the switch would touch *P*. The pendulum would thus receive an impulse every other vibration. We have described this switch, not to advocate it, but to warn against its use. For the contact would be quite insufficient. In order that the switch might not unduly retard the pendulum it must be light, but this would make the pressure on *P* too light to be trustworthy. Moreover, the strength of the impulse would vary with the strength of the battery, and hence the arc would be repeatedly uneven.

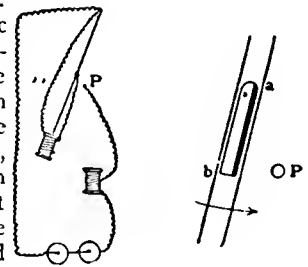

FIG. 29.—Electrical Clock (faulty design).

In contrast with this, let us consider a clock that is now giving excellent results at the Observatory of Neuchatel in Switzerland on Hipp's system (*La Pendule électrique de précision*, Neuchatel, 1884 and 1891). The pendulum (fig. 30) consists of two rods of steel joined by four bridges, one just below the suspension spring, the next about 12 in. lower, the next about half way down, and the last supporting a glass vessel of mercury which forms the bob. On the third of them is placed an iron armature,

As to the source of current for driving electrical clocks, if Leclanché cells be used they should preferably be kept in the open air under cover so as not to dry up. If direct electric current is available from electric light mains or the accumulators used for lighting a private house, so much the better. Of course the pressure of 50 or 100 volts used for lighting would be far too great for clock-driving, where only the pressure of a few volts is required. But it is easy by the insertion of suitable resistances, as for instance one or more incandescent lamps, to weaken down

which works between the poles of an electromagnet fixed to the case, and by which the pendulum is actuated. The circuit is closed and broken by a flipper, which is swayed to and fro by a block fixed to the pendulum at the second bridge. As long as the flipper is merely swayed, no contact takes place, but when the arc of vibration of the pendulum is diminished the flipper does not clear the block but is caught by a nick in it, and forced downwards. In this way the circuit is closed. Fig. 31 is a diagram of the apparatus. When the block *g* attached to the pendulum catches and presses down the flipper *s*, the lever *l* is rocked over, so that a contact is made at *k*, and the current

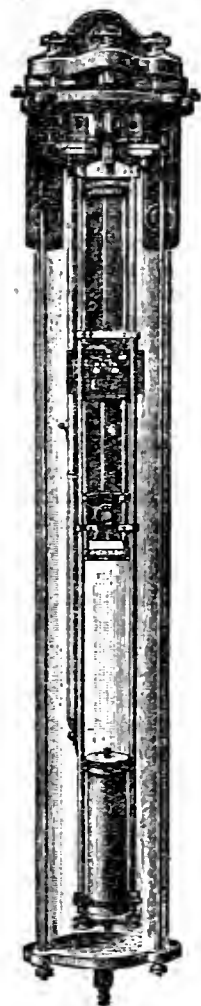

FIG. 30.—Hipp Electrical Clock (Peyer, Favarger et Cie.).

which enters the lever *l* through the knife edge *m*, runs through the second lever *n n*, down through the knife edge *o* to the battery, and through the electromagnet *b* which causes the armature *a* to be attracted. As the block *g* goes on and releases *s*, the lever *l* again falls upon the rest *p*, the lever *n* follows it a part of the way till it is stopped by the contact *q*; this shortcircuits the electromagnet and prevents to a large extent the formation of an induced current. It is claimed that sparking is by this method almost entirely avoided. It is only when *s* is caught in the notch of the block *g* that *s* is pressed down, so that the electric attraction only takes place every few vibrations. This ingenious arrangement makes the working of the clock nearly independent of the strength of the battery, for if the battery is strong the impulses are fewer and the average arc remains the same. The clock is enclosed in an airtight glass case so as to avoid barometric error. It was tested in 1905 at the Neuchâtel observatory. In winter in a room of a mean temperature of 35° F. it was $\frac{1}{4}$ sec. too slow, in summer when the temperature was 70°, it was $\frac{1}{2}$ sec. too fast. In the succeeding winter it became .53 sec. too slow again, thus gaining a little in summer and losing in

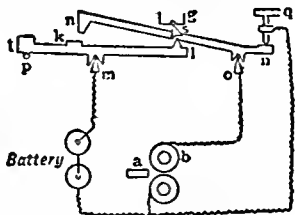

FIG. 31.—Contact Arrangement of Hipp Clock.

winter. Its average variation from its daily rate was, however, only .033 sec.

In another system originated by G. Froment, a small weight is raised by electricity and allowed to fall upon an arm sticking out at right angles to the pendulum in the plane of its motion, so as to urge it onwards. The weight is only allowed to rest on the arm during the downward swing of the pendulum. The method is not theoretically good, as the impulse is given at the end of the vibration of the pendulum instead of at its middle position.

In the clock invented by C. Féry (chef des travaux pratiques at the Ecole de Physique et Chimie, Paris), an electric impulse is given at every vibration, not by a battery but by means of the uniform movement of an armature which is alternately pulled away from and pushed towards a permanent horseshoe magnet. Currents are thus induced in a bobbin of fine wire placed between the poles of the horseshoe magnet. The movements of the

armature are produced by another horseshoe magnet actuated by the primary current from a battery which is turned on and off by the swinging of the pendulum. The energy of the induced current that drives the clock depends solely on the total movement of the armature, and is independent of whether that movement be executed slowly or rapidly, and therefore of the strength of the battery.

Electrical remontoires possess great advantages if they can be made to operate with certainty. For they can be made to wind up a scape-wheel just as is done in the case of the arrangement shown in fig. 16 so as to constitute a spring remontoire, or better still they can be made to raise a weight as in the case of the gravity train remontoire (fig. 15) but without the complications of wheel-work shown in that contrivance. Of this type one of the best known is that of H. Chesters Pond. A mainspring fixed on the arbor of the hour wheel is wound up every hour by means of another toothed wheel riding loose on the same arbor and driven by a small dynamo, to which the other end of the mainspring is attached. As soon as the hour wheel has made one revolution (driven round by the spring), a contact switch is closed whereupon

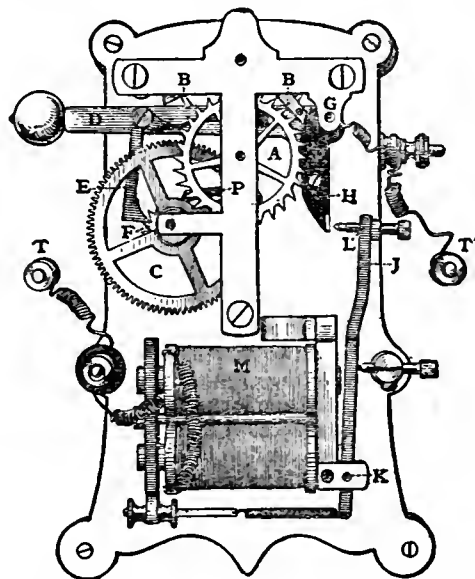

FIG. 32.—Hope Jones Electrical Remontoire.

the dynamo winds up the spring again exactly as the train and fly wind up the spring in fig. 15. These clocks require a good deal of power, and not being always trustworthy seem to have gone out of use. A contrivance of this kind now in use is that patented by F. Hope Jones and G. B. Bowell, and is represented in fig. 32. A pendulum is driven by the scape-wheel A, and pallets B B in the usual way. The scape-wheel is driven by another wheel C which, in turn, is driven by the weighted lever D supported by click E engaging the ratchet wheel F. This lever is centred at G and has an extension H at right angles to it. J is an armature of soft iron pivoted at K and worked by the electromagnet M. D gradually falls in the act of driving the clock by turning the wheels C and A until the contact plate on the arm H meets with the contact screw L at the end of the armature J, thus completing the electrical circuit from terminal T to terminal T' through the electromagnet M, and through any number of step-by-step dial movements which may be included in the same series circuit. The armature is then drawn towards the magnet with rapid acceleration, carrying the lever D with it. The armature is suddenly arrested by the poles of the magnet, but the momentum of the lever D carries it farther, and the click E engages another tooth of the ratchet F. A quick break of the circuit is thus secured, and the contact at L is a good one, first because the whole of the energy required to keep the clock going, or in other words the energy required to raise the lever D is

mechanically transmitted through its surfaces at each operation, and secondly, owing to the arrangement of the fulcrums at G and K which secure a rubbing contact. The duration of the contact is just that necessary to accomplish the work which has to be done, and it is remarkable that when used to operate large circuits of electrically propelled dials the duration accommodates itself to their exact requirements and the varying conditions of battery and self-induction. The ratchet wheel F is usually mounted loosely upon its arbor and is connected to the wheel C by means of a spiral spring, which in conjunction with the back-stop click P maintains the turning force on the wheelwork at the instant when the lever D is being raised.

Electrically driven dials usually consist of a ratchet wheel driven by an electrically moved pall. Care has to be taken that the pushes of the pall do not cause the ratchet wheel to be impelled too far. The anchor escapement of a common grandfather's clock can be made to drive the works by means of an electromagnet, the pendulum being removed. With a common anchor escapement the scape-wheel can be driven round by wagging the anchor to and fro. All then that is necessary is to fix a piece of iron on the anchor so that its weight pulls the anchor over one way, while an electromagnet pulls the iron the other. Impulses sent through the electromagnet will then drive the clock. If the clock is wound up in the ordinary way

the motion will be so much helped that the electric current has very little to do, and thus may be very feeble. Fig. 33 shows the dial-driving device of Hope Jones's clock. Each time that a current is sent by the master-clock, the electromagnet B attracts the pivoted armature C, and when the current ceases the lever D with the projecting arm E is driven back to its old position by the spring F, thus driving the wheel A

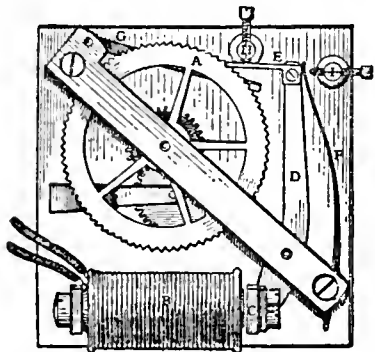

FIG. 33.—Hope Jones's Dial-driving Device.

forward one division. G is a back-stop click, and H, I, fixed stops.

It seems doubtful whether in large towns a number of dials could be electrically driven from a distance because of the large amount of power that would have to be transmitted. But for large buildings, such as hotels, they are excellent. One master-clock in the cellar will drive a hundred or so placed over the building. The master-clock may itself be driven by electricity, but it will require the services from time to time of some one to correct the time. Even this labour may be avoided if the master-clock is *synchronized*, and as synchronization requires but a small expenditure of force, it can be done over large areas. Hence the future of the clock seems to be a series of master-clocks, electrically driven, and synchronized one with another, in various parts of a city, from each of which a number of dials in the vicinity are driven. Electrical synchronization was worked out by Louis Bréguet and others, and a successful system was perfected in England by J. A. Lund. The leading principle of the best systems is at each hour to cause a pair of fingers or some equivalent device to close upon the minute hand and put it exactly to the hour. Other systems are designed to retard or to accelerate the pendulum, but the former appears the more practical method. There is probably a future before synchronization which will enable the services of a clockmaker to be largely dispensed with and relegate his work merely to keeping the instruments in repair.

Miscellaneous Clocks.—Some small clocks are made to go for a year. They have a heavy balance wheel of brass weighing about 2 lb and about 2½ in. in diameter, suspended from a point above its centre by a fine watch spring about 4 in. long. The crutch engages with the upper part of the spring, and as the

balance wheel swings the pallets are actuated. The whole clock is but a large watch with a suspended balance wheel, oscillating once in about 8 seconds. Unless the suspension spring be compensated for temperature, such clocks gain very much in winter.

An ingenious method of driving a clock by water has been proposed. As the pendulum oscillates to one side, an arm on it rises and at last lightly touches a drop of water hanging from a very fine nozzle; this drop is taken off and carried away by the arm, to be subsequently removed by adhesion to an escape funnel placed below the arm. Hence at each double vibration of the pendulum part of the work done by a drop of water falling through a short distance is communicated to the pendulum, which is thus kept in motion as long as the water lasts. At this rate a gallon of water ought to drive the clock for 40 hours. Care of course must be taken to keep the water in the reservoir at a constant level, so that the drops formed shall be uniform.

If it were worth while, no doubt the oscillations of a pendulum working in a vacuum could be maintained by the communication and discharge at each oscillation of a slight charge of electricity; or again, heat might at each oscillation be communicated to a thermo-electric junction, and the resulting current used to drive the pendulum.

The expansions and contractions of metal rods under the influence of the changes of temperature which take place in the course of each night and day have also been employed to keep a clock wound up, and if there were any need for it no doubt a small windmill rotating at the top of a tower would easily keep a turret clock fully wound, by a simple arrangement which would gear the going barrel of the clock to the wind vane motion, whenever the weight had fallen too low, and release it when the winding up was completed. Even a smoke jack would do the same office for a kitchen clock.

The methods of driving astronomical telescopes by means of clockwork will be found in the article TELESCOPE. Measurements of small intervals of time are performed by means of chronographs which in principle depend on the use of isochronous vibrating tuning-forks in place of pendulums. In practice it is needful in most cases that an observer should intervene in time measurements, although perhaps by means of a revolving photographic film a transit of the sun might be timed with extraordinary accuracy. But if the transit of a star across a wire is to be observed, there is no mode at present in use of doing so except by the use of the human eye, brain and hand. Hence in all such observations there is an element of personal error. Unfortunately we cannot apply a microscope to time as we can to space and make the cycle of events that takes place in a second last say for five minutes so as to time them truly. By personal observations the divisions of a second cannot in general be made more accurately than to $\frac{1}{10}$ or $\frac{1}{8}$ of a second. The most rapid music player does not strike a note more than 10 or 12 times in a second. It is only in case of recurring phenomena that we can make personal observations more accurate than this by taking the mean of a large number of observations, and allowing for personal error. For the purpose of determining longitude at sea accuracy to $\frac{1}{30}$ of a second of time would find the place to about 20 yards. It seems to follow that the extent to which astronomical clocks can be made accurate, viz. to $\frac{1}{30}$ of a second average variation from their mean daily rate, or one two-and-a-half millionth of 24 hours, is a degree of accuracy sufficient for present purposes, and it seems rather doubtful whether mechanical science will in the case of clocks be likely to reach a much higher figure.

In the 17th century it was a favourite device to make a clock show sidereal time as well as mean solar time. The length of the sidereal day is to the mean solar day as .99727 to 1, and various attempts have been made by trains of wheels to obtain this relation—but all are somewhat complicated.

Magical clocks are of several kinds. One that was in vogue about 1880 had a bronze figure on the top with outstretched arm holding in its hand the upper part of the spring of a pendulum,

about 10 in. long. The pendulum had apparently no escapement and the puzzle was how it was maintained in motion. It was impossible to detect the mystery by the aid of the eye alone; the truth, however, was that the whole figure swung to and fro at each oscillation of the pendulum, to an amount of $\frac{1}{100}$ of an inch on the outside rim of the base. A movement of $\frac{1}{100}$ of an inch per half second of time is imperceptible; it would be equivalent to perception of motion of the minute hand of a clock about 6 in. in diameter, which is almost impossible. The connexion of the figure to the anchor of the escapement was very complicated, but clocks of the kind kept fair time. A straw, poised near the end on a needle and with the short end united by a thread to the bronze figure, makes the motion apparent at once and discloses the trick. Another magical clock consists of two disks of thin sheet glass mounted one close behind the other, one carrying the minute hand and the other the hour hand. The disks rest on rollers which rotate and turn them round. The front and back of the movable disks are covered by other disks of glass surrounded by a frame, so that the whole looks simply like a single sheet of glass mounted in a frame, in the centre of which the hands rotate, without any visible connexion with the works of the clock.

Clocks have been made with a sort of balance wheel consisting of a thread with a ball at the end which winds backwards and forwards spirally round a rod. In others a swing or see-saw is attached to the pendulum, or a ship under canvas is made to oscillate in a heavy sea. In others the time is measured by the fall of a ball down an inclined plane, the time of fall being given by the formula $t = \sqrt{2s/g \sin a}$, where s is the length of the incline and a the inclination. But friction so modifies the result as to render experiment the only mode of adjusting such a clock. Sometimes a clock is made to serve as its own weight, as for instance when a clock shaped like a monkey is allowed to slide down a rope wound round the going barrel. Or the clock is made of a cylindrical shape outside and provided with a weighted arm instead of a going barrel; on being put upon an incline, it rolls down, and the fall supplies the motive power.

Clocks are frequently provided with chimes moved exactly like musical boxes, except that the pins in the barrel, instead of flipping musical combs, raise hammers which fall upon bells. The driving barrel is let off at suitable intervals. The cuckoo clock is a pretty piece of mechanism. By the push of a wire given to the body of the bird, it is bent forward, the wings and tail are raised and the beak opened. At the same time two weighted bellows measuring about 1×2 in. are raised and successively let drop. These are attached to small wooden organ pipes, one tuned a fifth above the other, which produce the notes. Phonographs are also attached to clocks, by which the hours are called instead of rung.

Clocks are also constructed with conical pendulums. It is a property of the conical pendulum that if swung round, the time of one complete revolution is the same as that of the double vibration of a pendulum equal in length to the vertical distance of the bob of the conical pendulum below its point of support. It follows that if the driving force of such a pendulum can be kept constant (as it easily can by an electric contact which is made at every revolution during which it falls below a certain point) the clock will keep time; or friction can be introduced so as to reduce the speed whenever the pendulum flies round too fast and hence the bob rises. Or again by suitable arrangements the bob may be made to move in certain curves so as to be isochronous. Plans of this kind are employed rather to drive telescopes, phonographs and other machines requiring uniform and steady movement.

Comical and performing clocks were very popular in the 15th and 16th centuries. One at Basel in Switzerland was arranged so as gradually to protrude a long tongue as the pendulum vibrated. It is still to be seen there in the museum. The famous clock at Strassburg, originally constructed in 1574, remade in 1842, displays a whole series of scenes, including processions of the apostles and other persons, and a cock that crows. A fine clock at Venice has two rather stiff bronze giants that strike the hours.

Clocks with complicated movements representing the positions of the heavenly bodies and the days of the week and month, allowance being made for leap year, were once the delight of the curious. Repeating clocks, which sounded the hours when a string was pulled, were once popular. The strings simply raised the lifting piece and let the clock strike as the hands would do when they came to the hour. This was of use in the old days when the only mode of striking a light at night was with a flint and steel, but lucifer matches and the electric light have rendered these clocks obsolete.

Testing Clocks.—The average amount by which a clock gains or loses is called its mean or average daily rate. A large daily rate of error is no proof that a clock is a bad one, for it might be completely removed by pendulum adjustment. What is required is that the daily rate shall be uniform, that is, that the clock shall not be gaining (or losing) more on one day than on another, or at one period of the same day than at another. In fig. 34 A B is a curve in which the abscissae represent intervals of time, the ordinates the number of seconds at any time by which the clock is wrong. The curve C D is one in which the ordinates are proportional to the tangents of the angles of inclination of the curve A B to the axis of x , that is dy/dx . Whenever the line A B is horizontal, C D cuts the axis of x . In a clock having no variation in its daily rate the curve A B would become a straight line, though it might be inclined to the axis of x , and C D, also a straight line, would be parallel to the axis of x , though it might not coincide with it. In a clock set to exact time and having

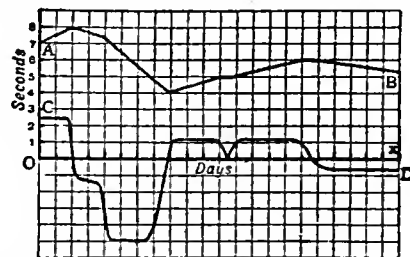

FIG. 34.—Curve of Variation of daily rate.

no variations of daily rate, both the curves would be straight lines and would coincide with the axis of x . The curve C D, known as the curve of variation of daily rate, will generally be found to follow changes of day and night, and of temperature, and the fluctuations of the barometer and hygrometer, it is the curve which reveals the true character of the clock. Hence in testing a clock two things have to be determined: first, the daily rate of error, and second, the average variations from that daily rate, in other words the *irregularities* of going. To test a clock well six months' or a year's trial is needed, and it is desirable to have it subjected to considerable changes of temperature.

The bibliography of horology is very extensive. Among modern works Lord Grimthorpe's *Rudimentary Treatise on Clocks, Watches and Bells* (8th edition, London, 1903) is perhaps the most convenient. Many references to older literature will be found in Thomas Reid's *Treatise on Clock and Watchmaking* (1849). (G.; H. H. C.)

Decorative Aspects.—In art the clock occupies a position of considerable distinction, and antique examples are prized and collected as much for the decorative qualities of their cases as for the excellence of their time-keeping. French and English cabinet-makers have especially excelled, although in entirely different ways, in the making of clock cases. The one aimed at comely utility, often made actually beautiful by fit proportion and the employment of finely grained woods; the other sought a bold and dazzling splendour in which ornament overlaid utility. It was not in either country until the latter part of the 17th century that the cabinet-maker's opportunity came. The bracket or chamber clock gave comparatively little scope to the worker in wood—in its earlier period, indeed, it was almost invariably encased in brass or other metal; and it was not until the introduction of the long pendulum swinging in a small space that it became customary to encase clocks in decorative woodwork. The long or "grandfather" clock dates from about the fourth quarter of the 17th century—what is, perhaps, the earliest surviving English dated specimen is inscribed with the date 1681. Originally it was a development

of the dome-shaped bracket clock, and in the older examples the characteristic dome or canopy is preserved. The first time-keepers of this type had oaken cases—indeed oak was never entirely abandoned; but when walnut began to come into favour a few years later that beautifully marked wood was almost invariably used for the choicest and most costly specimens. Thus in 1698 the dean and chapter of St Paul's cathedral paid the then very substantial price of £14 for an inlaid walnut long-cased eight-day clock to stand in one of the vestries. The rapidity with which the new style came into use is suggested by the fact that while very few long clocks can be certainly dated before 1690, between that year and the end of the century there are many examples. Throughout the 18th century they were made in myriads all over England, and since they were a prized possession it is not surprising that innumerable examples have survived. Vary as they may in height and girth, in wood and dial, they are all essentially alike. In their earlier years their faces were usually of brass engraved with cherubs' heads or conventional designs, but eventually the less rich white face grew common. There are two varieties—the eight-day and the thirty-hour. The latter is but little esteemed, notwithstanding that it is often as decorative as the more expensive clock. The favourite walnut case of the late 17th and early 18th century gave place in the course of a generation to mahogany, which retained its primacy until the introduction of cheaper clocks brought about the supersession of the long-cased variety. Many of these cases were made in lacquer when that material was in vogue; satinwood and other costly foreign timbers were also used for bandings and inlay. The most elegant of the "grandfather" cases are, however, the narrow-waisted forms of the William and Mary period in walnut inlay, the head framed in twisted pilasters. Long clocks of the old type are still made in small numbers and at high prices; they usually contain chimes. During the later period of their popularity the heads of long clocks were often filled in with painted disks representing the moon, by which its course could be followed. Such conceits as ships moving on waves or time with wings were also in favour. The northern parts of France likewise produced tall clocks, usually in oaken cases; those with Louis Quinze shaped panels are often very decorative. French love of applied ornament was, however, generally inimical to the rather uncompromising squareness of the English case, and the great Louis Quinze and Louis Seize cabinetmakers made some magnificent and monumental clocks, many of which were "long" only as regards the case, the pendulum being comparatively short, while sometimes the case acted merely as a pedestal for a bracket-clock fixed on the top. These pieces were usually mounted very elaborately in gilt bronze, cast and chased, and French bracket and chamber clocks were usually of gilded metal or marble, or a combination of the two; this essentially late 18th-century type still persists. English bracket clocks contemporary with them were most frequently of simple square or arched form in mahogany. The "grandfather" case was also made in the Low Countries, of generous height, very swelling and bulbous.

See F. J. Britten, *Old Clocks and Watches and their Makers* (2nd edition, London, 1904); Mathieu Planchon, *L'Horloge, son histoire retrospective, pittoresque et artistique* (Paris, 1899). (J. P.-B.)

CLODIA, VIA, an ancient high-road of Italy. Its course, for the first 11 m., was the same as that of the Via Cassia; it then diverged to the N.N.W. and ran on the W. side of the Lacus Sabatinus, past Forum Clodii and Blera. At Forum Cassii it may have rejoined the Via Cassia, and it seems to have taken the same line as the latter as far as Florentia (Florence). But beyond Florentia, between Luca (Lucca) and Luna, we find another Forum Clodii, and the Antonine Itinerary gives the route from Luca to Rome as being by the Via Clodia—wrongly as regards the portion from Florentia southwards, but perhaps rightly as regards that from Luca to Florentia. In that case the Clodius whose name the road bears, possibly C. Clodius Vestalis (c. 43 B.C.), was responsible for the construction of the first portion and of that from Florentia to Luca (and Luna), and the founder of the two Fora Clodii. The name seems, in imperial

times, to have to some extent driven out that of the Cassia, and both roads were administered, with other minor roads, by the same *curator*.

See Ch. Hülsen in Pauly-Wissowa, *Realencyclopädie*, iv. 63; cf. CASSIA, VIA. (T. As.)

CLODIUS, PUBLIUS (c. 93-52 B.C.), surnamed PULCHER, Roman politician. He took part in the third Mithradatic war under his brother-in-law Lucius Licinius Lucullus, but considering himself treated with insufficient respect, he stirred up a revolt; another brother-in-law, Q. Marcius Rex, governor of Cilicia, gave him the command of his fleet, but he was captured by pirates. On his release he repaired to Syria, where he nearly lost his life during a mutiny instigated by himself. Returning to Rome in 65, he prosecuted Catiline for extortion, but was bribed by him to procure acquittal. There seems no reason to believe that Clodius was implicated in the Catilinarian conspiracy; indeed, according to Plutarch (*Cicero*, 29), he rendered Cicero every assistance and acted as one of his body-guard. The affair of the mysteries of the Bona Dea, however, caused a breach between Clodius and Cicero in December 62. Clodius, dressed as a woman (men were not admitted to the mysteries), entered the house of Cæsar, where the mysteries were being celebrated, in order to carry on an intrigue with Cæsar's wife. He was detected and brought to trial, but escaped condemnation by bribing the jury. Cicero's violent attacks on this occasion inspired Clodius with the desire for revenge. On his return from Sicily (where he had been quaestor in 61) he renounced his patrician rank, and, having with the connivance of Cæsar been adopted by a certain P. Fonteius, was elected tribune of the people (10th of December 59). His first act was to bring forward certain laws calculated to secure him the popular favour. Corn, instead of being sold at a low rate, was to be distributed gratuitously once a month; the right of taking the omens on a fixed day and (if they were declared unfavourable) of preventing the assembly of the comitia, possessed by every magistrate by the terms of the Lex Aelia Fufia, was abolished; the old clubs or guilds of workmen were re-established; the censors were forbidden to exclude any citizen from the senate or inflict any punishment upon him unless he had been publicly accused and condemned. He then contrived to get rid of Cicero (*q.v.*) and the younger Cato (*q.v.*), who was sent to Cyprus as praetor to take possession of the island and the royal treasures. Cicero's property was confiscated by order of Clodius, his house on the Palatine burned down, and its site put up to auction. It was purchased by Clodius himself, who, not wishing to appear in the matter, put up some one to bid for him. After the departure of Cæsar for Gaul, Clodius became practically master of Rome with the aid of armed ruffians and a system of secret societies. In 57 one of the tribunes proposed the recall of Cicero, and Clodius resorted to force to prevent the passing of the decree, but was foiled by Titus Annius Milo (*q.v.*), who brought up an armed band sufficiently strong to hold him in check. Clodius subsequently attacked the workmen who were rebuilding Cicero's house at the public cost, assaulted Cicero himself in the street, and set fire to the house of Q. Cicero. In 56, when curule aedile, he impeached Milo for public violence (*de vi*), when defending his house against the attacks of Clodius, and also charged him with keeping armed bands in his service. Judicial proceedings were hindered by outbreaks of disturbance, and the matter was finally dropped. In 53, when Milo was a candidate for the consulship, and Clodius for the praetorship, the rivals collected armed bands and fights took place in the streets of Rome, and on the 20th of January 52 Clodius was slain near Bovillae.

His sister, CLODIA, wife of Q. Caccilius Metellus Celer, was notorious for her numerous love affairs. It is now generally admitted that she was the Lesbia of Catullus (Teuffel-Schwabe, *Hist. of Roman Lit.*, Eng. tr., 214, 3). For her intrigue with M. Caelius Rufus, whom she afterwards pursued with unrelenting

¹ It is suggested (W. M. Lindsay, *The Latin Language*, p. 41) that he changed his name Claudius into the plebeian form, Clodius, in order to gain the favour of the mob.

hatred and accused of attempting to poison her, see Cicero, *Pro Caelio*, where she is represented as a woman of abandoned character.

AUTHORITIES.—Cicero, *Letters* (ed. Tyrrell and Purser), *Pro Caelio*, *pro Sestio*, *pro Milone*, *pro Domo sua*, *de Haruspicio Responsis*, in *Pisonem*; Plutarch, *Lucullus*, *Pompey*, *Cicero*, *Caesar*; Dio Cassius xxxvi. 16, 19, xxxvii. 45, 46, 51, xxxviii. 12-14, xxxix. 6, 11, xl. 48. See also I. Gentile, *Clodio e Cicerone* (Milan, 1876); E. S. Beesley, "Cicero and Clodius," in *Fortnightly Review*, v.; G. Lacour-Gayet, *De P. Clodio Pulchro* (Paris, 1888), and in *Revue historique* (Sept. 1889); H. White, *Cicero, Clodius and Milo* (New York, 1900); G. Boissier, *Cicero and his Friends* (Eng. trans., 1897).

CLOGHER, a market village of Co. Tyrone, Ireland, in the south parliamentary division, on the Clogher Valley light railway. Pop. (1901) 225. It gives name to dioceses of the Church of Ireland and the Roman Catholic Church, but the seat of the Roman Catholic bishop is at Monaghan, with the cathedral. The Protestant cathedral, dedicated to St Macartin, dates from the 18th and early 19th century, but St Macartin (c. 500) was a disciple of St Patrick, and it is said that St Patrick himself founded a bishopric here. The name is derived from the Irish *cloch*, a pillar stone, such as were worshipped and regarded as oracles in many parts of pagan Ireland; the stone was preserved as late as the 15th century in the cathedral, and identity is even now claimed for a stone which lies near the church.

CLOISTER (Lat. *claustrum*; Fr. *cloître*; Ital. *chiostro*; Span. *claustrro*; Ger. *Kloster*). The word "cloister," though now restricted to the four-sided enclosure, surrounded with covered ambulatories, usually attached to conventual and cathedral churches, and sometimes to colleges, or by a still further limitation to the ambulatories themselves, originally signified the entire monastery. In this sense it is of frequent occurrence in earlier English literature (e.g. Shakespeare, *Meas. for Meas.* i. 3, "This day my sister should the cloister enter"), and is still employed in poetry. The Latin *claustrum*, as its derivation implies, primarily denoted no more than the enclosing wall of a religious house, and then came to be used for the whole building enclosed within the wall. To this sense the German "Kloster" is still limited, the covered walks, or cloister in the modern sense, being called "Klostergang," or "Kreuzgang." In French the word *cloître* retains the double sense.

In the special sense now most common, the word "cloister" denotes the quadrilateral area in a monastery or college of canons, round which the principal buildings are ranged, and which is usually provided with a covered way or ambulatory running all round, and affording a means of communication between the various centres of the ecclesiastical life, without exposure to the weather. According to the Benedictine arrangement, which from its suitability to the requirements of monastic life was generally adopted in the West, one side of the cloister was formed by the church, the refectory occupying the side opposite to it, that the worshippers might have the least annoyance from the noise or smell of the repasts. On the eastern side the chapter-house was placed, with other apartments belonging to the common life of the brethren adjacent to it, and, as a common rule, the dormitory occupied the whole of the upper story. On the opposite or western side were generally the cellarer's lodgings, with the cellars and store-houses, in which the provisions necessary for the sustenance of the confraternity were housed. In Cistercian monasteries the western side was usually occupied by the "domus conversorum," or lodgings of the lay-brethren, with their day-rooms and workshops below, and dormitory above. The cloister, with its surrounding buildings, generally stood on the south side of the church, to secure as much sunshine as possible. A very early example of this disposition is seen in the plan of the monastery of St Gall (see ABBEY, fig. 3). Local requirements, in some instances, caused the cloister to be placed to the north of the church. This is the case in the English cathedrals, formerly Benedictine abbeys, of Canterbury, Gloucester and Chester, as well as in that of Lincoln. Other examples of the northward situation are at Tintern, Buildwas and Sherborne. Although the covered

ambulatories are absolutely essential to the completeness of a monastic cloister, a chief object of which was to enable the inmates to pass from one part of the monastery to another without inconvenience from rain, wind, or sun, it appears that they were sometimes wanting. The cloister at St Albans seems to have been deficient in ambulatories till the abbacy of Robert of Gorham, 1151-1166, when the eastern walk was erected. This, as was often the case with the earliest ambulatories, was of wood covered with a sloping roof or "penthouse." We learn from Osborn's account of the conflagration of the monastery of Christ Church, Canterbury, 1067, that a cloister with covered ways existed at that time, affording communication between the church, the dormitory and the refectory. We learn from an early drawing of the monastery of Canterbury that this cloister was formed by an arcade of Norman arches supported on shafts, and covered by a shed roof. A fragment of an arcaded cloister of this pattern is still found on the eastern side of the infirmary-cloister of the same foundation. This earlier form of cloister has been generally superseded in England by a range of windows, usually unglazed, but sometimes, as at Gloucester, provided with glass, lighting a vaulted ambulatory, of which the cloisters of Westminster Abbey, Salisbury and Norwich are typical examples. The older design was preserved in the South, where "the cloister is never a window, or anything in the least approaching to it in design, but a range of small elegant pillars, sometimes single, sometimes coupled, and supporting arches of a light and elegant design, all the features being of a character suited to the place where they are used, and to that only" (Fergusson, *Hist. of Arch.* i. p. 610). As examples of this description of cloister, we may refer to the exquisite cloisters of St John Lateran, and St Paul's without the walls, at Rome, where the coupled shafts and arches are richly ornamented with ribbons of mosaic, and those of the convent of St Scholastica at Subiaco, all of the 13th century, and to the beautiful cloisters at Arles, in southern France; those of Aix, Fontfroide, Elne, &c., are of the same type; as also the Romanesque cloisters at Zürich, where the design suffers from the deep abacus having only a single slender shaft to support it, and at Laach, where the quadrangle occupies the place of the "atrium" of the early basilicas at the west end, as at St Clement's at Rome, and St Ambrose at Milan. Spain also presents some magnificent cloisters of both types, of which that of the royal convent of Huelgas, near Burgos, of the arcaded form, is, according to Fergusson, "unrivalled for beauty both of detail and design, and is perhaps unsurpassed by anything in its age and style in any part of Europe." Few cloisters are more beautiful than those of Monreale and Cefalu in Sicily, where the arrangement is the same, of slender columns in pairs with capitals of elaborate foliage supporting pointed arches of great elegance of form.

All other cloisters are surpassed in dimensions and in sumptuousness of decoration by the "Campo Santo" at Pisa. This magnificent cloister consists of four ambulatories as wide and lofty as the nave of a church, erected in 1278 by Giovanni Pisano round a cemetery composed of soil brought from Palestine by Archbishop Lanfranchi in the middle of the 12th century. The window-openings are semicircular, filled with elaborate tracery in the latter half of the 15th century. The inner walls are covered with frescoes invaluable in the history of art by Orcagna, Simone Memmi, Buffalmacco, Benozzo Gozzoli, and other early painters of the Florentine school. The ambulatories now serve as a museum of sculpture. The internal dimensions are 415 ft. 6. in. in length, 137 ft. 10 in. in breadth, while each ambulatory is 34 ft. 6. in. wide by 46 ft. high.

The cloister of a religious house was the scene of a large part of the life of the inmates of a monastery. It was the place of education for the younger members, and of study for the elders. A canon of the Roman council held under Eugenius II., in 826, enjoins the erection of a cloister as an essential portion of an ecclesiastical establishment for the better discipline and instruction of the clerks. Peter of Blois (*Serm.* 25) describes schools for the novices as being in the west walk, and moral lectures delivered in that next the church. At Canterbury the monks'

school was in the western ambulatory, and it was in the same walk that the novices were taught at Durham (Willis, *Monastic Buildings of Canterbury*, p. 44; *Rites of Durham*, p. 71). The other alleys, especially that next the church, were devoted to the studies of the elder monks. The constitutions of Hildemar and Dunstan enact that between the services of the church the brethren should sit in the cloister and read theology. For this purpose small studies, known as "carrols," i.e. a ring or enclosed space, were often found in the recesses of the windows. Of this arrangement there are examples at Gloucester, Chester and elsewhere. The use of these studies is thus described in the *Rites of Durham*:—"In every wyndowe" in the north alley "were iii pewes or carrells, where every one of the olde monkes had his carrell severally by himselfe, that when they had dyed they dyd resorte to that place of cloister, and there studyed upon their books, every one in his carrell all the afternonne unto evensong tyme. This was there exercise every daie." On the opposite wall were cupboards full of books for the use of the students in the carrols. The cloister arrangements at Canterbury were similar to those just described. New studies were made by Prior De Estria in 1317, and Prior Selling (1472-1494) glazed the south alley for the use of the studious brethren, and constructed "the new framed contrivances, of late styled carrols" (Willis, *Mon. Buildings*, p. 45). The cloisters were used not for study only but also for recreation. The constitutions of Archbishop Lanfranc, sect. 3, permitted the brethren to converse together there at certain hours of the day. To maintain necessary discipline a special officer was appointed under the title of *prior claustrii*. The cloister was always furnished with a stone bench running along the side. It was also provided with a lavatory, usually adjacent to the refectory, but sometimes standing in the central area, termed the cloister-garth, as at Durham. The cloister-garth was used as a place of sepulture, as well as the surrounding alleys. The cloister was in some few instances of two stories, as at Old St Paul's, and St Stephen's chapel, Westminster, and occasionally, as at Wells, Chichester and Hereford, had only three alleys, there being no ambulatory under the church wall.

The larger monastic establishments had more than one cloister; there was usually a second connected with the infirmary, of which there are examples at Westminster Abbey and at Canterbury; and sometimes one giving access to the kitchen and other domestic offices.

The cloister was not an appendage of monastic houses exclusively. It was also attached to colleges of secular canons, as at the cathedrals of Lincoln, Salisbury, Wells, Hereford and Chichester, and formerly at St Paul's and Exeter. It is, however, absent at York, Lichfield, Beverley, Ripon, Southwell and Wimborne. A cloister forms an essential part of the colleges of Eton and Winchester, and of New College and Magdalen at Oxford, and was designed by Wolsey at Christ Church. These were used for religious processions and lectures, for ambulatories for the studious at all times, and for places of exercise for the inmates generally in wet weather, as well as in some instances for sepulture.

For the arrangements of the Carthusian cloisters, as well as for some account of those appended to the monasteries of the East, see ABBEY. (E. V.)

CLONAKILTY, a seaport and market town of Co. Cork, Ireland, in the south parliamentary division, at the head of Clonakilty Bay, 33 m. S.W. of Cork on a branch of the Cork, Bandon & South Coast railway. Pop. of urban district (1901), 3098. It was brought into prosperity by Richard Boyle, first earl of Cork, and was granted a charter in 1613; but was partly demolished on the occasion of a fight between the English and Irish in 1641. It returned two members to the Irish parliament until the union. In the 18th century there was an extensive linen industry. The present trade is centred in brewing, corn-milling, yarn and farm-produce. The harbour-mouth is obstructed by a bar, and there is a pier for large vessels at Ring, a mile below the town. The fisheries are of importance. A ruined church on the island of Inchdorey, and castles on Galley Head, at Dunnycove, and at

Dunowen, together with a stone circle, are the principal antiquities in the neighbourhood.

CLONES, a market town of Co. Monaghan, Ireland, in the north parliamentary division, 64½ m. S.W. by W. from Belfast, and 93½ m. N.W. from Dublin by the Great Northern railway, on which system it is an important junction, the lines from Dublin, from Belfast, from Londonderry and Enniskillen, and from Cavan converging here. Pop. of urban district (1901), 2068. The town has a considerable agricultural trade, and there are corn mills and manufactures of agricultural implements. A former lace-making industry is extinct. The market-place, called the Diamond, occupies the summit of the slight elevation on which the town is situated. Clones was the seat of an abbey founded in the 6th century by St Tighernach (Tierney), to whom the Protestant parish church is dedicated. Remains of the abbey include a nave and tower of the 12th century, and a curious shrine formed out of a great block of red sandstone. Other antiquities are a round tower of rude masonry, 75 ft. high but lacking the cap; a rath, or encampment, and an ancient market cross in the Diamond.

CLONMACNOISE, one of the most noteworthy of the numerous early religious settlements in Ireland, on the river Shannon, in King's county, 9 m. S. of Athlone. An abbey was founded here by St Kieran in 541, which as a seat of learning gained a European fame, receiving offerings, for example, from Charles the Great, whose companion Alcuin the scholar received part of his education from the great teacher Colcu at Clonmacnoise. Several books of annals were compiled here, and the foundation became the seat of a bishopric, but it was plundered and wasted by the English in 1552, and in 1568 the diocese was united with that of Meath. The most remarkable literary monument of Clonmacnoise is the Book of the Dun Cow, written about 1100 still preserved (but in an imperfect form) by the Royal Irish Academy, and containing a large number of romances. It is a copy of a much earlier original, which was written on the skin of a favourite cow of St Kieran, whence the name of the work. The full title of the foundation is the "Seven Churches of Clonmacnoise," and remains of all these are extant. The Great Church, though rebuilt by a chief named McDermot, in the 14th century, retains earlier remains in a fine west doorway; the other churches are those of Fineen, Conor, St Kieran, Kelly, Melaghlin and Dowling. There are two round towers; O'Rourke's, lacking the roof, but occupying a commanding situation on rising ground, is dated by Petrie from the early 10th century, and stands 62 ft. in height; and McCarthy's, attached to Fineen's church, which is more perfect, but rather shorter, and presents the unusual feature of a doorway level with the ground, instead of several feet above it as is customary. There are three crosses, of which the Great Cross, made of a single stone and 15 ft. in height, is splendidly carved, with tracery and inscriptions. It faces the door of the Great Church, and is of the same date. A large number of inscribed stones dating from the 9th century and after are preserved in the churches. There are further remains of the Castle and Episcopal palace, a fortified building of the 14th century, and of a nunnery of the 12th century. In the neighbourhood are seen striking examples of the glacial phenomenon of *eskers*, or gravel ridges.

CLONMEL, a municipal borough and the county town of Co. Tipperary, Ireland, in the east parliamentary division, 112 m. S.W. from Dublin on a branch from Thurles of the Great Southern & Western railway, which makes a junction here with the Waterford and Limerick line of the same company. Pop. (1901) 10,167. Clonmel is built on both sides of the Suir, and also occupies Moore and Long Islands, which are connected with the mainland by three bridges. The principal buildings are the parish church, two Roman Catholic churches, a Franciscan friary, two convents, an endowed school dating from 1685, and the various county buildings. The beauty of the environs, and especially of the river, deserves mention; and their charm is enhanced by the neighbouring Galtee, Knockmealdown and other mountains, among which Slievenaman (2364 ft.) is conspicuous. A woollen manufacture was established in 1667, and was extensively carried on until the close of the 18th century. The

town contains breweries, flour-mills and tanneries, and has a considerable export trade in grain, cattle, butter and provisions. It stands at the head of navigation for barges on the Suir. It was the centre of a system, established by Charles Bianconi (1786-1875) in 1815 and subsequently, for the conveyance of travellers on light cars, extending over a great part of Leinster, Munster and Connaught. It is governed by a mayor and corporation, which, though retained under the Local Government (Ireland) Act of 1893, has practically the status of an urban district council. By the same act a part of the town formerly situated in county Waterford was added to county Tipperary. It was a parliamentary borough, returning one member, until 1885; having returned two members to the Irish parliament until the union.

The name, *Cluain mealla*, signifies the Vale of Honey. In 1269 the place was chosen as the seat of a Franciscan friary by Otho de Grandison, the first English possessor of the district; and it frequently comes into notice in the following centuries. In 1641 it declared for the Roman Catholic party, and in 1650 it was gallantly defended by Hugh O'Neill against the English under Cromwell. Compelled at last to capitulate, it was completely dismantled, and was never again fortified. Remains of the wall are seen in the churchyard, and the West Gate still stands in the main street.

CLOOTS. JEAN BAPTISTE DU VAL DE GRÂCE, BARON VON (1755-1794), better known as ANACHARSIS CLOOTS, a noteworthy figure in the French Revolution, was born near Cleves, at the castle of Gnadenthal. He belonged to a noble Prussian family of Dutch origin. The young Cloots, heir to a great fortune, was sent at eleven years of age to Paris to complete his education. There he imbibed the theories of his uncle the Abbé Cornelius de Pauw (1739-1799), philosopher, geographer and diplomatist at the court of Frederick the Great. His father placed him in the military academy at Berlin, but he left it at the age of twenty and traversed Europe, preaching his revolutionary philosophy as an apostle, and spending his money as a man of pleasure. On the breaking out of the Revolution he returned in 1789 to Paris, thinking the opportunity favourable for establishing his dream of a universal family of nations. On the 19th of June 1790 he appeared at the bar of the Assembly at the head of thirty-six foreigners; and, in the name of this "embassy of the human race," declared that the world adhered to the Declaration of the Rights of Man and of the Citizen. After this he was known as "the orator of the human race," by which title he called himself, dropping that of baron, and substituting for his baptismal names the pseudonym of Anacharsis, from the famous philosophical romance of the Abbé Jean Jacques Barthélemy. In 1792 he placed 12,000 livres at the disposal of the Republic—"for the arming of forty or fifty fighters in the sacred cause of man against tyrants." The 10th of August impelled him to a still higher flight; he declared himself the personal enemy of Jesus Christ, and abjured all revealed religions. In the same month he had the rights of citizenship conferred on him; and, having in September been elected a member of the Convention, he voted the king's death in the name of the human race, and was an active partisan of the war of propaganda. Excluded at the instance of Robespierre from the Jacobin Club, he was soon afterwards implicated in an accusation levelled against the Hébertists. His innocence was manifest, but he was condemned, and guillotined on the 24th of March 1794.

Cloots' main works are: *La Certitude des preuves du mahométisme* (London, 1780), published under the pseudonym of Ali-Gurber, in answer to Bergier's *Certitude des preuves du christianisme*; *L'Orateur du genre humain, ou Dépêches du Prussien Cloots au Prussien Herzberg* (Paris, 1791), and *La République universelle* (1792).

The biography of Cloots by G. Avenel (2 vols., Paris, 1865) is too eulogistic. See the three articles by H. Baulig in *La Révolution Française*, t. 41 (1901).

CLOQUET, a city of Carlton county, Minnesota, U.S.A., on the St Louis river, 28 m. W. by S. of Duluth. Pop. (1890) 2530; (1900) 3072; (1905, state census) 6117, of whom 2755 were

foreign born (716 Swedes, 689 Finns, 685 Canadians, 334 Norwegians); (1910) 7031. Cloquet is served by the Northern Pacific, the Great Northern, the Duluth & North-Eastern, and (for freight only) the Chicago, Milwaukee & St Paul railways. The river furnishes good water-power, and the city has various manufactures, including lumber, paper, wood pulp, match blocks and boxes. The first mill was built in 1878, and the village was named from the French word *claquet* (sound of the mill). Cloquet was incorporated as a village in 1883 and was chartered as a city in 1903.

CLOSE, MAXWELL HENRY (1822-1903), Irish geologist, was born in Dublin in 1822. He was educated at Weymouth and at Trinity College, Dublin, where he graduated in 1846; and two years later he entered holy orders. For a year he was curate of All Saints, Northampton; from 1849 to 1857 he was rector of Shangton in Leicestershire; and then for four years he was curate of Waltham-on-the-Wolds. In 1861, on the death of his father, he returned to Dublin, and while giving his services to various churches in the city, devoted himself almost wholly to literary and scientific pursuits, and especially to the glacial geology of Ireland, on which subject he became an acknowledged authority. His paper, read before the Geological Society of Ireland in 1866, on the "General Glaciation of Ireland" is a masterly description of the effects of glaciation, and of the evidence in favour of the action of land-ice. Later on he discussed the origin of the elevated shell-bearing gravels near Dublin, and expressed the view that they were accumulated by floating ice when the land had undergone submergence. He was for a time treasurer of the Royal Irish Academy, an active member of the Royal Dublin Society, and president in 1878 of the Royal Geological Society of Ireland. Astronomy and physics, as well as the ancient language and antiquities of Ireland, attracted his attention. He died in Dublin on the 12th of September 1903.

The obituary by Prof. G. A. J. Cole in *Irish Naturalist*, vol. xii. (1903) pp. 301-306, contains a list of publications and portrait.

CLOSE (from Lat. *clausum*, shut), a closed place or enclosure. In English law, the term is applied to a portion of land, enclosed or not, held as private property, and to any exclusive interest in land sufficient to maintain an action for trespass *quare clausum fregit*. The word is also used, particularly in Scotland, of the entry or passage, including the common staircase, of a block of tenement houses, and in architecture for the precincts of a cathedral or abbey.

The adjective "close" (*i.e.* closed) is found in several phrases, such as "close time" or "close season" (see GAME LAWS); close borough, one of which the rights and privileges were enjoyed by a limited class (see BOROUGH); close rolls and writs, royal letters, &c., addressed to particular persons, under seal, and not open to public inspection (see RECORD; *Chancery*; LETTERS PATENT). From the sense of "closed up," and so "confined," comes the common meaning of "near."

CLOSURE (Fr. *clôture*), the parliamentary term for the closing of debate according to a certain rule, even when certain members are anxious to continue the debate. (See PARLIAMENT: *Procedure*.)

CLOT, ANTOINE BARTHELEMY (1793-1868), French physician, known as CLOT BEY, was born at Grenoble on the 7th of November 1793, and graduated in medicine and surgery at Montpellier. After practising for a time at Marseilles he was made chief surgeon to Mehemet Ali, viceroy of Egypt. At Abuzabel, near Cairo, he founded a hospital and schools for all branches of medical instruction, as well as for the study of the French language; and, notwithstanding the most serious religious difficulties, instituted the study of anatomy by means of dissection. In 1832 Mehemet Ali gave him the dignity of bey without requiring him to abjure his religion; and in 1836 he received the rank of general, and was appointed head of the medical administration of the country. In 1849 he returned to Marseilles, though he revisited Egypt in 1856. He died at Marseilles on the 28th of August 1868. His publications included: *Relation des épidémies de choléra qui ont régné à l'Hezziaz*,

à Suez, et en Égypte (1832); *De la peste observée en Égypte* (1840); *Aperçu général sur l'Égypte* (1840); *Coup d'œil sur la peste et les quarantaines* (1851); *De l'ophthalmie* (1864).

CLOTAIRE (CHLOTHACHAR), the name of four Frankish kings.

CLOTAIRE I. (d. 561) was one of the four sons of Clovis. On the death of his father in 511 he received as his share of the kingdom the town of Soissons, which he made his capital, the cities of Laon, Noyon, Cambrai and Maastricht, and the lower course of the Meuse. But he was very ambitious, and sought to extend his domain. He was the chief instigator of the murder of his brother Clodomer's children in 524, and his share of the spoils consisted of the cities of Tours and Poitiers. He took part in the various expeditions against Burgundy, and after the destruction of that kingdom in 534 obtained Grenoble, Die and some of the neighbouring cities. When Provence was ceded to the Franks by the Ostrogoths, he received the cities of Orange, Carpentras and Gap. In 531 he marched against the Thuringi with his brother Theuderich (Thierry) I., and in 542 with his brother Childebert against the Visigoths of Spain. On the death of his great-nephew Theodebald in 555, Clotaire annexed his territories; and on Childebert's death in 558 he became king of all Gaul. He also ruled over the greater part of Germany, made expeditions into Saxony, and for some time exacted from the Saxons an annual tribute of 500 cows. The end of his reign was troubled by internal dissensions, his son Chram rising against him on several occasions. Following Chram into Brittany, where the rebel had taken refuge, Clotaire shut him up with his wife and children in a cottage, to which he set fire. Overwhelmed with remorse, he went to Tours to implore forgiveness at the tomb of St Martin, and died shortly afterwards.

CLOTAIRE II. (d. 629) was the son of Chilperic I. On the assassination of his father in 584 he was still in his cradle. He was, however, recognized as king, thanks to the devotion of his mother Fredegond and the protection of his uncle Gontran, king of Burgundy. It was not until after the death of his cousin Childebert II. in 595 that Clotaire took any active part in affairs. He then endeavoured to enlarge his estates at the expense of Childebert's sons, Theodebert, king of Austrasia, and Theuderich II., king of Burgundy; but after gaining a victory at Laffaux (597), he was defeated at Dormelles (600), and lost part of his kingdom. After the war between Theodebert and Theuderich and their subsequent death, the nobles of Austrasia and Burgundy appealed to Clotaire, who, after putting Brunhilda to death, became master of the whole of the Frankish kingdom (613). He was obliged, however, to make great concessions to the aristocracy, to whom he owed his victory. By the constitution of the 18th of October 614 he gave legal force to canons which had been voted some days previously by a council convened at Paris, but not without attempting to modify them by numerous restrictions. He extended the competence of the ecclesiastical tribunals, suppressed unjust taxes and undertook to select the counts from the districts they had to administer. In 623 he made his son Dagobert king of the Austrasians, and gradually subdued all the provinces that had formerly belonged to Childebert II. He also guaranteed a certain measure of independence to the nobles of Burgundy, giving them the option of having a special mayor of the palace, or of dispensing with that officer. These concessions procured him a reign of comparative tranquillity. He died on the 18th of October 629, and was buried at Paris in the church of St Vincent, afterwards known as St Germain des Prés.

CLOTAIRE III. (652-673) was a son of King Clovis II. In 657 he became the nominal ruler of the three Frankish kingdoms, but was deprived of Austrasia in 663, retaining Neustria and Burgundy until his death.

CLOTAIRE IV. (d. 719) was king of Austrasia from 717 to 719. (C. Pf.)

CLOTH, properly a covering, especially for the body, clothing, then the material of which such a covering is made; hence any material woven of wool or hair, cotton, flax or vegetable fibre.

In commercial usage, the word is particularly applied to a fabric made of wool. The word is Teutonic, though it does not appear in all the branches of the language. It appears in German as *Kleid*, dress (*Kleidung*, clothing), and in Dutch as *kleeed*. The ultimate origin is unknown; it may be connected with the root *kli-* meaning to stick, cling to, which appears in "clay," "cleave" and other words. The original meaning would be either that which clings to the body, or that which is pressed or "felted" together. The regular plural of "cloth" was "clothes," which is now confined in meaning to articles of clothing, garments, in which sense the singular "cloth" is not now used. For that word, in its modern sense of material, the plural "cloths" is used. This form dates from the beginning of the 17th century, but the distinction in meaning between "cloths" and "clothes" is a 19th-century one.

CLOTHIER, a manufacturer of cloth, or a dealer who sells either the cloth or made-up clothing. In the United States the word formerly applied only to those who dressed or fulled cloth during the process of manufacture, but now it is used in the general sense, as above.

CLOTILDA, SAINT (d. 544), daughter of the Burgundian king Chilperic, and wife of Clovis, king of the Franks. On the death of Gundioic, king of the Burgundians, in 473, his sons Gundobald, Godegesil and Chilperic divided his heritage between them; Chilperic apparently reigning at Lyons, Gundobald at Vienne and Godegesil at Geneva. According to Gregory of Tours, Chilperic was slain by Gundobald, his wife drowned, and of his two daughters, Chrona took the veil and Clotilda was exiled. This account, however, seems to have been a later invention. At Lyons an epitaph has been discovered of a Burgundian queen, who died in 506, and was most probably the mother of Clotilda. Clotilda was brought up in the orthodox faith. Her uncle Gundobald was asked for her hand in marriage by the Frankish king Clovis, who had just conquered northern Gaul, and the marriage was celebrated about 493. On this event many romantic stories, all more or less embroidered, are to be found in the works of Gregory of Tours and the chronicler Fredegarius, and in the *Liber historiae Francorum*. Clotilda did not rest until her husband had abjured paganism and embraced the orthodox Christian faith (496). With him she built at Paris the church of the Holy Apostles, afterwards known as Ste Genevieve. After the death of Clovis in 511 she retired to the abbey of St Martin at Tours. In 523 she incited her sons against her uncle Gundobald and provoked the Burgundian war. In the following year she tried in vain to protect the rights of her grandsons, the children of Clodomer, against the claims of her sons Childebert I. and Clotaire I., and was equally unsuccessful in her efforts to prevent the civil discords between her children. She died in 544, and was buried by her husband's side in the church of the Holy Apostles.

There is a mediocre *Life in Mon. Germ. Hist.: Script. rer. Merov.*, vol. ii. See also G. Kurth, *Sainte Clotilde* (2nd ed., Paris, 1897). (C. Pf.)

CLOUD (from the same root, if not the same word, as "clod," a word common in various forms to Teutonic languages for a mass or lump; it is first applied in the usual sense in the late 13th century; the Anglo-Saxon *clūd* is only used in the sense of "a mass of rock," *wolcen* being used for "cloud"), a mass of condensed vapour hanging in the air at some height from the earth.

Classification of Clouds.—The earliest serious attempt to name the varieties of cloud was made by J. B. Lamarck in 1801, but he only used French terms, and those were not always happily chosen. The field was therefore still clear when in 1803 Luke Howard published, in *Tilloch's Philosophical Magazine*, an entirely independent scheme in which the terms were all Latin, and were applied with such excellent judgment that his system remains as the broad basis of those in use to-day. He recognized three primary types of cloud—Cirrus, Cumulus and Stratus—and four derivative or compound forms,—Cirro-cumulus, Cirro-stratus, Cumulo-stratus and Cumulo-cirro-stratus or Nimbus.

His own definitions were:—

(1) *Cirrus*.—Parallel, flexuous or diverging fibres, extensible in any or all directions.

(2) *Cumulus*.—Convex or conical heaps, increasing upward from a horizontal base.

(3) *Stratus*.—A widely-extended continuous horizontal sheet, increasing from below.

(4) *Cirro-cumulus*.—Small, well-defined, roundish masses, in close horizontal arrangement.

(5) *Cirro-stratus*.—Horizontal or slightly inclined masses, attenuated towards a part or the whole of their circumferences, bent downward, or undulated, separate or in groups consisting of small clouds having these characters.

(6) *Cumulo-stratus*.—The cirro-stratus blended with the cumulus, and either appearing intermixed with the heaps of the latter or superadding a widespread structure to its base.

(7) *Cumulo-cirro-stratus, or nimbus*.—The rain-cloud: a cloud or system of clouds from which rain is falling. It is a horizontal sheet, above which the cirrus spreads, while the cumulus enters it laterally and from beneath.

This system was universally adopted, and apart from some ambiguity in the definitions of cumulo-stratus and nimbus, it was sufficiently detailed for many purposes, such as the general relations between clouds and the movements of the barometer. When, however, such questions as the mode of origin of particular forms of cloud came to be investigated, it was at once felt that Howard's classes were too wide, and something much more detailed was required. The result has been the promulgation from time to time of revised schemes, most of these being based on Howard's work, and differing from him by the introduction of new terms or of subdivisions of his types. Some of these new terms have come more or less into use, such as A. Poëy's *pallium* to signify a uniform sheet, but as a general rule the proposals were not accompanied by a clear enough exposition of their precise meaning for others to be quite sure of the author's intention. Other writers not appreciating how fully Howard's names had become established, boldly struck out on entirely new lines. The most important of these were probably those due respectively to (1) Poëy, published in the *Annuaire de la société météorologique de France*, 1865, (2) M. l'Abbé Maze, published in the *Mémoires du congrès météorologique international*, 1889, and (3) Frederic Gaster, *Quart. Jour. R. Meteorological Society*, 1893. In all of these Howard's terms are used, but the systems were much more elaborate, and the verbal descriptions sometimes difficult to follow.

In his book *Cloudland* (1894) Clement Ley published a novel system. He grouped all clouds under four heads, in accordance with the mode in which he believed them to be formed.

I. Clouds of Radiation.

Nebula	Fog.
Nebula Stillans	Wet fog.
Nebula Pulverea	Dust fog.

II. Clouds of Interfret.

Nubes Informis.	Scud.
Stratus Quietus	Quiet cloud.
Stratus Lenticularis	Lenticular cloud.
Stratus Maculosus	Mackerel cloud.
Stratus Castellatus	Turret cloud.
Stratus Precipitans	Plane shower.

III. Clouds of Inversion.

Cumulo-rudimentum	Rudiment.
Cumulus	Heap cloud.
Cumulo-stratus	Anvil cloud.
Cumulo-stratus Mammatus	Tubercled anvil cloud.
Cumulo-nimbus	Shower cloud.
Cumulo-nimbus Nivosus	Snow shower.
Cumulo-nimbus Grandineus	Hail shower.
Cumulo-nimbus Mammatus	Festooned shower cloud.
Nimbus	Rainfall cloud.
Nimbus nivosus	Snowfall.
Nimbus grandineus	Hailfall.

IV. Clouds of Inclination.

Nubes Fulgens	Luminous cloud.
Cirrus	Curl cloud.
Cirro-filum	Gossamer cloud.
Cirro-velum	Veil cloud.
Cirro-macula	Speckle cloud.
Cirro-velum Mammatum. ¹	Draped veil cloud.

¹ Varieties.

It will be seen that Ley's scheme is really an amplification of Howard's. The term "Interfret" is defined as the interaction of horizontal currents of different velocities. Inversion is a synonym for vertical convection, and Inclination is used to imply that such clouds consist of sloping lines of falling ice particles.

While Ley had been finishing his work and seeing it through the press, H. Hildebrand-Hildebrandsson and R. Abercromby had devised another modification which differed from Howard's chiefly by the introduction of a new class, which they distinguished by the use of the prefix *Alto*. This scheme was formally adopted by the International Meteorological Conference held at Munich in 1891, and a committee was appointed to draw up an atlas showing the exact forms typical of each variety considered. Finally in August 1894 a small sub-committee consisting of Messrs H. Hildebrand-Hildebrandsson, A. Riggenbach-Burckhardt and Teisserenc de Bort was charged with the task of producing the atlas. Their task was completed in 1896, and meteorologists were at last supplied with a fairly detailed scheme, and one which was adequately illustrated, so that there could be no doubt of the authors' meaning. It is as follows:—

The International Classification.

(a) Separate or globular masses (most frequently seen in dry weather).

(b) Forms which are widely extended, or completely cover the sky (in wet weather).

A. *Upper clouds*, average altitude 9000 metres.¹

a. 1. Cirrus.

b. 2. Cirro-stratus.

B. *Intermediate clouds*, between 3000 m. and 7000 m.

a. 3. Cirro-cumulus.

4. Alto-cumulus.

b. 5. Alto-stratus.

C. *Lower clouds*, 2000 m.

a. 6. Strato-cumulus.

b. 7. Nimbus.

D. *Clouds of Diurnal Ascending Currents*.

a. 8. Cumulus, apex 1800 m., base 1400 m.

b. 9. Cumulo-nimbus, apex 3000 m. to 8000 m., base 1400 m.

E. *High Fogs*, under 1000 m.

10. Stratus.

Explanations.

1. *Cirrus* (Ci).—Detached clouds, delicate and fibrous-looking, taking the form of feathers, generally of a white colour, sometimes arranged in belts which cross a portion of the sky in great circles and by an effect of perspective, converge towards one or two points of the horizon (the Ci-S. and the Ci-Cu. often contribute to the formation of these belts).—See Plate, fig. 1.

2. *Cirro-stratus* (Ci-S).—A thin, whitish sheet, at times completely covering the sky, and only giving it a whitish appearance (it is then sometimes called cirro-nebula), or at others presenting, more or less distinctly, a formation like a tangled web. This sheet often produces halos around the sun and moon. See fig. 2.

3. *Cirro-cumulus* (Ci-Cu).—Small globular masses, or white flakes without shadows, or having very slight shadows, arranged in groups and often in lines. See fig. 3.

4. *Alto-cumulus* (A-Cu).—Largish globular masses, white or greyish, partially shaded, arranged in groups or lines, and often so closely packed that their edges appear confused. The detached masses are generally larger and more compact (changing to S-Cu.) at the centre of the group; at the margin they form into finer flakes (changing to Ci-Cu.). They often spread themselves out in lines in one or two directions. See fig. 4.

5. *Alto-stratus* (A-S).—A thick sheet of a grey or bluish colour, showing a brilliant patch in the neighbourhood of the sun or moon, and without causing halos, sometimes giving rise to coronae. This form goes through all the changes like Cirro-stratus, but according to measurements made at Upsala, its altitude is one-half as great. See fig. 5.

6. *Strato-cumulus* (S-Cu).—Large globular masses or rolls of dark cloud, frequently covering the whole sky, especially in winter, and occasionally giving it a wavy appearance. The layer is not, as a rule, very thick, and patches of blue sky are often seen through intervening spaces. All sorts of transitions between this form and Alto-cumulus are seen. It may be distinguished from nimbus by its globular or rolled appearance, and also because it does not bring rain. See fig. 6.

¹ 1 metre = 3.28 ft.

7. *Nimbus* (N.), *Rain Cloud*.—A thick layer of dark clouds, without shape and with ragged edges, from which continued rain or snow generally falls. Through openings in these clouds an upper layer of cirro-stratus or alto-stratus may almost invariably be seen. If the layer of nimbus separates up into shreds, or if small loose clouds are visible floating at a low level, underneath a large nimbus they may be described as *fracto-nimbus* (Scud of sailors). See fig. 9.

8. *Cumulus* (Cu.) (*Wool-pack Clouds*).—Thick clouds of which the upper surface is dome-shaped and exhibits protuberances while the base is horizontal. These clouds appear to be formed by a diurnal ascensional movement which is almost always observable. When the cloud is opposite the sun, the surfaces usually presented to the observer have a greater brilliance than the margins of the protuberances. When the light falls aslant, these clouds give deep shadows, but if they are on the same side as the sun they appear dark, with bright edges. See fig. 7.

The true cumulus has clear superior and inferior limits. It is often broken up by strong winds, and the detached portions undergo continual changes. These altered forms may be distinguished by the name of *Fracto-cumulus*.

9. *Cumulo-nimbus* (Cu.-N.); *The Thunder-cloud; Shower-cloud*.—Heavy masses of clouds, rising in the form of mountains, turrets or anvils, generally having a sheet or screen of fibrous appearance above (false cirrus) and underneath, a mass of cloud similar to nimbus. From the base there generally fall local showers of rain or snow (occasionally hail or soft hail). Sometimes the upper edges have the compact form of cumulus, rising into massive peaks round which the delicate false cirrus floats, and sometimes the edges themselves separate into a fringe of filaments similar to that of cirrus. This last form is particularly common in spring showers. See fig. 10.

The front of thunderclouds of wide extent frequently presents the form of a large bow spread over a portion of the sky which is uniformly brighter in colour.

10. *Stratus* (S).—A horizontal sheet of lifted fog. When this sheet is broken up into irregular shreds by the wind, or by the summits of mountains, it may be distinguished by the name of *Fracto-stratus*. See fig. 8.

The scheme also provides that where a stratus or nimbus takes a lumpy form, this fact shall be described by the adjective *cumuliformis*, and if its base shows downward projecting bosses the word *mammato* is prefixed.

Issued as it has been with the authority of an international congress of specialists, this scheme has been generally accepted, and must be regarded as the orthodox system, and for the great majority of observations it is quite detailed enough. But it does not give universal satisfaction. Cirrus clouds, for instance, exhibit many forms, and these so diverse that they must be due to very different causes. Hence for the minuter study of cloud forms a more elaborate scheme is still needed.

Hence in 1896 H. H. Clayton of the Blue Hill observatory, Massachusetts, published in the *Annals* of the astronomical observatory of Harvard College a highly detailed scheme in which the International types and a number of subdivisions were grouped under four classes—*stratiforms* or sheet clouds; *cumuliforms* or woolpack clouds; *focculiforms*, including strato-cumulus, alto-cumulus and cirro-cumulus; and *cirriforms* or hairy clouds. The International terms are embodied and the special varieties are distinguished by the use of prefixes such as *tracto-cirrus* or *cirrus bands*, *grano-cirro-cumulus* or *granular cirrus*, &c.

Again in 1904 F. L. Obenbach of the Cleveland observatory devised a different system, published in the annual report, in which the International types are preserved, but each is subdivided into a number of species. In the absence of any atlas to define the precise meaning of the descriptions given, neither of these American schemes has come into general use.

Further proposals were put forward by A. W. Clayden in *Cloud Studies* (1905). His scheme accepts the whole of the International names which he regards as the cloud genera, and suggests specific Latin names for the chief varieties, accompanying the descriptions by photographs. The proposed scheme is as follows.

Genus.	Species.	
Cirrus	Cirro-nebula	Cirrus haze.
	Cirro-filum	Thread cirrus.
	Cirrus Excelsus	High "
	" Ventosus	Windy "
	" Nebulosus	Hazy "
	" Caudatus	Tailed "
	" Vittatus	Ribbon "
	" Inconstans	Change "
	" Communis	Common "

Cirro-stratus	Communis	Common Ci.-S.
	Nebulosus	Hazy "
	Vittatus	Ribbon "
Cirro-cumulus	Cumulosus	Flocculent Ci.-S.
	Cirro-macula	Speckle cloud.
Alto-clouds	Nebulosus	Hazy Ci. cu.
	Alto-stratus	
	" " maculosus	Mackerel sky.
	" " fractus	
	Alto-strato-cumulus	
Alto-clouds	Alto-cumulus informis	
	" " nebulosus	
	Alto-cumulus castellatus	Turret cloud.
	" " glomeratus	High ball cumulus.
Stratus	" " communis	
	" " stratiformis	Flat alto-cum.
	Stratus maculosus	
Cumulus	" " radius	Roll cloud.
	" " lenticularis	Fall cloud.
	Strato-cumulus	
	Cumulus minor	Small cumulus.
	" major	Large cumulus.
	Cumulo-nimbus	Storm cloud.

The term nimbus is to be applied to any cloud from which rain is falling, but if the true form of the cloud is visible the term should be used as a qualifying adjective. The prefix *fracto-* or the adjective *fractus* should be used when the cloud is undergoing disintegration or appears ragged or broken. *Mammato-* is used in the ordinary sense, and finally *undatus* or *waved* is to be added to the name of any cloud showing a wave-like or rippled structure. (A. W. C.)

CLouDBERRY, *Rubus Chamaemorus*, a low-growing creeping herbaceous plant, with stem not prickly, and with simple obtusely lobed leaves and solitary white flowers, resembling those of the blackberry, but larger—one inch across,—and with stamens and pistils on different plants. The orange-yellow fruit is about half an inch long and consists of a few large drupes with a pleasant flavour. The plant occurs in the mountainous parts of Great Britain, and is widely distributed through the more northerly portions of both hemispheres. In northern Denmark and Sweden the fruit is gathered in large quantities and sold in the markets.

CLouD-BURST, a sudden and violent storm of rain. The name probably originated from the idea that the clouds were solid masses full of water that occasionally burst with disastrous results. A whirlwind passing over the sea sometimes carries the water upwards in a whirling vortex; passing over the land its motion is checked and a deluge of water falls. Occasionally on high lands far from the sea violent storms occur, with rain that seems to descend in sheets, sweeping away bridges and culverts and tearing up roads and streets, being due to great and rapid condensation and vortical whirling of the resulting heavy clouds (see METEOROLOGY).

CLouDED LEOPARD (*Felis nebulosa* or *macroscelis*), a large arboreal cat from the forests of south-east Asia, Sumatra, Java, Borneo and Formosa. This cat, often called the clouded tiger, is beautifully marked, and has an elongated head and body, long tail and rather short limbs. The canine teeth are proportionately longer than in any other living cat. Little is known of the habits of the clouded leopard, but it preys on small mammals and birds, and rarely comes to the ground. The native Malay name is *Arimaudahan* ("tree-tiger"). The species is nearly related to the small Indian marbled cat (*F. marmorata*), and Fontaniers cat (*F. tristis*) of Central Asia. (R. L.*)

CLOUET, FRANÇOIS (d. 1572), French miniature painter. The earliest reference to him is the document dated December 1541 (see CLOUET, JEAN), in which the king renounces for the benefit of the artist his father's estate which had escheated to the crown as the estate of a foreigner. In it the younger Janet is said to have "followed his father very closely in the science of his art." Like his father, he held the office of groom of the chamber and painter in ordinary to the king, and so far as salary is concerned, he started where his father left off. A long list of drawings contains those which are attributed to this artist, but we still lack perfect certainty about his works. There is, however, more to go upon than there was in the case of his father,

as the praises of François Clouet were sung by the writers of the day, his name was carefully preserved from reign to reign, and there is an ancient and unbroken tradition in the attribution of many of his pictures. There are not, however, any original attestations of his works, nor are any documents known which would guarantee the ascriptions usually accepted. To him are attributed the portraits of Francis I. at the Uffizi and at the Louvre, and various drawings relating to them. He probably also painted the portrait of Catherine de' Medici at Versailles and other works, and in all probability a large number of the drawings ascribed to him were from his hand. One of his most remarkable portraits is that of Mary, queen of Scots, a drawing in chalks in the Bibliothèque Nationale, and of similar character are the two portraits of Charles IX. and the one at Chantilly of Marguerite of France. Perhaps his masterpiece is the portrait of Elizabeth of Austria in the Louvre.

He resided in Paris in the rue de Ste Avoye in the Temple quarter, close to the Hôtel de Guise, and in 1568 is known to have been under the patronage of Claude Gouffier de Boisy, Seigneur d'Oiron, and his wife Claude de Baune. Another ascertained fact concerning François Clouet is that in 1571 he was "summoned to the office of the Court of the Mint," and his opinion was taken on the likeness to the king of a portrait struck by the mint. He prepared the death-mask of Henry II., as in 1547 he had taken a similar mask of the face and hands of Francis I., in order that the effigy to be used at the funeral might be prepared from his drawings; and on each of these occasions he executed the painting to be used in the decorations of the church and the banners for the great ceremony.

Several miniatures are believed to be his work, one very remarkable portrait being the half-length figure of Henry II. in the collection of Mr J. Pierpont Morgan. Another of his portraits is that of the duc d'Alençon in the Jones collection at South Kensington, and certain representations of members of the royal family which were in the Hamilton Palace collection and the Magniac sale are usually ascribed to him. He died on the 22nd of December 1572, shortly after the massacre of St Bartholomew, and his will, mentioning his sister and his two illegitimate daughters, and dealing with the disposition of a considerable amount of property, is still in existence. His daughters subsequently became nuns.

His work is remarkable for the extreme accuracy of the drawing, the elaborate finish of all the details, and the exquisite completeness of the whole portrait. He must have been a man of high intelligence, and of great penetration, intensely interested in his work, and with considerable ability to represent the character of his sitter in his portraits. His colouring is perhaps not specially remarkable, nor from the point of style can his pictures be considered specially beautiful, but in perfection of drawing he has hardly any equal.

To Monsieur Louis Dimier, the leading authority upon his works, and to his volume on *French Painting in the Sixteenth Century*, as well as to the works of MM. Bouchot, La Borde and Maulde-La Clavière, the present writer is indebted for the information contained in this article. (G. C. W.)

CLOUET, JEAN (d. c. 1541). French miniature painter, generally known as JANET. The authentic presence of this artist at the French court is first to be noted in 1516, the second year of the reign of Francis I. By a deed of gift made by the king to the artist's son of his father's estate, which had escheated to the crown, we learn that he was not actually a Frenchman, and never even naturalized. He is supposed to have been a native of the Low Countries, and probably his real name was Clowet. His position was that of groom of the chamber to the king, and he received a stipend at first of 180 livres and later of 240. He lived several years in Tours, and there it was he met his wife, who was the daughter of a jeweller. He is recorded as living in Tours in 1522, and there is a reference to his wife's residence in the same town in 1523, but in 1529 they were both settled in Paris, probably in the neighbourhood of the parish of Ste Innocent, in the cemetery of which they were buried. He stood godfather at a christening on the 8th of July 1540, but

was no longer living in December 1541, and therefore died between those two dates.

His brother, known as CLOUET DE NAVARRE, was in the service of Marguerite d'Angoulême, sister of Francis I., and is referred to in a letter written by Marguerite about 1529. Jean Clouet had two children, François and Catherine, who married Abel Foulon, and left one son, who continued the profession of François Clouet after his decease. Jean Clouet was undoubtedly a very skilful portrait painter, but it must be acknowledged without hesitation that there is no work in existence which has been proved to be his. There is no doubt that he painted a portrait of the mathematician, Oronce Finé, in 1530, when Finé was thirty-six years old, but the portrait is now known only by a print. Janet is generally believed, however, to have been responsible for a very large number of the wonderful portrait drawings now preserved at Chantilly, and at the Bibliothèque Nationale, and to him is attributed the portrait of an unknown man at Hampton Court, that of the dauphin Francis, son of Francis I. at Antwerp, and one other portrait, that of Francis I. in the Louvre.

Seven miniature portraits in the *Manuscript of the Gallic War* in the Bibliothèque Nationale (13,429) are attributed to Janet with very strong probability, and to these may be added an eighth in the collection of Mr J. Pierpont Morgan, and representing Charles de Cossé, Maréchal de Brissac, identical in its characteristics with the seven already known. There are other miniatures in the collection of Mr Morgan, which may be attributed to Jean Clouet with some strong degree of probability, inasmuch as they closely resemble the portrait drawings at Chantilly and in Paris which are taken to be his work. In his oil paintings the execution is delicate and smooth, the outlines hard, the texture pure, and the whole work elaborately and very highly finished in rich, limpid colour. The chalk drawings are of remarkable excellence, the medium being used by the artist with perfect ease and absolute sureness, and the mingling of colour being in exquisite taste, the modelling exceedingly subtle, and the drawing careful, tender and emphatic. The collection of drawings preserved in France, and attributed to this artist and his school, comprises portraits of all the important persons of the time of Francis I. In one album of drawings the portraits are annotated by the king himself, and his merry reflections, stinging taunts or biting satires, add very largely to a proper understanding of the life of his time and court. Definite evidence, however, is still lacking to establish the attribution of the best of these drawings and of certain oil paintings to the Jean Clouet who was groom of the chambers to the king.

The chief authority in France on the work of this artist is Monsieur Louis Dimier, and to his works, and to information derived direct from him, the present writer is indebted for almost all the information given in this article. (G. C. W.)

CLOUGH, ANNE JEMIMA (1820-1892), English educationalist, was born at Liverpool on the 20th of January 1820, the daughter of a cotton merchant. She was the sister of Arthur Hugh Clough, the poet. When two years old she was taken with the rest of the family to Charleston, South Carolina. It was not till 1836 that she returned to England, and though her ambition was to write, she was occupied for the most part in teaching. Her father's failure in business led her to open a school in 1841. This was carried on until 1846. In 1852, after making some technical studies in London and working at the Borough Road and the Home and Colonial schools, she opened another small school of her own at Ambleside in Westmorland. Giving this up some ten years later, she lived for a time with the widow of her brother Arthur Hugh Clough—who had died in 1861—in order that she might educate his children. Keenly interested in the education of women, she made friends with Miss Emily Davies, Madame Bodichon, Miss Buss and others. After helping to found the North of England council for promoting the higher education of women, she acted as its secretary from 1867 to 1870 and as its president from 1873 to 1874. When it was decided to open a house for the residence of women students at Cambridge, Miss Clough was chosen as its first principal.

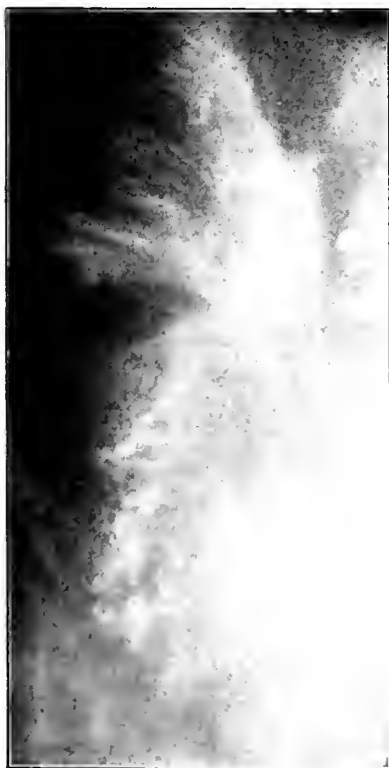

Fig. 1.—Cirrus.



Fig. 2.—Cirro-Stratus.



Fig. 3.—Cirro-Cumulus.



Fig. 4.—Alto-Cumulus.

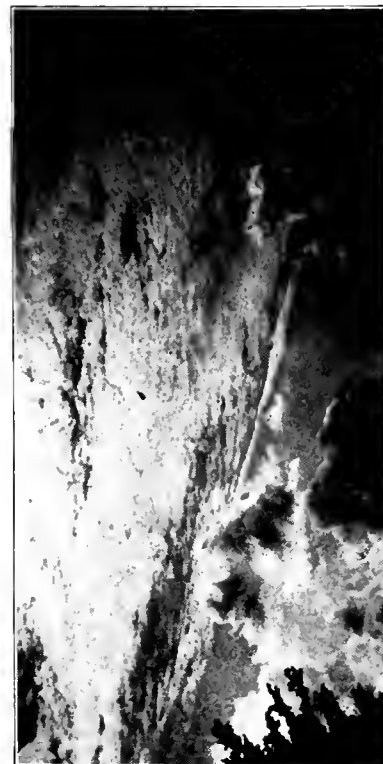

Fig. 5.—Alto-Stratus.



Fig. 6.—Strato-Cumulus.



Fig. 7.—Cumulus.



Fig. 8.—Stratus.



Fig. 9.—Nimbus.



Fig. 10.—Cumulo-Nimbus.

This hostel, started in Regent Street, Cambridge, in 1871 with five students, and continued at Merton Hall in 1872, led to the building of Newnham Hall, opened in 1875, and to the erection of Newnham College on its present basis in 1880. Miss Clough's personal charm and high aims, together with the development of Newnham College under her care, led her to be regarded as one of the foremost leaders of the women's educational movement. She died at Cambridge on the 27th of February 1892. Two portraits of Miss Clough are at Newnham College, one by Sir W. B. Richmond, the other by J. J. Shannon.

See *Memoir of Anne Jemima Clough*, by Blanche Athena Clough (1897).

CLOUGH, ARTHUR HUGH (1819-1861), English poet, was born at Liverpool on the 1st of January 1819. He came of a good Welsh stock by his father, James Butler Clough, and of a Yorkshire one by his mother, Anne Perfect. In 1822 his father, a cotton merchant, moved to the United States, and Clough's childhood was spent mainly at Charleston, South Carolina, much under the influence of his mother, a cultivated woman, full of moral and imaginative enthusiasm. In 1828 the family paid a visit to England, and Clough was left at school at Chester, whence he passed in 1829 to Rugby, then under the sway of Dr Thomas Arnold, whose strenuous views on life and education he accepted to the full. Cut off to a large degree from home relations, he passed a somewhat reserved and solitary boyhood, devoted to the well-being of the school and to early literary efforts in the *Rugby Magazine*. In 1836 his parents returned to Liverpool, and in 1837 he went with a scholarship to Balliol College, Oxford. Here his contemporaries included Benjamin Jowett, A. P. Stanley, J. C. Shairp, W. G. Ward, Frederick Temple and Matthew Arnold.

Oxford, in 1837, was in the full swirl of the High Church movement led by J. H. Newman. Clough was for a time carried away by the flood, and, although he recovered his equilibrium, it was not without an amount of mental disturbance and an expenditure of academic time, which perhaps accounted for his failure to obtain more than a second class in his final examination. He missed a Balliol fellowship, but obtained one at Oriel, with a tutorship, and lived the Oxford life of study, speculation, lectures and reading-parties for some years longer. Gradually, however, certain sceptical tendencies with regard to the current religious and social order grew upon him to such an extent as to render his position as an orthodox teacher of youth irksome, and in 1848 he resigned it. The immediate feeling of relief showed itself in buoyant, if thoughtful, literature, and he published poems both new and old. Then he travelled, seeing Paris in revolution and Rome in siege, and in the autumn of 1849 took up new duties as principal of University Hall, a hostel for students at University College, London. He soon found that he disliked London, in spite of the friendship of the Carlyles, nor did the atmosphere of Unitarianism prove any more congenial than that of Anglicanism to his critical and at bottom conservative temper. A prospect of a post in Sydney led him to engage himself to Miss Blanche Mary Shore Smith, and when it disappeared he left England in 1852, and went, encouraged by Emerson, to Cambridge, Massachusetts. Here he remained some months, lecturing and translating Plutarch for the booksellers, until in 1853 the offer of an examinership in the Education Office brought him to London once more. He married, and pursued a steady official career, diversified only by an appointment in 1856 as secretary to a commission sent to study certain aspects of foreign military education. At this, as at every period of his life, he enjoyed the warm respect and admiration of a small circle of friends, who learnt to look to him alike for unselfish sympathy and for spiritual and practical wisdom. In 1860 his health began to fail. He visited first Malvern and Freshwater, and then the East, France and Switzerland, in search of recovery, and finally came to Florence, where he was struck down by malaria and paralysis, and died on the 13th of November 1861. Matthew Arnold wrote upon him the exquisite lament of *Thyrsis*.

Shortly before he left Oxford, in the stress of the Irish potato-

famine, Clough wrote an ethical pamphlet addressed to the undergraduates, with the title, *A Consideration of Objections against the Retrenchment Association at Oxford* (1847). His Homeric pastoral *The Bothie of Tober-na-Fuossich*, afterwards rechristened *Tober-na-Vuolich* (1848), was inspired by a long vacation after he had given up his tutorship, and is full of socialism, reading-party humours and Scottish scenery. *Ambarvalia* (1849), published jointly with his friend Thomas Burbidge, contains shorter poems of various dates from 1840, or earlier, onwards. *Amours de Voyage*, a novel in verse, was written at Rome in 1849; *Dipsychus*, a rather amorphous satire, at Venice in 1850; and the idylls which make up *Mari Magno, or Tales on Board*, in 1861. A few lyric and elegiac pieces, later in date than the *Ambarvalia*, complete the tale of Clough's poetry. His only considerable enterprise in prose was a revision of the 17th century translation of Plutarch by Dryden and others, which occupied him from 1852, and was published as *Plutarch's Lives* (1859).

No part of Clough's life was wholly given up to poetry, and he probably had not the gift of detachment necessary to produce great literature in the intervals of other occupations. He wrote but little, and even of that little there is a good deal which does not aim at the highest seriousness. He never became a great craftsman. A few of his best lyrics have a strength of melody to match their depth of thought, but much of what he left consists of rich ore too imperfectly fused to make a splendid or permanent possession. Nevertheless, he is rightly regarded, like his friend Matthew Arnold, as one of the most typical English poets of the middle of the 19th century. His critical instincts and strong ethical temper brought him athwart the popular ideals of his day both in conduct and religion. His verse has upon it the melancholy and the perplexity of an age of transition. He is a sceptic who by nature should have been with the believers. He stands between two worlds, watching one crumble behind him, and only able to look forward by the sternest exercise of faith to the reconstruction that lies ahead in the other. On the technical side, Clough's work is interesting to students of metre, owing to the experiments which he made, in the *Bothie* and elsewhere, with English hexameters and other types of verse formed upon classical models.

Clough's *Poems* were collected, with a short memoir by F. T. Palgrave, in 1862; and his *Letters and Remains*, with a longer memoir, were privately printed in 1865. Both volumes were published together in 1869 and have been more than once reprinted. Another memoir is *Arthur Hugh Clough: A Monograph* (1883), by S. Waddington. Selections from the poems were made by Mrs Clough for the Golden Treasury series in 1894, and by E. Rhys in 1896. (E. K. C.)

CLOUTING, the technical name given to a light plain cloth used for covering butter and farmers' baskets, and for dish and pudding cloths. The same term is often given to light cloths of the nursery diaper pattern.

CLOVELLY, a fishing village in the Barnstaple parliamentary division of Devonshire, England, 11 m. W.S.W. of Bideford. Pop. (1901) 621. It is a cluster of old-fashioned cottages in a unique position on the sides of a rocky cleft in the north coast; its main street resembles a staircase which descends 400 ft. to the pier, too steeply to allow of any wheeled traffic. Thick woods shelter it on three sides, and render the climate so mild that fuchsias and other delicate plants flourish in midwinter. All Saints' church, restored in 1866, is late Norman, containing several monuments to the Carys, lords of the manor for 600 years. The surrounding scenery is famous for its richness of colour, especially in the grounds of Cary Court, and along "The Hobby," a road cut through the woods and overlooking the sea. Clovelly is described by Dickens in *A Message from the Sea*.

CLOVER, in botany, the English name for plants of the genus *Trifolium*, from Lat. *tres*, three, and *folium*, a leaf, so called from the characteristic form of the leaf, which has three leaflets (trifoliate), hence the popular name trefoil. It is a member of the family *Leguminosae*, and contains about three hundred species, found chiefly in north temperate regions, but also, like other north temperate genera, on the mountains in

the tropics. The plants are small annual or perennial herbs with trifoliate (rarely 5- or 7-foliolate) leaves, with stipules adnate to the leaf-stalk, and heads or dense spikes of small red, purple, white, or rarely yellow flowers; the small, few-seeded pods are enclosed in the calyx. Eighteen species are native in Britain, and several are extensively cultivated as fodder-plants. *T. pratense*, red or purple clover, is the most widely cultivated.

This plant, either sown alone or in mixture with rye-grass, has for a long time formed the staple crop for soiling; and so long as it grew freely, its power of shooting up again after repeated mowings, the bulk of crop thus obtained, its palatableness to stock and feeding qualities, the great range of soils and climate in which it grows, and its fitness either for pasturage or soiling, well entitled it to this preference. Except on certain rich calcareous clay soils, it has now, however, become an exceedingly precarious crop. The seed, when genuine, which unfortunately is very often not the case, germinates as freely as ever, and no greater difficulty than heretofore is experienced in having a full plant during autumn and the greater part of winter; but over most part of the country, the farmer, after having his hopes raised by seeing a thick cover of vigorous-looking clover plants over his field, finds to his dismay, by March or April, that they have either entirely disappeared, or are found only in capricious patches here and there over the field. No satisfactory explanation of this "clover-sickness" has yet been given, nor any certain remedy, of a kind to be applied to the soil, discovered. One important fact is, however, now well established, viz. that when the cropping of the land is so managed that clover does not recur at shorter intervals than eight years, it grows with much of its pristine vigour. The knowledge of this fact now determines many farmers in varying their rotation so as to secure this important end. At one time there was a somewhat prevalent belief that the introduction of beans into the rotation had a specific influence of a beneficial kind on the clover when it came next to be sown; but the true explanation seems to be that the beans operate favourably only by the incidental circumstance of almost necessarily lengthening the interval betwixt the recurrences of clover.

When the four-course rotation is followed, no better plan of managing this process has been yet suggested than to sow beans, pease, potatoes or tares, instead of clover, for one round, making the rotation one of eight years instead of four. The mechanical condition of the soil seems to have something to do with the success or failure of the clover crop. We have often noticed that headlands, or the converging line of wheel-tracks near a gateway at which the preceding root crop had been carted from a field, have had a good take of clover, when on the field generally it had failed. In the same way a field that has been much poached by sheep while consuming turnips upon it, and which has afterwards been ploughed up in an unkindly state, will have the clover prosper upon it, when it fails in other cases where the soil appears in far better condition. If red clover can be again made a safe crop, it will be a boon indeed to agriculture. Its seeds are usually sown along with a grain crop, any time from the 1st of February to May, at the rate of 12 lb to 20 lb per acre when not combined with other clovers or grasses.

Italian rye-grass and red clover are now frequently sown in mixture for soiling, and succeed admirably. It is, however, a wiser course to sow them separately, as by substituting the Italian rye-grass for clover, for a single rotation, the farmer not only gets a crop of forage as valuable in all respects, but is enabled, if he choose, to prolong the interval betwixt the sowings of clover to twelve years, by sowing, as already recommended, pulse the first round, Italian rye-grass the second, and clover the third.

These two crops, then, are those on which the arable-land farmer mainly relies for green forage. To have them good, he must be prepared to make a liberal application of manure. Good farm-yard dung may be applied with advantage either in autumn or spring, taking care to cart it upon the land only when it is dry enough to admit of this being done without injury. It must also be spread very evenly so soon as emptied from the

carts. But it is usually more expedient to use either guano, nitrate of soda, or soot for this purpose, at the rates respectively of 2 cwt., 1 cwt. and 20 bushels. If two or more of these substances are used, the quantities of each will be altered in proportion. They are best also to be applied in two or three portions at intervals of fourteen to twenty days, beginning towards the end of December, and only when rain seems imminent or has just fallen.

When manure is broadcast over a young clover field, and presently after washed in by rain, the effect is identical with that of first dissolving it in water, and then distributing the dilution over the surface, with this difference, namely, that the first plan costs only the price of the guano, &c., and is available at any time and to every one, whereas the latter implies the construction of tanks and costly machinery.

T. incarnatum, crimson or Italian clover, though not hardy enough to withstand the climate of Scotland in ordinary winters, is a most valuable forage crop in England. It is sown as quickly as possible after the removal of a grain crop at the rate of 18 lb to 20 lb per acre. It is found to succeed better when only the surface of the soil is stirred by the scarifier and harrow than when a ploughing is given. It grows rapidly in spring, and yields an abundant crop of green food, peculiarly palatable to live stock. It is also suitable for making into hay. Only one cutting, however, can be obtained, as it does not shoot again after being mown.

T. repens, white or Dutch clover, is a perennial abundant in meadows and good pastures. The flowers are white or pinkish, becoming brown and deflexed as the corolla fades. *T. hybridum*, Alsike or Swedish clover, is a perennial which was introduced early in the 19th century and has now become naturalized in Britain. The flowers are white or rosy, and resemble those of the last species. *T. medium*, meadow or zigzag clover, a perennial with straggling flexuous stems and rose-purple flowers, is of little agricultural value. Other British species are: *T. arvense*, hare's-foot trefoil, found in fields and dry pastures, a soft hairy plant with minute white or pale pink flowers and feathery sepals; *T. fragiferum*, strawberry clover, with densely-flowered, globose, rose-purple heads and swollen calyxes; *T. procumbens*, hop trefoil, on dry pastures and roadsides, the heads of pale yellow flowers suggesting miniature hops; and the somewhat similar *T. minus*, common in pastures and roadsides, with smaller heads and small yellow flowers turning dark brown. The last named is the true shamrock. Specimens of shamrock and other clovers are not infrequently found with four leaflets, and, like other rarities, are considered lucky. Calvary clover is a member of the closely allied genus *Medicago*—*M. Echinus*, so called from the curled spiny pod; it has small heads of yellow clover-like flowers, and is a native of the south of France.

CLOVES, the dried, unexpanded flower-buds of *Eugenia caryophyllata*, a tree belonging to the natural order Myrtaceae. They are so named from the French word *clou*, on account of their resemblance to a nail. The clove tree is a beautiful evergreen which grows to a height of from 30 to 40 ft., having large oval leaves and crimson flowers in numerous groups of terminal clusters. The flower-buds are at first of a pale colour and gradually become green, after which they develop into a bright red, when they are ready for collecting. Cloves are rather more than half an inch in length, and consist of a long cylindrical calyx, terminating in four spreading sepals, and four unopened petals which form a small ball in the centre. The tree is a native of the small group of islands in the Indian Archipelago called the Moluccas, or Spice Islands; but it was long cultivated by the Dutch in Amboyna and two or three small neighbouring islands. Cloves were one of the principal Oriental spices that early excited the cupidity of Western commercial communities, having been the basis of a rich and lucrative trade from an early part of the Christian era. The Portuguese, by doubling the Cape of Good Hope, obtained possession of the principal portion of the clove trade, which they continued to hold for nearly a century, when, in 1605, they were expelled

from the Moluccas by the Dutch. That power exerted great and inhuman efforts to obtain a complete monopoly of the trade, attempting to extirpate all the clove trees growing in their native islands, and to concentrate the whole production in the Amboyna Islands. With great difficulty the French succeeded in introducing the clove tree into Mauritius in the year 1770; subsequently the cultivation was introduced into Guiana, Brazil, most of the West Indian Islands and Zanzibar. The chief commercial sources of supply are now Zanzibar and its neighbouring island Pemba on the East African coast, and Amboyna. Cloves are also grown in Java, Sumatra, Réunion, Guiana and the West India Islands.

Cloves as they come into the market have a deep brown colour, a powerfully fragrant odour, and a taste too hot and acrid to be pleasant. When pressed with the nail they exude a volatile oil with which they are charged to the unusual proportion of about 18%. The oil is obtained as a commercial product by submitting the cloves with water to repeated distillation. It is, when new and properly prepared, a pale yellow or almost colourless fluid, becoming after some time of a brown colour; and it possesses the odour and taste peculiar to cloves. The essential oil of cloves—the *Oleum Caryophylli* of the British Pharmacopoeia—is a mixture of two substances, one of which is oxidized, whilst the other is not. *Eugenol*, or eugenic acid, $C_{10}H_{12}O_2$, is the chief constituent. It is capable of forming definite salts. The other constituent is a hydrocarbon $C_{15}H_{24}$, of which the distilling point differs from that of eugenol, and which solidifies only with intense cold. Oil of cloves is readily soluble in alcohol and ether, and has a specific gravity of about 1.055. Its dose is $\frac{1}{2}$ -3 minims. Besides this oil, cloves also contain two neutral bodies, eugenin and caryophyllin, the latter of which is an isomer of camphor. They are of no practical importance. The British Pharmacopoeia contains an infusion of cloves (*Infusum Caryophylli*), of which the strength is 1 part in 40 of boiling water and the dose $\frac{1}{2}$ -1 oz. Cloves are employed principally as a condiment in culinary operations, in confectionery, and in the preparation of *liqueurs*. In medicine they are tonic and carminative, but they are little used except as adjuncts to other substances on account of their flavour, or with purgatives to prevent nausea and griping. The essential oil forms a convenient medium for using cloves for flavouring purposes, it possesses the medicinal properties characteristic of a volatile oil, and it is frequently employed to relieve toothache. Oil of cloves is regarded by many dental surgeons as the most effective local anaesthetic they possess in cases where it is desired, before cutting a sensitive tooth for the purpose of filling it, to lower the sensibility of the dentine. For this purpose the cavity must be exposed to cotton wool saturated with the oil for about ten days.

CLOVIO, GIORGIO GIULIO (1498-1578), Italian painter, by birth a Croat and by profession a priest, is said to have learned the elements of design in his own country, and to have studied afterwards with intense diligence at Rome under Giulio Romano, and at Verona under Girolamo de' Libri. He excelled in historical pieces and portraits, painting as for microscopical examination, and yet contriving to handle his subjects with great force and precision. His book of twenty-six pictures representing the procession of Corpus Domini, in Rome, was the work of nine years, and the covers were executed by Benvenuto Cellini. The British Museum has his twelve miniatures of the victories of the emperor Charles V. In the Vatican library is preserved a manuscript life of Frederick, duke of Urbino, superbly illustrated by Clovio, who is *facile princeps* among Italian miniaturists. He was called Macedo, or Macedone, to connect him with his supposed Macedonian ancestry.

CLOVIS (*Chlodovech*) (c. 466-511), king of the Salian Franks, son of Childeric I., whom he succeeded in 481 at the age of fifteen. At that date the Salian Franks had advanced as far as the river Somme, and the centre of their power was at Tournai. On the history of Clovis between the years 481 and 486 the records are silent. In 486 he attacked Syagrius, a Roman general who, after the fall of the western empire in 476, had

carved out for himself a principality south of the Somme, and is called by Gregory of Tours "rex Romanorum." After being defeated by Clovis at the battle of Soissons, Syagrius sought refuge with the Visigothic king Alaric II., who handed him over to the conqueror. Henceforth Clovis fixed his residence at Soissons, which was in the midst of public lands, e.g. Berny-Rivière, Juvigny, &c. The episode of the vase of Soissons¹ has a legendary character, and all that it proves is the deference shown by the pagan king to the orthodox clergy. Clovis undoubtedly extended his dominion over the whole of Belgica Secunda, of which Reims was the capital, and conquered the neighbouring cities in detail. Little is known of the history of these conquests. It appears that St Geneviève defended the town of Paris against Clovis for a long period, and that Verdun-sur-Meuse, after a brave stand, accepted an honourable capitulation thanks to St Eusitius. In 491 some barbarian troops in the service of Rome, Arboruchi (*Ἀρβούρχοι*), Thuringians, and even Roman soldiers who could not return to Rome, went over to Clovis and swelled the ranks of his army.

In 493 Clovis married a Burgundian princess, Clotilda, niece of Gundobald and Godegesil, joint kings of Burgundy. This princess was a Christian, and earnestly desired the conversion of her husband. Although Clovis allowed his children to be baptized, he remained a pagan himself until the war against the Alemanni, who at that time occupied the country between the Vosges, and the Rhine and the neighbourhood of Lake Constance. By pushing their incursions westward they came into collision with Clovis, who marched against them and defeated them in the plain of the Rhine. The legend runs that, in the thickest of the fight, Clovis swore that he would be converted to the God of Clotilda if her God would grant him the victory. After subduing a part of the Alemanni, Clovis went to Reims, where he was baptized by St Remigius on Christmas day 496, together with three thousand Franks. The story of the phial of holy oil (the *Sainte Ampoule*) brought from heaven by a white dove for the baptism of Clovis was invented by Archbishop Hincmar of Reims three centuries after the event.

The baptism of Clovis was an event of very great importance. From that time the orthodox Christians in the kingdom of the Burgundians and Visigoths looked to Clovis to deliver them from their Arian kings. Clovis seems to have failed in the case of Burgundy, which was at that time torn by the rivalry between Godegesil and his brother Gundobald. Godegesil appealed for help to Clovis, who defeated Gundobald on the banks of the Ouche near Dijon, and advanced as far as Avignon (500), but had to retire without being able to retain any of his conquests. Immediately after his departure Gundobald slew Godegesil at Vienne, and seized the whole of the Burgundian kingdom. Clovis was more fortunate in his war against the Visigoths. Having completed the subjugation of the Alemanni in 506, he marched against the Visigothic king Alaric II. in the following year, in spite of the efforts of Theodoric, king of the Ostrogoths, to prevent the war. After a decisive victory at Vouillé near Poitiers, in which Clovis slew Alaric with his own hand, the whole of the kingdom of the Visigoths as far as the Pyrenees was added to the Frankish empire, with the exception of Septimania, which, together with Spain, remained in possession of Alaric's grandson Amalaric, and Provence, which was seized by Theodoric and annexed to Italy. In 508 Clovis received at Tours the insignia of the consulship from the eastern emperor, Anastasius, but the title was purely honorific. The last years of his life Clovis spent in Paris, which he made the capital of his kingdom, and where he built the church of the Holy Apostles, known later as the church of St Geneviève. By murdering the petty Frankish

¹ The story is as follows. The vase had been taken from a church by a Frankish soldier after the battle of Soissons, and the bishop had requested Clovis that it might be restored. But the soldier who had taken it refused to give it up, and broke it into fragments with his *francisca*, or battle-axe. Some time afterwards, when Clovis was reviewing his troops, he singled out the soldier who had broken the vase, upbraided him for the neglect of his arms, and dashed his *francisca* to the ground. As the man stooped to pick it up, the king clove his skull with the words: "Thus didst thou serve the vase of Soissons."

kings who reigned at Cambrai, Cologne and other residences, he became sole king of all the Frankish tribes. He died in 511.

Clovis was the true founder of the Frankish monarchy. He reigned over the Salian Franks by hereditary right; over the other Frankish tribes by reason of his kinship with their kings and by the choice of the warriors, who raised him on the shield; and he governed the Gallo-Romans by right of conquest. He had the Salic law drawn up, doubtless between the years 486 and 507; and seems to have been represented in the cities by a new functionary, the *graf*, *comes*, or count. He owed his success in great measure to his alliance with the church. He took the property of the church under his protection, and in 511 convoked a council at Orleans, the canons of which have come down to us. But while protecting the church, he maintained his authority over it. He intervened in the nomination of bishops, and at the council of Orleans it was decided that no one, save a son of a priest, could be ordained clerk without the king's order or the permission of the count.

The chief source for the life of Clovis is the *Historia Francorum* (bk. ii.) of Gregory of Tours, but it must be used with caution. Among modern works, see W. Junghans, *Die Geschichte der fränkischen Könige Childerich und Clodovech* (Göttingen, 1857); F. Dahn, *Urgeschichte der germanischen und romanischen Völker*, vol. iii. (Berlin, 1883); W. Schultze, *Deutsche Geschichte v. d. Urzeit bis zu den Karolingern*, vol. ii. (Stuttgart, 1896); G. Kurth, *Clovis* (2nd ed., Paris, 1901).

(C. PF.)

CLOWN (derived by Fuller, in his *Worthies*, from Lat. *colonus*, a husbandman; but apparently connected with "clod" and with similar forms in Teutonic and Scandinavian languages), a rustic, boorish person; the comic character in English pantomime, always dressed in baggy costume, with face whitened and eccentrically painted, and a tufted wig. The character probably descends from representations of the devil in medieval miracle-plays, developed partly through the stage rustics and partly through the fools or jesters (also called clowns) of the Elizabethan drama. The whitened face and baggy costume indicate a connexion also with the continental Pierrot. The prominence of the clown in pantomime (*q.v.*) is a comparatively modern development as compared with that of Harlequin.

CLOYNE, a small market town of Co. Cork, Ireland, in the east parliamentary division, 15 m. E. S. E. of the city of Cork. Pop. (1901) 827. It gives its name to a Roman Catholic diocese, the cathedral of which is at Queenstown. Cloyne was the seat of a Protestant diocese until 1835, when it was united to that of Cork. It was originally a foundation of the 6th century. The cathedral church, dedicated to its founder St Colman, a disciple of St Finbar of Cork, is a plain cruciform building mainly of the 14th century, with an earlier oratory in the churchyard. It contains a few handsome monuments to its former bishops, but until 1890, when a monument was erected, had nothing to preserve the memory of the illustrious Dr George Berkeley, who held the see from 1734 to 1753. Opposite the cathedral is a very fine round tower 100 ft. in height, though the conical roof has long been destroyed. The Roman Catholic church is a spacious building of the early 19th century. The town was several times plundered by the Danes in the 9th century; it was laid waste by Dermot O'Brien in 1071, and was burned in 1137. In 1430 the bishopric was united to that of Cork; in 1638 it again became independent, and in 1660 it was again united to Cork and Ross. In 1678 it was once more declared independent, and so continued till 1835. The name, *Cluain-Uamha*, signifies "the meadow of the cave," from the curious limestone caves in the vicinity. The Pipe Roll of Cloyne, compiled by Bishop Swaffham in 1364, is a remarkable record embracing a full account of the feudal tenures of the see, the nature of the impositions, and the duties the *puri homines Sancti Colmani* were bound to perform at a very early period. The roll is preserved in the record office, Dublin. It was edited by Richard Caulfield in 1859.

CLUB (connected with "clump"), (1) a thick stick, used as a weapon, or heavy implement for athletic exercises ("Indian club," &c.); (2) one of the four suits of playing-cards,—the translation of the Spanish *basto*—represented by a black trefoil

(taken from the French, in which language it is *trèfle*); (3) a term given to a particular form of association of persons. It is to this third sense that this article is devoted.

By the term "club," the most general word for which is in Gr. *ἐταιρία*, in Lat. *sodalitas*, is here meant an association within the state of persons not united together by any natural ties of kinship, real or supposed. Modern clubs are dealt with below, and we begin with an account of Greek and Roman clubs. Such clubs are found in all ancient states of which we have any detailed knowledge, and seem to have dated in one form or another from a very early period. It is not unreasonable to suppose, in the absence of certain information, that the rigid system of groups of kin, *i.e.* family, *gens*, *phratría*, &c., affording no principle of association beyond the maintenance of society as it then existed, may itself have suggested the formation of groups of a more elastic and expansive nature; in other words, that clubs were an expedient for the deliverance of society from a too rigid and conservative principle of crystallization.

Greek.—The most comprehensive statement we possess as to the various kinds of clubs which might exist in a single Greek state is contained in a law of Solon quoted incidentally in the Digest of Justinian (47-22), which guaranteed the administrative independence of these associations provided they kept within the bounds of the law. Those mentioned (apart from demes and phratries, which were not clubs as here understood) are associations for religious purposes, for burial, for trade, for privateering (*ἐπι λείαν*), and for the enjoyment of common meals. Of these by far the most important are the religious clubs, about which we have a great deal of information, chiefly from inscriptions; and these may be taken as covering those for burial purposes and for common meals, for there can be no doubt that all such unions had originally a religious object of some kind. But we have to add to Solon's list the political *ἐταιρία* which we meet with in Athenian history, which do not seem to have always had a religious object, whatever their origin may have been; and it may be convenient to clear the ground by considering these first.

In the period between the Persian and Peloponnesian wars we hear of hetairies within the two political parties, oligarchic and democratic; Themistocles is said (Plut. *Aristides*, 2) to have belonged to one, Pericles' supporters seem to have been thus organized (Plut. *Per.* 7 and 13), and Cimon had a hundred *hetairoi* devoted to him (Plut. *Cim.* 17). These associations were used, like the *collegia sodalicia* at Rome (see below), for securing certain results at elections and in the law-courts (Thuc. viii. 54), and were not regarded as harmful or illegal. But the bitterness of party struggles in Greece during the Peloponnesian War changed them in many states into political engines dangerous to the constitution, and especially to democratic institutions; Aristotle mentions (*Politics*, p. 1310 a) a secret oath taken by the members of oligarchic clubs, containing the promise, "I will be an enemy to the people, and will devise all the harm I can against them." At Athens in 413 B.C. the conspiracy against the democracy was engineered by means of these clubs, which existed not only there but in the other cities of the empire (Thuc. viii. 48 and 54), and had now become secret conspiracies (*συνωμοσίαι*) of a wholly unconstitutional kind. On this subject see Grote, *Hist. of Greece*, v. 360; A. H. J. Greenidge, *Handbook of Greek Constitutional History*, 208 foll.

Passing over the clubs for trade or plunder mentioned in Solon's law, of which we have no detailed knowledge, we come to the religious associations. These were known by several names, especially *thiasi*, *eranoi* and *orgeones*, and it is not possible to distinguish these from each other in historical times, though they may have had different origins. They had the common object of sacrifice to a particular deity; the *thiasi* and *orgeones* seem to be connected more especially with foreign deities whose rites were of an orgiastic character. The organization of these societies is the subject of an excellent treatise by Paul Foucart (*Les Associations religieuses chez les Grecs*, Paris, 1873), still indispensable, from which the following particulars are chiefly drawn. For the greater part of them the evidence consists of

inscriptions from various parts of Greece, many of which were published for the first time by Foucart, and will be found at the end of his book.

The first striking point is that the object of all these associations is to maintain the worship of some *foreign* deity, *i.e.* of some deity who was not one of those admitted and guaranteed by the state—the divine inhabitants of the city, as they may be called. For all these the state made provision of priests, temples, sacrifices, &c.; but for all others these necessities had to be looked after by private individuals associated for the purpose. The state, as we see from the law of Solon quoted above, made no difficulty about the introduction of foreign worships, provided they did not infringe the law and were not morally unwholesome, and regarded these associations as having all the rights of legal corporations. So we find the cult of deities such as Sabazius, Mater Magna (see GREAT MOTHER OF THE GODS) and Attis, Adonis, Isis, Serapis, Mên Tyrannos, carried on in Greek states, and especially in seaports like the Peiræus, Rhodes, Smyrna, without protest, but almost certainly without moral benefit to the worshippers. The famous passage in Demosthenes (*de Corona*, sect. 250 foll.) shows, however, that the initiation at an early age in the rites of Sabazius did not gain credit for Aeschines in the eyes of the best men. We are not surprised to find that, in accordance with the foreign character of the cults thus maintained, the members of the associations are rarely citizens by birth, but women, freedmen, foreigners and even slaves. Thus in an inscription found by Sir C. Newton at Cnidus, which contains a mutilated list of members of a *Ithiasos*, one only out of twelve appears to be a Cnidian citizen, four are slaves, seven are probably foreigners. Hence we may conclude that these associations were of importance, whether for good or for evil, in organizing and encouraging the foreign population in the cities of Greece.

The next striking fact is that these associations were organized, as we shall also find them at Rome, in imitation of the constitution of the city itself. Each had its law, its assembly, its magistrates or officers (*i.e.* secretary, treasurer) as well as priests or priestesses, and its finance. The law regulated the conditions of admission, which involved an entrance fee and an examination (*δοκιμασία*) as to character; the contributions, which had to be paid by the month, and the steps to be taken to enforce payment, *e.g.* exclusion in case of persistent neglect of this duty; the use to be made of the revenues, such as the building or maintenance of temple or club-house, and the cost of crowns or other honours voted by the assembly to its officers. This assembly, in accordance with the law, elected its officers once a year, and these, like those of the state itself, took an oath on entering office, and gave an account of their stewardship at the end of the year. Further details on these points of internal government will be found in Foucart's work (pp. 20 foll.), chiefly derived from inscriptions of the orgeones engaged in the cult of the Mother of the Gods at the Peiræus. The important question whether these religious associations were in any sense benefit clubs, or relieved the sick and needy, is answered by him emphatically in the negative.

As might naturally be supposed, the religious clubs increased rather than diminished in number and importance in the later periods of Greek history, and a large proportion of the inscriptions relating to them belong to the Macedonian and Roman empires. One of the most interesting, found in 1868, belongs to the 2nd century A.D., *viz.* that which reveals the worship of Mên Tyrannos at Laurium (Foucart, pp. 119 foll.). This Phrygian deity was introduced into Attica by a Lycian slave, employed by a Roman in working the mines at Laurium. He founded the cult and the *cranos* which was to maintain it, and seems also to have drawn up the law regulating its ritual and government. This may help us to understand the way in which similar associations of an earlier age were instituted.

Roman.—At Rome the principle of private association was recognized very early by the state; *sodalitates* for religious purposes are mentioned in the XII. Tables (Gaius in *Digest*, 47. 22. 4), and *collegia opificum*, or trade guilds, were believed

to have been instituted by Numa, which probably means that they were regulated by the *jus divinum* as being associated with particular worships. It is difficult to distinguish between the two words *collegium* and *sodalitas*; but *collegium* is the wider of the two in meaning, and may be used for associations of all kinds, public and private, while *sodalitas* is more especially a union for the purpose of maintaining a cult. Both words indicate the permanence of the object undertaken by the association, while a *societas* is a temporary combination without strictly permanent duties. With the *societates publicanorum* and other contracting bodies of which money-making was the main object, we are not here concerned.

The *collegia opificum* ascribed to Numa (Plut. *Numa*, 17) include guilds of weavers, fullers, dyers, shoemakers, doctors, teachers, painters, &c., as we learn from Ovid, *Fasti*, iii. 819 foll., where they are described as associated with the cult of Minerva, the deity of handiwork; Plutarch also mentions flute-players, who were connected with the cult of Jupiter on the Capitol, and smiths, goldsmiths, tanners, &c. It would seem that, though these guilds may not have had a religious origin as some have thought, they were from the beginning, like all early institutions, associated with some cult; and in most cases this was the cult of Minerva. In her temple on the Aventine almost all these *collegia* had at once their religious centre and their business headquarters. When during the Second Punic War a guild of poets was instituted, this too had its meeting-place in the same temple. The object of the guild in each case was no doubt to protect and advance the interests of the trade, but on this point we have no sufficient evidence, and can only follow the analogy of similar institutions in other countries and ages. We lose sight of them almost entirely until the age of Cicero, when they reappear in the form of political clubs (*collegia sodalicia* or *compitalicia*) chiefly with the object of securing the election of candidates for magistracies by fair or foul means—usually the latter (see esp. *Cic. pro Plancio, passim*). These were suppressed by a *senatusconsultum* in 64 B.C., revived by Clodius six years later, and finally abolished by Julius Caesar, as dangerous to public order. Probably the old trade guilds had been swamped in the vast and growing population of the city, and these, inferior and degraded both in personnel and objects, had taken their place. But the principle of the trade guild reasserts itself under the Empire, and is found at work in Rome and in every municipal town, attested abundantly by the evidence of inscriptions. Though the right of permitting such associations belonged to the government alone, these trade guilds were recognized by the state as being instituted "*ut necessariam operam publicis utilitatibus exhiberent*" (*Digest*, 50. 6. 6). Every kind of trade and business throughout the Empire seems to have had its *collegium*, as is shown by the inscriptions in the *Corpus* from any Roman municipal town; and the life and work of the lower orders of the municipales are shadowed forth in these interesting survivals. The primary object was no doubt still to protect the trade; but as time went on they tended to become associations for feasting and enjoyment, and more and more to depend on the munificence of patrons elected with the object of eliciting it. Fuller information about them will be found in G. Boissier, *La Religion romaine d'Auguste aux Antonins*, ii. 286 foll., and S. Dill, *Roman Society from Nero to Marcus Aurelius*, pp. 264 foll. How far they formed a basis or example for the guilds of the early middle ages is a difficult question which cannot be answered here (see *GILDS*); it is, however, probable that they gradually lost their original business character, and became more and more associations for procuring the individual, lost as he was in the vast desert of the empire, some little society and enjoyment in life, and the certainty of funeral rites and a permanent memorial after death.

We may now return to the associations formed for the maintenance of cults, which were usually called *sodalitates*, though the word *collegium* was also used for them, as in the case of the college of the Arval Brothers (*q.v.*). Of the ancient *Sodales Titii* nothing is known until they were revived by Augustus; but it seems probable that when a gens or family charged with

the maintenance of a particular cult had died out, its place was supplied by a *sodalitas* (Marquardt, *Staatsverwaltung*, iii. 134). The introduction of new cults also led to the institution of new associations; thus in 495 B.C. when the worship of Minerva was introduced, a *collegium mercatorum* was founded to maintain it, which held its feast on the *dies natalis* (dedication day) of the temple (Liv. ii. 27. 5); and in 387 the *ludi Capitolini* were placed under the care of a similar association of dwellers on the Capitoline hill. In 204 B.C. when the Mater Magna was introduced from Pessinus (see GREAT MOTHER OF THE GODS) a *sodalitas* (or *sodalitates*) was instituted which, as Cicero tells us (*de Seneca*. 13. 45) used to feast together during the *ludi Megalenses*. All such associations were duly licensed by the state, which at all times was vigilant in forbidding the maintenance of any which it deemed dangerous for religious or political reasons; thus in 186 B.C. the senate, by a decree of which part is preserved (*C.I.L.* i. 43), made all combination for promoting the Bacchic religious rites strictly illegal. But legalized *sodalitates* are frequent later; the temple of Venus Genetrix, begun by Julius and finished by Augustus, had its *collegium* (Pliny, *N.H.* ii. 93), and *sodalitates* were instituted for the cult of the deified emperors Augustus, Claudius, &c.

We thus arrive by a second channel at the *collegia* of the empire. Both the history of the trade guilds and that of the religious *collegia* or *sodalitates* conduct us by a course of natural development to that extraordinary system of private association with which the empire was honeycombed.

As has been already said of the trade guilds, the main objects of association seem to have been to make life more enjoyable and to secure a permanent burial-place; and of these the latter was probably the primary or original one. It was a natural instinct in the classical as in the pre-classical world to wish to rest securely after death, to escape neglect and oblivion. This is not the place to explain the difficulties which the poorer classes in the Roman empire had to face in satisfying this instinct; but since the publication of the *Corpus Inscriptionum* has made us familiar with the conditions of the life of these classes, there can be no doubt that this was always a leading motive in their passion for association. In the year A.D. 133 under Hadrian this instinct was recognized by law, *i.e.* by a *senatusconsultum* which has fortunately come down to us. It was engraved at the head of their own regulations by a *collegium* instituted for the worship of Diana and Antinous at Lanuvium, and runs thus: "*Qui stipem menstruam conferre volent in funera, in id collegium coeant, neque sub specie ejus collegii nisi semel in mense coeant conferendi causa unde defuncti sepeliantur*" (*C.I.L.* xiv. 2112). From the *Digest*, 47. 22. 1, the *locus classicus* on this subject, we learn that this was a general law allowing the founding of funerary associations, provided that the law against illicit *collegia* were complied with, and it was natural that from that time onwards such *collegia* should spring up in every direction. The inscription of Lanuvium, together with many others (for which see the works of Boissier and Dill already cited), has given us a clear idea of the constitution of these colleges. Their members were as a rule of the humblest classes of society, and often included slaves; from each was due an entrance fee and a monthly subscription, and a funeral grant was made to the heir of each member at his death in order to bury him in the burying-place of the college, or if they were too poor to construct one of their own, to secure burial in a public *columbarium*. The instinct of the Roman for organization is well illustrated in the government of these colleges. They were organized on exactly the same lines as the municipal towns of the empire; their officers were elected, usually for a year, or in the case of honorary distinctions, for life; as in a municipal town, they were called *quinquennales*, *curatores*, *praefecti*, &c., and quaestors superintended the finances of the association. Their place of meeting, if they were rich enough to have one, was called *schola* and answered the purpose of a club-house; the site or the building was often given them by some rich patron, who was pleased to see his name engraved over its doorway. Here we come upon one of those defects in the society of the empire which seem

gradually to have sapped the virility of the population—the desire to get others to do for you what you are unwilling or unable to do for yourself. The *patroni* increased in number, and more and more the colleges acquired the habit of depending on their benefactions, while at the same time it would seem that the primary object of burial became subordinate to the claims of the common weal. It may also be asserted with confidence, as of the Greek clubs, that these *collegia* rarely or never did the work of our benefit clubs, by assisting sick or infirm members; such objects at any rate do not appear in the inscriptions. The only exceptions seem to be the military *collegia*, which, though strictly forbidden as dangerous to discipline, continued to increase in number in spite of the law. The great legionary camps of the Roman province of Africa (Cagnat, *L'Armée romaine*, 457 foll.) have left us inscriptions which show not only the existence of these clubs, but the way in which their funds were spent; and it appears that they were applied to useful purposes in the life of a member as well as for his burial, *e.g.* to travelling expenses, or to his support after his discharge (see especially *C.I.L.* viii. 2552 foll.).

As the Roman empire became gradually impoverished and depopulated, and as the difficulty of defending its frontiers increased, these associations must have been slowly extinguished, and the living and the dead citizen alike ceased to be the object of care and contribution. The sudden invasion of Dacia by barbarians in A.D. 166 was followed by the extinction of one *collegium* which has left a record of the fact, and probably by many others. The master of the college of Jupiter Cernenius, with the two quaestors and seven witnesses, attest the fact that the college has ceased to exist. "The accounts have been wound up, and no balance is left in the chest. For a long time no member has attended on the days fixed for meetings, and no subscriptions have been paid" (Dill, *op. cit.* p. 285). The record of similar extinctions in the centuries that followed, were they extant, would show us how this interesting form of crystallization, in which the well-drilled people of the empire displayed an unusual spontaneity, gradually melted away and disappeared (see further GILDS and CHARITY AND CHARITIES).

Besides the works already cited may be mentioned Mommsen, *de Collegiis et Sodalitiis* (1843), which laid the foundation of all subsequent study of the subject; Marquardt, *Staatsverwaltung*, iii. 134 foll.; de Marchi, *Il Culto privato di Roma antica*, ii. 75 foll.; Kornemann, s. v. "Collegium" in Pauly-Wissowa, *Realencyclopädie*. (W. W. F.)*

Modern Clubs.—The word "club," in its modern sense of an association to promote good-fellowship and social intercourse, is not very old, only becoming common in England at the time of *The Tatler* and *The Spectator* (1709-1712). It is doubtful whether its use originated in its meaning of a knot of people, or from the fact that the members "clubbed" together to pay the expenses of their meetings. The oldest English clubs were merely informal periodic gatherings of friends for the purpose of dining or drinking together. Thomas Occleve (*temp.* Henry IV) mentions such a club called *La Court de Bone Compaignie*, of which he was a member. John Aubrey (writing in 1659) says: "We now use the word *clubbe* for a sodality in a tavern." Of these early clubs the most famous was the Bread Street or Friday Street Club, originated by Sir Walter Raleigh, and meeting at the Mermaid Tavern. Shakespeare, Beaumont, Fletcher, Selden and Donne were among the members. Another such club was that which met at the Devil Tavern near Temple Bar; and of this Ben Jonson is supposed to have been the founder.

With the introduction of coffee-drinking in the middle of the 17th century, clubs entered on a more permanent phase. The coffee-houses of the later Stuart period are the real originals of the modern club-house. The clubs of the late 17th and early 18th century type resembled their Tudor forerunners in being oftenest associations solely for conviviality or literary coteries. But many were confessedly political, *e.g.* The Rota, or Coffee Club (1659), a debating society for the spread of republican ideas, broken up at the Restoration, the Calves Head Club (*c.* 1693) and the Green Ribbon Club (1675) (*q.v.*). The characteristics of all these clubs were: (1) no permanent financial bond between

the members, each man's liability ending for the time being when he had paid his "score" after the meal; (2) no permanent club-house, though each clique tended to make some special coffee-house or tavern their headquarters. These coffee-house clubs soon became hotbeds of political scandal-mongering and intriguing, and in 1675 Charles II. issued a proclamation which ran, "His Majesty hath thought fit and necessary that coffee houses be (for the future) put down and suppressed," owing to the fact "that in such houses divers false, malicious and scandalous reports are devised and spread abroad to the Defamation of his Majesty's Government and to the Disturbance of Peace and Quiet of the Realm." So unpopular was this proclamation that it was almost instantly found necessary to withdraw it, and by Anne's reign the coffee-house club was a feature of England's social life.

From the 18th-century clubs two types have been evolved. (1) The social and dining clubs, permanent institutions with fixed club-house. The London coffee-house clubs in increasing their members absorbed the whole accommodation of the coffee-house or tavern where they held their meetings, and this became the club-house, often retaining the name of the original keeper, e.g. White's, Brooks's, Arthur's, Boodle's. The modern club, sometimes proprietary, i.e. owned by an individual or private syndicate, but more frequently owned by the members who delegate to a committee the management of its affairs, first reached its highest development in London, where the district of St James's has long been known as "Clubland", but the institution has spread all over the English-speaking world. (2) Those clubs which have but occasional or periodic meetings and often possess no club-house, but exist primarily for some specific object. Such are the many purely athletic, sports and pastimes clubs, the Jockey Club, the Alpine, chess, yacht and motor clubs. Then there are literary clubs, musical and art clubs, publishing clubs; and the name of "club" has been annexed by a large group of associations which fall between the club proper and mere friendly societies, of a purely periodic and temporary nature, such as slate, goose and Christmas clubs, which are not required to be registered under the Friendly Societies Act.

Thus it is seen that the modern club has little in common with its prototypes in the 18th century. Of those which survive in London the following may be mentioned: White's, originally established in 1698 as White's Chocolate House, became the headquarters of the Tory party, but is to-day no longer political. Brooks's (1764), originally the resort of the Whigs, is no longer strictly associated with Liberalism. Boodle's (1762) had a tradition of being the resort of country gentlemen, and especially of masters of foxhounds. Arthur's (1765), originally an offshoot of White's, has always been purely social. The Cocoa Tree (1746) also survives as a social resort. Social clubs, without club-houses, are represented by the Literary Club ("The Club"), founded in 1764 by Sir Joshua Reynolds and Dr Johnson, and such recent institutions as the Johnson Club, Ye Sette of Odd Volumes (founded by Bernard Quaritch) and many others.

The number of regularly established clubs in London is now upwards of a hundred. Of these the more important, with the dates of their establishment, are: Army and Navy (1837); Athenaeum (1824), founded by Sir Walter Scott and Thomas Moore "for the association of individuals known for their scientific or literary attainments, artists of eminence in any class of the fine arts, and noblemen and gentlemen distinguished as liberal patrons of science, literature or the arts"; Bachelors' (1881); Carlton (1832), the chief Conservative club, City Carlton (1868); Conservative (1840); Constitutional (1883); Devonshire (1875); East India United Service (1849); Garrick (1831), "for the general patronage of the drama, for bringing together the supporters of the drama, and for the formation of a theatrical library with works on costume"; Guards (1813); Junior Athenaeum (1864); Junior Carlton (1864); Marlborough (1869); National Liberal (1882); Oriental (1824), Oxford and Cambridge (1830); Reform (1837), formerly the Liberal headquarters; Savage (1857); St James's (1857), diplomatic;

Travellers' (1819), for which a candidate must have "travelled out of the British Islands to a distance of at least 500 m. from London in a direct line"; Turf (1868); Union (1822); United Service (1815); Wellington (1885); Windham (1828). Almost every interest, rank and profession has its club. Thus there is a Press Club, a Fly-Fishers' Club, a Gun Club, an Authors', a Farmers', a Lawyers' (the Eldon) and a Bath Club. Of the purely women's clubs the most important are the Alexandra (1884), the Empress (1897), Lyceum (1904) and Ladies' Army & Navy (1904); while the Albemarle and the Sesame have a leading place among clubs for men and women. Of political clubs having no club-house, the best known are the Cobden (Free Trade, 1866); the Eighty (Liberal, 1880) and the United (Unionist, 1886). There are clubs in all important provincial towns, and at Edinburgh the New Club (1787), and in Dublin the Kildare Street (1790), rival those of London.

The mode of election of members varies. In some clubs the committee alone have the power of choosing new members. In others the election is by ballot of the whole club, one black ball in ten ordinarily excluding. In the Athenaeum, whilst the principle of election by ballot of the whole club obtains, the duty is also cast upon the committee of annually selecting nine members who are to be "of distinguished eminence in science, literature or the arts, or for public services," and the rule makes stringent provision for the conduct of these elections. On the committee of the same club is likewise conferred power to elect without ballot princes of the blood royal, cabinet ministers, bishops, the speaker of the House of Commons, judges, &c.

The affairs of clubs are managed by committees constituted of the trustees, who are usually permanent members, and of ordinarily twenty four other members, chosen by the club at large, one-third of whom go out of office annually. These committees have plenary powers to deal with the affairs of the club committed to their charge, assembling weekly to transact current business and audit the accounts. Once a year a meeting of the whole club is held, before which a report is laid, and any action taken thereupon which may be necessary. (See J. Wertheimer, *The Law relating to Clubs*, 1903; and Sir E. Carson on Club law, in vol. iii. of *The Laws of England*, 1909.)

Previous to 1902 clubs in England had not come within the purview of the licensing system. The Licensing Act of 1902, however, remedied that defect, and although it was passed principally to check the abuse of "clubs" being formed solely to sell intoxicating liquors free from the restrictions of the licensing acts, it applied to *all* clubs in England and Wales, of whatever kind, from the humblest to the most exalted Pall Mall club. The act required the registration of every club which occupied any premises habitually used for the purposes of a club and in which intoxicating liquor was supplied to members or their guests. The secretary of every club was required to furnish to the clerk to the justices of the petty sessional division a return giving (a) the name and objects of the club; (b) the address of the club, (c) the name of the secretary; (d) the number of members; (e) the rules of the club relating to (i.) the election of members and the admission of temporary and honorary members and of guests; (ii.) the terms of subscription and entrance fee, if any; (iii.) the cessation of membership; (iv.) the hours of opening and closing; and (v.) the mode of altering the rules. The same particulars must be furnished by a secretary before the opening of a new club. The act imposed heavy penalties for supplying and keeping liquor in an unregistered club. The act gave power to a court of summary jurisdiction to strike a club off the register on complaint in writing by any person on any of various grounds, e.g. if its members numbered less than twenty-five; if there was frequent drunkenness on the premises, if persons were habitually admitted as members without forty-eight hours' interval between nomination and admission; if the supply of liquor was not under the control of the members or the committee, &c. The Licensing (Scotland) Act 1903 made Scottish clubs liable to registration in a similar manner.

In no other country did club-life attain such an early perfection

as in England. The earliest clubs on the European continent were of a political nature. These in 1848 were repressed in Austria and Germany, and the modern clubs of Berlin and Vienna are mere replicas of their English prototypes. In France, where the term *cercle* is most usual, the first was Le Club Politique (1782), and during the Revolution such associations proved important political forces (see JACOBIENS, FEUILLANTS, CORDELIERS). Of the modern purely social clubs in Paris the most notable are The Jockey Club (1833) and the Cercle de la Rue Royale.

In the United States clubs were first established after the War of Independence. One of the first in date was the Hoboken Turtle Club (1797), which still survives. Of the modern clubs in New York the Union (1836) is the earliest, and other important ones are the Century (1847), Union League (1863), University (1865), Knickerbocker (1871), Lotus (1870), Manhattan (1865), and Metropolitan (1891). But club-life in American cities has grown to enormous proportions; the number of excellent clubs is now legion, and their hospitality has become proverbial. The chief clubs in each city are referred to in the topographical articles.

Walter Arnold, *Life and Death of the Sublime Society of Beefsteaks* (1871); John Aubrey, *Letters of Eminent Persons* (2 vols.); C. Marsh, *Clubs of London, with Anecdotes of their Members, Sketches of Character and Conversation* (2 vols., 1832); *Notes and Queries*, 3rd series, vols. 1, 9, 10; W. H. Pyne, *Wine and Walnuts* (2 vols., 1823); Admiral Smyth, *Sketch of the Use and Progress of the Royal Society Club* (1860); John Timbs, *Club Life of London, with Anecdotes of Clubs, Coffee-Houses and Taverns* (2 vols., 1866), and *History of Clubs and Club Life* (1872); Th. Walker, *The Original*, fifth edition, by W. A. Guy (1875); *The Secret History of Clubs of all Descriptions* by Ned Ward (1709); *Complete and Humorous Account of all the Remarkable Clubs and Societies in the Cities of London and Westminster*, by Ned Ward (7th edition, 1756); *The London Clubs; Their Anecdotes, History, Private Rules and Regulations* (12mo, 1853); Rev. A. Hume, *Learned Societies and Printing Clubs* (1847); J. Strang, *Glasgow and its Clubs* (1857); A. F. Leach, *Club Cases* (1879); Col. G. J. Ivey, *Clubs of the World* (1880); J. Wertheimer, *Law relating to Clubs* (1885); L. Fagan, *The Reform Club* (1887); F. G. Waugh, *Members of the Athenæum Club* (privately printed 1888).

CLUB-FOOT (*talipes*), the name given to deformities of the foot, some of which are congenital, others acquired—the latter being chiefly due to infantile paralysis. *Talipes equinus* is that form in which the heel does not touch the ground, the child resting on the toes. In *talipes varus* the foot is turned inwards and shortened, the inner edge of the foot is raised, and the child walks on the outer edge. These two conditions are often combined, the heel being drawn up and the foot twisted inward; the name given to the twofold deformity is *talipes equino-varus*. It is the most usual congenital form. In *talipes calcaneus* the toes are pointed upwards and the foot rests on the heel. This is always an acquired (paralytic) deformity.

The treatment of congenital club-foot, which is almost invariably *varus* or *equino-varus*, should be begun as soon as ever the abnormal condition of the foot is recognized. The nurse should be shown how to twist and coax the foot into the improved position, and should so hold it in her hand many times a day. And thus by daily, or, one might almost say, hourly manipulations, much good may be accomplished without distress to the infant. If after weeks or months of these measures insufficient progress has been made, the subcutaneous division of a tendon or two, or of some tendons and ligaments may be necessary, the foot being subsequently fixed up in the improved position in plaster of Paris. If these subcutaneous operations also prove disappointing, or if after their apparently successful employment the foot constantly relapses into the old position, a more radical procedure will be required. Of the many procedures which have been adopted there is, probably, none equal to that of free transverse incision introduced by the late Dr A. M. Phelps of New York. By this "open method" the surgeon sees exactly what structures are at fault and in need of division—skin, fasciæ tendons, ligaments; everything, in short, which prevented the easy rectification of the deformity. After the operation, the foot is fixed, without any strain, in an over-corrected position, between plaster of Paris splints. By the adoption of this method the old instrument of torture known as "Scarpa's

shoe" has become obsolete, as have also some of those operations which effected improvement of the foot by the removal of portions of the bony arch. Phelps's operation removes the deformity by increasing the length of the concave border of the foot rather than by shortening the convex borders as in cuneiform osteotomy; it is a levelling up, not a levelling down.

Talipes valgus is very rare as a congenital defect, but is common enough as a result of infantile paralysis and as such is apt to be combined with the calcanean variety. "Flat-foot" is sometimes spoken of as *spurious talipes valgus*; it is due to the bony arches of the foot being called upon to support a weight beyond their power. The giving way of the arches may be due to weakness of the muscles, tendons or ligaments—probably of all three. It is often met with in feeble and flabby children, and in nurses, waiters, policemen and others whose feet grow tired from much standing. Exercises on tip-toe, especially with a skipping rope, massage, rest and tonic treatment will give relief, and shoes or boots may be supplied with the heel and sole thickened along the inner borders so that the weight may be received along the strong outer border of the foot. When the flat-footed individual stands it should be upon the outer borders of his feet, or better still, when convenient, on tip-toe, as this posture strengthens those muscles of the leg which run into the sole of the foot and hold up the bony arches. In certain extreme cases the surgeon wrenches the splay feet into an inverted position and fixes them in plaster of Paris, taking off the casing every day for the purpose of massage and exercises.

Flat-foot is often associated with knock-knee in children and young adults who are the subject of rickets.

Morton's Disease.—In some cases of flat-foot the life of the individual is made miserable by neuralgia at the root of the toes, which comes on after much standing or walking, the distress being so great that, almost regardless of propriety, he is compelled to take off his boot. The condition is known as Morton's disease or *metatarsalgia*. The pain is due to the nerves of the toes (which come from the sole of the foot) being pressed upon by the rounded ends of the long bones of the foot near the web of the toes. It does not generally yield to palliative measures (though rest of the foot and a change to broad-toed, easy boots may be helpful), and the only effectual remedy is resection of the head of one of the metatarsal bones, after which relief is complete and permanent.

For paralytic club-foot, in which distressing corns have been developed over the unnatural prominences upon which the sufferer has been accustomed to walk, the adoption of the most promising conservative measures are usually disappointing, and relief and happiness may be obtainable only after the performance of Syme's amputation through the ankle-joint.

CLUE, or **CLEW** (O. Eng. *cluwe*), originally a ball of thread or wool, the thread of life, which, according to the fable, the Fates spin for every man. The ordinary figurative meaning, a piece of evidence leading to discovery, or a sign pointing to the right track, is derived from the story of Theseus, who was guided through the labyrinth by the ball of thread held by Ariadne.

CLUENTIUS HABITUS, AULUS, of Larinum in Samnium, the hero of a Roman *cause célèbre*. In 74 B.C. he accused his stepfather Staius Albius Oppianicus of an attempt to poison him; had it been successful, the property of Cluentius would have fallen to his mother Sasia. Oppianicus and two others were condemned, and some years later Oppianicus died in exile. But the verdict was looked upon with suspicion, and it was known for a fact that one of the jurymen had received a large sum of money for distribution amongst his colleagues. The result was the degradation of Cluentius himself and several of the jurymen. In 66, Sasia induced her stepson Oppianicus to charge Cluentius with having caused the elder Oppianicus to be poisoned while in exile. On this occasion the defence was undertaken by Cicero in the extant speech *Pro Cluentio*. In the end Cluentius was acquitted. Cicero afterwards boasted openly that he had thrown dust in the eyes of the jury (Quintilian, *Instit.* ii. 17. 21, who quotes this speech more than any other). His efforts are chiefly devoted to proving that the condemnation

of the elder Oppianicus was just and in no way the result of the jury having been bribed by Cluentius; only a small portion of the end of the speech deals with the specific charge. It was generally believed that the verdict in the former trial was an unfair one; and this opinion was most prejudicial to Cluentius. But even if it could be shown that Cluentius had bribed the jury-men, this did not prove that he had poisoned Oppianicus, although it supplied a sufficient reason for wishing to get him out of the way. The speech delivered by Cicero on this occasion is considered one of his best.

Editions of the speech by W. Y. Fausset (1887), W. Ramsay (1883); see also H. Nettleship, *Lectures and Essays* (1885).

CLUMP, a word common to Teutonic languages, meaning a mass, lump, group or cluster of indefinite form, as a clump of grass or trees. The word is used of a wooden and clumsy shoe, made out of one piece of wood, worn by German peasants, and by transference is applied to the thick extra sole added to heavy boots for rough wear. Shoemakers speak of "clumping" a boot when it is mended by having a new sole fastened by nails and not sewn by hand to the old sole.

CLUNES, a borough of Talbot county, Victoria, Australia, $97\frac{1}{2}$ m. by rail N.W. of Melbourne. Pop. (1901) 2426. It is the centre of an agricultural, pastoral and mining district, in which gold was first discovered in 1851. It lies in a healthy and picturesque situation at an elevation of 1081 ft. An annual agricultural exhibition and large weekly cattle sales are held in the town.

CLUNY, or **CLUGNY**, a town of east central France, in the department of Saône-et-Loire, on the left bank of the Grosne, 14 m. N.W. of Mâcon by road. Pop. (1906) 3105. The interest of the town lies in its specimens of medieval architecture, which include, besides its celebrated abbey, the Gothic church of Notre-Dame, the church of St Marcel with its beautiful Romanesque spire, portions of the ancient fortifications, and a number of picturesque houses belonging to the Romanesque, Gothic and Renaissance periods. The chief remains of the abbey (see **ABBEY**) are the ruins of the basilica of St Peter and the abbot's palace. The church was a Romanesque building, completed early in the 12th century, and until the erection of St Peter at Rome was the largest ecclesiastical building in Europe. It was in great part demolished under the First Empire, but the south transept, a high octagonal tower, the chapel of Bourbon (15th century), and the ruins of the apse still remain. In 1750 the abbey buildings were largely rebuilt and now contain a technical school. Part of the site of the church is given up to the stabling of a government stud. The abbot's palace, which belongs to the end of the 15th century, serves as hôtel-de-ville, library and museum. The town has quarries of limestone and building-stone, and manufactures pottery, leather and paper.

A more village at the time when the abbey was founded (910), Cluny gradually increased in importance with the development of the religious fraternity, and in 1090 received a communal charter from the abbot St Hugh. In 1471 the town was taken by the troops of Louis XI. In 1529 the abbey was given "in commendam" to the family of Guise, four members of which held the office of abbot during the next hundred years. The town and abbey suffered during the Wars of Religion of the 16th century, and the abbey was closed in 1790. The residence erected in Paris at the end of the 15th century by the abbots Jean de Bourbon and Jacques d'Amboise, and known as the Hôtel de Cluny (see **HOUSE**, Plate I., fig. 6), is occupied by the du Sommerard collection; but the Collège de Cluny founded in 1269 by the abbot Yves de Vergy, as a theological school for the order, is no longer in existence.

The Order of Cluniac Benedictines.—The Monastery of Cluny was founded in 910 by William I. the Pious, count of Auvergne and duke of Guienne (Aquitaine). The first abbot was Berno, who had under his rule two monasteries in the neighbourhood. Before his death in 927 two or three more came under his control, so that he bequeathed to his successor the government of a little group of five or six houses, which became the nucleus of the order of Cluny. Berno's successor was Odo: armed with

papal privileges he set to work to make Cluny the centre of a revival and reform among the monasteries of France; he also journeyed to Italy, and induced some of the great Benedictine houses, and among them St Benedict's own monasteries of Subiaco and Monte Cassino, to receive the reform and adopt the Cluny manner of life. The process of extension, partly by founding new houses, partly by incorporating old ones, went on under Odo's successors, so that by the middle of the 12th century Cluny had become the centre and head of a great order embracing 314 monasteries—the number 2000, sometimes given, is an exaggeration—in all parts of Europe, in France, Italy, the Empire, Lorraine, Spain, England, Scotland, Poland, and even in the Holy Land. And the influence of Cluny extended far beyond the actual order: many monasteries besides Monte Cassino and Subiaco adopted its customs and manner of life without subjecting themselves to its sway; and of these, many in turn became the centres of reforms which extended Cluny ideas and influences over still wider circles: Fleury and Hirsau may be mentioned as conspicuous examples. The gradual stages in the growth of the Cluny sphere of influence is exhibited in a map [VI. C.] in Heussi and Mulert's *Handatlas zur Kirchengeschichte*, 1905.

When we turn to the inner life of Cluny, we find that the decrees of Aix-la-Chapelle, which summed up the Carolingian movement for reform (see **BENEDICTINES**), were taken as the basis of the observance. Field work and manual labour were given up; and in compensation the tendency initiated by Benedict of Aniane, to prolong and multiply the church services far beyond the canonical office contemplated by St Benedict, was carried to still greater extremes, so that the services came to occupy nearly the whole day. The lessons at the night office became so lengthy that, e.g., the Book of Genesis was read through in a week; and the daily psalmody, between canonical office and extra devotions, exceeded a hundred psalms (see Edm. Bishop, *Origin of the Primer*, Early English Text Soc., Original Series, No. 109).

If its influence on the subsequent history of monastic and religious life and organization be considered, the most noteworthy feature of the Cluny system was its external polity, which constituted it a veritable "order" in the modern sense of the word, the first that had existed since that of Pachomius (see **MONASTICISM**). All the houses that belonged, either by foundation or incorporation, to the Cluny system were absolutely subject to Cluny and its abbot, who was "general" in the same sense as the general of the Jesuits or Dominicans, the practically absolute ruler of the whole system. The superiors of all the subject houses (usually priors, not abbots) were his nominees; every member of the order was professed by his permission, and had to pass some of the early years of his monastic life at Cluny itself; the abbot of Cluny had entire control over every one of the monks—some 10,000, it is said; it even came about that he had the practical appointment of his successor. For a description and criticism of the system, see F. A. Gasquet, *Sketch of Monastic Constitutional History*, pp. xxxii-xxxv (the Introduction to 2nd ed. (1895) of the English trans. of the *Monks of the West*); here it must suffice to say that it is the very antithesis of the Benedictine polity (see **BENEDICTINES**).

The greatness of Cluny is really the greatness of its early abbots. If the short reign of the unworthy Pontius be excepted, Cluny was ruled during a period of about 250 years (910-1157) by a succession of seven great abbots, who combined those high qualities of character, ability and religion that were necessary for so commanding a position; they were Berno, Odo, Aymard, Majolus (Maieul), Odilo, Hugh, Peter the Venerable. Sprung from noble families of the neighbourhood; educated to the highest level of the culture of those times; endowed with conspicuous ability and prudence in the conduct of affairs; enjoying the consideration and confidence of popes and sovereigns; employed again and again as papal legates and imperial ambassadors; taking part in all great movements of ecclesiastical and temporal politics; refusing the first sees in Western Christendom, the cardinalate, and the papacy itself.

they ever remained true to their state as monks, without loss of piety or religion. Four of them, indeed, Odo, Maieul, Odilo and Hugh, are venerated as saints.

In the movement associated with the name of Hildebrand the influence of Cluny was thrown strongly on the side of religious and ecclesiastical reform, as in the suppression of simony and the enforcing of clerical celibacy; but in the struggle between the Papacy and the Empire the abbots of Cluny seem to have steered a middle course between Guelfs and Ghibellines, and to have exercised a moderating influence; St Hugh maintained relations with Henry IV. after his excommunication, and probably influenced him to go to Canossa. Hildebrand himself, though probably not a monk of Cluny, was a monk of a Cluniac monastery in Rome; his successor, Urban II., was actually a Cluny monk, as was Paschal II. It may safely be said that from the middle of the 10th century until the middle of the 12th, Cluny was the chief centre of religious influence throughout Western Europe, and the abbot of Cluny, next to the pope, the most important and powerful ecclesiastic in the Latin Church.

Everything at Cluny was on a scale worthy of so great a position. The basilica, begun 1089 and dedicated 1131, was, until the building of the present St Peter's, the largest church in Christendom, and was both in structure and ornamentation of unparalleled magnificence. The monastic buildings were gigantic.

During the abbacy of Peter the Venerable (1122-1157) it became clear that, after a lapse of two centuries, a renewal of the framework of the life and a revival of its spirit had become necessary. Accordingly he summoned a great chapter of the whole order whereat the priors and representatives of the subject houses attended in such numbers that, along with the Cluny community, the assembly consisted of 1200 monks. This chapter drew up the 76 statutes associated with Peter's name, regulating the whole range of claustral life, and solemnly promulgated as binding on the whole Cluniac obedience. But these measures did not succeed in saving Cluny from a rapid decline that set in immediately after Peter's death. The monarchical status of the abbot was gradually curtailed by the holding of general chapters at fixed periods and the appointment of a board of definitors, elected by the chapter, as a permanent council for the abbot. Owing to these restrictions and still more to the fact that the later abbots were not of the same calibre as the early ones, their power and influence waned, until in 1528 (if not in 1456) the abbey fell into "commendam." The rise of the Cistercians and the mendicant orders were contributory causes, and also the difficulties experienced in keeping houses in other countries subject to a French superior. And so the great system gradually became a mere congregation of French houses. Of the commendatory abbots the most remarkable were Cardinals Richelieu and Mazarin, who both initiated attempts to introduce reforms into the Cluny congregation, the former trying to amalgamate it with the reformed congregation of St Maur, but without effect. Martène tells us that in the early years of the 18th century in the monastery of Baume, one of Berno's original group of Cluny houses—indeed the parent house of Cluny itself—no one was admitted as a monk who had not sixteen quarterings in his coat of arms. A reform movement took root in the Cluny congregation, and during the last century of its existence the monks were divided into two groups, the Reformed and the Unreformed, living according to different laws and rules, with different superiors, and sometimes independent, and even rival, general chapters. This most unhappy arrangement hopelessly impaired the vitality and work of the congregation, which was finally dissolved and suppressed in 1790, the church being deliberately destroyed.

Cluniac houses were introduced into England under the Conqueror. The first foundation was at Barnstaple; the second at Lewes by William de Warenne, in 1077, and it counted as one of the "Five Daughters of Cluny." In quick succession followed Thetford, Montacute, Wenlock, Bermondsey, and in Scotland, Paisley; a number of lesser foundations were made,

and offshoots from the English houses; so that the English Cluniac dependencies in the 13th century amounted to 40. It is said that in the reign of Edward III. they transmitted to Cluny annually the sum of £2000, equivalent to £60,000 of our money. Such a drain on the country was naturally looked on with disfavour, especially during the French wars; and so it came about that as "alien priories" they were frequently sequestered by the crown. As the communities came to be composed more and more of English subjects, they tended to grow impatient of their subjection to a foreign house, and began to petition parliament to be naturalized and to become denizen. In 1351 Lewes was actually naturalized, but a century later the prior of Lewes appears still as the abbot of Cluny's vicar in England. Though the bonds with Cluny seem to have been much relaxed if not wholly broken, the Cluniac houses continued as a separate group up to the dissolution, never taking part in the chapters of the English Benedictines. At the end there were eight greater and nearly thirty lesser Cluniac houses: for list see Table in F. A. Gasquet's *English Monastic Life*; and *Catholic Dictionary*, art. "Cluny."

The history of Cluny up to the death of Peter the Venerable may be extracted out of Mabillon's *Annales* by means of the Index; the story is told in Helyot, *Hist. des ordres religieux* (1792), v. cc. 18, 19. Abridged accounts, with references to the most recent literature, may be found in Max Heimbucher, *Orden und Kongregationen* (1896), i. § 20; Herzog-Hauck, *Realencyklopädie* (ed. 3), art. "Cluni" (Grutzmacher); and Wetzer und Welte, *Kirchenlexikon* (ed. 2), art. "Clugny" (Hefele). The best modern monograph is by E. Sackur, *Die Cluniacenser* (1891-1894). In English a good account is given in Maitland, *Dark Ages*, §§ xviii.-xxvi.; the Introduction to G. F. Duckett's *Charters and Records of Cluni* (1890) contains, besides general information, a description of the church and the buildings, and a list of the chief Cluniac houses in all countries. The story of the English houses is briefly sketched in the second chapter of F. A. Gasquet's *Henry VIII. and the English Monasteries* (the larger ed., 1886). (E. C. B.)

CLUSERET, GUSTAVE PAUL (1823-1900), French soldier and politician, was born at Paris. He was an officer in the *garde mobile* during the revolution of 1848. He took part in several expeditions in Algeria, joined Garibaldi's volunteers in 1860, and in 1861 resigned his commission to take part in the Civil War in America. He served under Frémont and McClellan, and rose to the rank of general. Then, joining a band of Irish adventurers, he went secretly to Ireland, and participated in the Fenian insurrection (1866-67). He escaped arrest on the collapse of the movement, but was condemned to death in his absence. On his return to France he proclaimed himself a Socialist, opposed militarism, and became a member of the *Association internationale des travailleurs*, a cosmopolitan Socialist organization, known as the "*Internationale*." On the proclamation of the Third Republic in 1871 he set to work to organize the social revolution, first at Lyons and afterwards at Marseilles. His energy, his oratorical gifts, and his military experience gave him great influence among the working classes. On the news of the communist rising of the 18th of March 1871 he hastened to Paris, and on the 16th of April was elected a member of the commune. Disagreements with the other communist leaders led to his arrest on the 1st of May, on a false charge of betraying the cause. On the 24th of the same month the occupation of Paris by the Versailles troops restored him to liberty, and he succeeded in escaping from France. He did not return to the country till 1884. In 1888 and 1889 he was returned as a deputy to the chamber by Toulon. He died in 1900. Cluseret published his *Mémoires* (of the Commune) at Paris in 1887-1888.

CLUSIUM (mod. *Chiusi*, *q.v.*), an ancient town of Italy, one of the twelve cities of Etruria, situated on an isolated hill at the S. end of the valley of the Clanis (China). It was according to Roman tradition one of the oldest cities of Etruria and indeed of all Italy, and, if Camars (the original name of the town, according to Livy) is rightly connected with the Camertes Umbri, its foundation would go back to pre-Etruscan times. It first appears in Roman history at the end of the 7th century B.C., when it joined the other Etruscan towns against Tarquinius Priscus, and at the end of the 6th century B.C. it placed itself,

under its king Lars Porsena, at the head of the attempt to re-establish the Tarquins in Rome. At the time of the invasion of the Gauls in 391 B.C., on the other hand, Clusium was on friendly terms with Rome; indeed, it was the action of the Roman envoys who had come to intercede for the people of Clusium with the Gauls, and then, contrary to international law, took part in the battle which followed, which determined the Gauls to march on Rome. Near Clusium too, according to Livy (according to Polybius ii. 19. 5, ἐν τῇ Καπερίων χῶρᾳ, i.e. in Umbria near Camerinum), a battle occurred in 296 B.C. between the Gauls and Samnites combined, and the Romans; a little later the united forces of Clusium and Perugia were defeated by the Romans. The precise period at which Clusium came under Roman supremacy is, however, uncertain, though this must have happened before 225 B.C., when the Gauls advanced as far as Clusium. In 205 B.C. in the Second Punic War we hear that they promised ship timber and corn to Scipio. The Via Cassia, constructed after 187 B.C., passed just below the town. In the first civil war, Papirius Carbo took up his position here, and two battles occurred in the neighbourhood. Sulla appears to have increased the number of colonists, and a statue was certainly erected in his honour here. In imperial times we hear little of it, though its grain and grapes were famous. Christianity found its way into Clusium as early as the 3rd century, and the tombstone of a bishop of A.D. 322 exists. In A.D. 540 it is named as a strong place to which Vitiges sent a garrison of a thousand men.

Of pre-Roman or Roman buildings in the town itself there are few remains, except for some fragments of the Etruscan town walls composed of rather small rectangular blocks of travertine, built into the medieval fortifications. Under it, however, extends an elaborate system of rock-cut passages, probably drains. The chief interest of the place lies in its extensive necropolis, which surrounds the city on all sides. The earliest tombs (*tombe a pozzo*, shaft tombs) are previous to the beginning of Greek importation. Of *tombe a fossa* there are none, and the next stage is marked by the so-called *tombe a tiro*, in which the cinerary urn (often with a human head) is placed in a large clay jar (*tiro*, Lat. *dolium*). These belong to the 7th century B.C., and are followed by the *tombe a camera*, in which the tomb is a chamber hewn in the rock, and which can be traced back to the beginning of the 6th century B.C. From one of the earliest of these came the famous François vase; another is the tomb of Poggio Renzo, or della Scimmia (the monkey), with several chambers decorated with archaic paintings. The most remarkable group of tombs is, however, that of Poggio Gaiella, 3 m. to the N., where the hill is honey-combed with chambers in three storeys (now, however, much ruined and inaccessible), partly connected by a system of passages, and supported at the base by a stone wall which forms a circle and not a square—a fact which renders impossible its identification with the tomb of Porsena, the description of which Pliny (*Hist. Nat.* xxxvi. 91) has copied from Varro. Other noteworthy tombs are those of the Granduca, with a single subterranean chamber carefully constructed in travertine, and containing eight sarcophagi of the same material; of Vigna Grande, very similar to this; of Colle Casuccini (the ancient stone door of which is still in working order), with two chambers, containing paintings representing funeral rites; of Poggio Moro and Valdacqua, in the former of which the paintings are almost destroyed, while the latter is now inaccessible.

A conception of the size of the whole necropolis may be gathered from the fact that nearly three thousand Etruscan inscriptions have come to light from Clusium and its district alone, while the part of Etruria north of it as far as the Arno has produced barely five hundred. Among the later tombs bilingual inscriptions are by no means rare, and both Etruscan and Latin inscriptions are often found in the same cemeteries, showing that the use of the Etruscan language only died out gradually. A large number of the inscriptions are painted upon the tiles which closed the niches containing the cinerary urns. The urns themselves are small, often of terra-cotta,

originally painted, though the majority of them have lost their colour, and rectangular in shape. This style of burial seems peculiar to a district which E. Bormann (*Corp. Inscr. Lat.* xi. Berlin, 1887, p. 373) defines as a triangle formed by the Clanis (with the lakes of Chiusi and Montepulciano, both small, shallow and fever-breeding), on the E., the villages of Cetona, Sarteano, Castelluccio and Monticchiello on the W., and Montepulciano and Acquaviva on the N. In Roman times the territory of Clusium seems to have extended as far as Lake Trasimene. The local museum contains a valuable and important collection of objects from the necropolis, including some specially fine *bucchero*, sepulchral urns of travertine, alabaster and terra-cotta, painted vases, stone *cippi* with reliefs, &c.

Two Christian catacombs have been found near Clusium, one in the hill of S. Caterina near the railway station, the inscriptions of which seem to go back to the 3rd century, another 2 m. to the E. in a hill on which a church and monastery of S. Mustiola stood, which goes back to the 4th century, including among its inscriptions one bearing the date A.D. 303, and the tombstone of L. Petronius Dexter, bishop of Clusium, who died in A.D. 322. The total number of inscriptions known in Clusium is nearly 3000 Etruscan (*Corp. Inscr. Etrusc.*, Berlin, 475-3306) and 500 Latin (*Corp. Inscr. Lat.* xi. 2090-2593). To the W. and N.W. of Chiusi—at Cetona, Sarteano, Chianciano and Montepulciano—Etruscan cemeteries have been discovered; the objects from them formed, in the latter half of the 19th century, interesting local collections described by Dennis, which have since mostly passed to larger museums or been dispersed.

See G. Dennis, *Cities and Cemeteries of Etruria* (London, 1883), ii. 290 seq.; L. Giometti, *Guida di Chiusi* (Poggibonsi, 1904). (T. As.)

CLUWER (CLUVER, CLUVIER, CLUVERIUS), **PHILIP** (1580-1623), German geographer and historian, was born at Danzig in 1580. After travelling in Germany and Poland (where he learnt Polish), he began the study of law at Leiden, but he soon turned his attention to history and geography, which were then taught there by Joseph Scaliger. After campaigning in Bohemia and Hungary, suffering imprisonment, and travelling in England, Scotland and France, he finally settled in Holland, where (after 1616) he received a regular pension from Leiden Academy. In 1611 he began to publish his works. He died at Leiden in 1623. His principal writings are: *Germania Antiqua* (1616), *Siciliae Antiquae libri duo*, *Sardinia et Corsica Antiqua* (1619), and the posthumous *Italia Antiqua* (1622) and *Introductio in Universam Geographiam* (1620).

CLYDE, COLIN CAMPBELL, BARON (1792-1863), British soldier, was born at Glasgow on the 20th of October 1792. He received his education at the Glasgow high school, and when only sixteen years of age obtained an ensigncy in the 6th foot, through the influence of Colonel Campbell, his maternal uncle. The youthful officer had an early opportunity of engaging in active service. He fought under Sir Arthur Wellesley at Vimiera, took part in the retreat of Sir John Moore, and was present at the battle of Corunna. He shared in all the fighting of the Peninsular campaigns, and was severely wounded while leading a storming-party at the attack on San Sebastian. He was again wounded at the passage of the Bidassoa, and compelled to return to England, when his conspicuous gallantry was rewarded by promotion without purchase. Campbell held a command in the American expedition of 1814; and after the peace of the following year he devoted himself to studying the theoretical branches of his profession. In 1823 he quelled the negro insurrection in Demerara, and two years later obtained his majority by purchase. In 1832 he became lieutenant-colonel of the 98th foot, and with that regiment rendered distinguished service in the Chinese War of 1842. Campbell was next employed in the Sikh War of 1848-49, under Lord Gough. At Chillianwalla, where he was wounded, and at the decisive victory of Gujrat, his skill and valour largely contributed to the success of the British arms; and his "steady coolness and military precision" were highly praised in official despatches. He was made a K.C.B. in 1840, and specially named in the thanks of parliament.

After rendering important services in India Sir Colin Campbell

returned home in 1853. Next year the Crimean War broke out, and he accepted the command of the Highland brigade, which formed part of the duke of Cambridge's division. The brigade and its leader distinguished themselves very greatly at the Alma; and with his "thin red line" of Highlanders he repulsed the Russian attack on Balaklava. At the close of the war Sir Colin was promoted to be knight grand cross of the Bath, and elected honorary D.C.L. of Oxford. His military services, however, had as yet met with tardy recognition; but, when the crisis came, his true worth was appreciated. The outbreak of the Indian Mutiny (*q.v.*) called for a general of tried experience; and on the 11th of July 1857 the command was offered to him by Lord Palmerston. On being asked when he would be ready to set out, the veteran replied, "Within twenty-four hours." He was as good as his word; he left England the next evening, and reached Calcutta on the 13th of August. After spending upwards of two months in the capital to organize his resources, he started for the front on the 27th of October, and on the 17th of November relieved Lucknow for the second time. Sir Colin, however, considered Lucknow a false position, and once more abandoned it to the rebels, retaking it in March 1858. He continued in charge of the operations in Oudh until the embers of the revolt had died away. For these services he was raised to the peerage, in 1858, as Lord Clyde; and, returning to England in the next year, he received the thanks of both Houses of Parliament and a pension of £2000 a year. He died on the 14th of August 1863.

Though not a great general, and lacking in the dash which won England so many victories in India, Lord Clyde was at once a brave soldier and a careful and prudent leader. The soldiers whom he led were devotedly attached to him; and his courteous demeanour and manly independence of character won him unvarying respect.

See Sir Owen Tudor Burne, *Clyde and Strathnairn* ("Rulers of India" series, 1891); and L. Shadwell, *Life of Colin Campbell, Lord Clyde* (1881).

CLYDE (Welsh, *Clwyd*, "far heard," "strong," the *Glotta* of Tacitus), the principal river of Lanarkshire, Scotland. It is also the name of the estuary which forms the largest and finest firth on the west coast.

1. *The River*.—Daer Water, rising in Gana Hill (2190 ft.) on the borders of Lanarkshire and Dumfriesshire, after a course of 10½ m., and Potrail Water, rising 3 m. farther W. in the same hilly country (1928 ft.), after running N.N.E. for 7 m., unite 3½ m. S. of Elvanfoot to form the Clyde, of which they are the principal headstreams, though many mountain burns in these upland regions are also contributory. The old rhyme that "Annan, Tweed and Clyde rise a' out o' ae hillside" is not true, for Little Clyde Burn here referred to, rising in Clyde Law (2190 ft.), is only an affluent and not a parent stream. From the junction of the Daer and Potrail the river pursues a direction mainly northwards for several miles, winding eastwards around Tinto Hill, somewhat north-westerly to near Carstairs, where it follows a serpentine course westwards and then southwards. From Harperfield, a point about 4 m. above Lanark, it assumes a north-westerly direction, which, roughly, it maintains for the rest of its course as a river, which is generally held to end at Dumbarton, where it merges in the Firth. Its principal tributaries on the right are the Medwin (16 m. long), entering near Carnwath, the Mouse (15 m.), joining it at Lanark, the South Calder (16 m.) above Bothwell, the North Calder (12 m.) below Uddingston, the Kelvin (21 m.) at Glasgow, and the Leven (7 m.) at Dumbarton. The chief left-hand affluents are the Elvan (8 m.), entering at Elvanfoot, the Duneaton (19 m.), joining a few miles above Roberton, the Garf (6½ m.) below Lamington, the Douglas (20 m.) above Bonnington, the Nethan (12 m.) at Crossford, the Avon (28 m.) at Hamilton, the Rotten Calder (10 m.) near Newton, and the Cart (1 m.), formed by the junction of the Black Cart (9 m.) and the White Cart (19 m.), below Renfrew.

The total length of the Clyde from the head of the Daer to Dumbarton is 106 m., and it drains an area estimated at 1481

sq. m. It is thus the third longest river in Scotland (being exceeded by the Spey and Tay), but in respect of the industries on its lower banks, and its sea-borne commerce, it is one of the most important rivers in the world. Near Lanark it is broken by the celebrated Falls, four in number, which are all found within a distance of 3¼ m. Bonnington Linn, the most graceful, 2 m. above Lanark, is divided into two parts by a mass of tree-clad rocks in mid-stream, and has a height of 30 ft. From this spot the river runs for half a mile through a rugged, red sandstone gorge till it reaches Corra Linn, the grandest of the Falls, where in three leaps, giving it the aspect of a splendid cascade, it makes a descent of 84 ft., which, however, it accomplishes during flood at a single bound. Almost ¼ m. below Corra Linn, Dundaff Linn is reached, a fall of only 10 ft. Farther down, 1½ m. below Lanark, at Stonebyres Linn, reproducing the characteristic features of Corra Linn, the river descends in ordinary water in three leaps, and in flood in one bold drop of 80 ft. Within this space of 3¼ m. the river effects a total fall of 230 ft., or 61½ ft. in the mile. From Stonebyres Linn to the sea the fall is practically 4 ft. in every mile. The chief villages and towns on or close to the river between its source and Glasgow are Crawford, Lamington, New Lanark, Lanark, Hamilton, Bothwell, Blantyre and Uddingston. At Bowling (pop. 1018)—the point of transshipment for the Forth and Clyde Canal—the river widens decidedly, the fairway being indicated by a stone wall continued seawards as far as Dumbarton. Dunglass Point, near Bowling, is the western terminus of the wall of Antoninus, or Grim's Dyke; and in the grounds of Dunglass Castle, now a picturesque fragment, stands an obelisk to Henry Bell (1767–1830), the pioneer of steam navigation in Europe.

As far down as the falls the Clyde remains a pure fishing stream, but from the point at which it begins to receive the varied tribute of industry, its water grows more and more contaminated, and at Glasgow the work of pollution is completed. Towards the end of the 18th century the river was yet fordable at the Broomielaw in the heart of Glasgow, but since that period, by unexampled enterprise and unstinted expenditure of money, the stream has been converted into a waterway deep enough to allow liners and battleships to anchor in the harbour (see GLASGOW).

Clydesdale, as the valley of the upper Clyde is called, begins in the district watered by headstreams of the river, the course of which in effect it follows as far as Bothwell, a distance of 50 m. It is renowned for its breed of cart-horses (specifically known as Clydesdales), its orchards, fruit fields and market gardens, its coal and iron mines.

2. *The Firth*.—From Dumbarton, where the firth is commonly considered to begin, to Ailsa Craig, where it ends, the fairway measures 64 m. Its width varies from 1 m. at Dumbarton to 37 m. from Girvan to the Mull of Kintyre. The depth varies from a low-tide minimum of 22 ft. in the navigable channel at Dumbarton to nearly 100 fathoms in the Sound of Bute and at other points. The Cumbraes, Bute and Arran are the principal islands in its waters. The sea lochs all lie on the Highland shore, and comprise Gare Loch, Loch Long, Loch Goil, Holy Loch, Loch Striven, Loch Riddon and Loch Fyne. The only rivers of any importance feeding the Firth are the Ayrshire streams, of which the chief are the Garnock, Irvine, Ayr, Doon and Girvan. The tide ascends above Glasgow, where its farther rise is barred by a weir. The head-ports are Glasgow, Port Glasgow, Greenock, Ardrossan, Irvine, Troon, Ayr and Campbeltown. In addition to harbour lights, beacons on rocks, and light-ships, there are lighthouses on Ailsa Craig, Sanda, Davaar, Pladda, Holy Isle, and Little Cumbrae, and at Turnberry Point, Cloch Point and Toward Point. The health and holiday resorts on the lochs, islands and mainland coast are numerous.

CLYDEBANK, a police burgh of Dumbartonshire, Scotland, on the right bank of the Clyde, 6 m. from Glasgow. Pop. (1891) 10,014; (1901) 21,591. There are stations at Yoker, Clydebank, Kilbowie and Dalmuir, all comprised within the burgh since 1886, served by both the North British and the Caledonian railways. In 1875 the district was almost purely rural, but since that date flourishing industries have been planted in the different

parts. At Clydebank are large shipbuilding yards and engineering works; at Yoker there is some shipbuilding and a distillery; at Kilbowie the Singer Manufacturing Company have an immense factory, covering nearly 50 acres and giving employment to many thousands of operatives; at Dalmuir are the building and repairing yards of the Clyde Navigation Trust. The important Rothesay Dock, under this trust, was opened by the prince and princess of Wales in April 1907. The municipality owns a fine town hall and buildings. Part of the parish extends across the Clyde into the shire of Renfrew.

CNIDUS (mod. *Tekir*), an ancient city of Caria in Asia Minor, situated at the extremity of the long peninsula that forms the southern side of the Sinus Ceramicus or Gulf of Cos. It was built partly on the mainland and partly on the Island of Triopion or Cape Krio, which anciently communicated with the continent by a causeway and bridge, and now by a narrow sandy isthmus. By means of the causeway the channel between island and mainland was formed into two harbours, of which the larger, or southern, now known as Port Freano, was further enclosed by two strongly-built moles that are still in good part entire. The extreme length of the city was little less than a mile, and the whole intramural area is still thickly strewn with architectural remains. The walls, both insular and continental, can be traced throughout their whole circuit; and in many places, especially round the acropolis, at the N.E. corner of the city, they are remarkably perfect. Our knowledge of the site is largely due to the mission of the Dilettanti Society in 1812, and the excavations executed by C. T. Newton in 1857-1858; but of recent years it has become a frequent calling station of touring steamers, which can still lie safely in the southern harbour. The agora, the theatre, an odeum, a temple of Dionysus, a temple of the Muses, a temple of Aphrodite and a great number of minor buildings have been identified, and the general plan of the city has been very clearly made out. The most famous statue by the elder Praxiteles, the Aphrodite, was made for Cnidus. It has perished, but late copies exist, of which the most faithful is in the Vatican gallery. In a temple-enclosure C. T. Newton discovered a fine seated statue of Demeter, which now adorns the British Museum; and about 3 m. south-east of the city he came upon the ruins of a splendid tomb, and a colossal figure of a lion carved out of one block of Pentelic marble, 10 ft. in length and 6 in height, which has been supposed to commemorate the great naval victory of Conon over the Lacedaemonians in 394 B.C. Among the minor antiquities obtained from the city itself, or the great necropolis to the east, perhaps the most interesting are the leaden *κατάδεσμοι*, or imprecationary tablets, found in the temple of Demeter, and copied in facsimile in the appendix to the second volume of Newton's work. Peasants still find numerous antiquities, and the site would certainly repay more thorough excavation.

Cnidus was a city of high antiquity and probably of Lacedaemonian colonization. Along with Halicarnassus and Cos, and the Rhodian cities of Lindus, Camirus and Ialysus it formed the Dorian Hexapolis, which held its confederate assemblies on the Triopian headland, and there celebrated games in honour of Apollo, Poseidon and the nymphs. The city was at first governed by an oligarchic senate, composed of sixty members, known as *ἀμνήμονες*, and presided over by a magistrate called an *ἀρεστήρ*; but, though it is proved by inscriptions that the old names continued to a very late period, the constitution underwent a popular transformation. The situation of the city was favourable for commerce, and the Cnidians acquired considerable wealth, and were able to colonize the island of Lipara, and founded the city of Corcyra Nigra in the Adriatic. They ultimately submitted to Cyrus, and from the battle of Eurymedon to the latter part of the Peloponnesian War they were subject to Athens. In 394 B.C. Conon fought off the port the battle which destroyed Spartan hegemony. The Romans easily obtained their allegiance, and rewarded them for help given against Antiochus by leaving them the freedom of their city. During the Byzantine period there must still have been a considerable population; for the ruins contain a large number of

buildings belonging to the Byzantine style, and Christian sepulchres are common in the neighbourhood. Eudoxus, the astronomer, Ctesias, the writer on Persian history, and Sostratus, the builder of the celebrated Pharos at Alexandria, are the most remarkable of the Cnidians mentioned in history.

See C. T. Newton and R. P. Pullen, *Hist. of Discoveries at Halicarnassus, Cnidus, &c.* (1863).

CNOSSUS, KNOSSOS, or GNOSSUS, an ancient city of Crete, on the left bank of the Caeratus, a small stream which falls into the sea on the north side of the island. The city was situated about 3 m. from the coast, and, according to the old traditions, was founded by Minos, king of Crete. The locality was associated with a number of the most interesting legends of Greek mythology, particularly with those which related to Jupiter, who was said to have been born, to have been married, and to have been buried in the vicinity. Cnossus was also assigned as the site of the labyrinth in which the Minotaur was confined. The truth behind these legends has been revealed in recent years by the excavations of Dr Evans. As the historical city was peopled by Dorians, the manners, customs and political institutions of its inhabitants were all Dorian. Along with Gortyna and Cydonia, it held for many years the supremacy over the whole of Crete; and it always took a prominent part in the civil wars which from time to time desolated the island. When the rest of Crete fell under the Roman dominion, Cnossus shared the same fate, and became a Roman colony. Aenesidemus, the sceptic philosopher, and Chersiphron, the architect of the temple of Diana at Ephesus, were natives of Cnossus.

The Site.—As the excavations at Cnossus are discussed at length in the article CRETE, it must suffice here briefly to enumerate the more important. The chief building is the Great Palace, the so-called "House of Minos," the excavation of which by Arthur Evans dates from 1900: a number of rooms lying round the central paved court, oriented north and south, have been identified, among them being the throne-room with some well-preserved wall paintings and a small bathroom attached, in the north-west quarter a larger bathroom and a shrine, and residential chambers in the south and east. The latter part of the palace is composed of a number of private rooms and halls, and is especially remarkable for its skilful drainage and water-supply systems.

In 1907 excavations on the south side of the palace showed that the plan was still incomplete, and a southern cryptoporticus, and outside it a large south-west building, probably an official residence, were discovered. Of special interest was a huge circular cavity under the southern porch into which the sub-structures of the palace had been sunk. This cavity was filled with rubbish, sherds, &c., the latest of which was found to date as far back as the beginning of the Middle Minoan age, and the later work of 1908 only proved (by means of a small shaft, sunk through the débris) that the rock floor was 52 ft. below the surface. The first attempt to reach the floor by a cutting in the hill-side proved abortive, but the operations of 1910 led to a successful result. The cavity proved to be a great reservoir approached by a rock-cut staircase and of Early Minoan date.

In 1904-1905 a paved way running due west from the middle of the palace was excavated, and found to lead to another building described as the "Little Palace" largely buried under an olive grove. The first excavations showed that this building was on the same general plan and belonged to the same period as the "House of Minos," though somewhat later in actual date (17th century B.C.). Large halls, which had subsequently been broken up into smaller apartments, were found, and among a great number of other artistic remains one seal-impression of special interest showing a one-masted ship carrying a thoroughbred horse—perhaps representing the first importation of horses into Crete. A remarkable shrine with fetish idols was also discovered. The sacred Double-Axe symbol is prominent, as in the greater palace. By the end of 1910 the excavation of this smaller palace was practically completed. It was found to cover an area of more than 9,400 ft. with a frontage of more than 130 ft., and had five stone staircases. One object of special interest found

in the course of excavation is a black steatite vessel in the form of a bull's head. The modelling is of a very high order, and the one eye which remains perfect is cut out of rock crystal, with the pupil and iris marked by colours applied to the lower face of the crystal.

The work of excavation in the palace has been complicated by the necessity of propping up walls, floors and staircases. In some instances it has been found necessary to replace the original wooden pillars by pillars of stone. Again in the "Queen's Megaron" in the east wing of the Great Palace it was found that the exposure of the remains to the violent extremes of Cretan weather must soon prove fatal to them. It was therefore decided to restore the columns and part of the wall, and to roof over the whole area.

For recent excavations see R. M. Burrows, *The Discoveries in Crete* (1907); A. Mosso, *The Palaces of Crete* (1907); Lagrange, *La Crète ancienne* (1908); Dr. Evans's reports in *The Times*, Oct. 31, 1905, July 15, 1907, Aug. 27, 1908, and 1909 (Index); D. Mackenzie, *Cretan Palaces*.

COACH (through the Fr. *coche*, originally from the Magyar *kocsi*, an adjective from the Hungarian place named Kocs, between Raab and Buda, i.e. the sort of vehicle used there in the 15th century), a large kind of carriage for passengers (see CARRIAGE). As a general term it is used (as in "coach-building") for all carriages, and also in combination with qualifying attributes for particular forms (stage-coach, mail-coach, mourning-coach, hackney-coach, &c.); but the typical coach involves four wheels, springs and a roof. The stage-coach, with seats outside and in, was a public conveyance which was known in England from the 16th century, and before railways the stage-coaches had regular routes (stages) all over the country; through their carrying the mails (from 1784) the term "mail-coach" arose. Similar vehicles were used in America and on the European continent. The *diligence*, though not invariably with four horses, was the Continental analogue for public conveyance, with other minor varieties such as the *Stellwagen* and *Eilwagen*.

The driving of coaches with four horses was a task in which a considerable amount of skill was required,¹ and English literature is full of the difficulties and humours of "the road" in old days. A form of sport thus arose for enterprising members of the nobility and gentry, and after the introduction of railways made the mail-coach obsolete as a matter of necessity, the old sport of coaching for pleasure still survived, though only to a limited extent. The Four-in-hand Club was started in England in 1856 and the Coaching Club in 1870, as the successors of the old Bensington Driving Club (1807-1852), and Four-Horse Club (1808-1829); and in America the New York Coaching Club was founded in 1875. But coaching remains the sport of the wealthier classes, although in various parts of England (e.g. London to Brighton, and in the Lake district), in America, and in Europe, public coaches still have their regular times and routes for those who enjoy this form of travel. The earliest railway vehicles for passengers were merely the road coaches of the period adapted to run on rails, and the expression "coaching traffic" is still used in England to denote traffic carried in passenger trains.

Of coaches possessing a history the two best known in the United Kingdom are the king's state coach, and that of the lord mayor of London. The latter is the oldest, having been built, or at least first used, for the procession of Sir Charles Asgill, lord mayor elect, in November 1757. The body of this vehicle is not supported by springs, but hung on leather straps; and the whole structure is very richly loaded with ornamental carving, gilding and paint-work. The different panels and the doors contain various allegorical groups of figures representing suitable subjects, and heraldic devices painted in a spirited manner. The royal state coach, which is described as "the most superb carriage ever built," was designed by Sir William Chambers, the paintings on it were executed by Cipriani, and

¹ The idea of "driving" was responsible for the use of the term "coach" and "coaching" to mean a tutor or trainer, for examinations or athletic contests.

the work was completed in 1761. During the later part of Queen Victoria's reign it was hardly ever seen, but on the accession of Edward VII. the coach was once more put in order for use on state occasions. The following is an official description of this famous coach:—

"The whole of the carriage and body is richly ornamented with laurel and carved work, beautifully gilt. The length, 24 ft.; width, 8 ft. 3 in.; height, 12 ft.; length of pole, 12 ft. 4 in.; weight, 4 tons. The carriage and body of the coach is composed as follows:—Of four large tritons, who support the body by four braces, covered with red morocco leather, and ornamented with gilt buckles, the two figures placed in front of the carriage bear the driver, and are represented in the action of drawing by cables extending round their shoulders, and the cranes and sounding shells to announce the approach of the monarch of the ocean; and those at the back carry the imperial fasces, topped with tridents. The driver's foot-board is a large scallop shell, ornamented with bunches of reeds and other marine plants. The pole represents a bundle of lances; the splinter bar is composed of a rich moulding, issuing from beneath a voluted shell, and each end terminating in the head of a dolphin; and the wheels are imitated from those of the ancient triumphal chariot. The body of the coach is composed of eight palm-trees, which, branching out at the top, sustain the roof; and four angular trees are loaded with trophies allusive to the victories obtained by Great Britain during the late glorious war, supported by four lions' heads. On the centre of the roof stand three boys, representing the genii of England, Scotland and Ireland, supporting the imperial crown of Great Britain, and holding in their hands the sceptre, sword of state, and ensigns of knighthood; their bodies are adorned with festoons of laurel, which fall from thence towards the four corners. The panels and doors are painted with appropriate emblematical devices, and the linings are of scarlet velvet richly embossed with national emblems."

See the *Badminton Driving*, by the duke of Beaufort (1888); Rogers's *Manual of Driving* (Philadelphia, 1900); and "Nimrod's" *Essays on the Road* (1876).

COAHUILA, a northern frontier state of Mexico, bounded N. and N.E. by Texas, U.S.A., E. by Nuevo León, S. by San Luis Potosí and Zacatecas, and W. by Durango and Chihuahua. Area, 63,569 sq. m.; pop. (1895) 237,815; (1900) 296,938. Its surface is a roughly broken plateau, traversed N.W. to S.E. by several ranges of mountains and sloping gently toward the Rio Grande. The only level tract of any size in the state is the Bolsón de Mapimí, a great depression on the western side which was long considered barren and uninhabitable. It is a region of lakes and morasses, of arid plains and high temperatures, but experiments with irrigation toward the end of the 19th century were highly successful and considerable tracts have since been brought under cultivation. In general the state is insufficiently watered, the rainfall being light and the rivers small. The rivers flow eastward to the Rio Grande. The climate is hot and dry, and generally healthy. Stock-raising was for a time the principal industry, but agriculture has been largely developed in several localities, among the chief products of which are cotton—Coahuila is the principal cotton-producing state in Mexico—Indian corn, wheat, beans, sugar and grapes. The Parras district in the southern part of the state has long been celebrated for its wines and brandies. The mineral wealth of the state is very great, and the mining industries, largely operated with foreign capital, are important. The mineral products include silver, lead, coal, copper, and iron. The mining operations are chiefly centred in the Sierra Mojada, Sierra Carmen, and in the Santa Rosa valley. The modern industrial development of the state is due to the railway lines constructed across it during the last quarter of the 19th century, and to the investment of foreign capital in local enterprises. The first Spanish settlement in the region now called Coahuila was at Saltillo in 1586, when it formed part of the province of Nueva Vizcaya. Later it became the province of Nueva Estremadura under the Spanish régime, and in 1824, under the new republican organization, it became the state of Coahuila and included Texas and Nuevo León. Later in the same year Nuevo León was detached, but Texas remained a part of the state until 1835. The capital of the state is Saltillo; Monclova was the capital from 1833 to 1835. Among the more important towns are Parras (pop. 6476 in 1900), 98 m. W. by N. of Saltillo in a rich grape-producing district, Ciudad Porfirio Díaz, and Monclova (pop. 6684 in 1900); 105 m. N. by W. of Saltillo, on the Mexican International railway.

COAL. In its most general sense the term "coal" includes all varieties of carbonaceous minerals used as fuel, but it is now usual in England to restrict it to the particular varieties of such minerals occurring in the older Carboniferous formations. On the continent of Europe it is customary to consider coal as divisible into two great classes, depending upon differences of colour, namely, *brown coal*, corresponding to the term "lignite" used in England and France, and *black or stone coal*, which is equivalent to coal as understood in England. Stone coal is also a local English term, but with a signification restricted to the substance known by mineralogists as anthracite. In old English writings the terms pit-coal and sea-coal are commonly used. These have reference to the mode in which the mineral is obtained, and the manner in which it is transported to market.

The root *kol* is common to all the Teutonic nations, while in French and other Romance languages derivatives of the Latin *carbo* are used, e.g. *charbon de terre*. In France and Belgium, however, a peculiar word, *houille*, is generally used to signify mineral coal. This word is supposed to be derived from the Walloon *hoie*, corresponding to the medieval Latin *hullae*. Littré suggests that it may be related to the Gothic *haurja*, coal. Anthracite is from the Greek *ἄνθραξ*, and the term *lithanthrax*, stone coal, still survives, with the same meaning, in the Italian *litantrace*.

It must be borne in mind that the signification now attached to the word coal is different from that which formerly obtained when wood was the only fuel in general use. Coal then meant the carbonaceous residue obtained in the destructive distillation of wood, or what is known as charcoal, and the name collier was applied indifferently to both coal-miners and charcoal-burners.

The spelling "cole" was generally used up to the middle of the 17th century, when it was gradually superseded by the modern form, "coal." The plural, coals, seems to have been used from a very early period to signify the broken fragments of the mineral as prepared for use.

Coal is an amorphous substance of variable composition, and therefore cannot be as strictly defined as a crystallized or definite mineral can. It varies in colour from a light brown in the newest lignites to a pure black, often with a bluish or yellowish tint in the more compact anthracite of the older formations. It is opaque, except in exceedingly thin slices, such as made for microscopic investigation, which are imperfectly transparent, and of a dark brown colour by transmitted light. The streak is black in anthracite, but more or less brown in the softer varieties. The maximum hardness is from 2.5 to 3 in anthracite and hard bituminous coals, but considerably less in lignites, which are nearly as soft as rotten wood. A greater hardness is due to the presence of earthy impurities. The densest anthracite is often of a semi-metallic lustre, resembling somewhat that of graphite. Bright, glance or pitch coal is another brilliant variety, brittle, and breaking into regular fragments of a black colour and pitchy lustre. Lignite and cannel are usually dull and earthy, and of an irregular fracture, the latter being much tougher than the black coal. Some lignites are, however, quite as brilliant as anthracite; cannel and jet may be turned in the lathe, and are susceptible of taking a brilliant polish. The specific gravity is highest in anthracite and lowest in lignite, bituminous coals giving intermediate values (see Table I.). As a rule, the density increases with the amount of carbon, but in some instances a very high specific gravity is due to intermixed earthy matters, which are always denser than even the densest form of coal substance.

Coal is never definitely crystalline, the nearest approach to such a structure being a compound fibrous grouping resembling that of gypsum or arragonite, which occurs in some of the steam coals of South Wales, and is locally known as "cone in cone," but no definite form or arrangement can be made out of the fibres. Usually it occurs in compact beds of alternating bright and dark bands in which impressions of leaves, woody fibre and other vegetable remains are commonly found. There is generally a tendency in coals towards cleaving into cubical or prismatic

blocks, but sometimes the cohesion between the particles is so feeble that the mass breaks up into dust when struck. These peculiarities of structure may vary very considerably within small areas; and the position of the divisional planes or cleats with reference to the mass, and the proportion of small coal or slack to the larger fragments when the coal is broken up by cutting-tools, are points of great importance in the working of coal on a large scale.

The divisional planes often contain small films of other minerals, the commonest being calcite, gypsum and iron pyrites, but in some cases zeolitic minerals and galena have been observed. Salt, in the form of brine, is sometimes present in coal. Hydrocarbons, such as petroleum, bitumen, paraffin, &c., are also found occasionally in coal, but more generally in the associated sandstones and limestones of the Carboniferous formation. Gases, consisting principally of light carburetted hydrogen or marsh gas, are often present in considerable quantity in coal, in a dissolved or occluded state, and the evolution of these upon exposure to the air, especially when a sudden diminution of atmospheric pressure takes place, constitutes one of the most formidable dangers that the coal miner has to encounter.

The classification of the different kinds of coal may be considered from various points of view, such as their chemical composition, their behaviour when subjected to heat or when burnt, and their geological position and origin. They all contain carbon, hydrogen, oxygen and nitrogen, forming the carbonaceous or combustible portion, and some quantity of mineral matter, which remains after combustion as a residue or "ash." As the amount of ash varies very considerably in different coals, and stands in no relation to the proportion of the other constituents, it is necessary in forming a chemical classification to compute the results of analysis after deduction of the ash and hygroscopic water. Examples of analyses treated in this manner are furnished in the last column of Table I., from which it will be seen that the nearest approach to pure carbon is furnished by anthracite, which contains above 90%. This class of coal burns with a very small amount of flame, producing intense local heat and no smoke. It is especially used for drying hops and malt, and in blast furnaces where a high temperature is required, but it is not suited for reverberatory furnaces.

The most important class of coals is that generally known as bituminous, from their property of softening or undergoing an apparent fusion when heated to a temperature far below that at which actual combustion takes place. This term is founded on a misapprehension of the nature of the occurrence, since, although the softening takes place at a low temperature, still it marks the point at which destructive distillation commences, and hydrocarbons both of a solid and gaseous character are formed. That nothing analogous to bitumen exists in coals is proved by the fact that the ordinary solvents for bituminous substances, such as bisulphide of carbon and benzol, have no effect upon them, as would be the case if they contained bitumen soluble in these re-agents. The term is, however, a convenient one, and one whose use is almost a necessity, from its having an almost universal currency among coal miners. The proportion of carbon in bituminous coals may vary from 80 to 90%—the amount being highest as they approach the character of anthracite, and least in those which are nearest to lignites. The amount of hydrogen is from 4½ to 6%, while the oxygen may vary within much wider limits, or from about 3 to 14%. These variations in composition are attended with corresponding differences in qualities, which are distinguished by special names. Thus the semi-anthracitic coals of South Wales are known as "dry" or "steam coals," being especially valuable for use in marine steam-boilers, as they burn more readily than anthracite and with a larger amount of flame, while giving out a great amount of heat, and practically without producing smoke. Coals richer in hydrogen, on the other hand, are more useful for burning in open fires—smiths' forges and furnaces—where a long flame is required.

The excess of hydrogen in a coal, above the amount necessary

Classification.

Anthracite.

Bituminous coals.

Physical properties.

to combine with its oxygen to form water, is known as "disposable" hydrogen, and is a measure of the fitness of the coal for use in gas-making. This excess is greatest in what is known as cannel coal, the Lancashire kannel or candle coal, so named from the bright light it gives out when burning. This, although of very small value as fuel, commands a specially high price for gas-making. Cannel is more compact and duller than ordinary coal, and can be wrought in the lathe and polished.

oxygen and hygroscopic water are much higher than in true coals. The property of caking or yielding a coherent coke is usually absent, and the ash is often very high. The specific gravity is low when not brought up by an excessive amount of earthy matter. Sometimes it is almost pasty, and crumbles to powder when dried, so as to be susceptible of use as a pigment, forming the colour known as Cologne earth, which resembles umber or sepia. In Nassau and Bavaria woody structure is very common, and it is

TABLE I.—Elementary Composition of Coal (the figures denote the amounts per cent).

Localities.	Specific Gravity.	Carbon.	Hydrogen.	Oxygen.	Nitrogen.	Sulphur.	Ash.	Water.	Composition calculated exclusive of Water, Sulphur and Ash.			
									Carbon.	Hydrogen.	O. and N.	
<i>Anthracite.</i>												
1. South Wales	1.392	90.39	3.28	2.98	0.83	0.91	1.61	2.00	93.54	3.39	3.82	
2. Pennsylvania	1.462	90.45	2.45	2.45	4.67	..	94.89	2.54	2.57	
3. Peru	82.70	1.41	..	0.85	10.35	3.75	0.94	97.34	1.66	1.00	
<i>Bituminous Steam and Coking Coal.</i>												
4. Risca, South Wales	75.49	4.73	..	6.78	1.21	10.67	1.12	86.78	5.43	7.79	
5. Aberdare	86.80	4.25	..	3.06	0.83	4.40	0.66	92.24	4.51	3.25	
6. Hartley, Northumberland	78.65	4.65	..	13.36	0.55	2.49	..	80.67	4.76	14.5	
7. Dudley, Staffordshire	1.278	78.57	5.29	12.88	1.84	0.39	1.03	1.13	79.70	5.37	14.9	
8. Stranitzan, Styria	79.90	4.85	12.75	0.64	0.20	1.66	..	81.45	4.92	13.63	
<i>Cannel or Gas Coal.</i>												
9. Wigan, Lancashire	1.276	80.07	5.53	8.08	2.12	1.50	2.70	0.91	85.48	5.90	8.62	
10. Boghead, Scotland	65.10	8.91	..	7.25	0.96	19.78	..	79.61	11.24	9.15	
11. (Alberite) Nova Scotia	82.67	9.14	..	8.19	82.67	9.14	8.19	
12. (Tasmanite) Tasmania	1.18	79.34	10.41	..	4.93	5.32	83.80	10.99	5.21	
<i>Lignite and Brown Coal.</i>												
13. Cologne	1.100	63.29	4.98	..	26.24	..	8.49	..	66.97	5.27	27.76	
14. Bovey Tracy, Devonshire	66.31	5.63	22.86	0.57	2.36	2.36	..	69.53	5.90	24.57	
15. Trifail, Styria	59.72	5.34	33.18	2.80	0.90	7.86	..	55.11	5.80	39.09	

These properties are most highly developed in the substance known as jet, which is a variety of cannel found in the lower oolitic strata of Yorkshire, and is almost entirely used for ornamental purposes, the whole quantity produced near Whitby, together with a further supply from Spain, being manufactured into articles of jewellery at that town.

When coal is heated to redness out of contact with the air, the more volatile constituents, water, hydrogen, oxygen, and nitrogen are in great part expelled, a portion of the carbon being also volatilized in the form of hydrocarbons and carbonic oxide,—the greater part, however, remaining behind, together with all the mineral matter or ash, in the form of coke, or, as it is also called, "fixed carbon." The proportion of this residue is greatest in the more anthracitic or drier coals, but a more valuable product is yielded by those richer in hydrogen. Very important distinctions—those of caking or non-caking—are founded on the behaviour of coals when subjected to the process of coking. The former class undergo an incipient fusion or softening when heated, so that the fragments coalesce and yield a compact coke, while the latter (also called free-burning) preserve their form, producing a coke which is only serviceable when made from large pieces of coal, the smaller pieces being incoherent and of no value. The caking property is best developed in coals low in oxygen with 25 to 30% of volatile matters. As a matter of experience, it is found that caking coals lose that property when exposed to the action of the air for a lengthened period, or by heating to about 300° C., and that the dust or slack of non-caking coal may, in some instances, be converted into a coherent coke by exposing it suddenly to a very high temperature, or compressing it strongly before charging it into the oven.

Lignite or brown coal includes all varieties which are intermediate in properties between wood and coals of the older formations. A coal of this kind is generally to be distinguished by its brown colour, either in mass or in the blacker varieties in the streak. The proportion of carbon is comparatively low, usually not exceeding 70%, while the

from this circumstance that the term lignite is derived. The best varieties are black and pitchy in lustre, or even bright and scarcely to be distinguished from true coals. These kinds are most common in Eastern Europe. Lignites, as a rule, are generally found in strata of a newer geological age, but there are many instances of perfect coals being found in such strata.

By the term "ash" is understood the mineral matter remaining unconsumed after the complete combustion of the carbonaceous portion of a coal. According to Couriot (*Annales de la société géologique de Belgique*, vol. xxiii. p. 105) the stratified character of the ash may be rendered apparent in an X-ray photograph of a piece of coal about an inch thick, when it appears in thin parallel bands, the combustible portion remaining transparent. It may also be rendered visible if a smooth block of free-burning coal is allowed to burn away quickly in an open fire, when the ash remains in thin grey or yellow bands on the surface of the block. The composition of the ashes of different coals is subject to considerable variation, as will be seen by Table II

The composition of the ash of true coal approximates to that of a fire-clay, allowance being made for lime, which may be present either as carbonate or sulphate, and for sulphuric acid. Sulphur is derived mainly from iron pyrites, which yields sulphates by combustion. An indication of the character of the ash of a coal is afforded by its colour, white ash coals being generally freer from sulphur than those containing iron pyrites, which yield a red ash. There are, however, several striking exceptions, as for instance in the anthracite from Peru, given in Table I., which contains more than 10% of sulphur, and yields but a very small percentage of a white ash. In this coal, as well as in the lignite of Tasmania, known as white coal or Tasmanite, the sulphur occurs in organic combination, but is so firmly held that it can only be very partially expelled, even by exposure to a very high and continued heating out of contact with the air. An anthracite occurring in connexion with the old volcanic rocks of Arthur's Seat, Edinburgh, which contains a large amount of sulphur in proportion to the

Ash of coal.

Sulphur in coal.

TABLE II.—Composition of the Ashes of Coals.

	Silica.	Alumina.	Ferric Oxide.	Lime.	Magnesia.	Potash.	Sulphuric Acid.	Phosphoric Acid.	Total.
<i>True Coals.</i>									
Dowlais, South Wales	39.64	39.20	11.84	1.81	2.58	3.01	98.08
Ebbw Vale, "	53.00	35.01	..	3.94	2.20	..	4.89	0.88	99.92
Königsgrube, Silesia	55.41	18.95	16.06	3.21	1.87	2.05	1.73	0.56	99.64
Ohio	44.60	41.10	7.40	3.61	1.28	1.82	0.59	0.29	100.69
<i>Lignites.</i>									
Helmstadt, Saxony	17.27	11.57	5.57	23.67	2.58	2.64	33.83	..	97.13
Edelény, Hungary	36.01	23.07	5.05	15.62	3.64	2.38	12.35	..	98.12

ash, has been found to behave in a similar manner. Under ordinary conditions, from $\frac{1}{5}$ to $\frac{1}{4}$ of the whole amount of sulphur in a coal is volatilized during combustion, the remaining $\frac{3}{4}$ to $\frac{4}{5}$ being found in the ash.

The amount of water present in freshly raised coals varies very considerably. It is generally largest in lignites, which may sometimes contain 30% or even more, while in the coals of the coal measures it does not usually exceed from 5 to 10%. The loss of weight by exposure to the atmosphere from drying may be from $\frac{1}{5}$ to $\frac{2}{3}$ of the total amount of water contained.

Coal is the result of the transformation of woody fibre and other vegetable matter by the elimination of oxygen and hydrogen in proportionally larger quantity than carbon, so that the percentage of the latter element is increased in the manner shown in Table III., given by J. Percy, the mineral matter being also changed by the removal of silica and alkalis and the substitution of substances analogous in composition to fire-clay. The causes and methods of these changes are, however, not very exactly defined. Accord-

C_2H_2 and C_2H_4 , where $C:H=7.98$ and $C:O+N=46.5$. In cannel coals the prevailing constituents are the spores of cryptogamic plants, algae being rare or in many cases absent. By making very thin sections and employing high magnification (1000-1200 diameters), Renault has been enabled to detect numerous forms of bacilli in the woody parts preserved in coal, one of which, *Micrococcus carbo*, bears a strong resemblance to the living *Clostridium* found in trees buried in peat bogs. Clearer evidence of their occurrence has, however, been found in fragments of wood fossilized by silica or carbonate of lime which are sometimes met with in coal seams.

The subsequent change of peaty substance into coal is probably due to geological causes, i.e. chemical and physical processes similar to those that have converted ordinary sediments into rock masses. Such changes seem, however, to have been very rapidly accomplished, as pebbles of completely formed coal are commonly found in the sandstones and coarser sedimentary strata alternating with the coal seams in many coalfields.

The variation in the composition of coal seams in different parts of the same basin is a difficult matter to explain. It has been variously attributed to metamorphism, consequent upon igneous intrusion, earth movements and other kinds of geothermic action, greater or less loss of volatile constituents during the period of coaly transformation, conditioned by differences of permeability in the enclosing rocks, which is greater for sandstones than for argillaceous strata, and other causes; but none of these appears to be applicable over more than limited areas. According to L. Lemièrre, who has very fully reviewed the relation of composition to origin in coal seams (*Bulletin de la Société de l'Industrie minière*, 4 ser. vol. iv. pp. 851 and 1299, vol. v. p. 273), differences in composition are mainly original, the denser and more anthracitic varieties representing plant substance which has been more completely macerated and deprived of its putrescible constituents before submergence, or of which the deposition had taken place in shallow water, more readily accessible to atmospheric oxidizing influences than the deeper areas where conditions favourable to the elaboration of compounds richer in hydrogen prevailed.

The conditions favourable to the production of coal seem therefore to have been—forest growth in swampy ground about the mouths of rivers, and rapid oscillation of level, the coal produced during subsidence being covered up by the sediment brought down by the river forming beds of sand or clay, which, on re-elevation, formed the soil for fresh growths, the alternation being occasionally broken by the deposit of purely marine beds. We might therefore expect to find coal wherever strata of estuarine origin are developed in great mass. This is actually the case; the Carboniferous, Cretaceous and Jurassic systems (*qq.v.*) contain coal-bearing strata though in unequal degrees,—the first being known as the Coal Measures proper, while the others are of small economic value in Great Britain, though more productive in workable coals on the continent of Europe. The Coal Measures which form part of the Palaeozoic or oldest of the three great geological divisions are mainly confined to the countries north of the equator. Mesozoic coals are more abundant in the southern hemisphere, while Tertiary coals seem to be tolerably uniformly distributed irrespective of latitude.

The nature of the Coal Measures will be best understood by

TABLE III.—Composition of Fuels (assuming Carbon=100).

	Carbon.	Hydrogen.	Oxygen.	Disposable Hydrogen.
Wood	100	12.18	83.07	1.80
Peat	100	9.85	55.67	2.89
Lignite	100	8.37	42.42	3.07
Thick Coal, S. Staffordshire	100	6.12	21.23	3.47
Hartley Steam Coal	100	5.91	18.32	3.62
South Wales Steam Coal	100	4.75	5.28	4.09
American Anthracite	100	2.84	1.74	2.63

ing to the elaborate researches of B. Renault (*Bulletin de la Société de l'Industrie minière*, 3 ser. vol. xiii. p. 865), the agents of the transformation of cellulose into peaty substances are saprophytic fungi and bacterial ferments. As the former are only active in the air while the latter are anaerobic, the activity of either agent is conditioned by variation in the water level of the bog. The ultimate term of bacterial activity seems to be the production of ulmic acid, containing carbon 65.31 and hydrogen 3.85%, which is a powerful antiseptic. By the progressive elimination of oxygen and hydrogen, partly as water and partly as carbon dioxide and marsh gas, the ratios of carbon to oxygen and hydrogen in the rendered product increase in the following manner:—

	C : H	C : O
Cellulose	7.2	0.9
Peat	9.8	1.8
Lignite, imperfect	12.2	2.4
" perfect	12.6	3.6

The resulting product is a brown pasty or gelatinous substance which binds the more resisting parts of the plants into a compact mass. The same observer considers Boghead coal, kerosene shale and similar substances used for the production of mineral oils to be mainly alteration products of gelatinous fresh water algae, which by a nearly complete elimination of oxygen have been changed to substances approximating in composition to

considering in detail the areas within which they occur in Britain, together with the rocks with which they are most intimately associated. The commencement of the Carboniferous period is marked by a mass of limestones known as the Carboniferous or Mountain Limestone, which contains a large assemblage of marine fossils, and has a maximum thickness in S.W. England and Wales of about 2000 ft. The upper portion of this group consists of shales and sandstones, known as the Yoredale Rocks, which are highly developed in the moorland region between Lancashire and the north side of Yorkshire. These are also called the Upper Limestone Shale, a similar group being found in places below the limestone, and called the Lower Limestone Shale, or, in the north of England, the Tuedian group. Going northward the beds of limestone diminish in thickness, with a proportional increase in the intercalated sandstones and shales, until in Scotland they are entirely subordinate to a mass of coal-bearing strata, which forms the most productive members of the Scotch coalfields. The next member of the series is a mass of coarse sandstones, with some slates and a few thin coals, known as the Millstone Grit, which is about equally developed in England and in Scotland. In the southern coalfields it is usually known by the miners' name of "Farewell rock," from its marking the lower limit of possible coal working. The Coal Measures, forming the third great member of the Carboniferous series, consist of alternations of shales and sandstones, with beds of coal and nodular ironstones, which together make up a thickness of many thousands of feet—from 12,000 to 14,000 ft. when at the maximum of development. They are divisible into three parts, the Lower Coal Measures, the middle or Pennant, a mass of sandstone containing some coals, and the Upper Coal-Measures, also containing workable coal. The latter member is marked by a thin limestone band near the top, containing *Spirorbis carbonarius*, a small marine univalve.

The uppermost portion of the Coal Measures consists of red sandstone so closely resembling that of the Permian group, which are next in geological sequence, that it is often difficult to decide upon the true line of demarcation between the two formations. These are not, however, always found together, the Coal Measures being often covered by strata belonging to the Trias or Upper New Red Sandstone series. The areas containing productive coal measures are usually known as coalfields or basins, within which coal occurs in more or less regular beds, also called seams or veins, which can often be followed over a considerable length of country without change of character, although, like all stratified rocks, their continuity may be interrupted by faults or dislocations, also known as slips, hitches, heaves or troubles.

The thickness of coal seams varies in Great Britain from a mere film to 35 or 40 ft.; but in the south of France and in India masses of coal are known up to 200 ft. in thickness. These very thick seams are, however, rarely constant in character for any great distance, being found commonly to degenerate into carbonaceous shales, or to split up into thinner beds by the intercalation of shale bands or partings. One of the most striking examples of this is afforded by the thick or ten-yard seam of South Staffordshire, which is from 30 to 45 ft. thick in one connected mass in the neighbourhood of Dudley, but splits up into eight seams, which, with the intermediate shales and sandstones, are of a total thickness of 400 ft. in the northern part of the coalfield in Cannock Chase. Seams of a medium thickness of 3 to 7 ft. are usually the most regular and continuous in character. Cannel coals are generally variable in quality, being liable to change into shales or black-band ironstones within very short horizontal limits. In some instances the coal seams may be changed as a whole, as for instance in South Wales, where the coking coals of the eastern side of the basin pass through the state of dry steam coal in the centre, and become anthracite in the western side.

(H. B.)

The most important European coalfields are in Great Britain, Belgium and Germany. In Great Britain there is the South Welsh field, extending westward from the march of Monmouth-

shire to Kidwelly, and northward to Merthyr Tydfil. A midland group of coalfields extends from south Lancashire to the West Riding of Yorkshire, the two greatest industrial districts in the country, southward to Warwickshire and Staffordshire, and from Nottinghamshire on the east to Flintshire on the west. In the north of England are the rich field of Northumberland and Durham, and a lesser field on the coast of Cumberland (Whitehaven, &c.). Smaller isolated fields are those of the Forest of Dean (Gloucestershire) and the field on either side of the Avon above Bristol. Coal has also been found in Kent, in the neighbourhood of Dover. In Scotland coal is worked at various points (principally in the west) in the Clyde-Forth lowlands. In Belgium the chief coal-basins are those of Hainaut and Liège. Coal has also been found in an extension northward from this field towards Antwerp, while westward the same field extends into north-eastern France. Coal is widely distributed in Germany. The principal field is that of the lower Rhine and Westphalia, which centres in the industrial region of the basin of the Ruhr, a right-bank tributary of the Rhine. In the other chief industrial region of Germany, in Saxony, Zwickau and Lugau, are important mining centres. In German Silesia there is a third rich field, which extends into Austria (Austrian Silesia and Galicia), for which country it forms the chief home source of supply (apart from lignite). Part of the same field also lies within Russian territory (Poland) near the point where the frontiers of the three powers meet. Both in Germany and in Austria-Hungary the production of lignite is large—in the first-named especially in the districts about Halle and Cologne; in the second in north-western Bohemia, Styria and Carniola. In France the principal coalfield is that in the north-east, already mentioned; another of importance is the central (Le Creusot, &c.) and a third, the southern, about the lower course of the Rhone. Coal is pretty widely distributed in Spain, and occurs in several districts in the Balkan peninsula. In Russia, besides the Polish field, there is an important one south of Moscow, and another in the lower valley of the Donetz, north of the Sea of Azov. The European region poorest in coal (proportionately to area) is Scandinavia, where there is only one field of economic value—a small one in the extreme south of Sweden.

In Asia the Chinese coalfields are of peculiar interest. They are widely distributed throughout China Proper, but those of the province of Shansi appear to be the richest. Proportionately to their vast extent they have been little worked. In a modified degree the same is true of the Indian fields; large supplies are unworked, but in several districts, especially about Raniganj and elsewhere in Bengal, workings are fully developed. Similarly in Siberia and Japan there are extensive supplies unworked or only partially exploited. Those in the neighbourhood of Semipalatinsk may be instanced in the first case and those in the island of Yezo in the second. In Japan, however, several smaller fields (e.g. in the island of Kiushiu) are more fully developed. Coal is worked to some extent in Sumatra, British North Borneo, and the Philippine Islands.

In the United States of America the Appalachian mountain system, from Pennsylvania southward, roughly marks the line of the chief coal-producing region. This group of fields is followed in importance by the "Eastern Interior" group in Indiana, Illinois and Kentucky, and the "Western Interior" group in Iowa, Missouri and Kansas. In Arkansas, Oklahoma and Texas, and along the line of the Rocky Mountains, extensive fields occur, producing lignite and bituminous coal. The last-named fields are continued northward in Canada (Crow's Nest Pass field, Vancouver Island, &c.). There is also a group of coalfields on the Atlantic seaboard of the Dominion, principally in Nova Scotia. Coal is known at several points in Alaska, and there are rich but little worked deposits in Mexico.

In the southern countries coal-production is insignificant compared with that in the northern hemisphere. In South America coal is known in Venezuela, Colombia, Peru, northern Chile, Brazil (chiefly in the south), and Argentina (Parana, the extreme south of Patagonia, and Tierra del Fuego), but in no

country are the workings extensive. Africa is apparently the continent poorest in coal, though valuable workings have been developed at various points in British South Africa, e.g. at Kronstad, &c., in Cape Colony, at Vereeniging, Boksburg and elsewhere in the Transvaal, in Natal and in Swaziland. Australia possesses fields of great value, principally in the south-east (New South Wales and Victoria), and in New Zealand considerable quantities of coal and lignite are raised, chiefly in South Island.

The following table, based on figures given in the *Journal of the Iron and Steel Institute*, vol. 72, will give an idea of the coal production of the world:—

TABLE IV.

Europe:—		Tons.
United Kingdom	1905	236,128,936
Germany, coal	"	121,298,167
" lignite	"	52,498,507
France	"	35,869,497
Belgium	"	21,775,260
Austria, coal	"	12,585,263
" lignite	"	22,692,076
Hungary, coal	1904	1,031,501
" lignite	"	5,447,283
Spain	1905	3,202,911
Russia	1904	19,318,000
Holland	"	466,997
Bosnia, lignite	1905	540,237
Rumania	1905	110,000
Servia	1904	183,204
Italy, coal and lignite	1905	412,916
Sweden	"	322,384
Greece, lignite	1904	466,997
Asia:—		
India	1905	8,417,739
Japan	1903	10,088,845
Sumatra	1904	207,280
Africa:—		
Transvaal	1904	2,409,033
Natal	1905	1,129,407
Cape Colony	1904	154,272
America:—		
United States	1905	350,821,000
Canada	1904	7,509,860
Mexico	"	700,000
Peru	1905	72,665
Australasia:—		
New South Wales	1905	6,632,138
Queensland	"	529,326
Victoria	"	153,135
Western Australia	"	127,364
Tasmania	"	51,993
New Zealand	"	1,585,756

The questions, what is the total amount of available coal in the coalfields of Great Britain and Ireland, and how long it may be expected to last, have frequently been discussed since the early part of the 19th century, and particular attention was directed to them after the publication of Stanley Jevons's book on *The Coal Question* in 1865. In 1866 a royal commission was appointed to inquire into the subject, and in its report, issued in 1871, estimated that the

coal resources of the country, in seams of 1 ft. thick and upwards situated within 4000 ft. of the surface, amounted to 90,207,285,398 tons. A second commission, which was appointed in 1901 and issued its final report in 1905, taking 4000 ft. as the limit of practicable depth in working and 1 ft. as the minimum workable thickness, and after making all necessary deductions, estimated the available quantity of coal in the proved coalfields of the United Kingdom as 100,914,668,167 tons. Although in the years 1870-1903 the amount raised was 5,694,928,507 tons, this later estimate was higher by 10,707,582,769 tons than that of the previous commission, the excess being accounted for partly by the difference in the areas regarded as productive by the two commissions, and partly by new discoveries and more accurate knowledge of the coal seams. In addition it was estimated that in the proved coalfields at depths greater than 4000 ft. there were 5,239,433,980 tons, and that in concealed and unproved fields, at depths less than 4000 ft. there were 39,483,844,000 tons, together with 854,608,307 tons in that part of the Cumberland coalfield beyond 5 m. and within 12 m. of high-water mark, and 383,024,000 tons in the South Wales coalfield under the sea in St Bride's Bay and part of Carmarthen Bay.

In Table V. below column I. shows the quantity of coal still remaining unworked in the different coalfields at depths not exceeding 4000 ft. and in seams not less than 1 ft. thick, as estimated by seven district commissioners; column II. the total estimated reductions on account of loss in working due to faults and other natural causes in seams and of coal required to be left for barriers, support of surface buildings, &c.; and column III. the estimated net available amount remaining unworked.

As regards the duration of British coal resources, the commissioners reported (1905):—

" This question turns chiefly upon the maintenance or the variation of the annual output. The calculations of the last Coal Commission as to the future exports and of Mr Jevons as to the future annual consumption make us hesitate to prophesy how long our coal resources are likely to last. The present annual output is in round numbers 230 million tons, and the calculated available resources in the proved coalfields are in round numbers 100,000 million tons, exclusive of the 40,000 million tons in the unproved coalfields, which we have thought best to regard only as probable or speculative. For the last thirty years the average increase in the output has been 2½% per annum, and that in the exports (including bunkers) 4½% per annum. It is the general opinion of the District Commissioners that owing to physical considerations it is highly probable that the present rate of increase of the output of coal can long continue—indeed, they think that some districts have already attained their maximum output, but that on the other hand the developments in the newer coalfields will possibly increase the total output for some years.

In view of this opinion and of the exhaustion of the shallower collieries we look forward to a time, not far distant, when the rate of increase of output will be slower, to be followed by a period of stationary output, and then a gradual decline."

According to a calculation made by P. Frech in 1900, on the basis of the then rate of production, the coalfields of central France, central Bohemia, the kingdom of Saxony, the Prussian province of Saxony and the north of England, would be exhausted in 100 to 200 years, the other British coalfields, the Waldenburg-Schatzlar and that of the north of France in 250 years, those of Saarbrücken, Belgium, Aachen and Westphalia in 600 to 800 years, and those of Upper Silesia in more than 1000 years. (O. J. R. H.; H. M. R.)

Coal-Mining.

The opening and laying out, or, as it is generally called, "winning," of new collieries is rarely undertaken without a preliminary examination of the character of the strata by means of borings, either for the purpose of determining the

TABLE V.

District.	Coalfield.	I.	II.	III.
A.	South Wales and Monmouthshire	33,443,000,339	6,972,003,760	26,470,996,579
	Somersetshire and part of Gloucestershire	No details	No details	4,198,301,099
	Forest of Dean	305,928,137	47,394,690	258,533,447
B.	North Stafford	5,267,833,074	899,782,727	4,368,050,347
	South Stafford	1,953,627,435	538,179,363	1,415,448,072
	Warwickshire	1,448,804,556	321,822,653	1,126,981,903
C.	Leicestershire	2,467,583,205	642,124,654	1,825,458,551
	Shropshire	369,174,620	48,180,921	320,993,699
	Lancashire	5,349,554,437	1,111,046,710	4,238,507,727
D.	Cheshire	358,998,172	67,165,901	291,832,271
	North Wales	2,513,026,200	776,558,371	1,736,467,829
	Yorkshire	No details	No details	19,138,006,395
E.	Derby and Notts.	No details	No details	7,360,725,100
	Northumberland	7,040,348,127	1,530,722,486	5,509,625,641
	Cumberland	2,188,938,830	661,230,025	1,527,708,805
F.	Durham	6,607,700,522	1,336,584,176	5,271,116,346
	Scotland	21,259,767,661	5,579,311,305	15,681,456,356
G.	Ireland	No details	No details	174,458,000

number and nature of the coal seams in new ground, or the position of the particular seam or seams which it is proposed to work in extensions of known coalfields.

The principle of proving a mineral field by boring is illustrated by fig. 1, which represents a line direct from the dip to the rise of the field, the inclination of the strata being one in eight. No. 1 bore is commenced at the dip, and reaches a seam of coal A, at 40 fathoms; at this depth it is considered proper to remove nearer to the outcrop so that lower strata may be bored into at a less depth, and a second bore is commenced. To find the position of No. 2, so as to form a continuous section, it is necessary to reckon the inclination of the strata, which is 1 in 8; and as

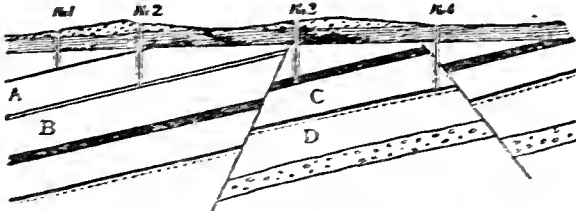

FIG. 1.—Proving by Boreholes.

bore No. 1 was 40 fathoms in depth, we multiply the depth by the rate of inclination, $40 \times 8 = 320$ fathoms, which gives the point at which the coal seam A should reach the surface. But there is generally a certain depth of alluvial cover which requires to be deducted, and which we call 3 fathoms, then $(40 - 3 = 37) \times 8 = 296$ fathoms; or say 286 fathoms is the distance that the second bore should be placed to the rise of the first, so as to have, for certain, the seam of coal A in clear connexion with the seam of coal B. In bore No. 3, where the seam B, according to the same system of arrangement, should have been found at or near the surface, another seam C is proved at a considerable depth, differing in character and thickness from either of the preceding. This derangement being carefully noted, another bore to the outcrop on the same principle is put down for the purpose of proving the seam C; the nature of the strata at first is found to agree with the latter part of that bored through in No. 3, but immediately on crossing the dislocation seen in the figure it is changed and the deeper seam D is found.

The evidence therefore of these bores (3 and 4) indicates some material derangement, which is then proved by other bores, either towards the dip or the outcrop, according to the judgment of the borer, so as to ascertain the best position for sinking pits. For the methods of boring see BORING.)

The working of coal may be conducted either by means of levels or galleries driven from the outcrop in a valley, or by shafts or pits sunk from the surface. In the early days of coal-mining, open working, or quarrying from the outcrop of the seams, was practised to a considerable extent; but there are now few if any places in England where this can be done. In 1873 there could be seen, in the thick coal seams of Bengal, near Raniganj, a seam about 50 ft. thick laid bare, over an area of several acres, by stripping off a superficial covering varying from 10 to 30 ft., in order to remove the whole of the coal without loss by pillars. Such a case, however, is quite exceptional. The operations by which the coal is reached and laid out for removal are known as "winning," the actual working or extraction of the coal being termed "getting." In fig. 2 A B is a cross cut level, by which the seams of coal 1 and 2 are won, and C D a vertical shaft by which the seams 1, 2 and 3 are won. When the field is won by the former method, the coal lying above the level is said to be "level free." The mode of winning by level is of less general application than that by shafts, as the capacity for production is less, owing to the smaller size of roadways by which the coal must be brought to the surface, levels of large section being expensive and difficult to keep open when the mine has been for some time at work. Shafts, on the other hand, may be made of almost any capacity, owing to the high speed in drawing which is attainable

Methods
of
working.

with proper mechanism, and allow of the use of more perfect arrangements at the surface than can usually be adopted at the mouth of a level on a hill-side. A more cogent reason, however, is to be found in the fact that the principal coalfields are in flat countries, where the coal can only be reached by vertical sinking.

The methods adopted in driving levels for collieries are generally similar to those adopted in other mines. The ground is secured by timbering, or more usually by arching in masonry or brick-work. Levels like that in fig. 2, which are driven across the stratification, or generally anywhere not in coal, are known as "stone drifts." The sinking of colliery shafts, however, differs considerably from that of other mines, owing to their generally large size, and the difficulties that are often encountered from water during the sinking. The actual coal measure strata, consisting mainly of shales and clays, are generally impervious to water, but when strata of a permeable character are sunk through, such as the magesian limestone of the north of England, the Permian sandstones of the central counties, or the chalk and greensand in the north of France and Westphalia, special methods are required in order to pass the water-bearing beds, and to protect the shaft and workings from the influx of water subsequently. Of these methods one of the chief is the plan of tubbing, or lining the excavation with an impermeable casing of wood or iron, generally the latter, built up in segments forming rings, which are piled upon each other throughout the whole depth of the water-bearing strata. This method necessitates the use of very considerable pumping power during the sinking, as the water has to be kept down in order to allow the sinkers to reach a water-tight stratum upon which the foundation of the tubbing

Sinking of
shafts.

Tubbing.

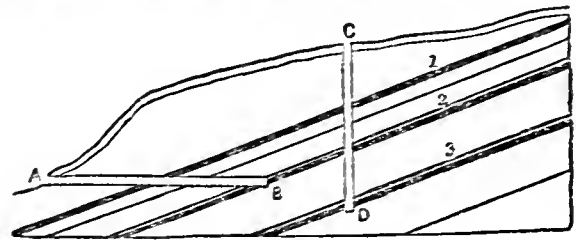

FIG. 2.—Shaft and Level.

can be placed. This consists of a heavy cast iron ring, known as a wedging crib, or curb, also fitted together in segments, which is lodged in a square-edged groove cut for its reception, tightly caulked with moss, and wedged into position. Upon this the tubbing is built up in segments, of which usually from 10 to 12 are required for the entire circumference, the edges being made perfectly true. The thickness varies according to the pressure expected, but may be taken at from $\frac{3}{4}$ to $1\frac{1}{2}$ in. The inner face is smooth, but the back is strengthened with angle brackets at the corners. A small hole is left in the centre of each segment, which is kept open during the fitting to prevent undue pressure upon any one, but is stopped as soon as the circle is completed. In the north of France and Belgium wooden tubbings, built of polygonal rings, were at one time in general use. The polygons adopted were of 20 or more sides approximating to a circular form.

The second principal method of sinking through water-bearing ground is by compressed air. The shaft is lined with a cylinder of wrought iron, within which a tubular chamber, provided with doors above and below, known as an air-lock, is fitted by a telescopic joint, which is tightly packed so as to close the top of the shaft air-tight. Air is then forced into the inclosed space by means of a compressing engine, until the pressure is sufficient to oppose the flow of water into the excavation, and to drive out any that may collect in the bottom of the shaft through a pipe which is carried through the air-sluice to the surface. The miners work in the bottom in the same manner as divers in an ordinary diving-bell. Access to the surface is obtained through the double doors of the air-sluice,

Pneumatic
sinking.

the pressure being reduced to that of the external atmosphere when it is desired to open the upper door, and increased to that of the working space below when it is intended to communicate with the sinkers, or to raise the stuff broken in the bottom. This method has been adopted in various sinkings on the continent of Europe.

The third method of sinking through water-bearing strata is that of boring, adopted by Messrs Kind & Chaudron in Belgium and Germany. For this purpose a horizontal bar armed with vertical cutting chisels is used, which cuts out the whole section of the shaft simultaneously.

Shaft boring. In the first instance, a smaller cutting frame is used, boring a hole from 3 to 5 ft. in diameter, which is kept some 50 or 60 ft. in advance, so as to receive the detritus, which is removed by a shell pump of large size. The large trepan or cutter weighs about 16 tons, and cuts a hole of from 9 to 15 ft. in diameter. The water-tight lining may be either a wrought iron tube, which is pressed down by jack screws as the borehole advances, or cast iron tubing put together in short complete rings, in contradistinction to the old plan of building them up of segments. The tubing, which is considerably less in diameter than the borehole, is suspended by rods from the surface until a bed suitable for a foundation is reached, upon which a sliding length of tube, known as the moss box, bearing a shoulder, which is filled with dried moss, is placed. The whole weight of the tubing is made to bear on the moss, which squeezes outwards, forming a completely water-tight joint. The interval between the back of the tubing and the sides of the borehole is then filled up with concrete, which on setting fixes the tubing firmly in position. With increase in depth, however, the thickness and weight of the cast iron tubing in a large shaft become almost unmanageable; in one instance, at a depth of 1215 ft., the bottom rings in a shaft 14½ ft. in diameter are about 4 in. thick, which is about the limit for sound castings. It has therefore been proposed, for greater depths, to put four columns of tubings of smaller diameters, 8½ and 5½ ft., in the shaft, and fill up the remainder of the boring with concrete, so that with thinner and lighter castings a greater depth may be reached. This, however, has not as yet been tried. Another extremely useful method of sinking through water-bearing ground, introduced by Messrs A. & H. T. Poetsch in 1883, and originally applied to shafts passing through quicksands above brown coal seams, has been applied with advantage in opening new pits through the secondary and tertiary strata above the coal measures in the north of France and Belgium, some of the most successful examples being those at Lens, Anzin and Vicq, in the north of France basin. In this system the soft ground or fissured water-bearing rock is rendered temporarily solid by freezing the contained water within a surface a few feet larger in diameter than the size of the finished shaft, so that the ground may be broken either by hand tools or blasting in the same manner as hard rock. The miners are protected by the frozen wall, which may be 4 or 5 ft. thick. The freezing is effected by circulating brine (calcium chloride solution) cooled to 5° F. through a series of vertical pipes closed at the bottom, contained in boreholes arranged at equal distances apart around the space to be frozen, and carried down to a short distance below the bottom of the ground to be secured. The chilled brine enters through a central tube of small diameter, passes to the bottom of the outer one and rises through the latter to the surface, each system of tubes being connected above by a ring main with the circulating pumps. The brine is cooled in a tank filled with spiral pipes, in which anhydrous ammonia, previously liquefied by compression, is vaporized *in vacuo* at the atmospheric temperature by the sensible heat of the return-current of brine, whose temperature has been slightly raised in its passage through the circulating tubes. When hard ground is reached, a seat is formed for the cast iron tubing, which is built up in the usual way and concreted at the back, a small quantity of caustic soda being sometimes used in mixing the concrete to prevent freezing. In an application of this method at Vicq, two shafts of 12 and 16.4 ft. diameter, in a covering of cretaceous strata, were frozen to a depth of 300 ft. in fifty days,

the actual sinking and lining operations requiring ninety days more. The freezing machines were kept at work for 200 days, and 2191 tons of coal were consumed in supplying steam for the compressors and circulating pumps.

The introduction of these special methods has considerably simplified the problem of sinking through water-bearing strata. Some of the earlier sinkings of this kind, when pumps had to be depended on for keeping down the water, were conducted at great cost, as, for instance, at South Hetton, and more recently Ryhope, near Sunderland, through the magnesian limestone of Durham.

The size and form of colliery shafts vary in different districts. In the United States and Scotland rectangular pits secured by timber framings are still common, but the tendency is now generally to make them round, 30 ft. being about the largest diameter employed. In the Midland counties, from 7 to 9 ft. is a very common size, but larger dimensions are adopted where a large production is required. Since the accident at Hartley colliery in 1862, caused by the breaking of the pumping-engine beam, which fell into the shaft and blocked it up, whereby the whole of the men then at work in the mine were starved to death, it has been made compulsory upon mine-owners in the United Kingdom to have two pits for each working, in place of the single one divided by walls or brattices which was formerly thought sufficient. The use of two independent connexions—whether separate pits or sections of the same pit, between the surface and the workings—is necessary for the service of the ventilation, fresh air from the surface being carried down one, known as the "downcast," while the foul or return air of the mine rises through the other or "upcast" pit back to the surface. In a heavily-watered mine it is often necessary to establish a special engine-pit, with pumps permanently fixed, or a division of one of the pits may be devoted to this purpose. The pumps, placed close to the point where the water accumulates, may be worked by an engine on the surface by means of heavy reciprocating rods which pass down the shaft, or by underground motors driven by steam, compressed air or electricity.

Where the water does not accumulate very rapidly it is a common practice to allow it to collect in a pit or sump below the working bottom of the shaft, and to draw it off in a water tub or "koppet" by the main engine, when the latter is not employed in raising coal.

The laying out of a colliery, after the coal has been won, by sinkings or levels, may be accomplished in various ways, according to the nature of the coal, its thickness and dip, and the extent of ground to be worked. In the South Staffordshire and other Midland coalfields, where only shallow pits are required, and the coals are thick, a pair of pits may be sunk for a very few acres, while in the North of England, on the other hand, where sinking is expensive, an area of some thousands of acres may be commanded from the same number of pits. In the latter case, which represents the most approved practice, the sinking is usually placed about the centre of the ground, so that the workings may radiate in every direction from the pit bottom, with the view of employing the greatest number of hands to advantage. Where a large area cannot be commanded, it is best to sink to the lowest point of the field for the convenience of drawing the coal and water which become level-free in regard to the pit. Where properties are much divided, it is always necessary to maintain a thick barrier of unwrought coal between the boundary of the mine and the neighbouring workings, especially if the latter are to the dip. If a prominent line of fault crosses the area it may usually be a convenient division of the fields into sections or districts. The first process in laying out the workings consists in driving a gallery on the level along the course of the coal seam, which is known as a "dip head level," and a lower parallel one, in which the water collects, known as a "lodgment level." Galleries driven at right angles to these are known as a "dip" or "rise headings," according to their position above or below the pit bottom. In Staffordshire the main levels are also known as

Size of shafts.

Laying out workings.

"gate roads." To secure the perpendicularity of the shaft, it is necessary to leave a large mass or pillar of the seam untouched around the pit bottom. This pillar is known in Scotland as the "pit bottom stoop." The junction of the levels with the pit is known as the "pit eye"; it is usually of an enlarged section, and lined with masonry or brick-work, so as to afford room for handling the wagons or trams of coal brought from the working faces. In this portion of the pit are generally placed the furnaces for ventilation, and the boilers required for working steam engines underground, as well as the stables and lamp cabin.

The removal of the coal after the roads have been driven may be effected in many different ways, according to the custom of

Method of working coal.

the district. These may, however, all be considered as modifications of two systems, viz. pillar work and long-wall work. In the former, which is also known as "post and stall" or "bord and pillar" in the north of England, "pillar and stall" in South Wales, and "stoop and room" in Scotland, the field is divided into strips by numerous openings driven parallel to the main rise headings, called "bords" or "bord gates," which are again divided by cutting through them at intervals, so as to leave a series of

Pillar working.

pillars arranged chequer-wise over the entire area. These pillars are left for the support of the roof as the workings advance, so as to keep the mine open and free from waste. In the oldest form of this class of working, where the size of the pillar is equal to the width of the stall or excavation, about $\frac{2}{3}$ of the whole seam will be removed, the remainder being left in the pillars. A portion of this may be got by the process known as robbing the pillars, but the coal so obtained is liable to be very much crushed from the pressure of the superincumbent strata. This crushing may take place either from above or below, producing what are known as "creeps" or "sits."

A coal seam with a soft pavement and a hard roof is the most subject to a "creep." The first indication is a dull hollow sound heard when treading on the pavement or floor, probably occasioned

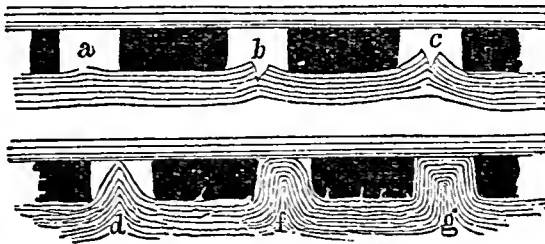

FIG. 3.—"Creeps" in Coal-Mines.

by some of the individual layers parting from each other as shown at *a* fig. 3; the succeeding stages of creep are shown at *b*, *c*, *d*, *f*, and *g*, in the same figure; the last being the final stage, when the coal begins to sustain the pressure from the overlying strata, in common with the disturbed pavement.

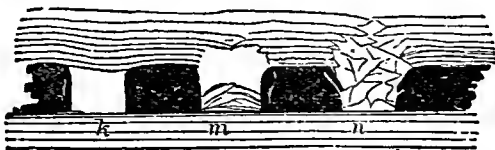

FIG. 4.—"Sits" in Mines.

"Sits" are the reverse of creeps; in the one case the pavement is forced up, and in the other the roof is forced or falls down, for want of proper support or tenacity in itself. This accident generally arises from an improper size of pillars; some roofs,

however, are so difficult to support that sits take place where the half of the coal is left in pillars. Fig. 4. will convey a general idea of the appearance of sits,—*k*, *m*, *n* showing different stages.

The modern method of pillar working is shown in fig. 5. In the Northumberland steam coal district, where it is carried out in the most perfect manner, the bords are 5 to 6 yds. in width, while the pillars are 22 yds. broad and 30 yds. long, which are subsequently got out on coming back. In the same figure is also shown the method of working whole coal and pillars at the same time, a barrier of two or three ranges of pillars or a rib of solid coal being left between the working in the solid and those in the pillars. The space from which the entire quantity of coal

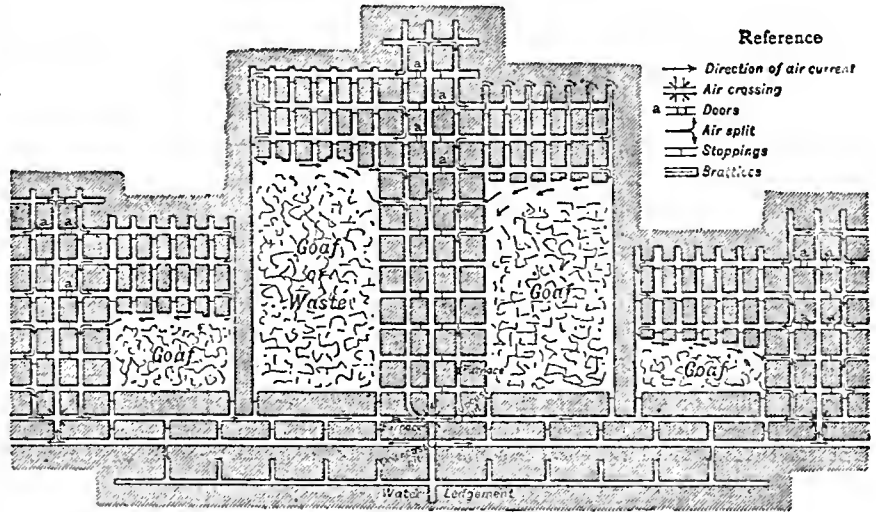

FIG. 5.—Pillar Working.

has been removed is known in different districts as the "goaf," "gob," or "waste."

Fig. 6 represents the Lancashire system of pillar working. The area is laid out by two pairs of level drifts, parallel to each other, about 150 yds. apart, which are carried to the boundary. About 100 yds. back from the boundary a communication is made between these levels, from which other levels are driven forward, dividing the coal into ribs of about 25 or 30 yds. wide, which are then cut back by taking off the coal in slices from

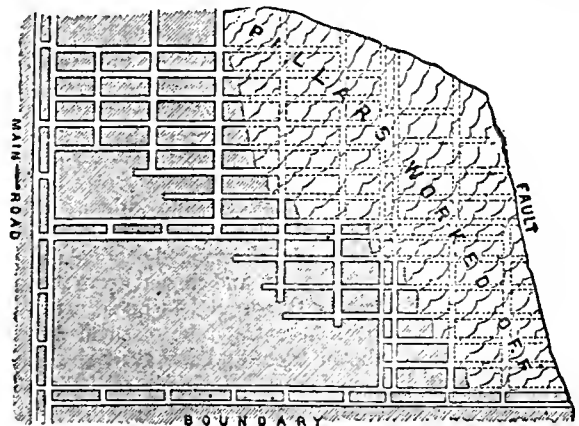

FIG. 6.—Lancashire method of working Coal.

the level towards the rise in breadths of about 6 yds. By this method the whole of the coal is got backwards, the main roads being kept in solid coal; the intermediate levels not being driven till they are wanted, a greater amount of support is given, and the pillars are less crushed than is usual in pillar working.

In the South Wales system of working, cross headings are driven from the main roads obliquely across the rise to get a sufficiently easy gradient for horse roads, and from these the stalls are opened out with a narrow entrance, in order to

leave support on either side of the road, but afterwards widening to as great a breadth as the seam will allow, leaving pillars of a minimum thickness. The character of such workings is very irregular in plan, and as the ventilation is attended with considerable difficulty, it is now becoming generally superseded by more improved methods.

The second great principle of working is that known as long-wall or long-work, in which the coal is taken away either in broad faces from roads about 40 or 50 yds. apart and parallel to each other, or along curved faces between roads radiating from the pit bottom—the essential feature in both cases being the removal of the whole of the coal at once, without first sub-dividing it into pillars, to be taken away at a

Long-wall working.

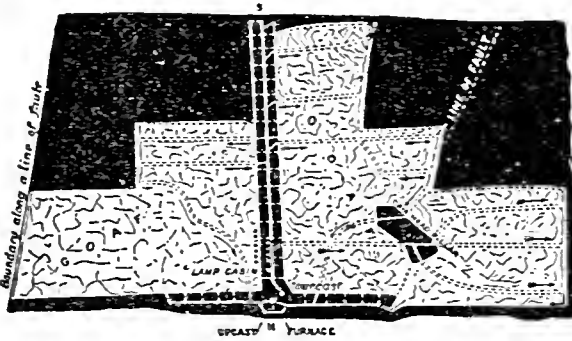

FIG. 7.—Long-wall method of working Coal in Derbyshire.

second working. The roof is temporarily supported by wooden props or pack walling of stone, for a sufficient breadth along the face to protect the workmen, and allow them to work together behind. The general character of a long-wall working is shown in fig. 7, which represents an area of about 500 acres of the bottom hard steam coal at Shipley in Derbyshire. The principal road extends from the shafts southward; and on both sides of it the coal has been removed from the light-shaded area by cutting it back perpendicularly towards the boundaries, along faces about 50 yds. in length, those nearest to the shaft being kept in advance of those farther away, producing a step-shaped outline to the face of the whole coal. It will be seen that by this method the whole of the seam, with the exception of the pillars left to protect the main roadways, is removed. The roads for drawing the coal from the working faces to the shaft are kept open by walling through the waste or goaf produced by the fall of the unsupported roof. The straight roads are the air-ways for carrying pure air from the down-cast shaft to the working faces, while the return air passes along the faces and back to the up-cast by the curved road. The above is the method of working long-wall forward, *i.e.* taking the coal in advance from the pit towards the boundary, with roads kept open through the gob. Another method consists in driving towards the boundary, and taking the coal backward towards the shafts, or working homeward, allowing the waste to close up without roads having to be kept open through it. This is of course preferable, but is only applicable where the owner of the mine can afford to expend the capital required to reach the limit of the field in excess of that necessary when the raising of coal proceeds *pari passu* with the extension of the main roads. Fig. 6 is substantially a modification of this kind of long-wall work.

South Yorkshire method.

Fig. 8 represents a method of working practised in the South Yorkshire district, known as bords and banks. The field is divided by levels and headings into rectangular banks, while from the main levels bords or wickets about 30 yds. wide, separated from each other by banks of about the same width, are carried forward in long-wall work, as shown on the left side of the figure, the waste being carefully packed behind so as to secure the ventilation. When these have been worked up to the extremity, as shown on the right side, the intermediate bank is removed by working backward towards the level. This system, therefore, combines both methods of long-wall working, but it is not generally applicable, owing to the

difficulty of ventilation, due to the great length of air-way that has to be kept open around the waste on each bank.

The relative advantages of the different methods may be generally stated as follows. Long-wall work is best suited for thin coals, and those having a good roof, *i.e.* one that gives way gradually and fills up the excavation made by removing the coal without scaling off suddenly and falling into the working faces, when practically the whole of the coal may be removed. Against these advantages must be placed the difficulties attending the maintenance of roads through the goaves, and in some cases the large proportion of slack to round or large coal obtained. Pillar working, in the whole coal, is generally reputed to give a more advantageous proportion of round coal to slack, the latter being more abundantly produced on the removal of the pillars, but as these form only a small portion of the whole seam, the general yield is more advantageous than in the former method. The ventilation of pillar working is often attended with difficulty, and the coal is longer exposed to the influence of the air, a point of importance in some coals, which deteriorate in quality when exposed to a hot damp atmosphere. The great increase in the size of the pillars in the best modern collieries worked upon this principle has, however, done much to approximate the two systems to an equality in other respects.

Where the whole of the coal is removed at once there is less chance of surface damage, when the mines are deep, than with pillar workings. A notable instance of this was afforded at Newstead, Notts, where the ruined front of Newstead Abbey was lowered several feet without any injury to the structure.

The working of very thick seams presents certain special peculiarities, owing to the difficulties of supporting the roof in the excavated portions, and supplying fresh air to the workings. The most typical example of this kind of working in England is afforded by the thick coal of South Staffordshire, which consists of a series of closely associated coal seams, varying from 8 to 12 or 13, divided

Working thick seams.

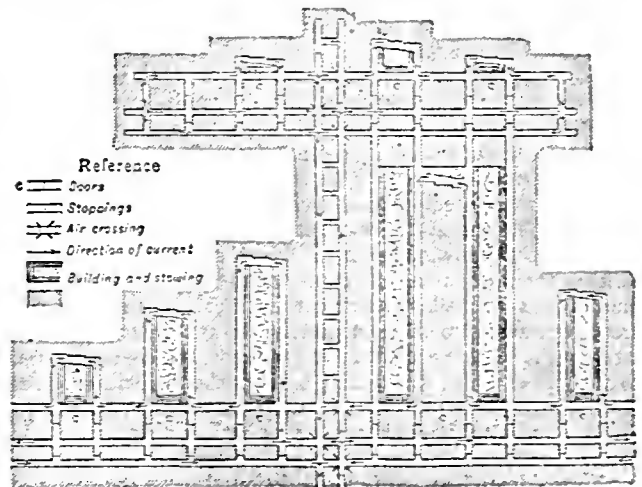

FIG. 8.—Bords and Banks.

from each other by their partings, but making together one great bed of from 25 to 40 ft. or more in thickness. The partings together do not amount to more than 2 or 3 ft. The method of working which has been long in use is represented in fig. 9. The main level or gate road is driven in the benches coal, or lower part of the seam, while a smaller drift for ventilation, called an air heading, is carried above it in one of the upper beds called the slipper coal. From the gate road a heading called a bolt-hole is opened, and extended into a large rectangular chamber, known as a "side of work," large pillars being left at regular intervals, besides smaller ones or cogs. The order in which the coal is cut is shown in the dotted and numbered squares in the figure. The coal is first cut to the top of the slipper coal from below, after which the upper portion is either broken down by wedging or falls of itself. The working of these upper portions is exceedingly

dangerous, owing to the great height of the excavations, and fatal accidents from falls of roof are in consequence more common in South Staffordshire than in any other coalfield in this country. The air from the down-cast shaft enters from the gate road, and passes to the up-cast through the air heading above. About one-half of the total coal (or less) is obtained in the first working; the roof is then allowed to fall, and when the gob is sufficiently consolidated, fresh roads are driven through it to obtain the ribs and pillars left behind by a second or even, in some cases, a third

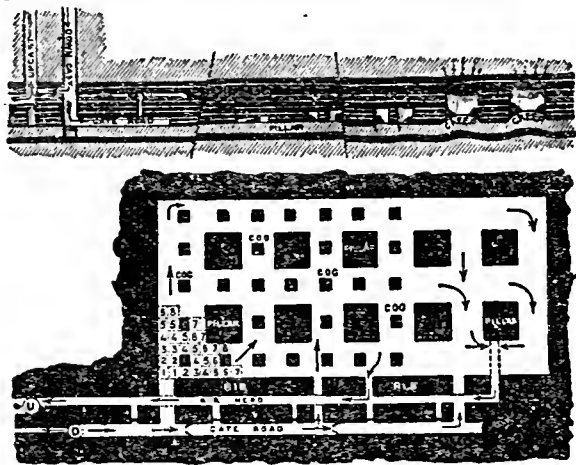

FIG. 9.—South Staffordshire method of working Thick Coal.

working. The loss of coal by this method is very considerable, besides great risk to life and danger from fire. It has, therefore, been to some extent superseded by the long-wall method, the upper half being taken at the first working, and removed as completely as possible, working backwards from the boundaries to the shaft. The lower half is then taken in the same manner, after the fallen roof has become sufficiently consolidated to allow the mine to be re-opened.

In the working of thick seams inclined at a high angle, such as those in the south of France, and in the lignite mines of Styria and Bohemia, the method of working in horizontal slices, about 12 or 15 ft. thick, and filling up the excavation with broken rock and earth from the surface, is now generally adopted in preference to the systems formerly used. At Monceaux les Mines, in France, a seam 40 ft. thick, and dipping at an angle of 20°, is worked in the following manner. A level is driven in a sandstone forming the floor, along the course of the coal, into which communications are made by cross cuts at intervals of 16 yds., which are driven across to the roof, dividing up the area to be worked into panels. These are worked backwards, the coal being taken to a height of 20 ft., the opening being packed up with stone sent down from the surface. As each stage is worked out, the floor level is connected with that next below it by means of an incline, which facilitates the introduction of the packing material. Stuff containing a considerable amount of clay is found to be the best suited for the purpose of filling, as it consolidates readily under pressure.

In France and Germany the method of filling the space left by the removal of the coal with waste rock, quarried underground or sent down from the surface, which was originally used in connexion with the working of thick inclined seams by the method of horizontal slices, is now largely extended to long-wall workings on thin seams, and in Westphalia is made compulsory where workings extend below surface buildings, and safety pillars of unwrought coal are found to be insufficient. With careful packing it is estimated that the surface subsidence will not exceed 40% of the thickness of the seam removed, and will usually be considerably less. The material for filling may be the waste from earlier workings stored in the spoil banks at the surface; where there are blast furnaces in the neighbourhood, granulated slag mixed with earth affords excellent packing. In thick seams packing adds about 5d. per ton to the cost of the coal, but in thinner seams the advantage is on the other side.

In some anthracite collieries in America the small coal or culm and other waste are washed into the exhausted workings by water which gives a compact mass filling the excavation when the water has drained away. A modification of this method, which originated in Silesia, is now becoming of importance in many European coalfields. In this the filling material, preferably sand, is sent down from the surface through a vertical steel pipe mixed with sufficient water to allow it to flow freely through distributing pipes in the levels commanding the excavations to be filled; these are closed at the bottom by screens of boards sufficiently close to retain the packing material while allowing the water to pass by the lower level to the pumping-engine which returns it to the surface.

The actual cutting of the coal is chiefly performed by manual labour, the tool employed being a sharp-pointed double-armed pick, which is nearly straight, except when required for use in hard rock, when the arms are made with an inclination or "anchored." The terms pike, pick, mandril and slitter are applied to the collier's pick in different districts, the men being known as pikemen or hewers. In driving levels it is necessary to cut grooves vertically parallel to the walls, a process known as shearing; but the most important operation is that known as holing or kirving, which consists in cutting a notch or groove in the floor of the seam to a depth of about 3 ft., measured back from the face, so as to leave the overhanging part unsupported, which then either falls of its own accord within a few hours, or is brought down either by driving wedges along the top, or by blasting. The process of holing in coal is one of the severest kinds of human labour. It has to be performed in a constrained position, and the miner lying on his side has to cut to a much greater height, in order to get room to carry the groove in to a sufficient depth, than is required to bring the coal down,

giving rise to a great waste in slack as compared with machine work. This is sometimes obviated by holing in the beds below the coal, or in any portion of a seam of inferior quality that may not be worth working. This loss is proportionately greater in thin than in thick seams, the same quantity being cut to waste in either case.

The method of cutting coal on the long-wall system is seen in fig. 10, representing the working at the Shipley colliery. The coal is 40 in. thick, with a seam of fire-clay and a roof of black shale; about 6 in. of the upper part, known as the roof coal, not being worth working, is left behind. A groove of triangular section of 30 in. base and 9 in. high is cut along the face,

inclined timber props being placed at intervals to support the overhanging portion until the required length is cut. These are then removed, and the coal is allowed to fall, wedges or blasting being employed when necessary. The roof of the excavation is supported as the coal is removed, by packing up the waste material, and by a double row of props 2 ft. from each other, placed temporarily along the face. These are placed 5 ft. apart, the props of the back row alternating with those in front.

Methods
of cutting
coal.

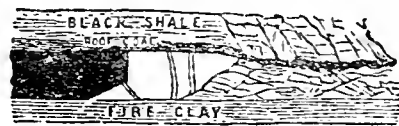
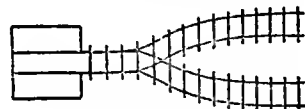

FIG. 10.—Long-wall working-face—Plan and Section.

The props used are preferably of small oak or English larch, but large quantities of fir props, cut to the right length, are also imported from the north of Europe. As the work proceeds onwards, the props are withdrawn and replaced in advance, except those that may be crushed by the pressure or buried by sudden falls of the roof.

In Yorkshire hollow square pillars, formed by piling up short blocks of wood or chocks, are often used instead of props formed of a single stem.

In securing the roof and sides of coal workings, malleable iron and steel are now used to some extent instead of timber, although the consumption of the latter material is extremely large. As a substitute for timber props at the face, pieces of steel joists, with the web cut out for a short distance on either end, with the flanges turned back to give a square bearing surface, have been introduced. In large levels only the cap pieces for the roof are made of steel joists, but in smaller ones complete arches made of pieces of rails fish-jointed at the crown are used. In another system introduced by the Mannesmann Tube Company the prop is made up of weldless steel tubes sliding telescopically one within the other, which are fixed at the right height by a screw clamp capable of carrying a load of 15 to 16 tons. These can be most advantageously used on thick seams 6 to 10 ft. or upwards. For shaft linings steel rings of H or channel section supported by intermediate struts are also used, and cross-bearers or buntons of steel joists and rail guides are now generally substituted for wood.

When the coal has been under-cut for a sufficient length, the struts are withdrawn, and the overhanging mass is allowed to fall during the time that the workmen are out of the pit, or it may be brought down by driving wedges, or if it be of a compact character a blast in a borehole near the roof may be required. Sometimes, but rarely, it happens that it is necessary to cut vertical grooves in the face to determine the limit of the fall, such limits being usually dependent upon the cleet or divisional planes in the coal, especially when the work is carried perpendicular to them or on the end.

The substitution of machinery for hand labour in cutting coal has long been a favourite problem with inventors, the earliest plan being that of Michael Meinzie, in 1761, who proposed to work a heavy pick underground by power transmitted from an engine at the surface, through the agencies of spear-rods and chains passing over pulleys; but none of the methods suggested proved to be practically successful until the general introduction of compressed air into mines furnished a convenient motive power, susceptible of being carried to considerable distances without any great loss of pressure. This agent has been applied in various ways, in machines which either imitate the action of the collier by cutting with a pick or make a groove by rotating cutters attached to an endless chain or a revolving disk or wheel. The most successful of the first class, or pick machines, that of William Firth of Sheffield, consists essentially of a horizontal pick with two cutting arms placed one slightly in advance of the other, which is swung backwards and forwards by a pair of bell crank levers actuated by a horizontal cylinder engine mounted on a railway truck. The weight is about 15 cwt. At a working speed of 60 yds. per shift of 6 hours, the work done corresponds to that of twelve average men. The width of the groove cut is from 2 to 3 in. at the face, diminishing to 1½ in. at the back, the proportion of waste being very considerably diminished as compared with the system of holing by hand. The use of this machine has allowed a thin seam of cannel, from 10 to 14 in. in thickness, to be worked at a profit, which had formerly been abandoned as too hard to be worked by hand-labour. Pick machines have also been introduced by Jones and Levick, Bidder, and other inventors, but their use is now mostly abandoned in favour of those working continuously.

In the Gartsherrie machine of Messrs Baird, the earliest of the flexible chain cutter type, the chain of cutters works round a fixed frame or jib projecting at right angles from the engine carriage, an arrangement which makes it necessary to cut from

the end of the block of coal to the full depth, instead of holing into it from the face. The forward feed is given by a chain winding upon a drum, which hauls upon a pulley fixed to a prop about 30 yds. in advance. This is one of the most compact forms of machine, the smaller size being only 20 in. high. With an air pressure of from 35 to 40 lb. per sq. in., a length of from 300 to 350 ft. of coal is holed, 2 ft. 9 in. deep, in the shift of from 8 to 10 hours. The chain machine has been largely developed in America in the Jeffrey, Link Bell, and Morgan Gardner coal cutters. These are similar in principle to the Baird machine, the cutting agent being a flat link chain carrying a double set of chisel points, which are drawn across the coal face at the rate of about 5 ft. per second; but, unlike the older machines, in which the cutting is done in a fixed plane, the chain with its motor is made movable, and is fed forward by a rack-and-pinion motion as the cutting advances, so that the cut is limited in breadth (3½ to 4 ft.), while its depth may be varied up to the maximum travel (8 ft.) of the cutting frame. The carrying frame, while the work is going on, is fixed in position by jackscrews bearing against the roof of the seam, which, when the cut is completed, are withdrawn, and the machine shifted laterally through a distance equal to the breadth of the cut and fixed in position again. The whole operation requires from 8 to 10 minutes, giving a cutting speed of 120 to 150 sq. ft. per hour. These machines weigh from 20 to 22 cwt., and are mostly driven by electric motors of 25 up to 35 h.p. as a maximum. By reason of their intermittent action they are only suited for use in driving galleries or in pillar-and-stall workings.

A simple form of the saw or spur wheel coal-cutting machine is that of Messrs Winstanly & Barker (fig. 11), which is driven

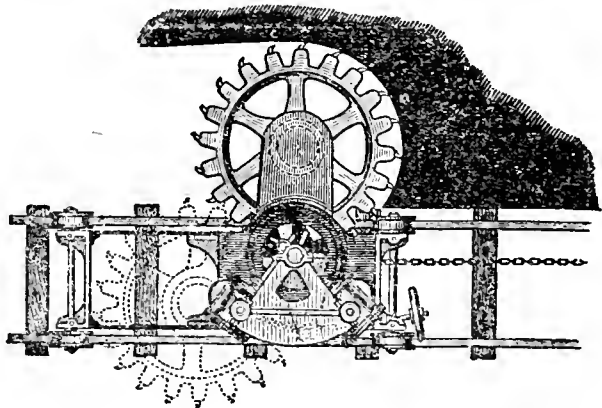

FIG. 11.—Winstanly & Barker's Coal-cutting Machine—Plan.

by a pair of oscillating engines placed on a frame running on rails in the usual way. The crank shaft carries a pinion which gears into a toothed wheel of a coarse pitch, carrying cutters at the ends of the teeth. This wheel is mounted on a carrier which, being movable about its centre by a screw gearing worked by hand, gives a radial sweep to the cutting edges. When at work it is slowly turned until the carrier is at right angles to the frame, when the cut has attained the full depth. The forward motion is given by a chain winding upon a crab placed in front, by which it is hauled slowly forward. With 25 lb pressure it will hole 3 ft. deep, at the rate of 30 yds. per hour, the cut being only 2½ in. high, but it will only work on one side of the carriage. This type has been greatly improved and now is the most popular machine in Great Britain, especially in long-wall workings. W. E. Garforth's Diamond coal cutter, one of the best known, undercuts from 5½ to 6 ft. In some instances electric motors have been substituted for compressed-air engines in such machines.

Another class of percussive coal-cutters of American origin is represented by the Harrison, Sullivan and Ingersoll-Sergeant machines, which are essentially large rock drills without turning gear for the cutting tool, and mounted upon a pair of wheels placed so as to allow the tool to work on a forward slope. When in use the machine is placed upon a wooden platform inclining

towards the face, upon which the miner lies and controls the direction of the blow by a pair of handles at the back of the machine, which is kept stationary by wedging the wheels against a stop on the platform. These machines, which are driven by compressed air, are very handy in use, as the height and direction of the cut may be readily varied; but the work is rather severe to the driver on account of the recoil shock of the piston, and an assistant is necessary to clear out the small coal from the cut, which limits the rate of cutting to about 125 sq. ft. per hour.

Another kind of application of machinery to coal mining is that of Messrs Bidder & Jones, which is intended to replace the use of blasting for bringing down the coal. It consists

Coal-wedging machines.

of a small hydraulic press, which forces a set of expanding bits or wedges into a bore-hole previously bored by a long screw augur or drill, worked by hand, the action of the press being continued until a sufficient strain is obtained to bring down the coal. The arrangement is, in fact, a modification of the plug and feather system used in stone quarrying for obtaining large blocks, but with the substitution of the powerful rending force of the hydraulic press for hand-power in driving up the wedges. This apparatus has been used at Harecastle in North Staffordshire, and found to work well, but with the disadvantage of bringing down the coal in unmanageably large masses. A method of wedging down coal sufficiently perfected to be of general application would add greatly to the security of colliers.

The removal of the coal broken at the working face to the pit bottom may in small mines be effected by hand labour, but more generally it is done by horse or mechanical traction, upon railways, the "trams" or "tubs," as the pit wagons are called, being where possible brought up to the face. In steeply inclined seams passes or shoots leading to the main level below are sometimes used, and in Belgium iron plates are sometimes laid in the excavated ground to form a slide for the coal down to the loading place. In some instances travelling belts or creepers have been adopted, which deliver the coal with a reduced amount of breakage, but this application is not common. The capacity of the trams varies with the size of the workings and the shaft. From 5 to 7 cwt. are common sizes, but in South Wales they are larger, carrying up to one ton or more. The rails used are of flat bottomed or bridge section varying in weight from 15 to 25 lb to the yd.; they are laid upon cross sleepers in a temporary manner, so that they can be easily shifted along the working faces, but are carefully secured along main roads intended to carry traffic continuously for some time. The arrangement of the roads at the face is shown in the plan, fig. 10. In the main roads to the pit when the distance is not considerable horse traction may be used, a train of 6 to 15 vehicles being drawn by one horse, but more generally the hauling or, as it is called in the north of England, the leading of the trains of tubs is effected by mechanical traction.

In a large colliery where the shafts are situated near the centre of the field, and the workings extend on all sides, both to the dip and rise, the drawing roads for the coal may be of three different kinds—(1) levels driven at right angles to the dip, suitable for horse roads, (2) rise ways, known as jimmy roads, jig-brows, or up-brows, which, when of sufficient slope, may be used as self-acting planes, *i.e.* the loaded waggons may be made to pull back the empty ones to the working faces, and (3) dip or down-brows, requiring engine power. A road may be used as a self-acting or gravitating incline when the gradient is 1 in 30 or steeper, in which case the train is lowered by a rope passing over a pulley or brake drum at the upper end, the return empty train being attached to the opposite end of the rope and hauled up by the descending load. The arrangements for this purpose vary, of course, with the amount of work to be done with one fixing of the machinery; where it is likely to be used for a considerable time, the drum and brake are solidly constructed, and the ropes of steel or iron wire carefully guided over friction rollers, placed at intervals between the rails to prevent them from chafing and wearing out on the ground. Where the load has to be hauled up a rising gradient, underground engines, driven by steam or compressed air or

electric motors, are used. In some cases steam generated in boilers at the surface is carried in pipes to the engines below, but there is less loss of power when compressed air is sent down in the same way. Underground boilers placed near the up-cast pit so that the smoke and gases help the ventilating furnace have been largely used but are now less favourably regarded than formerly. Water-pressure engines, driven by a column of water equal to the depth of the pit, have also been employed for hauling. These can, however, only be used advantageously where there are fixed pumps, the fall of water generating the power resulting in a load to be removed by the expenditure of an equivalent amount of power in the pumping engine above that necessary for keeping down the mine water.

The principal methods in which power can be applied to underground traction are as follows:—

1. Tail rope system.
2. Endless chain system.
3. Endless rope system on the ground.
4. Endless rope system overhead.

The three last may be considered as modifications of the same principle. In the first, which is that generally used in Northumberland and Durham, a single line of rails is used, the loaded tubs being drawn "out bye," *i.e.* towards the shaft, and the empty ones returned "in bye," or towards the working faces, by reversing the engine; while in the other systems, double lines, with the rope travelling continuously in the same direction, are the rule. On the tail rope plan the engine has two drums worked by spur gearing, which can be connected with, or cast loose from, the driving shaft at pleasure. The main rope, which draws out the loaded tubs, coils upon one drum, and passes near the floor over guide sheaves placed about 20 ft. apart. The tail rope, which is of lighter section than the main one, is coiled on the second drum, passes over similar guide sheaves placed near the roof or side of the gallery round a pulley at the bottom of the plane, and is fixed to the end of the train or set of tubs. When the load is being drawn out, the engine pulls directly on the main rope, coiling it on to its own drum, while the tail drum runs loose paying out its rope, a slight brake pressure being used to prevent its running out too fast. When the set arrives out bye, the main rope will be wound up, and the tail rope pass out from the drum to the end and back, *i.e.* twice the length of the way; the set is returned in bye, by reversing the engine, casting loose the main, and coupling up the tail drum, so that the tail rope is wound up and the main rope paid out. This method, which is the oldest, is best adapted for ways that are nearly level, or when many branches are intended to be worked from one engine, and can be carried round curves of small radius without deranging the trains; but as it is intermittent in action, considerable engine-power is required in order to get up the required speed, which is from 8 to 10 m. per hour. From 8 to 10 tubs are usually drawn in a set, the ways being often from 2000 to 3000 yds. long. In dip workings the tail rope is often made to work a pump connected with the bottom pulley, which forces the water back to the cistern of the main pumping engine in the pit.

For the endless chain system, which is much used in the Wigan district, a double line of way is necessary, one line for full and the other for empty tubs. The chain passes over a pulley driven by the engine, placed at such a height as to allow it to rest upon the tops of the tubs, and round a similar pulley at the far end of the plane. The forward edge of the tub carries a projecting pin or horn, with a notch into which the chain falls which drags the tub forward. The road at the outer end is made of a less slope than the chain, so that on arrival the tub is lowered, clears the pin, and so becomes detached from the chain. The tubs are placed on at intervals of about 20 yds., the chain moving continuously at a speed of from 2½ to 4 m. per hour. This system presents the greatest advantages in point of economy of driving power, especially where the gradients are variable, but is expensive in first cost, and is not well suited for curves, and branch roads cannot be worked continuously, as a fresh set of pulleys worked by bevel gearing is required for each branch.

The endless rope system may be used with either a single or

double line of way, but the latter is more generally advantageous. The rope, which is guided upon sheaves between the rails, is taken twice round the head pulley. It is also customary to use a stretching pulley to keep the rope strained when the pull of the load diminishes. This is done by passing a loop at the upper end round a pulley mounted in a travelling frame, to which is attached a weight of about 15 cwt. hanging by a chain. This weight pulls directly against the rope; so if the latter slacks, the weight pulls out the pulley frame and tightens it up again. The tubs are usually formed into sets of from 2 to 12, the front one being coupled up by a short length of chain to a clamping hook formed of two jaws moulded to the curve of the rope which are attached by the "run rider," as the driver accompanying the train is called. This system in many respects resembles the tail rope, but has the advantage of working with one-third less length of rope for the same length of way.

The endless rope system overhead is substantially similar to the endless chain. The wagons are attached at intervals by short lengths of chain lapped twice round the rope and hooked into one of the links, or in some cases the chains are hooked into hempen loops on the main rope. In mines that are worked from the outcrop by adits or day levels traction by locomotives driven by steam, compressed air or electricity is used to some extent. The most numerous applications are in America.

One of the most important branches of colliery work is the management of the ventilation, involving as it does the supply of fresh air to the men working in the pit, as well as the removal of inflammable gases that may be given off by the coal. This is effected by carrying through the workings a large volume of air which is kept continually moving in the same direction, descending from the surface by one or more pits known as intake or downcast pits, and leaving the mine by a return or upcast pit. Such a circulation of air can only be effected by mechanical means when the workings are of any extent, the methods actually adopted being—(1) The rarefaction of the air in the upcast pit by a furnace placed at the bottom; and (2) Exhaustion by machinery at the surface. The former plan, being the older, has been most largely used, but is becoming replaced by some form of machine.

The usual form of ventilating furnace is a plain fire grate placed under an arch, and communicating with the upcast shaft by an inclined drift. It is separated from the coal by a narrow passage walled and arched in brickwork on both sides. The size of the grate varies with the requirements of the ventilation, but from 6 to 10 ft. broad and from 6 to 8 ft. long are usual dimensions. The fire should be kept as thin and bright as possible, to reduce the amount of smoke in the upcast. When the mine is free from gas, the furnace may be worked by the return air, but it is better to take fresh air directly from the downcast by a scale, or split, from the main current. The return air from fiery workings is never allowed to approach the furnace, but is carried into the upcast by a special channel, called a dumb drift, some distance above the furnace drift, so as not to come in contact with the products of combustion until they have been cooled below the igniting point of fire-damp. Where the upcast pit is used for drawing coal, it is usual to discharge the smoke and gases through a short lateral drift near the surface into a tall chimney, so as to keep the pit-top as clear as possible for working. Otherwise the chimney is built directly over the mouth of the pit.

Mechanical ventilation may be effected either by direct exhaustion or centrifugal displacement of the air to be removed. In the first method reciprocating bells, or piston machines, or rotary machines of varying capacity like gas-works exhausters, are employed. They were formerly used on a very large scale in Belgium and South Wales, but the great weight of the moving parts makes it impossible to drive them at the high speed called for by modern requirements, so that centrifugal fans are now generally adopted instead. An early and very successful machine of this class, the Guibal fan, is represented in fig. 12. The fan has eight arms, framed together of wrought iron bars, with diagonal struts, so as to obtain rigidity with comparative

lightness, carrying flat close-boarded blades at their extremities. It revolves with the smallest possible clearance in a chamber of masonry, one of the side walls being perforated by a large round hole, through which the air from the mine is admitted to the centre of the fan. The lower quadrant of the casing is enlarged spirally, so as to leave a narrow rectangular opening at the bottom, through which the air is discharged into a chimney of gradually increasing section carried to a height of about 25 ft. The size of the discharge aperture can be varied by means of a flexible wooden shutter sliding in a groove in a cast iron plate, curved to the slope of the casing. By the use of the spiral guide casing and the chimney the velocity of the effluent air is gradually

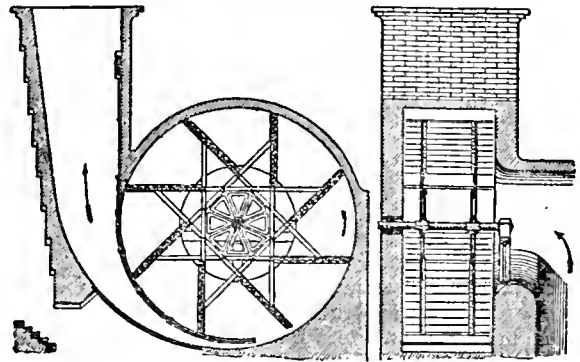

FIG. 12.—Guibal Fan.

reduced up to the point of final discharge into the atmosphere, whereby a greater useful effect is realized than is the case when the air streams freely from the circumference with a velocity equal to that of the rotating fan. The power is applied by steam acting directly on a crank at one end of the axle, and the diameter of the fan may be 40 ft. or more.

The Waddle fan, represented in fig. 13, is an example of another class of centrifugal ventilator, in which a close casing is not used, the air exhausted being discharged from the circumference directly into the atmosphere. It consists of a hollow sheet iron drum formed by two conoidal tubes, united together

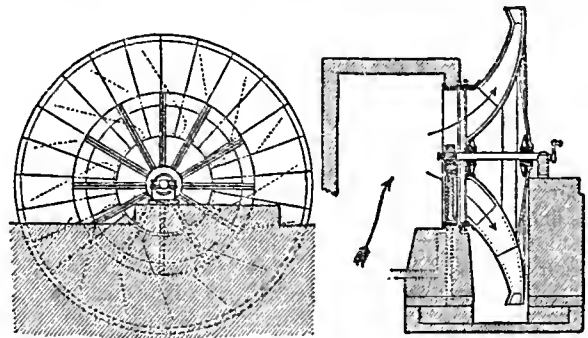

FIG. 13.—Waddle Fan.

by numerous guide blades, dividing it up into a series of rectangular tubes of diminishing section, attached to a horizontal axle by cast iron bosses and wrought iron arms. The tubes at their smallest part are connected to a cast iron ring, 10 ft. in diameter, but at their outer circumference they are only 2 ft. apart. The extreme diameter is 25 ft.

By the adoption of more refined methods of construction, especially in the shape of the intake and discharge passages for the air and the forms of the fan blades, the efficiency of the ventilating fan has been greatly increased so that the dimensions can be much reduced and a higher rate of speed adopted. Notable examples are found in the Rateau, Ser and Capell fans, and where an electric generating station is available electric motors can be advantageously used instead of steam.

The quantity of air required for a large colliery depends upon the number of men employed, as for actual respiration from

100 to 200 cub. ft. per minute should be allowed. In fiery mines, however, a very much larger amount must be provided in order to dilute the gas to the point of safety. **Distribution of air under ground.** Even with the best arrangements a dangerous increase in the amount of gas is not infrequent from the sudden release of stored-up masses in the coal, which, overpowering the ventilation, produce magazines of explosive material ready for ignition when brought in contact with the flame of a lamp or the blast of a shot. The management of such places, therefore, requires the most constant vigilance on the part of the workmen, especially in the examination of the working places that have been standing empty during the night, in which gas may have accumulated, to see that they are properly cleared before the new shift commences.

The actual conveyance or coursing of the air from the intake to the working faces is effected by splitting or dividing the current at different points in its course, so as to carry it as directly as possible to the places where it is required. In laying out the mine it is customary to drive the levels or roads in pairs, communication being made between them at intervals by cutting through the intermediate pillar; the air then passes along one and returns by the other. As the roads advance other pillars are driven through in the same manner, the passages first made being closed by stoppings of broken rock, or built up with brick and mortar walls, or both. When it is desired to preserve a way from one road or similar class of working to another, double doors placed at sufficient intervals apart to take in one or more trams between them when closed are used, forming a kind of lock or sluice. These are made to shut air-tight against their frames, so as to prevent the air from taking a short cut back to the upcast, while preserving free access between the different districts without following the whole round of the air-ways. The ventilation of ends is effected by means of brattices or temporary partitions of thin boards placed midway in the drift, and extending to within a few feet of the face. The air passes along one side of the brattice, courses round the free end, and returns on the other side. In many cases a light but air-proof cloth, specially made for the purpose, is used instead of wood for brattices, as being more handy and more easily removed. In large mines where the air-ways are numerous and complicated, it often happens that currents travelling in opposite directions are brought together at one point. In these cases it is necessary to cross them. The return air is usually made to pass over the intake by a curved drift carried some distance above in the solid measures, both ways being arched in brickwork, or even in some cases lined with sheet iron so as to ensure a separation not likely to be destroyed in case of an explosion (see figs. 5 and 8). The use of small auxiliary blowing ventilators underground, for carrying air into workings away from the main circuits, which was largely advocated at one time, has lost its popularity, but a useful substitute has been found in the induced draught produced by jets of compressed air or high-pressure water blowing into ejectors. With a jet of $\frac{1}{8}$ in. area, a pipe discharging $1\frac{2}{3}$ gallon of water per minute at 165 lb pressure per sq. in., a circulation of 850 cub. ft. of air per minute was produced at the end of a level, or about five times that obtained from an equal volume of air at 60 lb pressure. The increased resistance, due to the large extension of workings from single pairs of shafts, the ventilating currents having often to travel several miles to the upcast, has led to great increase in the size and power of ventilating fans, and engines from 250 to 500 H.P. are not uncommonly used for such purposes.

The lighting of underground workings in collieries is closely connected with the subject of ventilation. In many of the smaller pits in the Midland districts of England, and generally in South Staffordshire, the coals are sufficiently free from gas, or rather the gases are not liable to become explosive when mixed with air, to allow the use of naked lights, candles being generally used. Oil lamps are employed in many of the Scotch collieries, and are almost universally used in

Belgium and other European countries. The buildings near the pit bottom, such as the stables and lamp cabin, and even the main roads for some distance, are often in large collieries lighted with gas brought from the surface, or in some cases the gas given off by the coal is used for the same purpose. Where the gases are fiery, the use of protected lights or safety lamps (*q.v.*) becomes a necessity.

The nature of the gases evolved by coal when freshly exposed to the atmosphere has been investigated by several chemists, more particularly by Lyon Playfair and Ernst von Meyer. The latter observer found the gases given off by coal from the district of Newcastle and Durham to contain carbonic acid, marsh gas or light carburetted hydrogen (the fire-damp of the miner), oxygen and nitrogen. A later investigation, by J. W. Thomas, of the gases dissolved or occluded in coals from South Wales basin shows them to vary considerably with the class of coal. The results given below, which are selected from a much larger series published in the *Journal of the Chemical Society*, were obtained by heating samples of the different coals *in vacuo* for several hours at the temperature of boiling water:—

Composition of gas evolved by coal.

Quality.	Colliery.	Volume per ton in cub. ft.	Composition in Volumes per cent.			
			Carbonic Acid.	Oxygen.	Marsh Gas.	Nitrogen.
Bituminous	Cwm Clydach .	19.72	5.44	1.05	63.76	29.75
"	Lantwit . . .	14.34	9.43	2.25	31.95	56.34
Steam	Navigation .	89.62	13.21	0.49	81.64	4.66
Anthracite	Bonville's Court	198.95	2.62	..	93.13	4.25

In one instance about 1% of hydride of ethyl was found in the gas from a blower in a pit in the Rhondda district, which was collected in a tube and brought to the surface to be used in lighting the engine-room and pit-bank. The gases from the bituminous house coals of South Wales are comparatively free from marsh gas, as compared with those from the steam coal and anthracite pits. The latter class of coal contains the largest proportion of this dangerous gas, but holds it more tenaciously than do the steam coals, thus rendering the workings comparatively safer. It was found that, of the entire volume of occluded gas in an anthracite, only one-third could be expelled at the temperature of boiling water, and that the whole quantity, amounting to 650 cub. ft. per ton, was only to be driven out by a heat of 300° C. Steam coals being softer and more porous give off enormous volumes of gas from the working face in most of the deep pits, many of which have been the scene of disastrous explosions.

The gases evolved from the sudden outbursts or blowers in coal, which are often given off at a considerable tension, are the most dangerous enemy that the collier has to contend with. They consist almost entirely of marsh gas, with only a small quantity of carbonic acid, usually under 1%, and from 1 to 4% of nitrogen.

Fire-damp when mixed with from four to twelve times its volume of atmospheric air is explosive; but when the proportion is above or below these limits it burns quietly with a pale blue flame.

The danger arising from the presence of coal dust in the air of dry mines, with or without the addition of fire-damp, has, since it was first pointed out by Professor W. Galloway, been made the subject of special inquiries in the principal European countries interested in coal mining; and although certain points are still debatable, the fact is generally admitted as one calling for special precautions. The conclusions arrived at by the royal commission of 1891, which may be taken as generally representative of the views of British colliery engineers, are as follows:—

1. The danger of explosion when gas exists in very small quantities is greatly increased by the presence of coal dust.
2. A gas explosion in a fiery mine may be intensified or indefinitely propagated by the dust raised by the explosion itself.
3. Coal dust alone, without any gas, may cause a dangerous

explosion if ignited by a blown-out shot; but such cases are likely to be exceptional.

4. The inflammability of coal dust varies with different coals, but none can be said to be entirely free from risk.

5. There is no probability of a dangerous explosion being produced by the ignition of coal dust by a naked light or ordinary flame.

Danger arising from coal dust is best guarded against by systematically sprinkling or watering the main roads leading from the working faces to the shaft, where the dust falling from the trams in transit is liable to accumulate. This may be done by water-carts or hose and jet, but preferably by finely divided water and compressed air distributed from a network of pipes carried through the workings. This is now generally done, and in some countries is compulsory, when the rocks are deficient in natural moisture. In one instance the quantity of water required to keep down the dust in a mine raising 850 tons of coal in a single shift was 28.8 tons, apart from that required by the jets and motors. The distributing network extended to more than 30 m. of pipes, varying from $3\frac{1}{2}$ in. to 1 in. in diameter.

In all British coal-mines, when gas in dangerous quantities has appeared within three months, and in all places that are dry and dusty, blasting is prohibited, except with "permitted" explosives, whose composition and properties have been examined at the testing station at the Royal Arsenal, Woolwich. A list of those sanctioned is published by the Home Office. They are mostly distinguished by special trade names, and are mainly of two classes—those containing ammonium nitrate and nitrobenzene or nitronaphthalene, and those containing nitroglycerin and nitrocellulose, which are essentially weak dynamites. The safety property attributed to them is due to the depression of the temperature of the flame or products of explosion to a point below that necessary to ignite fire-damp or coal dust in air from a blown-out shot. New explosives that are found to be satisfactory when tested are added to the list from time to time, the composition being stated in all cases.

Methods for enabling miners to penetrate into workings where the atmosphere is totally irrespirable have come into use for saving life after explosions and for repairing shafts and pit-work under water. The acrophore of A. Galibert was in its earlier form a bag of about 12 cub. ft. capacity containing air at a little above atmospheric pressure; it was carried on the back like a knapsack and supplied the means of respiration. The air was continually returned and circulated until it was too much contaminated with carbonic acid to be further used, a condition which limited the use of the apparatus to a very short period. A more extended application of the same principle was made in the apparatus of L. Denayrouze by which the air, contained in cylinders at a pressure of 300 to 350 lb per sq. in., was supplied for respiration through a reducing valve which brought it down nearly to atmospheric pressure. This apparatus was, however, very heavy and became unmanageable when more than an hour's supply was required. The newer forms are based upon the principle, first enunciated by Professor Theodor Schwann in 1854, of carrying compressed oxygen instead of air, and returning the products of respiration through a regenerator containing absorptive media for carbonic acid and water, the purified current being returned to the mouth with an addition of fresh oxygen. The best-known apparatus of this class is that developed by G. A. Meyer at the Shamrock colliery in Westphalia, where a body of men are kept in systematic training for its use at a special rescue station. This corps rendered invaluable service at the exploring and rescue operations after the explosion at Courrières in March 1906, the most disastrous mining accident on record, when 1100 miners were killed. A somewhat similar apparatus called the "weg," after the initials of the inventor, is due to W. E. Garforth of Wakefield. In another form of apparatus advantage is taken of the property possessed by sodium-potassium peroxide of giving off oxygen when damped; the residue of caustic soda and potash yielded by the reaction is used to absorb the carbonic acid of the expired air. Experiments have also been made with a device in which

the air-supply is obtained by the evaporation of liquid air absorbed in asbestos.

Underground fires are not uncommon accidents in coal-mines. In the thick coal workings in South Staffordshire the slack left behind in the sides of work is especially liable to fire from so-called spontaneous combustion, due to the rapid oxidation that is set up when finely divided coal is brought in contact with air. The best remedy in such cases is to prevent the air from gaining access to the coal by building a wall round the burning portion, which can in this way be isolated from the remainder of the working, and the fire prevented from spreading, even if it cannot be extinguished. When the coal is fired by the blast of an explosion it is often necessary to isolate the mine completely by stopping up the mouths of the pits with earth, or in extreme cases it must be flooded with water or carbonic acid before the fire can be brought under. There have been several instances of this being done in the fiery pits in the Barnsley district, notably at the great explosion at the Oaks colliery in 1866, when 360 lives were lost.

The drawing or winding of the coal from the pit bottom to the surface is one of the most important operations in coal mining, and probably the department in which mechanical appliances have been brought to the highest state of development.

The different elements making up the drawing arrangements of a colliery are—(1) the cage, (2) the shaft or pit fittings, (3) the drawing-rope, (4) the engine and (5) the surface arrangements. The cage, as its name implies, consists of one or more platforms connected by an open framework of vertical bars of wrought iron or steel, with a top bar to which the drawing-rope is attached. It is customary to have a curved sheet iron roof or bonnet when the cage is used for raising or lowering the miners, to protect them from injury by falling materials. The number of platforms or decks varies considerably; in small mines only a single one may be used, but in the larger modern pits two-, three- or even four-decked cages are used. The use of several decks is necessary in old pits of small section, where only a single tram can be carried on each. In the large shafts of the Northern and Wigan districts the cages are made about 8 ft. long and $3\frac{1}{2}$ ft. broad, being sufficient to carry two large trams on one deck. These are received upon a railway made of two strips of angle iron of the proper gauge for the wheels, and are locked fast by a latch falling over their ends. At Cadeby Main with four-decked cages the capacity is eight 10-cwt. tubs or 4 tons of coal.

The guides or conductors in the pit may be constructed of wood, in which case rectangular fir beams, about 3 by 4 in., are used, attached at intervals of a few feet to buntons or cross-beams built into the lining of the pit. Two guides are required for each cage; they may be placed opposite to each other, either on the long or short sides—the latter being preferable. The cage is guided by shoes of wrought iron, a few inches long and bell-mouthed at the ends, attached to the horizontal bars of the framing, which pass loosely over the guides on three sides, but in most new pits rail guides of heavy section are used. They are applied on one side of the cage only, forming a complete vertical railway, carried by iron cross sleepers, with proper seats for the rails instead of wooden buntons; the cage is guided by curved shoes of a proper section to cover the heads of the rails. Rigid guides connected with the walling of the pit are probably the best and safest, but they have the disadvantage of being liable to distortion, in case of the pit altering its form, owing to irregular movements of the ground, or other causes. Wooden guides being of considerable size, block up a certain portion of the area of the pit, and thus offer an impediment to the ventilation, especially in upcast shafts, where the high temperature, when furnace ventilation is used, is also against their use. In the Lancashire and the Midland districts wire-rope guides have been introduced to a very considerable extent, with a view of meeting the above objections. These are simply wire-ropes, from $\frac{3}{4}$ to $1\frac{1}{2}$ in. in diameter, hanging from a cross-bar connected with the pit-head framing at the surface, and attached to a similar

Methods of winding.

Cage.

Aero-phores.

Safety explosives.

bar at the bottom, which are kept straight by a stretching weight of from 30 cwt. to 4 tons attached to the lower bar. In some cases four guides are used—two to each of the long sides of the cage; but a more general arrangement is to have three—two on one side, and the third in an intermediate position on the opposite side. Many colliery managers, however, prefer to have only two opposite guides, as being safer. The cage is connected by tubular clips, made in two pieces and bolted together, which slide over the ropes. In addition to this it is necessary to have an extra system of fixed guides at the surface and at the bottom, where it is necessary to keep the cage steady during the operations of loading and landing, there being a much greater amount of oscillation during the passage of the cage than with fixed guides. For the same reason it is necessary to give a considerable clearance between the two lines of guides, which are kept from 15 to 18 in. apart, to prevent the possibility of the two cages striking each other in passing. With proper precautions, however, wire guides are perfectly safe for use at the highest travelling speed.

The cage is connected with the drawing-rope by short lengths of chain from the corners, known as tackling chains, gathered into a central ring to which the rope is attached.

Ropes and chains.

Round steel wire-ropes, about 2 in. in diameter, are now commonly used; but in very deep pits they are sometimes tapered in section to reduce the dead weight lifted. Flat ropes of steel or iron wire were and are still used to a great extent, but round ones are now generally preferred. In Belgium and the north of France flat ropes of aloë fibre (Manila hemp or plantain fibre) are in high repute, being considered preferable by many colliery managers to wire, in spite of their great weight. A rope of this class for a pit 1200 metres deep, tapered from 15.6 in. to 9 in. in breadth and from 2 in. to $1\frac{1}{2}$ in. in thickness, weighed 14.3 tons, and another at Anzin, intended to lift a gross load of 15 tons from 750 metres, is $2\frac{1}{2}$ in. broad and 3 in. thick at the drum end, and weighs 18 tons. Tapered round ropes, although mechanically preferable, are not advantageous in practice, as the wear being greater at the cage end than on the drum it is necessary to cut off portions of the former at intervals. Ultimately also the ropes should be reversed in position, and this can only be done with a rope of uniform section.

The engines used for winding or hoisting in collieries are usually direct-acting with a pair of horizontal cylinders coupled directly to the drum shaft. Steam at high pressure exhausting into the atmosphere is still commonly used,

Winding engines.

but the great power required for raising heavy loads from deep pits at high speeds has brought the question of fuel economy into prominence, and more economical types of the two-cylinder tandem compound class with high initial steam pressure, superheating and condensing, have come in to some extent where the amount of work to be done is sufficient to justify their high initial cost. One of the earliest examples was erected at Llanbradack in South Wales in 1894, and they have been somewhat extensively used in Westphalia and the north of France. In a later example at the Bargold pit of the Powell Duffryn Steam Coal Company a mixed arrangement is adopted with horizontal high-pressure and vertical low-pressure cylinders. This engine draws a net load of $5\frac{1}{2}$ tons of coal from a depth of 625 yds. in 45 seconds, the gross weight of the four trams, cage and chains, and rope, with the coal, being 20 tons 12 cwt. The work of the winding engine, being essentially of an intermittent character, can only be done with condensation when a central condenser keeping a constant vacuum is used, and even with this the rush of steam during winding may be a cause of disturbance. This difficulty may be overcome by using Rateau's arrangement of a low-pressure turbine between the engine and the condenser. The accumulator, which is similar in principle to the thermal storage system of Drutt Halpin, is a closed vessel completely filled with water, which condenses the excess of steam during the winding period, and becoming superheated maintains the supply to the turbine when the main engine is standing. The power so developed is generally utilized in the production of electricity, for which there is an abundant use about large collieries.

The drum, when round ropes are used, is a plain broad cylinder, with flanged rims, and cased with soft wood packing, upon which the rope is coiled; the breadth is made sufficient to take the whole length of the rope at two laps. One drum is usually fixed to the shaft, while the other is loose, with a screw link or other means of coupling, in order to be able to adjust the two ropes to exactly the same length, so that one cage may be at the surface when the other is at the bottom, without having to pay out or take up any slack rope by the engine.

For flat ropes the drum or bobbin consists of a solid disk, of the width of the rope fixed upon the shaft, with numerous parallel pairs of arms or horns, arranged radially on both sides, the space between being just sufficient to allow the rope to enter and coil regularly upon the preceding lap. This method has the advantage of equalizing the work of the engine throughout the journey, for when the load is greatest, with the full cage at the bottom and the whole length of rope out, the duty required in the first revolution of the engine is measured by the length of the smallest circumference; while the assistance derived from gravitating action of the descending cage in the same period is equal to the weight of the falling mass through a height corresponding to the length of the largest lap, and so on, the speed being increased as the weight diminishes, and vice versa. The same thing can be effected in a more perfect manner by the use of spiral or scroll drums, in which the rope is made to coil in a spiral groove upon the surface of the drum, which is formed by the frusta of two obtuse cones placed with their smaller diameters outwards. This plan, though mechanically a very good one, has certain defects, especially in the possibility of danger resulting from the rope slipping sideways, if the grooves in the bed are not perfectly true. The great size and weight of such drums are also disadvantages, as giving rather unmanageable dimensions in a very deep pit. In some cases, therefore, a combined form is adopted, the body of the drum being cylindrical, and a width equal to three or four laps conical on either side.

Counterbalance chains for the winding engines are used in the collieries of the Midland districts of England. In this method a third drum is used to receive a heavy flat link chain, shorter than the main drawing-ropes, the end of which hangs down a special or balance pit. At starting, when the full load is to be lifted, the balance chain uncoils, and continues to do so until the desired equilibrium between the working loads is attained, when it is coiled up again in the reverse direction, to be again given out on the return trip.

In Koepe's method the drum is replaced by a disk with a grooved rim for the rope, which passes from the top of one cage over the guide pulley, round the disk, and back over the second guide to the second cage, and a tail rope, passing round a pulley at the bottom of the shaft, connects the bottoms of the cages, so that the dead weight of cage, tubs and rope is completely counterbalanced at all positions of the cages, and the work of the engine is confined to the useful weight of coal raised. Motion is communicated to the rope by frictional contact with the drum, which is covered through about one-half of the circumference. This system has been used in Nottinghamshire, and at Sneyd, in North Staffordshire. In Belgium it was tried in a pit 940 metres deep, where it has been replaced by flat hempen ropes, and is now restricted to shallower workings. In Westphalia it is applied in about thirty different pits to a maximum depth of 761 metres.

A novelty in winding arrangements is the substitution of the electromotor for the steam engine, which has been effected in a few instances. In one of the best-known examples, the Zollern colliery in Westphalia, the Koepe system is used, the winding disk being driven by two motors of 1200 H.P. each on the same shaft. Motion is obtained from a continuous-current generator driven by an alternating motor with a very heavy fly-wheel, a combination known as the Ilgner transformer, which runs continuously with a constant draught on the generating station, the extremely variable demand of the winding engine during the acceleration period being met by the energy stored in the fly-wheel, which runs at a very high speed. This

arrangement works admirably as regards smoothness and safety in running, but the heavy first cost and complication stand in the way of its general adoption. Nevertheless about 60 electric winding engines were at work or under construction in May 1906.

The surface arrangements of a modern deep colliery are of considerable extent and complexity, the central feature being the head gear or pit frame carrying the guide pulleys which lead the winding ropes from the axis of the pit to the drum. This is an upright frame, usually made in wrought iron or steel strutted by diagonal thrust

beams against the engine-house wall or other solid abutments, the height to the bearings of the guide pulleys being from 80 to 100 ft. or more above the ground level. This great height is necessary to obtain head-room for the cages, the landing platforms being usually placed at some considerable height above the natural surface. The pulleys, which are made as large as possible up to 20 ft. in diameter to diminish the effect of bending strains in the rope by change in direction, have channelled cast iron rims with wrought iron arms, a form combining rigidity with strength, in order to keep down their weight.

To prevent accidents from the breaking of the rope while the cage is travelling in the shaft, or from over-winding when in consequence of the engine not being stopped in time the cage may be drawn up to the head-gear pulleys (both of which are unhappily not uncommon), various forms of safety catches and disconnecting hooks have been adopted. The former contrivances consist essentially of levers or cams with toothed surfaces or gripping shoes mounted upon transverse axes attached to the sides of the cage, whose function is to take hold of the guides and support the cage in the event of its becoming detached from the rope. The opposite axes are connected with springs which are kept in compression by tension of the rope in drawing but come into action when the pull is released, the side axes then biting into wooden guides or gripping those of steel bars or ropes. The use of these contrivances is more common in collieries on the continent of Europe, where in some countries they are obligatory, than in England, where they are not generally popular owing to their uncertainty in action and the constant drag on the guides when the rope slacks.

For the prevention of accidents from over-winding, detaching hooks are used. These consist essentially of links formed of a pair of parallel plates joined by a central bolt forming a scissors joint which is connected by chain links to the cage below and the winding-rope above. The outer sides of the link are shaped with projecting lugs above. When closed by the load the width is sufficient to allow it to enter a funnel-shaped guide on a cross-bar of the frame some distance above the bank level, but on reaching the narrower portion of the guide at the top the plates are forced apart which releases the ropes and brings the lugs into contact with the top of the cross-bar which secures the cage from falling.

Three principal patterns, those of King, Ormerod and Walker, are in use, and they are generally efficient supposing the speed of the cage at arrival is not excessive. To guard against this it is now customary to use some speed-checking appliance, independent of the engine-man, which reduces or entirely cuts off the steam supply when the cage arrives at a particular point near the surface, and applies the brake if the load is travelling too quickly. Maximum speed controllers in connexion with the winding indicator, which do not allow the engine to exceed a fixed rate of speed, are also used in some cases, with recording indicators.

When the cage arrives at the surface, or rather the platform forming the working top above the mouth of the pit, it is received upon the keeps, a pair of hinged gratings which are kept in an inclined position over the pit-top by counter-balance weights, so that they are pushed aside to allow the cage to pass upwards, but fall back and receive it when the engine is reversed. The tubs are then removed or struck by the landers, who pull them forward on to the platform, which is covered with cast iron plates; at the same time empty ones are pushed in from the opposite side. The cage is then lifted by the engine clear of the keeps, which are

Surface arrangements.

Striking and screening.

opened by a lever worked by hand, and the empty tubs start on the return trip. When the cage has several decks, it is necessary to repeat this operation for each, unless there is a special provision made for loading and discharging the tubs at different levels. An arrangement of this kind for shifting the load from a large cage at one operation was introduced by Fowler at Hucknall, in Leicestershire, where the trains are received into a framework with a number of platforms corresponding to those of the cage, carried on the head of a plunger movable by hydraulic pressure in a vertical cylinder. The empty tubs are carried by a corresponding arrangement on the opposite side. By this means the time of stoppage is reduced to a minimum, 8 seconds for a three-decked cage as against 28 seconds, as the operations of lowering the tubs to the level of the pit-top, discharging, and replacing them are performed during the time that the following load is being drawn up the pit.

In the United Kingdom the drawing of coal is generally confined to the day shift of eight hours, with an output of from 100 to 150 tons per hour, according to the depth, capacity of coal tubs, and facilities for landing and changing tubs. With Fowler's hydraulic arrangement 2000 tons are raised 600 yds. in eight hours. In the deeper German pits, where great thicknesses of water-bearing strata have to be traversed, the first establishment expenses are so great that in order to increase output the shaft is sometimes provided with a complete double equipment of cages and engines. In such cases the engines may be placed in line on opposite sides of the pit, or at right angles to each other. It is said that the output of single shafts has been raised by this method to 3500 and 4500 tons in the double shift of sixteen hours. It is particularly well suited to mines where groups of seams at different depths are worked simultaneously. Some characteristic figures of the yield for British collieries in 1898 are given below:—

Albion Colliery, South	}	551,000 tons in a year for one shaft and one engine.
Wales		
Silkworth Colliery, North-	}	535,000 tons in a year for shaft
umberland		580 yds. deep, two engines.
Bolsover Colliery, Derby	}	598,798 tons in 279 days, shaft
		365 yds. deep.
Denaby Main Colliery, Yorkshire	}	629,947 tons in 281 days, maxi-
		um per day 2673 tons.

At Cadeby Main colliery near Doncaster in 1906, 3360 tons were drawn in fourteen hours from one pit 763 yds. deep.

The tub when brought to the surface, after passing over a weigh-bridge where it is weighed and tallied by a weigher specially appointed for the purpose by the men and the owner jointly, is run into a "tippler," a cage turning about a horizontal axis which discharges the load in the first half of the rotation and brings the tub back to the original position in the second. It is then run back to the pit-bank to be loaded into the cage at the return journey.

Coal as raised from the pit is now generally subjected to some final process of classification and cleaning before being despatched to the consumer. The nature and extent of these operations vary with the character of the coal, which if hard and free from shale partings may be finished by simple screening into large and nut sizes and smaller slack or duff, with a final hand-picking to remove shale and dust from the larger sizes. But when there is much small duff, with intermixed shale, more elaborate sizing and washing plant becomes necessary. Where hand-picking is done, the larger-sized coal, separated by 3-in. bar screens, is spread out on a travelling band, which may be 300 ft. long and from 3 to 5 wide, and carried past a line of pickers stationed along one side, who take out and remove the waste as it passes by, leaving the clean coal on the belt. The smaller duff is separated by vibrating or rotating screens into a great number of sizes, which are cleaned by washing in continuous current or pulsating jiggling machines, where the lighter coal rises to the surface and is removed by a stream of water, while the heavier waste falls and is discharged at a lower level, or through a valve at the bottom of the machine. The larger or "nut" sizes, from ¼ in. upwards, are washed on plain sieve plates, but for finer-grained duff the sieve is covered with a bed of broken felspar lumps about 3 in.

thick, forming a kind of filter, through which the fine dirt passes to the bottom of the hutch. The cleaned coal is carried by a stream of water to a bucket elevator and delivered to the storage bunkers, or both water and coal may be lifted by a centrifugal pump into a large cylindrical tank, where the water drains away, leaving the coal sufficiently dry for use. Modern screening and washing plants, especially when the small coal forms a considerable proportion of the output, are large and costly, requiring machinery of a capacity of 100 to 150 tons per hour, which absorbs 350 to 400 H.P. In this, as in many other cases, electric motors, supplied from a central station are now preferred to separate steam-engines.

Anthracite coal in Pennsylvania is subjected to breaking between toothed rollers and an elaborate system of screening, before it is fit for sale. The largest or lump coal is that which remains upon a riddle having the bars 4 in. apart; the second, or steamboat coal, is above 3 in.; broken coal includes sizes above $2\frac{1}{2}$ or $2\frac{1}{4}$ in.; egg coal, pieces above $2\frac{1}{2}$ in. sq.; large stove coal, $1\frac{1}{2}$ in.; small stove, 1 to $1\frac{1}{2}$ or $1\frac{1}{4}$ in.; chestnut coal, $\frac{3}{4}$ to $\frac{1}{2}$ in.; pea coal, $\frac{1}{2}$ in.; and buckwheat coal, $\frac{1}{2}$ in. The most valuable of these are the egg and stove sizes, which are broken to the proper dimensions for household use, the larger lumps being unfit for burning in open fire-places. In South Wales a somewhat similar treatment is now adopted in the anthracite districts.

With the increased activity of working characteristic of modern coal mining, the depth of the mines has rapidly increased, and at the present time the level of 4000 ft., formerly assumed as the possible limit for working, has been nearly attained. The following list gives the depths reached in the deepest collieries in Europe in 1906, from which it will be seen that the larger number, as well as the deepest, are in Belgium:—

	Metres.	Ft.
Saint Henriette, C ^o des Produits, Flenu, Belgium	1150	3773
Viviers Gilly	1143	3750
Marcinelle, No. 11, Charleroi	1075	3527
Marchienne, No. 2	1065	3494
Agrappe, Mons	1060	3478
Pendleton dip workings	Lancashire 1059	3474
Sacre Madame, Charleroi	Belgium 1055	3461
Ashton Moss dip workings	Lancashire 1024	3360
Ronchamp, No. 11 pit	France 1015	3330
Viernoy, Anderlues	Belgium 1006	3301
Astley Pit, Dukinfield, dip workings	Cheshire 960	3150
Saint André, Poirier, Charleroi	Belgium 950	3117

The greatest depth attained in the Westphalian coal is at East Recklinghausen, where there are two shafts 841 metres (2759 ft.) deep.

The subject of the limiting depth of working has been very fully studied in Belgium by Professor Simon Stassart of Mons ("Les Conditions d'exploitation à grande profondeur en Belgique," *Bulletin de la Société de l'Industrie minière*, 3 ser., vol. xiv.), who finds that no special difficulty has been met with in workings above 1100 metres deep from increased temperature or atmospheric pressure. The extreme temperatures in the working faces at 1150 metres were 79° and 86° F., and the maximum in the end of a drift, 100°; and these were quite bearable on account of the energetic ventilation maintained, and the dryness of the air. The yield per man on the working faces was 4.5 tons, and for the whole of the working force underground, 0.846 tons, which is not less than that realized in shallower mines. From the experience of such workings it is considered that 1500 metres would be a possible workable depth, the rock temperature being 132°, and those of the intake and return galleries, 92° and 105° respectively. Under such conditions work would be practically impossible except with very energetic ventilation and dry air. It would be scarcely possible to circulate more than 120,000 to 150,000 cub. ft. per minute under such conditions, and the number of working places would thus be restricted, and consequently the output reduced to about 500 tons per shift of 10 hours, which could be raised by a single engine at the surface without requiring any very different appliances from those in current use.

In the United Kingdom the ownership of coal, like that of

other minerals, is in the proprietor of the soil, and passes with it, except when specially reserved in the sale. Coal lying under the sea below low-water mark belongs to the crown, and can only be worked upon payment of royalties, even when it is approached from shafts sunk upon land in private ownership. In the Forest of Dean, which is the property of the crown as a royal forest, there are certain curious rights held by a portion of the inhabitants known as the Free Miners of the Forest, who are entitled to mine for coal and iron ore, under leases, known as gales, granted by the principal agent or gaveler representing the crown, in tracts not otherwise occupied. This is the only instance in Great Britain of the custom of free coal-mining under a government grant or concession, which is the rule in almost every country on the continent of Europe.

The working of collieries in the United Kingdom is subject to the provisions of the Coal Mines Regulation Act 1887, as amended by several minor acts, administered by inspectors appointed by the Home Office, and forming a complete disciplinary code in all matters connected with coal-mining. An important act was passed in 1908, limiting the hours of work below ground of miners. For a detailed account of these various acts see the article LABOUR LEGISLATION.

Coal-mining is unfortunately a dangerous occupation, more than a thousand deaths from accident being reported annually by the inspectors of mines as occurring in the collieries of the United Kingdom.

The number of lives lost during the year 1906 was, according to the inspectors' returns:—

From explosions	54
" falls of ground	547
" other underground accidents	328
" accidents in shafts	65
" surface accidents	135

Total . 1129

The principal sources of danger to the collier, as distinguished from other miners, are explosions of fire-damp and falls of roof in getting coal; these together make up about 70% of the whole number of deaths. It will be seen that the former class of accidents, though often attended with great loss of life at one time, are less fatal than the latter.

AUTHORITIES.—The most important new publication on British coal is that of the royal commission on coal supplies appointed in 1901, whose final report was issued in 1905. A convenient digest of the evidence classified according to subjects was published by the *Colliery Guardian* newspaper in three quarto volumes in 1905-1907, and the leading points bearing on the extension and resources of the different districts were incorporated in the fifth edition (1905) of Professor Edward Hull's *Coal Fields of Great Britain*. The Report of the earlier royal commission (1870), however, still remains of great value, and must not be considered to have had its conclusions entirely superseded. In connexion with the re-survey in greater detail of the coalfields by the Geological Survey a series of descriptive memoirs were undertaken, those on the North Staffordshire and Leicestershire fields, and nine parts dealing with that of South Wales, having appeared by the beginning of 1908.

An independent work on the coal resources of Scotland under the title of the *Coalfields of Scotland*, by R. W. Dixon, was published in 1902.

The Rhenish-Westphalian coalfield was fully described in all details, geological, technical and economic, in a work called *Die Entwicklung des niederrheinisch-westfälischen Steinkohlen Bergbaus in der zweiten Hälfte des 19^{ten} Jahrhunderts* (also known by the short title of *Sammelwerk*) in twelve quarto volumes, issued under the auspices of the Westphalian Coal Trade Syndicate (Berlin, 1902-1905).

The coalfields of the Austrian dominions (exclusive of Hungary) are described in *Die Mineralkohlen Oesterreichs*, published at Vienna by the Central Union of Austrian mineowners. It continues the table of former official publications in 1870 and 1878, but in much more detail than its predecessors.

Systematic detailed descriptions of the French coalfields appear from time to time under the title of *Études sur les gîtes minéraux de la France* from the ministry of public works in Paris.

Much important information on American coals will be found in the three volumes of *Reports on the Coal Testing Plant at the St Louis Exhibition*, published by the United States Geological Survey in 1906. A special work on the *Anthracite Coal Industry of the United States*, by P. Roberts, was published in 1901.

The most useful general work on coal mining is the *Text Book of Coal Mining*, by H. W. Hughes, which also contains detailed

Ownership of coal.

Coal Mines Regulation Act.

Accidents.

bibliographical lists for each division of the text. The 5th edition appeared in 1904.

Current progress in mining and other matters connected with coal can best be followed by consulting the abstracts and bibliographical lists of memoirs on these subjects that have appeared in the technical journals of the world contained in the *Journal of the Institute of Mining Engineers* and that of the *Iron and Steel Institute*. The latter appears at half-yearly intervals and includes notices of publications up to about two or three months before the date of its publication.

(H. B.)

COALBROOKDALE, a town and district in the Wellington parliamentary division of Shropshire, England. The town has a station on the Great Western railway, 160 m. N.W. from London. The district or dale is the narrow and picturesque valley of a stream rising near the Wrekin and following a course of some 8 m. in a south-easterly direction to the Severn. Great ironworks occupy it. They were founded in 1709 by Abraham Darby with the assistance of Dutch workmen, and continued by his son and descendants. Father and son had a great share in the discovery and elaboration of the use of pit-coal for making iron, which revolutionized and saved the English iron trade. The father hardly witnessed the benefits of the enterprise, but the son was fully rewarded. It is recorded that he watched the experimental filling of the furnace ceaselessly for six days and nights, and that, just as fatigue was overcoming him, he saw the molten metal issuing, and knew that the experiment had succeeded.

The third Abraham Darby built the famous Coalbrookdale iron bridge over the Severn, which gives name to the neighbouring town of Ironbridge, which with a portion of Coalbrookdale is in the parish of Madeley (q.v.). Fine wrought iron work is produced, and the school of art is well known. There are also brick and tile works.

COAL-FISH (*Gadus virens*), also called green cod, black pollack, saith and sillock, a fish of the family *Gadidae*. It has a very wide range, which nearly coincides with that of the cod, although of a somewhat more southern character, as it extends to both east and west coasts of the North Atlantic, and is occasionally found in the Mediterranean. It is especially common in the north, though rarely entering the Baltic; it becomes rare south of the English Channel. Unlike the cod and haddock, the coal-fish is, to a great extent, a surface-swimming fish, congregating together in large schools, and moving from place to place in search of food; large specimens (3 to 3½ ft. long), however, prefer deep water, down to 70 fathoms. The flesh is not so highly valued as that of the cod and haddock. The lower jaw projects more or less beyond the upper, the mental barble is small, sometimes rudimentary, the vent is below the posterior half of the first dorsal fin, and there is a dark spot in the axil of the pectoral fin.

COALING STATIONS. Maritime war in all ages has required that the ships of the belligerents should have the use of sheltered waters for repairs and for replenishment of supplies. The operations of commerce from the earliest days demanded natural harbours, round which, as in the conspicuous instance of Syracuse, large populations gathered. Such points, where wealth and resources of all kinds accumulated, became objects of attack, and great efforts were expended upon their capture. As maritime operations extended, the importance of a seaboard increased, and the possession of good natural harbours became more and more advantageous. At the same time, the growing size of ships and the complexity of fittings caused by the development of the sailing art imposed new demands upon the equipment of ports alike for purposes of construction and for repairs; while the differentiation between warships and the commercial marine led to the establishment of naval bases and dockyards provided with special resources. From the days when the great sailors of Elizabeth carried war into distant seas, remote harbours began to assume naval importance. Expeditionary forces required temporary bases, such as Guantanamo Bay, in Cuba, which was so utilized by Admiral Vernon in 1741. As outlying territories began to be occupied, and jurisdiction to be exercised over their ports, the harbours available for the free use of a belligerent were gradually reduced in number, and it became occasionally necessary to take them by force. Thus, in 1781, the capture of

Trincomalee was an object of sufficient importance to justify special effort, and Suffren gained a much-needed refuge for his ships, at the same time compelling his opponent to depend upon the open roadstead of Madras, and even to send ships to Bombay. In this case a distant harbour acquired strategic importance, mainly because sheltered waters, in the seas where Hughes and Suffren strove for naval supremacy, were few and far between. A sailing man-of-war usually carried from five to six months' provisions and water for 100 to 120 days. Other needs required to be met, and during the wars of the French Revolution it was usual, when possible, to allow ships engaged in blockade to return to port every five or six weeks "to refresh." For a sailing fleet acting on the offensive, a port from which it could easily get to sea was a great advantage. Thus Raleigh protested against the use of closely landlocked harbours. "Certain it is," he wrote, "that these ships are purposely to serve His Majesty and to defend the kingdom from danger, and not to be so penned up from casualities as that they should be less able or servicable in times of need." Nelson for this reason made great use of Maddalena Bay, in Sardinia, and was not greatly impressed with the strategic value of Malta in spite of its fine natural harbour. The introduction of steam gave rise to a new naval requirement—coal—which soon became vital. Commerce under steam quickly settled down upon fixed routes, and depots of coal were established to meet its needs. Coaling stations thus came into existence by a natural process, arising from the exigencies of trade, and began later to supply the needs of navies.

For many years there was no inquiry into the war requirements of the British fleet as regards coal, and no attempt to regularize or to fortify the ports at which it was stored. Successful naval war had won for Great Britain many points of vantage throughout the world, and in some cases the strategic value of ports had been proved by actual experience. The extreme importance of the Cape of Good Hope, obscured for a time after the opening of the Suez Canal, was fully realized in sailing days, and the naval conditions of those days to some extent determined the choice of islands and harbours for occupation. These does not, however, appear to have been any careful study of relative strategic values. Towns were occasionally drafted by persons whose geographical knowledge was at fault, and positions were, in some cases, abandoned which ought to have been retained, or tentatively held when they might have been abandoned. It was left to the personal exertions of Sir Stamford Raffles to secure such a supremely important roadstead as that of Singapore for the empire. Although, therefore, the relative values of positions was not always recognized, Great Britain obtained as a legacy from sailing days a large number of harbours admirably adapted for use as coaling stations. Since the dawn of the era of steam, she has acquired Aden, Perim, Hong-Kong, North Borneo, Fiji, part of New Guinea, Fanning Island, and many other islands in the Pacific, while the striking development of Australia and New Zealand has added to the long roll of British ports. The coaling stations, actual and potential, of the empire are unrivalled in number, in convenience of geographical distribution, and in resources. Of the numerous British ports abroad which contained coal stores, only the four so-called "fortresses"—Gibraltar, Malta, Halifax and Bermuda—were at first fortified as naval stations after the introduction of rifled ordnance. The term fortress is a misnomer in every case except Gibraltar, which, being a peninsula separated only by a neck of neutral ground from the territory of a foreign power, exists under fortress conditions. Large sums were expended on these places with little regard to principles, and the defences of Bermuda, which were very slowly constructed, are monuments of misapplied ingenuity.

In 1878 great alarm arose from strained relations with Russia. Rumours of the presence of Russian cruisers in many waters, and of hostile projects, were readily believed, although the Russian navy, which had just shown itself unable to face that of Turkey, would at this period have been practically powerless. Widespread fears for the security of coaling stations led to the appointment of a strong

British
coaling
stations.

Caribbean
Gibraltar
Malta.

royal commission, under the presidency of the earl of Carnarvon, which was instructed to inquire into and report upon the protection of British commerce at sea. This was the first attempt to formulate any principles, or to determine which of the many ports where coal was stored should be treated as coaling stations essential for the purposes of war. The terms of the reference to the commission were ill-conceived. The basis of all defence of sea-borne commerce is a mobile navy. It is the movement of commerce upon the sea during war, not its security in port, that is essential to the British empire, and a navy able to protect commerce at sea must evidently protect ports and coaling stations. The first object of inquiry should, therefore, have been to lay down the necessary standard of naval force. The vital question of the navy was not referred to the royal commission, and the four fortresses were also strangely excluded from its purview. It followed inevitably that the protection of commerce was approached at the wrong end, and that the labours of the commission were to a great extent vitiated by the elimination of the principal factor. Voluminous and important evidence, which has not been made public, was, however, accumulated, and the final report was completed in 1881. The commissioners recalled attention to the extreme importance of the Cape route to the East; they carefully examined the main maritime communications of the empire, and the distribution of trade upon each; they selected certain harbours for defence, and they obtained from the War Office and endorsed projects of fortification in every case; lastly, they condemned the great dispersion of troops in the West Indies, which had arisen in days when it was a political object to keep the standing army out of sight of the British people, and had since been maintained by pure inadvertence. Although the principal outcome of the careful inquiries of the commission was to initiate a great system of passive defence, the able reports were a distinct gain. Some principles were at last formulated by authority, and the information collected, if it had been rendered accessible to the public, would have exercised a beneficial influence upon opinion. Moreover, the commissioners, overstepping the bounds of their charter, delivered a wise and statesmanlike warning as to the position of the navy.

Meanwhile, the impulse of the fears of 1878 caused indifferent armaments to be sent to Cape Town, Singapore and Hong-Kong, there to be mounted after much delay in roughly designed works. At the same time, the great colonies of Australasia began to set about the defence of their ports with commendable earnestness. There is no machinery for giving effect to the recommendations of a royal commission, and until 1887, when extracts were laid before the first colonial Conference, the valuable report was veiled in secrecy. After several years, during which Lord Carnarvon persistently endeavoured to direct attention to the coaling stations, the work was begun. In 1885 a fresh panic arose out of the Panjdeh difficulty, which supplied an impetus to the belated proceedings. Little had then been accomplished and the works were scarcely completed before the introduction of long breech-loading guns rendered their armaments obsolete.

The fortification of the coaling stations for the British empire is still proceeding on a scale which, in some cases, cannot easily be reconciled with the principles laid down by the president of the cabinet committee of defence. At the Guildhall, London, on the 3rd of December 1896, the duke of Devonshire stated that "The maintenance of sea supremacy has been assumed as the basis of the system of imperial defence against attack from over the sea. This is the determining factor in fixing the whole defensive policy of the empire." It was, however, he added, necessary to provide against "the predatory raids of cruisers"; but "it is in the highest degree improbable that this raiding attack would be made by more than a few ships, nor could it be of any permanent effect unless troops were landed." This is an unexceptionable statement of the requirements of passive defence in the case of the coaling stations of the British empire. Their protection must depend primarily on the navy. Their immobile armaments are needed to ward off a raiding attack, and a few effective guns, well mounted, manned by well-trained men, and kept in full readiness, will amply suffice.

If the command of the sea is lost, large expeditionary forces can be brought to bear upon coaling stations, and their security will thus depend upon their mobile garrisons, not upon their passive defences. In any case, where coal is stored on shore, it cannot be destroyed by the fire of a ship, and it can only be appropriated by landing men. A small force, well armed and well handled, can effectually prevent a raid of this nature without any assistance from heavy guns. In war, the possession of secure coal stores in distant ports may be a great advantage, but it will rarely suffice for the needs of a fleet engaged in offensive operations, and requiring to be accompanied or met at prearranged rendezvous by colliers from which coal can be transferred in any sheltered waters. In the British naval manœuvres of 1892, Admiral Sir Michael Seymour succeeded in coaling his squadron at sea, and by the aid of mechanical appli-
Modern conditions.

ances this is frequently possible. In the Spanish-American War of 1898 some coaling was thus accomplished; but Guantanamo Bay served the purpose of a coaling station during the operations against Santiago. Watering at sea was usually carried out by means of casks in sailing days, and must have been almost as difficult as coaling. As, however, it is certainty of coaling in a given time that is of primary importance, the utilization of sheltered waters as improvised coaling stations is sure to be a marked feature of future naval wars. Although coaling stations are now eagerly sought for by all powers which cherish naval ambitions, the annexation of the Hawaiian Islands by the United States being a case in point, it is probable that they will play a somewhat less important part than has been assumed. A fleet which is able to assert and to maintain the command of the sea, will not find great difficulty in its coal supply. Moreover, the increased coal endurance of ships of war tends to make their necessary replenishment less frequent. On the other hand, the modern warship, being entirely dependent upon a mass of complex machinery, requires the assistance of workshops to maintain her continuous efficiency, and unless docked at intervals suffers a material reduction of speed. Prolonged operations in waters far distant from home bases will therefore be greatly facilitated in the case of the Power which possesses local docks and means of executing repairs. Injuries received in action, which might otherwise disable a ship during a campaign, may thus be remedied. During the hostilities between France and China in 1884, the French ship "La Galissonnière" was struck by a shell from one of the
Secondary bases.

Min forts, which, though failing to burst, inflicted serious damage. As, by a technical fiction, a state of war was not considered to exist, the "La Galissonnière" was repaired at Hong-Kong and enabled again to take the sea. Local stores of reserve ammunition and of spare armaments confer evident advantages. Thus, independently of the question of coal supply, modern fleets employed at great distances from their bases require the assistance of ports furnished with special resources, and a power like Japan with well-equipped naval bases in the China Sea, and possessing large sources of coal, occupies, for that reason, a favoured position in regard to naval operations in the Far East. As the term "coaling station" refers only to a naval need which can often be satisfied without a visit to any port, it appears less suitable to modern conditions than "secondary base." Secondary bases, or coaling stations, when associated with a powerful mobile navy, are sources of maritime strength in proportion to the services they can render, and to their convenience of geographical position. In the hands of an inferior naval power, they may be used, as was Mauritius in 1809-1810, as points from which to carry on operations against commerce; but unless situated near to trade routes, which must be followed in war, they are probably less useful for this purpose than in sailing days, since convoys can now be more effectively protected, and steamers have considerable latitude of courses. Isolated ports dependent on sea-borne resources, and without strong bodies of organized fighting men at their backs are now, as always, hostages offered to the power which obtains command of the sea. (G. S. C.)

COALITION (Lat. *coalitio*, the verbal substantive of *coalescere*, to grow together), a combination of bodies or parts into one

body or whole. The word is used, especially in a political sense, of an alliance or temporary union for joint action of various powers or states, such as the coalition of the European powers against France, during the wars of the French Revolution; and also of the union in a single government of distinct parties or members of distinct parties. Of the various coalition ministries in English history, those of Fox and North in 1782, of the Whigs and the Peelites, under Lord Aberdeen in 1852-1853, and of the Liberal Unionists and Conservatives in Lord Salisbury's third ministry in 1895, may be instanced.

COAL-TAR, the black, viscous, sometimes semi-solid, fluid of peculiar smell, which is condensed together with aqueous "gas liquor" when the volatile products of the destructive distillation of coal are cooled down. It is also called "gas-tar," because it was formerly exclusively, and even now is mostly, obtained as a by-product in the manufacture of coal-gas, but the tar obtained from the modern coke-ovens, although not entirely identical with gas-tar, resembles it to such an extent that it is worked up with the latter, without making any distinction in practice between the two kinds. Some descriptions of gas-tar indeed differ very much more than coke-oven tar from pure coal-tar, viz. those which are formed when bituminous shale or other materials, considerably deviating in their nature from coal, are mixed with the latter for the purpose of obtaining gas of higher illuminating power.

It may be generally said that for the purpose of tar-distillers the tar is all the more valuable the less other materials than real coal have been used by the gas-maker. All these materials—bog-head shale, bituminous lignite and so forth—by destructive distillation yield more or less paraffinoid oils, which render the purification of the benzols very difficult and sometimes nearly impossible for the purposes of the manufacturer of coal-tar colours.

Neither too high nor too low a temperature should have been observed in gas-making in order to obtain a good quality of tar. Since in recent times most gas retorts have been provided with heating arrangements based on the production of gaseous fuel from coke, which produce higher temperatures than direct firing and have proved a great economy in the process of gas-making itself, the tar has become of decidedly inferior quality for the purposes of the tar-distillers, and in particular yields much less benzol than formerly.

Entirely different from gas-tar is the tar obtained as a by-product from those (Scottish) blast furnaces which are worked with splint-coal. This tar contains very little aromatic hydrocarbons, and the phenols are of quite a different character from those obtained in the working of gas-tar. The same holds good of oil-gas tars and similar substances. These should not be worked up like gas-tars.

The ordinary yield of tar in the manufacture of coal-gas is between 4 and 5% of the weight of the coal. Rather more is obtained when passing the gas through the apparatus of E. Pelouze and P. Audouin, where it is exposed to several shocks against solid surfaces, or by carrying on the process at the lowest possible temperature, as proposed by H. J. Davis, but this "carbonizing process" can only pay under special circumstances, and is probably no longer in practical use.

All coal-tars have a specific gravity above that of water, in most cases between 1.12 and 1.20, but exceptionally up to 1.25. The heavier tars contain less benzol than the lighter tars, and more "fixed carbon," which remains behind when the tars are exhausted of benzol and is a decidedly objectionable constituent. All tars also mechanically retain a certain quantity of water (or rather gas-liquor), say, 4% on the average, which is very obnoxious during the process of distillation, as it leads to "bumping," and therefore ought to be previously removed by prolonged settling, preferably at a slightly elevated temperature, which makes the tar more fluid. The water then rises to the top, and is removed in the ordinary way or by special "separators."

The tar itself is a mixture of exceedingly complex character. The great bulk of its constituents belongs to the class of "aromatic" hydrocarbons, of very different composition and degrees

of volatility, beginning with the simplest and most volatile, benzene (C_6H_6), and ending with an entirely indistinguishable mass of non-volatile bodies, which compose the pitch left behind in the tar-stills. The hydrocarbons mostly belong to the benzene series C_nH_{2n-6} , the naphthalene series C_nH_{2n-12} , and the anthracene and phenanthrene series C_nH_{2n-18} . Small quantities of "fatty" ("aliphatic") hydrocarbons are never absent, even in pure tars, and are found in considerable quantities when shales and similar matters have been mixed with the coal in the gas-retorts. They belong mostly to the paraffins C_nH_{2n+2} , and the olefines C_nH_{2n} . The "asphalt" or soluble part of the pitch is also a mixture of hydrocarbons, of the formula C_nH_{2n} ; even the "carbon," left behind after treating the pitch with all possible solvents is never pure carbon, but contains a certain quantity of hydrogen, although less than any of the volatile and soluble constituents of the tar.

Besides the hydrocarbons, coal-tar contains about 2% of the simpler phenols $C_nH_{2n-7}OH$, the best known and most valuable of which is the first of the series, carbolic acid (*q.v.*) C_6H_5OH , besides another interesting oxygenized substance, cumarone C_8H_6O . The phenols, especially the carbolic acid, are among the more valuable constituents of coal-tar. Numerous sulphur compounds also occur in coal-tar, some of which impart to it their peculiar nauseous smell, but they are of no technical importance or value.

Still more numerous are the nitrogenated compounds contained in coal-tar. Most of these are of a basic character, and belong to the pyridine and the quinoline series. Among these we find a somewhat considerable quantity of aniline, which, however, is never obtained from the tar for commercial purposes, as its isolation in the pure state is too difficult. The pyridines are now mostly recovered from coal-tar, but only in the shape of a mixture of all members of the series which is principally employed for denaturing alcohol. Some of these nitrogenated compounds possess considerable antiseptic properties, but on the whole they are only considered as a contamination of the tar-oils.

Applications of Coal-Tar in the Crude State.—Large quantities of coal-tar are employed for various purposes without submitting it to the process of distillation. It is mostly advisable to dehydrate the tar as much as possible for any one of its applications, and in some cases it is previously boiled in order to remove its more volatile constituents.

No preparation whatever is needed if the tar is to be used as fuel, either for heating the gas-retorts or for other purposes. Its heating-value is equal to the same weight of best coal, but it is very difficult to burn it completely without producing a great deal of evil-smelling smoke. This drawback has been overcome by employing the same means as have been found suitable for the combustion of the heavy petroleum residues, called "masut," viz. converting the tar into a fine spray by means of steam or compressed air. When the gas-maker cannot conveniently or profitably dispose of his tar for other purposes, he burns it by the above means under his retorts.

Several processes have also been patented for producing illuminating gas from tar, the most notable of which is the Dinsmore process. This process has been adversely criticized by very competent gas-makers, and no great success can be expected in this line.

Coal-tar is very much employed for painting wood, iron, brick-work, or stone, as a preventive against the influence of weather or the far more potent action of corrosive chemicals. This, of course, can be done only where appearance is no object, for instance in chemical works, where all kinds of erections and apparatus are protected by this cheap kind of paint. Coal-tar should not be used for tarring the woodwork and ropes of ships, a purpose for which only wood-tar has been found suitable.

One of the most considerable outlets for crude tar is in the manufacture of roofing-felt. This industry was introduced in Germany upwards of a hundred years ago, even before coal-tar was available, and has reached a very large extension both in that country and in the United States, where most of the gas-tar seems to be devoted to this purpose. In the United Kingdom

it is much less extensive. For this manufacture a special fabric is made from pure woollen fibre, on rolls of about 3 ft. width and of considerable length. The tar must be previously dehydrated, and is preferably deprived of its more volatile portions by heating in a still. It is heated in an iron pan to about 90° or 100° C.; the fabric is drawn through it by means of rollers which at the same time squeeze out the excess of tar; on coming out of these, the tarred felt is covered with a layer of sand on both sides by means of a self-acting apparatus; and is ultimately wound round wooden rolls, in which state it is sent out into the trade. This roofing-felt is used as a cheap covering, both by itself and as a grounding for tiles or slates. In the former case it must be kept in repair by repainting with tar from time to time, a top covering of sand or small gravel being put on after every coat of paint.

Coal-tar is also employed for the manufacture of lamp-black. This is done by burning the tar in ovens, connected with brick-chambers in which the large quantity of soot, formed in this process, deposits before the gases escape through the chimney. Numerous patents have been taken out for more efficiently collecting this soot. Most of it is employed without further manipulation for the manufacture of electric carbons, printing inks, shoe-blackening, patent leather and so forth. A finer quality of lamp-black, free from oily and empyreumatic parts, is obtained by calcining the soot in closed iron pots at a red heat.

Distillation of Coal-Tar.—Much more important than all applications of crude coal-tar is the industry of separating its constituents from it in a more or less pure form by fractional distillation, mostly followed by purifying processes. Most naturally this industry took its rise in Great Britain, where coal-gas was invented and made on a large scale before any other nation took it up, and up to this day both the manufacture of coal-gas and the distillation of the tar, obtained as a by-product thereof, are carried out on a much larger scale in that than in any other country. The first attempts in this line were made in 1815 by F. C. Accum, and in 1822 by Dr G. D. Longstaff and Dr Dalston. At first the aim was simply to obtain "naphtha," used in the manufacture of india-rubber goods, for burning in open lamps and for some descriptions of varnish; the great bulk of the tar remained behind and was used as fuel or burned for the purpose of obtaining lamp-black.

It is not quite certain who first discovered in the coal-naphtha the presence of benzene (*q.v.*), which had been isolated from oil-gas by M. Faraday as far back as 1825. John Leigh claims to have shown coal-tar benzene and nitro-benzene made from it at the British Association meeting held at Manchester in 1842, but the report of the meeting says nothing about it, and the world in general learned the presence of benzene in coal-tar only from the independent discovery of A. W. Hofmann, published in 1845. And it was most assuredly in Hofmann's London laboratory that Charles Mansfield worked out that method of fractional distillation of the coal-tar and of isolating the single hydrocarbons which laid the foundation of that industry. His patent, numbered 11,960 and dated November 11th, 1847, is the classical land-mark of it. About the same time, in 1846, Brønner, at Frankfort, brought his "grease-remover" into the trade, which consisted of the most volatile coal-tar oils, of course not separated into the pure hydrocarbons; he also sold water-white "creosote" and heavy tar-oils for pickling railway timbers, and used the remainder of the tar for the manufacture of roofing-felt. The employment of heavy oils for pickling timber had already been patented in 1838 by John Bethell, and from this time onward the distillation of coal-tar seems to have been developed in Great Britain on a larger scale, but the utilization of the light oils in the present manner naturally took place only after Sir W. H. Perkin, in 1856, discovered the first aniline colour which suddenly created a demand for benzene and its homologues. The isolation of carbolic acid from the heavier oils followed soon after; that of naphthalene, which takes place almost automatically, went on simultaneously, although the uses of this hydrocarbon for a long time remained much behind the quantities which are producible from coal-tar, until the

manufacture of synthetic indigo opened out a wide field for it. The last of the great discoveries in that line was the preparation of alizarine from anthracene by C. Graebe and C. T. Liebermann, in 1868, soon followed by patents for its practical manufacture by Sir W. H. Perkin in England, and by Graebe, Liebermann and H. Caro in Germany.

The present extension of the industry of coal-tar distilling can be only very roughly estimated from the quantity of coal-tar produced in various countries. Decidedly at the head is Great Britain, where about 700,000 tons are produced per annum, most of which probably finds its way into the tar-distilleries, whilst in Germany and the United States much less gas-tar is produced and a very large proportion of it is used for roofing-felt and other purposes.

We shall now give an outline of the processes used in the distillation of tar.

Dehydration.—The first operation in coal-tar distilling is the removal of the mechanically enclosed water. Some water is chemically combined with the bases, phenols, &c., and this, of course, cannot be removed by mechanical means, but splits off only during the distillation itself, when a certain temperature has been reached. The water mechanically present in the tar is separated by long repose in large reservoirs. Very thick viscous tars are best mixed with thinner tars, and the whole is gently heated by coils of pipes through which the heated water from the oil-condensers is made to flow. Sometimes special "tar-separators" are employed; working on the centrifugal principle. The water rises to the top and is worked up like ordinary gas-liquor. More water is again separated during the heating-up of the tar in the still itself, and can be removed there by a special overflow.

Tar-Stills.—The tar is now pumped into the tar-still, fig. 1. This is usually, as shown, an upright wrought-iron cylinder, with an arched top, and with a bottom equally vaulted upwards for the purpose of increasing the heating surface and of raising the level of the pitch remaining at the end of the operation above the fire-flues. The fuel is consumed on the fire-grate *a*, and, after having

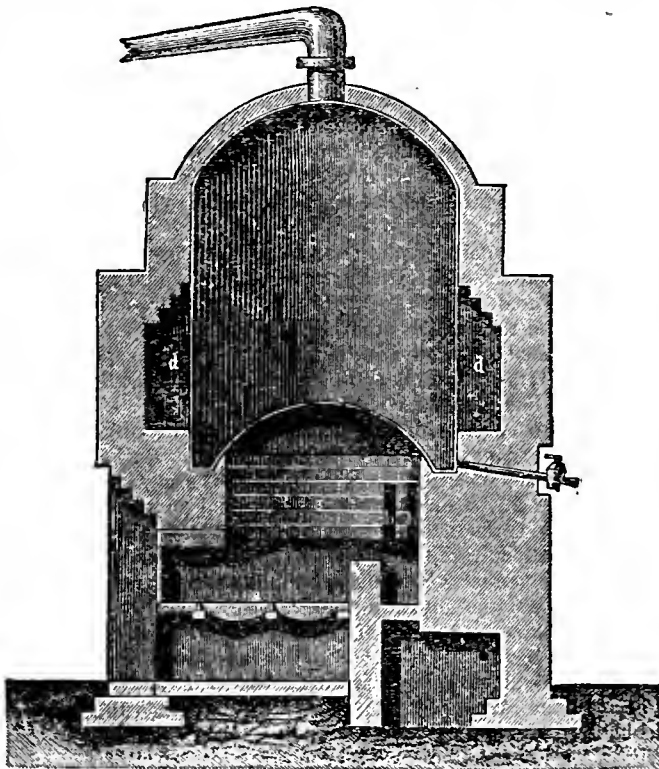

FIG. 1.—Tar-Still (sectional elevation).¹

traversed the holes *bb* in the annular wall *e* built below the still, the furnace gases are led around the still by means of the flue *d*, whence they pass to the chimney. Cast-iron necks are provided in the top for the outlet of the vapours, for a man-hole, supply-pipe, thermometer-pipe, safety valve, and for air and steam-pipes reaching down to the bottom and branching out into a number of distributing

¹ The illustrations in this article are from Prof. C. Lunge's *Coal Tar and Ammonia*, by permission of Friedrich Vieweg u. Sohn.

arms. Near the top there is an overflow pipe which comes into action on filling the still. In the lowest part of the bottom there is a running-off valve or tap. In some cases (but only exceptionally) a perpendicular shaft is provided, with horizontal arms, and chains hanging down from these drag along the bottom for the purpose of keeping it clean and of facilitating the escape of the vapours. This arrangement is quite unnecessary where the removal of the vapours is promoted by the injection of steam, but this steam must be carefully dried beforehand, or, better, slightly superheated, in order to prevent explosions, which might be caused by the entry of liquid water into the tar during the later stages of the work, when the temperature has arisen far above the boiling-point of water. The steam acts both by stirring up the tar and by rapidly carrying off the vapours formed in distillation. The latter object is even more thoroughly attained by the application of a vacuum, especially during the later stage of distillation. For this purpose the receivers, in which the liquids condensed in the cooler are collected, are connected with an air pump or an ejector, by which a vacuum of about $\frac{1}{4}$ in., say $\frac{1}{2}$ atmosphere, is made which lowers the boiling process by about 80° C.; this not merely hastens the process, but also produces an improvement of the quality and yield of the products, especially of the anthracene, and, moreover, lessens or altogether prevents the formation of coke on the still-bottom, which is otherwise very troublesome.

Most manufacturers employ ordinary stills as described. A few of them have introduced continuously acting stills, of which that constructed by Frederic Lennard has probably found a wider application than any of the others. They all work on the principle of gradually heating the tar in several compartments, following one after the other. The fresh tar is run in at one end and the pitch is run out from the other. The vapours formed in the various compartments are separately carried away and condensed, yielding at one and the same time those products which are obtained in the ordinary stills at the different periods of the distillation. Although in theory this continuous process has great advantages over the ordinary style of working, the complication of the apparatus and practical difficulties arising in the manipulation have deterred most manufacturers from introducing it.

The tar-stills are set in brickwork in such a manner that there is no over-heating of their contents. For this purpose the fire-grate is placed at a good distance from the bottom or even covered by a brick arch so that the flame does not touch the still-bottom at all and acts only indirectly, but the sides of the still are always directly heated. The fire-flue must not be carried up to a greater height than is necessary to provide against the overheating of any part of the still not protected inside by liquid tar, or, at the end of the operation, by liquid pitch. The outlet pipe is equally protected against overheating and also against any stoppage by pitch solidifying therein. The capacity of tar-stills ranges from 5 to 50 tons. They hold usually about 10 tons, in which case they can be worked off during one day.

The vapours coming from the still are condensed in coolers of various shapes, one of which is shown in figs. 2 and 3. The cooling-pipes are best made of cast-iron, say 4 in. wide inside and laid so as to have a continuous fall towards the bottom. A steam-pipe (b) is provided for heating the cooling water, which is necessary during the later part of the operation to prevent the stopping up of the pipes by the solidification of the distillates. A cock (a) allows

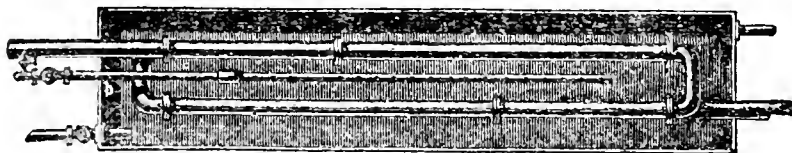

FIG. 2.—Condensing Worm (Plan).

steam to be injected into the condensing worm in order to clear any obstruction.

The cooling-pipe is at its lower end connected with receivers for the various distillates in such a manner that by the turning of a cock the flow of the distillates into the receivers can be changed at will. In a suitable place provision is made for watching the colour, the specific gravity, and the general appearance of the distillates. At the end of the train of apparatus, and behind the vacuum pump or ejector, when one is provided, there is sometimes a purifier for the gases which remain after condensation; or these gases are carried back into the fire, in which case a water-trap must be interposed to prevent explosions.

Distillation of the Tar.—The number of fractions taken during the distillation varies from four to six. Sometimes a first fraction is taken as "first runnings," up to a temperature of 105° C. in the still,

and a second fraction as "light oil," up to 210° C., but more usually these two are not separated in the first distillation, and the first or "light oil" fraction then embraces everything which comes over until the drops no longer float on, but show the same specific gravity as water. The specific gravity of this fraction varies from 0.91 to 0.94. The next fraction is the "middle oil" or "carbolic oil," of specific gravity 1.01, boiling up to 240° C.; it contains most of the carbolic acid and naphthalene. The next fraction is the "heavy oil" or "creosote oil," of specific gravity 1.04. Where the nature of the coals distilled for gas is such that the tar contains too little anthracene to be economically recovered, the creosote-oil fraction is carried right to the end; but otherwise, that is in most cases, a last fraction

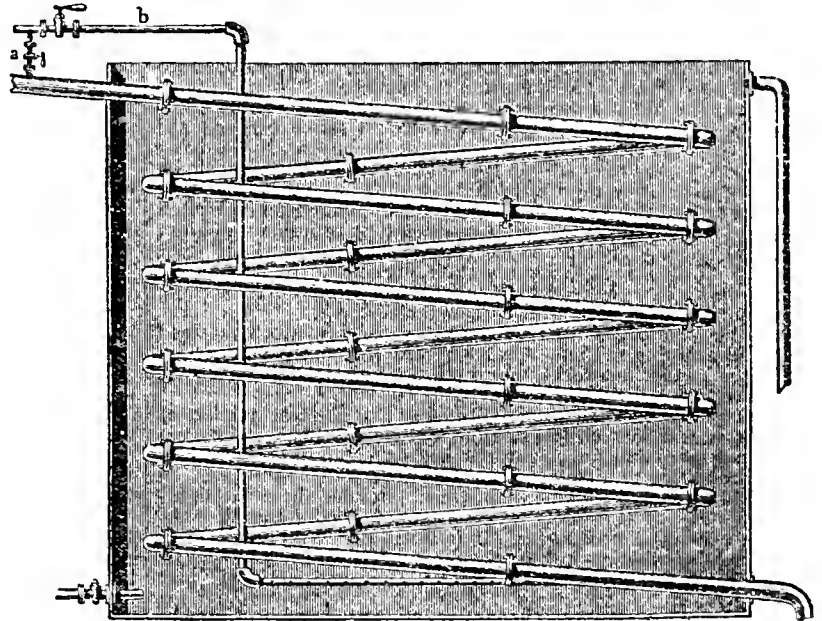

FIG. 3.—Condensing Worm (side elevation).

is made at about the temperature 270° C., above which the "anthracene oil" or "green oil" is obtained up to the finish of the distillation.

During the light-oil period the firing must be performed very cautiously, especially where the water has not been well removed, to prevent bumping and boiling over. It has been observed that, apart from the water, those tars incline most to boiling over which contain an unusual quantity of "fixed carbon." During this period cold water must be kept running through the cooler. The distillate at once separates into water (gas-liquor) and light oil, floating at the top. Towards the end of this fraction the distillation seems to cease, in spite of increasing the fires, and a rattling noise is heard in the still. This is caused by the combined water splitting off from the bases and phenols and causing slight explosions in the tar.

As soon as the specific gravity approaches 1.0, the supply of cold water to the cooler is at least partly cut off, so that the temperature of the water rises up to 40° C. This is necessary because otherwise some naphthalene would crystallize out and plug up the pipes. If a little steam is injected into the still during this period no stoppage of the pipes need be feared in any case, but this must be done cautiously.

When the carbolic oil has passed over and the temperature in the still has risen to about 240° C., the distillate can be run freely by always keeping the temperature in the cooler at least up to 40° C. The "creosote oil" which now comes over often separates a good deal of solid naphthalene on cooling.

The last fraction is made, either when the thermometer indicates 270° C., or when "green grease" appears in the distillate, or simply by judging from the quantity of the distillate. What comes over now is the "anthracene oil." The firing may cease towards the end as the steam (with the vacuum) will finish the work by itself. The water in the cooler should now approach the boiling-point.

The point of finishing the distillation is different in various places and for various objects. It depends upon the fact whether *soft* or *hard* pitch is wanted. The latter must be made where it has to be sold at a distance, as soft pitch cannot be easily carried during the warmer season in railway trucks and not at all in ships, where it would run into a single lump. Hard pitch is also always made where as much anthracene as possible is to be obtained. For hard pitch the distillation is carried on as far as practicable without causing the residue in the still to "coke." The end cannot be judged by the thermometer, but by the appearance and quantity of the distillate

and its specific gravity. If carried too far, not merely is coke formed, but the pitch is porous and almost useless, and the anthracene oil is contaminated with high-boiling hydrocarbons which may render it almost worthless as well. Hard pitch proper should soften at 100° C., or little above.

Where the distillation is to stop at soft pitch it is, of course, not carried up to the same point, but wherever the pitch can be disposed of during the colder season or without a long carriage, even the hard pitch is preferably softened within the still by pumping back a sufficient quantity of heavy oil, previously deprived of anthracene. This makes it much easier to discharge the still. When the contents consist of soft pitch they are run off without much trouble, but hard pitch not merely emits extremely pungent vapours, but is mostly at so high a temperature that it takes fire in the air. Hard pitch must, therefore, always be run into an iron or brick cooler where it cools down out of contact with air, until it can be drawn out into the open pots where its solidification is completed.

Most of the pitch is used for the manufacture of "briquettes" ("patent fuel"), for which purpose it should soften between 55° and 80° C. according to the requirements of the buyer. In Germany upwards of 50,000 tons are used annually in that industry; much of it is imported from the United Kingdom, whence also France and Belgium are provided. Apart from the softening point the pitch is all the more valued the more constituents it contains which are soluble in xylene. The portion insoluble in this is denoted as "fixed carbon." If the briquette manufacturer has bought the pitch in the hard state he must himself bring it down to the proper softening point by re-melting it with heavy coal-tar oils.

We now come to the treatment of the various fractions obtained from the tar-stills. These operations are frequently not carried out at the smaller tar-works, which sell their oils in the crude state to the larger tar-distillers.

Working up of the Light-Oil Fraction.—The greatest portion of the light-oil fraction consists of aromatic hydrocarbons, about one-fifth being naphthalene, four-fifths benzene and its homologues, in the proportion of about 100 benzene, 30 toluene, 15 xylenes, 10 trimethylbenzenes, 1 tetramethylbenzene. Besides these the light-oil contains 5-15% phenols, 1-3% bases, 0.1 sulphuretted compounds, 0.2-0.3% nitriles, &c. It is usually first submitted to a preliminary distillation in directly fired stills, similar to the tar-stills, but with a dephlegmating head. Here we obtain (1) first runnings (up to 0.89 spec. grav.), (2) heavy benzols (up to 0.95), (3) carbolic oil (up to 1.00). The residue remaining in the still (chiefly naphthalene) goes to the middle-oil fraction.

The "first runnings" are now "washed" in various ways, of which we shall describe one of the best. The oil is mixed with dilute caustic soda solution, and the solution of phenols thus obtained is worked up with that obtained from the next fractions. After this follows a treatment with dilute sulphuric acid (spec. grav. 1.3), to extract the pyridine bases, and lastly with concentrated sulphuric acid (1.84), which removes some of the aliphatic hydrocarbons and "unsaturated" compounds. After this the crude benzol is thoroughly washed with water and dilute caustic soda solution, until its reaction is neutral. The mixing of the basic, acid and aqueous washing-liquids with the oils is performed by compressed air, or more suitably by mechanical stirrers, arranged on a perpendicular, or better, a horizontal shaft. Precisely the same treatment takes place with the next fraction, the "heavy benzols," and the oils left behind after the washing operations now go to the steam-stills. The heaviest hydrocarbons are sometimes twice subjected to the operation of washing.

The washed crude benzols are now further fractionated by distillation with steam. The *steam-stills* are in nearly all details on the principle of the "column apparatus" employed in the distillation of alcoholic liquids, as represented in fig. 4. They are usually made of cast iron. The still itself is either an upright or a horizontal cylinder, heated by a steam-coil, of a capacity of from 1000 to 2000 gallons. The superposed columns contain from 20 to 50 compartments of a width of 2½ or 3 ft. The vapours pass into a cooler, and from this the distillate runs through an apparatus, where the liquor can be seen and tested, into the receivers. The latter are so arranged that the water passing over at the same time is automatically removed. This is especially necessary, because the last fraction is distilled by means of pure steam.

The fractions made in the steam distillation vary at different works. In some places the pure hydrocarbons are not extracted and here only the articles called: "90 per cent. benzol," "50 per cent. benzol," "solvent naphtha," "burning naphtha" are made, or any other commercial articles as they are ordered. The expression "per cent." in this case does not signify the percentage of real benzene, but that portion which distils over up to the temperature of 100° C., when a certain quantity of the article is heated in glass retorts of a definite shape, with the thermometer inserted in the liquid itself. By the application of well-constructed rectifying-columns and with proper care it is, however, possible to obtain in this operation nearly pure benzene, toluene, xylene, and cumene (in the two last cases a mixture of the various isomeric hydrocarbons). These hydrocarbons contain only a slight proportion of thiophene and its isomers, which can be removed only by a treatment with fuming sulphuric acid, but this is only exceptionally done.

Sometimes the *pyridine bases* are recovered from the tarry acid which is obtained in the treatment of the light oil with sulphuric acid, and which contains from 10 to 30% of bases, chiefly pyridine and its homologues with a little aniline, together with resinous substances. The latter are best removed by a partial precipitation with ammonia, either in the shape of gas or of concentrated ammoniacal liquor. This reagent is added until the acid reaction has just disappeared and a faint smell of pyridine is perceived. The mixture is allowed to settle, and it then separates into two layers. The upper layer, containing the impurities, is run off; the lower layer, containing the sulphates of ammonia and of the pyridine bases, is treated with ammonia in excess, where it separates into a lower aqueous layer of ammonium sulphate solution and an oil, consisting of crude pyridine. This is purified by fractionation in iron stills and distillation over caustic soda. Most of it is used for denaturing spirit of wine in Germany, for which purpose it is required to contain 90% of bases boiling up to 140° C. (see ALCOHOL).

Working up of the Middle-Oil Fraction (Carbolic Oil Fraction).—Owing to its great percentage of naphthalene (about 40%) this fraction is solid or semi-solid at ordinary temperatures. Its specific gravity is about 1.2; its colour may vary from light yellow to dark brown or black. In the latter case it must be re-distilled before further treatment. On cooling down, about four-fifths of the naphthalene crystallizes out on standing from three to ten days. The crystals are freed from the mother oils by draining and cold or hot pressing; they are then washed at 100° C. with concentrated sulphuric acid, afterwards with water and re-distilled or sublimed. About 10,000 tons of naphthalene are used annually in Germany, mostly for the manufacture of many azo-colours and of synthetic indigo.

The oils drained from the crude naphthalene are re-distilled and worked for carbolic acid and its isomers. For this purpose the oil is washed with a solution of caustic soda, of specific gravity 1.1; the solution thus obtained is treated with sulphuric acid or with carbon dioxide, and the crude phenols now separated are fractionated in a similar manner as is done in the case of crude benzol. The pure phenol crystallizes out and is again distilled in iron stills with a silver head and cooling worm; the remaining oils, consisting mainly of cresols, are sold as "liquid carbolic acid" or under other names.

Most of the oil which passes as the "creosote-oil fraction" is sold in the crude state for the purpose of pickling timber. It is at the ordinary temperature a semi-solid mixture of about 20% crystallized hydrocarbons (chiefly naphthalene), and 80% of a dark brown, nauseous smelling oil, of 1.04 spec. grav., and boiling between 200° and 300° C. The liquid portion contains phenols, bases, and a great number of hydrocarbons. Sometimes it is redistilled, when most of the naphthalene passes over in the first fraction, between 180° and 230° C., and crystallizes out in a nearly pure state. The oily portion remaining behind, about 60% of this distillate, contains about 30% phenols and 3% bases. It has highly disinfectant properties and is frequently converted into special disinfectants, e.g. by mixing it with four times its volume of slaked lime, which yields "disinfectant powder" for stables, railway cars, &c. Mixtures

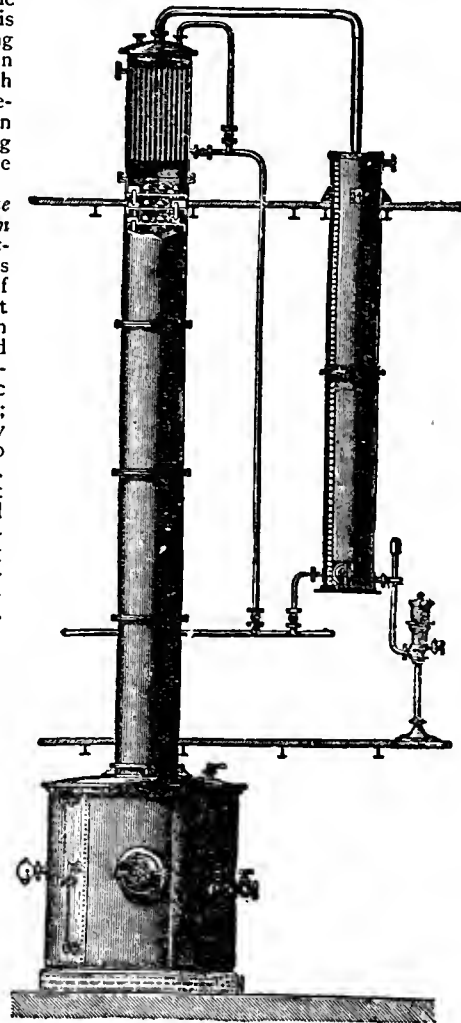

FIG. 4.—Benzol Still (elevation),

of potash soaps (soft soaps) with this oil have the property of yielding with water emulsions which do not settle for a long time and are found in the trade as "creolin," "sapocarbol," "lysol," &c.

That description of creosote oil which is sold for the purpose of picking railway sleepers, telegraph posts, timber for the erection of wharves and so forth, must satisfy special requirements which are laid down in the specifications for tenders to public bodies. These vary to a considerable extent. They always stipulate (1) a certain specific gravity (e.g. not below 1.035 and not above 1.065); (2) certain limits of boiling points (e.g. to yield at most 3% up to 150°, at most 30% between 150° and 255°, and at least 85% between 150° and 355°); (3) a certain percentage of phenols, as shown by extraction with caustic soda solution, say 8 to 10%.

Much of this creosote oil is obtained by mixing that which has resulted in the direct distillation of the tar with the liquid portion of the anthracene oils after separating the crude anthracene (see below). It is frequently stipulated that the oil should remain clear at the ordinary temperature, say 15° C., which means that no naphthalene should crystallize out.

Working up the Anthracene Oil Fraction.—The crude oil boils between 280° and 400° C. It is liquid at 60° C., but on cooling about 6 to 10% of crude anthracene separates as greenish-yellow, sandy crystals, containing about 30% of real anthracene, together with a large percentage of carbazol and phenanthrene. This crystallization takes about a week. The crude anthracene is separated from the mother oils by filter presses, followed by centrifugals or by hot hydraulic presses. The liquid oils are redistilled, in order to obtain more anthracene, and the last oils go back to the creosote oil, or are employed for softening the hard pitch (*vide supra*). The crude anthracene is brought up to 50 or 60, sometimes to 80%, by washing with solvent naphtha, or more efficiently with the higher boiling portion of the pyridine bases. The naphtha removes mostly only the phenanthrene, but the carbazol can be removed only by pyridine, or by subliming or distilling the anthracene over caustic potash. The whole of the anthracene is sold for the manufacture of artificial alizarine.

BIBLIOGRAPHY.—The principal work on Coal-tar is G. Lunge's *Coal-tar and Ammonia* (3rd ed., 1900). Consult also G. P. Sadtler, *Handbook of Industrial Organic Chemistry* (1891), and the article "Steinkohlentheer," Kraemer and Spreker, in *Encyklopädisches Handbuch der technischen Chemie* (4th ed., 1905, viii. 1). (G. L.)

COALVILLE, a town in the Loughborough parliamentary division of Leicestershire, England, 112 m. N.N.W. from London. Pop. of urban district (1901) 15,281. It is served by the Midland railway, and there is also a station (Coalville East) on the Nuneaton-Loughborough branch of the London & North-Western railway. This is a town of modern growth, a centre of the coal-mining district of north Leicestershire. There are also iron foundries and brick-works. A mile north of Coalville is Whitwick, with remains of a castle of Norman date, while to the north again are slight remains of the nunnery of Gracedieu, founded in 1240, where, after its dissolution, Francis Beaumont, the poet-colleague of John Fletcher, was born about 1586. In the neighbourhood is the Trappist abbey of Mount St Bernard, founded in 1835, possessing a large domain, with buildings completed from the designs of A. W. Pugin in 1844.

COAST (from Lat. *costa*, a rib, side), the part of the land which meets the sea in a line of more or less regular form. The word is sometimes applied to the bank of a river or lake, and sometimes to a region (cf. Gold Coast, Coromandel Coast) which may include the hinterland. If the coast-line runs parallel to a mountain range, such as the Andes, it has usually a more regular form than when, as in the *rias* coast of west Brittany, it crosses the crustal folds. Again, a recently elevated coast is more regular than one that has been long exposed to wave action. A recently depressed coast will show the irregularities that were impressed upon the surface before submergence. Wave erosion and the action of marine currents are the chief agents in coast sculpture. A coast of homogeneous rock exposed to similar action will present a regular outline, but if exposed to differential action it will be embayed where that action is greatest. A coast consisting of rocks of unequal hardness or of unequal structure will present headlands, "stacks" and "needles" of hard rocks, and bays of softer or more loosely aggregated rocks, when the wave and current action is similar throughout. The southern shore-line of the Isle of Wight and the western coast of Wales are simple examples of this differential resistance. In time the coast becomes "mature" and its outline undergoes little change as it gradually recedes, for the hard rock being now more exposed is worn away faster, but the softer rock more slowly because it is protected in the bays and re-entrants.

COAST DEFENCE, a general term for the military and naval protection and defence of a coast-line, harbours, dockyards, coaling-stations, &c., against serious attack by a strong naval force of the enemy, bombardment, torpedo boat or destroyer raids, hostile landing parties, or invasion by a large or small army. The principal means employed by the defender to cope with these and other forms of attack which may be expected in time of war or political crisis are described below. See also for further details NAVY; ARMY; FORTIFICATION AND SIEGE-CRAFT; AMMUNITION; ORDNANCE; SUBMARINE MINES; TORPEDO. The following is a general description of modern coast defences as applied in the British service.

No system of coast defence is of any value which does not take full account of the general distribution of sea-power and the resultant strength of the possible hostile forces. By resultant strength is meant the balance of one side over the other, for it is now generally regarded as an axiom that two opposing fleets must make their main effort in seeking one another, and that the force available for attack on coast defences will be either composed of such ships as can be spared from the main engagement, or the remnant of the hostile fleet after it has been victorious in a general action.

Coast defences are thus the complement and to some extent the measure of naval strength. It is often assumed that this principle was neglected in the large scheme of fortification associated in England with the name of Lord Palmerston, but it is at least arguable that the engineers responsible for the details of this scheme were dependent then as now on the naval view of what was a suitable naval strength. Public opinion has since been educated to a better appreciation of the necessity for a strong navy, and, as the British navy has increased, the scale of coast defences required has necessarily waned. Such a change of opinion is always gradual, and it is difficult to name an exact date on which it may be said that modern coast defence, as practised by British engineers, first began.

An approximation may, however, be made by taking the bombardment of Alexandria (1881) as being the parting of the ways between the old and the modern school. At that time the British navy, and in fact all other navies, had not really emerged from the stage of the wooden battleships. Guns were still muzzle-loaders, arranged mainly in broadsides, and protected by heavy armour; sails were still used as means of propulsion; torpedoes, net defence, signalling, and search-lights quite undeveloped.

At this time coast defences bore a close resemblance to the ships—the guns were muzzle-loaders, arranged in long batteries like a broadside, often in two tiers. The improvement of rifled ordnance had called for increased protection, and this was found first by solid constructions of granite, and latterly by massive iron fronts. Examples of these remain in Garrison Fort, Sheerness, and in Hurst Castle at the west end of the Solent. The range of guns being then relatively short, it was necessary to place forts at fairly close intervals, and where the channels to be defended could not be spanned from the shore, massive structures with two or even three tiers of guns, placed as close as on board ship and behind heavy armour, were built up from the ocean bed. On both sides the calibre and weight of guns were increasing, till the enormous sizes of 80 and 100 tons were used both ashore and afloat.

The bombardment of Alexandria established two new principles, or new applications of old principles, by showing the value of concealment and dispersion in reducing the effect of the fire of the fleet. On the old system, two ships firing at one another or ships firing at an iron-fronted fort shot "mainly into the brown"; if they missed the gun aimed at, one to the right or left was likely to be hit; if they missed the water-line, the upper works were in danger. At Alexandria, however, the Egyptian guns were scattered over a long line of shore, and it was soon found that with the guns and gunners available, hits could only be obtained by running in to short range and dealing with one gun at a time.

This new principle was not at once recognized, for systems

die hard, and much money and brains were invested in the then existing system. But a modern school was gradually formed; a small group of engineer officers under the leadership of Sir Andrew Clarke, the then inspector-general of fortifications, took the matter up, and by degrees the new views prevailed and the modern school of coast defence came into being between 1881 and 1885. Meanwhile important changes had been developing in the gun, the all-important weapon of coast defence, changes due mainly to the gradual supersession of the muzzle-loader by the breech-loader. The latter gave the advantages of quicker loading and more protection for the gun detachment over and above the technical improvements in the gun itself, which gave higher muzzle velocity, greater striking effect and longer effective range.

All this reacted on the general scheme of coast defence by enabling the number of guns to be reduced and the distance between forts increased. On the other hand, the ships, too, gained increased range and increased accuracy of fire, so that it became necessary in many cases to advance the general line of the coast defences farther from the harbour or dockyard to be defended, in order to keep the attackers out of range of the objective.

Another change resulted from an improvement in the method of mounting. Even in the older days discussion had arisen freely on the relative merits of barbette and casemate mounting. In the former the gun fires over a parapet, giving a larger field of view to the gun-layer, and a larger field of fire for the gun, with, however, more exposure for the detachment. The latter gives a restricted view and greater safety to the layer, but unless the casemate takes the form of a revolving turret, the arc of fire is very limited.

An important advantage of the barbette system is its cheapness, and thus in order to obtain with it concealment, suggestions were made for various forms of mounting which would allow of the gun, under the shock of recoil, disappearing behind the parapet to emerge only when loaded and ready for the next round. A mounting of this description for muzzle-loading guns, designed by Colonel Moncrieff, was actually in use in the defences of Alexandria and in H.M.S. "Téméraire."

But with the increased charges and length of breech-loading guns, a further change was desirable, and after some trials a system of disappearing mountings (see *ORDNANCE: Garrison Mountings*) was adopted into the British service.

A word must be now said on the size of gun finally adopted. At first muzzle-loaders figured largely in the British defences, even though these were planned on modern ideas; and even in 1906 muzzle-loading guns still existed and were counted as part of the defences. The sizes of these guns varied from the 32- or 64-pounder, of which the nomenclature depends on the weight of the shell, to the 7-in., 9-in., 10-in., 11-in., 12.5- and finally 17.25-in., the size indicating the calibre. Such a multiplication of sizes was due to gradual improvements in the science of gun manufacture, each advance being hailed as the last word to be said on the subject, and each in turn being rapidly made obsolete by something bigger and better. But with the improvements in gun design which followed the introduction of breech-loaders, the types used in coast defence were gradually narrowed down to two, the 9.2-in. and the 6-in. guns. Of these, the 9.2-in. was considered powerful enough to attack armour at any practical range, while the 6-in. gun was introduced to deal with lightly armed vessels at shorter ranges where 9.2-in. guns were unnecessarily powerful.

A few larger guns of 10-in. calibre have actually been used, but though the British navy has now scaled a 12-in. 50-ton gun as the stock size for battleships, for the heavy armament of the coast defences the War Office remain faithful to the 9.2-in. calibre, preferring to develop improvements rather in the direction of more rapid fire and higher muzzle velocity.

The 6-in. has also been retained and is extensively used for the smaller ports, where attack by powerful vessels is for various reasons considered improbable.

The design of the forts to contain the guns necessarily varied with the type of defence adopted, and the duties which the forts

had to fulfil. These duties may be said to be twofold, first to facilitate the service of the guns, and secondly to protect the guns and their detachments from damage by fire from ships, or by close attack from landing parties. The service of the gun is provided for by a system of cartridge and shell magazines (see *AMMUNITION*), well protected from fire and suitably arranged. The shelters for the gun detachments must be bomb-proof and fitted with some arrangements for comfort and sanitation. Formerly it was the custom to provide living accommodation for the full garrison in casemates inside each fort, but it is now considered better to provide barrack accommodation in the vicinity and to occupy forts in peace only by a few caretakers. The shelters in the fort itself can thus be kept at the minimum required when actually manning the guns. The protection of the guns and magazines against bombardment is provided, in the British service, mainly by an earthen parapet over a substantial roof or wall of concrete, but immediately round the gun an "apron" of concrete is necessary to withstand the shock of discharge or "blast."

It has been already mentioned that in the old designs a large number of guns was put in each fort, but with dispersion and improved gun power this number was much reduced. At first the type of fort adopted was for four guns, of which the two in the centre were heavy and the two on the flank of medium power. Such a design was good from the point of view of the engineer; it gave an economical grouping of magazines and shelters and was easily adapted to varying sites, and the smaller guns helped the larger by covering their flanks both towards the sea and also over the land approaches. But from the point of view of the artillery officer the arrangement was faulty, for when the guns are too much separated, ranging has to be carried out separately for each gun. On the other hand, two guns of the same calibre placed near one another can be fought simultaneously and form what is known as a "group." In the typical 4-gun battery described above, the flank guns had to be fought independently, which was wasteful of officers and staff. Further, in a battery of more than two guns the arc of fire of the centre guns is much restricted by that of the guns on either flank.

For these reasons it is now generally recognized that new works should be designed for only two guns of the same calibre, though 3- or 4-gun batteries are occasionally used in special circumstances.

Protection of the gun detachments against infantry attack is best provided by a line of infantry posts outside and on the flanks of the gun batteries, but as small parties may evade the outposts, or the latter may be driven in, it is necessary to place round each fort a line of obstacles sufficient to protect the guns against a rush and to cover the infantry while it rallies. This obstacle was formerly a wet or dry ditch, with escarp, counter-scarp and flanking galleries; but with the new design of parapet a simpler form of obstacle was adopted. This was obtained by carrying down and forward the slope of the parapet to a point well below the level of the surrounding ground, and then placing a stout fence at the foot of the parapet and concealed from view. It is in fact the old principle of the sunk fence, and has this further advantage, that the fence, being visible from the parapet, can be kept under fire by men posted between the guns without any special flanking galleries.

Occasionally two or more batteries are placed inside one line of obstacles, but usually each 2-gun battery is complete in itself.

Cases arise, e.g. with sites on the top of a cliff, where no obstacle is required; in such places the parapet merges into the surrounding ground.

In old days the parapet was shaped with well-defined edges and slopes. Now the parapet slopes gently down to the front and is rounded at the sides, so as to present no definite edge or angle to the enemy, and concealment is furthered by allowing grass or small scrub to grow over the parapet and round the guns. In order to obtain complete concealment from view the background behind the guns must be carefully studied from the

point of view of the attack. Sites on the sky-line, and marked contrasts of colour or shape, should be avoided. In some cases extensive planting, amounting to landscape gardening, is justified. This is most easily arranged in the tropics, where plant growth is rapid. In all cases the guns and their mountings should be coloured to blend with the background and thus avoid hard lines and shadows.

Any change of principle such as that of 1885 involves improvements both in guns and their adjuncts. Of these latter the most important was the position-finder designed by Colonel Watkin. This instrument in its simplest form, when the observer is following a ship through the telescope of the instrument, draws on a chart the track of the ship, so that the exact bearing and distance of the latter can be ascertained at any time and communicated to the guns by electrical and other dials, &c. The position-finder may be some distance from the guns it serves, and connected with them by electric cable. The guns can then be placed well under cover and in many cases out of sight of the target, giving a measure of protection which cannot be obtained with any system of direct laying over sights. This instrument has been applied on a high site to control guns placed low, or where guns are so placed as to be liable to obscuration by fog or mist the position-finder can be placed below the fog-line. In either case direct laying is provided for as an alternative. In some defences batteries equipped with old pattern 9-in. muzzle-loading guns, mounted as howitzers for long-range firing, have been placed in folds in the ground so as to be quite invisible from the sea and therefore invulnerable. Such batteries are fought entirely by the position-finder.

The next adjunct to coast defences is the submarine mine. In Great Britain the first submarine mining company dates from 1873, and from that date mining defences were gradually installed both at home and abroad; but the modern system of mining, which for twenty years was maintained at British ports, really started into full life under the impetus of Sir A. Clarke, about the same year (1885) in which we have dated the commencement of the modern coast defence system.

With the increased speed of warships, a method of attack on fortifications was evolved by running past the main defences and either taking them in reverse, or disregarding them and attacking the dockyard or other objective at short range. This was made more possible at most defended ports by the pushing forward of the defences which has been already alluded to, and it is especially dangerous where dockyards or towns are situated some way up a river or estuary, so that once the defences are passed there is a large stretch of water (e.g. the Thames, the Solent, and Cork harbour) in which the enemy can manoeuvre. In such cases there are two possible forms of defence, first by arranging for gun-fire behind the main gun position, usually called the defence of inner waters, and secondly by placing in the entrance and under the fire of the main gun defence some form of obstruction to detain ships under fire. This obstruction can be *passive* (booms, chains, rows of piles or sunken ships) or *active* (mines or torpedoes). Passive obstructions are only effective against comparatively small craft, and at important ports mines are the only efficient obstruction which can be used against large vessels.

After some years of experiment, English engineers adopted two main classes of mines, called "observation" and "contact" mines (see SUBMARINE MINES). Both were fired by electricity, which was applied only at the moment a hostile ship was within the dangerous zone of a mine. In the observation mines the moment of applying the electric current was ascertained by a position-finder, which, tracing a ship's course on a chart, made an electrical connexion at the moment the ship was over a mine. These mines were placed so as to be well below the bottom of any ships afloat and were used in channels which it was desired to leave open for the entrance of friendly vessels. Contact mines, which are moored a few feet below the surface of the water, are fired after certain electrical connexions have been made in a firing room on shore by the ship itself striking against the mine. These are used in waters which it is intended

to deny to friend and foe. Except in narrow waters where the whole width of the channel was required for friendly traffic, contact mines were generally used to limit the width of the channel to the minimum consistent with the amount of friendly traffic which would use the port in war. It will be readily understood that by bending this channel and disclosing its exact position only to special pilots, a very complete measure of security against surprise would be obtained. In English ports the practical importance of allowing free ingress for friendly traffic overruled all other considerations, and the friendly channels were always straight and coincided with some part of the usual fairway channel. They were also carefully marked by lightships and buoys.

A variation of the submarine mine is the Brennan torpedo, purchased by the British government about 1890. This differs from the torpedo used on board ship, mainly by the fact that the engine-power which drives it is on shore and connected with the torpedo by two strong wires. These wires are wound out of the torpedo by the engine, and by varying the strain on the two wires very accurate control of the steering can be obtained. This torpedo shares with the submarine mine the disadvantages that it must wait for the enemy to venture within its range, and with all other forms of defence (except contact mines), that it is made useless by fog or rain. As compared with a mine it has the advantage of being unaffected by tide or depth, and of forming no obstruction to traffic, except when actually in action. It was installed at the principal ports only.

The system of defence hitherto described is thus a main gun defence of 9.2-in. and 6-in. guns pushed well forward, assisted by position-finders, mine-fields and torpedo stations, and with some gun defence of inner waters. Subject to improvements in patterns of guns and mountings—of which the most important has been the substitution of barbette mounting and shield for the recoil mounting described above—this system held the field up to 1905, when, partly as a result of the experience of the Russo-Japanese War, and partly owing to the alteration of the naval balance of power due to the destruction of the Russian fleet, both the scale and system of defence were very considerably modified.

We can now consider another branch of defence, which was evolved *pari passu* with the automobile torpedo, and was therefore almost non-existent in 1885. In this year the boats specially built for carrying torpedoes were little more than launches, but in the next five years was developed the type of first-class torpedo boat. This, while seaworthy, was limited as to its radius of action by the small amount of coal it would carry. But with a possibly hostile coast only a few hours' steam away, and with foreign harbours thronged with torpedo craft, it became necessary for the British government especially to consider this form of attack and its antidote. It was obvious that in daytime and in clear weather such an attack would have little chance of success, also that in no circumstances would torpedo boats be able to damage fixed defences. Their best chance was attack by night, and the only form of attack was that referred to above as "running past," that is, an attempt to evade the defences and to attack ships or docks inside. The light draught of torpedo boats and their comparative invisibility favoured this form of attack.

To meet it the first requirement was some form of illumination of the defended channel. Experiments in the attack and defence of defended harbours took place at Gosport in 1879 and 1880, at Milford Haven in 1885, at Berehaven (by the royal navy) in 1886, at Langston Harbour in 1887, and a series at the Needles entrance of the Isle of Wight up to 1892. During the course of these experiments various methods of illumination were tried, but by far the best was found to be the light from an electric arc-lamp of high power projected by powerful reflectors. At first these were used as concentrated beams forming a pencil of light with an angular opening of about 2° to 3°. Such a beam directed at an incoming ship gives effective illumination up to a mile or more from the source of light, but has the disadvantage that it must be moved so as to follow the ship's movements.

Each beam thus lights only one ship at a time, and the movements of several beams crossing and re-crossing have a very confusing effect, with the consequent risk that a proportion of the attacking vessels may slip through unnoticed.

An alternative method of using electric lights is to arrange the projector so that the light comes out in a fan (generally of 30° divergence). Two or three such lights are usually placed side by side, forming an illuminated fan of considerable divergence. These fans are now used for the main defence, with in front of them one or more search lights to warn the defences of the approach of ships. There is some loss of range when using these fans as compared with search-lights, but by occupying both sides of a channel and placing the defences against torpedo boats at the narrowest point, an effective illumination can be obtained in moderate weather.

Heavy guns can, of course, be fired against torpedo boats, but their rate of fire is relatively slow, and at first they had also the disadvantage of using black powder, the smoke of which obscured the lights.

A small quick-firing gun using smokeless powder was seen to be a necessity. At first the 6-pounder was adopted as the stock size supplemented by machine guns for close range, but soon afterwards it became necessary to reconsider the scale of anti-torpedo boat defences, owing first to the increased size of first-class torpedo boats, and secondly to the introduction of a new type of vessel, the torpedo boat destroyer. The increased size of torpedo boats, and improved arrangements for the distribution of coal on board, made these boats practically proof against 6-pounder guns and necessitated the introduction of the 12-pounder. The torpedo boat destroyer, originally introduced to chase and destroy torpedo boats, not only justified its existence by checking the construction of more torpedo boats, but in addition became itself a sea-going torpedo craft, and thus increased the menace to defended ports and also the area over which this form of attack would be dangerous.

This development was met by an increased number of 12-pounder guns, assisted in the more important places by 4 7-in. (and latterly 4-in.) guns, and also by an increased number of lights, both guns and lights increasing at some places nearly fourfold. But even with the best possible arrangement of this form of defence, the possibility of interference by fog, mist or rain introduces a considerable element of uncertainty.

About the same time, and largely on account of the demand for better and quicker firing, the "automatic sight" was introduced (see *ORDNANCE: Garrison*; and *SIGHTS*). In this, a development of the principle of the position-finder, the act of bringing an object into the field of the auto-sight automatically lays the gun. In order to take full advantage of this, the ammunition was made up into a cartridge with powder and shell in one case to allow of the quickest possible loading. It may be added that the efficiency of the auto-sight depends on the gun being a certain height above the water, and that therefore the rise and fall of tide has to be allowed for in setting the sight.

In view of the possible interference by fog it was thought wise at an early stage to provide, towards the rear of the defences, some form of physical obstacle behind which ships could lie in safety. Such an obstacle had been designed in the early days by the Royal Engineers and took the form of a "boom" of baulks of timber secured by chains. Such booms were limited in size by considerations of expense and were only partially successful. About 1892 the British navy took the matter up and began experiments on a larger scale, substituting wire hawsers for chains and using old gunboats to divide the booms up into sections of convenient length. The result was that booms were definitely adopted as an adjunct of coast defence. Their place is behind the lighted area, but within reach of some of the anti-torpedo boat batteries.

Other forms of obstacle to torpedo boat attack, based on a modification of contact mines or a combination of mines and passive obstructions, have been tried but never definitely adopted, though some form of under-water defence of this description seems necessary to meet attack by submarines.

We may now summarize the anti-torpedo boat defences. These are, first, an outpost or look-out line of electric search-lights, then a main lighted area composed of fixed lights with which there are a considerable number of 12-pounder or 4-in. Q.F. guns fitted with auto-sights, and behind all this, usually at the narrowest part of the entrance, the boom.

Once coast defences are designed and installed, little change is possible during an attack, so that the operation of fighting a system of defence, such as we have considered above, is mainly a matter of peace training of gun-crews, electric light men and look-outs, coupled with careful organization. To facilitate the transmission of order and intelligence, a considerable system of telephonic and other electrical communication has been established. This may be considered under the three heads of (1) orders, (2) intelligence, (3) administration.

The communication of orders follows the organization adopted for the whole fortress. Each fortress is commanded by a fortress commander, who has a suitable staff. This officer sends orders to commanders of artillery, engineers, and infantry. The artillery officer in charge of a group of batteries is called a "fire commander"; his command is generally confined to such batteries as fire over the same area of water and can mutually support one another. Thus there may be several fire commanders at a defended port. Anti-torpedo boat batteries are not in a fire command, and are connected to the telephone system for intelligence only and not for orders. The engineers require orders for the control of electric lights or Brennan torpedo. The officer in charge of a group of lights or of a torpedo station is called a director. Though receiving orders direct from the fortress commander, he has also to co-operate with the nearest artillery commander. The infantry are posted on the flanks of the fixed defences, or on the land front. They are divided into suitable groups, each under a commanding officer, who communicates with the fortress commander. In large fortresses the area is divided into sections, each including some portion of the artillery, engineers, and infantry defence. In such cases the section commanders receive orders from the fortress commander and pass them on to their subordinates.

The *intelligence* system includes communication with the naval signal stations in the vicinity, one of which is specially selected for each port as the warning station and is directly connected to some part of the defences. Another part of the intelligence system deals with the arrangements for examining all ships entering a harbour. This is usually effected by posting in each entrance examination vessels, which are in communication by signal with a battery or selected post on shore. Any points on shore which can see the approaches are connected by a special alarm circuit, mainly for use in case of torpedo boat attack.

The *administrative* system of telephones is used for daily routine messages. These usually take the form of telephone lines radiating from a central exchange. In many stations the same lines may be used for command and administration, or intelligence and command, but at the larger stations each class of line is kept distinct. (W. B. B.)

COASTGUARD, a naval force maintained in Great Britain and Ireland to suppress smuggling, aid shipwrecked vessels and serve as a reserve to the navy. The coastguard was originally designed to prevent smuggling. Before 1816 this duty was entrusted to the revenue cutters, and to a body of "riding officers," mounted men who were frequently supported by detachments of dragoons. The crews of the cutters and the riding officers were under the authority of the custom house in London, and were appointed by the treasury. On the conclusion of the war with Napoleon in 1815 it was resolved to take stricter precautions against smuggling. A "coast blockade" was established in Kent and Sussex. The "Ramillies" (74) was stationed in the Downs and the "Hyperion" (42) at Newhaven. A number of half-pay naval lieutenants were appointed to these vessels, but were stationed with detachments of men and boats at the Martello towers erected along the coast as a defence against French invasion. They were known as the "preventive

water guard" or the "preventive service." The crews of the boats were partly drawn from the revenue cutters, and partly hired from among men of all trades. The "coast blockade" was extended to all parts of the coast. The revenue cutters and the riding officers continued to be employed, and the whole force was under the direction of the custom house. The whole was divided into districts under the command of naval officers. In 1822 the elements of which the preventive water guard was composed were consolidated, and in 1829 it was ordered that only sailors or fishermen should be engaged as boatmen. In 1830 the whole service consisted of 50 revenue cutters, five vessels of 150 and 200 tons, of the "preventive boats," and the riding officers. In 1831, during the administration of Sir James Graham, the service was transferred to the admiralty, though the custom house flag was used till 1857. After 1840 the men were drilled "in the common formations," mainly with a view to being employed for the maintenance of order and in support of the police, in case of Chartist or other agitations. But in 1845 the first steps were taken to utilize the coastguard as a reserve to the navy. The boatmen were required to sign an engagement to serve in the navy if called upon. In May 1857 the service was transferred entirely to the admiralty, and the coastguard became a part of the navy, using the navy flag. The districts were placed under captains of the navy, known as district captains, in command of ships stationed at points round the coast. Since that year the coastguard has been recruited from the navy, and has been required to do regular periods of drill at sea, on terms laid down by the admiralty from time to time. It has, in fact, been a form of naval reserve.

The rise and early history of the coastguard are told in *Smuggling Days and Smuggling Ways*, by the Hon. Henry N. Shore, R.N., (London, 1892). Its later history must be traced in the *Queen's* (and *King's*) *Regulations and Admiralty Instructions* of successive years. (D. H.)

COASTING, usually called tobogganing (*q.v.*) in Europe, the sport of sliding down snow or ice-covered hills or artificial inclines upon hand-sleds, or sledges, provided with runners shod with iron or steel. It is uncertain whether the first American sleds were copied from the Indian toboggans, but no sled without runners was known in the United States before 1870, except to the woodsmen of the Canadian border. American laws have greatly restricted, and in most places prohibited, the practice, once common, of coasting on the highways; and the sport is mainly confined to open hills and artificial inclines or chutes. Two forms of hand-sled are usual in America, the original "clipper" type, built low with long, pointed sides, originally shod with iron but since 1850 with round steel runners; and the light, short "girls' sled," with high skeleton sides, usually flat shod. There is also the "double-runner," or "bob-sled," formed of two clipper sleds joined by a board and steered by ropes, a wheel or a cross-bar, and seating from four to ten persons.

In Scandinavia several kinds of sled are common, but that of the fishermen, by means of which they transport their catch over the frozen fjords, is the one used in coasting, a sport especially popular in the neighbourhood of Christiania, where there are courses nearly 3 m. in length. This sled is from 4 to 6 ft. long, with skeleton sides about 7 in. high, and generally holds three persons. It is steered by two long sticks trailing behind. On the ice the fisherman propels his sled by means of two short picks. The general Norwegian name for sledge is *skjælker*, the primitive form being a kind of toboggan provided with broad wooden runners resembling the ski (*q.v.*). In northern Sweden and Finland the commonest form of single sled is the *Sparkstöttinger*, built high at the back, the coaster standing up and steering by means of two handles projecting from the sides.

Coasting in its highest development may be seen in Switzerland, at the fashionable winter resorts of the Engadine, where it is called tobogganing. The first regular races there were organized by John Addington Symonds, who instituted an annual contest for a challenge cup, open to all comers, over the steep post-road from Davos to Klosters, the finest natural coast in Switzerland, the sled used being the primitive native *Schliitli* or *Handschliitten*, a miniature copy of the ancient horse-sledge. Soon afterwards

followed the construction of great artificial runs, the most famous being the "Cresta" at St Moritz, begun in 1884, which is about 1350 yds. in length, its dangerous curves banked up like those of a bicycle track. On this the annual "Grand National" championship is contested, the winner's time being the shortest aggregate of three heats. In 1885 and the following year the native *Schliitli* remained in use, the rider sitting upright facing the goal, and steering either with the heels or with short picks. In 1887 the first American clipper sled was introduced by L. P. Child, who easily won the championship for that year on it. The sled now used by the contestants is a development of the American type, built of steel and skeleton in form. With it a speed of over 70 m. an hour has been attained. The coaster lies flat upon it and steers with his feet, shod with spiked shoes, to render braking easier, and helped with his gloved hands. The "double-runner" has also been introduced into Switzerland under the name of "bob-sleigh."

See *Ice Sports*, in the Isthmian Library, London (1901); *Tobogganing at St Moritz*, by T. A. Cook (London, 1896).

COATBRIDGE, a municipal and police burgh, having the privileges of a royal burgh, of Lanarkshire, Scotland. Pop. (1891) 15,212; (1901) 36,991. It is situated on the Monkland Canal, 8 m. E. of Glasgow, with stations on the Caledonian and North British railways. Until about 1825 it was only a village, but since then its vast stores of coal and iron have been developed, and it is now the centre of the iron trade of Scotland. Its prosperity was largely due to the ironmaster James Baird (*q.v.*), who erected as many as sixteen blast-furnaces in the immediate neighbourhood between 1830 and 1842. The industries of Coatbridge produce malleable iron, boilers, tubes, wire, tinplates and railway wagons, tiles, fire-bricks and fire-clay goods. There are two public parks in the town, and its public buildings include a theatre, a technical school and mining college, hospitals, and the academy and Baird Institute at Gartsherrie. Janet Hamilton, the poetess (1795-1873), spent most of her life at Langloan—now a part of Coatbridge—and a fountain has been erected to her memory near the cottage in which she lived. For parliamentary purposes the town, which became a municipal burgh in 1885, is included in the north-west division of Lanarkshire. About 4 m. west by south lies the mining town of Baillieston (pop. 3784), with a station on the Caledonian railway. It has numerous collieries, a nursery and market garden.

COATESVILLE, a borough of Chester county, Pennsylvania, U.S.A., on the west branch of Brandywine Creek, 39 m. W. of Philadelphia. Pop. (1890) 3680; (1900) 5721 (273 foreign-born); (1910) 11,084. It is served by the Pennsylvania and the Philadelphia & Reading railways, and interurban electric lines. For its size the borough ranks high as a manufacturing centre, iron and steel works, boiler works, brass works, and paper, silk and woollen mills being among its leading establishments. Its water-works are owned and operated by the municipality. Named in honour of Jesse Coates, one of its early settlers, it was settled about 1800, and was incorporated in 1867.

COATI, or **COATI-MUNDI**, the native name of the members of the genus *Nasua*, of the mammalian family *Procyonidae*. They are easily recognized by their long body and tail, and elongated, upturned snout; from which last feature the Germans call them *Rüsselbären* or "snouted bears." In the white-nosed coati, a native of Mexico and Central America, the general hue is brown, but the snout and upper lip are white, and the tail is often banded. In the red coati, ranging from Surinam to Paraguay, the tail is marked with from seven to nine broad fulvous or rufous rings, alternating with black ones, and tipped with black. Coatis are gregarious and arboreal in habit, and feed on birds, eggs, lizards and insects. They are common pets of the Spaniards in South America. (See **CARNIVORA**.)

COB, a word of unknown origin with a variety of meanings, which the *New English Dictionary* considers may be traced to the notions of something stout, big, round, head or top. In "cobble," *e.g.* in the sense of a round stone used in paving, the same word may be traced. The principal uses of "cob" are for a stocky strongly built horse, from 13 to 14 hands high, a small round loaf,

a round lump of coal, in which sense "cobble" is also used, the fruiting spike of the maize plant, and a large nut of the hazel type, more commonly known as the cob-nut.

"Cobbler," a patcher or mender of boots and shoes, is probably from a different root. It has nothing to do with an O. Fr. *coubler*, Mod. *coupler*, to fasten together. In "cobweb," the web of the spider, the "cob" represents the older *cop*, *coppe*, spider, cf. Dutch *spinnecop*.

COBALT (symbol Co, atomic weight 59), one of the metallic chemical elements. The term "cobalt" is met with in the writings of Paracelsus, Agricola and Basil Valentine, being used to denote substances which, although resembling metallic ores, gave no metal on smelting. At a later date it was the name given to the mineral used for the production of a blue colour in glass. In 1735 G. Brandt prepared an impure cobalt metal, which was magnetic and very infusible. Cobalt is usually found associated with nickel, and frequently with arsenic, the chief ores being speiss-cobalt, $(\text{Co}, \text{Ni}, \text{Fe})\text{As}_2$, cobaltite (*q.v.*), wad, cobalt bloom, linnacite, Co_2S_4 , and skutterudite, CoAs_3 . Its presence has also been detected in the sun and in meteoric iron. For the technical preparation of cobalt, and its separation from nickel, see NICKEL. The metal is chiefly used, as the oxide, for colouring glass and porcelain.

Metallic cobalt may be obtained by reduction of the oxide or chloride in a current of hydrogen at a red heat, or by heating the oxalate, under a layer of powdered glass. As prepared by the reduction of the oxide it is a grey powder. In the massive state it has a colour resembling polished iron, and is malleable and very tough. It has a specific gravity of 8.8, and it melts at 1530°C . (H. Copaux). Its mean specific heat between 9° and 97°C . is 0.10674 (H. Kopp). It is permanent in dry air, but in the finely divided state it rapidly combines with oxygen, the compact metal requiring a strong heating to bring about this combination. It decomposes steam at a red heat, and slowly dissolves in dilute hydrochloric and sulphuric acids, but more readily in nitric acid. Cobalt burns in nitric oxide at 150°C . giving the monoxide. It may be obtained in the pure state, according to C. Winkler (*Zeit. für anorg. Chem.*, 1895, 8, p. 1), by electrolyzing the pure sulphate in the presence of ammonium sulphate and ammonia, using platinum electrodes, any occluded oxygen in the deposited metal being removed by heating in a current of hydrogen.

Three characteristic oxides of cobalt are known, the monoxide, CoO , the sesquioxide, Co_2O_3 , and trivalent tetroxide, Co_3O_4 ; besides these there are probably oxides of composition CoO_2 , Co_3O_5 , Co_5O_7 and Co_4O_6 . Cobalt monoxide, CoO , is prepared by heating the hydroxide or carbonate in a current of air, or by heating the oxide Co_2O_3 in a current of carbon dioxide. It is a brown coloured powder which is stable in air, but gives a higher oxide when heated. On heating in hydrogen, ammonia or carbon monoxide, or with carbon or sodium, it is reduced to the metallic state. It is readily soluble in warm dilute mineral acids forming cobaltous salts. Cobaltous hydroxide, $\text{Co}(\text{OH})_2$, is formed when a cobaltous salt is precipitated by caustic potash in the absence of air. A blue basic salt is precipitated first, which, on boiling, rapidly changes to the rose-coloured hydroxide. It dissolves in acids forming cobaltous salts, and on exposure to air it rapidly absorbs oxygen, turning brown in colour. A. de Schulten (*Comptes Rendus*, 1889, 109, p. 266) has obtained it in a crystalline form; the crystals have a specific gravity of 3.597, and are easily soluble in warm ammonium chloride solution. Cobalt sesquioxide, Co_2O_3 , remains as a dark-brown powder when cobalt nitrate is gently heated. Heated at $190\text{--}300^\circ$ in a current of hydrogen it gives the oxide Co_3O_4 , while at higher temperatures the monoxide is formed, and ultimately cobalt is obtained. Cobaltic hydroxide, $\text{Co}(\text{OH})_3$, is formed when a cobalt salt is precipitated by an alkaline hypochlorite, or on passing chlorine through water containing suspended cobaltous hydroxide or carbonate. It is a brown-black powder soluble in hydrochloric acid, chlorine being simultaneously liberated. This hydroxide is soluble in well cooled acids, forming solutions which contain cobaltic salts, one of the most stable of which is the acetate. Cobalt dioxide, CoO_2 , has not yet been isolated in the pure state; it is probably formed when iodine and caustic soda are added to a solution of a cobaltous salt. By suspending cobaltous hydroxide in water and adding hydrogen peroxide, a strongly acid liquid is obtained (after filtering) which probably contains *cobaltous acid*, H_2CoO_3 . The barium and magnesium salts of this acid are formed when baryta and magnesia are fused with cobalt sesquioxide. Trivalent tetroxide, Co_3O_4 , is produced when the other oxides, or the nitrate, are heated in air.

By heating a mixture of cobalt oxalate and sal-ammoniac in air, it is obtained in the form of minute hard octahedra, which are not magnetic, and are only soluble in concentrated sulphuric acid.

The cobaltous salts are formed when the metal, cobaltous oxide, hydroxide or carbonate, are dissolved in acids, or, in the case of the insoluble salts, by precipitation. The insoluble salts are rose-red or violet in colour. The soluble salts are, when in the hydrated condition, also red, but in the anhydrous condition are blue. They are precipitated from their alkaline solutions as cobalt sulphide by sulphuretted hydrogen, but this precipitation is prevented by the presence of citric and tartaric acids; similarly the presence of ammonium salts hinders their precipitation by caustic alkalis. Alkaline carbonates give precipitates of basic carbonates, the formation of which is also retarded by the presence of ammonium salts. For the action of ammonia on the cobaltous salts in the presence of air see *Cobaltamines* (below). On the addition of potassium cyanide they give a brown precipitate of cobalt cyanide, $\text{Co}(\text{CN})_2$, which dissolves in excess of potassium cyanide to a green solution.

Cobalt chloride, CoCl_2 , in the anhydrous state, is formed by burning the metal in chlorine or by heating the sulphide in a current of the same gas. It is blue in colour and sublimes readily. It dissolves easily in water, forming the hydrated chloride, $\text{CoCl}_2 \cdot 6\text{H}_2\text{O}$, which may also be prepared by dissolving the hydroxide or carbonate in hydrochloric acid. The hydrated salt forms rose-red prisms, readily soluble in water to a red solution, and in alcohol to a blue solution. Other hydrated forms of the chloride, of composition $\text{CoCl}_2 \cdot 2\text{H}_2\text{O}$ and $\text{CoCl}_2 \cdot 4\text{H}_2\text{O}$ have been described (P. Sabatier, *Bull. Soc. Chim.* 51, p. 88; Bensch, *Jahresb. d. Chemie*, 1867, p. 291). Double chlorides of composition $\text{CoCl}_2 \cdot \text{NH}_4\text{Cl} \cdot 6\text{H}_2\text{O}$; $\text{CoCl}_2 \cdot \text{SnCl}_4 \cdot 6\text{H}_2\text{O}$ and $\text{CoCl}_2 \cdot 2\text{CdCl}_2 \cdot 12\text{H}_2\text{O}$ are also known. By the addition of excess of ammonia to a cobalt chloride solution in absence of air, a greenish-blue precipitate is obtained which, on heating, dissolves in the solution, giving a rose-red liquid. This solution, on standing, deposits octahedra of the composition $\text{CoCl}_2 \cdot 6\text{NH}_3$. These crystals when heated to 120°C . lose ammonia and are converted into the compound $\text{CoCl}_2 \cdot 2\text{NH}_3$ (E. Frémy). The bromide, CoBr_2 , resembles the chloride, and may be prepared by similar methods. The hydrated salt readily loses water on heating, forming at 100°C . the hydrate $\text{CoBr}_2 \cdot 2\text{H}_2\text{O}$, and at 130°C . passing into the anhydrous form. The iodide, CoI_2 , is produced by heating cobalt and iodine together, and forms a greyish-green mass which dissolves readily in water forming a red solution. On evaporating this solution the hydrated salt $\text{CoI}_2 \cdot 6\text{H}_2\text{O}$ is obtained in hexagonal prisms. It behaves in an analogous manner to $\text{CoBr}_2 \cdot 6\text{H}_2\text{O}$ on heating.

Cobalt fluoride, $\text{CoF}_2 \cdot 2\text{H}_2\text{O}$, is formed when cobalt carbonate is evaporated with an excess of aqueous hydrofluoric acid, separating in rose-red crystalline crusts. Electrolysis of a solution in hydrofluoric acid gives cobaltic fluoride, CoF_3 .

Sulphides of cobalt of composition Co_3S_4 , CoS , Co_2S_4 , Co_2S_3 and CoS_2 are known. The most common of these sulphides is cobaltous sulphide, CoS , which occurs naturally as sycpeorite, and can be artificially prepared by heating cobaltous oxide with sulphur, or by fusing anhydrous cobalt sulphate with barium sulphide and common salt. By either of these methods, it is obtained in the form of bronze-coloured crystals. It may be prepared in the amorphous form by heating cobalt with sulphur dioxide, in a sealed tube, at 200°C . In the hydrated condition it is formed by the action of alkaline sulphides on cobaltous salts, or by precipitating cobalt acetate with sulphuretted hydrogen (in the absence of free acetic acid). It is a black amorphous powder soluble in concentrated sulphuric and hydrochloric acids, and when in the moist state readily oxidizes on exposure.

Cobaltous sulphate, $\text{CoSO}_4 \cdot 7\text{H}_2\text{O}$, is found naturally as the mineral *bieberite*, and is formed when cobalt, cobaltous oxide or carbonate are dissolved in dilute sulphuric acid. It forms dark red crystals isomorphous with ferrous sulphate, and readily soluble in water. By dissolving it in concentrated sulphuric acid and warming the solution, the anhydrous salt is obtained. Hydrated sulphates of composition $\text{CoSO}_4 \cdot 6\text{H}_2\text{O}$, $\text{CoSO}_4 \cdot 4\text{H}_2\text{O}$ and $\text{CoSO}_4 \cdot \text{H}_2\text{O}$ are also known. The heptahydrated salt combines with the alkaline sulphates to form double sulphates of composition $\text{CoSO}_4 \cdot \text{M}_2\text{SO}_4 \cdot 6\text{H}_2\text{O}$ ($\text{M} = \text{K}, \text{NH}_4$, &c.).

The cobaltic salts corresponding to the oxide Co_2O_3 are generally unstable compounds which exist only in solution. H. Marshall (*Proc. Roy. Soc. Edin.* 59, p. 760) has prepared cobaltic sulphate $\text{Co}_2(\text{SO}_4)_3 \cdot 18\text{H}_2\text{O}$, in the form of small needles, by the electrolysis of cobalt sulphate. In a similar way potassium and ammonium cobalt alums have been obtained. A cobaltisulphurous acid, probably $\text{H}_2[(\text{SO}_2)_2 \cdot \text{Co}_2]$ has been obtained by E. Berglund (*Berichte*, 1874, 7, p. 469), in aqueous solution, by dissolving ammonium cobalto-cobaltisulphite $(\text{NH}_4)_2\text{Co}_2[(\text{SO}_2)_2 \cdot \text{Co}_2] \cdot 14\text{H}_2\text{O}$ in dilute hydrochloric or nitric acids, or by decomposition of its silver salt with hydrochloric acid. The ammonium cobalto-cobaltisulphite is prepared by saturating an air-oxidized ammoniacal solution of cobaltous chloride with sulphur dioxide. The double salts containing the metal in the cobaltic form are more stable than the corresponding single salts, and of these potassium cobaltinitrite, $\text{Co}_2(\text{NO}_2)_6 \cdot 6\text{KNO}_3 \cdot 3\text{H}_2\text{O}$, is best known. It may be prepared by the addition of potassium nitrite to an acetic acid solution of cobalt chloride. The yellow precipitate obtained is washed with a solution

of potassium acetate and finally with dilute alcohol. The reaction proceeds according to the following equation: $2\text{CoCl}_2 + 10\text{KNO}_2 + 4\text{HNO}_3 = \text{Co}_2(\text{NO}_2)_6 \cdot 6\text{KNO}_2 + 4\text{KCl} + 2\text{NO} + 2\text{H}_2\text{O}$ (A. Stromeyer, *Annalen*, 1855, 96, p. 220). This salt may be used for the separation of cobalt and nickel, since the latter metal does not form a similar double nitrite, but it is necessary that the alkaline earth metals should be absent, for in their presence nickel forms complex nitrites containing the alkaline earth metal and the alkali metal. A sodium cobaltinitrite is also known.

Cobalt nitrate, $\text{Co}(\text{NO}_3)_2 \cdot 6\text{H}_2\text{O}$, is obtained in dark-red monoclinic tables by the slow evaporation of a solution of the metal, its hydroxide or carbonate, in nitric acid. It deliquesces in the air and melts readily on heating. By the addition of excess of ammonia to its aqueous solution, in the complete absence of air, a blue precipitate of a basic nitrate of the composition $6\text{CoO} \cdot \text{N}_2\text{O}_5 \cdot 5\text{H}_2\text{O}$ is obtained.

By boiling a solution of cobalt carbonate in phosphoric acid, the acid phosphate $\text{CoH}_2\text{PO}_4 \cdot 3\text{H}_2\text{O}$ is obtained, which when heated with water to 250°C . is converted into the neutral phosphate $\text{Co}_3(\text{PO}_4)_2 \cdot 2\text{H}_2\text{O}$ (H. Debray, *Ann. de chimie*, 1861, [3] 61, p. 438). Cobalt ammonium phosphate, $\text{CoNH}_4\text{PO}_4 \cdot 12\text{H}_2\text{O}$, is formed when a soluble cobalt salt is digested for some time with excess of a warm solution of ammonium phosphate. It separates in the form of small rose-red crystals, which decompose on boiling with water.

Cobaltous cyanide, $\text{Co}(\text{CN})_2 \cdot 3\text{H}_2\text{O}$, is obtained when the carbonate is dissolved in hydrocyanic acid or when the acetate is precipitated by potassium cyanide. It is insoluble in dilute acids, but is readily soluble in excess of potassium cyanide. The double cyanides of cobalt are analogous to those of iron. Hydrocobaltocyanic acid is not known, but its potassium salt, $\text{K}_3\text{Co}(\text{CN})_6$, is formed when freshly precipitated cobalt cyanide is dissolved in an ice-cold solution of potassium cyanide. The liquid is precipitated by alcohol, and the washed and dried precipitate is then dissolved in water and allowed to stand, when the salt separates in dark-coloured crystals. In alkaline solution it readily takes up oxygen and is converted into potassium cobaltcyanide, $\text{K}_3\text{Co}(\text{CN})_6$, which may also be obtained by evaporating a solution of cobalt cyanide, in excess of potassium cyanide, in the presence of air, $8\text{KCN} + 2\text{Co}(\text{CN})_2 + \text{H}_2\text{O} + \text{O} = 2\text{K}_3\text{Co}(\text{CN})_6 + 2\text{KHO}$. It forms monoclinic crystals which are very soluble in water. From its aqueous solution, concentrated hydrochloric acid precipitates hydrocobaltocyanic acid, $\text{H}_2\text{Co}(\text{CN})_6$, as a colourless solid which is very deliquescent, and is not attacked by concentrated hydrochloric and nitric acids. For a description of the various salts of this acid, see P. Wesselsky, *Berichte*, 1869, 2, p. 588.

Cobaltamines. A large number of cobalt compounds are known, of which the empirical composition represents them as salts of cobalt to which one or more molecules of ammonia have been added. These salts have been divided into the following series:—

Diammine Series, $[\text{Co}(\text{NH}_3)_2]_x\text{M}$. In these salts $\text{X} = \text{NO}_2$ and $\text{M} =$ one atomic proportion of a monovalent metal, or the equivalent quantity of a divalent metal.

Triammine Series, $[\text{Co}(\text{NH}_3)_3]_x\text{X}$. Here $\text{X} = \text{Cl}, \text{NO}_3, \text{NO}_2, \frac{1}{2}\text{SO}_4$, &c.

Tetrammine Series. This group may be divided into the

Praseo-salts $[\text{R}_2\text{Co}(\text{NH}_3)_4]_x\text{X}$, where $\text{X} = \text{Cl}$.

Croceo-salts $[(\text{NO}_2)_2\text{Co}(\text{NH}_3)_4]_x\text{X}$, which may be considered as a subdivision of the praseo-salts.

Tetrammine purpureo-salts $[\text{RCo}(\text{NH}_3)_4 \cdot \text{H}_2\text{O}]_x\text{X}_2$.

Tetrammine roseo-salts $[\text{Co}(\text{NH}_3)_4 \cdot (\text{H}_2\text{O})_2]_x\text{X}_3$.

Fuseo-salts $[\text{Co}(\text{NH}_3)_4]\text{OH} \cdot \text{X}_2$.

Pentammine Series.

Pentammine purpureo-salts $[\text{R} \cdot \text{Co}(\text{NH}_3)_5]_x\text{X}_2$ where $\text{X} = \text{Cl}, \text{Br}, \text{NO}_3, \text{NO}_2, \frac{1}{2}\text{SO}_4$, &c.

Pentammine roseo-salts $[\text{Co}(\text{NH}_3)_5 \cdot \text{H}_2\text{O}]_x\text{X}_2$.

Hexammine or Luteo Series $[\text{Co}(\text{NH}_3)_6]_x\text{X}_3$.

The hexammine salts are formed by the oxidizing action of air on dilute ammoniacal solutions of cobaltous salts, especially in presence of a large excess of ammonium chloride. They form yellow or bronze-coloured crystals, which decompose on boiling their aqueous solution. On boiling their solution in caustic alkalis, ammonia is liberated. The pentammine purpureo-salts are formed from the luteo-salts by loss of ammonia, or from an air slowly oxidized ammoniacal cobalt salt solution, the precipitated luteo-salt being filtered off and the filtrate boiled with concentrated acids. They are violet-red in colour, and on boiling or long standing with dilute acids they pass into the corresponding roseo-salts.

The pentammine nitrito salts are known as the xanthocobalt salts and have the general formula $[\text{NO}_2 \cdot \text{Co}(\text{NH}_3)_5]_x\text{X}_2$. They are formed by the action of nitrous fumes on ammoniacal solutions of cobaltous salts, or purpureo-salts, or by the mutual reaction of chlorpurpureo-salts and alkaline nitrites. They are soluble in water and give characteristic precipitates with platinum and auric chlorides, and with potassium ferrocyanide. The pentammine roseo-salts can be obtained from the action of concentrated acids, in the cold, on air-oxidized solutions of cobaltous salts. They are of a reddish colour and usually crystallize well; on heating with concentrated acids are usually transformed into the purpureo-salts. Their alkaline solutions liberate ammonia on boiling. They give a characteristic pale red precipitate with sodium pyrophosphate, soluble in an excess of the precipitant; they also form precipitates on the addition of

platinic chloride and potassium ferrocyanide. For methods of preparation of the tetrammine and triammine salts, see O. Dammer's *Handbuch der anorganischen Chemie*, vol. 3 (containing a complete account of the preparation of the cobaltamine salts). The diammine salts are prepared by the action of alkaline nitrites on cobaltous salts in the presence of much ammonium chloride or nitrate; they are yellow or brown crystalline solids, not very soluble in cold water.

The above series of salts show striking differences in their behaviour towards reagents; thus, aqueous solutions of the luteo chlorides are strongly ionized, as is shown by their high electric conductivity; and all their chlorine is precipitated on the addition of silver nitrate solution. The aqueous solution, however, does not show the ordinary reactions of cobalt or of ammonia, and so it is to be presumed that the salt ionizes into $[\text{Co}(\text{NH}_3)_6]^{2+}$ and 3Cl^- . The purpureo chloride has only two-thirds of its chlorine precipitated on the addition of silver nitrate, and the electric conductivity is much less than that of the luteo chloride; again in the praseo-salts only one-third of the chlorine is precipitated by silver nitrate, the conductivity again falling; while in the triammine salts all ionization has disappeared. For the constitution of these salts and of the "metal ammonia" compounds generally, see A. Werner, *Zeit. für anorg. Chemie*, 1893 et seq., and *Berichte*, 1895, et seq.; and S. Jørgensen, *Zeit. für anorg. Chemie*, 1892 et seq.

The *oxycobaltamines* are a series of compounds of the general type $[\text{Co}_2\text{O}_2 \cdot \text{H}_2(\text{NH}_3)_6]_x\text{N}_4$ first observed by L. Gmelin, and subsequently examined by E. Frémy, W. Gibbs and G. Vortmann (*Monatshefte für Chemie*, 1885, 6, p. 404). They result from the cobaltamines by the direct taking up of oxygen and water. On heating, they decompose, forming basic tetrammine salts.

The atomic weight of cobalt has been frequently determined, the earlier results not being very concordant (see R. Schneider, *Pog. Ann.*, 1857, 101, p. 387; C. Marignac, *Arch. Phys. Nat.* [2], 1, p. 373; W. Gibbs, *Amer. Jour. Sci.* [2], 25, p. 483; J. B. Dumas, *Ann. Chim. Phys.*, 1859 [3], 55, p. 129; W. J. Russell, *Jour. Chem. Soc.*, 1863, 16, p. 51). C. Winkler, by the analysis of the chloride, and by the action of iodine on the metal, obtained the values 59.37 and 59.07, whilst W. Hempel and H. Thiele (*Zeit. f. anorg. Chem.*, 1896, 11, p. 73), by reducing cobalto-cobaltic oxide, and by the analysis of the chloride, have obtained the values 58.56 and 58.48. G. P. Baxter and others deduced the value 58.995 (O = 16).

Cobalt salts may be readily detected by the formation of the black sulphide, in alkaline solution, and by the blue colour they produce when fused with borax. For the quantitative determination of cobalt, it is either weighed as the oxide, Co_3O_4 , obtained by ignition of the precipitated monoxide, or it is reduced in a current of hydrogen and weighed as metal. For the quantitative separation of cobalt and nickel, see E. Hintz (*Zeit. f. anal. Chem.*, 1891, 30, p. 227), and also NICKEL.

COBALTITE, a mineral with the composition CoAsS , cobalt sulpharsenide. It is found as granular to compact masses, and frequently as beautifully developed crystals, which have the same symmetry as the isomorphous mineral pyrites, being cubic with parallel hemihedrism. The usual forms are the cube, octahedron and pentagonal dodecahedron {210}. The colour is silver-white with a reddish tinge, and the lustre brilliant and metallic, hence the old name cobalt-glance; the streak is greyish-black. The mineral is brittle, and possesses distinct cleavages parallel to the faces of the cube; hardness $5\frac{1}{2}$; specific gravity 6.2. The brilliant crystals from Tunaberg in Södermanland and Håkansboda in Vestmanland, Sweden, and from Skutterud near Drammen in Norway are well known in mineral collections. The cobalt ores at these localities occur with pyrites and chalcopyrite as bands in gneiss. Crystals have also been found at Khetri in Rajputana, and under the name *schita* the mineral is used by Indian jewellers for producing a blue enamel on gold and silver ornaments. Massive cobaltite has been found in small amount in the Botallack mine, Cornwall. A variety containing much iron replacing cobalt, and known as ferrocobaltite (Ger. *Stahlkobalt*), occurs at Siegen in Westphalia. (L. J. S.)

COBÁN, or **SANTO DOMINGO DE COBÁN**, the capital of the department of Alta Vera Paz in central Guatemala; about 90 m. N. of the city of Guatemala, on the Cojabón, a left-hand tributary of the Polochic. Pop. (1905) about 31,000. The town is built in a mountainous and fertile district, and consists chiefly of adobe Indian cottages, surrounded by gardens of flowering shrubs. More modern houses have been erected for the foreign residents, among whom the Germans are numerically predominant. In the chief square of the town stands a 16th-century Dominican church, externally plain, but covered internally with curious Indian decorations. The municipal offices, formerly a college for priests, are remarkable for their handsome but

disproportionately large gateway in Renaissance style. Despite the want of a railway, Cobán has a flourishing trade in coffee and cinchona; cocoa, vanilla and sugar-cane are also cultivated, and there are manufactures of rum, cotton fabrics, soap and cigars. The prosperity of the town is largely due to the industry of the Quiché, Kacobi or Kachobi Indians who form the majority of the inhabitants.

Cobán was founded in the 16th century by Dominican monks under Fray Pedro de Angulo, whose portrait is preserved in the church. In honour of the emperor Charles V. (1500-1558), Cobán received the name of *Ciudad Imperial* (which soon became obsolete), together with a coat of arms and other privileges belonging to a Spanish city of the first class.

COBAR, a mining town of Robinson county, New South Wales, Australia, 430 m. N.W. by W. of Sydney by rail. Pop. (1901) 3,571. The district of which Cobar is the centre abounds in minerals of all kinds, but copper and gold are those most extensively worked. The Great Cobar copper-mine is the most important in the state, and there are a number of successful gold-mines. In addition to the mining, the district produces large quantities of wool. Cobar is a municipality, as also is the adjacent township of Gladstone, with a mining population.

COBB, HOWELL (1815-1868), American political leader, was born at Cherry Hill, Jefferson county, Georgia, on the 7th of September 1815. He graduated from Franklin College (University of Georgia) in 1834, and two years later was admitted to the bar. From 1837 to 1840 he was solicitor-general for the western circuit of his state; from 1843 to 1851 and from 1855 to 1857 he was a member of the National House of Representatives, becoming Democratic leader in that body in 1847, and serving as speaker in 1849-1851; from 1851 to 1853 he was governor of his state; and from March 1857 to December 1860 he was secretary of the treasury in President Buchanan's cabinet. He was president of the convention of the seceded states which drafted a constitution for the Confederacy. In 1861 he was appointed colonel of a regiment and two years later was made a major-general. He died in New York on the 9th of October 1868. He sided with President Jackson on the question of nullification; was an efficient supporter of President Polk's administration during the Mexican War; and was an ardent advocate of slavery extension into the Territories, but when the Compromise of 1850 had been agreed upon he became its staunch supporter as a Union Democrat, and on that issue was elected governor of Georgia by a large majority. In 1860, however, he ceased to be a Unionist, and became a leader of the secession movement. From the close of the war until his death he vigorously opposed the Reconstruction Acts.

COBBETT, WILLIAM (1766-1835), English politician and writer, was born near Farnham in Surrey, according to his own statement, on the 9th of March 1766. He was the grandson of a farm-labourer, and the son of a small farmer; and during his early life he worked on his father's farm. At the age of sixteen, inspired with patriotic feeling by the sight of the men-of-war in Portsmouth harbour, he thought of becoming a sailor; and in May 1783, having, while on his way to Guildford fair, met the London coach, he suddenly resolved to accompany it to its destination. He arrived at Ludgate Hill with exactly half-a-crown in his pocket, but an old gentleman who had travelled with him invited him to his house, and obtained for him the situation of copying clerk in an attorney's office. He greatly disliked his new occupation; and rejecting all his father's entreaties that he would return home, he went down to Chatham early in 1784 with the intention of joining the marines. By some mistake, however, he was enlisted in a regiment of the line, which rather more than a year after proceeded to St John's, New Brunswick. All his leisure time during the months he remained at Chatham was devoted to reading the contents of the circulating library of the town, and getting up by heart Lowth's *English Grammar*. His uniform good conduct, and the power of writing correctly which he had acquired, quickly raised him to the rank of corporal, from which, without passing through the intermediate grade of sergeant, he was promoted to that of sergeant-major. In

November 1791 he was discharged at his own request, and received the official thanks of the major and the general who signed his discharge. In February 1792 Cobbett married the daughter of a sergeant-major of artillery, whom he had met some years before in New Brunswick. But his liberty was threatened in consequence of his bringing a charge of perulation against certain officers in his old regiment, and he went over to France in March, where he studied the language and literature. In his absence, the inquiry into his charges ended in an acquittal.

In September he crossed to the United States, and supported himself at Wilmington, Delaware, by teaching English to French emigrants. Among these was Talleyrand, who employed him, according to Cobbett's story, not because he was ignorant of English, but because he wished to purchase his pen. Cobbett made his first literary sensation by his *Observations on the Emigration of a Martyr to the Cause of Liberty*, a clever retort on Dr Priestley, who had just landed in America complaining of the treatment he had received in England. This pamphlet was followed by a number of papers, signed "Peter Porcupine," and entitled *Prospect from the Congress Gallery*, the *Political Censor* and the *Porcupine's Gazette*. In the spring of 1796, having quarrelled with his publisher, he set up in Philadelphia as bookseller and publisher of his own works. On the day of opening, his windows were filled with prints of the most extravagant of the French Revolutionists and of the founders of the American Republic placed side by side, along with portraits of George III., the British ministers, and any one else he could find likely to be obnoxious to the people; and he continued to pour forth praises of Great Britain and scorn of the institutions of the United States, with special abuse of the French party. Abuse and threats were of course in turn showered upon him, and in August 1797, for one of his attacks on Spain, he was prosecuted, though unsuccessfully, by the Spanish ambassador. Immediately on this he was taken up for libels upon American statesmen, and bound in recognizances to the amount of \$4,000, and shortly after he was prosecuted a third time for saying that Dr Benjamin Rush, who was much addicted to blood-letting, killed nearly all the patients he attended. The trial was repeatedly deferred, and was not settled till the end of 1799, when he was fined \$3,000. After this last misfortune, for a few months Cobbett carried on a newspaper called the *Rusksight*; but in June 1800 he set sail for England.

At home he found himself regarded as the champion of order and monarchy. Windham invited him to dinner, introduced him to Pitt, and begged him to accept a share in the *True Briton*. He refused the offer and joined an old friend, John Morgan, in opening a book shop in Pall Mall. For some time he published the *Porcupine's Gazette*, which was followed in January 1802 by the *Weekly Political Register*. In 1801 appeared his *Letters to Lord Hawkebury* (afterwards earl of Liverpool) and his *Letters to the Rt. Hon. Henry Addington*, in opposition to the proposed peace of Amiens. On the conclusion of the peace (1802) Cobbett made a still bolder protest; he determined to take no part in the general illumination, and—assisted by the sympathy of his wife, who, being in delicate health, removed to the house of a friend—he carried out his resolve, allowing his windows to be smashed and his door broken open by the angry mob. The letters to Addington are among the most polished and dignified of Cobbett's writings; but by 1803 he was once more revelling in personalities. The government of Ireland was singled out for wholesale attack; and a letter published in the *Register* remarked of Hardwicke, the lord-lieutenant, that the appointment was like setting the surgeon's apprentice to bleed the pauper patient. For this, though not a word had been uttered against Hardwicke's character, Cobbett was fined £500; and two days after the conclusion of this trial a second commenced, at the suit of Plunkett, the solicitor-general for Ireland, which resulted in a similar fine. About this time he began to write in support of Radical views; and to cultivate the friendship of Sir Francis Burdett, from whom he received considerable sums of money, and other favours, for which he gave no very grateful return. In 1809 he was once more in the most serious trouble.

He had bitterly commented on the flogging of some militia, because their mutiny had been repressed and their sentence carried out by the aid of a body of German troops, and in consequence he was fined £1000 and imprisoned for two years. His indomitable vigour was never better displayed. He still continued to publish the *Register*, and to superintend the affairs of his farm; a hamper containing specimens of its produce and other provisions came to him every week; and he amused himself with the company of some of his children and with weekly letters from the rest. On his release a public dinner, presided over by Sir F. Burdett, was held in honour of the event. He returned to his farm at Botley in Hampshire, and continued in his old course, extending his influence by the publication of the *Tuopenny Trask*, which, not being periodical, escaped the newspaper stamp tax. Meanwhile, however, he had contracted debts to the amount of £34,000 (for it is said that, notwithstanding the aversion he publicly expressed to paper currency, he had carried on his business by the aid of accommodation bills to a very large amount); and early in 1817 he fled to the United States. But his pen was as active as ever; from Long Island his MS. for the *Register* was regularly sent to England; and it was here that he wrote his clear and interesting *English Grammar*, of which 10,000 copies were sold in a month.

His return to England was accompanied by his weakest exhibition—the exhuming and bringing over of the bones of Thomas Paine, whom he had once heartily abused, but on whom he now wrote a panegyric ode. Nobody paid any attention to the affair; the relics he offered were not purchased; and the bones were reinterred.

Cobbett's great aim was now to obtain a seat in the House of Commons. He calmly suggested that his friends should assist him by raising the sum of £5000; it would be much better, he said, than a meeting of 50,000 persons. He first offered himself for Coventry, but failed; in 1826 he was by a large number of votes last of the candidates for Preston; and in 1828 he could find no one to propose him for the office of common councillor. In 1830, that year of revolutions, he was prosecuted for inciting to rebellion, but the jury disagreed, and soon after, through the influence of one of his admirers, Mr Fielden, who was himself a candidate for Oldham, he was returned for that town. In the House his speeches were listened to with amused attention. His position is sufficiently marked by the sneer of Peel that he would attend to Mr Cobbett's observations exactly as if they had been those of a "respectable member"; and the only striking part of his career was his absurd motion that the king should be prayed to remove Sir Robert Peel's name from the list of the privy council, because of the change he had proposed in the currency in 1819. In 1834 Cobbett was again member for Oldham, but his health now began to give way, and in June 1835 he left London for his farm, where he died on the 16th of that month.

Cobbett's account of his home-life makes him appear singularly happy; his love and admiration of his wife never failed; and his education of his children seems to have been distinguished by great kindness, and by a good deal of healthy wisdom, mingled with the prejudices due to the peculiarities of his temper and circumstances. Cobbett's ruling characteristic was a sturdy egoism, which had in it something of the nobler element of self-respect. A firm will, a strong brain, feelings not over-sensitive, an intense love of fighting, a resolve to get on, in the sense of making himself a power in the world—these are the principal qualities which account for the success of his career. His opinions were the fruits of his emotions. It was enough for him to get a thorough grasp of one side of a question, about the other side he did not trouble himself; but he always firmly seizes the facts which make for his view, and expresses them with unflinching clearness. His argument, which is never subtle, has always the appearance of weight, however flimsy it may be in fact. His sarcasm is seldom polished or delicate, but usually rough, and often abusive, while coarse nicknames were his special delight. His style is admirably correct and always extremely forcible.

Cobbett's contributions to periodical literature occupy 100 volumes, twelve of which consist of the papers published at Philadelphia between 1794 and 1800, and the rest of the *Weekly Political Register*, which ended only with Cobbett's death (June 1835). An abridgment of these works, with notes, was published by his sons, John M. Cobbett and James P. Cobbett. Besides this he published *An Account of the Horrors of the French Revolution*, and a work tracing all these horrors to "the licentious politics and infidel philosophy of the present age" (both 1798); *A Year's Residence in the United States*; *Parliamentary History of England from the Norman Conquest to 1800* (1806); *Collage Economy*; *Roman History*; *French Grammar and English Grammar*, both in the form of letters; *Geographical Dictionary of England and Wales*; *History of the Regency and Reign of George IV.*, containing a defence of Queen Caroline, whose cause he warmly advocated (1830-1834); *Life of Andrew Jackson, President of the United States* (1834); *Legacy to Labourers*; *Legacy to Peel*; *Legacy to Parsons* (1835), an attack on the secular claims of the Established Church; *Doom of Tithes*; *Rural Riots* (1830; new ed. 1855), an account of his tours on horseback through England, full of admirable descriptive writing; *Advice to Young Men and Women*; *Cobbett's Corn* (1828); and *History of the Protestant Reformation in England and Ireland* (1824-1827), in which he defends the monasteries, Queen Mary and Bonner, and attacks the Reformation, Henry VIII., Elizabeth and all who helped to bring it about, with such vehemence that the work was translated into French and Italian, and extensively circulated among Roman Catholics.

In 1798 Cobbett published in America an account of his early life, under the title of *The Life and Adventures of Peter Porcupine*; and he left papers relating to his subsequent career. His life has been written by R. Huish (1835), E. Smith (1878), and E. I. Carlyle (1904). See also the annotated edition of the *Register* (1833).

COBBOLD, THOMAS SPENCER (1828-1886), English man of science, was born at Ipswich in 1828, a son of the Rev. Richard Cobbold (1797-1877), the author of the *History of Margaret Catchpole*. After graduating in medicine at Edinburgh in 1851, he was appointed lecturer on botany at St Mary's hospital, London, in 1857, and also on zoology and comparative anatomy at Middlesex hospital in 1861. From 1868 he acted as Swiney lecturer on geology at the British Museum until 1873, when he became professor of botany at the Royal Veterinary College, afterwards filling a chair of helminthology which was specially created for him at that institution. He died in London on the 20th of March 1886. His special subject was helminthology, particularly the worms parasitic in man and animals, and as a physician he gained a considerable reputation in the diagnosis of cases depending on the presence of such organisms. His numerous writings include *Entozoa* (1864); *Tapeworms* (1866); *Parasites* (1879); *Human Parasites* (1882); and *Parasites of Meat and Prepared Flesh Food* (1884).

COBDEN, RICHARD (1804-1865), English manufacturer and Radical politician, was born at a farmhouse called Dunford, near Midhurst, in Sussex, on the 3rd of June 1804. The family had been resident in that neighbourhood for many generations, occupied partly in trade and partly in agriculture. Formerly there had been in the town of Midhurst a small manufacture of hosiery with which the Cobdens were connected, though all trace of it had disappeared before the birth of Richard. His grandfather was a maltster in that town, an energetic and prosperous man, almost always the bailiff or chief magistrate, and taking rather a notable part in county matters. But his father, forsaking that trade, took to farming at an unpropitious time. He was amiable and kind-hearted, and greatly liked by his neighbours, but not a man of business habits, and he did not succeed in his farming enterprise. He died when his son Richard was a child, and the care of the family devolved upon the mother, who was a woman of strong sense and of great energy of character, and who, after her husband's death, left Dunford and returned to Midhurst.

The educational advantages of Richard Cobden were not very ample. There was a grammar school at Midhurst, which at one time had enjoyed considerable reputation, but which had fallen into decay. It was there that he had to pick up such rudiments of knowledge as formed his first equipment in life, but from his earliest years he was indefatigable in the work of self-cultivation. When fifteen or sixteen years of age he went to London to the warehouse of Messrs Partridge & Price, in Eastcheap, one of the partners being his uncle. His relative,

noting the lad's passionate addiction to study, solemnly warned him against indulging such a taste, as likely to prove a fatal obstacle to his success in commercial life. But the admonition was unheeded, for while unweariedly diligent in business, he was in his intervals of leisure a most assiduous student. During his residence in London he found access to the London Institution, and made ample use of its large and well-selected library.

When he was about twenty years of age he became a commercial traveller, and soon became eminently successful in his calling. But never content to sink into the mere trader, he sought to introduce among those he met on the "road" a higher tone of conversation than usually marks the commercial room, and there were many of his associates who, when he had attained eminence, recalled the discussions on political economy and kindred topics with which he was wont to enliven and elevate the travellers' table. In 1830 Cobden learnt that Messrs Fort, calico printers at Sabden, near Clitheroe, were about to retire from business, and he, with two other young men, Messrs Sheriff and Gillet, who were engaged in the same commercial house as himself, determined to make an effort to acquire the succession. They had, however, very little capital among them. But it may be taken as an illustration of the instinctive confidence which Cobden through life inspired in those with whom he came into contact, that Messrs Fort consented to leave to these untried young men a large portion of their capital in the business. Nor was their confidence misplaced. The new firm had soon three establishments,—one at Sabden, where the printing works were, one in London and one in Manchester for the sale of their goods. This last was under the direct management of Cobden, who, in 1830 or 1831, settled in the city with which his name became afterwards so closely associated. The success of this enterprise was decisive and rapid, and the "Cobden prints" soon became known through the country as of rare value both for excellence of material and beauty of design. There can be no doubt that if Cobden had been satisfied to devote all his energies to commercial life he might soon have attained to great opulence, for it is understood that his share in the profits of the business he had established amounted to from £8000 to £10,000 a year. But he had other tastes, which impelled him irresistibly to pursue those studies which, as Bacon says, "serve for delight, for ornament and for ability." Prentice, the historian of the Anti-Corn-Law League, who was then editor of the *Manchester Times*, describes how, in the year 1835, he received for publication in his paper a series of admirably written letters, under the signature of "Libra," discussing commercial and economical questions with rare ability. After some time he discovered that the author of these letters was Cobden, whose name was until then quite unknown to him.

In 1835 he published his first pamphlet, entitled *England, Ireland and America, by a Manchester Manufacturer*. It attracted great attention, and ran rapidly through several editions. It was marked by a breadth and boldness of views on political and social questions which betokened an original mind. In this production Cobden advocated the same principles of peace, non-intervention, retrenchment and free trade to which he continued faithful to the last day of his life. Immediately after the publication of this pamphlet, he paid a visit to the United States, landing in New York on the 7th of June 1835. He devoted about three months to this tour, passing rapidly through the seaboard states and the adjacent portion of Canada, and collecting as he went large stores of information respecting the condition, resources and prospects of the great western republic. Soon after his return to England he began to prepare another work for the press, which appeared towards the end of 1836, under the title of *Russia*. It was mainly designed to combat a wild outbreak of Russophobia which, under the inspiration of David Urquhart, was at that time taking possession of the public mind. But it contained also a bold indictment of the whole system of foreign policy then in vogue, founded on ideas as to the balance of power and the necessity of large armaments for the protection of commerce. While this pamphlet was in the press, delicate health obliged him to leave England, and for several months, at the end

of 1836 and the beginning of 1837, he travelled in Spain, Turkey and Egypt. During his visit to Egypt he had an interview with Mehemet Ali, of whose character as a reforming monarch he did not bring away a very favourable impression. He returned to England in April 1837. From that time Cobden became a conspicuous figure in Manchester, taking a leading part in the local politics of the town and district. Largely owing to his exertions, the Manchester Athenaeum was established, at the opening of which he was chosen to deliver the inaugural address. He became a member of the chamber of commerce, and soon infused new life into that body. He threw himself with great energy into the agitation which led to the incorporation of the city, and was elected one of its first aldermen. He began also to take a warm interest in the cause of popular education. Some of his first attempts in public speaking were at meetings which he convened at Manchester, Salford, Bolton, Rochdale and other adjacent towns, to advocate the establishment of British schools. It was while on a mission for this purpose to Rochdale that he first formed the acquaintance of John Bright, who afterwards became his distinguished coadjutor in the free-trade agitation. Nor was it long before his fitness for parliamentary life was recognized by his friends. In 1837, the death of William IV. and the accession of Queen Victoria led to a general election. Cobden was candidate for Stockport, but was defeated, though not by a large majority.

In 1838 an anti-Corn-Law association was formed at Manchester, which, on his suggestion, was afterwards changed into a national association, under the title of the Anti-Corn-Law League (see CORN LAWS). Of that famous association Cobden was from first to last the presiding genius and the animating soul. During the seven years between the formation of the league and its final triumph, he devoted himself wholly to the work of promulgating his economic doctrines. His labours were as various as they were incessant—now guiding the councils of the league, now addressing crowded and enthusiastic meetings of his supporters in London or the large towns of England and Scotland, now invading the agricultural districts and challenging the landlords to meet him in the presence of their own farmers, to discuss the question in dispute, and now encountering the Chartists, led by Feargus O'Connor. But whatever was the character of his audience he never failed, by the clearness of his statements, the force of his reasoning and the felicity of his illustrations, to make a deep impression on the minds of his hearers.

In 1841, Sir Robert Peel having defeated the Melbourne ministry in parliament, there was a general election, when Cobden was returned for Stockport. His opponents had confidently predicted that he would fail utterly in the House of Commons. He did not wait long, after his admission into that assembly, in bringing their predictions to the test. Parliament met on the 19th of August. On the 24th, in course of the debate on the Address, Cobden delivered his first speech. "It was remarked," says Miss Martineau, in her *History of the Peace*, "that he was not treated in the House with the courtesy usually accorded to a new member, and it was perceived that he did not need such observance." With perfect self-possession, which was not disturbed by the jeers that greeted some of his statements, and with the utmost simplicity, directness and force, he presented the argument against the corn-laws in such a form as startled his audience, and also irritated some of them, for it was a style of eloquence very unlike the conventional style which prevailed in parliament.

From that day he became an acknowledged power in the House, and though addressing a most unfriendly audience, he compelled attention by his thorough mastery of his subject, and by the courageous boldness with which he charged the ranks of his adversaries. He soon came to be recognized as one of the foremost debaters on those economical and commercial questions which at that time so much occupied the attention of parliament; and the most prejudiced and bitter of his opponents were fain to acknowledge that they had to deal with a man whom the most practised and powerful orators of their party found it hard to cope with, and to whose eloquence, indeed, the great statesman

in whom they put their trust was obliged ultimately to surrender. On the 17th of February 1843 an extraordinary scene took place in the House of Commons. Cobden had spoken with great fervour of the deplorable suffering and distress which at that time prevailed in the country, for which, he added, he held Sir Robert Peel, as the head of the government, responsible. This remark, when it was spoken, passed unnoticed, being indeed nothing more than one of the commonplaces of party warfare. But a few weeks before, Mr Drummond, who was Sir Robert Peel's private secretary, had been shot dead in the street by a lunatic. In consequence of this, and the manifold anxieties of the time with which he was harassed, the mind of the great statesman was no doubt in a moody and morbid condition, and when he arose to speak later in the evening, he referred in excited and agitated tones to the remark, as an incitement to violence against his person. Sir Robert Peel's party, catching at this hint, threw themselves into a frantic state of excitement, and when Cobden attempted to explain that he meant official, not personal responsibility, they drowned his voice with clamorous and insulting shouts. But Peel lived to make ample and honourable amend for this unfortunate ebullition, for not only did he "fully and unequivocally withdraw the imputation which was thrown out in the heat of debate under an erroneous impression," but when the great free-trade battle had been won, he took the wreath of victory from his own brow, and placed it on that of his old opponent, in the following graceful words:—"The name which ought to be, and will be associated with the success of these measures, is not mine, or that of the noble Lord (Russell), but the name of one who, acting I believe from pure and disinterested motives, has, with untiring energy, made appeals to our reason, and has enforced those appeals with an eloquence the more to be admired because it was unaffected and unadorned; the name which ought to be chiefly associated with the success of these measures is the name of Richard Cobden." Cobden had, indeed, with unexampled devotion, sacrificed his business, his domestic comforts and for a time his health to the public interests. His friends therefore felt, at the close of that long campaign, that the nation owed him some substantial token of gratitude and admiration for those sacrifices. No sooner was the idea of such a tribute started than liberal contributions came from all quarters, which enabled his friends to present him with a sum of £80,000. Had he been inspired with personal ambition, he might have entered upon the race of political advancement with the prospect of attaining the highest official prizes. Lord John Russell, who, soon after the repeal of the corn laws, succeeded Sir Robert Peel as first minister, invited Cobden to join his government. But he preferred keeping himself at liberty to serve his countrymen unhackled by official ties, and declined the invitation. He withdrew for a time from England. His first intention was to seek complete seclusion in Egypt or Italy, to recover health and strength after his long and exhausting labours. But his fame had gone forth throughout Europe, and intimations reached him from many quarters that his voice would be listened to everywhere with favour, in advocacy of the doctrines to the triumph of which he had so much contributed at home. Writing to a friend in July 1846, he says—"I am going to tell you of a fresh project that has been brewing in my brain. I have given up all idea of burying myself in Egypt or Italy. I am going on an agitating tour through the continent of Europe." Then, referring to messages he had received from influential persons in France, Prussia, Austria, Russia and Spain to the effect mentioned above, he adds:—"Well, I will, with God's assistance during the next twelve months, visit all the large states of Europe, see their potentates or statesmen, and endeavour to enforce those truths which have been irresistible at home. Why should I rust in inactivity? If the public spirit of my countrymen affords me the means of travelling as their missionary, I will be the first ambassador from the people of this country to the nations of the continent. I am impelled to this by an instinctive emotion such as has never deceived me. I feel that I could succeed in making out a stronger case for the prohibitive nations of Europe to compel them to adopt a freer system than

I had here to overturn our protection policy." This programme he fulfilled. He visited in succession France, Spain, Italy, Germany and Russia. He was received everywhere with marks of distinction and honour. In many of the principal capitals he was invited to public banquets, which afforded him an opportunity of propagating those principles of which he was regarded as the apostle. But beside these public demonstrations he sought and found access in private to many of the leading statesmen, in the various countries he visited, with a view to indoctrinate them with the same principles. During his absence there was a general election, and he was returned (1847) for Stockport and for the West Riding of Yorkshire. He chose to sit for the latter.

When Cobden returned from the continent he addressed himself to what seemed to him the logical complement of free trade, namely, the promotion of peace and the reduction of naval and military armaments. His abhorrence of war amounted to a passion. Throughout his long labours in behalf of unrestricted commerce he never lost sight of this, as being the most precious result of the work in which he was engaged,—its tendency to diminish the hazards of war and to bring the nations of the world into closer and more lasting relations of peace and friendship with each other. He was not deterred by the fear of ridicule or the reproach of Utopianism from associating himself openly, and with all the ardour of his nature, with the peace party in England. In 1849 he brought forward a proposal in parliament in favour of international arbitration, and in 1851 a motion for mutual reduction of armaments. He was not successful in either case, not did he expect to be. In pursuance of the same object, he identified himself with a series of remarkable peace congresses—international assemblies designed to unite the intelligence and philanthropy of the nations of Christendom in a league against war—which from 1848 to 1851 were held successively in Brussels, Paris, Frankfort, London, Manchester and Edinburgh.

On the establishment of the French empire in 1851-1852 a violent panic took possession of the public mind. The press promulgated the wildest alarms as to the intentions of Louis Napoleon, who was represented as contemplating a sudden and piratical descent upon the English coast without pretext or provocation. By a series of powerful speeches in and out of parliament, and by the publication of his masterly pamphlet, *1793 and 1853*, Cobden sought to calm the passions of his countrymen. By this course he sacrificed the great popularity he had won as the champion of free trade, and became for a time the best-abused man in England. Immediately afterwards, owing to the quarrel about the Holy Places which arose in the east of Europe, public opinion suddenly veered round, and all the suspicion and hatred which had been directed against the emperor of the French were diverted from him to the emperor of Russia. Louis Napoleon was taken into favour as England's faithful ally, and in a whirlwind of popular excitement the nation was swept into the Crimean War. Cobden, who had travelled in Turkey, and had studied the condition of that country with great care for many years, discredited the outcry about maintaining the independence and integrity of the Ottoman empire which was the battle-cry of the day. He denied that it was possible to maintain them, and no less strenuously denied that it was desirable even if it were possible. He believed that the jealousy of Russian aggrandizement and the dread of Russian power were absurd exaggerations. He maintained that the future of European Turkey was in the hands of the Christian population, and that it would have been wiser for England to ally herself with them rather than with the doomed and decaying Mahomedan power. "You must address yourselves," he said in the House of Commons, "as men of sense and men of energy, to the question—what are you to do with the Christian population? for Mahomedanism cannot be maintained, and I should be sorry to see this country fighting for the maintenance of Mahomedanism. . . . You may keep Turkey on the map of Europe, you may call the country by the name of Turkey if you like, but do not think you can keep up the Mahomedan rule in the country." The torrent of popular sentiment in favour of war

was, however, irresistible; and Cobden and Bright were overwhelmed with obloquy.

At the beginning of 1857 tidings from China reached England of a rupture between the British plenipotentiary in that country and the governor of the Canton provinces in reference to a small vessel or lorch called the "Arrow," which had resulted in the English admiral destroying the river forts, burning 23 ships belonging to the Chinese navy and bombarding the city of Canton. After a careful investigation of the official documents, Cobden became convinced that those were utterly unrighteous proceedings. He brought forward a motion in parliament to this effect, which led to a long and memorable debate, lasting over four nights, in which he was supported by Sydney Herbert, Sir James Graham, Gladstone, Lord John Russell and Disraeli, and which ended in the defeat of Lord Palmerston by a majority of sixteen. But this triumph cost him his seat in parliament. On the dissolution which followed Lord Palmerston's defeat, Cobden became candidate for Huddersfield, but the voters of that town gave the preference to his opponent, who had supported the Russian War and approved of the proceedings at Canton. Cobden was thus relegated to private life, and retiring to his country house at Dunford, he spent his time in perfect contentment in cultivating his land and feeding his pigs.

He took advantage of this season of leisure to pay another visit to the United States. During his absence the general election of 1859 occurred, when he was returned unopposed for Rochdale. Lord Palmerston was again prime minister, and having discovered that the advanced liberal party was not so easily "crushed" as he had apprehended, he made overtures of reconciliation, and invited Cobden and Milner Gibson to become members of his government. In a frank, cordial letter which was delivered to Cobden on his landing in Liverpool, Lord Palmerston offered him the presidency of the Board of Trade, with a seat in the Cabinet. Many of his friends urgently pressed him to accept; but without a moment's hesitation he determined to decline the proposed honour. On his arrival in London he called on Lord Palmerston, and with the utmost frankness told him that he had opposed and denounced him so frequently in public, and that he still differed so widely from his views, especially on questions of foreign policy, that he could not, without doing violence to his own sense of duty and consistency, serve under him as minister. Lord Palmerston tried good-humouredly to combat his objections, but without success.

But though he declined to share the responsibility of Lord Palmerston's administration, he was willing to act as its representative in promoting freer commercial intercourse between England and France. But the negotiations for this purpose originated with himself in conjunction with Bright and Michel Chevalier. Towards the close of 1859 he called upon Lord Palmerston, Lord John Russell and Gladstone, and signified his intention to visit France and get into communication with the emperor and his ministers, with a view to promote this object. These statesmen expressed in general terms their approval of his purpose, but he went entirely on his own account, clothed at first with no official authority. On his arrival in Paris he had a long audience with Napoleon, in which he urged many arguments in favour of removing those obstacles which prevented the two countries from being brought into closer dependence on one another, and he succeeded in making a considerable impression on his mind in favour of free trade. He then addressed himself to the French ministers, and had much earnest conversation, especially with Rouher, whom he found well inclined to the economical and commercial principles which he advocated. After a good deal of time spent in these preliminary and unofficial negotiations, the question of a treaty of commerce between the two countries having entered into the arena of diplomacy, Cobden was requested by the British government to act as their plenipotentiary in the matter in conjunction with Lord Cowley, their ambassador in France. But it proved a very long and laborious undertaking. He had to contend with the bitter hostility of the French protectionists, which occasioned a good deal of vacillation on the part of the emperor and his ministers. There were also delays,

hesitations and cavils at home, which were more inexplicable. He was, moreover, assailed with great violence by a powerful section of the English press, while the large number of minute details with which he had to deal in connexion with proposed changes in the French tariff, involved a tax on his patience and industry which would have daunted a less resolute man. But there was one source of embarrassment greater than all the rest. One strong motive which had impelled him to engage in this enterprise was his anxious desire to establish more friendly relations between England and France, and to dispel those feelings of mutual jealousy and alarm which were so frequently breaking forth and jeopardizing peace between the two countries. This was the most powerful argument with which he had plied the emperor and the members of the French government, and which he had found most efficacious with them. But while he was in the midst of the negotiations, Lord Palmerston brought forward in the House of Commons a measure for fortifying the naval arsenals of England, which he introduced in a warlike speech pointedly directed against France, as the source of danger of invasion and attack, against which it was necessary to guard. This produced irritation and resentment in Paris, and but for the influence which Cobden had acquired, and the perfect trust reposed in his sincerity, the negotiations would probably have been altogether wrecked. At last, however, after nearly twelve months' incessant labour, the work was completed in November 1860. "Rare," said Mr Gladstone, "is the privilege of any man who, having fourteen years ago rendered to his country one signal service, now again, within the same brief span of life, decorated neither by land nor title, bearing no mark to distinguish him from the people he loves, has been permitted to perform another great and memorable service to his sovereign and his country."

On the conclusion of this work honours were offered to Cobden by the governments of both the countries which he had so greatly benefited. Lord Palmerston offered him a baronetcy and a seat in the privy council, and the emperor of the French would gladly have conferred upon him some distinguished mark of his favour. But with characteristic disinterestedness and modesty he declined all such honours.

Cobden's efforts in furtherance of free trade were always subordinated to what he deemed the highest moral purposes—the promotion of peace on earth and goodwill among men. This was his desire and hope as respects the commercial treaty with France. He was therefore deeply disappointed and distressed to find the old feeling of distrust still actively fomented by the press and some of the leading politicians of the country. In 1862 he published his pamphlet entitled *The Three Panics*, the object of which was to trace the history and expose the folly of those periodical visitations of alarm as to French designs with which England had been afflicted for the preceding fifteen or sixteen years.

When the Civil War threatened to break out in the United States, Cobden was deeply distressed. But after the conflict became inevitable his sympathies were wholly with the North, because the South was fighting for slavery. His great anxiety, however, was that the British nation should not be committed to any unworthy course during the progress of that struggle. And when relations with America were becoming critical and menacing in consequence of the depredations committed on American commerce by vessels issuing from British ports, he brought the question before the House of Commons in a series of speeches of rare clearness and force.

For several years Cobden had been suffering severely at intervals from bronchial irritation and a difficulty of breathing. Owing to this he had spent the winter of 1860 in Algeria, and every subsequent winter he had to be very careful and confine himself to the house, especially in damp and foggy weather. In November 1864 he went down to Rochdale and delivered a speech to his constituents—the last he ever delivered. That effort was followed by great physical prostration, and he determined not to quit his retirement at Midhurst until spring had fairly set in. But in the month of March there were discussions

in the House of Commons on the alleged necessity of constructing large defensive works in Canada. He was deeply impressed with the folly of such a project, and he was seized with a strong desire to go up to London and deliver his sentiments on the subject. He left home on the 21st of March, and caught a chill. He recovered a little for a few days after his arrival in London; but on the 29th there was a relapse, and on the 2nd of April 1865 he expired peacefully at his apartments in Suffolk Street.

On the following day there was a remarkable scene in the House of Commons. When the clerk read the orders of the day Lord Palmerston rose, and in impressive and solemn tones declared "it was not possible for the House to proceed to business without every member recalling to his mind the great loss which the House and country had sustained by the event which took place yesterday morning." He then paid a generous tribute to the virtues, the abilities and services of Cobden, and he was followed by Disraeli, who with great force and felicity of language delineated the character of the deceased statesman, who, he said, "was an ornament to the House of Commons and an honour to England." Bright also attempted to address the House, but, after a sentence or two delivered in a tremulous voice, he was overpowered with emotion, and declared he must leave to a calmer moment what he had to say on the life and character of the manliest and gentlest spirit that ever quitted or tenanted a human form.

In the French Corps Législatif, also, the vice-president, Forçade la Roquette, referred to his death, and warm expressions of esteem were repeated and applauded on every side. "The death of Richard Cobden," said M. la Roquette, "is not alone a misfortune for England, but a cause of mourning for France and humanity." Drouyn de Lhuys, the French minister of foreign affairs, made his death the subject of a special despatch, desiring the French ambassador to express to the government "the mournful sympathy and truly national regret which the death, as lamented as premature, of Richard Cobden had excited on that side of the Channel." "He is above all," he added, "in our eyes the representative of those sentiments and those cosmopolitan principles before which national frontiers and rivalries disappear; whilst essentially of his country, he was still more of his time; he knew what mutual relations could accomplish in our day for the prosperity of peoples. Cobden, if I may be permitted to say so, was an international man."

He was buried at West Lavington church, on the 7th of April. His grave was surrounded by a large crowd of mourners, among whom were Gladstone, Bright, Milner Gibson, Charles Villiers and a host besides from all parts of the country. In 1866 the Cobden Club was founded in London, to promote free-trade economics, and it became a centre for political propaganda on those lines; and prizes were instituted in his name at Oxford and Cambridge.

Cobden had married in 1840 Miss Catherine Anne Williams, a Welsh lady, and left five surviving daughters, of whom Mrs Cobden-Unwin (wife of the publisher Mr Fisher Unwin), Mrs Walter Sickert (wife of the painter) and Mrs Cobden-Sanderson (wife of the well-known artist in bookbinding), afterwards became prominent in various spheres, and inherited their father's political interest. His only son died, to Cobden's inexpressible grief, at the age of fifteen, in 1856.

The work of Cobden, and what is now called "Cobdenism," has in recent years been subjected to much criticism from the newer school of English economists who advocate a "national policy" (on the old lines of Alexander Hamilton and Friedrich List) as against his cosmopolitan ideals. But it remains the fact that his success with the free-trade movement was for years unchallenged, and that the leaps and bounds with which English commercial prosperity advanced after the repeal of the corn-laws were naturally associated with the reformed fiscal policy, so that the very name of protectionism came to be identified with all that was not merely heterodox but hateful. The tariff reform movement in England started by Mr Chamberlain (*q.v.*) had the result of giving new boldness to the opponents of Manchesterism, and the whole subject once more became controversial (see

FREE TRADE; CORN LAWS; PROTECTION; TARIFF; ECONOMICS). Cobden has left a deep mark on English history, but he was not himself a "scientific economist," and many of his confident prophecies were completely falsified. As a manufacturer, and with the circumstances of his own day before him, he considered that it was "natural" for Great Britain to manufacture for the world in exchange for her free admission of the more "natural" agricultural products of other countries. He advocated the repeal of the corn-laws, not essentially in order to make food cheaper, but because it would develop industry and enable the manufacturers to get labour at low but sufficient wages; and he assumed that other countries would be unable to compete with England in manufactures under free trade, at the prices which would be possible for English manufactured products. "We advocate," he said, "nothing but what is agreeable to the highest behests of Christianity—to buy in the cheapest market, and sell in the dearest." He believed that the rest of the world must follow England's example: "if you abolish the corn-laws honestly, and adopt free trade in its simplicity, there will not be a tariff in Europe that will not be changed in less than five years" (January 1846). His cosmopolitanism—which makes him in the modern Imperialist's eyes a "Little Englander" of the strictest sect—led him to deplore any survival of the colonial system and to hail the removal of ties which bound the mother country to remote dependencies; but it was, in its day, a generous and sincere reaction against popular sentiment, and Cobden was at all events an outspoken advocate of an irresistible British navy. There were enough inconsistencies in his creed to enable both sides in the recent controversies to claim him as one who if he were still alive would have supported their case in the altered circumstances; but, from the biographical point of view, these issues are hardly relevant. Cobden inevitably stands for "Cobdenism," which is a creed largely developed by the modern free-trader in the course of subsequent years. It becomes equivalent to economic *laissez-faire* and "Manchesterism," and as such it must fight its own corner with those who now take into consideration many national factors which had no place in the early utilitarian individualistic régime of Cobden's own day.

The standard biography is that by John Morley (1881). Cobden's speeches were collected and published in 1870. The centenary of his birth in 1904 was celebrated by a flood of articles in the newspapers and magazines, naturally coloured by the new controversy in England over the Tariff Reform movement.

COBET, CAREL GABRIEL (1813–1889), Dutch classical scholar, was born at Paris on the 28th of November 1813, and educated at the Hague Gymnasium and the university of Leiden. In 1836 he won a gold medal for an essay entitled *Prosopographia Xenophontica*, a brilliant characterization of all the persons introduced into the *Memorabilia*, *Symposium* and *Oeconomicus* of Xenophon. His *Observationes criticae in Platonis comici reliquias* (1840) revealed his remarkable critical faculty. The university conferred on him an honorary degree, and recommended him to the government for a travelling pension. The ostensible purpose of his journey was to collate the texts of Simplicius, which, however, engaged but little of his time. He contrived, however, to make a careful study of almost every Greek manuscript in the Italian libraries, and returned after five years with an intimate knowledge of palaeography. In 1846 he married, and in the same year was appointed to an extraordinary professorship at Leiden. His inaugural address, *De Arte interpretandi Grammaticas et Criticas Fundamentis innixa*, has been called the most perfect piece of Latin prose written in the 19th century. The rest of his life was passed uneventfully at Leiden. In 1856 he became joint editor of *Mnemossyne*, a philological review, which he soon raised to a leading position among classical journals. He contributed to it many critical notes and emendations, which were afterwards collected in book form under the titles *Novae Lectiones*, *Variae Lectiones* and *Miscellanea Critica*. In 1875 he took a prominent part at the Leiden Tercentenary, and impressed all his hearers by his wonderful facility in Latin improvisation. In 1884, when his health was failing, he retired as emeritus professor. He died on the 26th of October 1889. Cobet's special weapon as a critic

was his consummate knowledge of palaeography, but he was no less distinguished for his rare acumen and wide knowledge of classical literature. He has been blamed for rashness in the emendation of difficult passages, and for neglecting the comments of other scholars. He had little sympathy for the German critics, and maintained that the best combination was English good sense with French taste. He always expressed his obligation to the English, saying that his masters were three Richards—Bentley, Porson and Dawes.

See an appreciative obituary notice by W. G. Rutherford in the *Classical Review*, Dec. 1889; Hartman in Bursian's *Biographisches Jahrbuch*, 1890; Sandys, *Hist. Class. Schol.* (1908), iii. 282.

COBHAM, a village in the Medway parliamentary division of Kent, England, 4 m. W. of Rochester. The church (Early English and later, and restored by Sir G. G. Scott) is famous for its collection of ancient brasses, of which thirteen belonging to the years 1320–1529 commemorate members of the Brooke and Cobham families. There are some fine oak stalls and some tilting armour of the 14th century in the chancel. Cobham college, containing 20 almshouses, took the place, after the dissolution, of a college for priests founded by Sir John de Cobham in the 14th century. The present mansion of Cobham Hall is mainly Elizabethan. The picture gallery contains a fine collection of works by the great masters, Italian, Dutch and English.

The Cobham family was established here before the reign of King John. In 1313 Henry de Cobham was created Baron Cobham, but on the execution of Sir John Oldcastle (who had been summoned to parliament, *jure uxoris*, as Baron Cobham) in 1417, the barony lay dormant till revived in 1445 by Edward, son of Sir Thomas Brooke and Joan, grand-daughter of the 3rd Baron Cobham. In 1603 Henry Brooke, Lord Cobham, was arraigned for participation in the Raleigh conspiracy, and spent the remainder of his life in prison, where he died in 1618. With him the title expired, and Cobham Hall was granted to Lodowick Stewart, duke of Lennox, passing subsequently by descent and marriage to the earls of Darnley. The present Viscount Cobham (cr. 1718) belongs to the Lyttelton family (see **LYTTELTON**, 1ST BARON).

COBIJA, or **PUERTO LA MAR** (the official title given to it by the Bolivian government), a port and town of the Chilean province of Antofagasta, about 800 m. N. of Valparaiso. It is the oldest port on this part of the coast, and was for a time the principal outlet for a large mining district. It was formerly capital of the Bolivian department of Atacama and the only port possessed by Bolivia, but the seizure of that department in 1879 by Chile and the construction of the Antofagasta and Oruro railway deprived it of all importance, and its population, estimated at 6000 in 1858, has fallen to less than 500. Its harbour is comparatively safe but lacks landing facilities. Smelting for neighbouring mines is still carried on, and some of its former trade remains, but the greater part of it has gone to Tocopilla and Antofagasta. The town occupies a narrow beach between the sea and bluffs, and was greatly damaged by an earthquake and tidal wave in 1877.

COBLE (probably of Celtic origin, and connected with the root *ceu* or *cau*, hollow; cf. Welsh *ceubol*, a ferry-boat), a flat-bottomed fishing-boat, with deep-lying rudder and lug-sail, used off the north-east coast of England.

COBLENZ (**KOBLENZ**), a city and fortress of Germany, capital of the Prussian Rhine Province, 57 m. S.E. from Cologne by rail, pleasantly situated on the left bank of the Rhine at its confluence with the Mosel, from which circumstance it derived its ancient name *Confluentes*, of which Coblenz is a corruption. Pop. (1885) 31,669; (1905) 53,902. Its defensive works are extensive, and consist of strong modern forts crowning the hills encircling the town on the west, and of the citadel of Ehrenbreitstein (*q.v.*) on the opposite bank of the Rhine. The old city was triangular in shape, two sides being bounded by the Rhine and Mosel and the third by a line of fortifications. The last were razed in 1890, and the town was permitted to expand in this direction. Immediately outside the former walls lies the new central railway station, in which is effected a junction of the

Cologne-Mainz railway with the strategical line Metz-Berlin. The Rhine is crossed by a bridge of boats 485 yds. long, by an iron bridge built for railway purposes in 1864, and, a mile above the town, by a beautiful bridge of two wide and lofty spans carrying the Berlin railway referred to. The Mosel is spanned by a Gothic freestone bridge of 14 arches, erected in 1344, and also by a railway bridge.

The city, down to 1890, consisted of the Altstadt (old city) and the Neustadt (new city) or Klemenstadt. Of these, the Altstadt is closely built and has only a few fine streets and squares, while the Neustadt possesses numerous broad streets and a handsome frontage to the Rhine. In the more ancient part of Coblenz are several buildings which have an historical interest. Prominent among these, near the point of confluence of the rivers, is the church of St Castor, with four towers. The church was originally founded in 836 by Louis the Pious, but the present Romanesque building was completed in 1208, the Gothic vaulted roof dating from 1498. In front of the church of St Castor stands a fountain, erected by the French in 1812, with an inscription to commemorate Napoleon's invasion of Russia. Not long after, the Russian troops occupied Coblenz; and St Priest, their commander, added in irony these words—“*Vu et approuvé par nous, Commandant Russe de la Ville de Coblenz: Janvier 1er, 1814.*” In this quarter of the town, too, is the Liebfrauenkirche, a fine church (nave 1250, choir 1404–1431) with lofty late Romanesque towers; the castle of the electors of Trier, erected in 1280, which now contains the municipal picture gallery; and the family house of the Metternichs, where Prince Metternich, the Austrian statesman, was born in 1773. In the modern part of the town lies the palace (*Residenzschloss*), with one front looking towards the Rhine, the other into the Neustadt. It was built in 1778–1786 by Clement Wenceslaus the last elector of Trier, and contains among other curiosities some fine Gobelin tapestries. From its some pretty gardens and promenades (*Kaiserin Augusta Anlagen*) stretch along the bank of the Rhine, and in them is a memorial to the poet Max von Schenkendorf. A fine statue to the empress Augusta, whose favourite residence was Coblenz, stands in the Luisen-platz. But of all public memorials the most striking is the colossal equestrian statue of the emperor William I., erected by the Rhine provinces in 1897, standing on a lofty and massive pedestal, at the point where the Rhine and Mosel meet. Coblenz has also handsome law courts, government buildings, a theatre, a museum of antiquities, a conservatory of music, two high grade schools, a hospital and numerous charitable institutions. Coblenz is a principal seat of the Mosel and Rhenish wine trade, and also does a large business in the export of mineral waters. Its manufactures include pianos, paper, cardboard, machinery, boats and barges. It is an important transit centre for the Rhine railways and for the Rhine navigation.

Coblenz (*Confluentes*, *Covelenz*, *Cobelenz*) was one of the military posts established by Drusus about 9 B.C. Later it was frequently the residence of the Frankish kings, and in 860 and 922 was the scene of ecclesiastical synods. At the former of these, held in the Liebfrauenkirche, took place the reconciliation of Louis the German with his half-brother Charles the Bald. In 1018 the city, after receiving a charter, was given by the emperor Henry II. to the archbishop of Trier (Treves), and it remained in the possession of the archbishop-electors till the close of the 18th century. In 1249–1254 it was surrounded with new walls by Archbishop Arnold II. (of Isenburg); and it was partly to overawe the turbulent townsmen that successive archbishops built and strengthened the fortress of Ehrenbreitstein (*q.v.*) that dominates the city. As a member of the league of the Rhenish cities which took its rise in the 13th century, Coblenz attained to great prosperity; and it continued to advance till the disasters of the Thirty Years' War occasioned a rapid decline. After Philip Christopher, elector of Trier, had surrendered Ehrenbreitstein to the French the town received an imperial garrison (1632), which was soon, however, expelled by the Swedes. They in their turn handed the city over to the French, but the imperial forces succeeded in retaking it by

storm (1636). In 1688 it was besieged by the French under Marshal de Boufflers, but they only succeeded in bombarding the Altstadt into ruins, destroying among other buildings the old merchants' hall (*Kaufhaus*), which was restored in its present form in 1725. In 1786 the elector of Trier, Clement Wenceslaus of Saxony, took up his residence in the town, and gave great assistance in its extension and improvement; a few years later it became, through the invitation of his minister, Ferdinand, Freiherr von Duminique, one of the principal rendezvous of the French *émigrés*. This drew down upon the archbishop-elect the wrath of the French republicans; in 1794 Coblenz was taken by the Revolutionary army under Marceau (who fell during the siege), and, after the peace of Lunéville, it was made the chief town of the Rhine and Mosel department (1798). In 1814 it was occupied by the Russians, by the congress of Vienna it was assigned to Prussia, and in 1822 it was made the seat of government of the Rhine province.

See Daniel, *Deutschland* (Leipzig, 1895); W. A. Günther, *Geschichte der Stadt Koblenz* (Cobl., 1815); and Bär, *Urkunden und Akten zur Geschichte der Verfassung und Verwaltung der Stadt Koblenz bis zum Jahre 1500* (Bonn, 1898).

COBOURG, the capital of Northumberland county, Ontario, Canada, on Lake Ontario and the Grand Trunk railway; 70 m. E.N.E. of Toronto. Pop. (1901) 4239. It has a large, safe harbour, and steamboat communication with St Lawrence and Lake Ontario ports. It contains car-works, foundries, and carpet and woollen factories, and is a summer resort, especially for Americans. Victoria University, formerly situated here, was removed to Toronto in 1890.

COBRA (*Naja tripudians*), a poisonous Colubrine snake, belonging to the family *Elapidae*, known also as the hooded snake, cobra di capello or *naga*. In this genus the anterior ribs are elongated, and by raising and bringing forward these, the neck can be expanded at will into a broad disk or hood. It

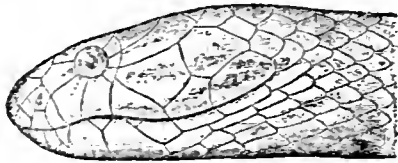

Head of Cobra.

possesses two rows of palatine teeth in the upper jaw, while the maxillary bones bear the fangs, of which the anterior one only is in connexion with the poison gland, the others in various stages of growth remaining loose in the surrounding flesh until the destruction of the poison fang brings the one immediately behind to the front, which then gets ankylosed to the maxillary bone, and into connexion with the gland secreting the poison, which in the cobra is about the size of an almond. Behind the poison fangs there are usually one or two ordinary teeth. The cobra attains a length of nearly 6 ft. and a girth of about 6 in.

The typical cobra is yellowish to dark-brown, with a black and white spectacle-mark on the back of the hood, and with a pair of large black and white spots on the corresponding under-surface. There are, however, many varieties, in some of which the spectacle markings on the hood are wanting. The cobra may be regarded as nocturnal in its habits, being most active by night, although not unfrequently found in motion during the day. It usually conceals itself under logs of wood, in the roofs of huts and in holes in old walls and ruins, where it is often come upon inadvertently, inflicting a death wound before it has been observed. It feeds on small quadrupeds, frogs, lizards, insects and the eggs of birds, in search of which it sometimes ascends trees. When seeking its prey it glides slowly along the ground, holding the anterior third of its body aloft, with its hood distended, on the alert for anything that may come in its way. "This attitude," says Sir J. Fayrer, "is very striking, and few objects are more calculated to inspire awe than a large cobra when, with his hood erect, hissing loudly and his eyes glaring, he prepares to strike." It is said to drink large quantities of water, although like reptiles in general it will live for many months without food or drink. The cobra is oviparous; and its eggs, which are from 18 to 25 in number, are of a pure white colour, somewhat resembling in

size and appearance the eggs of the pigeon, but sometimes larger. These it leaves to be hatched by the heat of the sun. It is widely distributed, from Transcaspia to China and to the Malay Islands, and is found in all parts of India, from Ceylon to the Himalayas up to about 8000 ft. above the level of the sea.

Closely allied is *N. haje*, the common hooded cobra of all Africa, the *Spy-slange*, i.e. spitting snake of the Boers.

The cobra is justly regarded as one of the most deadly of the Indian Thanatophidia. Many thousand deaths are caused annually by this unfortunately common species, but it is difficult to obtain accurate statistics. The bite of a vigorous cobra will often prove fatal in a few minutes, and as there is no practicable antidote to the poison, it is only in rare instances that such mechanical expedients as cauterizing, constriction or amputation can be applied with sufficient promptitude to prevent the virus from entering the circulation. Owing to a small reward offered by the Indian government for the head of each poisonous snake, great numbers of cobras have been destroyed; but only low-caste Hindus will engage in such work, the cobra being regarded by the natives generally with superstitious reverence, as a divinity powerful to injure, and therefore to be propitiated; and thus oftentimes when found in their dwellings this snake is allowed to remain, and is fed and protected. "Should fear," says Sir J. Fayrer, "and perhaps the death of some inmate bitten by accident, prove stronger than superstition, it may be caught, tenderly handled, and deported to some field, where it is released and allowed to depart in peace, not killed" (*Thanatophidia of India*). Great numbers, especially of young cobras, are killed by the adjutant birds and by the mungoos—a small mammal which attacks it with impunity, apparently not from want of susceptibility to the poison, but by its dexterity in eluding the bite of the cobra. Mere scratching or tearing does not appear to be sufficient to bring the poison from the glands; it is only when the fangs are firmly implanted by the jaws being pressed together that the virus enters the wound, and in those circumstances it has been shown by actual experiment that the mungoos, like all other warm-blooded animals, succumb to the poison. In the case of reptiles, the cobra poison takes effect much more slowly, while it has been proved to have no effect whatever on other venomous serpents.

In the Egyptian hieroglyphics the cobra occurs constantly with the body erect and hood expanded; its name was *ouro*, which signifies "king," and the animal appears in Greek literature as *ouraios* and *basiliscus*. With the Egyptian snake-charmers of the present day the cobra is as great a favourite as with their Hindu colleagues. They pretend to change the snake into a rod, and it appears that the supple snake is made stiff and rigid by a strong pressure upon its neck, and that the animal does not seem to suffer from this operation, but soon recovers from the cataleptic fit into which it has been temporarily thrown.

The cobra is the snake usually exhibited by the Indian jugglers, who show great dexterity in handling it, even when not deprived of its fangs. Usually, however, the front fang at least is extracted, the creature being thus rendered harmless until the succeeding tooth takes its place, and in many cases all the fangs, with the germs behind, are removed—the cobra being thus rendered innocuous for life. The snake charmer usually plays a few simple notes on the flute, and the cobra, apparently delighted, rears half its length in the air and sways its head and body about, keeping time to the music.

The cobra, like almost all poisonous snakes, is by no means aggressive, and when it gets timely warning of the approach of man endeavours to get out of his way. It is only when trampled upon inadvertently, or otherwise irritated, that it attempts to use its fangs. It is a good swimmer, often crossing broad rivers, and probably even narrow arms of the sea, for it has been met with at sea at least a quarter of a mile from land.

COBURG, a town of Germany, the twin capital with Gotha of the duchy of Saxe-Coburg-Gotha, on the left bank of the Itz, an affluent of the Regen, on the southern slope of the Frankenstein, the railway from Eisenach to Lichtenfels, and 40 m. S.S.E. of Gotha. Pop. (1905) 22,489. The town is for the most part

old, and contains a number of interesting buildings. The ducal palace, known as the Ehrenburg, is a magnificent building, originally erected on the site of a convent of bare-footed friars by Duke John Ernest in 1549, renovated in 1698, and restored in 1816 by Duke Ernest I. It contains a vast and richly decorated hall, the court church and a fine picture gallery. In the gardens are the mausoleum of Duke Francis (d. 1806) and his wife, a bronze equestrian statue of Duke Ernest II. and a fountain in commemoration of Duke Alfred (duke of Edinburgh). In the market square are the medieval Rathaus, the government buildings, and a statue of Prince Albert (consort of Queen Victoria), by William Theed the younger (1804-1891). In the Schloss-platz are the Edinburgh Palace (Palais Edinburg), built in 1881, the theatre and an equestrian statue of Duke Ernest I. Among the churches the most remarkable is the Moritzkirche, with a lofty tower. The educational establishments include a gymnasium, founded in 1604 by Duke John Casimir (d. 1633) and thus known as the Casimirianum, a commercial, an agricultural and other schools. The Zeughaus (armoury) contains the ducal library of 100,000 volumes, and among other public buildings may be mentioned the Augustenstift, formerly the seat of the ministerial offices, and the Marstall (royal mews). On a commanding eminence above the town is the ancient castle of Coburg, dating from the 11th century (see below). In 1781 it was turned into a penitentiary and lunatic asylum, but in 1835-1838 was completely restored, and now contains a natural history museum. The most interesting room in this building is that which was occupied by Luther in 1530, where the surroundings may have inspired, though (as is now proved) he did not compose, the famous hymn, *Ein' feste Burg ist unser Gott*; the bed on which he slept, and the pulpit from which he preached in the old chapel are shown. Coburg is a place of considerable industry, the chief branches of the latter being brewing, manufactures of machinery, colours and porcelain, iron-founding and saw-milling; and there is an important trade in the cattle reared in the neighbourhood. Among various places of interest in the vicinity are the ducal residences of Callenberg and Rosenau, in the latter of which Albert, Prince Consort, was born in 1819; the castle of Lauterburg; and the village of Neuses, with the house of the poet J. M. F. Rückert, who died here in 1866, and on the other side of the river the tomb of the poet Moritz August von Thümmel (1738-1817).

The town of Coburg, first mentioned in a record of 1207, owed its existence and its name to the castle, and in the 15th and 16th centuries was of considerable importance as a halting-place on the great trade route from Nuremberg *via* Bamberg to the North. In 1245 the castle became the seat of the elder branch of the counts of Henneberg (Coburg-Schmalkalden). The countships of Coburg and Schmalkalden passed by the marriage of Jutta, daughter of Hermann I. (d. 1290), to Otto V. of Brandenburg, whose grandson John, however, sold them to Henry VIII. of Henneberg, his brother-in-law. Henry's daughter Catherine (d. 1397) married Frederick III. of Meissen, and so brought the castle, town and countship into the possession of the Saxon house of Wettin. In 1549 Duke John Ernest of Saxony made Coburg his residence and turned the old castle into a fortress strong enough to stand a three years' siege (1632-1635) during the Thirty Years' War. In 1641 Coburg fell to the dukes of Saxe-Altenburg. In 1835 it became the residence of the dukes of Saxe-Coburg. For the princes of the house of Coburg see WETTIN and SAXE-COBURG.

COCA, or **CUCA** (*Erythroxylon coca*), a plant of the natural order Erythroxylaceae, the leaves of which are used as a stimulant in the western countries of South America.¹ It resembles a blackthorn bush, and grows to a height of 6 or 8 ft. The branches are straight, and the leaves, which have a lively green tint, are thin, opaque, oval, more or less tapering at the extremities.

¹ Garcilasso de la Vega, writing of the plant, says that it is called *cuca* by the Indians, *coca* by the Spaniards; and Father Blas Valera states that the leaves are called *cuca* both by Indians and Spaniards (*The Royal Commentaries of the Incas*, 1609-1617; trans. by C. R. Markham, Hakluyt Soc., 1871). See also, on the name *cuca*, Christison, *Brit. Med. Journ.*, April 29, 1876, p. 527.

A marked characteristic of the leaf is an areolated portion bounded by two longitudinal curved lines one on each side of the midrib, and more conspicuous on the under face of the leaf. Good samples of the dried leaves are uncurled, are of a deep green on the upper, and a grey-green on the lower surface, and have a strong tea-like odour; when chewed they produce a sense of warmth in the mouth, and have a pleasant, pungent taste. Bad specimens have a camphoraceous smell and a brownish colour, and lack the pungent taste. The flowers are small, and disposed in little clusters on short stalks; the corolla is composed of five yellowish-white petals, the anthers are heart-shaped, and the pistil consists of three carpels united to form a three-chambered ovary. The flowers are succeeded by red berries. The seeds are sown in December and January in small plots (*almacigas*) sheltered from the sun, and the young plants when from 1½ to 2 ft. in height are placed in holes (*aspi*), or, if the ground is level, in furrows (*uachos*) in carefully-weeded soil. The plants thrive best in hot, damp situations, such as the clearings of forests; but the leaves most preferred are obtained in drier localities, on the sides of hills. The leaves are gathered from plants varying in age from one and a half to upwards of forty years. They are considered ready for plucking when they break on being bent. The first and most abundant harvest is in March, after the rains; the second is at the end of June, the third in October or November. The green leaves (*matu*) are spread in thin layers on coarse woollen cloths and dried in the sun; they are then packed in sacks, which, in order to preserve the quality of the leaves, must be kept from damp.

In the Kew Bulletin for January 1889 is an account of the history and botany of the plant, which has been so long under cultivation in South America that its original home is doubtful. As the result of this cultivation numerous forms have arisen. The writer distinguishes from the typical Peruvian form with pointed leaves a variety *novo-granatense*, from New Granada, which has smaller leaves with a rounded apex. The plant is now cultivated in the West Indies, India, Ceylon, Java and elsewhere. It has been estimated that coca is used by about 8,000,000 of the human race, being consumed in Bolivia, Peru, Ecuador, Colombia and Rio Negro. In Peru the Indians carry a leathern pouch (the *chuspa* or *huallqui*) for the leaves, and a supply of pulverized unslaked lime, or a preparation of the ashes of the pulvino plant (*Chenopodium Quinoa*), called *llipta* or *lluda*. Three or four times a day labour is suspended for *chacchar* or *acullicar*, as the mastication of coca is termed. The leaves, deprived of their stalks, are chewed and formed into a ball (*acullico*) in the mouth; a small quantity of the lime or *llipta* is then applied to the *acullico* to give it a proper relish. Two or three ounces of coca are thus daily consumed by each Indian.

Coca was used by the Peruvian Indians in the most ancient times. It was employed as an offering to the sun, or to produce smoke at the great sacrifices; and the priests, it was believed, must chew it during the performance of religious ceremonies, otherwise the gods would not be propitiated. Coca is still held in superstitious veneration among the Peruvians, and is believed by the miners of Cerro de Pasco to soften the veins of ore, if masticated and thrown upon them.

The composition of different specimens of coca leaves is very inconstant. Besides the important alkaloid *cocaine* (*q.v.*), occurring to the extent of about 0.2% in fresh specimens, there are several other alkaloids. The preparations of coca leaves are incompatible with certain drugs which might often be prescribed in combination with them, such as salts of mercury, menthol and mineral acids, which latter decompose cocaine into benzoic acid and ecgonine.

Coca leaves and preparations of them have no external action. Internally their action is similar to that of opium, though somewhat less narcotic, and causing a dilatation of the pupil of the eye instead of a contraction. When masticated, the leaves first cause a tingling in the tongue and mucous membrane of the mouth, owing to a stimulation of the nerves of common sensation, and then abolish taste owing to a paralysis of the terminals of the gustatory nerves. They have a definite anaesthetic action

upon the mucous membrane of the stomach, from which there come in large part those organic sensations which we interpret as hunger. Hence it is possible, under the influence of coca, to go without food or consciousness of needing it, for as long a period as three days. The drug is not a food, however, as its composition and history in the body clearly show, and the individual who comfortably fasts under its influence nevertheless shows all the physical signs of starvation, such as loss of weight. In small doses coca stimulates the intestinal peristalsis and thus is an aperient, but in large doses it paralyzes the muscular coat of the bowel, causing constipation, such as is constantly seen in cocaine-maniacs, and in those inhabitants of Peru and the adjacent countries who take it in excess or are markedly susceptible to its influence.

The injection of coca leaves has a very remarkable effect upon the higher tracts of the nervous system—an effect curiously contrary to that produced by their chief ingredient upon the peripheral parts of the nervous apparatus. The mental power is, at any rate subjectively, enhanced in marked degree. In the absence of extended experiments in psychological laboratories, such as have been conducted with alcohol, it is not possible to say whether the apparent enhancement of the intellect is an objectively demonstrable fact. The physical power is unquestionably increased, such muscular exercises as are involved in ascending mountains being made much easier after the chewing of an ounce or so of these leaves. Excess in coca-chewing leads in many cases to great bodily wasting, mental failure, insomnia, weakness of the circulation and extreme dyspepsia. For other pharmacological characters and the therapeutic employments of coca see COCAINE.

COCAINE, $C_{17}H_{21}NO_4$, an alkaloid occurring to the extent of about 1% in the leaves of *Erythroxylon coca* (see above). It is associated with many other alkaloids: cinnamyl cocaine, $C_{19}H_{23}NO_4$; α -truxilline ($C_{19}H_{23}NO_4$)₂; β -truxilline, ($C_{19}H_{23}NO_4$)₂; benzoylcegonine, $C_{18}H_{19}NO_2$; tropa-cocaine, $C_{18}H_{19}NO_2$; hygrine, $C_3H_{15}NO$; cuscohygrine, $C_{13}H_{21}NO_2$. These substances, which may be collectively termed "cocaines," are all derivatives of ecgonine (*q.v.*). Cocaine is benzoylmethyl ecgonine. It crystallizes from alcohol in prisms, which are sparingly soluble in water. Its solution has a bitter taste, alkaline reaction, and is laevorotatory. Its use as a local anaesthetic (see ANAESTHESIA) makes it the most valuable of the coca alkaloids, and it is much used in ophthalmic practice. Applied to the conjunctiva it causes anaesthesia, dilatation of the pupil, diminution of the intraocular tension, and some interference with accommodation. The conversion of the mixture obtained by extracting coca-leaves into cocaine is effected by saponifying the esters into ecgonine and the respective acids, and then benzoylating and methylating the ecgonine. Homologues of cocaine—ethylbenzoylcegonine, &c.—have been prepared; they closely resemble natural cocaine. Cinnamyl cocaine is cinnamylmethylecgonine, *i.e.* cocaine in which the benzoyl group is replaced by the cinnamyl group. α - and β -truxillines, named from their isolation from a coca of Truxillo (Peru), are two isomeric alkaloids which hydrolyse to ecgonine, methyl alcohol, and two isomeric acids, the truxillie acids, $C_{18}H_{16}O_4$. The alkaloids are therefore methyl truxillylcegonines. The truxillie acids have been studied by K. Liebermann and his students (*Ber.*, vols. 21-27, and 31), and are diphenyl tetramethylene dicarboxylic acids.

COCANADA, or COCONADA, a town of British India, in the Godavari district of Madras, on the coast in the extreme north of the Godavari delta, about 315 m. N. of Madras. Pop. (1901) 48,096, showing an increase of 18% in the decade. As the administrative headquarters of the district, and the chief port on the Coromandel coast after Madras, Cocanada was formerly of considerable importance, but its shipping trade has declined, owing to the silting of the anchorage, and to the construction of the railway. It is connected by navigable channels with the canal system of the Godavari delta, and by a branch line with Samalkot on the East Coast railway. The anchorage is an open roadstead, with two lighthouses. The chief exports are rice,

cotton, sugar and oilseeds. Mills have been established for cleaning rice. The town contains a second-grade college, a high school, and a literary association.

COCCEIUS [strictly KOCCH], JOHANNES (1603-1669), Dutch theologian, was born at Bremen. After studying at Hamburg and Franeker, where Sixtinus Amama was one of his teachers, he became in 1630 professor of biblical philology at the "Gymnasium illustre" in his native town. In 1636 he was transferred to Franeker, where he held the chair of Hebrew, and from 1643 the chair of theology also, until 1650, when he succeeded Fr. Spanheim the elder as professor of theology at Leiden. He died on the 4th of November 1669. His chief services as an oriental scholar were in the department of Hebrew philology and exegesis. As one of the leading exponents of the "covenant" or "federal" theology, he spiritualized the Hebrew scriptures to such an extent that it was said that Cocceius found Christ everywhere in the Old Testament and Hugo Grotius found him nowhere. He taught that before the Fall, as much as after it, the relation between God and man was a covenant. The first covenant was a "Covenant of Works." For this was substituted, after the Fall, the "Covenant of Grace," to fulfil which the coming of Jesus Christ was necessary. He held millenarian views, and was the founder of a school of theologians who were called after him Cocceians. His theology was founded entirely on the Bible, and he did much to promote and encourage the study of the original text. In one of his essays he contends that the observance of the Sabbath, though expedient, is not binding upon Christians, since it was a Jewish institution. His most distinguished pupil was the celebrated Campeius Vitringa. His most valuable work was his *Lexicon et Commentarius Sermonis Hebraici et Chaldaici* (Leiden, 1669), which has been frequently republished; his theology is fully expounded in his *Summa Doctrinae de Fœdere et Testamento Dei* (1648).

His collected works were published in 12 folio volumes (Amsterdam, 1673-1675). See Herzog-Hauck, *Realencyklopädie*.

COCCIDIA, an important order of Sporozoa Ectospora, parasites possessing certain very distinctive characters. With one or two possible exceptions, they are invariably intracellular during the entire trophic life of the individual. They always attack tissue-cells, usually of an epithelium, and never blood-corpuscles. Correlated with the advanced degree of parasitism, there is a complete absence of specialization or differentiation of the cell-body, and the trophozoite is quite incapable of any kind of movement. In all cases, so far as known, the life-cycle is digenetic, an asexual generation (produced by schizogony) alternating with a sexual one (gametogony). After conjugation of two highly-differentiated gametes has taken place, a resistant oocyst is formed, which provides for the dispersal of the species; inside this sporogony (spore- and sporozoite-formation) goes on.

Hake (1839) was, perhaps, the first to describe a Coccidian, but he regarded the parasites as pathological cell-products. In 1845 N. Lieberkühn pointed out the resemblances to Gregarines, with which organisms he considered Coccidia to be allied. A year later, H. Kloss proved the existence of similar parasites in the snail, and attempted to construct their life-history; this form was subsequently named *Klossia helicina* by A. Schneider. The asexual part of the life-cycle was first described by Th. Eimer in 1870, for a Coccidian infesting the mouse, which was afterwards elevated by Schneider into a distinct genus *Eimeria*. The generic name *Coccidium* was introduced by R. Leuckart in 1879, for the parasite of the rabbit. It was many years, however, before the double character of the life-cycle was realized, and the ideas of L. and R. Pfeiffer, who first suggested the possibility of an alternation of generations, for a long time found no favour. In the first decade of the 20th century great progress was accomplished, thanks largely to the researches of F. Schaudinn and M. Siedlecki, who first demonstrated the occurrence of sexual conjugation in the group; and the Coccidian life-history is now one of the best known among Sporozoa.

Coccidia appear to be confined¹ to four great phyla, Vertebrates,

¹ A curious organism, parasitic in a gregarine, has lately been described by Dogiel as a coccidian, and termed *Hyalosphaera*.

Molluscs, Arthropods and Annelids; the first named group furnishes by far the most hosts, the parasites being frequently met with in domestic animals, both birds and mammals. Following from the casual method of infection, the epithelium of the gut or of its appendages (e.g. the liver [Plate I., fig. 1]) is a very common seat of the parasitic invasion. But in many cases Coccidia are found in other organs, to which they are doubtless carried by lymphatic or circulatory channels. In Molluscs, they often occur in the kidneys (fig. 2); in Insects, they are met with as "coelomic" parasites, the fat-bodies, pericardial cells, &c., being a favourite habitat; even the testis is not free from their attentions in one or two instances, though the ovary appears always immune.

The parasite invariably destroys its host-cell completely. The latter is at first stimulated to abnormal growth and activity and becomes greatly hypertrophied, the nucleus also undergoing karyolytic changes (fig. 4). The fatty materials elaborated by the host-cell are rapidly used up by the Coccidian, as nourishment; and at length the weakened and disorganized cell is no longer able to assimilate but dies and is gradually absorbed by the parasite, becoming reduced to a mere enclosing skin or envelope. In some cases (ex. *Cyclospora carlyolytica* of the mole) the parasite is actually intranuclear, the nucleus becoming greatly swollen and transformed into a huge vacuole containing it.

The effects of a Coccidian infection upon the host as a whole depend largely upon the extent to which endogenous multiplication of the parasites takes place. On the one hand, schizogony may be so limited in extent as not to cause appreciable injury to the host. This seems to be often the case in forms infecting Molluscs and Arthropods. On the other hand, where schizogony is rapid and prolonged, the results are oftenserious. For, although any one individual only causes the death of a single host-cell, yet the number of the parasites may be so enormously increased by this means, that the entire affected epithelium may be overrun and destroyed. Thus are occasioned grave attacks of coccidiosis, characterized by severe enteritis and diarrhoea, which may end fatally. In the case of the Vertebrates, secondary causes, resulting from the stoppage of the bile ducts, also help to produce death. There is, however, one factor in the endangered animal's favour. Schizogony cannot go on indefinitely; it has a limit, dependent upon the supply of host-cells, and consequently of nutriment, available. As this shows signs of becoming exhausted, by the rapid multiplication of the parasites, the latter begin to make preparations for the exogenous cycle, inaugurated by gametogony. When conjugation has taken place and sporogony is begun, the danger to the host is at an end. So that, if the acute stage of the disease is once successfully passed, the regenerative capacity of the epithelium may be able to restore something like equilibrium to the deranged metabolism in time to prevent collapse.

Coccidium schubergi, parasitic in the intestine of a centipede (*Lithobius forficatus*), may be taken as an example of a Coccidian life-history (see Schaudinn, 1900): some of the more important variations exhibited by other forms will be noted afterwards. The trophozoite, or actively-growing parasite, is an oval or rounded body (fig. 3, I.).

The general cytoplasm shows no differentiation into ectoplasm and endoplasm; it is uniformly alveolar in character. The nucleus is relatively large, and possesses a distinct membrane and a well-marked reticulum in which are embedded grains of chromatin. Its most conspicuous feature is the large deeply-staining karyosome, which consists of the greater part of the chromatin of the nucleus intimately bound up with a plastinoid basis. When fully grown, the trophozoite (now a schizont) undergoes schizogony. Its nucleus divides successively to form a number of nuclei, which travel to the periphery, and there become more or less regularly disposed (fig. 3, II. and III.). The protoplasm in the neighbourhood of each next grows out, as a projecting bud, carrying the nucleus with it. In this manner are formed a number of club-shaped bodies, the merozoites, which are at length set free from the parent-body (IV.), leaving a certain amount of residual cytoplasm behind. By the rupture of the disorganized host-

cell,¹ the fully-formed merozoites are liberated into the intestinal lumen, and seek out fresh epithelial cells. Each is more or less sickle-shaped, and capable of active movements. Once inside a new host-cell, the merozoite grows to a schizont again.

After this course has been repeated several times, gametogony sets in, the trophozoites growing more slowly and becoming the parent-cells of the sexual elements (gametocytes), either male individuals (microgametocytes) or female ones (megagametocytes). A microgametocyte (fig. 3, VI. ♂) is characterized by its dense but finely reticular or alveolar cytoplasm, very different from the loose structure of that of a schizont. The male elements (microgametes) are formed in a manner essentially comparable to that in which the formation of merozoites takes place. Although the details of the nuclear changes and divisions vary somewhat, the end-result is similar, a number of little nuclear agglomerations being evenly distributed at the surface (VII. ♂). Each of these elongates considerably, becoming comma-shaped and projecting from the gametocyte. Nearly all the body of the male gamete (VIII. ♂) consists of chromatin, the cytoplasm only forming a very delicate zone or envelope around the nucleus. From the cytoplasm two long fine flagella grow out, one of which originates at the anterior end, the other, apparently, at the hinder end, acting as a rudder; but it is probable that this also is developed at the anterior end and attached to the side of the body. By means of their flagella the numerous microgametes break loose from the body of the microgametocyte and swim away in search of a female element.

A megagametocyte (VI. ♀) is distinguished by its rather different shape, being more like a bean than a sphere until ripe for maturation, and by the fact that it stores up in its cytoplasm quantities of reserve nutriment in the form of rounded refringent plastinoid grains. Each female gametocyte gives rise to only a single female element (megagamete), after a process of nuclear purification. The karyosome is expelled from the nucleus into the cytoplasm, where it breaks up at once into fragments (VII. ♀). Meanwhile the gametocyte is becoming spherical, and its changes in shape aid in setting it free from the shrivelled host-cell. The fragments of the karyosome, which are, as it were, squeezed out to the exterior, exert a powerful attraction upon the microgametes, many of which swarm round the now mature megagamete. The female nucleus (pronucleus) approaches the surface of the cell (VIII. ♀), and at this spot a little clear cytoplasmic prominence arises (cone of reception). On coming into contact with this protuberance (probably attracted to it by the female pronucleus), a microgamete adheres. Partly by its own movements and partly by the withdrawal of the cone of attraction, the male penetrates into the female element and fertilization is accomplished. Only one microgamete can thus pass into the megagamete, for immediately its entry is effected a delicate membrane is secreted around the copula (zygote), which effectually excludes other less fortunate ones. This membrane rapidly increases in thickness and becomes the oocyst (IX.), and the copula is now ready to begin sporogony.

Sporogony goes on indifferently either inside the host or after the cyst has been passed out with the faeces to the exterior. The definitive nucleus of the zygote (resulting from the intimate fusion of the male and female pronuclei, by means of a somewhat elaborate "fertilization-spindle" [X.]) gives rise by successive direct divisions to four nuclei (XII.), around which the protoplasm becomes segregated; these segments form the four sporoblasts. Around each sporoblast two membranes are successively secreted (exospore and endospore), which constitute the sporocyst (XIII.); the sporocyst and its contents forming the spore. The nucleus of each spore next divides, again directly, and this is followed by the division of the cytoplasm. As a final result, each of the four spores contains two germs (sporozoites), and a certain amount of residual protoplasm (fig. 3, XIV.); this latter enclosed a viscid, vacuole-like body, which aids in the subsequent dehiscence of the sporocyst. On being eaten by a fresh host, the wall of the oocyst is dissolved at a particular region by the

¹ It is important to note that in schizogony there is never any cyst or cyst-membrane formed around the parasite.

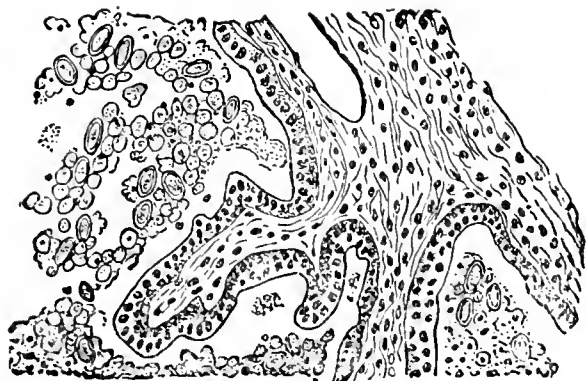

Fig. 1.—Section through Rabbit's Liver, infected with *Coccidium Cuniculi*. (After Thoma.)

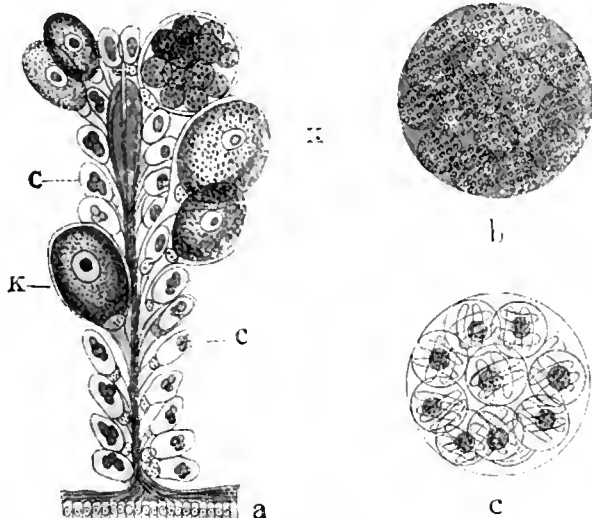

Fig. 2.—*Klossia Helicina*, from Kidney of *Helix Hortensis*.

a, Portion of a section of the kidney showing normal epithelial cells containing concretions (c), and enlarged epithelial cells containing the parasite (k) in various stages; b, cyst of the *Klossia* containing sporoblasts; c, cyst with ripe spores, each enclosing four sporozoites and a patch of residual protoplasm. (From Wasielewski, after Balbiani.)

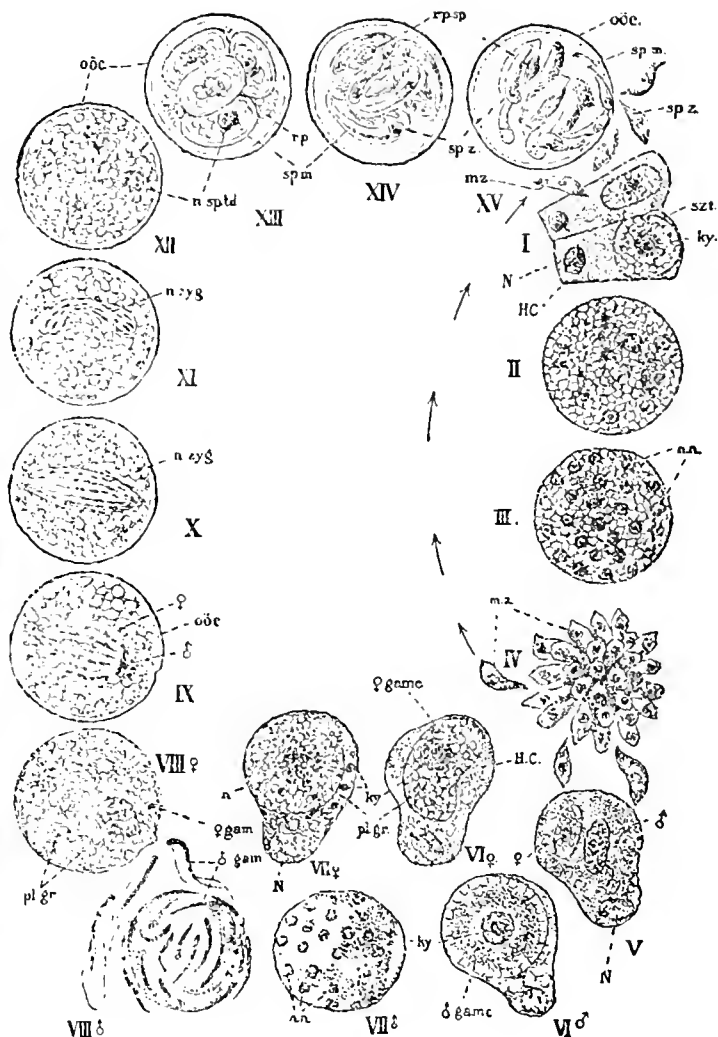

Fig. 3.—The Life-Cycle of *Coccidium Schubergi*, Schaud. (Par. *Lithobius Forficatus*). (From Minchin, after Schaudinn.)

I-IV represents the schizogony, commencing with infection of an epithelial cell by a sporozoite or merozoite. After stage IV the development may start again at stage I, as indicated by the arrows; or it may go on to the formation of gametocytes (V). V-VIII represents the sexual generation. The line of development, hitherto single (I-IV) becomes split into two lines—male (VI ♂, VII ♂, VIII ♂), and female (VI ♀, VII ♀, VIII ♀), culminating in the highly differentiated micro- and mega-gametes. By conjugation these two lines are again united. IX, X, show the formation of the zygote by fusion of the nuclei of the gametes. XI-XV, sporogony. H.C, host-cell; N, its nucleus; mz, merozoite; sz.t, schizont; ky, karyosome (or fragments of same); n.n, daughter-nuclei of schizont; pl.gr, plastinoid grains; ooc, oocyst; n.zyg, zygote-nucleus (segmentation-nucleus); sp.m, spore-membrane (sporocyst); rp, residual protoplasm of oocyst ("reliquat kystal"); rp.sp, residual protoplasm of spore ("reliquat sporal"); sp.z, sporozoite.

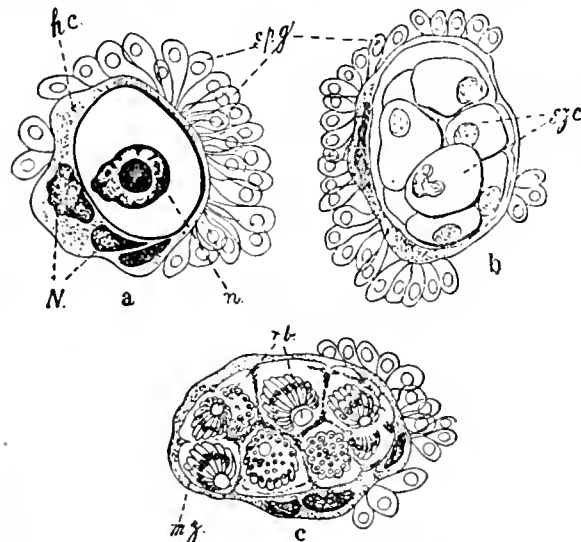

Fig. 4.—Phases of *Caryotropha Mesnili*, Siedl. (Par. *Polymnia Nebulosa*).

a, Young schizont in a cluster of spermatogonia; the host-cell (represented granulated) and two of its neighbours are greatly hypertrophied, with very large nuclei, and have fused into a single mass containing the parasite (represented clear, with a thick outline). The other spermatogonia are normal. b, Intracellular schizont divided up into schizontocytes (c), each schizontocyte giving rise to a cluster of merozoites arranged as a "corps en barillet"; sp.g, spermatogonia; h.c, host-cell; N, nucleus of host-cell or cells; n, nucleus of parasite; sc, schizontocyte; mz, merozoites; r.b, residual bodies of the schizontocytes. (From Minchin, after Siedlecki.)

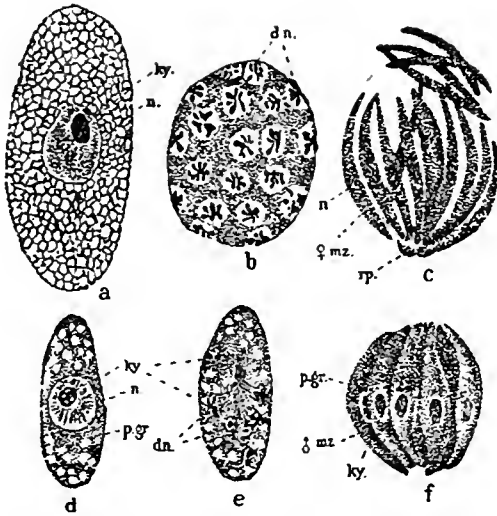

Fig. 5.—Schizogony of *Adelea Ovata*, A. Schn. (Par. *Lithobius Forficatus*).

a-c, ♀ generation; d-f, ♂ generation. a, Full-grown ♀ schizont (*megaschizont*), with a large nucleus (n) containing a conspicuous karyosome (ky). b, Commencement of schizogony; the nucleus has divided up to form a number of daughter-nuclei (dn). The karyosome of stage a has broken up into a great number of daughter-karyosomes, each of which forms at first the centre of one of the star-shaped daughter-nuclei; but in a short time the daughter-karyosomes become inconspicuous. c, Completion of schizogony; the ♀ schizont has broken up into a number of *megamerozoites* (♀ mz) implanted on a small quantity of residual protoplasm (r.p.). Each ♀ merozoite has a chromatic nucleus (n) without a karyosome. d, Full-grown ♂ schizont (*microschizont*), with nucleus (n), karyosome (ky), and a number of characteristic pigment-granules (p.gr.). e, Commencement of schizogony. The nucleus is dividing up into a number of daughter-nuclei (dn), each with a conspicuous karyosome (ky). f, Completion of schizogony. The numerous micromerozoites (♂ mz) have each a nucleus with a conspicuous karyosome (ky) at one pole, and the protoplasm contains pigment-granules (p.gr.) near the nucleus, on the side farthest from the karyosome. (From Minchin, after Siedlecki.)

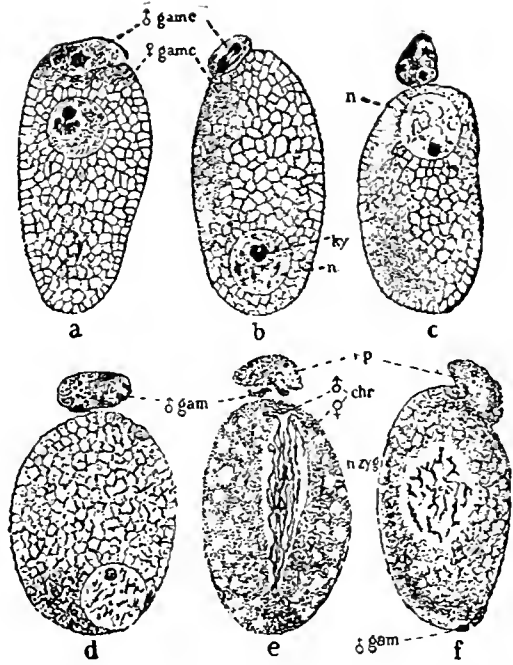

Fig. 6.—Association and Conjugation in *Adelea Ovata*.

a, Young microgametocyte (♂ gamc.) attached to a megagametocyte (♀ gamc.). The nucleus of the microgametocyte gives rise to 4 daughter-nuclei (c) which become (d) 4 microgametes (♂ gam.). e, One of the microgametes penetrates the megagamete, which forms a fertilization-spindle composed of male and female chromatin (♂ chr. and ♀ chr.). The other 3 microgametes and the residual protoplasm of the microgametocyte (r.p.) perish. The karyosome of the megagamete has disappeared, as such. f, Union of the chromatin of both elements, to produce the zygote-nucleus (n.zyg.). (From Minchin, after Siedlecki.)

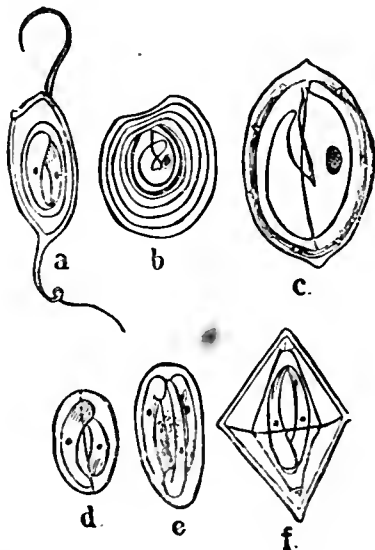

Fig. 7.—Spores of Various Coccidian Genera.

a, *Minchinia chitonis* (E.R.L.), (par. *Chiton*); b, *Diaspora hydatidea*, Léger (par. *Polydesmus*); c, *Echinospira labbei*, Léger (par. *Lithobius mutabilis*); d, *Goussia motellae*, Labbé; e, *Diplospora* (*Hyaloklossia*), *lieberkuhni* (Labbé), (par. *Rana esculenta*); f, *Crystallospora cristalloides* (Thél.), (par. *Motella tricirrata*). (From Minchin; b and c after Léger, the others after Labbé.)

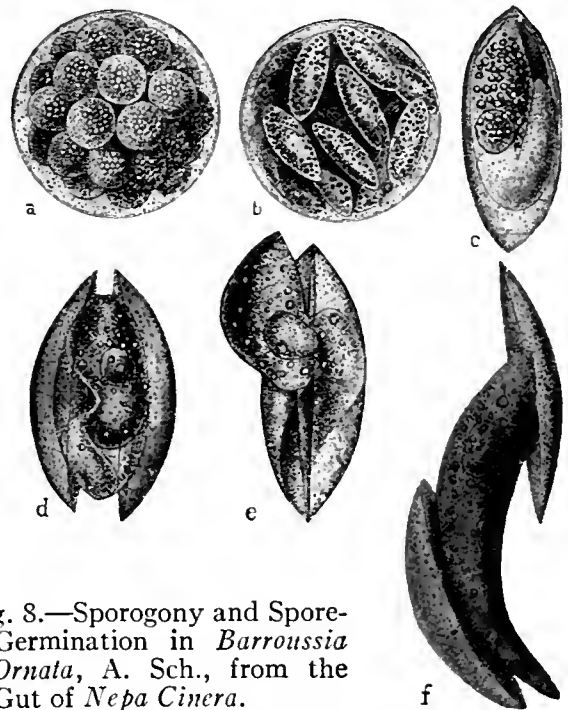

Fig. 8.—Sporogony and Spore-Germination in *Barroussia Ornata*, A. Sch., from the Gut of *Nepa Cinera*.

a, Oocyst with sporoblasts; b, oocyst with ripe spores; c, a spore highly magnified, showing the single sporozoite bent on itself; d, the spore has split along its outer coat or epispore, but the sporozoite is still enclosed in the endospore; e, the sporozoite freed from the endospore, is emerging; f, the sporozoite has straightened itself out and is freed from its envelopes. (From Wasielewski, after A. Schneider.)

digestive juices, which are thus enabled to reach the spores and cause the rupture of the sporocysts. As the result of instructive experiments, Metzner has shown that it is the pancreatic and not the gastric juice by which this liberation of the germs is effected. The liberated sporozoites creep out and proceed to infect the epithelial cells. The sporozoites (XV.) are from 15-20 μ long by 4-6 μ wide; they are fairly similar to merozoites in form, structure and behaviour, the chief point of distinction being that they have no karyosome in the nucleus (cf. above).

Comparing the life-cycle of other Coccidia with that just described, a greater or less degree of modification is frequently met with. In the process of schizogony two orders of division sometimes occur; the parent-schizont first divides up into a varying number of rounded daughter-schizonts (schizontocytes), each of which gives rise, in the usual manner, to a cluster of merozoites,¹ which thus constitute a second order of cells. Siedlecki (1902) has found this to be the case in *Caryotropha mesnili* (fig. 4), and Woodcock (1904) has shown that it is most probably really the same process which Smith and Johnson (1902) mistook for sporogony when originally describing their Coccidian of the mouse, *Klossiella*. In *Caryotropha*, a perfectly similar state of affairs is seen in the formation of microgametes from the microgametocyte; this is additionally interesting as showing that this process is neither more nor less than male schizogony.

Coming to the sexual generation, considerable variation is met with as regards the period in the life-history when sexual differentiation first makes its appearance. Sexuality may become evident at the very beginning of schizogony, as, e.g. in *Adelea ovata* (Siedlecki, 1899), where the first-formed schizonts (those developed from the sporozoites) are differentiated into male and female (micro- and mega-schizonts) (see Plate II., fig. 5). Correspondingly, the merozoites, to which they give rise, are also different (micro- and mega-merozoites). In one or two cases sexuality appears even earlier in the cycle, and has thus been carried still farther back.

The Coccidia, as a whole, have not developed the phenomenon of association of the sexual individuals prior to gamete-formation which is so characteristic of Gregarines. Their method of endeavouring to secure successful sporulation, and thus the survival of the species, has been rather by the extreme specialization of the sexual process. In place of many female elements, which the primitive or ancestral forms may be assumed to have had,² there is always, save possibly for one exception,³ only a single relatively huge megagamete formed, which offers a comparatively easy goal for one of the many microgametes. Nevertheless in the effort to render fertilization absolutely certain, a few Coccidia have acquired (secondarily) the power of associating; a state of things which enables those forms, moreover, to effect an economy in the number of male gametes, only three or four being developed. Instances are seen in *Adelea mesnili* (Perez, 1903), *A. ovata* (fig. 6), and *Klossia helicina* (Siedlecki, 1899). It is very interesting to note that, in the two last cases, unless this association of the microgametocyte with the megagametocyte occurs, neither can the former produce male elements (microgametes) nor can the female individual mature and become ready for fertilization. (Concerning this question of association see also GREGARINES.)

In sporogony, great variation is seen with respect to the number of spores and sporozoites formed; and, as in Gregarines, these characters are largely used for purposes of classification, under which heading they are better considered. Usually, the spores (fig. 7) are quite simple in outline, and not produced into

¹ The merozoites are frequently arranged like the staves of a barrel—whence the term *barillet*, which is frequently used.

² In *Cyclospora*, Schaudinn (1902) has noted certain abnormal cases of the persistence and further multiplication of the "reduction-nuclei" of the female element (i.e. the nuclear portions given off during maturation), followed by multiple fertilization. This occurrence points strongly to the conclusion that there were originally many female gametes (cf. also the sporoblasts of Gregarines).

³ The remarkable forms parasitic in Cephalopods (of late known as *Eucoccidium*), if still ranked with the Coccidia, furnish an exception (see below).

spines or processes; exceptions are found, however, in a few instances (e.g. *Minchinia chilonis*). In one case (*Coccidium mitrarium*), the oocyst itself, instead of being spherical, is curiously shaped like a mitre.

The life-history as a whole is invariably undergone in a single host, i.e. there is no alternation of true hosts.⁴ Schaudinn, in his work on the Coccidia of *Lithobius* (1900), showed that the oocysts expelled with the faeces may be eaten by wood-lice (*Oniscus*), but when this happens they pass through the intestine of the wood-louse unaltered, the latter not being an intermediate host but merely a carrier.

The order Coccidiidea is divided into four families, characterized by the number of sporocysts (if any) found in the oocyst.

Fam. ASPOROCYSTIDAE, Léger. No sporozoites are formed in the oocyst, the sporozoites being unenclosed (genus spores). Classifi-
cation.

Genus, *Légerella*, Mesnil. This genus actually conforms to Aimé Schneider's original definition of *Eimeria*, which was founded on what were really the schizogonous generations of other forms, then thought to be distinct. In view of the great confusion attending the use of this name, however, Mesnil (1900) has suggested the new one here adopted. Two species known, *L. nova* and *L. lestituli*, both from different species of *Glomeris*, a Myriapod; the former inhabits the Malpighian tubules, the latter the testis.

Fam. DISPOROCYSTIDAE, Léger. The oocyst contains 2 spores.

Genus 1. *Cyclospora*, A. Schneider. Spores dizoic, i.e. with two sporozoites. *C. glomericola*, from the intestinal epithelium of *Glomeris*, and *C. caryolytica*, from the intestinal epithelium of the mole, intranuclear.

Genus 2. *Diplospora*, Labbé. Spores tetrazoic. *D. laeaei*, from many birds, is the best-known species; and others have been described from different Sauropsida. *D. lieberkühni* is an interesting form occurring in the kidneys of the frog, which it reaches by way of the circulation.

Genus 3. *Isospora*, Schn. Spores polyzoic. Founded for *I. rara*, parasitic in the black slug (*Limax cinereo-niger*). Many authors consider that Schneider was mistaken in attributing many sporozoites to this form, and would unite with it the genus *Diplospora*.

Fam. TETRASPOROCYSTIDAE, Léger. The oocyst contains 4 spores.

Genus 1. *Coccidium*,⁵ Leuckart. The spores are dizoic and the sporocysts rounded or oval. A very large number of species are known, mostly from Vertebrate hosts. *C. cuniculi* (= *C. oviforme*) from the rabbit (intestine and diverticula), but also occurring sometimes in other domestic animals; *C. falciiformis*, from the mouse; *C. faurei* from sheep; and *C. schubergi*, from *Lithobius* (a centipede), are among the best-known forms. All of them may cause disastrous epidemics of coccidiosis.

Genus 2. *Paracoccidium*, Laveran and Mesnil. This genus is distinguished from *Coccidium* by the fact that the sporocysts become dissolved up in the oocyst, thus leaving the 8 sporozoites unenclosed, recalling the condition in *Légerella*. *P. pretvoti*, unique species, from the frog's intestine.

Genus 3. *Crystallospora*, Labbé. Spores also dizoic, but having the form of a double pyramid. *C. crystalloides* from a fish, *Metella tricirrata*.

Genus 4. *Angeiocystis*, Brasil. Apparently 6 sporozoites, but the only species, *A. audouinii*, has only been briefly described; from a Polychaete (*Audouinia*).

Fam. POLYSPOROCYSTIDAE, Léger. The oocyst contains numerous spores.

There are several genera with monozoic spores, characterized by variations in the form and structure of the sporocysts, e.g. *Barroussia*, Schn. (fig. 8), *Echinospora*, Léger, and *Diaspora*, Léger; most of these forms are from Myriapods.

Genus *Adelea*, Schn. Dizoic spores; sporocysts round or oval, plain. Several species are included in this well-known genus, among them being *A. ovata*, *A. mesnili*, *A. dimidiata*; most of them are parasitic in Insects or Myriapods.

Genus *Minchinia*, Labbé. Dizoic spores; the sporocysts are produced at each pole into a long filament. *M. chilonis*, from the liver of *Chilton* (Mollusca).

Genus *Klossia*, Schn. The spores are tetrazoic (or perhaps polyzoic). *K. helicina* from the kidney of various land-snails is the best-known form. Usually said to have 5 to 6 spores, but Mesnil considers that the normal number is 4, as is the case in another species, *K. soror*.

Genus *Caryotropha*, Siedlecki. Many spherical spores (about 20)

⁴ Again with the exception of *Eucoccidium*.

⁵ Purists in systematic nomenclature maintain that this name should be relinquished in favour of *Eimeria*, since the latter was the first legitimate generic name given to a Coccidian. But one reason against the use of *Eimeria* has been stated already (it should be used for *E. (Légerella) nova*, if anywhere); and in addition, the word *Coccidium* and its important derivatives are now so universally established that it would be little short of ridiculous to displace them.

each with 12 sporozoites. *C. mesnili*, unique species, from the spermatogonial (testis) cells of *Polymnia* (a Polychaete). An interesting point in the schizogony is the formation of schizontocytes (see above).

A Coccidian parasitic in the kidneys of the mouse has been described by Smith and Johnson (1902) and named by them *Klossiella*, on the ground that it possessed many spores, each with about 20 sporozoites. Woodcock has shown, however, that the authors were in all probability dealing with a similar modification of schizogony to that which obtains in *Caryotropha*. The sporogony of this form (and hence its systematic position) remains at present, therefore, quite unknown.

There are several doubtful or insufficiently known genera, e.g. *Bancarella*, *Goussia*, *Hyaloklossia*, *Gonobia*, *Pfeifferella* and *Rhabdospora*, many of which probably represent only schizogonous generations of other forms. (For information concerning these see Labbé, 1897.)

Lastly it remains to mention the extremely interesting forms parasitic in Cephalopods. For some years these have provided a fruitful source of discussion to systematists. Here it may be stated simply that their systematic position and nomenclature were thought to have been finally settled by the researches of Jacquemet (1903) and Lühe (1902) in the following terms:—

Genus *Eucoccidium*. Lühe (syn. *Légerina* Jacq.), Coccidia possessing polysporous oocysts and lacking schizogony, parasitic in Cephalopods. Two well-known species: *E. eberthi* (Labbé), (= *Benedenia* seu *Klossia* e. seu *octopiana*), parasitic in *Sepia*, which is tri- or tetra-zoic; and *E. octopium* (Schn.), (syn. *Benedenia* seu *Klossia* o.) from *Octopus*, which is polyzoic, having 10 to 12 sporozoites. In both forms cysts containing megasporos and megasporozoites, and others containing microspores and microsporozoites are found, considered as representing sexual differentiation thrown back to the very earliest stages of the life-cycle.

Quite recently much additional light has been thrown upon our knowledge of these parasites, including a new one, *E. jacquemeti*. Moroff (1906) has shown that not one but many megagametes are formed, and fertilized by the microgametes. For this reason he regards them as Gregarines rather than Coccidia. Further, Léger and Duboscq (1906) have found that the characteristic coelomic parasites (*Aggregata*) of Crustacea, generally regarded as gymnosporous Gregarines (i.e. Gregarines in which the sporozoites are naked) constitute in reality nothing more or less than a schizogonous generation of these Cephalopodan parasites, which have thus an alternation of true hosts. The ripe sporocysts from the Cephalopod are eaten by a particular crab (e.g. *Portunus* or *Inachus*, according to the parasite), the sporozoites are liberated and traverse the mucous membrane of the intestine, coming to rest in the surrounding lymphatic layer. Here a large "cyst" is formed, projecting into the body-cavity, the contents of which give rise to a great number of merozoites. On the crab being devoured by the right species of Cephalopod, the merozoites doubtless give rise to the sexual generation again.

As the name *Aggregata* is much the older, and as, moreover, there is no longer any reason to retain that of *Eucoccidium*, these parasites must in future receive the former generic appellation. With regard to the various specific names, however, they remain quite unsettled until the life-history is properly worked out in different cases (see also GREGARINES).

It seems to the writer a much more open question than Moroff and Léger and Duboscq apparently suppose, whether these parasites are to be relegated to the Gregarines. For undoubtedly they have many Coccidian features, and on the other hand they differ in many ways from Gregarines. The chief feature of agreement with the latter order is the possession of many female gametes. As already said, there can be little doubt that this was the condition in the Coccidian ancestor, and it is by no means impossible that one or two forms existing at the present day remain primitive in that respect. On the other hand, the advanced character of the parasitism (the parasites remaining intracellular up to and including gamete-formation); the entire lack of the characteristic feature of association; the schizogony, which is only a very rare occurrence in Gregarines, and which, in the present case, strongly suggests the process in *Caryotropha* and *Klossiella*; and, last but not least, the varying number of the sporozoites (3 in one form, 10–15 in others), which is very different from the almost constant number (8) in Gregarines, are all characters in which these forms agree with Coccidia and not with Gregarines. Having regard to these points, the writer is inclined, for the present, to consider *Aggregata* as an offshoot rather from the Coccidian than from the Gregarine branch of the Ectosporan tree.

BIBLIOGRAPHY.—The following are some of the important papers dealing with the order:—G. Bonnet-Eymard, "Sur l'évolution de l'*Eimeria* *noxæ*, Schneider," *C.R. Soc. Biol.* 52, p. 659, 1900; L. Brasil, "Sur une Coccidie nouvelle, &c.," *C.R.Ac. Sci.* 139, p. 645, 1904; L. Cuénot, "*Légerella testiculi* n. sp., &c.," *Arch. Zool. exp.* (N. et R.), (3) 10, p. 49, 6 figs., 1902; M. Jacquemet, "Sur la systématique des Coccidies des Céphalopodes," *Arch. Protistenk.* 2 p., 190, 1903; A. Labbé, "Recherches zoologiques, cytologiques et biologiques sur les Coccidies," *Arch. zool. exp.* (3), 4, p. 517, 3 pls., 1897; A. Laveran, "Sur les modes de reproduction d'*Isospora lacazei*,"

C.R. Soc. Biol. 50, p. 1139, 1898; A. Laveran and F. Mesnil, "Sur deux Coccidies intestinales de la *Rana esculenta*," *op. cit.* 54, p. 857, 9 figs., 1902; A. Laveran and F. Mesnil, "Sur la Coccidie trouvée dans le rein de la *Rana esculenta*, &c.," *C.R.Ac. Sci.* 135, p. 82, 10 figs., 1902; A. Laveran and F. Mesnil, "Sur quelques Protozoaires parasitaires d'une tortue, &c.," *t. c.* p. 609, 14 figs., 1902; L. Léger, "Sur une nouvelle Coccidie à microgamètes ciliés," *op. cit.*, 127, p. 418, 1898; L. Léger, "Sur la morphologie et le développement des microgamètes des Coccidies," *Arch. zool. exp.* (N. et R.) (3), 6, 1898; L. Léger, "Essai sur la classification des Coccidies, &c.," *Ann. Mus. Nat. Hist.*, Marseille (2), Bull. i. p. 71, 4 pls., 1898; L. Léger, "Sur la présence d'une Coccidie coelomique chez *Oloccrates*, &c.," *Arch. zool. exp.* (N. et R.) (3), 8, p. i., 1900; L. Léger, "Sur le genre *Eimeria* et la classification des Coccidies," *C.R. Soc. Biol.* 52, p. 575, 1900; L. Léger and O. Duboscq, "Recherches sur les Myriapodes de Corse et leurs parasites," *Arch. zool. exp.* (4), 1, p. 307, 24 figs., 1903; L. Léger and O. Duboscq, "Sur l'évolution des Gregarines gymnosporées des Crustacés," *C.R.Ac. Sci.* 142, p. 1225, 1906; L. Léger and O. Duboscq, "L'évolution d'une *Aggregata* de la seiche chez le *Portunus depurator*," *C.R. Soc. Biol.* 60, p. 1001, 1906; M. Lühe, "Über Geltung und Bedeutung der Gattungsnamen *Eimeria* und *Coccidium*," C. B. Bakter (1) 31 Orig., p. 771, 1902; C. B. Bakter "Die Coccidien-Literatur der letzten vier Jahre," *Zool. Centrbl.* 10, 45 pp., 1903; F. Mesnil, "Sur la conservation du nom générique *Eimeria*, &c.," *C.R. Soc. Biol.* 52, p. 603, 1900; F. Mesnil, "Les Travaux récents sur les Coccidies," *Bull. Inst. Pasteur*, i. pp. 473, 505, 1903; R. Metzner, "Untersuchungen an *Coccidium* *cuniculi*," *Arch. Protistenk.* 2, p. 13, pl. ii. 1903; G. Moussu and G. Marotel, "La Coccidie du mouton et son parasite," *Arch. Parasitol.* 6, p. 82, 10 figs., 1902; T. Moroff, "Sur l'évolution des prétendues Coccidies des Céphalopodes," *C.R.Ac. Sci.* 142, p. 652, 1906; C. Perez, "Le Cycle évolutif de l'*Adelea* *mesnili*, &c.," *Arch. Protistenk.* 2, p. 1, pl. 1, 1903; F. Schaudinn, "Untersuchungen über den Generationswechsel bei Coccidien," *Zool. Jahrbücher* (Anat.) 13, p. 197, 4 pls., 1900; F. Schaudinn, "Studien über krankheitserregende Protozoen—I. *Cyclospora carolytica*, &c.," *Arb. kais. Gesundh.-amt*, 18, p. 378, 2 pls., 1902; M. Siedlecki, "Réproduction sexuée . . . chez . . . *Coccidium proprium*," *C.R. Soc. Biol.* 50, p. 664, figs., 1898; M. Siedlecki, "Étude cytologique . . . de la Coccidie de la seiche, &c.," *Ann. Inst. Pasteur*, 12, p. 799, 3 pls., 1898; M. Siedlecki, "Étude cytologique . . . de *Adelea* *ovata*," *op. cit.* 13, p. 169, 3 pls., 1899; M. Siedlecki, "Cycle évolutif de la *Caryotropha mesnili*, &c.," *Bull. Ac. Cracovie*, p. 561, 5 figs., 1902; T. Smith and H. P. Johnson, "On a Coccidian (*Klossiella muris*, gen. et spec. nov.), &c.," *J. exp. Med.* 6, p. 303, 3 pls., 1902; H. M. Woodcock, "Notes on Sporozoa. I. On *Klossiella muris*, &c.," *Q.J. micr. Sci.* 48, p. 153, 2 figs., 1904. (H. M. Wo.)

COCCULUS INDICUS, the commercial name for the dried fruits of *Anamirta Cocculus* (natural order Menispermaceae), a large climbing shrub, native to India. It contains a bitter poisonous principle, *picrotaxin*, used in small doses to control the night sweats of phthisis. It was formerly known as Levant nut and Levant shell, owing to the fact that it was brought to Europe by way of the Levant.

COCHABAMBA, a central department of Bolivia, occupying the eastern angle of the great Bolivian plateau, bounded N. by the department of El Beni, E. by Santa Cruz, S. by Chuquisaca and Potosí, and W. by Potosí, Oruro and La Paz. Area, 23,328 sq. m.; pop. (1900) 328,163. Its average elevation is between 8000 and 10,000 ft., and its mean temperature ranges from 50° to 60° F., making it one of the best climatic regions in South America. The rainfall is moderate and the seasons are not strongly marked, the difference being indicated by rainfall rather than by temperature. The rainy season is from November to February. Cochabamba is essentially an agricultural department, although its mineral resources are good and include deposits of gold, silver and copper. Its temperate climate favours the production of wheat, Indian corn, barley and potatoes, and most of the fruits and vegetables of the temperate zone. Coca, cacao, tobacco and most of the fruits and vegetables of the tropics are also produced. Its forest products include rubber and cinchona. Lack of transportation facilities, however, have been an insuperable obstacle to the development of any industry beyond local needs except those of cinchona and rubber. Sheep and cattle thrive in this region, and an experiment with silkworms gave highly successful results. The population is chiefly of the Indian and *mestizo* types, education is in a backward state, and there are no manufactures other than those of the domestic stage, the natives making many articles of wearing apparel and daily use in their own homes. Rough highways and

mule-paths are the only means of communication, but a projected railway from Cochabamba (city) to Oruro, 132 m., promises to bring this isolated region into touch with the commercial world. The department is divided into nine provinces, but there is no effective local government outside the municipalities. The capital is Cochabamba; other important towns are Punata, Tarata, Totorá, Mizque and Sacába.

COCHABAMBA, a city of Bolivia, capital of the department of the same name and of the province of Cercado, situated on the Rocha, a small tributary of the Guapay river, in lat. 17° 27' S. and long. 65° 46' W. Pop. (1900) 21,586, mostly Indians and *mestizos*. The city stands in a broad valley of the Bolivian plateau, 8,400 ft. above sea-level, overshadowed by the snow-clad heights of Tunari and Larati, 291 m. north-north-west of Sucre and 132 m. east-north-east of Oruro, with both of which places it is connected by rough mountain roads. A subsidized stage-coach line runs to Oruro. A contract for a railway between the two cities was made in 1906, connecting with the Antofagasta and Arica lines. The climate is mild and temperate, and the surrounding country fertile and cultivated. Cochabamba is often described as the most progressive city of Bolivia, but it has been held back by its isolated situation. The warehouses of the city are well supplied with foreign goods, and trade is active in spite of high prices. The city is provided with telegraphic communication via Oruro, and enjoys a large part of the Amazon trade through some small river ports on tributaries of the Mamoré. The city is regularly laid out, and contains many attractive residences surrounded by gardens. It is an episcopal city (since 1847), containing many churches, four conventual establishments, and a missionary college of the "Propaganda Fide" for the conversion of Indians. The city has a university and two colleges, but they are poorly equipped and receive very little support from the government. Cochabamba was founded in the 16th century, and for a time was called Oropesa. It took an active part in the "war of independence," the women distinguishing themselves in an attack on the Spanish camp in 1815, and some of them being put to death in 1818 by the Spanish forces. In 1874 the city was seized and partly destroyed by Miguel Aguirre, but in general its isolated situation has been a protection against the disorders which have convulsed Bolivia since her independence.

COCHEM, a town of Germany, in the Prussian Rhine province on the Mosel, and 30 m. W. of Coblenz by the railway to Trier, which above the town enters the longest tunnel (2½ m.) in Germany. Pop. 3,500. It is romantically situated in the deep and winding valley of the Mosel, at the foot of a hill surrounded by a feudal castle dating from 1051, which has been restored in its former style. There is a considerable trade in wines.

COCHERY, LOUIS ADOLPHE (1819-1900), French statesman, was born at Paris. After studying law he soon entered politics, and was on the staff of the ministry of justice after the revolution of February 1848. From the *coup d'état* of 1851 to May 1869 he devoted himself to journalism. Then, elected deputy by the department of the Loiret, he joined the group of the Left Centre, and was a supporter of the revolution of the 4th of September 1870. His talent in finance won him a distinguished place in the chamber. From 1879 till 1883 he was minister of posts and telegraphs, and in January 1888 he was elected to the senate. He died in 1900.

His son, **GEORGES CHARLES PAUL**, born in 1855, was in his father's department from 1879 till 1885, deputy from 1885, five times president of the Budget Commission, minister of finance (1895-1898) and vice-president of the chamber (1898-1902), and again finance minister in the Briand Cabinet, 1909.

COCHIN, DENYS MARIE PIERRE AUGUSTIN (1851-), French politician, was born at Paris. He studied law, was elected to the chamber of deputies in 1893, and gradually became one of the leaders and principal orators of the Conservative party. He opposed the project of the income-tax in 1894, the revision of the Dreyfus case in 1899, and the separation of the church and state in 1905. He is known as an author by his works,

L'Évolution de la vie (1895); *Le Monde extérieur* (1895); *Contre les barbares* (1899); *Ententes et ruptures* (1905).

COCHIN, a feudatory state of southern India, in political subordination to Madras, with an area of 1,361 sq. m. It is bounded on the N. by British Malabar, on the E. by British Malabar, Coimbatore and Travancore, on the S. by Travancore, and on the W. by British Malabar and the Arabian Sea. Isolated from the main territory, and situated to the north-east of it, lies the major portion of the Chittore *taluk*, entirely surrounded by British territory. The whole state may be divided into three well-defined regions or zones: (1) the eastern zone, consisting of broken forested portions of the Western Ghats, which, gradually decreasing in height, merge into (2) the central belt, comprising the uplands and plains that dip towards the lagoons or "backwaters" along the coast (see COCHIN, town), beyond which lies (3) the western zone, forming the littoral strip. The low belt which borders on the seas and the backwaters is by nature flat and swampy, but has in the course of ages become enriched by the work of man. On leaving the seaboard, an undulating country is found, diversified with grassy flats, naked hills and wooded terraces, intersected by numerous torrents and rapids, and profusely dotted with homesteads, orchards and cultivated fields, up to the very foot of the Ghats. Here the landscape, now on a grander scale, embraces great forests which form a considerable source of wealth. Of the total area of the state the forests and lagoons cover nearly 605 and 16 sq. m. respectively.

In 1901 the population was 812,025, showing an increase of 12% in the decade. More than one-fifth are Christians, mostly Syrians and Roman Catholics. The revenue is estimated at £153,000, subject to a tribute of £13,000. During recent years the financial condition of the state has been flourishing. The principal products are rice, cocoanuts, timber, cardamoms, pepper and a little coffee. Salt is manufactured along the coast. The capital is Ernakulam, but the raja resides at Tripunthura. The principal commercial centre is Mattancheri, adjoining the British town of Cochin. The chief means of communication is by boat along the backwaters; but in 1902 a metre-gauge line was constructed by the Madras railway at the expense of the state to connect Ernakulam with Shoranur.

History.—What is now the native state of Cochin formed, until about the middle of the 9th century A.D., part of the ancient Chera or Kerala kingdom (see KERALA). Its port of Kodungalur (Kranganur, the ancient Muziris), at the mouth of the Periyar, was from early times one of the chief centres for the trade between Europe and India; and it was at Malankara, near Kodungalur, that the apostle Thomas is traditionally said to have landed. The history of Cochin is, however, like that of the Kerala kingdom generally, exceedingly obscure previous to the arrival of the Portuguese. The rajas of Cochin, who are of pure Kshatriya blood, claim descent from the Chera king Cheraman Perumal, the last of his race to rule the vast tract from Gokarn in North Kanara to Cape Comorin. About the middle of the 9th century this king, according to tradition, resigned his kingdom, embraced Islam, and went on pilgrimage to Arabia, where he died. Towards the end of the century the Chera kingdom was overrun and dismembered by the Cholas. It was in 1498 that Vasco da Gama reached the Malabar coast; and in 1502 the Portuguese were allowed to settle in the town of Cochin, where they built a fort and began to organize trade with the surrounding country. By the end of the century their influence had become firmly established, largely owing to the effective aid they had given to the rajas of Cochin in their wars with the Zamorin of Calicut. The Syrian Christians, forming at that time a large proportion of the population, now felt the weight of Portuguese ascendancy; in 1599 Menezes, the archbishop of Goa, held a synod at Udayamperur (Diamper), a village 12 m. south-east of Cochin, at which their tenets were pronounced heretical and their service-books purged of all Nestorian phrases. In 1663, however, Portuguese domination came to an end with the capture of Cochin by the Dutch, whose ascendancy continued for about a hundred years. In 1756 Hyder Ali of Mysore invaded the

state and forced the raja to acknowledge his suzerainty and pay tribute. In 1791 Tippoo, son of Hyder Ali, ceded the sovereignty to the British, who entered into a treaty with the raja by which he became their vassal and paid an annual tribute of a lakh of rupees. On the 17th of October 1809, in consequence of an attempt of the hereditary chief minister Paliyath Achan, in 1808, to raise an insurrection against the British without his master's knowledge, a fresh treaty was made, by which the raja undertook to hold no correspondence with any foreign state and to admit no foreigners to his service without the sanction of the British government, which, while undertaking to defend the raja's territories against all enemies, reserved the right to dismantle or to garrison any of his fortresses. In 1818 the tribute, raised to 2½ lakhs in 1808, was permanently fixed at 2 lakhs. Since then, under the rule of the rajas, the state has greatly advanced in prosperity, especially under that of H.H. Sir Sri Rama Varma (b. 1852), who succeeded in 1895, was made a K.C.S.I. in 1897, and G.C.S.I. in 1903.

COCHIN, a town of British India, in the district of Malabar, Madras. Pop. (1901) 19,274. The town lies at the northern extremity of a strip of land about 12 m. in length, but in few places more than a mile in breadth, which is nearly insulated by inlets of the sea and estuaries of streams flowing from the Western Ghats. These form the Cochin backwaters, which consist of shallow lagoons lying behind the beach-line and below its level. In the monsoon the Cochin backwaters are broad navigable channels and lakes; in the hot weather they contract into shallows in many places not 2 ft. deep. The town of Cochin is about a mile in length by half a mile in breadth. Its first European possessors were the Portuguese. Vasco da Gama founded a factory in 1502, and Albuquerque built a fort, the first European fort in India, in 1503. The British made a settlement in 1634, but retired when the Dutch captured the town in 1663. Under the Dutch the town prospered, and about 1778 an English traveller described it as a place of great trade, "a harbour filled with ships, streets crowded with merchants, and warehouses stored with goods from every part of Asia and Europe, marked the industry, the commerce, and the wealth of the inhabitants." In 1795 Cochin was captured from the Dutch by the British, and in 1806 the fortifications and public buildings were blown up by order of the authorities. The explosion destroyed much private property, and for a long time seriously affected the prosperity of the town. Considerable sea-borne trade is still carried on. A lighthouse stands on the ruins of the old fort. The chief exports are coconut products, for the preparation of which there are factories, and tea; and the chief import is rice. Cochin is the only port south of Bombay in which large ships can be built.

COCHIN-CHINA,¹ a French colony in the extreme south of French Indo-China. The term formerly included the whole Annamese empire—Tongking, Annam, and Lower Cochin-China, but it now comprises only the French colony, which corresponds to Lower Cochin-China, and consists of the six southern provinces of the Annamese empire annexed by France in 1862 and 1867. Cochin-China is bounded W. by the Gulf of Siam, N.W. and N. by Cambodia, E. by Annam, and S.E. by the China Sea. Except along part of the north-west frontier, where the canal of Vinh-Thé divides it from Cambodia, its land-limits are conventional. Its area is about 22,000 sq. m.

In 1901 the population numbered 2,968,529, of whom 4932 were French (exclusive of French troops, who numbered 2537), 2,558,301 Annamese, 231,902 Cambodians, 92,075 Chinese, 42,940 savages (Min Huong), the rest being Asiatics of other nationalities, together with a few Europeans other than French.

Geography.—Cochin-China consists chiefly of an immense plain, flat and monotonous, traversed by the Mekong and extending from Ha-Tien in the west to Baria in the east, and from Bien-Hoa in the north-east to the southern point of the peninsula of Ca-Mau in the south-west. The last spurs of the mountains of Annam, which come to an end at Cape St Jacques, extend over parts of the provinces of Tay-Ninh, Bien-Hoa and Baria in the north-east and east of the colony, but nowhere exceed 2900 ft.

¹ See also INDO-CHINA, FRENCH; and ANNAM.

in height; low hills are found in the north-western province of Chau-Doc. Cochin-China is remarkable for the abundance of its waterways. The Mekong divides at Pnom-Penh in Cambodia into two arms, the Fleuve supérieur and the Fleuve inférieur, which, pursuing a course roughly parallel from north-west to south-east, empty into the China Sea by means of the numerous channels of its extensive delta. From June to October the inundations of the Mekong cover most of the country, portions of which, notably the Plaine des Joncs in the north and a large tract of the peninsula of Ca-Mau, are little else than marshes. Besides a great number of small coastal streams there are four other rivers of secondary importance, all of which water the east of the colony, viz. the Don-Nai, which rising in the Annamese mountains flows west, then abruptly south, reaching the sea to the west of Cape St Jacques; the Saigon river, which flowing from north-west to south-east passes Saigon, the capital of the colony, 12 m. below which it unites with the Don-Nai; and the two Vaicos, which join the Don-Nai close to its mouth. These rivers flow into the sea through numerous winding channels, forming a delta united by canals to that of the Mekong. The waterways of Cochin-China communicate by means of natural or artificial channels (*arroyos*), facilitating transport and aiding in the uniform distribution of the inundation to which the country owes its fertility. Canals from Chau-Doc to Ha-Tien and from Long Xuyen to Rach-Gia join the Mekong with the Gulf of Siam. East of Cape St Jacques the mountains of Annam come down close to the sea; west of that point, as far as the southern headland of Ca-Mau, the coast-line of Cochin-China runs north-east to south-west for about 160 m. in a straight line broken only by the mouths of the Don-Nai and Mekong. From Cape Ca-Mau to Rach-Gia it runs north for a distance of 120 m., then north-west as far as Ha-Tien, where the boundary line between it and Cambodia meets the sea.

Climate and Fauna.—The climate of the country is warm, humid, and very trying to Europeans. The wet season, during which heavy rain falls almost daily, lasts from April to October, coinciding with the south-west monsoon. The hottest period lasts from the middle of April to the middle of June, the thermometer during that time often reaching 94° F., and never descending below 86°. The forest regions of Cochin-China harbour the tiger, panther, leopard, tiger-cat, ichneumon, wild boar, deer, buffalo, rhinoceros and elephant, as well as many varieties of monkeys and rats. Of birds some species of parakeet, the "mandarin" blackbird, and the woodcock are not found in the rest of Indo-China. Duck, teal, cranes and other aquatic birds abound in the delta. Venomous reptiles are numerous, and the Mekong contains crocodiles.

Agriculture and Industries.—The cultivation of the rice-fields, which cover large extents of the plains of Cochin-China, is by far the chief industry of the colony. Pepper is grown in considerable quantities in the districts of Ha-Tien and Bien-Hoa, and sugar-canes, coffee, cotton, tobacco and jute are also produced. The buffalo, used both for transport and in the rice-fields, and swine, the flesh of which forms an important element in the native diet, are the principal domestic animals. Oxen and cows are of secondary importance and the climate is unsuitable for sheep; horses of a small breed are used to some extent. The chief industrial establishments are those for the decortication of rice at Saigon and Cholon; they are in the hands of the Chinese, by whom most of the trade in the colony is conducted. Sugar-making, the distillation of rice-spirit, silk-weaving, fishing and the preparation of a fish-sauce (*nuoc-mam*) made from decayed fish, and the manufacture of salt from sea-water and of lime are carried on in many localities.

Commerce.—Rice is the chief article of export, dried or salted fish, pepper and cotton ranking next in order of value. Imports include woven goods, metals, ironware, machinery, tea, wines and spirits, mineral oils, opium, paper, and arms and powder. The ports of Saigon and Mytho are accessible to the largest vessels, and are connected by a railway (see INDO-CHINA, FRENCH). The roadsteads of Rach-Gia, Ca-Mau, and Ha-Tien can accommodate only vessels of low tonnage. In 1905 exports

reached a value of £3,816,000, and imports a value of £4,834,000 (not including treasure and transit trade).

Government and Administration.—Cochin-China is administered by a lieutenant-governor under the authority of the governor-general of Indo-China. He is assisted by the *conseil colonial* numbering sixteen members, six of whom are French citizens elected by the French, six natives elected by the natives, the other four being members of the chamber of commerce of Saigon and the *conseil privé*. The *conseil colonial*, besides its advisory functions, discusses and votes the budget, determines the nature of the taxes, has supreme control over the tariffs, and extensive powers in the administration of colonial domains. The *conseil privé* is a deliberative body under the presidency of the lieutenant-governor, composed of colonial officials together with two native members. The colony is divided into four circumscriptions (Saigon, My-Tho, Vinh-Long, Bassac), at the head of each of which is an inspector of native affairs. These are subdivided into twenty provinces, each administered by an administrator of native affairs by whose side is the provincial council consisting of natives and occupied with the discussion of ways and means and questions of public works. The provinces are divided into cantons and subdivided into communes. The commune forms the basis of the native social system. Its assembly of notables or municipal council forms a sort of oligarchy, the members of which themselves elect individuals from among the more prominent inhabitants to fill vacancies. The notables elect the provincial councillors in the proportion, usually, of one to every canton, and their delegates elect the chief of the canton, who voices the wishes of the natives to the government. Local administration, e.g. supervision of markets, policing, land-transfer, &c., are carried on by a mayor and two assistants, to whom the municipal council delegates its powers. The same body draws up the list of males liable to the poll-tax and of the lands liable to land-tax, these being the chief sources of revenue. There are French tribunals of first instance in nine of the chief towns of the colony, and in four of these there are criminal courts. These administer justice in accordance both with French law and, in the case of natives, with Annamese law, which has been codified for the purpose. Saigon has two chambers of the court of appeal of French Indo-China and a tribunal of commerce. Primary instruction is given in some six hundred schools. Cochin-China is represented in the French chamber by a deputy. The capital is Saigon (*q.v.*); of the other towns, Cholon (*q.v.*), My-Tho, Vinh-Long and Chau-Doc are of importance.

In 1904 the budget receipts amounted to £495,241 (as compared with £474,545 in 1899). To this sum the land and poll-tax and other direct taxes contributed £374,630. The main heads of expenditure, of which the total was £467,328, were as follows:—

Government	£87,271
Administration	62,725
Public Works	40,454
Transport	38,173
Public Instruction	36,009
Topography and Surveying	32,036

History.—The Khmer kingdom (see CAMBODIA), at its zenith from the 9th to the 12th centuries, included a large portion of the modern colony of Cochin-China, the coastal portion and perhaps the eastern region being under the dominion of the empire of Champa, which broke up during the 15th century. This eastern region was occupied in the 17th century by the Annamese, who in the 18th century absorbed the western provinces. From this period the history of Cochin-China follows that of Annam (*q.v.*) till 1867, when it was entirely occupied by the French and became a French colony. In 1887 it was united with Cambodia, Annam and Tongking to form the Indo-Chinese Union (see INDO-CHINA, FRENCH).

COCHINEAL, a natural dye-stuff used for the production of scarlet, crimson, orange and other tints, and for the preparation of lake and carmine. It consists of the females of *Coccus cacti*, an insect of the family *Coccidae* of the order *Hemiptera*, which feeds upon various species of the *Cactaceae*, more especially the nopal plant, *Opuntia coccinellifera*, a native of Mexico and Peru.

The dye was introduced into Europe from Mexico, where it had been in use long before the entrance of the Spaniards in the year 1518, and where it formed one of the staple tributes to the crown for certain districts. In 1523 Cortes received instructions from the Spanish court to procure it in as large quantities as possible. It appears not to have been known in Italy so late as the year 1548, though the art of dyeing then flourished there. Cornelius van Drebbel, at Alkmaar, first employed cochineal for the production of scarlet in 1650. Until about 1725 the belief was very prevalent that cochineal was the seed of a plant, but Dr Martin Lister in 1672 conjectured it to be a kind of kermes, and in 1703 Antony van Leeuwenhoek ascertained its true nature by aid of the microscope. Since its introduction cochineal has supplanted kermes (*Coccus ilicis*) over the greater part of Europe.

The male of the cochineal insect is half the size of the female, and, unlike it, is devoid of nutritive apparatus; it has long white wings, and a body of a deep red colour, terminated by two diverging setae. The female is apterous, and has a dark-brown plano-convex body; it is found in the proportion of 150 to 200 to one of the male insect. The dead body of the mother insect serves as a protection for the eggs until they are hatched. Cochineal is now furnished not only by Mexico and Peru, but also by Algiers and southern Spain. It is collected thrice in the seven months of the season. The insects are carefully brushed from the branches of the cactus into bags, and are then killed by immersion in hot water, or by exposure to the sun, steam, or the heat of an oven—much of the variety of appearance in the commercial article being caused by the mode of treatment. The dried insect has the form of irregular, fluted and concave grains, of which about 70,000 go to a pound. Cochineal has a musty and bitterish taste. There are two principal varieties—*silver cochineal*, which has a greyish-red colour, and the furrows of the body covered with a white bloom or fine down; and *black cochineal*, which is of a dark reddish brown, and destitute of bloom. *Granilla* is an inferior kind, gathered from uncultivated plants. The best crop is the first of the season, which consists of the unimpregnated females; the later crops contain an admixture of young insects and skins, which contain proportionally little colouring matter.

The black variety of cochineal is sometimes sold for silver cochineal by shaking it with powdered talc or heavy-spar; but these adulterations can be readily detected by means of a lens. The duty in the United Kingdom on imported cochineal was repealed in 1845.

Cochineal owes its tinctorial power to the presence of a substance termed cochinealin or carminic acid, $C_{17}H_{13}O_{10}$, which may be prepared from the aqueous decoction of cochineal. Cochineal also contains a fat and wax; cochineal wax or coccerin, $C_{30}H_{40}(C_{31}H_{61}O_3)_2$, may be extracted by benzene, the fat is a glyceryl myristate $C_3H_5(C_{14}H_{27}O_2)_3$.

COCHLAEUS, JOHANN (1479–1552), German humanist and controversialist, whose family name was Dobneck, was born of poor parents in 1479 at Wendelstein (near Nuremberg), whence his friends gave him the punning surname Cochlaeus (spiral), for which he occasionally substituted Wendelstinus. Having received some education at Nuremberg from the humanist Heinrich Grieninger, he entered (1504) the university of Cologne. In 1507 he graduated, and published under the name of Wendelstein his first piece, *In musicam exhortatorium*. He left Cologne (May 1510) to become schoolmaster at Nuremberg, where he brought out several school manuals. In 1515 he was at Bologna, hearing (with disgust) Eck's famous disputation against usury, and associating with Ulrich von Hutten and humanists. He took his doctor's degree at Ferrara (1517), and spent some time in Rome, where he was ordained priest. In 1520 he became dean of the Liebfrauenkirche at Frankfurt, where he first entered the lists as a controversialist against the party of Luther, developing that bitter hatred to the Reformation which animated his forceful but shallow ascription of the movement to the meanest motives, due to a quarrel between the Dominicans and Augustinians. Luther would not meet him in discussion at Mainz in 1521. He was present at the diets of Worms, Regensburg, Spire and

Augsburg. The peasants' war drove him from Frankfort; he obtained (1526) a canonry at Mainz; in 1529 he became secretary to Duke George of Saxony, at Dresden and Meissen. The death of his patron (1539) compelled him to take flight. He became canon (September 1539) at Breslau, where he died on the 10th of January 1552. He was a prolific writer, largely of overgrown pamphlets, harsh and furious. His more serious efforts retain no permanent value. With humanist convictions, he had little of the humanist spirit. We owe to him one of the few contemporary notices of the young Servetus.

See C. Otto, *Johannes Cochlaeus, der Humanist* (1874); Haas, in I. Goschler's *Dict. encyclopéd. de la théol. cath.* (1858); Brecher, in *Allgemeine deutsche Biographie* (1876); T. Kolde, in A. Hauck's *Realencyklopädie für prol. Theol. u. Kirche* (1898). (A. Go.)

COCK, EDWARD (1805–1892), British surgeon, was born in 1805. He was a nephew of Sir Astley Cooper, and through him became at an early age a member of the staff of the Borough hospital in London, where he worked in the dissecting room for thirteen years. Afterwards he became in 1838 assistant surgeon at Guy's, where from 1849 to 1871 he was surgeon, and from 1871 to 1892 consulting surgeon. He rose to be president of the College of Surgeons in 1869. He was an excellent anatomist, a bold operator, and a clear and incisive writer, and though in lecturing he was afflicted with a stutter, he frequently utilized it with humorous effect and emphasis. From 1843 to 1849 he was editor of *Guy's Hospital Reports*, which contain many of his papers, particularly on stricture of the urethra, puncture of the bladder, injuries to the head, and hernia. He was the first English surgeon to perform pharyngotomy with success, and also one of the first to succeed in trephining for middle meningeal haemorrhage; but the operation by which his name is known is that of opening the urethra through the perinaeum (see *Guy's Hospital Reports*, 1866). He died at Kingston in 1892.

COCKADE (Fr. *cocarde*, in 16th century *coquarde*, from *coq*, in allusion probably to the cock's comb), a knot of ribbons or a rosette worn as a badge, particularly now as part of the livery of servants. The cockade was at first the button and loop or clasp which "cocked" up the side of an ordinary slouch hat. The word first appears in this sense in Rabelais in the phrase "*bonnet à la coquarde*," which is explained by Cotgrave (1611) as a "Spanish cap or fashion of bonnet used by substantial men of yore . . . worne proudly or peartly on th' one side." The bunch of ribbons as a party badge developed from this entirely utilitarian button and loop. The Stuarts' badge was a white rose, and the resulting white cockade figured in Jacobite songs after the downfall of the dynasty. William III.'s cockade was of yellow, and the House of Hanover introduced theirs of black, which in its present spiked or circular form of leather is worn in England to-day by the royal coachmen and grooms, and the servants of all officials or members of the services. At the battle of Sheriffmuir in the reign of George I. the English soldiers wore a black rosette in their hats, and in a contemporary song are called "the red-coat lads wi' black cockades." At the outbreak of the French Revolution of 1789, cockades of green ribbon were adopted. These afterwards gave place to the tricolour cockade, which is said to have been a mixture of the traditional colours of Paris (red and blue) with the white of the Bourbons, the early Revolutionists being still Royalists. The French army wore the tricolour cockade until the Restoration. To-day each foreign nation has its special coloured cockade. Thus the Austrian is black and yellow, the Bavarian light blue and white, the Belgian black, yellow and red, French the tricolour, Prussian black and white, Russian green and white, and so on, following usually the national colours. Originally the wearing of a cockade, as soon as it had developed into a badge, was restricted to soldiers, as "to mount a cockade" was "to become a soldier." There is still a trace of the cockade as a badge in certain military headgears in England and elsewhere. Otherwise it has become entirely the mark of domestic service. The military cocked hat, the lineal descendant of the *bonnet à la coquarde*, became the fashion in France during the reign of Louis XV.

See *Genealogical Magazine*, vols. i.-iii. (London, 1897–1899); Racinet, *La Costume historique* (6 vols., Paris, 1888).

COCKAIGNE (COCKAYNE), LAND OF (O. Fr. *Coquaigne*, mod. Fr. *cognac*, "abundance," from Ital. *Cocagna*; "as we say 'Lubberland,' the epicure's or glutton's home, the land of all delights, so taken in mockerie": Florio), an imaginary country, a medieval Utopia where life was a continual round of luxurious idleness. The origin of the Italian word has been much disputed. It seems safest to connect it, as do Grimm and Littré, ultimately with Lat. *coquere*, through a word meaning "cake," the literal sense thus being "The Land of Cakes." In Cockaigne the rivers were of wine, the houses were built of cake and barley-sugar, the streets were paved with pastry, and the shops supplied goods for nothing. Roast geese and fowls wandered about inviting folks to eat them, and buttered larks fell from the skies like manna. There is a 13th-century French *fabliau*, *Cocaigne*, which was possibly intended to ridicule the fable of the mythical Avalon, "the island of the Blest." The 13th-century English poem, *The Land of Cockaygne*, is a satire on monastic life. The term has been humorously applied to London, and by Boileau to the Paris of the rich. The word has been frequently confused with Cockney (*q.v.*).

See D. M. Méon, *Fabliaux et contes* (4 vols., 1808), and F. J. Furnivall, *Early English Poems* (Berlin, 1862).

COCKATOO (*Cacatuidae*), a family of parrots characterized among Old World forms by their usually greater size, by the crest of feathers on the head, which can be raised or depressed at will, and by the absence of green in their coloration. They inhabit the Indian Archipelago, New Guinea and Australia, and are gregarious, frequenting woods and feeding on seeds, fruits and the larvae of insects. Their note is generally harsh and unmusical, and although they are readily tamed when taken young becoming familiar, and in some species showing remarkable intelligence, their powers of vocal imitation are usually limited. Of the true cockatoos (*Cacatua*) the best known is the sulphur-crested cockatoo (*Cacatua galerita*), of a pure white plumage with the exception of the crest, which is deep sulphur yellow, and of the ear and tail coverts, which are slightly tinged with yellow. The crest when erect stands 5 in. high. These birds are found in Australia in flocks varying from 100 to 1000 in number, and do great damage to newly-sown grain, for which reason they are mercilessly destroyed by farmers. They deposit their eggs—two in number, and of a pure white colour—in the hollows of decayed trees or in the fissures of rocks, according to the nature of the locality in which they reside. This is one of the species most usually kept in Europe as a cage bird. Leadbeater's Cockatoo (*Cacatua Leadbeateri*), an inhabitant of South Australia, excels all others in the beauty of its plumage, which consists in great part of white, tinged with rose colour, becoming a deep salmon colour under the wings, while the crest is bright crimson at the base, with a yellow spot in the centre and white at the tip. It is exceedingly shy and difficult of approach, and its note is more plaintive while less harsh than that of the preceding species. In the cockatoos belonging to the genus *Calyptorhynchus* the general plumage is black or dark brown, usually with a large spot or band of red or yellow on the tail. The largest of these is known as the funereal cockatoo (*Calyptorhynchus funereus*), from the lugubrious note or call which it utters, resembling the two syllables Wy—la—, the native name of the species. It deposits its eggs in the hollows of the large gum-trees of Australia, and feeds largely on the larvae of insects, in search of which it peels off the bark of trees, and when thus employed it may be approached closely. The cockateel (*Calopsittacus novae-hollandiae*), the only species in the family smaller than a pigeon, and with a long pointed tail, is a common aviary bird, and breeds freely in captivity.

COCKATRICE, a fabulous monster, the existence of which was firmly believed in throughout ancient and medieval times,—descriptions and figures of it appearing in the natural history works of such writers as Pliny and Aldrovandus, those of the latter published so late as the beginning of the 17th century. Produced from a cock's egg hatched by a serpent, it was believed to possess the most deadly powers, plants withering at its touch, and men and animals dying poisoned by its look. It stood in

awe, however, of the cock, the sound of whose crowing killed it, and consequently travelers were wont to take this bird with them in travelling over regions supposed to abound in cockatrices. The weasel alone among mammals was unaffected by the glance of its evil eye, and attacked it at all times successfully; for when wounded by the monster's teeth it found a ready remedy in rue—the only plant which the cockatrice could not wither. This myth reminds one of the real contests between the weasel-like mungoos of India and the deadly cobra, in which the latter is generally killed. The term "cockatrice" is employed on four occasions in the English translation of the Bible, in all of which it denotes nothing more than an exceedingly venomous reptile; it seems also to be synonymous with "basilisk," the mythical king of serpents.

COCKBURN, SIR ALEXANDER JAMES EDMUND, 10th Bart. (1802–1880), lord chief justice of England, was born on the 24th of December 1802, of ancient Scottish stock. He was the son of Alexander, fourth son of Sir James Cockburn, 6th baronet, his three uncles, who had successively held the title, dying without heirs. His father was British envoy extraordinary and minister plenipotentiary to the state of Columbia, and married Yolande, daughter of the vicomte de Vignier. Young Alexander was at one time intended for the diplomatic service, and frequently during the legal career which he ultimately adopted he was able to make considerable use of the knowledge of foreign languages, especially French, with which birth and early education had equipped him. He was educated at Trinity Hall, Cambridge, of which he was elected a fellow, and afterwards an honorary fellow. He entered at the Middle Temple in 1825, and was called to the bar in 1829. He joined the western circuit, and for some time such practice as he was able to obtain lay at the Devon sessions, quarter sessions at that time affording an opening and a school of advocacy to young counsel not to be found anywhere fifty years later. In London he had so little to do that only the persuasion of friends induced him to keep his London chambers open. Three years after his call to the bar, however, the Reform Bill was passed, and the petitions which followed the ensuing general election gave rise to a large number of new questions for the decision of election committees, and afforded an opening of which he promptly availed himself. The decisions of the committees had not been reported since 1821, and with M. C. Rowe, another member of the western circuit, Cockburn undertook a new series of reports. They only published one volume, but the work was well done, and in 1833 Cockburn had his first parliamentary brief.

In 1834 Cockburn was well enough thought of to be made a member of the commission to inquire into the state of the corporations of England and Wales. Other parliamentary work followed; but he had ambition to be more than a parliamentary counsel, and attended diligently on his circuit, besides appearing before committees. In 1841 he was made a Q.C., and in that year a charge of simony, brought against his uncle, William, dean of York, enabled him to appear conspicuously in a case which attracted considerable public attention, the proceedings taking the form of a motion for prohibition duly obtained against the ecclesiastical court, which had deprived Dr Cockburn of his office. Not long after this, Sir Robert Peel's secretary, Edward Drummond, was shot by the crazy Scotsman, Daniel M'Naughten, and Cockburn, briefed on behalf of the assassin, not only made a very brilliant speech, which established the defence of insanity, but also secured the full publicity of a long report in the *Morning Chronicle* of the 6th of March 1843. Another well-known trial in which he appeared a year later was that of *Wood v. Peel* (*The Times*, 2nd and 3rd of July 1844), the issue being in form to determine the winner of a bet (the Gaming Act was passed in the following year) as to the age of the Derby winner Running Rein—in substance to determine, if possible, the vexed question whether Running Rein was a four-year-old or a three-year-old when he was racing as the latter. Running Rein could not be produced by Mr Wood, and Baron Alderson took a strong view of this circumstance, so that Cockburn found himself on the losing side, while his strenuous advocacy of his client's cause had

led him into making, in his opening speech, strictures on Lord George Bentinck's conduct in the case which had better have been reserved to a later stage. He was, however, a hard fighter, but not an unfair one—a little irritable at times, but on the whole a courteous gentleman, and his practice went on increasing.

In 1847 he decided to stand for parliament, and was elected without a contest Liberal M.P. for Southampton. His speech in the House of Commons on behalf of the government in the Don Pacifico dispute with Greece commended him to Lord John Russell, who appointed him solicitor-general in 1850 and attorney-general in 1851, a post which he held till the resignation of the ministry in February, 1852. During the short administration of Lord Derby which followed, Sir Frederic Thesiger was attorney-general, and Cockburn was engaged against him in the case of *R. v. Newman*, on the prosecution of Achilli. This was the trial of a criminal information for libel filed against John Henry Newman, who had denounced a scandalous and profligate friar named Achilli, then lecturing on Roman Catholicism in England. Newman pleaded justification; but the jury who heard the case in the Queen's Bench, with Lord Campbell presiding, found that the justification was not proved except in one particular: a verdict which, together with the methods of the judge and the conduct of the audience, attracted considerable comment. The verdict was set aside, and a new trial ordered, but none ever took place. In December 1852, under Lord Aberdeen's ministry, Cockburn became again attorney-general, and so remained until 1856, taking part in many celebrated trials, such as the Hopwood Will Case in 1855, and the Swynfen Will Case, but notably leading for the crown in the trial of William Palmer of Rugeley in Staffordshire—an ex-medical man who had taken to the turf, and who had poisoned a friend of similar pursuits named Cook with strychnine, in order to obtain money from his estate by forgery and otherwise. Cockburn made an exhaustive study of the medical aspects of the case, and the prisoner's comment when convicted after a twelve days' trial was, alluding to the attorney-general's advocacy, "It was the riding that did it." In 1854 Cockburn was made recorder of Bristol. In 1856 he became chief justice of the common pleas. He inherited the baronetcy in 1858. In 1859 Lord Campbell became chancellor, and Cockburn became chief justice of the Queen's Bench, continuing as a judge for twenty-four years and dying in harness. On Friday, the 19th of November 1880, he tried causes with special juries at Westminster; on Saturday, the 20th, he presided over a court for the consideration of crown cases reserved; he walked home, and on that night he died of *angina pectoris* at his house in Hertford Street.

Sir Alexander Cockburn earned and deserved a high reputation as a judge. He was a man of brilliant cleverness and rapid intuition rather than of profound and laboriously cultivated intellect. He had been a great advocate at the bar, with a charm of voice and manner, fluent and persuasive rather than learned; but before he died he was considered a good lawyer, some assigning his unquestioned improvement in this respect to his frequent association on the bench with Blackburn. He had notoriously little sympathy with the Judicature Acts. Many were of opinion that he was inclined to take an advocate's view of the cases before him, making up his mind as to their merits prematurely and, in consequence, wrongly, as well as giving undue prominence to the views which he so formed; but he was beyond doubt always in intention, and generally in fact, scrupulously fair. It is not necessary to enumerate the many *causes célèbres* at which Sir Alexander Cockburn presided as a judge. It was thought that he went out of his way to arrange that they should come before him, and his successor, Lord Coleridge, writing in 1881 to Lord Bramwell, to make the offer that he should try the murderer Lefroy as a last judicial act before retiring, added, "Poor dear Cockburn would hardly have given you such a chance." Be this as it may, Cockburn tried all cases which came before him, whether great or small, with the same thoroughness, courtesy and dignity, so that no counsel or suitor could complain that he had not been fully heard in a matter in which the issues were seemingly trivial; while he

certainly gave great attention to the elaboration of his judgments and charges to juries. He presided at the Tichborne trial at Bar, lasting 188 days, of which his summing-up occupied eighteen.

The greatest public occasion on which Sir Alexander Cockburn acted, outside his usual judicial functions, was that of the "Alabama" arbitration, held at Geneva in 1872, in which he represented the British government, and dissented from the view taken by the majority of the arbitrators, without being able to convince them. He prepared, with Mr C. F. Adams, the representative of the United States, the English translation of the award of the arbitrators, and published his reasons for dissenting in a vigorously worded document which did not meet with universal commendation. He admitted in substance the liability of England for the acts of the "Alabama," but not on the grounds on which the decision of the majority was based, and he held England not liable in respect of the "Florida" and the "Shenandoah."

In personal appearance Sir Alexander Cockburn was of small stature, but great dignity of deportment. He was fond of yachting and sport, and was engaged in writing a series of articles on the "History of the Chase in the Nineteenth Century" at the time of his death. He was fond, too, of society, and was also throughout his life addicted to frivolities not altogether consistent with advancement in a learned profession, or with the positions of dignity which he successively occupied. At the same time he had a high sense of what was due to and expected from his profession; and his utterance upon the limitations of advocacy, in his speech at the banquet given in the Middle Temple Hall to M. Berryer, the celebrated French advocate, may be called the classical authority on the subject. Lord Brougham, replying for the guests other than Berryer, had spoken of "the first great duty of an advocate to reckon everything subordinate to the interests of his client." The lord chief justice, replying to the toast of "the judges of England," dissented from this sweeping statement, saying, amid loud cheers from a distinguished assembly of lawyers, "The arms which an advocate wields he ought to use as a warrior, not as an assassin. He ought to uphold the interests of his clients *per fas*, not *per nefas*. He ought to know how to reconcile the interests of his clients with the eternal interests of truth and justice" (*The Times*, 9th of November 1864). Sir Alexander Cockburn was never married, and the baronetcy became extinct at his death.

AUTHORITIES.—*The Times*, 22nd of November 1880; *Law Journal*; *Law Times*; *Solicitors' Journal*, 27th of November 1880; *Law Magazine*, new series, vol. xv. p. 193, 1851; *Ashley's Life of Lord Palmerston*; *Nash's Life of Lord Westbury*; "Reminiscences of Lord Chief Justice Coleridge," by Lord Russell of Killowen, in the *North American Review*, September 1894; *The Greville Memoirs*; *Croker's Correspondence and Diaries*; *Justin M'Carthy's History of Our Own Times*; *Serjeant Ballantine's Experiences; Bench and Bar*, by Serjeant Robinson; *Fairchild's Life of Lord Bramwell*; *Manson's Builders of Our Law*; *Burke's Peerage*, ed. 1879; *Foster's Peerage*, 1880.

COCKBURN, ALICIA, or **ALISON** (1713–1794), Scottish poet, authoress of one of the most exquisite of Scottish ballads, the "Flowers of the Forest," was the daughter of Robert Rutherford of Fairnalce, Selkirkshire, and was born on the 8th of October 1713. There are two versions of this song,—the one by Mrs Cockburn, the other by Jean Elliot (1727–1805) of Minto. Both were founded on the remains of an ancient Border ballad. Mrs Cockburn's—that beginning "I've seen the smiling of Fortune beguiling"—is said to have been written before her marriage in 1731, though not published till 1765. Anyhow, it was composed many years before Jean Elliot's sister verses, written in 1756, beginning, "I've heard them liltin' at our ewe-milkin'." Robert Chambers states that the ballad was written on the occasion of a great commercial disaster which ruined the fortunes of some Selkirkshire lairds. Later biographers, however, think it probable that it was written on the departure to London of a certain John Aikman, between whom and Alison there appears to have been an early attachment. In 1731 Alison Rutherford was married to Patrick Cockburn of Ormiston. After her marriage she knew all the intellectual and aristocratic celebrities

of her day. In the memorable year 1745 she vented her Whiggism in a squib upon Prince Charlie, and narrowly escaped being taken by the Highland guard as she was driving through Edinburgh in the family coach of the Keiths of Ravelston, with the parody in her pocket. Mrs Cockburn was an indefatigable letter-writer and a composer of parodies, squibs, toasts and "character-sketches"—then a favourite form of composition—like other wits of her day; but the "Flowers of the Forest" is the only thing she wrote that possesses great literary merit. At her house on Castle-hill, and afterwards in Crichton Street, she received many illustrious friends, among whom were Mackenzie, Robertson, Hume, Home, Monboddo, the Keiths of Ravelston, the Balcarres family and Lady Anne Barnard, the authoress of "Auld Robin Gray." As a Rutherford she was a connexion of Sir Walter Scott's mother, and was her intimate friend. Lockhart quotes a letter written by Mrs Cockburn in 1777, describing the conduct of little Walter Scott, then scarcely six years old, during a visit which she paid to his mother, when the child gave as a reason for his liking for Mrs Cockburn that she was a "virtuoso like himself." Mrs Cockburn died on the 22nd of November 1794.

See her *Letters and Memorials* . . . , with notes by T. Craig Brown (1900).

COCKBURN, SIR GEORGE, Bart. (1772–1853), British admiral, second son of Sir James Cockburn, Bart., and uncle of Lord Chief Justice Cockburn, was born in London. He entered the navy in his ninth year. After serving on the home station, and in the East Indies and the Mediterranean, he assisted, as captain of the "Minerve" (38) at the blockade of Leghorn in 1796, and fought a gallant action with the Spanish frigate "Sabina" (40) which he took. He was present at the battle of Cape St Vincent. In 1809, in command of the naval force on shore, he contributed greatly to the reduction of Martinique, and signed the capitulation by which that island was handed over to the English; for his services on this occasion he received the thanks of the House of Commons. After service in the Scheldt and at the defence of Cadiz he was sent in 1811 on an unsuccessful mission for the reconciliation of Spain and her American colonies. He was made rear-admiral in 1812, and in 1813–14, as second in command to Warren, he took a prominent part in the American War, especially in the capture of Washington. Early in 1815 he received the order of the Bath, and in the autumn of the same year he carried out, in the "Northumberland" (74), the sentence of deportation to St Helena which had been passed upon Bonaparte. In 1818 he received the Grand Cross of his order, and was made a lord of the admiralty; and the same year he was returned to parliament for Portsmouth. He was promoted to the rank of vice-admiral in 1819, and to that of admiral in 1837; he became senior naval lord in 1841, and held office in that capacity till 1846. From 1827 he was a privy councillor. In 1851 he was made admiral of the fleet, and in 1852, a year before his death, inherited the family baronetcy from his elder brother, being himself succeeded by his brother William, dean of York, who died in 1858.

See O'Byrne, *Naval Biography*; W. James, *Naval History*; *Gentleman's Magazine* for 1853.

COCKBURN, HENRY THOMAS (1779–1854), Scottish judge, with the style of Lord Cockburn, was born in Edinburgh on the 26th of October 1779. His father, a keen Tory, was a baron of the Scottish court of exchequer, and his mother was connected by marriage with Lord Melville. He was educated at the high school and the university of Edinburgh; and he was a member of the famous Speculative Society, to which Sir Walter Scott, Brougham and Jeffrey belonged. He entered the faculty of advocates in 1800, and attached himself, not to the party of his relatives, who could have afforded him most valuable patronage, but to the Whig or Liberal party, and that at a time when it held out few inducements to men ambitious of success in life. On the accession of Earl Grey's ministry in 1830 he became solicitor-general for Scotland. In 1834 he was raised to the bench, and on taking his seat as a judge in the court of session he adopted the title of Lord Cockburn. Cockburn's forensic style

was remarkable for its clearness, pathos and simplicity; and his conversational powers were unrivalled among his contemporaries. The extent of his literary ability only became known after he had passed his seventieth year, on the publication of his biography of Lord Jeffrey in 1852, and from the *Memorials of his Time*, which appeared posthumously in 1856. He died on the 26th of April 1854, at his mansion of Bonaly, near Edinburgh.

COCKER, EDWARD (1631-1675), the reputed author of the famous *Arithmetick*, the popularity of which has added a phrase ("according to Cocker") to the list of English proverbialisms, was an English engraver, who also taught writing and arithmetic. He is credited with the authorship and execution of some fourteen sets of copy slips, one of which, *Daniel's Copy-Book*, engraved by Edward Cocker, *Philomath* (1664), is preserved in the British Museum. Pepys, in his *Diary*, makes very favourable mention of Cocker, who appears to have displayed great skill in his art. *Cocker's Arithmetick*, the fifty-second edition of which appeared in 1748, and which has passed through about 112 editions in all, was not published during the lifetime of its reputed author, the first impression bearing date of 1678. Augustus de Morgan in his *Arithmetical Books* (1847) adduces proofs, which may be held to be conclusive, that the work was a forgery of the editor and publisher, John Hawkins; and there appears to be no doubt that the *Decimal Arithmetick* (1684), and the *English Dictionary* (second edition, 1715), issued by Hawkins under Cocker's name, are forgeries also. De Morgan condemns the *Arithmetick* as a diffuse compilation from older and better works, and dates "a very great deterioration in elementary works on arithmetic" from the appearance of the book, which owed its celebrity far more to persistent puffing than to its merits. He pertinently adds,—“This same Edward Cocker must have had great reputation, since a bad book under his name pushed out the good ones.”

COCKERELL, CHARLES ROBERT (1788-1863), British architect, was born in London on the 28th of April 1788. After a preliminary training in his profession, he went abroad in 1810 and studied the great architectural remains of Greece, Italy and Asia Minor. At Aegina, Phigalia and other places of interest, he conducted excavations on a large scale, enriching the British Museum with many fine fragments, and adding several valuable monographs to the literature of archaeology. Elected in 1829 an associate of the Royal Academy, he became a full member in 1836, and in 1839 he was appointed professor of architecture. On Sir John Soane's death in 1837 Cockerell was appointed architect of the Bank of England, and carried out the alterations that were judged to be necessary in that building. In addition to branch banks at Liverpool and Manchester he erected in 1830 the new library at Cambridge, and in 1845 the university galleries at Oxford, as well as the Sun and the Westminster Fire Offices in Bartholomew Lane and in the Strand; and he was joint architect of the London & Westminster Bank, Lothbury, with Sir W. Tite. On the death of Henry Lonsdale Elmes in 1847, Cockerell was selected to finish the St George's Hall, Liverpool. Cockerell's best conceptions were those inspired by classic models; his essays in the Gothic—the college at Lampeter, for instance, and the chapel at Harrow—are by no means so successful. His thorough knowledge of Gothic art, however, can be seen from his writings, *On the Iconography of Wells Cathedral*, and *On the Sculptures of Lincoln and Exeter Cathedrals*. In his *Tribute to the Memory of Sir Christopher Wren* (1838) he published an interesting collection of the whole of Wren's works drawn to one scale.

COCKERILL, WILLIAM (1759-1832), Anglo-French inventor and machinist, was born in England in 1759. He went to Belgium as a simple mechanic, and in 1799 constructed at Verviers the first wool-carding and wool-spinning machines on the continent. In 1807 he established a large machine workshop at Liège. Orders soon poured in on him from all over Europe, and he amassed a large fortune. In 1810 he was granted the rights of naturalization by Napoleon I., and in 1812 handed over the management of his business to his youngest son, JOHN COCKERILL (1790-1840)

Thanks to his own energy and ability, aided by the influence of King William I. of the Netherlands, John Cockerill largely extended his father's business. King William secured him a site at Seraing, where he built large works, including an iron-foundry and blast furnace. The construction of the Belgian railways in 1834 gave a great impetus to these works, branches of which had already been opened in France, Germany and Poland. In 1838 Cockerill met with a carriage accident which nearly proved fatal, and the prospect of his loss resulted in the credit of the firm being so badly shaken that in 1839 it was compelled to go into liquidation, the liabilities being estimated at 26 millions of francs, the assets at 18 millions. This reverse, however, was only temporary. John Cockerill had practically concluded negotiations to construct the Russian government railways, when his constitution, undermined by overwork, broke down. He died at Warsaw on the 19th of June 1840. The iron works, among the largest in Europe, are still carried on under the name of La Société Cockerill at Seraing (*q.v.*).

COCKERMOUTH, a market town in the Cocker mouth parliamentary division of Cumberland, England, 27 m. S.W. of Carlisle, on the Cocker mouth, Keswick & Penrith, the London & North Western, and the Maryport & Carlisle railways. Pop. of urban district (1901) 5355. It is pleasantly situated on the river Derwent, at the junction of the Cocker, outlying hills of the Lake District sheltering it on the north, east and south. The castle has remains of Norman work in the keep, and other ancient portions (including the gateway) of later date, but is in part modernized as a residence. The grammar school was founded in 1676. The county industrial school is established in the town. The industries include the manufacture of woollens and confectionery, tanning and engineering, and there is a considerable agricultural trade. There are coal mines in the neighbourhood. A statue was erected in 1875 to the sixth earl of Mayo, who represented the borough (abolished in 1885) from 1857 to 1868. There is a Roman fort a mile west of the town, at Papcastle.

Cockermouth (*Cokermuth, Cokermuc*) was made the head of the honour or barony of Allerdale when that barony was created and granted to Waltheof in the early part of the 12th century. At a later date the honour of Allerdale was frequently called the honour of Cockermouth. Waltheof probably built the castle, under the shelter of which the town grew up. Although it never received any royal charter, the earliest records relating to Cockermouth mention it as a borough. In 1295 it returned two members to parliament and then not again until 1640. By the Representation of the People Act of 1867 the representation was reduced to one member, and by the Redistribution Act of 1885 it was disfranchised. In 1221 William de Fortibus, earl of Albemarle, was granted a Saturday market, which later in the year was transferred to Monday, the day on which it has continued to be held ever since. The Michaelmas Fair existed in 1343, and an inquisition dated 1374 mentions two horse-fairs on Whit-Monday and at Michaelmas. In 1638 Algernon Percy, earl of Northumberland, obtained a grant of a fair every Wednesday from the first week in May till Michaelmas. The chief sources of revenue in Norman times were the valuable fisheries and numerous mills.

COCK-FIGHTING, or COCKING, the sport of pitting game-cocks to fight, and breeding and training them for the purpose. The game-fowl is now probably the nearest to the Indian jungle-fowl (*Gallus ferrugineus*), from which all domestic fowls are believed to be descended. The sport was popular in ancient times in India, China, Persia and other eastern countries, and was introduced into Greece in the time of Themistocles. The latter, while moving with his army against the Persians, observed two cocks fighting desperately, and, stopping his troops, inspired them by calling their attention to the valour and obstinacy of the feathered warriors. In honour of the ensuing victory of the Greeks cock-fights were thenceforth held annually at Athens, at first in a patriotic and religious spirit, but afterwards purely for the love of the sport. Lucian makes Solon speak of quail-fighting and cocking, but he is evidently referring to a time later than that

of Themistocles. From Athens the sport spread throughout Greece, Asia Minor and Sicily, the best cocks being bred in Alexandria, Delos, Rhodes and Tanagra. For a long time the Romans affected to despise this "Greek diversion," but ended by adopting it so enthusiastically that Columella (1st century A.D.) complained that its devotees often spent their whole patrimony in betting at the pit-side. The cocks were provided with iron spurs (*tela*), as in the East, and were often dosed with stimulants to make them fight more savagely.

From Rome cocking spread northwards, and, although opposed by the Christian church, nevertheless became popular in Great Britain, the Low Countries, Italy, Germany, Spain and her colonies. On account of adverse legislation cocking has practically died out everywhere excepting in Spain, countries of Spanish origin and the Orient, where it is still legal and extremely popular. It was probably introduced into England by the Romans before Caesar's time. William Fitz-Stephen first speaks of it in the time of Henry II. as a sport for school-boys on holidays, and particularly on Shrove Tuesday, the masters themselves directing the fights, or mains, from which they derived a material advantage, as the dead birds fell to them. It became very popular throughout England and Wales, as well as in Scotland, where it was introduced in 1681. Occasionally the authorities tried to repress it, especially Cromwell, who put an almost complete stop to it for a brief period, but the Restoration re-established it among the national pastimes. Contemporary apologists do not, in the 17th century, consider its cruelty at all, but concern themselves solely with its justification as a source of pleasure. "If Leviathan took his sport in the waters, how much more may Man take his sport upon the land?" From the time of Henry VIII., who added the famous Royal Cock-pit to his palace of Whitehall, cocking was called the "royal diversion," and the Stuarts, particularly James I. and Charles II., were among its most enthusiastic devotees, their example being followed by the gentry down to the 19th century. Gervase Markham in his *Pleasures of Princes* (1614) wrote "Of the Choyce, Ordring, Breeding and Dyeting of the fighting-Cocke for Battell," his quaint directions being of the most explicit nature. When a cock is to be trained for the pit he must be fed "three or foure daies only with old Maunchet (fine white bread) and spring water." He is then set to spar with another cock, "putting a payre of hots upon each of their heeles, which Hots are soft, bumbasted roules of Leather, covering their spurs, so that they cannot hurt each other. . . . Let them fight and buffet one another a good space." After exercise the bird must be put into a basket, covered with hay and set near the fire. "Then let him sweate, for the nature of this scowring is to bring away his grease, and to breed breath, and strength." If not killed in the fight, "the first thing you doe, you shall search his wounds, and as many as you can find you shall with your mouth sucke the blood out of them, then wash them with warm salt water, . . . give him a roule or two, and so stove him up as hot as you can."

Cocking-mains usually consisted of fights between an agreed number of pairs of birds, the majority of victories deciding the main; but there were two other varieties that aroused the particular ire of moralists. These were the "battle royal," in which a number of birds were "set," i.e. placed in the pit, at the same time, and allowed to remain until all but one, the victor, were killed or disabled, and the "Welsh main," in which eight pairs were matched, the eight victors being again paired, then four, and finally the last surviving pair. Among London cock-pits were those at Westminster, in Drury Lane, Jewin Street and Birdcage Walk (depicted by Hogarth). Over the royal pit at Whitehall presided the king's cockmaster. The pits were circular in shape with a matted stage about 20 ft. in diameter and surrounded by a barrier to keep the birds from falling off. Upon this barrier the first row of the audience leaned. Hardly a town in the kingdom was without its cockpit, which offered the sporting classes opportunities for betting not as yet sufficiently supplied by horse-racing. With the growth of the latter sport and the increased facilities for reaching the racing centres, cocking gradually declined, especially after parliament passed

laws against it, so that gentlemen risked arrest by attending a main.

Among the best-known devotees of the sport was a Colonel Mordaunt, who, about 1780, took a number of the best English game-cocks to India. There he found the sport in high favour with the native rulers and his birds were beaten. Perhaps the most famous main in England took place at Lincoln in 1830 between the birds of Joseph Gulliver, the most celebrated breeder, or "feeder," of his day, and those of the earl of Derby. The conditions called for seven birds a side, and the stakes were 5000 guineas the main and 1000 guineas each match. The main was won by Gulliver by five matches to two. His grandson was also a breeder, and the blood of his cocks still runs in the best breeds of Great Britain and America. Another famous breeder was Dr Bellyse of Audlem, the principal figure in the great mains fought at Chester during race-week at the beginning of the 19th century. His favourite breed was the white pile, and "Cheshire piles" are still much-fancied birds. Others were Irish brown-reds, Lancashire black-reds and Staffordshire duns.

In Wales, as well as some parts of England, cocking-mains took place regularly in churchyards, and in many instances even inside the churches themselves. Sundays, wakes and church festivals were favourite occasions for them. The habit of holding mains in schools was common from the 12th to about the middle of the 19th century. When cocking was at its height, the pupils of many schools were made a special allowance for purchasing fighting-cocks, and parents were expected to contribute to the expenses of the annual main on Shrove Tuesday, this money being called "cockpence." Cock-fighting was prohibited by law in Great Britain in 1849.

Cocking was early introduced into America, though it was always frowned upon in New England. Some of the older states, as Massachusetts, forbade it by passing laws against cruelty as early as 1836, and it is now expressly prohibited in Canada and in most states of the Union, or is repressed by general laws for the prevention of cruelty to animals.

Cocks are fought at an age of from one to two years. "Heeling," or the proper fastening of the spurs, and "cutting out," trimming the wings at a slope, and cutting the tail down by one-third of its length and shortening the hackle and rump feathers, are arts acquired by experience. The comb is cut down close, so as to offer the least possible mark for the hostile bird's bill. The cock is then provided with either "short heels," spurs $1\frac{1}{2}$ in. or less in length, or with "long heels," from 2 to $2\frac{1}{2}$ in. in length. The training of a cock for the pit lasts from ten days to a month or more, during which time the bird is subjected to a rigid diet and exercise in running and sparring. The birds may not be touched after being set down in the pit, unless to extricate them from the matting. Whenever a bird refuses to fight longer he is set breast to breast with his adversary in the middle of the pit, and if he then still refuses to fight he is regarded as defeated. Among the favourite breeds may be mentioned the "Irish gilders," "Irish Grays," "Shawlnecks," "Gordons," "Eslin Red-Quills," "Baltimore Topknots," "Dominiques," "War-horses" and "Claibornes."

Cock-fighting possesses an extensive literature of its own. See Gervase Markham, *Pleasures of Princes* (London, 1614); Blain, *Rural Sports* (London, 1853); "Game Cocks and Cock-Fighting," *Outing*, vol. 39; "A Modest Commendation of Cock-Fighting," *Blackwood's Magazine*, vol. 22; "Cock-Fighting in Schools," *Chambers' Magazine*, vol. 65.

COCK LANE GHOST, a supposed apparition, the vagaries of which attracted extraordinary public attention in London during 1762. At a house in Cock Lane, Smithfield, tenanted by one Parsons, knockings and other noises were said to occur at night varied by the appearance of a luminous figure, alleged to be the ghost of a Mrs Kent who had died in the house some two years before. A thorough investigation revealed that Parsons' daughter, a child of eleven, was the source of the disturbance. The object of the Parsons family seems to have been to accuse the husband of the deceased woman of murdering her, with a view to blackmail. Parsons was prosecuted and condemned to the pillory. Among the crowds who visited the

house was Dr Johnson, who was in consequence made the object of a scurrilous attack by the poet Charles Churchill in "The Ghost."

See A. Lang, *Cock Lane and Common Sense* (1894).

COCKLE, SIR JAMES (1819-1895), English lawyer and mathematician, was born on the 14th of January 1819. He was the second son of James Cockle, a surgeon, of Great Oakley, Essex. Educated at Charterhouse and Trinity College, Cambridge, he entered the Middle Temple in 1838, practising as a special pleader in 1845 and being called in 1846. Joining the midland circuit, he acquired a good practice, and on the recommendation of Chief Justice Sir William Erle he was appointed chief justice of Queensland in 1863. He received the honour of knighthood in 1869, retired from the bench, and returned to England in 1879.

Cockle is more remembered for his mathematical and scientific investigations than as a lawyer. Like many young mathematicians he attacked the problem of resolving the higher algebraic equations, notwithstanding Abel's proof that a solution by radicles was impossible. In this field Cockle achieved some notable results, amongst which is his reproduction of Sir William R. Hamilton's modification of Abel's theorem. Algebraic forms were a favourite object of his studies, and he discovered and developed the theory of criticoids, or differential invariants; he also made contributions to the theory of differential equations. He displayed a keen interest in scientific societies. From 1863 to 1879 he was president of the Queensland Philosophical Society (now incorporated in the Royal Society of Queensland); on his return to England he became associated with the London Mathematical Society, of which he was president from 1886 to 1888, and the Royal Astronomical Society, serving as a member of the council from 1888 to 1892. He died in London on the 27th of January 1895.

A volume containing his scientific and mathematical researches made during the years 1864-1877 was presented to the British Museum in 1897 by his widow. See the obituary notice by the Rev. R. Harley in *Proc. Roy. Soc.* vol. 59.

COCKLE, in zoology, a mollusc (*Cardium*) of the class Lamellibranchia (*q.v.*). A very large number of species of *Cardium* have been distinguished by conchologists. Besides the common species *Cardium edule*, two others occur in Britain, but are not sufficiently common to be of commercial importance. One of these is *C. echinatum*, which is larger than the common species, reaching 3 in. in diameter, and distinguished by the presence of spines along the ribs of the shell. The other is *C. norvegicum*, which is also somewhat larger than *C. edule*, is longer dorso-ventrally than broad, and is only faintly ribbed.

The two valves of the shell of the common cockle are similar to each other, and somewhat circular in outline. The beak or umbo of each valve is prominent and rounded, and a number of sharp ridges and furrows radiate from the apex to the free edge of the shell, which is crenated. The ligament is external, and the hinge carries cardinal teeth in each valve. The interior of the shell is remarkable for the absence of pearly lustre on its interior surface. The colour externally is reddish or yellowish. The pallial line, which is the line of attachment of the mantle parallel to the edge of the shell, is not indented by a sinus at the posterior end. In the entire animal the posterior end projects slightly more than the anterior from the region of the umbones.

The animal possesses two nearly equal adductor muscles. The edges of the mantle are united posteriorly except at the anal and branchial apertures, which are placed at the ends of two very short siphons or tubular prolongations of the mantle; the siphons bear a number of short tentacles, and many of these are furnished with eye-spots. The foot is very large and powerful; it can be protruded from the anterior aperture between the mantle edges, and its outer part is bent sharply forwards and terminates in a point. By means of this muscular foot the cockle burrows rapidly in the muddy sand of the sea-shore, and it can also when it is not buried perform considerable leaps by suddenly bending the foot. The foot has a byssus gland on its posterior surface.

On either side of the body between the mantle and the foot are two flat gills each composed of two lamellae. *Cardium*

belongs to the order of Lamellibranchia in which the gills present the maximum of complexity, the original vertical filaments of which they are composed being united by interfilamentar and interlamellar junctions. In other respects the anatomy of the cockle presents no important differences from that of a typical Lamellibranch. The sexes are distinct, and the generative opening is on the side of the body above the edge of the inner lamella of the inner gill. The eggs are minute, and pass out into the sea-water through the dorsal or exhalent siphon. The breeding season is April, May and June. The larva for a time swims freely in the sea-water, having a cirlet of cilia round the body in front of the mouth, forming the velum. The shell is developed on the dorsal surface behind the velum, the foot on the opposite or ventral surface behind the mouth. After a few days, when the mantle bearing the shell valves has developed so much as to enclose the whole body, the young cockle sinks to the bottom and commences to follow the habits of the adult. The usual size of the cockle in its shell is from 1 to 2 in. in breadth.

The common cockle is regularly used as food by the poorer classes. It occurs in abundance on sandy shores in all estuaries. At the mouth of the Thames the gathering of cockles forms a considerable industry, especially at Leigh. On the coast of Lancashire also the fishery, if it may be so called, is of considerable importance. The cockles are gathered by the simple process of raking them from the sand, and they are usually boiled and extracted from their shells before being sent to market. The cockle is liable to the same suspicion as the oyster of conveying the contamination of typhoid fever where the shores are polluted, but as it is boiled before being eaten it is probably less dangerous.

(J. T. C.)

COCKNEY, a colloquial name applied to Londoners generally, but more properly confined to those born in London, or more strictly still to those born within the sound of the bells of St Mary-le-Bow church. The origin of the word has been the subject of many guesses, from that in John Minsheu's lexicon, *Ductor in linguas* (1617), which gives the tale of the town-bred child who, on hearing a horse neigh, asked whether a "cock neighed" too, to the confusion of the word with the name of the Utopia, the land of Cockaigne (*q.v.*). The historical examination of the various uses of "Cockney," by Sir James Murray (see *Academy*, 10th of May 1890, and the *New English Dictionary*, s.v.) clearly shows the true derivation. The earliest form of the word is *cokenay* or *cokeney*, i.e. the *cy* or egg, and *coken*, genitive plural of "cock," "cocks' eggs" being the name given to the small and malformed eggs sometimes laid by young hens, known in German as *Hahneneier*. An early quotation, in Langland's *Piers Plowman*, A. vii. 272, gives the combination of "cokeneyes" and bacon to make a "collop," or dish of eggs and bacon. The word then applied to a child overlong nursed by its mother, hence to a simpleton or milksop. Thus in Chaucer, *Recce's Tale*, the word is used with *daf*, i.e. a fool. The particular application of the name as a term of contempt given by country folk to town-bred people, with their dandified airs and ignorance of country ways and country objects, is easy. Thus Robert Whittington or Whittington (*fl.* 1520), speaks of the "cokneys" in such "great cytees as London, York, Perusy" (Perugia), showing the general use of the word. It was not till the beginning of the 17th century that "cockney" appears to be confined to the inhabitants of London.

The so-called "Cockney" accent or pronunciation has varied in type. In the first part of the 19th century, it was chiefly characterized by the substitution of a *v* for a *w*, or vice versa. This has almost entirely disappeared, and the chief consonantal variation which exists is perhaps the change of *th* to *f* or *v*, as in "fing" for thing, or "favver" for father. This and the vowel-sound change from *ou* to *ah*, as in "abaht" for "about," are only heard among the uneducated classes, and, together with other characteristic pronunciations, phrases and words, have been well illustrated in the so-called "coster" songs of Albert Chevalier. The most marked and widely-prevalent change of vowel sound is that of *ei* for *ai*, so that "daily" becomes "dily" and "may" becomes "my." This is sometimes so marked

that it almost amounts to incapacity to distinguish the vowels *e* and *i*, and is almost universal in large classes of the population of London. The name of the "Cockney School of Poetry" was applied in 1817 to the literary circle of which Leigh Hunt was the principal representative, though Keats also was aimed at. The articles in *Blackwood's Magazine*, in which the name appeared, have generally, but probably wrongly, been attributed to John Gibson Lockhart.

COCK-OF-THE-ROCK, the familiar name of the birds of the genus *Rupicola* (subfamily Rupicolinae) of the Cotingas (allied to the Manakins, *q.v.*), found in the Amazon valley. They are about the size of a pigeon, with orange-coloured plumage, a pronounced crest, and orange-red flesh, and build their nests on rock. The skins and feathers are highly valued for decoration.

COCKPIT, the term originally for an enclosed place in which the sport of cock-fighting (*q.v.*) was carried on. On the site of an old cockpit opposite Whitehall in London was a block of buildings used from the 17th century as offices by the treasury and the privy council, for which the old name survived till the early 19th century. The name was given also to a theatre in London, built in the early part of the 17th century on the site of Drury Lane theatre. As the place where the wounded in battle were tended, or where the junior officers consorted, the term was also formerly applied to a cabin used for these purposes on the lower deck of a man-of-war.

COCKROACH¹ (*Blattidae*), a family of orthopterous insects, distinguished by their flattened bodies, long thread-like antennae, and shining leathery integuments. Cockroaches are nocturnal creatures, secreting themselves in chinks and crevices about houses, issuing from their retreats when the lights are extinguished, and moving about with extraordinary rapidity in search of food. They are voracious and omnivorous, devouring, or at least damaging, whatever comes in their way, for all the species emit a disagreeable odour, which they communicate to whatever article of food or clothing they may touch.

The common cockroach (*Stilopyga orientalis*) is not indigenous to Europe, but is believed to have been introduced from the Levant in the cargoes of trading vessels. The wings in the male are shorter than the body; in the female they are rudimentary. The eggs, which are 16 in number, are deposited in a leathery capsule fixed by a gum-like substance to the abdomen of the female, and thus carried about till the young are ready to escape, when the capsule becomes softened by the emission of a fluid substance. The larvae are perfectly white at first and wingless, although in other respects not unlike their parents, but they are not mature insects until after the sixth casting of the skin.

The American cockroach (*Periplaneta americana*) is larger than the former, and is not uncommon in European seaports trading with America, being conveyed in cargoes of grain and other food produce. It is very abundant in the Zoological Gardens in London, where it occurs in conjunction with a much smaller imported species *Phyllodromia germanica*, which may also be seen in some of the cheaper restaurants.

In both of these species the females, as well as the males, are winged.

In addition to these noxious and obtrusive forms, England has a few indigenous species belonging to the genus *Ectobia*, which live under stones or fallen trees in fields and woods. The largest known species is the drummer of the West Indies (*Blaber gigantea*), so called from the tapping noise it makes on wood, sufficient, when joined in by several individuals, as usually happens, to break the slumbers of a household. It is about 2 in. long, with wings 3 in. in expanse, and forms one of the most noisome and injurious of insect pests. Wingless females of many tropical species present a close superficial resemblance to woodlice; and one interesting apterous form known as *Pseudoglomeris*, from the East Indies, is able to roll up like a millipede.

The best mode of destroying cockroaches is, when the fire and

¹The word is a corruption of Sp. *cucaracha*. In America it is commonly abbreviated to "roach."

lights are extinguished at night, to lay some treacle on a piece of wood afloat on a broad basin of water. This proves a temptation to the vermin too great to be resisted. The chinks and holes from which they issue should also be filled up with unslaked lime, or painted with a mixture of borax and heated turpentine.

See generally Miall and Denny, *The Structure and Life History of the Cockroach* (1887); G. H. Carpenter, *Insects: their Structure and Life* (1899); Charles Lester Marlatt, *Household Insects* (U.S. Department of Agriculture, revised edition, 1902); Leland Ossian Howard, *The Insect Book* (1902).

COCK'S-COMB, in botany, a cultivated form of *Celosia cristata* (natural order Amarantaceae), in which the inflorescence is monstrous, forming a flat "fasciated" axis bearing numerous small flowers. The plant is a low-growing herbaceous annual, bearing a large, comb-like, dark red, scarlet or purplish mass of flowers. Seeds are sown in March or April in pans of rich, well-drained sandy soil, which are placed in a hot-bed at 65° to 70° in a moist atmosphere. The seedlings require plenty of light, and when large enough to handle are potted off and placed close to the glass in a frame under similar conditions. When the heads show they are shifted into 5-in. pots, which are plunged to their rims in ashes or coco-nut fibre refuse, in a hot-bed, as before, close to the glass; they are sparingly watered and more air admitted. The soil recommended is a half-rich sandy loam and half-rotten cow and stable manure mixed with a dash of silver sand. The other species of *Celosia* cultivated are *C. pyramidalis*, with a pyramidal inflorescence, varying in colour in the great number of varieties, and *C. argentea*, with a dense white inflorescence. They require a similar cultural treatment to that given for *C. cristata*.

COCKTON, HENRY (1807-1853), English humorous novelist, was born in London on the 7th of December 1807. He published a number of volumes, but is best known as the author of *Valentine Vox, the Ventriloquist* (1840) and *Sylvester Sound, the Somnambulist* (1844). He died at Bury St Edmunds on the 26th of June 1853.

COCKX (or **COCK**), **HIERONYMUS [JEROME]** (1510-1570), Flemish painter and engraver, was born at Antwerp, and in 1545 was admitted to the Guild of St Luke as a painter. It is as an engraver, however, that he is famous, a number of portraits and subject-pictures by him, and reproductions of Flemish masters, being well known. His brother Matthys (1505-1552) was also a painter.

COCOA,² more properly CACAO, a valuable dietary substance yielded by the seeds of several small trees belonging to the genus *Theobroma*, of the natural order Sterculiaceae. The whole genus, which comprises twelve species, belongs to the tropical parts of the American continent; and although the cocoa of commerce is probably the produce of more than one species, by far the greatest and most valuable portion is obtained from *Theobroma Cacao*. The generic name is derived from *θεός* (god) and *βρώμα* (food), and was bestowed by Linnaeus as an indication of the high appreciation in which he held the beverage prepared from the seeds, which he considered to be a food fit for the gods.

The common cacao tree is of low stature, seldom exceeding 25 ft. in height, but it is taller in its native forests than it is in cultivated plantations. The leaves are large, smooth, and glossy, elliptic-oblong and tapering in form, growing principally at the ends of branches, but sometimes springing directly from the main trunk. The flowers are small, and occur in numerous clusters on the main branches and the trunk, a very marked peculiarity which gives the matured fruit the appearance of being artificially attached to the tree. Generally only a single fruit is matured from each cluster of flowers. When ripe the fruit or "pod" is elliptical-ovoid in form, from 7 to 10 in. in length and from 3 to 4½ in. in diameter. It has a hard, thick, leathery rind of a rich purplish-yellow colour, externally rough and marked with ten very distinct longitudinal ribs or elevations. The

²As a matter of nomenclature it is unfortunate that the corrupt form "cocoa," from a confusion with the coco-nut (*q.v.*), has become stereotyped. When introduced early in the 18th century it was as a trisyllable *co-co-a*, a mispronunciation of *cacao* or *cocoa*, the Spanish adaptation from the Mexican *cacaual*.

interior of the fruit has five cells, in each of which is a row of from 5 to 12 seeds embedded in a soft delicately pink acid pulp. Each fruit thus contains from 20 to 50 or more seeds, which constitute the raw cacao or "cacao beans" of commerce.

The tree appears to have been originally a native of the coast lands of the Gulf of Mexico and tropical South America as far



Branch of Cocoa Tree, with Fruit in section, much reduced.

south as the basin of the Amazon; but it can be cultivated in suitable situations within the 25th parallels of latitude. It flourishes best within the 15th parallels, at elevations ranging from near the sea-level up to about 2000 ft. in height. It is now cultivated in Mexico, Honduras, Guatemala, Nicaragua, Brazil, Peru, Ecuador, New Granada, Venezuela, Surinam, Guiana, and in many of the West Indian islands, particularly in Trinidad, San Domingo, Grenada, Cuba, Porto Rico and Jamaica. Away from America it has been introduced,

and is cultivated on a large scale in West Africa, Ceylon and the Dutch East Indies.

History.—The value of cacao was appreciated in its native country before the discovery of America by Europeans. The Spaniards found in use in Mexico a beverage known by the Aztec name of *chocolath*, from *choco* (cacao) and *lath* (water). W. H. Prescott records that the emperor Montezuma of Mexico was "exceedingly fond of it . . . no less than 50 jars or pitchers being prepared for his own daily consumption; 2000 more were allowed for that of his household." Bags of cacao containing a specified number of beans were also a recognized form of currency in the country. The product was early introduced into Spain, and thence to other parts of Europe. The *Public Advertiser* (London) of June 16, 1657, contains an announcement that "In Bishopgate St., in Queen's Head Alley, at a Frenchman's house, is an excellent West India drink, called chocolate, to be sold, where you may have it ready at any time, and also unmade at reasonable rates." Chocolate was a very fashionable beverage in the early part of the 18th century.

Cultivated Varieties.—Numerous varieties of the cacao, *i.e.* of *Theobroma Cacao*, are recognized in cultivation. According to Dr P. Preuss, who has travelled extensively in the cacao producing countries of the world studying this crop, it is impossible to embody in a single table the characteristics of the world's varieties. A separate classification is needed for almost each country. In 1882 the Trinidad forms were classified by Sir D. Morris. This table was later revised by Mr J. H. Hart, and more recently Mr R. H. Lock studied the Ceylon varieties. As the Ceylon cacaos were obtained mainly from Trinidad, and as Mr Lock's results agree substantially with those of Sir D. Morris, they serve to illustrate the distinguishing characteristics of the West Indian and Ceylon forms. The main divisions are as follows:—

1. **Criollo.**—Pods relatively thin-walled and soft, rough, pointed at apex. The seeds or beans are plump and of pale colour. The ripe pods may be either red (colorado) or yellow (amarillo).

2. **Forastero.**—Pods relatively thick-walled and hard. The seeds vary in colour from pale to deep purple. Various varieties are recognized, such as cundeamor, amelonado, liso, calabacillo, differing in shape, colour and character of beans, &c., and of each of these again there may be a colorado and amarillo sub-variety. Of special interest is calabacillo, a variety with a smooth, small pod, and deep

purple beans. It is considered by some to be sufficiently distinct to form a third type equivalent to criollo or forastero. Others again would raise amelonado to the rank of a distinct type. Of the above calabacillo is the hardiest and yields the least valuable beans; criollo is the most delicate and yields beans of the highest value, whilst forastero is intermediate in both respects. In general pale coloured beans are less bitter and more valuable than purple beans. Both, however, may occur in the same pod.

Alligator, or lagarto cacao, is the common name of a variety cultivated in Nicaragua, Guatemala, &c. Its pods are distinctly five-angled and beset with irregular, warty protuberances. Some regard it as a distinct species, *T. pentagona*, but others only as a variety of *T. Cacao*. Its produce is of high value.

T. bicolor, indigenous to Central America, is another species of some interest. It bears small, hard woody pods about 6 in. long and 3 in. in diameter, with curious surface markings. The beans possess a fetid odour and a bitter flavour and are known as "tiger cacao." It is not likely to become of great commercial importance, although consumed locally where found. "*Cecaco blanco*" and "*pataste*" are other names for this species.

Cultivation and Preparation.—Cacao requires for its successful cultivation a deep, well-watered and yet well-drained soil, shelter from strong winds, and a thoroughly tropical climate, with a mean annual temperature of about 80° F., a rainfall of from 50 to 100 or more in., and freedom from long droughts. Young plants are grown from seed, which may either be sown directly in the positions the future trees are to occupy, varying according to local circumstances from 6 to 25 ft. apart in all directions, or raised in nurseries and transplanted later. The latter course is desirable when it is necessary to water and otherwise tend the seedlings. However raised, the young plants require to be shaded, and this is usually done by planting bananas, cassava or other useful crops between the rows of cacao. In some countries, but not in all, permanent shade trees are planted amongst the cacao. Various leguminous trees are commonly used, *e.g.* the coral tree (*Erythrina* spp.) sometimes known as *bois immortel* and *madre del cacao* or mother of cacao, *Albizia Lebbek*, *Pithecolobium Saman*, &c. The various rubber trees have been employed with success. Wind belts are also necessary in exposed situations.

Cacao comes into bearing when about five years old, the small pink flowers and the succeeding large pods being borne directly on the trunk and main branches. The pods are carefully picked when ripe, broken open, and the slimy mass of contained seeds and their enveloping mucilaginous pulp extracted. The "beans" are next fermented or "sweated," often in special houses constructed for the purpose, or by placing them in heaps and covering with leaves or earth, or in baskets, barrels, &c., lined with banana leaves. During fermentation the beans should be stirred once daily or oftener. The time of fermentation varies from one to twelve or even more days. Pale-coloured beans usually require less time than the deep purple and bitter kinds. The method adopted also considerably modifies the time required. The process of fermenting destroys the mucilage; the seeds lose to some degree their bitter flavour and their colour also changes: the pale criollo seeds, for example, developing a cinnamon-brown colour. The "fracture" of the beans also characteristically alters. Fermentation is not universally practised; the purple colour and bitter taste of unfermented cacao being wanted in some markets.

After the fermentation is completed the beans may or may not be washed, opinion as to the desirability of this process varying in different countries. In any case, however, they have to be dried and cured. When climatic conditions are favourable this is commonly done by spreading the beans in thin layers on barbecues, or stone drying floors, or otherwise exposing them to the sun. Sliding roofs or other means of rapidly affording shelter are desirable in case of showers, excessive heat, and also for protection at night. Artificial drying is now often resorted to and various patterns of drying houses are in use.

The appearance of the beans may often be improved by "claying," a very slight coating of red earth or clay being added. Polishing the beans also gives them a brighter appearance,

removes mildew, and remnants of dried mucilage, &c. This may be done by "dancing the cacao," *i.e.* treading a heap with the bare feet, or by the use of special polishing machines. The cacao is now ready for shipment, and is usually packed in bags. Hamburg is the chief port in the world for cacao. Until quite recently, however, this position was held by Havre, which is now second in Europe. New York imports about the same amount as Havre. London follows next in importance.

Cacao-producing Countries.—In the following table the production in tons (of 1000 kilos=2205 lb) of the principal producing countries, arranged under continents, is given for 1905 and 1901. During this period the total world's production has increased by about 40%, as indicated in the summary below. Study of the table will show where the increase has taken place, but attention is directed especially to the rapid development in West Africa.

<i>America.</i>			
	1905 (tons).	1901 (tons).	
Ecuador	21,128	22,896	
Brazil	21,091	18,324	
Trinidad	20,018	11,943	
San Domingo	12,785	6,850	
Venezuela	11,700	7,860	
Grenada	5,456	4,865	
Cuba and Porto Rico	3,000	1,750	
Haiti	2,343	1,950	
Surinam	1,612	3,163	
Jamaica	1,484	1,350	
French West Indies	1,200	825	
St. Lucia	700	765	
Dominica	597	..	
Total, America	103,114	82,541	
<i>Africa.</i>			
	1905 (tons).	1901 (tons).	
San Thomé	25,379	16,983	
Gold Coast and Lagos	5,666	997	
Cameroons	1,185	528	
Congo Free State	195	..	
Total, Africa	32,425	18,508	
<i>Asia.</i>			
	1905 (tons).	1901 (tons).	
Ceylon	3543	2697	
Dutch East Indies	1492	1277	
Total, Asia	5035	3974	
Other countries	800	700	
<i>World's Production.</i>			
	1905 (tons).	1901 (tons).	
Tropical America and West Indies	103,114	82,541	
West Africa	32,425	18,508	
Asia	5,035	3,974	
Other countries	800	700	
Total	141,374	105,723	

Composition.—The relative weights of the various parts of a whole cacao pod are given thus by Prof. J. B. Harrison for British Guiana specimens:—

	Calabacillo.	Forastero.
Husk	80.59	89.87
Pulp	7.61	4.23
Cuticles of the beans	1.77	0.50
Kernels of the beans	10.03	5.40
	100.00	100.00

The husk is composed mainly of water and cellulose woody tissue, with their usual mineral constituents, and has a low manurial value. The pulp contains sugars which become converted into alcohol during fermentation. Fibrous elements and water compose about six-tenths of the cuticles, which also contain approximately: albuminoids (6%), alkaloids (2%), fat (2%), sugars (6%), starch (7%), colouring matter (4%), tartaric acid (3%) and small quantities of various mineral constituents. The average composition of the kernels, according to Payen, is:—

	Per cent.
Fat (cacao butter)	50
Starch	10
Albuminoids	20
Water	12
Cellulose	2
Mineral matter	4
Theobromine	2
Colouring matter (cacao-red)	trace
	100.00

Manufacture of Cocoa and Chocolate.—The beans are cleaned and sorted to remove foreign bodies of all kinds and also graded into sizes to secure uniformity in roasting. The latter process is carried out in rotating iron drums in which the beans are heated to a temperature of about 260° to 280° F., and results in developing the aroma, partially converting the starch into dextrin, and eliminating bitter constituents. The beans also dry and their shells become crisp. In the next process the beans are gently crushed and winnowed, whereby the light shells are removed, and after removal by sifting of the "germs" the beans are left in the form of the irregular cocoa-nibs occasionally seen in shops. Cocoa-nibs may be infused with water and drunk, but for most people the beverage is too rich, containing the whole of the cacao-fat or cacao-butter. This fat is extracted from the carefully ground nibs by employing great hydraulic pressure in heated presses. The fat exudes and solidifies. When fresh it is yellowish-white, but becomes quite white on keeping. It is very valuable for pharmaceutical purposes and is a constituent of many pomades. With care it can be kept for a long time without going rancid.

After the extraction of the fat the resulting mass is ground to a fine powder when it is ready for use in the ordinary way. Many preparations on the market are of course not pure cocoa but contain admixtures of various starchy and other bodies.

The shells of the beans separated by the winnowing process contain theobromine, and their infusion with water is sometimes used as a substitute for coffee, under the name "miserable." More recently they have been put to good account as a cattle food.

In the preparation of chocolate the preliminary processes of cleaning, sorting, roasting and removing the shells, and grinding the nibs, are followed as for cocoa. The fat, however, is not extracted, but sugar, and sometimes other materials also, are added to the ground pasty mass, together with suitable flavouring materials, as for example vanilla. The greatest care is taken in the process and elaborate grinding and mixing machinery employed. The final result is a semi-liquid mass which is moulded into the familiar tablets or other forms in which chocolate comes on the market.

Cocoa as a beverage has a similar action to tea and coffee, inasmuch as the physiological properties of all three are due to the alkaloids and volatile oils they contain. Tea and coffee both contain the alkaloid caffeine, whilst cocoa contains theobromine. In tea and coffee, however, we only drink an infusion of the leaves or seeds, whilst in cocoa the whole material is taken in a state of very fine suspension, and as the preceding analysis indicates, the cocoa bean, even with the fat extracted, is of high nutritive value.

Cacao-consuming Countries.—The principal cacao-consuming countries are indicated below, which gives the imports into the countries named for 1905. These figures, as also those on production, are taken from *Der Gordin*.

	Tons (1000 kilos),
United States of America	34,958
Germany	29,663
France	21,748
United Kingdom	21,106
Holland	19,295
Spain	6,102
Switzerland	5,218
Belgium	3,019
Austria Hungary	2,668
Russia	2,230
Denmark	1,125

Carry forward 147,132

	Tons (1000 kilos.)
Brought forward	147,132
Italy	971
Sweden	900
Canada	700
Australia	600
Norway, Portugal and Finland	692
Total	150,995

During recent years the use of cocoa has increased rapidly in some countries. The following table gives the increase per cent in consumption in 1905 over that in 1901 for the five chief consumers:—

	Per cent.
United States	70
Germany	61
France	21
United Kingdom	11
Holland	34
(A. B. R.; W. G. F.)	

COCO DE MER, or **DOUBLE COCO-NUT**, a palm, *Lodoicea Sechellarum*, which is a native of the Seychelles Islands. The flowers are borne in enormous fleshy spadices, the male and female on distinct plants. The fruits, which are among the largest known, take ten years to ripen; they have a fleshy and fibrous envelope surrounding a hard nut-like portion which is generally two-lobed, suggesting a large double coco-nut. The contents of the nut are edible as in the coco-nut. The empty fruits (after germination of the seed) are found floating in the Indian Ocean, and were known long before the palm was discovered, giving rise to various stories as to their origin.

COCOMA, or **CUCAMAS**, a tribe of South American Indians living on the Marañon and lower Huallaga rivers, Peru. In 1681, at the time of the Jesuit missionaries' first visit, they had the custom of eating their dead and grinding the bones to a powder, which was mixed with a fermented liquor and drunk. When expostulated with by the Jesuits they said "it was better to be inside a friend than to be swallowed up by the cold earth." They are a provident, hard-working people, partly Christianized, and bolder than most of the civilized Indians. Their languages show affinity to the Tupi-Guarani stock.

COCO-NUT¹ PALM (*Cocos nucifera*), a very beautiful and lofty palm-tree, growing to a height of from 60 to 100 ft., with a cylindrical stem which attains a thickness of 2 ft. The tree terminates in a crown of graceful waving pinnate leaves. The leaf, which may attain to 20 ft. in length, consists of a strong mid-rib, whence numerous long acute leaflets spring, giving the whole the appearance of a gigantic feather. The flowers are arranged in branching spikes 5 or 6 ft. long, enclosed in a tough spathe, and the fruits mature in bunches of from 10 to 20. The fruits when mature are oblong, and triangular in cross section, measuring from 12 to 18 in. in length and 6 to 8 in. in diameter. The fruit consists of a thick external husk or rind of a fibrous structure, within which is the ordinary coco-nut of commerce. The nut has a very hard, woody shell, enclosing the nucleus or kernel, the true seed, within which again is a milky liquid called coco-nut milk. The palm is so widely disseminated throughout tropical countries that it is impossible to distinguish its original habitat. It flourishes with equal vigour on the coast of the East Indies, throughout the tropical islands of the Pacific, and in the West Indies and tropical America. It, however, attains its greatest luxuriance and vigour on the sea shore, and it is most at home in the innumerable small islands of the Pacific seas, of the vegetation of which it is eminently characteristic. Its wide distribution, and its existence in even the smallest coral islets of the Pacific, are due to the character of the fruit, which is eminently adapted for distribution by sea. The fibrous husk renders the fruit light and the leathery skin prevents water-logging. The seed will germinate readily on the sea-shore, the seedling growing out through the soft germ-pore on the upper

¹ The spelling "cocoa-nut," which introduces a confusion with cocoa (*q.v.*) or cacao, is a corruption of the original Portuguese form, dating from (and largely due to) Johnson's *Dictionary*. The spelling "coker-nut," introduced to avoid the same ambiguity, is common in England.

end of the hard nut. The fruits dropping into the sea from trees growing on any shores would be carried by tides and currents to be cast up and to vegetate on distant coasts.

The coco-nut palm, being the most useful of its entire tribe to the natives of the regions in which it grows, and furnishing many valuable and important commercial products, is the subject of careful cultivation in many countries. On the Malabar and Coromandel coasts of India the trees grow in vast numbers; and in Ceylon, which is peculiarly well suited for their cultivation, it is estimated that twenty millions of the trees flourish. The wealth of a native in Ceylon is estimated by his property in coco-nut trees, and Sir J. Emerson Tennent noted a law case in a district court in which the subject in dispute was a claim to the 2520th part of ten of the precious palms. The cultivation of coco-nut plantations in Ceylon was thus described by Sir J. E. Tennent. "The first operation in coco-nut planting is the formation of a nursery, for which purpose the ripe nuts are placed in squares containing about 400 each; these are covered an inch deep with sand and seaweed or soft mud from the beach, and watered daily till they germinate. The nuts put down in April are sufficiently grown to be planted out before the rains of September, and they are then set out in holes 3 ft. deep and 20 to 30 ft. apart. . . . Before putting in the young plant it is customary to bed the roots with soft mud and seaweed, and for the first two years they must be watered and protected from the glare of the sun under shades made of the plaited fronds of the coco-nut palm, or the fan-like leaves of the palmyra." The palm begins to bear fruit from the fifth to the seventh year of its age, each stock carrying from 5 to 30 nuts, the tree maturing on an average 60 nuts yearly.

The uses to which the various parts of the coco-nut palm are applied in the regions of their growth are almost endless. The nuts supply no inconsiderable proportion of the food of the natives, and the milky juice enclosed within them forms a pleasant and refreshing drink. The juice drawn from the unexpanded flower spathes forms "toddy," which may be boiled down to sugar, or it is allowed to ferment and is distilled, when it yields a spirit which, in common with a like product from other sources, is known as "arrack." As in other palms, the young bud cut out of the top of the tree forms an esculent vegetable, "palm cabbage." The trunk yields a timber (known in European commerce as porcupine wood) which is used for building, furniture, firewood, &c.; the leaves are plaited into cajan fans and baskets, and used for thatching the roofs of houses; the shell of the nut is employed as a water-vessel; and the external husk or rind yields the coir fibre, with which are fabricated ropes, cordage, brushes, &c. The coco-nut palm also furnishes very important articles of external commerce, of which the principal is coco-nut oil. It is obtained by pressure or boiling from the kernels, which are first broken up into small pieces and dried in the sun, when they are known as copperah or *copra*. It is estimated that 1000 full-sized nuts will yield upwards of 500 lb. of copra, from which 25 gallons of oil should be obtained. The oil is a white solid substance at ordinary temperatures, with a peculiar, rather disagreeable odour, from the volatile fatty acids it contains, and a mild taste. Under pressure it separates into a liquid and a solid portion, the latter, coco-stearin, being extensively used in the manufacture of candles. Coco-nut oil is also used in the manufacture of marine soap, which forms a lather with sea-water. Coir is also an important article of commerce, being in large demand for the manufacture of coarse brushes, door mats and woven coir-matting for lobbies and passages. A considerable quantity of fresh nuts is imported, chiefly from the West Indies, into Britain and other countries; they are familiar as the reward of the popular English amusement of "throwing at the coco-nuts"; and the contents are either eaten raw or used as material for cakes, &c., or sweetmeats ("coker-nut").

COCYTUS (mod. *Vuvu*), a tributary of the Acheron, a river of Thesprotia (mod. *pashalik* of Iannina), which flows into the Ionian Sea about 20 m. N. of the Gulf of Arta. The name is also applied in Greek mythology to a tributary of the Acheron or of the Styx, a river in Hades. The etymology suggested is from

κωκβελρ, to wail, in allusion to the cries of the dead. Virgil describes it as the river which surrounds the underworld (*Aen.* vi. 132).

COD, the name given to the typical fish of the family *Gadidae*, of the Teleostean suborder Anacanthini, the position of which has much varied in our classifications. Having no spines to their fins, the Gadids used, in Cuvierian days, to be associated with the herrings, Salmonids, pike, &c., in the artificially-conceived order of Malacopterygians, or soft-finned bony fishes. But, on the ground of their air-bladder being closed, or deprived of a pneumatic duct communicating with the digestive canal, such as is characteristic of the Malacopterygians, they were removed from them and placed with the flat-fishes, or *Pleuronectidae*, in a suborder Anacanthini, regarded as intermediate in position between the Acanthopterygians, or spiny-finned fishes, and the Malacopterygians. It has, however, been shown that the flat-fishes bear no relationship to the Gadids, but are most nearly akin to the John Dories (see *DORY*).

The suborder Anacanthini is, nevertheless, maintained for the *Muraenolepididae* Gadids and two related families, *Macruridae* and *Muraenolepididae*, and may be thus defined:—Air-bladder without open duct. Parietal bones separated by the supra-occipital; prootic and exoccipital separated by the enlarged opisthotic. Pectoral arch suspended from the skull; no meso-ocoracoid arch. Ventral fins below or in front of the pectorals, the pelvic bones posterior to the clavicular symphysis and only loosely attached to it by ligament. Fins without spines; caudal fin, if present, without expanded hypural, perfectly symmetrical, and supported by the neural and haemal spines of the posterior vertebrae, and by basal bones similar to those supporting the dorsal and anal rays. This type of caudal fin must be regarded as secondary, the *Gadidae* being, no doubt, derived from fishes in which the homocercal fin of the typical Teleostean had been lost.

About 120 species of Gadids are distinguished, mostly marine, many being adapted to life at great depths; all are carnivorous. They inhabit chiefly the northern seas, but many abyssal forms occur between the tropics and in the southern parts of the Atlantic and Pacific. They are represented in British waters by eight genera, and about twenty species, only one of which, the burbot (*Lota vulgaris*), is an inhabitant of fresh waters. Several of the marine species are of first-rate economic importance. The genus *Gadus* is characterized by having three dorsal and two anal fins, and a truncated or notched caudal fin. In the cod and haddock the base of the first anal fin is not, or but slightly, longer than that of the second dorsal fin; in the whiting, pout, coal-fish, pollack, hake, ling and burbot, the former is considerably longer than the latter.

The cod, *Gadus morrhua*, possesses, in common with the other members of the genus, three dorsal and two anal fins, and a single barbel, at least half as long as the eye, at the chin. It is a widely-distributed species, being found throughout the northern and temperate seas of Europe, Asia and America, extending as far south as Gibraltar, but not entering the Mediterranean, and inhabits water from 25 to 50 fathoms deep, where it always feeds close to the bottom. It is exceedingly voracious, feeding on the smaller denizens of the ocean—fish, crustaceans, worms and molluscs, and greedily taking almost any bait the fisherman chooses to employ. The cod spawns in February, and is exceedingly prolific, the roe of a single female having been known to contain upwards of eight millions of ova, and to form more than half the weight of the entire fish. Only a small proportion of these get fertilized, and still fewer ever emerge from the egg. The number of cod is still further reduced by the trade carried on in roe, large quantities of which are used in France as ground-bait in the sardine fishery, while it also forms an article of human food. The young are about an inch in length by the end of spring, but are not fit for the market till the second year, and it has been stated that they do not reach maturity, as shown by the power of reproduction, till the end of their third year. They usually measure about 3 ft. in length, and weigh from 12 to 20 lb, but specimens have been taken from 50 to 70 lb in weight.

As an article of food the cod-fish is in greatest perfection during

the three months preceding Christmas. It is caught on all parts of the British and Irish coasts, but the Dogger Bank, and Rockall, off the Outer Hebrides, have been specially noted for their cod-fisheries. The fishery is also carried on along the coast of Norfolk and Suffolk, where great quantities of the fish are caught with hook and line, and conveyed to market alive in "well-boats" specially built for this traffic. Such boats have been in use since the beginning of the 18th century. The most important cod-fishery in the world is that which has been prosecuted for centuries on the Newfoundland banks, where it is not uncommon for a single fisherman to take over 500 of these fish in ten or eleven hours. These, salted and dried, are exported to all parts of the world, and form, when taken in connexion with the enormous quantity of fresh cod consumed, a valuable addition to the food resources of the human race.

The air-bladder of this fish furnishes isinglass, little, if at all, inferior to that obtained from the sturgeon, while from the liver is obtained cod-liver oil, largely used in medicine as a remedy in scrofulous complaints and pulmonary consumption (see *COD-LIVER OIL*). "The Norwegians," says Cuvier, "give cod-heads with marine plants to their cows for the purpose of producing a greater proportion of milk. The vertebrae, the ribs, and the bones in general, are given to their cattle by the Icelanders, and by the Kamtchatdales to their dogs. These same parts, properly dried, are also employed as fuel in the desolate steppes of the Icy Sea."

At Port Logan in Wigtonshire cod-fish are kept in a large reservoir, scooped out of the solid rock by the action of the sea, egress from which is prevented by a barrier of stones, which does not prevent the free access of the water. These cod are fed chiefly on mussels, and when the keeper approaches to feed them they may be seen rising to the surface in hundreds and eagerly seeking the edge. They have become comparatively tame and familiar. Frank Buckland, who visited the place, states that after a little while they allowed him to take hold of them, scratch them on the back, and play with them in various ways. Their flavour is considered superior to that of the cod taken in the open sea. (G. A. B.)

CODA (Ital. for "tail"; from the Lat. *cauda*), in music, a term for a passage which brings a movement or a separate piece to a conclusion. This developed from the simple chords of a cadence into an elaborate and independent form. In a series of variations on a theme or in a composition with a fixed order of subjects, the "coda" is a passage sufficiently contrasted with the conclusions of the separate variations or subjects, added to form a complete conclusion to the whole. Beethoven raised the "coda" to a feature of the highest importance.

CODE (Lat. *codex*), the term for a complete and systematic body of law, or a complete and exclusive statement of some portion of the law; and so by analogy for any system of rules or doctrine; also for an arrangement in telegraphy, signalling, &c., by which communications may be made according to rules adopted for brevity or secrecy.

In jurisprudence the question of the reduction of laws to written codes, representing a complete and readily accessible system, is a matter of great historical and practical interest. Many collections of laws, however, which are commonly known as codes,¹ would not correspond to the definition given above. The Code of Justinian (see *JUSTINIAN I.*; *ROMAN LAW*), the most celebrated of all, is not in itself a complete and exclusive system of law. It is a collection of imperial constitutions, just as the Pandects are a collection of the opinions of juriconsults. The Code and the Pandects together being, as Austin says, "digests of Roman law in force at the time of their conception," would, if properly arranged, constitute a code. Codification in this sense is merely a question of the *form* of the laws, and has nothing to do with their goodness or badness from an ethical or political point of view. Sometimes codification only means the changing of unwritten into written law; in the stricter sense it means the changing of unwritten or badly-written law into law well written.

¹ The most ancient code known, that of Khammurabi, is dealt with in the article *BABYLONIAN LAW*.

The same causes which made collections of laws necessary in the time of Justinian have led to similar undertakings among modern peoples. The actual condition of laws until the period when they are consciously remodelled is one of confusion, contradiction, repetition and disorder; and to these evils the progress of society adds the burden of perpetually increasing legislation. Some attempt must be made to simplify the task of learning the laws by improving their expression and arrangement. This is by no means an easy task in any country, but in England it is surrounded with peculiar difficulties. The independent character of English law has prevented an attempt to do what has already been done for other systems which have the basis of the Roman law to fall back upon.

The most celebrated modern code is the French. The necessity of a code in France was mainly caused by the immense number of separate systems of jurisprudence existing in that country before 1789, justifying Voltaire's sarcasm that a traveller in France had to change laws about as often as he changed horses. At first published under the title of *Code Civil des Français*, it was afterwards entitled the *Code Napoléon* (*q.v.*)—the emperor Napoleon wishing to attach his name to a work which he regarded as the greatest glory of his reign. The code, it has been said, is the product of Roman and customary law, together with the ordinances of the kings and the laws of the Revolution. In form it has passed through several changes caused by the political vicissitudes of the country, and it has of course suffered from time to time important alterations in substance, but it still remains virtually the same in principle as it left the hands of its framers. The code has produced a vast number of commentaries, among which may be named those of A. Duranton, R. T. Troplong and J. C. F. Demolombe. The remaining French codes are the *Code de procédure civile*, the *Code de commerce*, the *Code d'instruction criminelle* and the *Code pénal*. The merits of the French code have entered into the discussion on the general question of codification. Austin agrees with Savigny in condemning the ignorance and haste with which it was compiled. "It contains," says Austin, "no definitions of technical terms (even the most leading), no exposition of the *rationale* of distinctions (even the most leading), no exposition of the broad principles and rules to which the narrower provisions expressed in the code are subordinate; hence its fallacious brevity." Codes modelled on the French code have, however, taken firm root in most of the countries of continental Europe and in other parts of the world as well, such as Latin America and several of the British colonies.

The Prussian code (*Code Frédéric*) was published by Frederick the Great in 1751. It was intended to take the place of "Roman, common Saxon and other foreign subsidiary laws and statutes," the provincial laws remaining in force as before. One of the objects of the king was to destroy the power of the advocates, whom he hoped to render useless. This, with other systems of law existing in Germany, has been replaced by the Civil Code of 1900 (see GERMANY).

The object of all these codes has been to frame a common system to take the place of several systems of law, rather than to restate in an exact and exhaustive form the whole laws of a nation, which is the problem of English codification. The French and Prussian codes, although they have been of great service in simplifying the law, have failed to prevent outside themselves that accumulation of judiciary and statute law which in England has been the chief motive for codification. A more exact parallel to the English problem may be found in the *Code of the State of New York*. The revised constitution of the state, as adopted in 1846, "ordered the appointment of two commissions, one to reduce into a written and a systematic code the whole body of the law of the state, and the other to revise, reform, simplify and abridge the rules and practice, pleadings, &c., of the courts of record." By an act of 1847, the state legislature declared that the body of substantive law should be contained in three codes—the Political, the Civil and the Penal. The works of both commissions, completed in 1865, filled six volumes, containing the Code of Civil Procedure

(including the law of evidence), the Book of Forms, the Code of Criminal Procedure, the Political Code, the Penal Code and the Civil Code. In the introduction to the Civil Code it was claimed that in many departments of the law the codes "provided for every possible case, so that when a new case arises it is better that it should be provided for by new legislation." The New York code was defective in the important points of definition and arrangement. It formed the basis, however, of the present codes of civil and criminal procedure in the state of New York. Much interest has attached to the Penal Code drawn up by Edward Livingston (*q.v.*) for the state of Louisiana. The system consists of a Code of Crime and Punishments, a Code of Procedure, a Code of Evidence, a Code of Reform and Prison Discipline, and a Book of Definitions. "Though the state for which the codes were prepared," said Chief Justice Chase, "neglected to avail itself of the labours assigned and solicited by itself, they have proved, together with their introductions, a treasure of suggestions to which many states are indebted for useful legislation." Most of the other states in the United States have codes stating the law of pleading in civil actions, and such states are often described as code states to distinguish them from those adhering to the older forms of action, divided between those at law and those at equity. A few states have general codes of political and civil rights. The general drift of legislation and of public sentiment in the United States is towards the extension of the principle of codification, but the contrary view has been ably maintained (see J. C. Carter, *Provinces of the Written and the Unwritten Law*, New York, 1889).

Since the time of Bentham, the codification of the law of England has been the dream of the most enlightened jurists and statesmen. In the interval between Bentham and our own time there has been an immense advance in the scientific study of law, but it may be doubted whether the problem of codification is at all nearer solution. Interest has mainly been directed to the historical side of legal science, to the phenomena of the evolution of laws as part of the development of society, and from this point of view the question of remodelling the law is one of minor interest. To Bentham the problem presented itself in the simplest and most direct form possible. What he proposed to do was to set forth a body of laws, clearly expressed, arranged in the order of their logical connexion, exhibiting their own *rationale* and excluding all other law. On the other hand the problem has in some respects become easier since the time of Bentham. With the Benthamite codification the conception of reform in the substantive law is more or less mixed up. If codification had been possible in his day, it would, unless it had been accompanied by the searching reforms which have been effected since, and mainly through his influence, perhaps have been more of an evil than a good. The mere dread that, under the guise of codification or improvement in form, some change in substance may secretly be effected has long been a practical obstacle in the way of legal reform. But the law has now been brought into a state of which it may be said that, if it is not the best in all respects that might be desired, it is at least in most respects as good as the conditions of legislation will permit it to be. Codification, in fact, may now be treated purely as a question of form. What is proposed is that the law, being, as we assume, in substance what the nation wishes it to be, should be made as accessible as possible, and as intelligible as possible. These two essential conditions of a sound system of law are, we need hardly say, far from being fulfilled in England. The law of the land is embodied in thousands of statutes and tens of thousands of reports. It is expressed in language which has never been fixed by a controlling authority, and which has swayed about with every change of time, place and circumstance. It has no definitions, no rational distinctions, no connexion of parts. Until the passing of the Judicature Act of 1873 it was pervaded throughout its entire sphere by the flagrant antinomy of law and equity, and that act has only ordered, not executed, its consolidation. No lawyer pretends to know more than a fragment of it. Few practical questions can be answered by a lawyer without a search into numberless acts of parliament and

reported cases. To laymen, of course, the whole law is a sealed book. As there are no authoritative general principles, it happens that the few legal maxims known to the public, being apprehended out of relation to their authorities, are as often likely to be wrong as to be right. It is hopeless to think of making it possible for every man to be his own lawyer, but we can at least try to make it possible for a lawyer to know the whole law. The earlier advocates of codification founded their case mainly on the evils of judiciary law, *i.e.* the law contained in the reported decisions of the judges. Bentham's bitter antipathy to judicial legislation is well known. Austin's thirtieth lecture (*Lectures*, ed. 1869) contains an exhaustive criticism of the tenable objections to judiciary law. All such law is embedded in decisions on particular cases, from which it must be extracted by a tedious and difficult process of induction. Being created for particular cases it is necessarily uncomprehensive, imperfect, uncertain and bulky. These are evils which are incident to the nature of judiciary laws. The defective form of the existing statute law, moreover, has also given rise to loud complaints. Year by year the mass of legislation grows larger, and as long as the basis of a system is judiciary law, it is impossible that the new statutes can be completely integrated therewith. The mode of framing acts of parliament, and especially the practice of legislating by reference to previous acts, likewise produce much uncertainty and disorder. Some progress has, however, been made by the passing from time to time of various acts codifying branches of law, such as the Bills of Exchange Act 1882, the Partnership Act 1890, the Trusts Act 1893, and the Interpretation Act 1889.

The Statute Law Revision Committee also perform a useful work in excising dead law from the statute-book, partly by repeal of obsolete and spent acts and parts of acts, and partly by pruning redundant preambles and words. The construction of a section of an act may depend on the preamble and the context, and the repeal of the preamble and certain parts of the act may therefore affect the construction of what is left. This is provided for by a clause which is said to have been settled by Lord Westbury. It provides (in effect) that the repeal of any words or expressions of enactment shall not affect the construction of any statute or part of a statute. The lawyer, therefore, cannot rely on the revised edition of the statutes alone, and it is still necessary for him to consult the complete act as it was originally enacted.

The process of gradual codification adopted in India has been recommended for imitation in England by those who have had some experience of its working. The first of the Indian codes was the Penal Code (see CRIMINAL LAW), and there are also codes of civil and criminal procedure.

Whether any attempt will ever be made to supersede this vast and unarranged mass by a complete code seems very doubtful. Writers on codification have for the most part insisted that the work should be undertaken as a whole, and that the parts should have relation to some general scheme of the law which should be settled first. The practical difficulties in the way of an undertaking so stupendous as the codification *uno coëtu* of the whole mass of the law hardly require to be stated.

In discussions on codification two difficulties are insisted on by its opponents, which have some practical interest—(1) What is to be done in those cases for which the code has not provided? and (2) How is new law to be incorporated with the code? The objection that a code will hamper the opinions of the court, destroy the flexibility and elasticity of the common law, &c., disappears when it is stated in the form of a proposition, that law codified will cover a smaller number of cases, or will be less easily adapted to new cases, than law uncodified. The French system ordered the judges, under a penalty, to give a decision on all cases, whether contemplated or not by the code, and referred them generally to the following sources:—(1) *Équité naturelle*, *loi naturelle*; (2) *loi romain*; (3) *loi coutumier*; (4) *usages*, *exemples*, *jugements*, *jurisprudence*; (5) *droit commun*; (6) *principes généraux*, *maximes*, *doctrine*, *science*. The Prussian code, on the other hand, required the judges to report new cases to the head of the judicial department, and they were decided by

the legislative commission. No provision was made in either case for incorporating the new law with the code, an omission which Austin justly considers fatal to the usefulness of codification. It is absurd to suppose that any code can remain long without requiring substantial alteration. Cases will arise when its meaning must be extended and modified by judges, and every year will produce its quota of new legislation by the state. The courts should be left to interpret a code as they now interpret statutes, and provision should be made for the continual revision of the code, so that the new law created by judges or directly by the state may from time to time be worked into the code.

CODE NAPOLÉON, the first code of the French civil law, known at first as the *Code civil des Français*, was promulgated in its entirety by a law of the 30th Ventose in the year XII. (31st of March 1804). On the 3rd of September 1807 it received the official name of Code Napoléon, although the part that Napoleon took in framing it was not very important. A law of 1818 restored to it its former name, but a decree of the 27th of March 1852 re-established the title of Code Napoléon. Since the 4th of September 1870 the laws have quoted it only under the name of the Code Civil.

Never has a work of legislation been more national in the exact sense of the word. Desired for centuries by the France of the *ancien régime*, and demanded by the *cahiers* of 1789, this "code of civil laws common to the whole realm" was promised by the constitution of 1791. However, the two first assemblies of the Revolution were able to prepare only a few fragments of it. The preparation of a coherent plan began with the Convention. The *ancien régime* had collected and adjusted some of the material. There was, on the one hand, a vast juridical literature which by eliminating differences of detail, had disengaged from the various French "customs" the essential part which they had in common, under the name of "common customary law"; on the other hand, the Roman law current in France had in like manner undergone a process of simplification in numerous works, the chief of which was that of Domat; while certain parts had already been codified in the *Grandes Ordonnances*, which were the work of d'Aguesseau. This legacy from the past, which it was desired to preserve within reason, had to be combined and blended with the laws of the Revolution, which had wrought radical reforms in the conditions affecting the individual, the tenure of real property, the order of inheritance and the system of mortgages. Cambacérés, as the representative of a commission of the Convention, brought forward two successive schemes for the Code Civil. As a member of one of the councils, he drew up a third under the Directory, and these projected forms came in turn nearer and nearer to what was to be the ultimate form of the code. So great was the interest centred in this work, that the law of the 19th Brumaire, year VIII., which, in ratification of the previous day's *coup d'état* nominated provisional consuls and two legislative commissions, gave injunctions to the latter to draw up a scheme for the Code Civil. This was done in part by one of the members, Jacqueminot, and finally under the constitution of the year VIII., the completion of the work was taken in hand. The legislative machinery established by this constitution, defective as it was in other respects, was eminently suited for this task. Indeed, all projected laws emanated from the government and were prepared by the newly established council of state, which was so well recruited that it easily furnished qualified men, mostly veterans of the revolution, to prepare the final scheme. The council of state naturally possessed in its legislative section and its general assembly bodies both competent and sufficiently limited to discuss the texts efficiently. The *corps législatif* had not the right of amendment, so could not disturb the harmony of the scheme. It was in the discussions of the general assembly of the council of state that Napoleon took part, in 97 cases out of 102 in the capacity of chairman, but, interesting as his observations occasionally are, he cannot be considered as a serious collaborator in this great work.

Those responsible for the scheme have in the main been very successful in their work; they have generally succeeded in fusing

the two elements which they had to deal with, namely ancient French law, and that of the Revolution. The point in which their work is comparatively weak is the system of hypothec (*q.v.*), because they did not succeed in steering a middle course between two opposite systems, and the law of the 23rd of March 1855 (*sur la transcription en matière hypothécaire*) was necessary to make good the deficiency. A fault frequently found with the Code Civil is that its general divisions show a lack of logic and method, but the division is practically that of the Institutes of Justinian, and is about as good as any other: persons, things, inheritance, contracts and obligations, and finally, in place of actions, which have no importance for French law except from the point of view of procedure, privileges and hypothecs, as in the ancient *coutumes* of France, and prescription. It is, *mutatis mutandis*, practically the same division as that of Blackstone's Commentaries.

Of late years other objections have been expressed; serious omissions have been pointed out in the Code; it has not given to personal property the importance which it has acquired in the course of the 19th century; it makes no provision for dealing with the legal relations between employers and employed which modern complex undertakings involve; it does not treat of life insurance, &c. But this only proves that it could not foretell the future, for most of these questions are concerned with economic phenomena and social relations which did not exist at the time when it was framed. The Code needed revising and completing, and this was carried out by degrees by means of numerous important laws. In 1904, after the celebration of the centenary of the Code Civil, an extra-parliamentary commission was nominated to prepare a revision of it, and at once began the work.

The influence of the Code Civil has been very great, not only in France but also abroad. Belgium has preserved it, and the Rhine provinces only ceased to be subject to it on the promulgation of the civil code of the German empire. Its ascendancy has been due chiefly to the clearness of its provisions, and to the spirit of equity and equality which inspires them. Numerous more recent codes have also taken it as a model: the Dutch code, the Italian, and the code of Portugal; and, more remotely, the Spanish code, and those of the Central and South American republics. In the present day it is rivalled by the German civil code, which, having been drawn up at the end of the 19th century, naturally does not show the same lacunae or omissions. It is inspired, however, by a very different spirit, and the French code does not suffer altogether by comparison with it either in substance or in form.

See *Le Code Civil, livre du centenaire* (Paris, 1904), a collection of essays by French and foreign lawyers. (J. P. E.)

CODIAEUM, a small genus of plants belonging to the natural order Euphorbiaceae. One species, *C. variegatum*, a native of Polynesia, is cultivated in greenhouses, under the name of croton, for the sake of its leaves, which are generally variegated with yellow, and are often twisted or have the blades separated into distinct portions.

CODICIL (Lat. *codicillus*, a little book or tablet, diminutive of *codex*), a supplement to a will (*q.v.*), containing anything which a testator desires to add, or which he wishes to retract, to explain or to alter. In English law a codicil requires to be executed with the same formalities as a will under the Wills Act 1837.

CODILLA, the name given to the broken fibres which are separated from the flax during the scutching process. On this account it is sometimes termed scutching tow. Quantities of this material are used along with heckled tow in the production of tow yarns.

CODINUS, GEORGE [GEORGIOS KODINOS], the reputed author of three extant works in Byzantine literature. Their attribution to him is merely a matter of convenience, two of them being anonymous in the MSS. Of Codinus himself nothing is known; it is supposed that he lived towards the end of the 15th century. The works referred to are the following:—

1. *Patria* (Τὰ Πάτρια τῆς Κωνσταντινουπόλεως), treating of the history, topography, and monuments of Constantinople.

It is divided into five sections: (a) the foundation of the city; (b) its situation, limits and topography; (c) its statues, works of art, and other notable sights; (d) its buildings; (e) the construction of the church of St Sophia. It was written in the reign of Basil II. (976–1025), revised and rearranged under Alexius I. Comnenus (1081–1118), and perhaps copied by Codinus, whose name it bears in some (later) MSS. The chief sources are: the *Patria* of Hesychius Illustrius of Miletus, an anonymous (*c.* 750) brief chronological record (*Παραστάσεις σύντομοι χρονικά*), and an anonymous account (*διήγησις*) of St Sophia (ed. T. Preger in *Scriptores originum Constantinopolitanarum*, fasc. i., 1901, to be followed by the *Patria* of Codinus). Procopius, *De Aedificiis* and the poem of Paulus Silentarius on the dedication of St Sophia should be read in connexion with this subject.

2. *De Officiis* (*Περὶ τῶν Ὀφφικίων*), a sketch, written in an unattractive style, of court and higher ecclesiastical dignities and of the ceremonies proper to different occasions. It should be compared with the *De Cerimoniis* of Constantine Porphyrogenitus.

3. A chronological outline of events from the beginning of the world to the taking of Constantinople by the Turks (called *Agarenes* in the MS. title). It is of little value.

Complete editions are (by I. Bekker) in the Bonn *Corpus scriptorum Hist. Byz.* (1839–1843, where, however, some sections of the *Patria* are omitted), and in J. P. Migne, *Patrologia graeca*, clvii.; see also C. Krumbacher, *Geschichte der byzantinischen Literatur* (1897).

COD-LIVER OIL (*Oleum Morrhuae*, or *Oleum Jecoris Aselli*), the oil obtained from the liver of the common cod (*Gadus morrhua*). In the early process for extracting the oil the livers were allowed to putrefy in wooden tubs, when oils of two qualities, one called "pale oil," and the other "light brown oil," successively rose to the surface and were drawn off. A third oil was obtained by heating the liver-residues to above the boiling-point of water, whereupon a black product, technically called "brown oil," separated. The modern practice consists in heating the perfectly fresh, cleaned livers by steam to a temperature above that of boiling water, or, in more recent practice, to a lower temperature, the livers being kept as far as possible from contact with air. The oils so obtained are termed "steamed-liver oils." The "pale" and "light brown" oils are used in pharmacy; the "brown" oil, the cod oil of commerce, being obtained from putrid and decomposing livers, has an objectionable taste and odour and is largely employed by tanners. By boiling the livers at a somewhat high temperature, "unracked" cod oil is obtained, containing a considerable quantity of "stearine"; this fat, which separates on cooling, is sold as "fish stearine" for soap-making, or as "fish-tallow" for currying. The oil when freed from the stearine is known as "racked oil." "Coast cod oil" is the commercial name for the oil obtained from the livers of various kinds of fish, *e.g.* hake, ling, haddock, &c. The most important centres of the cod-liver oil industry are Lofoten and Romsdal in Norway; the oil is also prepared in the United States, Canada, Newfoundland, Iceland and Russia; and at one time a considerable quantity was prepared in the Shetland Islands and along the east coast of Scotland.

Cod-liver oil contains palmitin, stearin and other more complex glycerides; the "stearine" mentioned above, however, contains very little palmitin and stearin. Several other acids have been identified: P. M. Meyerdaahl obtained 4% of palmitic acid, 20% of jecoleic acid, C₁₉H₃₆O₂, and 20% of therapeutic acid, C₁₇H₃₂O₂; other investigators have recognized jecoric acid, C₁₈H₃₀O₂, asellic acid, C₁₇H₃₂O₂, and physetoleic acid, C₁₆H₃₀O₂, but some uncertainty attends these last three acids. Therapeutic and jecoleic acids apparently do not occur elsewhere in the animal kingdom, and it is probable that the therapeutic properties of the oil are associated with the presence of these acids, and not with the small amount of iodine present as was at one time supposed. Other constituents are cholesterol (0.46–1.32%), traces of calcium, magnesium, sodium, chlorine and bromine, and various aliphatic amines which are really secondary products, being formed by the decomposition of the cellular tissue. Cod-liver oil is used externally in medicine when its internal

administration is rendered impossible by idiosyncrasy or the state of the patient's digestion. The oil is very readily absorbed from the skin and exerts all its therapeutic actions when thus exhibited. This method is often resorted to in the case of infants or young children suffering from abdominal or other forms of tuberculosis. Its only objection is the odour which the patient exhales. When taken by the mouth, cod-liver oil shares with other liver-oils the property of ready absorption. It often causes unpleasant symptoms, which must always be dealt with and not disregarded, more harm than good being done if this course is not followed. Fortunately a tolerance is soon established in the majority of cases. It has been experimentally proved that this is more readily absorbed than any other oil—including other liver-oils. Much attention has been paid to the explanation of this fact, since knowledge on this point might enable an artificial product, without the disadvantages of this oil, to be substituted for it. Very good results have been obtained from a preparation named "lipanin," which consists of six parts of oleic acid and ninety-four of pure olein. Cod-liver oil has the further peculiarity of being more readily oxidizable than any other oil; an obviously valuable property when it is remembered that the entire food-value of oils depends on their oxidation.

Cod-liver oil may be given in all wasting diseases, and is occasionally valuable in cases of chronic rheumatoid arthritis; but its great therapeutic value is in cases of tuberculosis of whatever kind, and notably in pulmonary tuberculosis or consumption. Its reputation in this is quite inexpugnable. It is essential to remember that "in phthisis the key of the situation is the state of the alimentary tract," and the utmost care must be taken to obviate the nausea, loss of appetite and diarrhoea, only too easily induced by this oil. It is best to begin with only one dose in the twenty-four hours, to be taken just before going to sleep, so that the patient is saved its unpleasant "repetition" from an unaccustomed stomach. In general, it is therefore wise to order a double dose at bedtime. The oil may be given in capsules, or in the form of an emulsion, with or without malt-extract, or success may be obtained by adding, to every two drachms of the oil, ten minims of pure ether and a drop of peppermint oil. The usual dose, at starting, is one or two drachms, but the oil should be given eventually in the largest quantities that the patient can tolerate.

CODRINGTON, CHRISTOPHER (1668-1710), British soldier and colonial governor, whose father was captain-general of the Leeward Isles, was born in the island of Barbados, West Indies, in 1668. Educated at Christ Church, Oxford, he was elected a fellow of All Souls, and subsequently served with the British forces in Flanders, being rewarded in 1695 with a captaincy in the Guards. In the same year he attended King William III. on his visit to Oxford, and, in the absence of the public orator, was chosen to deliver the University oration. In 1697, on the death of his father, he was appointed captain-general and commander-in-chief of the Leeward Isles. In 1703 he commanded the unsuccessful British expedition against Guadeloupe. After this he resigned his governorship, and spent the rest of his life in retirement and study on his Barbados estates. He died on the 7th of April 1710, bequeathing these estates to the Society for the Propagation of the Gospel in Foreign Parts for the foundation of a college in Barbados. This college, known as the Codrington college, was built in 1714-1742. To All Souls College, Oxford, he bequeathed books worth £6000 and £10,000 in money, out of which was built and endowed the Codrington library there.

CODRINGTON, SIR EDWARD (1770-1851), British admiral, belonged to a family long settled at Dodrington in Gloucestershire. He was the youngest of three brothers, who were left orphans at an early age, and were educated by an uncle, Mr Bethell. Edward Codrington was sent for a short time to Harrow, and entered the navy in July 1783. He served on the American station, in the Mediterranean and at home, till he was promoted lieutenant on the 28th of May 1783. Lord Howe selected him to be signal lieutenant on the flagship of the Channel fleet at the beginning of the revolutionary war with France. In that capacity he served in the "Queen Charlotte" (100) during the

operations which culminated in the battle of the 1st of June 1794. The notes he wrote on Barrow's account of the battle in his *Life of Howe*, and the reminiscences he dictated to his daughter, which are to be found in her memoir of him, are of great value for the history of the action. On the 7th of October 1794 he was promoted commander, and on the 6th of April 1795 attained the rank of post-captain and the command of the "Babet" (22). He continued to serve in the Channel, and was present at the action off L'Orient on the 23rd of June 1795. Codrington wrote notes on this encounter also, which are to be found in the memoir. They are able and valuable, but, like all his correspondence throughout his life, show that he was of a somewhat censorious disposition, was apt to take the worst view of the conduct of others, and was liable to be querulous. He next commanded the "Druid" (32) in the Channel and on the coast of Portugal, till she was paid off in 1797. Codrington now remained on shore and on half-pay for some years. In December 1802 he married Jane, daughter of Jasper Hall of Kingston, Jamaica.

On the renewal of the war after the breach of the peace of Amiens he was appointed (May 1805) to the command of the "Orion" (74) and was attached to the fleet on the coast of Spain, then blockading Villeneuve in Cadiz. The "Orion" took a conspicuous part in the battle of Trafalgar. Codrington's correspondence contains much illuminative evidence as to the preliminaries and the events of the victory. From 1805 till 1813 he continued to serve first in the "Orion" and then (1808) in the "Blake" (74) in European waters. He was present on the Walcheren expedition, and was very actively employed on the Mediterranean coast of Spain in co-operating with the Spaniards against the French. In 1814 he was promoted rear-admiral, at which time he was serving on the coast of North America as captain of the fleet to Sir Alexander Cochrane during the operations against Washington, Baltimore and New Orleans. In 1815 he was made K.C.B., and was promoted vice-admiral on the 10th of July 1821. In December 1826 he was appointed to the Mediterranean command, and sailed on the 1st of February 1827. From that date until his recall on the 21st of June 1828 he was engaged in the arduous duties imposed on him by the Greek War of Independence, which had led to anarchy and much piracy in the Levant. On the 20th of October 1827 he destroyed the Turkish and Egyptian naval forces at Navarino (*q.v.*), while in command of a combined British, French and Russian fleet. As the battle had been unforeseen in England, and its result was unwelcome to the ministry of the day, Codrington was entangled in a correspondence to prove that he had not gone beyond his instructions, and he was recalled by a despatch, dated the 4th of June.

After the battle Codrington went to Malta to refit his ships. He remained there till May 1828, when he sailed to join his French and Russian colleagues on the coast of the Morea. They endeavoured to enforce the evacuation of the peninsula by Ibrahim peacefully. The Pasha made diplomatic difficulties, and on the 25th of July the three admirals agreed that Codrington should go to Alexandria to obtain Ibrahim's recall by his father Mehemet Ali. Codrington had heard on the 22nd of June of his own supersession, but, as his successor had not arrived, he carried out the arrangement made on the 25th of July, and his presence at Alexandria led to the treaty of the 6th of August 1828, by which the evacuation of the Morea was settled. His services were recognized by the grant of the grand cross of the Bath, but there is no doubt that he was treated as a scape-goat at least to some extent. After his return home he was occupied for a time in defending himself, and then in leisure abroad. He commanded a training squadron in the Channel in 1831 and became admiral on the 10th of January 1837. From November 1839 to December 1842 he was commander-in-chief at Portsmouth. He died on the 28th of April 1851.

Sir Edward Codrington left two sons, Sir William (1804-1884), a soldier who commanded in the Crimea, and Sir John Henry (1808-1877), a naval officer, who died an admiral of the fleet.

See *Memoir of the Life of Admiral Sir Edward Codrington*, by his daughter Jane, Lady Bouchier, wife of Sir T. Bouchier, R.N. (London, 1873). (D. H.)

CODRUS, in Greek legend, the last king of Athens. According to the story, it was prophesied at the time of the Dorian invasion of Peloponnesus (c. 1068 B.C.) that only the death of their king at the enemy's hands could ensure victory to the Athenians. Devoting himself to his country, Codrus, in the disguise of a peasant, made his way into the enemy's camp, and provoked a quarrel with some Dorian soldiers. He fell, and the Dorians, on discovering that Codrus had been slain, retreated homeward, despairing of success. No one being thought worthy to succeed Codrus, the title of king was abolished, and that of archon (*q.v.*) substituted for it.

See Lycurgus, *Leocr.* xx. [=84-87]; Justin ii. 6; Vell. Pat. i. 2; Grote, *Hist. of Greece*, pt. i. ch. 18; Busolt, *Griechische Geschichte*, i.

CODY, WILLIAM FREDERICK (1846-), American scout and showman, known under the name of "Buffalo Bill," was born in 1846 in Scott county, Iowa. He first became known as one of the riders of the "Pony Express," a mail service established in the spring of 1860 by the Central Overland California and Pike's Peak Express Company to carry the mails overland from Saint Joseph, Missouri, to Sacramento, California, a distance of 1950 m., by means of relays of ponies, each rider being expected to cover about 75 m. daily. Owing to the wildness of the country and the hostility of the Indians, both the riders and the station-keepers led lives of great hardship and danger. The "Pony Express" was discontinued in 1861 upon the completion of the Pacific Telegraph company's line, and young Cody became a scout and guide for the United States army. In 1863 he formally enlisted in the 7th regiment of Kansas cavalry, in which he served until the close of the Civil War. In 1867 he made a contract with the Kansas Pacific railway to furnish its employees with buffalo meat while the line was being extended through the wilderness, and his name of "Buffalo Bill" was given him from this circumstance. In 1868-1872 he was again an army scout and guide, serving against the Sioux and Cheyennes; and in 1872 was a member of the Nebraska house of representatives. During the Sioux-Cheyenne War of 1876 he served in the 5th United States Cavalry, and at the battle of Indian Creek killed the Cheyenne chief Yellow Hand in single combat. In 1883 he organized his "Wild West Show," a spectacular performance on a large scale, his first European tour taking place in 1887. In the Nebraska national guard he again served against the Sioux in 1890-1891.

CO-EDUCATION, the term applied to the instruction and training of boys and girls, or of young people of both sexes, in the same school or institution, in the same classes and through the same courses of study. Examples of the thoroughgoing application of this principle can be found in every grade of education from the elementary school to the university. But the term "Co-education" is sometimes used in a wider sense, in order to include cases in which boys and girls, or young men and young women of university age, are admitted to membership of the same school or college but receive instruction wholly or in part in separate classes and in different subjects. Other variable factors in co-educational systems are the extent to which men and women are mixed on the teaching staff, and the freedom of intercourse permitted between pupils of the two sexes in class, in games and in other activities of school life. In another form of combined education (preferred by Comte, *Système de politique positive*, iv. 266), pupils of the two sexes are taught successively by the same teacher. By the English Board of Education, a distinction is drawn between mixed schools and dual schools. "Mixed schools" are those in which, for most subjects of the curriculum, boys and girls are taught together by the same teachers: in "dual schools" there are separate boys' and girls' departments under a single principal, but with separate entrances, classrooms and playgrounds for the two sexes.

History.—Co-education in early times was occasional and sporadic. For example, women were admitted by Plato to the inner circle of the Academy on terms of equality with men. The educational endowments of Teos provided that the professors of literature should teach both boys and girls. It is uncertain whether the Roman schools in classical times were attended by both sexes. A tombstone found at Capua represents a schoolmaster with a boy on one side and a girl on the other. Probably

co-education was practised in country districts for economical reasons; and also in the home schools organized by wealthier families (Wilkins, *Roman Education*, pp. 42-43). At Charles the Great's Palace School at Aachen (A.D. 782 onwards), Alcuin taught together the young princes and their sisters, as well as grown men and women. The Humanists of the Renaissance made the full development of personality a chief aim of education, and held up literary accomplishment as a desirable mark of personal distinction both for men and women. This led to the scholarly education of girls along with boys in the home schools of some great families. Thus, at Mantua (1423 onwards), Vittorino da Feltre taught Cecilia Gonzaga with her brothers and the other boy pupils at his boarding-school; but there is no evidence that the latter was otherwise co-educational. Luther and other Reformers urged that girls as well as boys should be taught to read the Bible. Hence came the tendency to co-education of boys and girls in some elementary schools in Protestant lands. This tendency can be traced both in Scotland and in the northern parts of England. It is believed that, in the early days of New England, district schools in smaller American towns were open to boys and girls alike, but that few girls advanced beyond reading and writing (Martin, *Massachusetts Public School System*, p. 130). At Dorchester, Mass., it was left to the discretion of the elders and schoolmen whether maids should be taught with the boys or not; but in practice the girls seem to have been educated apart. In 1602 the council of Ayr, Scotland, ordained that the girls who were learning to read and write at the Grammar School should be sent to the master of the Song School, "because it is not seemly that sic lasses should be among the lads" (Grant, *History of the Burgh and Parish Schools of Scotland*, p. 526 ff.). Meriden, Connecticut, seems to have made common provision for the elementary education of boys and girls in 1678. Northampton, Mass., did the same in 1680. Deerfield, Mass., in 1698 voted that "all families having children either male or female between the ages of six and ten years shall pay by the poll for their schooling"—presumably in the common school.

Thus the beginnings of co-education in its modern organized form may be traced back partly to Scotland and partly to the United States. The co-education of boys and girls, carried through in varying degrees of completeness, was not uncommon in the old Endowed Schools of Scotland, and became more frequent as increasing attention was given to the education of girls. At the Dollar Institution, founded by John McNabb for the benefit of the poor of the parish of Dollar and shire of Clackmannan (date of will, 1800), boys and girls have been educated together in certain classes since the beginning of the school in 1818. In the eastern parts of the United States, where the Puritan tradition also prevailed, co-education struck firm root, and spread chiefly for reasons of convenience and economy (Dexter, *History of Education in United States*, p. 430). But throughout the west, co-education was strongly preferred in elementary and secondary schools and in universities on the further ground that it was believed to be more in accordance with the democratic principle of equal educational opportunity for the two sexes.

It should be added, however, that the leaven of Pestalozzi's thought has worked powerfully both in Europe and America in favour of the idea of co-education. His view was that all educational institutions should, as far as possible, be modelled upon the analogy of the family and of the home. At Stanz (1798-1799) he educated together in one household boys and girls ranging in age from five to fifteen. At Burgdorf (1799-1804) his work was in part co-educational. At Yverdon (1804-1825) Pestalozzi established a school for girls close to his school for boys. The girls received instruction from some of the masters of the boys' school, and girls and boys met at evening worship, in short excursions and at other times.

In England, the Society of Friends have been the pioneers of co-education in boarding schools, both for younger children and for pupils up to fifteen or sixteen years of age. The practice of the society, though not exclusively co-educational, has long been favourable to co-education, either in its complete or restricted form, as being more in harmony with the conditions

of family life. Ackworth school was established by the London Yearly Meeting in 1779 for the education of boys and girls; but the school has never been fully co-educational, the boys and girls being taught separately except in a few classes. At Sidcot school, which was founded in 1808 by the Associated Quarterly Meetings in the west of England for the education of children of Friends, boys and girls are taught together, except in certain handicraft subjects. Several other co-educational schools were founded by the Society of Friends during the first half of the 19th century.

Since that time the movement towards co-education in secondary schools and universities has steadily gained strength in England. It has been furthered by the diffusion of Pestalozzian ideas and also by the influence of American example. In England, private schools have made some of the most valuable co-educational experiments. A private boarding and day secondary school on co-educational lines was instituted by Mr W. A. Case in Hampstead in 1865. A co-educational boarding-school was founded in 1869 by Miss Lushington at Kingsley near Alton, Hants. In 1873 Mr W. H. Herford began the Ladybarn school for boys and girls at Withington in the suburbs of Manchester. The passing of the Welsh Intermediate Education Act 1889 led to the establishment of a considerable number of new mixed or dual secondary day-schools in Wales. Many English teachers gained experience in these schools and subsequently influenced English education. The work and writings of Mr J. H. Badley at Bedales, Petersfield, a co-educational boarding-school of the first grade, gave greatly increased weight to the principle of co-education. Important additions have also been made to the fund of co-educational experience by the King Alfred's school (Hampstead), Keswick school, and West Heath school (Hampstead). In 1907 a Public Co-educational Boarding School was opened at Harpenden.

Since the Education Act 1902 became law, there has been a rapid increase of co-educational secondary day-schools of the lower grade, under county or borough education authorities, in all parts of England. This increase is due to two chief causes, viz. (1) The co-educational tradition of some of the higher grade board schools, many of which have become secondary schools; and (2) the economy effected by establishing one co-educational secondary school, in place of two smaller schools for boys and girls separately.

The idea of co-education in secondary schools has spread in several other European countries, especially in Holland, Norway, Sweden and Denmark. In Scandinavia, the new practice appears to have begun with the establishment of a private higher secondary school, the Palmgremiska Samskolan, in Stockholm, in 1876. A similar school, Nya Svenska Läroverket, was founded upon the same model in Helsingfors, Finland, in 1880. In Norway, the law of 1896 introduced co-education in all state schools. In Denmark, as in Norway, co-education was begun in private schools; on its proving a success there, it was introduced into the state schools, with two exceptions; and it is now obligatory in most state schools but optional in private schools (J. S. Thornton, *Schools Public and Private in the North of Europe*, 1907, p. 97). In Holland, there is now a good deal of co-education in lower secondary schools of the modern type. For example, at Utrecht, the state higher burgher school provides the same course of instruction, except in gymnastics, for boys and girls. At Almelo, the municipal higher burgher school, though co-educational, differentiates the classes in several subjects. In Belgium, France, Germany and Austria, co-education, though frequent in elementary schools, is regarded as undesirable in secondary; but the movement in its favour in many parts of Germany seems to be gathering strength. All over Europe the Roman Catholic populations prefer the older ideal of separate schools for boys and girls.

Co-education in colleges and universities, which began at Oberlin, Ohio, in 1833, was adopted almost without exception by the state universities throughout the west of America from 1862 onwards. Since that time the idea has spread rapidly throughout Europe, and the presence of women students at

universities originally confined to men is one of the most striking educational facts of the age.

Co-education in the United Kingdom, (a) England and Wales.—The Board of Education does not possess any summary showing the number of pupils in mixed public elementary schools or in mixed departments of such schools. In 1901, out of 31,502 departments of public elementary schools in England and Wales, nearly half (15,504) were mixed departments, in which boys and girls were educated together. But as the departments were of unequal size, it must not be inferred from this that half the children in public elementary schools in that year (5,883,762) were receiving co-education. Of the total number of departments in public elementary schools in England and Wales, the percentage of mixed schools fell from 51.6 in 1881 to 49.4 in 1891 and 49.2 in 1901. But these percentages must not be taken to prove an absolute decline in the number of children in mixed departments.

In England, out of 492 public secondary schools which were recognized by the Board of Education for the receipt of government grant for the school year ending July 31, 1905, and which contained 85,358 pupils, 108 schools, with 21,720 pupils, were mixed; and 20 schools, with 8980 pupils, were dual schools.

Thus, of the total number of pupils in the secondary schools referred to above, a little over 25% were in mixed schools, and about 10% were in dual schools. It is not safe to assume, however, that all the mixed schools were completely co-educational in their work, or that the dual schools were not co-educational in respect of certain subjects or parts of the course. It should also be remembered that, besides the secondary schools recognized by the Board of Education for the receipt of government grant, there is a considerable number of great endowed secondary boarding-schools ("public schools" in the English use of that expression) which are for boys only. There are also at least 5000 private secondary schools, of which, in 1897 (since when no comprehensive statistical inquiry has been made), 970, with 26,027 pupils, were mixed schools. But the great majority of the children in these mixed schools were under twelve years of age. The number of boys and girls over twelve years of age, in the mixed private secondary schools which were included in the 1897 return, was only 5488.

In Wales, for the school year ending July 31, 1905, out of 84 state-aided public secondary schools, 11 were mixed and 44 were dual schools. The number of scholars in the Welsh schools referred to above was 9340. Of these, 1457, or 15%, were in mixed schools, and 5085, or 54%, were in dual schools. The managers of dual schools in Wales have the power to arrange that boys and girls shall be taught together in any or all the classes; and, as a matter of fact, nearly all the dual schools are worked as mixed schools, though they appear in these figures under dual.

(b) *Scotland.*—In the public elementary schools, including the higher grade schools of Scotland, co-education is the almost universal rule. The exceptions, which for the most part are Roman Catholic or Episcopal Church schools, tend to diminish year by year. In 1905, out of 3843 departments in the Scotch public elementary and higher grade schools, 3783 were mixed. These include the infant departments. Out of the total number of children in the public elementary and higher grade schools, including infants' departments, 98.43% were receiving co-education.

In the secondary schools of Scotland there has been in recent years little perceptible movement either towards co-education or away from it. What movement there is, favours the establishment of separate secondary schools for girls in the large centres of population. Out of 109 public secondary schools in Scotland in 1905-1906, 29 schools were for boys only and 40 schools for girls only. One school had boys and girls in separate departments. In the remaining 39 schools, boys and girls were taken together to an extent which varied with the subjects taken; but there was nothing of the nature of a strict separation of the sexes as regards the ordinary work of the school.

(c) *Ireland.*—In Ireland, the percentage of pupils on the rolls of mixed national schools (i.e. schools attended by boys and

girls), to the total number of pupils on the rolls of all national schools, has slowly increased. In 1880 the percentage was 57.5; in 1898, 59.4; in 1905, 60.9.

The Commissioners of Intermediate Education in Ireland had on their list in 1906, 38 secondary schools which were classified by them as mixed schools. These schools were attended by 640 boys and 413 girls between 13 and 19 years of age. The commissioners do not know to what extent the boys and girls in these schools received instruction in the same classes. As, however, the schools are small, they believe that in the great majority of cases the boys and girls were taught together. In one large school not classified as mixed, the boys (117) and girls (60) were taught in the same classes.

Universities and University Colleges in the United Kingdom.—Women are admitted as members of the universities of London, Durham, Manchester, Liverpool, Birmingham, Leeds, Sheffield, Wales, Edinburgh, Aberdeen, St Andrews, Glasgow, Dublin and the Royal University of Ireland. At Oxford and Cambridge women are not admitted as members of the university, but by courtesy enjoy entrance to practically all university lectures and examinations. The social life of the men and women students is more separate in the old than in the new universities. In no grade of education in the United Kingdom has the principle of co-education made more rapid advance than in the universities. The university education of women began in London (Queen's College 1848, Bedford College 1849, both being preceded by classes in earlier years). The University of London in 1878 decided to accept from the crown a supplemental charter making every degree, honour and prize awarded by the university accessible to students of both sexes on perfectly equal terms. By charter in 1880, the Victoria University (now broken up into the universities of Manchester, Liverpool and Leeds) received power to grant degrees to women as well as to men. The charter of the university of Wales (1893) provides that "Women shall be eligible equally with men for admittance to any degree which our university is authorized to confer; every office created in the university, and the membership of every authority constituted by the charter shall be open to women equally with men." In 1889 the Universities (Scotland) Act empowered the commissioners to make ordinances, enabling each university to admit women in graduation in one or more faculties and to provide for their instruction. At all the university colleges in the United Kingdom women are educated as well as men.

United States.—Co-education is a characteristic feature of the educational system of the different states of the American Union. Of elementary school pupils at least 96%, and of secondary school pupils 95%, are in mixed schools. In 1903, out of a total enrolment of 15,990,803 pupils in public elementary and secondary schools and training colleges, 15,387,734 were in schools attended by pupils of both sexes. Out of 550,600 pupils on the rolls of public secondary schools (high schools) in 1902, 523,300 were in co-educational schools. The same was true of 43% of the pupils (numbering over 100,000) in private secondary schools. In colleges and universities 62% of all undergraduates were in co-educational institutions, to which category thirty-four American universities belong (U.S. Commissioner of Education, *Report for 1903*, p. 2454). In America opinion is thus predominantly in favour of co-education, but there is a current of adverse criticism, especially among some who have had experience of school conditions in large cities.

General Review of the Question.—In schools for infants and younger children co-education is approved by all authorities. It is increasingly favoured on educational grounds in smaller schools for children up to 12 or 13 years of age or thereabouts. But where elementary schools have to be large, separate departments for boys and girls are generally preferable, though mixed schools are often established for reasons of economy. At the other end of the educational scale, viz. in the universities, the co-education of men and women in the same institution is fast becoming the rule. This is due partly to the prohibitive cost of duplicating teaching staff, laboratories, libraries and other equipment, partly to the desire of women to qualify themselves

for professional life by passing through the same courses of training as are prescribed for men. The degree, however, to which social intercourse is carried on between men and women students differs widely in the different co-educational universities. There are occasional signs, e.g. at Chicago, of a reaction against the fullest form of academic co-education. And it is probable that the universities will provide, among many courses common to men and women, some (like engineering) suitable for men only, and others (like advanced instruction in home-science, or certain courses of professional preparation for teachers of young children) which will rarely be attended by any but women. Common use of the same university institutions is compatible with much differentiation in courses of study and with separately organized forms of collegiate life. It is with regard to the part of education which lies between the elementary schools and the universities that the sharpest division of opinion upon the principle of co-education now exists. In Europe, with the exception of Scandinavia, those who advocate co-education of the sexes in secondary schools up to 18 or 19 years of age are at present in a distinct minority, even as regards day schools, and still more when they propose to apply the same principle to boarding schools. But the application of the co-educational principle to all schools alike is favoured by an apparently increasing number of men and women. This movement in opinion is connected with the increase in the number of girls desiring access to secondary schools, a demand which can most easily and economically be met by granting to girls access to some of the existing schools for boys. The co-educational movement is also connected with a strong view of sex equality. It is furthered by the rapidly increasing number of women teachers who are available for higher educational work. Mixed secondary schools with mixed staffs are spreading for reasons of economy in smaller towns and rural districts. In large towns separate schools are usually recommended in preference, but much depends upon the social tradition of the neighbourhood. Those who advocate co-education for boys and girls in secondary schools urge it mainly on the ground of its naturalness and closer conformity to the conditions of healthy, unselfconscious home life. They believe it to be a protective against uncleanness of talk and school immorality. They point to its convenience and economy. They welcome co-education as likely to bring with it a healthy radicalism in regard to the older tradition of studies in boys' secondary schools. They approve it as leading to mixed staffs of men and women teachers, and as the most effectual way of putting girls in a position of reasonable equality with boys in respect of intellectual and civic opportunity. On the other hand, those who oppose co-education in secondary schools rest their case upon the danger of the intellectual or physical overstrain of girls during adolescence; and upon the unequal rate of development of boys and girls during the secondary school period, the girls being more forward than the boys at first, but as a rule less able to work as hard at a somewhat later stage. The critics further complain that co-education is generally so organized that the girls' course of study is more or less assimilated to that of the boys, with the result that it cannot have the artistic and domestic character which is suitable for the majority of girls. Complaint is also made that the head of a co-educational school for pupils over the age of 10 is usually a man, though the health and character of girls need the care and control of a woman vested with complete authority and responsibility. While demurring to the view that co-education of the sexes would be a moral panacea, the critics of the system admit that the presence of the girls would exert a refining influence, but they believe that on the whole the boys are likely to gain less from co-education than the girls are likely to lose by it. In all these matters carefully recorded observation and experiment are needed, and it may well be found that co-education is best for some boys and for some girls, though not for all. Temperaments and dispositions differ. Some boys seem by nature more fitted for the kind of training generally given to girls; some girls are by nature fitted for the kind of training generally given to boys. The sex division does not mark off

temperaments into two sharply contrasted groups. The introduction of girls into boys' secondary schools may remove or mitigate coarse traditions of speech and conduct where such persist. But it would be unfortunate if stiff and pedantic traditions of secondary education were now fixed upon girls instead of being reconsidered and modified in the interests of boys also. In any case, if co-education in secondary schools is to yield the benefits which some anticipate from it, great vigilance, careful selection of pupils and very liberal staffing will be necessary. Without these securities the results of co-education in secondary schools might be disappointing, disquieting or even disastrous.

BIBLIOGRAPHY.—Plato in the *Republic* (v. 452-456) and *Laws* (vii. 804-805) argues that women should share as far as possible in education with men. Mary Wollstonecraft, *A Vindication of the Rights of Women* (1792), contends that "both sexes ought, not only in private families but in public schools, to be educated together." J. G. Spurzheim, *Principles of Education*, pp. 272-288 (Edinburgh, 1821), replies to this argument. In the Board of Education *Special Reports on Educational Subjects*, vol. vi. (Wyman & Sons, 1900), J. H. Badley, writing on *The Possibility of Co-education in English Preparatory and other Secondary Schools*, is strongly in favour. "In co-education . . . half-heartedness means failure. The more completely both sexes can be brought together upon an equal and natural footing the less the difficulties grow." In the Board of Education *Special Reports*, vol. xi. (Wyman & Sons, 1902), Rev. Cecil Grant, writing on *Can American Education be grafted upon the English Public School System?* answers strongly in the affirmative: co-education is recommended on eight grounds:—(1) Vast economy of expenditure; (2) return to the natural system; (3) discipline made easier; (4) intellectual stimulus; (5) a better balance in instruction; (6) improved manners; (7) prevention of extremes of masculinity or femininity; (8) a safeguard against the moral danger.

Co-education: a series of Essays (London, 1903), edited by Alice Woods, is in favour of co-education, nine practical workers recording their experience; this is one of the best books on the subject. J. H. Badley's *Co-education after Fifteen: its Value and Difficulties*. *Child Life* (London, January, 1906), is candid, judicious and practical. M. E. Sadler in *Reports on Secondary Education in Hampshire, Derbyshire and Essex* (1904, 1905 and 1906 respectively) gives details of the curriculum of many co-educational secondary schools. In the U.S. Commissioner of Education *Report for 1903*, vol. i. pp. 1047-1078, Anna Tolman Smith, writing on *Co-education in the Schools and Colleges of the United States*, gives an historical review of the subject with bibliography (compare bibliography in *Report of U.S. Commissioner of Education for 1900-1901*, pp. 1310-1325). G. Stanley Hall on *Adolescence, its Psychology and its Relations to Physiology, Anthropology, Sociology, Sex, Crime, Religion and Education*, vol. ii. chap. xvii., on Adolescent Girls and their education (New York, D. Appleton & Co., 1904), is strongly against co-education during adolescence. In W. Rein's *Encyklopädisches Handbuch der Pädagogik* (Langensalza, Beyer), art. "Gemeinsame Erziehung für Knaben und Mädchen," K. E. Palmgren is in favour of co-education (vol. iii. of 2nd ed. 1905). See also W. Rein, *Über gemeinsame Erziehung von Knaben und Mädchen* (Freiburg, 1903), and *Bericht über den I. Internationalen Kongress für Schulhygiene* (Nürnberg, 1904), vol. ii. pp. 140 ff., "Co-education in der höheren Schulen." (M. E. S.)

COEFFETEAU, NICOLAS (1574-1623), French theologian, poet and historian, was born at Saint-Calais. He entered the Dominican order and lectured on philosophy at Paris, being also "ordinary preacher" to Henry IV., and afterwards ambassador at Rome. In 1606 he was vicar-general of the congregation of France, and received from Marie de' Medici the revenues of the sees of Lombes and Saintes. He also administered the diocese of Metz, and was nominated to that of Marseilles in 1621, but ill-health obliged him here to take a coadjutor. Coeffeteau won considerable distinction in the controversy against the Protestant reformers and also wrote a *History of Rome from Augustus to Constantine*. Many of his theological writings were collected in one volume (Paris, 1622), and at the time of his death in 1623 he was engaged on a translation of the New Testament which is still in manuscript.

COEHOORN, MENNO, BARON VAN (1641-1704), Dutch soldier and military engineer, of Swedish extraction, was born at Leeuwarden in Friesland. He received an excellent military and general education, and at the age of sixteen became a captain in the Dutch army. He took part in the defence of Maastricht in 1673 and in the siege of Grave in the same year, where the small mortars (called coehorns) invented by him caused the French garrison considerable trouble (Seydel, *Nachrichten über Festungskriege*, Leipzig, 1818). He was made a colonel for his gallant

conduct at the battle of Seneff (1674), and was present also at the battles of Cassel (1677) and Saint Denis (1678).

The circumstances of the time and the country turned Coehoorn's attention to the art of fortification, and the events of the late war showed him that existing methods could no longer be relied upon. His first published work, *Versterckinge de Vijfhoek met alle syne Buytenwerken* (Leeuwarden, 1682), at once aroused attention, and involved the author in a lively controversy with a rival engineer, Louys Paan (Leeuwarden, 1682, 1683; copies are in the library of the Dutch ministry of war). The military authorities were much interested in this, and entrusted Coehoorn with the reconstruction of several fortresses in the Netherlands. This task he continued throughout his career; and his experience in the work made him the worthy rival of his great contemporary Vauban. He formulated his ideas a little later in his chief work, *Nieuwe Vestingbouw op en natte of lage horizont*, &c. (Leeuwarden, 1685), in which he laid down three "systems," the characteristic feature of which was the multiplicity and great saliency of the works, which were calculated and in principle are still eminently suited for flat and almost marshy sites such as those of the Low Countries. He borrowed many of the details from the works of his Dutch predecessor Freytag, of Albrecht Dürer, and of the German engineer Speckle, and in general he aimed rather at the adaptation of his principles to the requirements of individual sites than at producing a geometrically and theoretically perfect fortress; and throughout his career he never hesitated to depart from his own rules in dealing with exceptional cases, such as that of Groningen. Subsequent editions of *Nieuwe Vestingbouw* appeared in Dutch (1702, and frequently afterwards), English (London, 1705), French (Wesel, 1705), and German (Düsseldorf, 1709).

From 1688 to the treaty of Ryswick Coehoorn served as a brigadier. At the battle of Fleurus he greatly distinguished himself, and in 1692 he defended Namur, a fortress of his own creation. Namur was taken by Vauban; but the Dutch engineer had his revenge three years later, when the place, on which in the meantime Vauban had lavished his skill, fell to his attack. Coehoorn became lieutenant-general and inspector-general of the Netherlands fortresses, and the high-German peoples as well as his own countrymen honoured him. He commanded a corps in the army of the duke of Marlborough from 1701 to 1703, and in the constant siege warfare of these campaigns in the Low Countries his technical skill was of the highest value. The swift reduction of the fortress of Bonn and the siege of Huy in 1703 were his crowning successes. At the opening of his following campaign he was on his way to confer with Marlborough when he died of apoplexy at Wijkel on the 17th of March 1704.

His "first system" was applied to numerous places in Holland, notably Nijmegen, Breda and Bergen-op-Zoom. Mannheim in Germany was also fortified in this way, while the "second system" was applied to Belgrade and Temesvár in eastern Europe.

His son, Gosewijn Theodor van Coehoorn, wrote his life (re-edited Sypersstein, Leeuwarden, 1860). See also v. Zastrow, *Geschichte der beständigen Befestigung* (Leipzig, 1828); von Brese-Winiari, *Über Entstehen und Wesen der neueren Befestigungsmethode* (1844); Cosseran de Villenois, *Essai historique sur la fortification* (1869); Mandar, *Architecture des forteresses* (1801); Krayenhoff, *Verhandlung oer de eerste versterkingsmanier van Coehoorn* (Hague, 1823); Bosscha, *Nederlandsche heldend te Land* (Amsterdam, 1838); Dewez, *Histoire de Belgique* (Brussels, 1823); Ypey, *Narratio de rebus gestis Mennonis Cohorni* (1771); Hennert, *Dissertation sur la fortification permanente* (1795); Böhm, *Gründliche Anleitung zur Kriegsbaukunst* (1776); *Axiomas of allgemene bekenntnisse oer de Vestingbouw door Menno Baron van Coehoorn*, *Uytgewerkt door E. W. Berg* (MS. in Dutch Ministry of War); Bousmard, *Essai général de fortification* (1797); also the article **FORTIFICATION AND SIEGECRAFT**.

COELENTERA, a group or grade of the animal kingdom, the zoological importance of which has risen considerably since the time (1887) of the publication of the first article under that heading in the *Ency. Brit.* (9th edit.), even though their numbers have been reduced by the elevation of the Sponges or Porifera to the rank of an independent Phylum under the title Parazoa (W. J. Sollas, 1884). For the Coelentera thus restricted, the term Enterocoela, in contrast to Coelomoela (the old Coelomata), was suggested by E. R. Lankester (1900).

From the more complex colonial Protozoa the Coelentera are readily separated by their possession of two distinct sets of cells, with diverse functions, arranged in two definite layers,—a condition found in no Protozoan. The old criterion by which they and other Metazoa were once distinguished from Protozoa, namely, the differentiation of large and small sexual cells from each other and from the remaining cells of the body, has been broken down by the discovery of numerous cases of such differentiation among Protozoa. The Coelentera, as contrasted with other Metazoa (but not Parazoa), consist of two layers of cells only, an outer layer or ectoderm, an inner layer or endoderm. They have hence been described as Diploblastica. In the remaining Metazoa certain cells are budded off at an early stage of development from one or both of the two original layers, to form later a third layer, the mesoderm, which lies between the ectoderm and endoderm; such forms have therefore received the name Triploblastica. At the same time it is necessary to observe that it is by no means certain that the mesoderm found in various groups of Metazoa is a similar or homologous formation in all cases. A second essential difference between Coelentera and other Metazoa (except Parazoa) is that in the former all spaces in the interior of the body are referable to a single cavity of endodermal origin, the "gastro-vascular cavity," often termed the coelenteron: the spaces are always originally continuous with one another, and are in almost every case permanently so. This single cavity and its lining serve apparently for all those functions (digestion, excretion, circulation and often reproduction) which in more complex organisms are distributed among various cavities of independent and often very diverse origin.

In the Coelentera the ectoderm and endoderm are set apart from one another at a very early period in the life-history; generally either by delamination or invagination, processes described in the article EMBRYOLOGY. Between these two cell-layers a mesogloea (G. C. Bourne, 1887) is always intercalated as a secretion by one or both of them; this is a gelatinoid, primitively structureless lamella, which in the first instance serves merely as a basal support for the cells. In many cases, as, for example, in the Medusae or jelly-fish, the mesogloea may be so thick as to constitute the chief part of the body in bulk and weight. The ectoderm rarely consists of more than one layer of cells: these are divisible by structure and function into nervous, muscular and secretory cells, supported by interstitial cells. The endoderm is generally also an epithelium one cell in thickness, the cells being digestive, secretory and sometimes muscular. Reproductive sexual cells may be found in either of these two layers, according to the class and sub-class in question. The mesogloea is in itself an inert non-cellular secretion, but the immigration of muscular and other cells into its substance, from both ectoderm and endoderm, gives it in many cases a strong resemblance to the mesoderm of Triploblastica,—a resemblance which, while probably superficial, may yet serve to indicate the path of evolution of the mesoderm.

The Coelentera may thus be briefly defined as Metazoa which exhibit two embryonic cell-layers only,—the ectoderm and endoderm,—their body-cavities being referable to a single cavity or coelenteron in the endoderm. Their position in the animal kingdom and their main subdivisions may be expressed in the following table:—

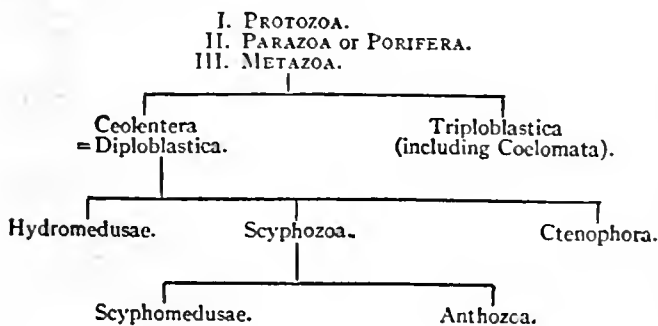

In the above-given classification, the Scyphomedusae, formerly included with the Hydromedusae as Hydrozoa, are placed nearer the Anthozoa. The reasons for this may be stated briefly.

The HYDROMEDUSAE are distinguished from the Scyphozoa chiefly by negative characters; they have no stomodaeum, that is, no ingrowth of ectoderm at the mouth to form an oesophagus; they have no mesenteries (radiating partitions) which incompletely subdivide the coelenteron; and they have no concentration of digestive cells into special organs. Their ectodermal muscles are mainly longitudinal, their endodermal muscles are circularly arranged on the body-wall. Their sexual cells are (probably in all cases) produced from the ectoderm, and lie in those radii which are first accentuated in development. They typically present two structural forms, the non-sexual hydroid and the sexual medusoid; in such a case there is an alternation of generations (metagenesis), the hydroid giving rise to the medusoid by a sexual gemmation, the medusoid bearing sexual cells which develop into a hydroid. In some other cases medusoid develops directly from medusoid (hypogenesis), whether by sexual cells or by gemmation. The medusoids have a muscular velum of ectoderm and mesogloea only.

The SCYPHOZOA have the following features in common:— They typically exhibit an ectodermal stomodaeum; partitions or mesenteries project into their coelenteron from the body-wall, and on these are generally concentrated digestive cells (to form mesenterial filaments, phacellae or gastric filaments, &c.); the external musculature of the body-wall is circular (except in *Ceriantlius*); the internal, longitudinal; and the sexual cells probably always arise in the endoderm.

The SCYPHOMEDUSAE, like the Hydromedusae, typically present a metagenesis, the non-sexual scyphistomoid (corresponding to the hydroid) alternating with the sexual medusoid. In other cases the medusoid is hypogenetic, medusoid producing medusoid. The sexual cells of the medusoid lie in the endoderm on interradial, that is, on the second set of radii accentuated in the course of development. The medusoids have no true velum; in some cases a structure more or less resembling this organ, termed a velarium, is present, permeated by endodermal canals.

The ANTHOZOA differ from the Scyphomedusae in having no medusoid form; they all more or less resemble a sea-anemone, and may be termed actinoid. They are (with rare exceptions, probably secondarily acquired) hypogenetic, the offspring resembling the parent, and both being sexual. The sexual cells are borne on the mesenteries in positions irrespective of obvious developmental radii.

The CTENOPHORA are so aberrant in structure that it has been proposed to separate them from the Coelentera altogether: they are, however, theoretically deducible from an ancestor common to other Coelentera, but their extreme specialization precludes the idea of any close relationship with the rest.

As regards the other three groups, however, it is easy to conceive of them as derived from an ancestor, represented to some extent by the planula-larva, which was Coelenterate so far as it was composed of an ectoderm and endoderm, and had an internal digestive cavity (I. of the table).

At the point of divergence between Scyphozoa and Hydromedusae (II. of the table of hypothetical descent), we may conceive of its descendant as tentaculate, capable of either floating (swimming) or fixation at will like *Lucernaria* to-day; and exhibiting incipient differentiation of myoepithelial cells (formerly termed neuro-muscular cells). At the parting of the ways which led, on the one hand, to modern Scyphomedusae, on the other to Anthozoa (III.), it is probable that the common ancestor was marked by incipient mesenteries and by the limitation of the sexual cells to endoderm. The lines of descent—II. to Hydromedusae, and III. to Scyphomedusae—represent periods during which the hypothetical ancestors II. and III., capable of either locomotion or fixation at will, were either differentiated into alternating generations of fixed sterile nutritive hydroids (scyphistomoids) and locomotor sexual medusoids, or abandoned the power of fixation in hypogenetic cases. During the period

represented by the line of descent—III. to Anthozoa—this group abandoned its power of adult locomotion by swimming. During

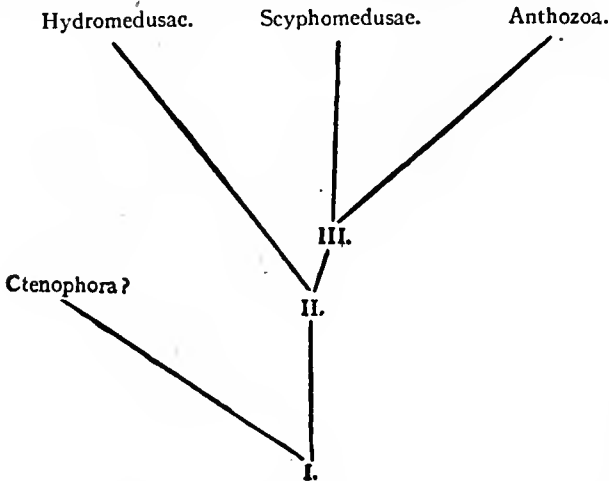

these periods were also attained those less important structural characters which these three groups present to-day. (G.H.Fo.)

COELLO, ALONSO SANCHEZ (1515–1590), Spanish painter, according to some authorities a native of Portugal, was born, according to others, at Benifacio, near the city of Valencia. He studied many years in Italy; and returning to Spain in 1541 he settled at Madrid, and worked on religious themes for most of the palaces and larger churches. He was a follower of Titian, and, like him, excelled in portraits and single figures, elaborating the textures of his armours, draperies, and such accessories in a manner so masterly as strongly to influence Velazquez in his treatment of like objects. Many of his pictures were destroyed in the fires that consumed the Madrid and Prado palaces, but many good examples are yet extant, among which may be noted the portraits of the infantes Carlos and Isabella, now in the Madrid gallery, and the St Sebastian painted in the church of San Gerónimo, also in Madrid. Coello left a daughter, Isabella Sanchez, who studied under him, and painted excellent portraits.

COELLO, ANTONIO (1610?–1652), Spanish dramatist and poet, was born at Madrid about the beginning of the 17th century. He entered the household of the duke de Albuquerque, and after some years of service in the army received the order of Santiago in 1648. He was a favourite of Philip IV., who is reported to have collaborated with him; this rumour is not confirmed, but there is ample proof of Coello's collaboration with Calderón, Rojas Zorrilla, Solís and Velez de Guevara, the most distinguished dramatists of the age. The best of his original plays, *Los Empeños de seis horas*, has been wrongly ascribed to Calderón; it was adapted by Samuel Tuke, under the title of *The Adventures of five Hours*, and was described by Pepys as superior to *Othello*. It is an excellent example of stagecraft and animated dialogue. Coello died on the 20th of October 1652, shortly after his nomination to a post in the household of Philip IV.

COELOM AND SEROUS MEMBRANES. In human anatomy the body-cavity or coelom (Gr. *κοῖλος*, hollow) is divided into the *pericardium*, the two *pleurae*, the *peritoneum* and the two *tunicae vaginales*.

The *pericardium* is a closed sac which occupies the central part of the thorax and contains the heart. Like all the serous membranes it has a visceral and a parietal layer, the former of which is closely applied to the heart and consists of endothelial cells with a slight fibrous backing: to it is due the glossy appearance of a freshly removed heart. The parietal layer is double; externally there is a strong fibrous protective coat which is continuous with the other fibrous structures in the neighbourhood, especially with the sheaths of the great vessels at the root of the heart, with prolongations of the fascia of the neck, and with the central tendon of the diaphragm, while internally is the serous layer which is reflected from the surface of the heart, where the

great vessels enter, so that everywhere the two layers of the serous membrane are in contact, and the only thing within the cavity is a drop or two of the fluid secreted by the serous walls. When the parietal layer is laid open and the heart removed by cutting through the great vessels, it will be seen that there are two lines of reflection of the serous layer, one common to the aorta and pulmonary artery, the other to all the pulmonary veins and the two venae cavae.

The *pleurae* very closely resemble the pericardium except that the fibrous outer coat of the parietal layer is not nearly as strong; it is closely attached to the inner surface of the chest walls and mesially to the outer layer of the pericardium; above it is thickened by a fibrous contribution from the scalene muscles, and this forms the *dome of the pleura* which fits into the concavity of the first rib and contains the apex of the lung. The reflection of the serous layer of the pleura, from the parietal to the visceral part, takes place at the root of the lung, where the great vessels enter, and continues for some distance below this as the *ligamentum latum pulmonis*. The upper limit of the pleural cavity reaches about half an inch above the inner third of the clavicle, while, below, it may be marked out by a line drawn from the twelfth thoracic spine to the tenth rib in the mid axillary line, the eighth rib in the nipple line, and the sixth rib at its junction with the sternum. There is probably very little difference in the lower level of the pleurae on the two sides.

The *peritoneum* is a more extensive and complicated membrane than either the pericardium or pleura; it surrounds the abdominal and pelvic viscera, and, like the other sacs, has a parietal and visceral layer. The line of reflection of these, though a continuous one, is very tortuous. The peritoneum consists of a *greater* and *lesser sac* which communicate through an opening known as the *foramen of Winslow*, and the most satisfactory way of understanding these is to follow the reflections first in a vertical

median (sagittal) section and then in a horizontal one, the body being supposed to be in the upright position. If a median sagittal section be studied first, and a start be made at the umbilicus (see fig. 1), the parietal peritoneum is seen to run upward, lining the anterior abdominal wall, and then to pass along the under surface of the diaphragm till its posterior third is reached; here there is a reflection on to the liver (L), forming the anterior layer of the *coronary ligament* of that viscus, while the membrane now becomes visceral and envelops the front of the liver as far back as the transverse fissure on its lower surface; here it is reflected on to the stomach (St) forming the anterior layer of the *gastro-hepatic* or *lesser omentum*. It now covers the front of the stomach, and at the lower border runs down as the anterior layer of an apron-like fold, the *great omentum*, which in some cases reaches as low as the pubes; then it turns up again as the posterior or fourth layer of the great omentum until the transverse colon (C) is reached, the posterior surface of which it covers and is reflected, as the posterior layer of the *transverse meso-colon*, to the lower part of the pancreas (P); after this it turns down and covers the anterior surface of the third part of the duodenum (D) till the posterior wall of the abdomen is reached, from which it is reflected on to the small intestine (I) as the anterior layer of the *mesentery*, a fold varying from 5 to 8 in. between its

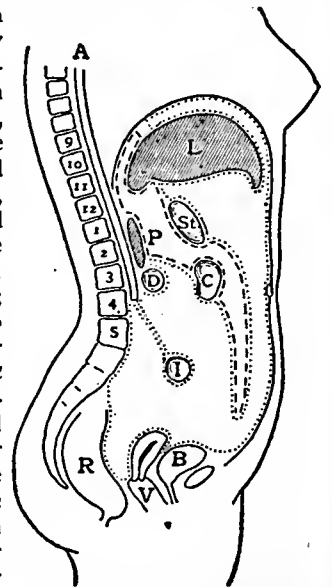

FIG. 1.—Diagram of vertical median section of Abdomen.

A, Aorta. D, Duodenum.
P, Pancreas. B, Bladder.
I, Intestine. St, Stomach.
R, Rectum. C, Colon.
L, Liver. V, Vagina.

(The fine dots represent the great sac of the peritoneum, the coarse dots the lesser sac.)

attachments. After surrounding the small intestine it becomes the posterior layer of the mesentery and so again reaches the posterior abdominal wall, down which it runs until the rectum (R) is reached. The anterior surface of this tube is covered by peritoneum to a point about 3 in. from the anus, where it is reflected on to the uterus and vagina (V) in the female and then on to the bladder (B); in the male, on the other hand, the reflection is directly from the rectum to the bladder. At the apex of the bladder, after covering the upper surface of that organ, it is lifted off by the urachus and runs up the anterior abdominal wall to the umbilicus, from which the start was made. All this is the greater sac. The tracing of the lesser sac may be conveniently started at the transverse fissure of the liver, whence the membrane runs down to the stomach (St) as the posterior layer of the lesser omentum, lines the posterior surface of the stomach, passes down as the second layer of the great omentum and up again as the third layer, covers the anterior surface of the transverse colon (C) and then reaches the pancreas (P) as the anterior layer of the transverse mesocolon. After this it covers the front of the pancreas and in the middle line of the body runs up below the diaphragm to within an inch of the anterior layer of the coronary ligament of the liver; here it is reflected on to the top of the Spigelian lobe of the liver to form the posterior

layer of the coronary ligament, covers the whole Spigelian lobe, and so reaches the transverse fissure, the starting-point.

This section, therefore, shows two completely closed sacs without any visible communication. In the female, however, the great sac is not absolutely closed, for the Fallopian tubes open into it by their

minute *ostia abdominalia*, while at the other ends they communicate with the cavity of the uterus and so with the vagina and exterior.

A horizontal section through the upper part of the first lumbar vertebra will, if a fortunate one (see fig. 2), pass through the foramen of Winslow and show the communication of the two sacs. A starting-point may be made from the mid-ventral line and the parietal peritoneum traced round the left side of the body wall until the outer edge of the left kidney (K) is reached; here it passes in front of the kidney and is soon reflected off on to the spleen, which it nearly surrounds; just before it reaches the hilum of that organ, where the vessels enter, it is reflected on to the front of the stomach (St), forming the anterior layer of the *gastro-splenic omentum*; it soon reaches the lesser curvature of the stomach and then becomes the anterior layer of the lesser omentum, which continues until the bile duct (B.D) and portal vein (P.V) are reached at its right free extremity; here it turns completely round these structures and runs to the left again, as the posterior layer of the lesser omentum, behind the stomach (St) and then to the spleen (Sp) as the posterior layer of the *gastro-splenic omentum*. From the spleen it runs to the right once more, in front of the pancreas (P), until the inferior vena cava (V.C) is reached, and this point is just behind the portal vein and is the place where the lesser and greater sacs communicate, known as the foramen of Winslow. From this opening the lesser sac runs to the left, while all the rest of the peritoneal cavity in the section is greater sac. From the front of the vena cava the parietal peritoneum passes in front of the right kidney (K) and round the right abdominal wall to the mid-ventral line. The right part of this section is filled by the liver (L), which is completely surrounded by a visceral layer of peritoneum, and no reflection

is usually seen at this level between it and the parietal layer. Some of the viscera, such as the kidneys and pancreas, are retro-peritoneal; others, such as the small intestines and transverse colon, are surrounded, except at one point where they are attached to the dorsal wall by a *mesentery* or *mesocolon* as the reflections are called; others again are completely surrounded, and of these the caecum is an example; while some, like the liver and bladder, have large uncovered areas, and the reflections of the membrane form ligaments which allow considerable freedom of movement.

The *tunica vaginalis* is the remains of a process of the peritoneum (*processus vaginalis*) which descends into the scrotum during foetal life some little time before the testis itself descends. After the descent of the testis the upper part usually becomes obliterated, while the lower part forms a serous sac which nearly surrounds the testis, but does not quite do so. Posteriorly the epididymis is in close contact with the testis, and here the visceral layer is not in contact; there is, however, a pocket called the *digital fossa* which squeezes in from the outer side between the testis and epididymis. The parietal layer lines the inner wall of its own side of the scrotum.

For a full description of the topography of the serous membranes see any of the standard text-books of anatomy, by Gray, Quain, Cunningham or Macalister. Special details will be found in Sir F. Treves' *Anatomy of the Intestinal Canal and Peritoneum* (London, 1885); C. B. Lockwood, *Hunterian Lectures on Hernia* (London, 1889); C. Addison, "Topographical Anatomy of the Abdominal Viscera in Man," *Jour. Anat.*, vols. 34, 35; F. Dixon and A. Birmingham, "Peritoneum of the Pelvic Cavity," *Jour. Anat.* vol. 34 p. 127; W. Waldeyer, "Das Becken" (1899), and "Topographical Sketch of the Lateral Wall of the Pelvic Cavity," *Jour. Anat.* vol. 32; B. Moynihan, *Retroperitoneal Hernia* (London, 1899). A complete bibliography of the subject up to 1895 will be found in *Quain's Anatomy*, vol. 3, part 4, p. 69.

Embryology.—As the mesoderm is gradually spreading over the embryo it splits into two layers, the outer of which is known as the *somatopleure* and lines the parietal or ectodermal wall,

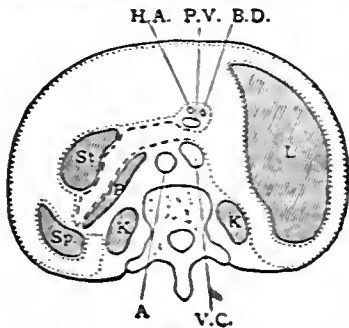
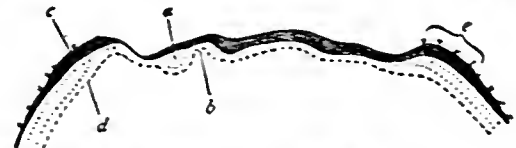

FIG. 2.—Diagram of Horizontal Section through upper part of 1st Lumbar Vertebra.

A, Aorta. H.A., Hepatic Artery. Sp., Spleen. B.D., Bile duct. V.C., Vena Cava. P., Pancreas. P.V., Portal Vein. K., Kidney. L., Liver. St., Stomach.

The dotting of the peritoneum is through the upper part of the first lumbar vertebra

will, if a fortunate one (see fig. 2), pass through the foramen of Winslow and show the communication of the two sacs. A starting-point may be made from the mid-ventral line and the parietal peritoneum traced round the left side of the body wall until the outer edge of the left kidney (K) is reached; here it passes in front of the kidney and is soon reflected off on to the spleen, which it nearly surrounds; just before it reaches the hilum of that organ, where the vessels enter, it is reflected on to the front of the stomach (St), forming the anterior layer of the *gastro-splenic omentum*; it soon reaches the lesser curvature of the stomach and then becomes the anterior layer of the lesser omentum, which continues until the bile duct (B.D) and portal vein (P.V) are reached at its right free extremity; here it turns completely round these structures and runs to the left again, as the posterior layer of the lesser omentum, behind the stomach (St) and then to the spleen (Sp) as the posterior layer of the *gastro-splenic omentum*. From the spleen it runs to the right once more, in front of the pancreas (P), until the inferior vena cava (V.C) is reached, and this point is just behind the portal vein and is the place where the lesser and greater sacs communicate, known as the foramen of Winslow. From this opening the lesser sac runs to the left, while all the rest of the peritoneal cavity in the section is greater sac. From the front of the vena cava the parietal peritoneum passes in front of the right kidney (K) and round the right abdominal wall to the mid-ventral line. The right part of this section is filled by the liver (L), which is completely surrounded by a visceral layer of peritoneum, and no reflection



After Young and Robinson, Cunningham's Text-Book of Anatomy. FIG. 3.—Diagram of Longitudinal Section, showing the different areas of the Blastodermic Vesicle.

c, Pericardium. b, Bucco-pharyngeal area. d, Entoderm. e, Ectoderm. f, Placental area.

while the inner lines the entoderm and is called the *splanchnopleure*; between the two is the coelom. The pericardial area is early differentiated from the rest of the coelom and at first lies in front of the neural and bucco-pharyngeal area; here the

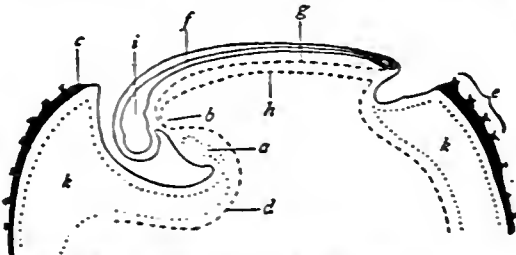

After Young and Robinson, Cunningham's Text-Book of Anatomy. FIG. 4.—Diagram of a Developing Ovum, seen in Longitudinal Section.

f, Spinal cord. g, Notochord. h, Dorsal wall of alimentary canal. i, Brain. j, Extra embryonic coelom. k, Other numbers as in fig. 3.

mesoderm stretches right across the mid-line, which it does not in front and behind. As the head fold of the embryo is formed the pericardium is gradually turned right over, so that the dorsal side becomes the ventral and the anterior limit the posterior; this will be evident on referring to the two accompanying diagrams.

The two primitive aortae lie at first in the ventral wall of the

pericardium, but with the folding over they come to lie in the dorsal wall and gradually bulge into the cavity as they coalesce to form the heart, so that the heart drops into the dorsal side of the pericardium and draws down a fold of the membrane called the *dorsal mesocardium*. In mammals A. Robinson (*Jour. Anat. and Phys.*, xxxvii. 1) has shown that no ventral mesocardium exists, though in more lowly vertebrates it is present. Laterally the pericardial cavity communicates with the general cavity of the coelom, but with the growth of the Cuvierian ducts (see development of veins) these communications disappear. Originally the mesocardium runs the whole length of the pericardium from before backward, but later on the middle part becomes obliterated, and so the two separate reflections from the parietal to the visceral layer, already noticed, are accounted for.

Just behind the pericardium and in front of the umbilicus, which at first are close together, the mesoderm forms a mass which is called the *septum transversum*, and into this the developing lungs push bag-like protrusions of the coelom, consisting of visceral and parietal layers, and these eventually lose their connexion with the rest of the coelom, as the diaphragm develops, and become the pleural cavities. After the pericardium and pleurae have been separated off the remainder of the coelom becomes the peritoneum. At first the stomach and intestine form a straight tube, which is connected to the dorsum of the embryo by a *dorsal mesentery* and to the mid-ventral wall in front of the umbilicus by a *ventral mesentery*. Into the ventral mesentery the liver grows as diverticula from the duodenum, so that some of the mesentery remains as the *falciform ligament* of the liver and some as the lesser omentum. Into the dorsal mesentery the pancreas grows, also as diverticula, from the duodenum, while the spleen is developed from the mesoderm contained in the same fold. As the stomach turns over so that its left side becomes ventral, the dorsal mesentery attached to it becomes pulled out, in such a way that part of it forms the great omentum and part the gastro-splenic omentum. After the caecum is formed as a diverticulum from the intestine it is situated close to the liver and gradually travels down into the right iliac fossa. This passage to the right is accompanied by a throwing over of the duodenal loop to the right, so that the right side of its mesentery becomes pressed against the dorsal wall of the abdomen and obliterated. This accounts for the fact that the pancreas and duodenum are only covered by peritoneum on their anterior surfaces in man. The formation of the lesser sac is due to the turning over of the stomach to the right, with the result that a cave, known sometimes as the *bursa omentalis*, is formed behind it. Originally, of course, the whole colon had a *dorsal mesocolon* continuous with the mesentery, but in the region of the ascending and descending colon this usually disappears and these parts of the gut are uncovered by peritoneum posteriorly. The transverse mesocolon persists and at first is quite free from the great omentum, but later, in man, the two structures fuse¹ and the fourth layer of the great omentum becomes continuous with the posterior layer of the transverse mesocolon.

For further details see Quain's *Anatomy* (London, 1908).

Comparative Anatomy.—In the Amphioxus the coelom is developed in the embryo as a series of bilateral pouches, called *enterocoelae*, from the sides of the alimentary canal; these are therefore entodermal in their origin, as in Sagitta and the Echinodermata among the invertebrates. In the adult the development of the atrium causes a considerable reduction of the coelom, represented by two dorsal coelomic canals communicating with a ventral canal by means of branchial canals which run down the outer side of the primary gill bars. Into the dorsal canals the nephridia open. In the intestinal region the coelom is only present on the left side.

In the higher vertebrates (*Craniala*) the coelom is developed by a splitting of the mesoderm into two layers, and a peri-

cardium is constricted off from the general cavity. In all cases the ova burst into the coelom before making their way to the exterior, and in some cases, e.g. amphioxus, lamprey (*Cyclostomata*), eels and mud-fish (*Dipnoi*), the sperm cells do so too. The Cyclostomata have a pair of *genital pores* which lead from the coelom into the urino-genital sinus, and so to the exterior.

In the Elasmobranch fish there is a *pericardio-peritoneal canal* forming a communication between these two parts of the coelom; also a large common opening for the two oviducts in the region of the liver, and two openings, called *abdominal pores*, on to the surface close to the cloacal aperture. In the Teleostomi (Teleostean and Ganoid fish) abdominal pores are rare, but in most Teleostei (bony fish) the ova pass directly down oviducts, as they do in Arthropods, without entering the peritoneal cavity; there is little doubt, however, that these oviducts are originally coelomic in origin. In the Dipnoi (mud-fish) abdominal pores are found, and probably serve as a passage for the sperm cells, since there are no vasa deferentia. In fishes a complete dorsal mesentery is seldom found in the adult; in many cases it only remains as a tube surrounding the vessels passing to the alimentary canal.

In the Amphibia, Reptilia and Aves, one cavity acts as pleura and peritoneum, though in the latter the lungs are not completely surrounded by a serous membrane. In many lizards the comparatively straight intestine, with its continuous dorsal mesentery and ventral mesentery in the anterior part of the abdomen, is very like a stage in the development of the human and other mammalian embryos. In the mammalia the diaphragm is complete (see DIAPHRAGM) and divides the pleuro-peritoneal cavity into its two constituent parts. In the lower mammals the derivatives of the original dorsal mesentery do not undergo as much fusion and obliteration as they do in adult man; the ascending and descending mesocolon is retained, and the transverse mesocolon contracts no adhesion to the great omentum. It is a common thing, however, to find a fenestrated arrangement of the great omentum which shows that its layers have been completely obliterated in many places.

In those animals, such as the rabbit, in which the tests are sometimes in the scrotum and sometimes in the abdomen, the communication between the peritoneum and the tunica vaginalis remains throughout life.

For further details and literature up to 1902, see R. Wiedersheim's *Vergleichende Anatomie der Wirbeltiere* (Jena, 1902). (F. G. P.)

COEN, JAN PIETERSZON (1587-1630), fourth governor-general of the Dutch East Indies, was born at Hoorn, and spent his youth at Rome in the house of the famous merchants the Piscatori. In 1607 he sailed from Amsterdam to the Indies as second commercial agent, and remained away four years. He had proved so capable that in 1612 he was sent out a second time at the head of a trading expedition. In the following year he was made a councillor and director-general of the East Indian trade. Afterwards he became president at Bantam, and on the 31st of October 1617 he was promoted in succession to Laurens Reaal to the post of governor-general. To his vigour and intrepidity the Dutch in no small measure owed the preservation and establishment of their empire in the East. He took and destroyed Jacatra, and founded on its ruins the capital of the Dutch East Indies, to which he gave the name of Batavia. In 1622 Coen obtained leave to resign his post and return to Holland, but in his absence great difficulties had arisen with the English at Amboina (the so-called massacre of Amboina), and in 1627 under pressure from the directors of the East India Company he again returned as governor-general to Batavia. In 1629 he was able to beat off a formidable attack of the sultan of Mataram, sometimes styled emperor of Java, upon Batavia. He died the following year.

COENACULUM, the term applied to the eating-room of a Roman house in which the supper (*coena*) or latest meal was taken. It was sometimes placed in an upper storey and reached by an external staircase. The Last Supper in the New Testament was taken in the Coenaculum, the "large upper room" cited in St Mark (xiv. 15) and St Luke (xxii. 12).

¹ Some authorities hold that this alteration is not brought about by fusion, but by a dragging away of the posterior layer of the great omentum from the dorsal wall of the abdomen.

CÆNWULF (d. 821), king of Mercia, succeeded to the throne in 796, on the death of Ecgrith, son of Offa. His succession is somewhat remarkable, as his direct ancestors do not seem to have held the throne for six generations. In 798 he invaded Kent, deposed and imprisoned Eadberht Præn, and made his own brother Cuthred king. Cuthred reigned in Kent from 798 to 807, when he died, and Cœnwulf seems to have taken Kent into his own hands. It was during this reign that the archbishopric of Lichfield was abolished, probably before 803, as the Hygeberht who signed as an abbot at the council of Cloveshoe in that year was presumably the former archbishop. Cœnwulf appears from the charters to have quarrelled with Wulfred of Canterbury, who was consecrated in 806, and the dispute continued for several years. It was probably only settled at Cloveshoe in 825, when the lawsuit of Cwœnthryth, daughter and heiress of Cœnwulf, with Wulfred was terminated. Cœnwulf may have instigated the raid of Æthelmund, earl of the Hwicce, upon the accession of Ecgerht. He died in 821, and was succeeded by his brother Ceolwulf I.

See Earle and Plummer's edition of the *Anglo-Saxon Chronicle*, 796, 819 (Oxford, 1892); W. de G. Birch, *Cartularium Saxonicum*, 378 (London, 1885-1893). (F. G. M. B.)

COERCION (from Lat. *coercere*, to restrain), an application of moral or physical compulsion by which a person is forced to do or refrain from doing some act or set of acts apart from his own voluntary motion. Where the coercion is direct or positive, *i.e.* where the person is compelled by physical force to do an act contrary to his will,—for example, when a man is compelled to join a rebel army, and to serve as a soldier under threats of death,—his act is not legally a crime. Where the coercion is implied, as when a person is legally under subjection to another, the person coerced, having no will on the subject, is not responsible. But this principle is applied only within narrow limits, and does not extend to the command of a superior to an inferior; of a parent to a child; of a master to his servant or a principal to his agent. Where, however, a married woman commits a crime in the presence of her husband, she is generally presumed to have acted by his coercion, and to be entitled to acquittal, but this presumption does not extend to grave crimes, nor to those in which the principal part may be supposed to be taken by the woman, such as keeping a brothel. In civil matters, such as the making of a contract, where the law requires the free assent of the person who undertakes the obligation, coercion is a ground for invalidating the instrument.

The term "coercion" is inevitably somewhat ambiguous, and depends on the circumstances of the case. In a political sense, the application of the Crimes Act of 1887 to Ireland was called "coercion" by those opposed to the English Unionist party and government, as being special legislation differing from the ordinary law applicable in the United Kingdom.

CŒUR, JACQUES (c. 1395-1456), founder of the trade between France and the Levant, was born at Bourges, in which city his father, Pierre Cœur, was a rich merchant. Jacques is first heard of about 1418, when he married Macée de Léodepart, daughter of Lambert de Léodepart, an influential citizen, provost of Bourges, and a former valet of John, duke of Berry. About 1429 he formed a commercial partnership with two brothers named Godard; and in 1432 he was at Damascus, buying and bartering, and transporting the wares of the Levant—gall-nuts, wools and silks, goats' hair, brocades and carpets—to the interior of France by way of Narbonne. In the same year he established himself at Montpellier, and there began those gigantic operations which have made him illustrious among financiers. Details are wanting; but it is certain that in a few years he placed his country in a position to contend not unsuccessfully with the great trading republics of Italy, and acquired such reputation as to be able, mere trader as he was, to render material assistance to the knights of Rhodes and to Venice herself.

In 1436 Cœur was summoned to Paris by Charles VII., and made master of the mint that had been established in that city. The post was of vast importance, and the duties onerous. The country was deluged with the base moneys of three reigns, charged

with superscriptions both French and English, and Charles had determined on a sweeping reform. In this design he was ably seconded by the merchant, who, in fact, inspired or prepared all the ordinances concerning the coinage of France issued between 1435 and 1451. In 1438 he was made steward of the royal expenditure; in 1441 he and his family were ennobled by letters patent. In 1444 he was sent as one of the royal commissioners to preside over the new parlement of Languedoc, a dignity he bore till the day of his disgrace. In 1445 his agents in the East negotiated a treaty between the sultan of Egypt and the knights of Rhodes; and in 1447, at his instance, Jean de Village, his nephew by marriage, was charged with a mission to Egypt. The results were most important; concessions were obtained which greatly improved the position of the French consuls in the Levant, and that influence in the East was thereby founded which, though often interrupted, was for several centuries a chief commercial glory of France. In the same year Cœur assisted in an embassy to Amadeus VIII., former duke of Savoy, who had been chosen pope as Felix V. by the council of Basel; and in 1448 he represented the French king at the court of Pope Nicholas V., and was able to arrange an agreement between Nicholas and Amadeus, and so to end the papal schism. Nicholas treated him with the utmost distinction, lodged him in the papal palace, and gave him a special licence to traffic with the infidels. From about this time he made large advances to Charles for carrying on his wars; and in 1449, after fighting at the king's side through the campaign, he entered Rouen in his train.

At this moment the great trader's glory was at its height. He had represented France in three embassies, and had supplied the sinews of that war which had ousted the English from Normandy. He was invested with various offices of dignity, and possessed the most colossal fortune that had ever been amassed by a private Frenchman. The sea was covered with his ships; he had 300 factors in his employ, and houses of business in all the chief cities of France. He had built houses and chapels, and had founded colleges in Paris, at Montpellier and at Bourges. The house at Bourges (see HOUSE, Plate II. figs. 7 and 8) was of exceptional magnificence, and remains to-day one of the finest monuments of the middle ages in France. He also built there the sacristy of the cathedral and a sepulchral chapel for his family. His brother Nicholas was made bishop of Luçon, his sister married Jean Bochetel, the king's secretary, his daughter married the son of the viscount of Bourges, and his son Jean became archbishop of Bourges. But Cœur's gigantic monopoly caused his ruin. Dealing in everything, money and arms, peltry and jewels, brocades and woollens—a broker, a banker, a farmer—he had absorbed the trade of the country, and merchants complained they could make no gains on account of "that Jacquet." He had lent money to needy courtiers, to members of the royal family, and to the king himself, and his debtors, jealous of his wealth, were eager for a chance to cause his overthrow.

In February 1450 Agnes Sorel, the king's mistress, suddenly died. Eighteen months later it was rumoured that she had been poisoned, and a lady of the court who owed money to Jacques Cœur, Jeanne de Vendôme, wife of Francois de Montberon, and an Italian, Jacques Colonna, formally accused him of having poisoned her. There was not even a pretext for such a charge, but for this and other alleged crimes the king, on the 31st of July 1451, gave orders for his arrest and for the seizure of his goods, reserving to himself a large sum of money for the war in Guienne. Commissioners extraordinary, the merchant's declared enemies, were chosen to conduct the trial, and an inquiry began, the judges in which were either the prisoner's debtors or the holders of his forfeited estates. He was accused of having paid French gold and ingots to the infidels, of coining light money, of kidnapping oarsmen for his galleys, of sending back a Christian slave who had taken sanctuary on board one of his ships, and of committing frauds and exactions in Languedoc to the king's prejudice. He defended himself with all the energy of his nature. His innocence was manifest; but a conviction was necessary, and in spite of strenuous efforts on the part of his friends, after twenty-two

months of confinement in five prisons, he was condemned to do public penance for his fault, to pay the king a sum equal to about £1,000,000 of modern money, and to remain a prisoner till full satisfaction had been obtained; his sentence also embraced confiscation of all his property, and exile during royal pleasure. On the 5th of June 1453 the sentence took effect; at Poitiers the shameful form of making honourable amends was gone through; and for nearly three years nothing is known of him. It is probable that he remained in prison; it is certain that his vast possessions were distributed among the intimates of Charles.

In 1455 Jacques Cœur, wherever confined, contrived to escape into Provence. He was pursued; but a party, headed by Jean de Village and two of his old factors, carried him off to Tarascon, whence, by way of Marseilles, Nice and Pisa, he managed to reach Rome. He was honourably and joyfully received by Nicholas V., who was fitting out an expedition against the Turks. On the death of Nicholas, Calixtus III. continued his work, and named his guest captain of a fleet of sixteen galleys sent to the relief of Rhodes. Cœur set out on this expedition, but was taken ill at Chios, and died there on the 25th of November 1456. After his death Charles VII. showed himself well disposed to the family, and allowed Jacques Cœur's sons to come into possession of whatever was left of their father's wealth.

See the admirable monograph of Pierre Clément, *Jacques Cœur et Charles VII* (1858, 2nd ed. 1874); A. Valet de Viriville, *Charles Sept et son époque* (3 vols., 1862-1865); and Louisa Costello, *Jacques Cœur, the French Argonaut* (London, 1847).

CŒUR D'ALÈNE ("awl-heart," the French translation of the native name *skitswish*), a tribe of North American Indians of Salishan stock. The name is said to have been originally that of a chief noted for his cruelty. The tribe has given its name to a lake, river and range of mountains in Idaho, where on a reservation the survivors, some 400, are settled.

COFFEE (Fr. *café*, Ger. *Kaffee*). This important and valuable article of food is the produce chiefly of *Coffea arabica*, a Rubiaceoous plant indigenous to Abyssinia, which, however, as cultivated originally, spread outwards from the southern parts of Arabia. The name is probably derived from the Arabic K'hawah, although by some it has been traced to Kaffa, a province in Abyssinia, in which the tree grows wild.

The genus *Coffea*, to which the common coffee tree belongs, contains about 25 species in the tropics of the Old World, mainly African. Besides being found wild in Abyssinia, the common coffee plant appears to be widely disseminated in Africa, occurring wild in the Mozambique district, on the shores of the Victoria Nyanza, and in Angola on the west coast. The coffee leaf disease in Ceylon brought into prominence Liberian coffee (*C. liberica*), a native of the west coast of Africa, now extensively grown in several parts of the world. Other species of economic importance are Sierra Leone

coffee (*C. stenophylla*) and Congo coffee (*C. robusta*), both of which have been introduced into and are cultivated on a small scale in various parts of the tropics. *C. excelsa* is another species of considerable promise.

The common Arabian coffee shrub is an evergreen plant, which under natural conditions grows to a height of from 18 to 20 ft., with oblong-ovate, acuminate, smooth and shining leaves, measuring about 6 in. in length by 2½ wide. Its flowers, which

are produced in dense clusters in the axils of the leaves, have a five-toothed calyx, a tubular five-parted corolla, five stamens and a single bifid style. The flowers are pure white in colour, with a rich fragrant odour, and the plants in blossom have a lovely and attractive appearance, but the bloom is very evanescent. The fruit is a fleshy berry, having the appearance and size of a small cherry, and as it ripens it assumes a dark red colour. Each fruit contains two seeds embedded in a yellowish pulp, and the seeds are enclosed in a thin membranous endocarp (the "parchment"). Between each seed and the parchment is a delicate covering called the "silver skin." The seeds which constitute the raw coffee "beans" of commerce are plano-convex in form, the flat surfaces which are laid against each other within the berry having a longitudinal furrow or groove. When only one seed is developed in a fruit it is not flattened on one side, but circular in cross section. Such seeds form "pea-berry" coffee.

The seeds are of a soft, semi-translucent, bluish or greenish colour, hard and tough in texture. The regions best adapted for the cultivation of coffee are well-watered mountain slopes at an elevation ranging from 1000 to 4000 ft. above sea-level, within the tropics, and possessing a mean annual temperature of about 65° to 70° F.

The Liberian coffee plant (*C. liberica*) has larger leaves, flowers and fruits, and is of a more robust and hardy constitution, than Arabian coffee. The seeds yield a highly aromatic and well-flavoured coffee (but by no means equal to Arabian), and the plant is very prolific and yields heavy crops. Liberian coffee grows, moreover, at low altitudes, and flourishes in many situations unsuitable to the Arabian coffee. It grows wild in great abundance along the whole of the Guinea coast.

History.—The early history of coffee as an economic product is involved in considerable obscurity, the absence of fact being compensated for by a profusion of conjectural statements and mythical stories. The use of coffee (*C. arabica*) in Abyssinia was recorded in the 15th century, and was then stated to have been practised from time immemorial. Neighbouring countries, however, appear to have been quite ignorant of its value. Various legendary accounts are given of the discovery of the beneficial properties of the plant, one ascribing it to a flock of sheep accidentally browsing on the wild shrubs, with the result that they became elated and sleepless at night! Its physiological action in dissipating drowsiness and preventing sleep was taken advantage of in connexion with the prolonged religious service of the Mahommedans, and its use as a devotional antisoporific stirred up fierce opposition on the part of the strictly orthodox and conservative section of the priests. Coffee by them was held to be an intoxicating beverage, and therefore prohibited by the Koran, and severe penalties were threatened to those addicted to its use. Notwithstanding threats of divine retribution and other devices, the coffee-drinking habit spread rapidly among the Arabian Mahommedans, and the growth of coffee and its use as a national beverage became as inseparably connected with Arabia as tea is with China.

Towards the close of the 16th century the use of coffee was recorded by a European resident in Egypt, and about this epoch it came into general use in the near East. The appreciation of coffee as a beverage in Europe dates from the 17th century. "Coffee-houses" were soon instituted, the first being opened in Constantinople and Venice. In London coffee-houses date from 1652, when one was opened in St Michael's Alley, Cornhill. They soon became popular, and the rôle played by them in the social life of the 17th and 18th centuries is well known. Germany, France, Sweden and other countries adopted them at about the same time as Great Britain. In Europe, as in Arabia, coffee at first made its way into favour in the face of various adverse and even prohibitive restrictions. Thus at one time in Germany it was necessary to obtain a licence to roast coffee. In England Charles II. endeavoured to suppress coffee-houses on the ground that they were centres of political agitation, his royal proclamation stating that they were the resort of disaffected persons "who devised and spread abroad divers false, malicious and



FIG. 1.—Branch of *Coffea arabica*.

scandalous reports, to the defamation of His Majesty's government, and to the disturbance of the peace and quiet of the nation."

Up to the close of the 17th century the world's entire, although limited, supply of coffee was obtained from the province of Yemen in south Arabia, where the true celebrated Mocha or Mokka coffee is still produced. At this time, however, plants were successfully introduced from Arabia to Java, where the cultivation was immediately taken up. The government of Java distributed plants to various places, including the botanic garden of Amsterdam. The Portuguese introduced coffee into Ceylon. From Amsterdam the Dutch sent the plant to Surinam in 1718, and in the same year Jamaica received it through the governor Sir Nicholas Lawes. Within a few years coffee reached the other West Indian islands, and spread generally through the tropics of the New World, which now produce by far the greater portion of the world's supply.

Cultivation and Preparation for Market.—Coffee plants are grown from seeds, which, as in the case of other crops, should be obtained from selected trees of desirable characteristics. The seeds may be sown "at stake," *i.e.* in the actual positions the mature plants are to occupy, or raised in a nursery and afterwards transplanted. The choice of methods is usually determined by various local considerations. Nurseries are desirable where there is risk of drought killing seedlings in the open. Whilst young the plants usually require to be shaded, and this may be done by growing castor oil plants, cassava (*Manihot*), maize or Indian corn, bananas, or various other useful crops between the coffee, until the latter develop and occupy the ground. Sometimes, but by no means always, permanent shading is afforded by special shade trees, such as species of the coral tree (*Erythrina*) and other leguminous trees. Opinions as to the necessity of shade trees varies in different countries; *e.g.* in Brazil and at high elevations in Jamaica they are not employed, whereas in Porto Rico many look on them as absolutely essential. It is probable that in many cases where shade trees are of advantage their beneficial action may be indirect, in affording protection from wind, drought or soil erosion, and, when leguminous plants are employed, in enriching the soil in nitrogen. The plants begin to come into bearing in their second or third year, but on the average the fifth is the first year of considerable yield. There may be two, three, or even more "flushes" of blossom in one year, and flowers and fruits in all stages may thus be seen on one plant. The fruits are fully ripe about seven months after the flowers open; the ripe fruits are fleshy, and of a deep red colour, whence the name of "cherry." When mature the fruits are picked by hand, or allowed to fall of their own accord or by shaking the plant. The subsequent preparation may be according to (1) the dry or (2) the wet method.

In the dry method the cherries are spread in a thin layer, often on a stone drying floor, or barbecue, and exposed to the sun. Protection is necessary against heavy dew or rain. The dried cherries can be stored for any length of time, and later the dried pulp and the parchment are removed, setting free the two beans contained in each cherry. This primitive and simple method is employed in Arabia, in Brazil and other countries. In Brazil it is giving place to the more modern method described below.

In the wet, or as it is sometimes called, West Indian method, the cherries are put in a tank of water. On large estates galvanized spouting is often employed to convey the beans by the help of running water from the fields to the tank. The mature cherries sink, and are drawn off from the tank through pipes to the pulping machines. Here they are subjected to the action of a roughened cylinder revolving closely against a curved iron plate. The fleshy portion is reduced to a pulp, and the mixture of pulp and liberated seeds (each still enclosed in its parchment) is carried away to a second tank of water and stirred. The light pulp is removed by a stream of water and the seeds allowed to settle. Slight fermentation and subsequent washings, accompanied by trampling with bare feet and stirring by rakes or special machinery, result in the parchment coverings being left quite clean. The beans are now dried on barbecues, in trays, &c.,

or by artificial heat if climatic conditions render this necessary. Recent experiments in Porto Rico tend to show that if the weather is unfavourable during the crop period the pulped coffee can be allowed to remain moist and even to malt or sprout without injury to the final value of the product when dried later. The product is now in the state known as parchment coffee, and may be exported. Before use, however, the parchment must be removed. This may be done on the estate, at the port of shipment, or in the country where imported. The coffee is thoroughly dried, the parchment broken by a roller, and removed by winnowing. Further rubbing and winnowing removes the silver skin, and the beans are left in the condition of ordinary unroasted coffee. Grading into large, medium and small beans, to secure the uniformity desirable in roasting, is effected by the use of a cylindrical or other pattern sieve, along which the beans are made to travel, encountering first small, then medium, and finally large apertures or meshes. Damaged beans and foreign matter are removed by hand picking. An average yield of cleaned coffee is from 1½ to 2 lb per tree, but much greater crops are obtained on new rich lands, and under special conditions.

Production.—The centre of production has shifted greatly since coffee first came into use in Europe. Arabia formerly supplied the world; later the West Indies and then Java took the lead, to be supplanted in turn by Brazil, which now produces about three-quarters of the world's supply and controls the market.

Brazil.—Coffee planting is the chief industry of Brazil, and coffee the principal export. The states of São Paulo, Rio de Janeiro, Minas Geraes and Santos, contain the chief coffee-producing lands. The annual output ranges from about 10,000,000 to 16,000,000 bags (of 120 lb each), whilst the world's annual consumption is more or less stationary at about 16,000,000 bags. The overwhelming importance of the Brazilian output is thus evident. Recently efforts have been made to restrict production to maintain prices, and the Coffee Convention scheme came into force in São Paulo on December 1, 1906, and in Rio de Janeiro and Minas Geraes on January 1, 1907. The cultivation in general is very primitive in character, periodical weeding being almost all the attention the plants receive. Manuring is commonly confined to mulches of the cut weeds and addition of the coffee husks. New lands in São Paulo yield from 80 cwt. to 100 cwt. of cleaned coffee per 1000 trees (700 go to the acre); the average yield, however, is not more than 15 cwt. The plants are at their best when from 10 to 15 years old, but continue yielding for 30 years or even more.

Other South American Countries.—Venezuela, Colombia, Ecuador, Peru, and to a much less degree Bolivia and Paraguay, produce coffee, the annual crops of the two former countries being each of about £1,500,000 in value.

Central America.—Guatemala produces the most in this region; the coffee estates are mainly controlled by Germans, who have brought them to a high pitch of perfection. The crop ranges in value from about £1,000,000 to £1,500,000 per annum. Costa Rica and San Salvador produce about half this amount. In Nicaragua, Honduras and Panama, coffee is extensively cultivated, and all export the product.

West Indies.—Coffee is grown in most of the islands, often only for local use. Haiti produces the largest amount, the annual value of the crop being about £500,000. Porto Rico formerly had a flourishing industry, but it has declined owing to various causes. The interior is still expected to be devoted largely to coffee, and the U.S. Department of Agriculture has carried out experiments to improve methods and ensure the cultivation of better varieties. Jamaica produces the famous Blue Mountain Coffee, which compares favourably with the best coffees of the world, and also ordinary or "plain grown"; the Blue Mountain is cultivated at elevations of from 3000 to 4500 ft. Coffee usually ranks third or fourth in value amongst the exports of the island.

Africa. the native country of the coffees, does not now contribute any important amount to the world's output. In Liberia, the Gold Coast and elsewhere on the West Coast are many plantations, but the low prices ruling of recent years have caused coffee to be neglected for more remunerative crops. Coffee is, however, still the principal export of Nyasaland (British Central Africa), where it was introduced as recently as 1894. The area under coffee has been greatly reduced, owing partly to more attention being paid to cotton, partly to droughts and other causes. In Somaliland and Abyssinia coffee cultivation is of very ancient date. Two kinds are exported, Harrari and Habashi. The former compares favourably with Mocha coffee. The industry could be very considerably extended. In Natal, Rhodesia, &c., coffee is grown, but not in sufficient quantity to supply the local demand.

Arabia.—The name "Mocha" is applied generally to coffee produced in Arabia. Turkey and Egypt obtain the best grades. Traders from these countries go to Arabia, buy the crops on the trees, and supervise its picking and preparation themselves. The coffee is prepared by the "dry method."

India is the principal coffee-growing region in the British empire, and produces about one-fifth of the total supply of the United Kingdom. There are some 213,000 acres under coffee, mostly in southern India. The official report states that the production of coffee is restricted for the most part to a limited area in the elevated region above the south-western coast, the coffee lands of Mysore, Coorg, and the Madras districts of Malabar and the Nilgiris, comprising 86% of the whole area under the plant in India. About one-half of the whole coffee-producing area is in Mysore. In Burma, Assam and Bombay, coffee is of minor importance. During 1904-1906 there was a reduction of the area under coffee in India by 21,554 acres.

Ceylon.—The history of coffee in Ceylon is practically that of the coffee-leaf disease (see below). The Dutch introduced Arabian coffee in 1720, but abandoned its cultivation later. It was revived by the British, and developed very rapidly between 1836 and 1845, when there was a temporary collapse owing to financial crisis in the United Kingdom. In 1880 the exports of coffee were of the value of about £2,784,163. Ten years later they had fallen to £430,633, owing to the ravages of the coffee-leaf disease. The output continued to decrease, and the value of the crop in 1906 was only £17,258. Liberian coffee, which is hardier and more resistant to disease, was introduced, but met with only partial success.

Dutch East Indies.—Coffee from this source passes under the general name of "Java," that island producing the greatest amount; Sumatra, Borneo and the Celebes, &c., however, also contribute. The Java plantations are largely owned by the government. Much of the coffee from these islands is of a high quality.

Australasia.—Coffee can be cultivated in the northern territories of Australia, but comparatively little is done with this crop; Queensland produces the largest amount.

Hawaii, &c.—In all the islands of the Hawaiian group coffee is grown, but nine-tenths or more is raised in Hawaii itself, the Kona district being the chief seat of production. The exports go mostly to the United States, and there is also a large local consumption.

Coffee thrives well also in the Philippines and Guam.

The World's Trade.—The following figures, from the *Year-book* of the U. S. Department of Agriculture, indicate the relative importance of the coffee-exporting countries.

Country.	1904. Exports coffee in lb.	1905. Exports coffee in lb.
America—		
Brazil	1,326,027,795	1,431,328,038
Colombia	130,000,000	(est.) 70,000,000
Venezuela	128,000,000	" 94,370,090
Haiti	81,407,346	45,244,232
Salvador	75,314,003	61,822,223
Guatemala	71,653,700	81,081,600
Mexico	41,855,368	42,456,491
Costa Rica	27,730,672	39,788,002
Nicaragua	21,661,621	18,171,515
Porto Rico	15,330,590	
Jamaica	5,781,440	9,046,464
Asia—		
Dutch East Indies	77,168,254	72,864,649
British India	36,920,464	40,340,384
Singapore (port of export)	12,367,156	11,935,034
Other countries	216,891,567	220,132,690
Total	2,268,109,976	2,238,581,412

In 1906 there was an increased total of 2,680,855,878 lb, due to the Brazil export rising to 1,847,367,771 lb. The aggregate value of the coffee annually entering the world's markets is about £40,000,000.

Coffee Consumption.—The United States of America consume nearly one half of all the coffee exported from the producing countries of the world. This might of course be due merely to the States containing more coffee-drinkers than other countries, but the average consumption per head in the country is about 11 to 12 lb per annum, an amount equalled or excelled only in Norway, Sweden and Holland. Whilst one great branch of the Anglo-Saxon stock is near the head of the list, it is interesting to note that the United Kingdom and also Canada and Australia are almost at the foot, using only about 1 lb of coffee per head each year. Germany, with a consumption of about 6 to 7 lb per person per annum uses considerably less than a quarter of the world's commercial crop. France, about 5 lb per head, takes about one eighth; and Austria-Hungary, about 2 lb, uses some one-sixteenth. Holland consumes approximately as much, but with a much smaller population, the Dutch using more per head than any other people—14 lb to 15 lb per annum. Their taste is seen also in the relatively high consumption in South Africa. Sweden, Belgium and the United Kingdom, follow next in order of total amount used.

In many tropical countries much coffee is drunk, but as it is often produced locally exact figures are not available. The average consumption in the United Kingdom is about 50,000,000 lb per annum; about one-fifth only is produced in the British empire, and of this about nineteen-twentieths come from India and one-twentieth from the British West Indies.

Coffee-leaf Disease.—The coffee industry in Ceylon was ruined by the attack of a fungoid disease (*Hemileia vastatrix*) known as the Ceylon coffee-leaf disease. This has since extended its ravages into every coffee-producing country in the Old World, and added greatly to the difficulties of successful cultivation. The fungus is a microscopic one, the minute spores of which, carried by the wind, settle and germinate upon the leaves of the plant. The

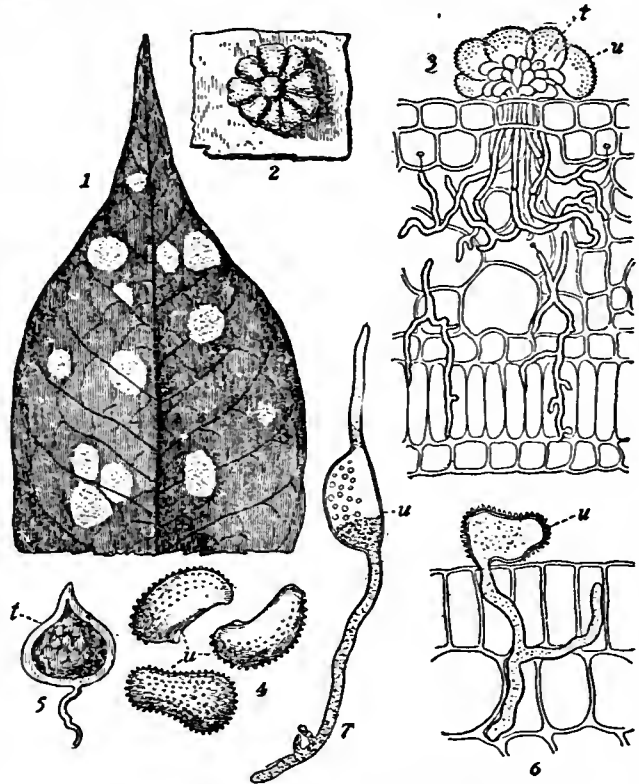

FIG. 2.—Coffee-leaf Disease, *Hemileia vastatrix*.

- 1, Part of leaf showing diseased patches.
- 2, Cluster of uredospores.
- 3, Transverse section of a diseased patch in the leaf showing the hyphae of the fungus pushing between the leaf-cells and tapping them for nourishment. The hyphae have broken through in the upper face and are forming a cluster of spores.
- 4, Ripe uredospores.
- 5, A teleutospore.
- 6, A uredospore germinating, the germ-tube is penetrating the leaf.
- 7, Uredospore germinating.
- 8, Uredospore.
- 9, Teleutospore.
- 2-7, Highly magnified.

fungus spreads through the substance to the leaf, robbing the leaf of its nourishment and causing it to wither and fall. An infected plantation may be cleansed, and the fungus in its nascent state destroyed, by powdering the trees with a mixture of lime and sulphur, but, unless the access of fresh spores brought by the wind can be arrested, the plantations may be readily reinfected when the lime and sulphur are washed off by rain. The separation of plantations by belts of trees to windward is suggested as a check to the spread of the disease.

Microscopic Structure.—Raw coffee seeds are tough and horny in structure, and are devoid of the peculiar aroma and taste which are so characteristic of the roasted seeds. The minute structure of coffee allows it to be readily recognized by means of the microscope, and as roasting does not destroy its distinguishing peculiarities, microscopic examination forms the readiest means of determining the genuineness of any sample. The substance of the seed, according to Dr Hassall, consists "of an assemblage

of vesicles or cells of an angular form, which adhere so firmly together that they break up into pieces rather than separate into distinct and perfect cells. The cavities of the cells include, in the form of little drops, a considerable quantity of aromatic volatile

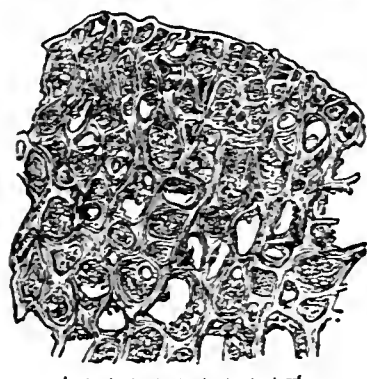

FIG. 3.—Microscopic structure of Coffee.

oil, on the presence of which the fragrance and many of the active principles of the berry depend" (see fig. 3).

Physiological Action.—Coffee belongs to the medicinal or auxiliary class of food substances, being solely valuable for its stimulant effect upon the nervous and vascular system. It produces a feeling of buoyancy and exhilaration comparable to a certain stage of alcoholic intoxication, but which does not end in depression

or collapse. It increases the frequency of the pulse, lightens the sensation of fatigue, and it sustains the strength under prolonged and severe muscular exertion. The value of its hot infusion under the rigours of Arctic cold has been demonstrated in the experience of all Arctic explorers, and it is scarcely less useful in tropical regions, where it beneficially stimulates the action of the skin.

The physiological action of coffee mainly depends on the presence of the alkaloid caffeine, which occurs also in tea, Paraguay tea, and cola nuts, and is very similar to theobromine, the active principle in cocoa. The percentage of caffeine present varies in the different species of *Coffea*. In Arabian coffee it ranges from about 0.7 to 1.6%; in Liberian coffee from 1.0 to 1.5%. Sierra Leone coffee (*C. stenophylla*) contains from 1.52 to 1.70%; in *C. excelsa* 1.89% is recorded, and as much as 1.97% in *C. canephora*. Four species have been shown by M. G. Bertrand to contain no caffeine at all, but instead a considerable quantity of a bitter principle. All these four species are found only in Madagascar or the neighbouring islands. Other coffees grown there contain caffeine as usual. Coffee, with the caffeine extracted, has also been recently prepared for the market. The commercial value of coffee is determined by the amount of the aromatic oil, caffeine, which develops in it by the process of roasting. By prolonged keeping it is found that the richness of any seeds in this peculiar oil is increased, and with increased aroma the coffee also yields a blander and more mellow beverage. Stored coffee loses weight at first with great rapidity, as much as 8% having been found to dissipate in the first year of keeping, 5% in the second, and 2% in the third; but such loss of weight is more than compensated by improvement in quality and consequent enhancement of value.

Roasting.—In the process of roasting, coffee seeds swell up by the liberation of gases within their substance,—their weight decreasing in proportion to the extent to which the operation is carried. Roasting also develops with the aromatic caffeine above alluded to a bitter soluble principle, and it liberates a portion of the caffeine from its combination with the caffetannic acid. Roasting is an operation of the greatest nicety, and one, moreover, of a crucial nature, for equally by insufficient and by excessive roasting much of the aroma of the coffee is lost; and its infusion is neither agreeable to the palate nor exhilarating in its influence. The roaster must judge of the amount of heat required for the adequate roasting of different qualities, and while that is variable, the range of roasting temperature proper for individual kinds is only narrow. In continental countries it is the practice to roast in small quantities, and thus the whole charge is well under the control of the roaster; but in Britain large roasts are the rule, in dealing with which much difficulty is experienced in producing uniform torrefaction, and in stopping the process at the proper moment. The coffee-roasting apparatus is usually a malleable iron cylinder mounted to revolve over the

fire on a hollow axle which allows the escape of gases generated during torrefaction. The roasting of coffee should be done as short a time as practicable before the grinding for use, and as ground coffee especially parts rapidly with its aroma, the grinding should only be done when coffee is about to be prepared.

Adulteration.—Although by microscopic, physical and chemical tests the purity of coffee can be determined with perfect certainty, yet ground coffee is subjected to many and extensive adulterations (see also ADULTERATION). Chief among the adulterant substances, if it can be so called, is chicory; but it occupies a peculiar position, since very many people on the European continent as well as in Great Britain deliberately prefer a mixture of chicory with coffee to pure coffee. Chicory is indeed destitute of the stimulant alkaloid and essential oil for which coffee is valued; but the facts that it has stood the test of prolonged and extended use, and that its infusion is, in some localities, used alone, indicate that it performs some useful function in connexion with coffee, as used at least by Western communities. For one thing, it yields a copious amount of soluble matter in infusion with hot water, and thus gives a specious appearance of strength and substance to what may be really only a very weak preparation of coffee. The mixture of chicory with coffee is easily detected by the microscope, the structure of both, which they retain after torrefaction, being very characteristic and distinct. The granules of coffee, moreover, remain hard and angular when mixed with water, to which they communicate but little colour; chicory, on the other hand, swelling up and softening, yields a deep brown colour to water in which it is thrown. The specific gravity of an infusion of chicory is also much higher than that of coffee. Among the numerous other substances used to adulterate coffee are roasted and ground roots of the dandelion, carrot, parsnip and beet; beans, lupins and other leguminous seeds; wheat, rice and various cereal grains; the seeds of the broom, fenugreek and iris; acorns; "negro coffee," the seeds of *Cassia occidentalis*, the seeds of the ochro (*Hibiscus esculentus*), and also the soja or soy bean (*Glycine Soya*). Not only have these with many more similar substances been used as adulterants, but under various high-sounding names several of them have been introduced as substitutes for coffee; but they have neither merited nor obtained any success, and their sole effect has been to bring coffee into undeserved disrepute with the public.

Not only is ground coffee adulterated, but such mixtures as flour, chicory and coffee, or even bran and molasses, have been made up to simulate coffee beans and sold as such.

The leaves of the coffee tree contain caffeine in larger proportion than the seeds themselves, and their use as a substitute for tea has frequently been suggested. The leaves are actually so used in Sumatra, but being destitute of any attractive aroma such as is possessed by both tea and coffee, the infusion is not palatable. It is, moreover, not practicable to obtain both seeds and leaves from the same plant, and as the commercial demand is for the seed alone, no consideration either of profit or of any dietetic or economic advantage is likely to lead to the growth of coffee trees on account of their leaves. (A. B. R.; W. G. F.)

COFFER (Fr. *coffre*, O. Fr. *cofre* or *cofne*, Lat. *coffinus*, cf. "coffin"), in architecture, a sunk panel in a ceiling or vault; also a casket or chest in which jewels or precious goods were kept, and, if of large dimensions, clothes. The marriage coffers in Italy were of exceptional richness in their carving and gilding and were sometimes painted by great artists.

COFFERDAM, in engineering. To enable foundations (q.v.) to be laid in a site which is under water, the engineer sometimes surrounds it with an embankment or dam, known as a cofferdam, to form an enclosure from which the water is excluded. Where the depth of water is small and the current slight, simple clay dams may be used, but in general cofferdams consist of two rows of piles, the space between which is packed with clay puddle. The dam must be sufficiently strong to withstand the exterior pressure to which it is exposed when the enclosed space is pumped dry.

COFFEYVILLE, a city of Montgomery county, Kansas, U.S.A., on the Verdigris river, about 150 m. S. of Topeka and near the

southern boundary of the state. Pop. (1890) 2282; (1900) 4953, of whom 803 were negroes; (1905) 13,196; (1910) 12,687. Coffeyville is served by the Missouri Pacific, the Atchison, Topeka & Santa Fé, the Missouri, Kansas & Texas, and the Saint Louis, Iron Mountain & Southern railways, and by inter-urban electric railway to Independence. It is in the Kansas natural-gas field, ships large quantities of grain, and has a large zinc oxide smelter and a large oil refinery, and various manufactures, including vitrified brick and tile, flour, lumber, chemicals, window glass, bottles, pottery and straw boards. The municipality owns and operates its water-works and electric lighting plant. Coffeyville, named in honour of A. M. Coffey, who was a member of the first legislature of the territory of Kansas, was founded in 1869, but in 1871 it was removed about 1 m. from its original site, now known as "old town." It was incorporated as a city of the third class in 1872 and received a new charter in 1887. Coffeyville became a station on the Leavenworth, Lawrence & Galveston railway (now part of the Atchison, Topeka & Santa Fé), and for several years large numbers of cattle were driven here from Indian Territory and Texas for shipment; in fact, the city's chief importance was as a trade centre for the north part of Indian Territory until natural gas was found here in large quantities in 1892.

COFFIN (from Lat. *coffinus*, Gr. *κόφος*, a coffer, chest or basket, but never meaning "coffin" in its present sense), the receptacle in which a corpse is confined. The Greeks and Romans disposed of their dead both by burial and by cremation. Greek coffins varied in shape, being in the form of an urn, or like the modern coffins, or triangular, the body being in a sitting posture. The material used was generally burnt clay, and in some cases this had obviously been first moulded round the body, and so baked. Cremation was the commonest method of disposing of the dead among the Romans, until the Christian era, when stone coffins came into use. Examples of these have been frequently dug up in England. In 1853, during excavations for the foundations of some warehouses in Hayden Square, Minorities, London, a Roman stone coffin was found within which was a leaden shell. Others have been found at Whitechapel, Stratford-le-Bow, Old Kent Road and Battersea Fields, and in great numbers at Colchester, York, Southfleet and Kingsholme near Gloucester. In early England stone coffins were only used by the nobles and the wealthy. Those of the Romans who were rich enough had their coffins made of a limestone brought from Assos in Troas, which it was commonly believed "ate the body"; hence arose the name sarcophagus (q.v.).

The coffins of the Chaldeans were generally clay urns with the top left open, resembling immense jars. These, too, must have been moulded round the body, as the size of the mouth would not admit of its introduction after the clay was baked. The Egyptian coffins, or sarcophagi, as they have been improperly called, are the largest stone coffins known and are generally highly polished and covered with hieroglyphics, usually a history of the deceased. Mummy chests shaped to the form of the body were also used. These were made of hard wood or *papier mâché* painted, and like the stone coffins bore hieroglyphics. The Persians, Parthians, Medes and peoples of the Caspian are not known to have had any coffins, their usual custom being to expose the body to be devoured by beasts and birds of prey. Unhewn flat stones were sometimes used by the ancient European peoples to line the grave. One was placed at the bottom, others stood on their edges to form the sides, and a large slab was put on top, thus forming a rude cist. In England after the Roman invasion these rude cists gave place to the stone coffin, and this, though varying much in shape, continued in use until the 16th century.

The most primitive wooden coffin was formed of a tree-trunk split down the centre, and hollowed out. The earliest specimen of this type is in the Copenhagen museum, the implements found in it proving that it belonged to the Bronze Age. This type of coffin, more or less modified by planing, was used in medieval Britain by those of the better classes who could not afford stone, but the poor were buried without coffins, wrapped simply in cloth or even covered only with hay and flowers. Towards the

end of the 17th century, coffins became usual for all classes. It is worth noting that in the Burial Service in the Book of Common Prayer the word "coffin" is not used.

Among the American Indians some tribes, e.g. the Sacs, Foxes and Sioux, used rough hewn wooden coffins; others, such as the Seris, sometimes enclosed the corpse between the carapace and plastron of a turtle. The Seminoles of Florida used no coffins, while at Santa Barbara, California, canoes containing corpses have been found buried though they may have been intended for the dead warrior's use in the next world. Rough stone cists, too, have been found, especially in Illinois and Kentucky. In their tree and scaffold burial the Indians sometimes used wooden coffins, but oftener the bodies were simply wrapped in blankets. Canoes mounted on a scaffold near a river were used as coffins by some tribes, while others placed the corpse in a canoe or wicker basket and floated them out into the stream or lake (see FUNERAL RITES). The aborigines of Australia generally used coffins of bark, but some tribes employed baskets of wicker-work.

Lead coffins were used in Europe in the middle ages, shaped like the mummy chests of ancient Egypt. Iron coffins were more rare, but they were certainly used in England and Scotland as late as the 17th century, when an order was made that upon bodies so buried a heavier burial fee should be levied. The coffins used in England to-day are generally of elm or oak lined with lead, or with a leaden shell so as to delay as far as possible the process of disintegration and decomposition. In America glass is sometimes used for the lids, and the inside is lined with copper or zinc. The coffins of France and Germany and the continent generally, usually differ from those of England in not being of the ordinary hexagonal shape but having sides and ends parallel. Coffins used in cremation throughout the civilized world are of some light material easily consumed and yielding little ash. Ordinary thin deal and *papier mâché* are the favourite materials. Coffins for what is known as Earth to Earth Burial are made of wicker-work covered with a thin layer of *papier mâché* over cloth.

See also FUNERAL RITES; CREMATION; BURIAL AND BURIAL ACTS; EMBALMING; MUMMY, &c.

BIBLIOGRAPHY.—Dr H. C. Yarrow, "Study of the Mortuary Customs of the North American Indians," *Report of Bureau of Amer. Ethnol.* vol. i. (Washington, U.S.A., 1881); Rev. Thomas Hugo, "On the Hayden Square Sarcophagus," *Journ. of Archaeol. Soc.* vol. ix. (London, 1854); C. V. Creagh, "On Unusual Forms of Burial by People of the East Coast of Borneo," *J.A.I.* vol. xxvi. (London, 1896-1897); Rev. J. Edward Vaux, *Church Folk-lore* (1894).

COG. (1) (From an older *cogge*, a word which appears in various forms in Teutonic languages, as in O. Ger. *kogge* or *kocke*, and also in Romanic, as in O. Fr. *cogue*, or *coque*, from which the Eng. "cock-boat" is derived; the connexion between the Teutonic and the Romanic forms is obscure), a broadly built, round-shaped ship, used as a trader and also as a ship of war till the 15th century. (2) (A word of obscure origin, possibly connected with Fr. *coche*, and Ital. *cocca*, a notch; the Celtic forms *cog* and *cocas* come from the English), a tooth in a series of teeth, morticed on to, or cut out of the circumference of a wheel, which works with the tooth in a corresponding series on another wheel (see MECHANICS). (3) (Also of quite obscure origin), a slang term for a form of cheating at dice. The early uses of the word show that this was done not by "loading" the dice, as the modern use of the expression of "cogged dice" seems to imply, but by sleight of hand in directing the fall or in changing the dice.

COGERS HALL, a London tavern debating society. It was instituted in 1755 at the White Bear Inn (now St Bride's Tavern), Fleet Street, moved about 1850 to Discussion Hall, Shoe Lane, and in 1871 finally migrated to the Barley Mow Inn, Salisbury Square, E.C., its present quarters. The name is often wrongly spelt Codgers and Coggers; the "o" is really long, the accepted derivation being from Descartes' *Cogito, ergo sum*, and thus meaning "The society of thinkers." The aims of the Coggers were "the promotion of the liberty of the subject and the freedom of the Press, the maintenance of loyalty to the laws,

the rights and claims of humanity and the practice of public and private virtue." Among its early members Cogers Hall reckoned John Wilkes, one of its first presidents, and Curran, who in 1773 writes to a friend that he spent a couple of hours every night at the Hall. Later Dickens was a prominent member.

See Peter Rayleigh, *History of Ye Antient Society of Cogers* (London, 1904).

COGHLAN, CHARLES FRANCIS (1841-1899), Irish actor, was born in Paris, and was educated for the law. He made his first London appearance in 1860, and became the leading actor at the Prince of Wales's. He went to America in 1876, where he remained for the rest of his life, playing first in Augustin Daly's company and then in the Union-Square stock company, during the long run of *The Celebrated Case*. He also played with his sister, and in support of Mrs Langtry and Mrs Fiske, and in 1898 produced a version of Dumas' *Kean*, called *The Royal Box*, in which he successfully starred during the last years of his life. He died in Galveston, Texas, on the 27th of November 1899.

His sister, the actress ROSE COGHLAN (1853-), went to America in 1871, was again in England from 1873 to 1877, playing with Barry Sullivan, and then returned to America, where she became prominent as Countess Zicka in *Diplomacy*, and Stephanie in *Forget-me-not*. She was at Wallack's almost continuously until 1888, and subsequently appeared in melodrama in parts like the title-rôle of *The Sporting Duchess*.

COGNAC, a town of south-western France, capital of an arrondissement in the department of Charente, on the left bank of the river Charente, 32 m. W. of Angoulême on the Ouest-État railway, between Angoulême and Saintes. Pop. (1906) 18,389. The streets of the old town—which borders the river—are narrow and tortuous, but the newer parts are well provided with open spaces. The chief of these is the beautiful Parc Francois I^{er} overlooking the Charente. In one of the squares there is a statue of Francis I., who was born here. The chief building is a church of the 12th century dedicated to St Leger, which preserves a fine Romanesque façade and a tower of the 15th century. A castle of the 15th and 16th centuries, once the residence of the counts of Angoulême, now a storehouse for brandy, and a medieval gate stand in the older part of the town. Cognac is the seat of a subprefect and has tribunals of first instance and of commerce, a council of trade arbitrators, a chamber of commerce, and consulates of the United States, Spain and Portugal. Its most important industry is the distillation of the brandy (*q.v.*) to which the town gives its name. Large quantities are carried, by way of the river, to the neighbouring port of Tonnay-Charente. The industries subsidiary to the brandy trade, such as the making of cases and bottles, occupy many hands. Ironware is also manufactured, and a considerable trade is maintained in grain and cattle. In 1526 Cognac gave its name to a treaty concluded against Charles V. by Francis I., the pope, Venice and Milan. Its possession was contested during the wars of religion, and in 1570 it became one of the Huguenot strongholds. In 1651 it successfully sustained a siege against Louis II., prince of Condé, leader of the Fronde.

See *Le Pays du Cognac*, by L. Ravaz, for a description of the district and its viticulture.

COGNITION (Latin *cognitio*, from *cognoscere*, to become acquainted with), in psychology, a term used in its most general sense for all modes of being conscious or aware of an object, whether material or intellectual. It is an ultimate mode of consciousness, strictly the presentation (through sensation or otherwise) of an object to consciousness; in its complete form, however, it seems to involve a judgment, *i.e.* the separation from other objects of the object presented. The psychological theory of cognition takes for granted the dualism of the mind that knows and the object known; it takes no account of the metaphysical problem as to the possibility of a relation between the ego and the non-ego, but assumes that such a relation does exist. Cognition is therefore distinct from emotion and conation; it has no psychological connexion with feelings of pleasure and pain, nor does it tend as such to issue in action.

For the analysis of cognition-reactions see O. Külpe, *Outlines of*

Psychology (Eng. trans., 1895), pp. 411 foll.; E. B. Titchener, *Experimental Psychology* (1905), ii. 187 foll. On cognition generally, G. F. Stout's *Analytic Psychology and Manual of Psychology*. W. James's *Principles of Psychology* (1890), i. 216 foll.; also article **PSYCHOLOGY**.

COGNIZANCE (Lat. *cognoscere*, to know), knowledge, notice, especially judicial notice, the right of trying or considering a case judicially, the exercise of jurisdiction by a court of law. In heraldry a "cognizance" is an emblem, badge or device, used as a distinguishing mark by the body of retainers of a royal or noble house.

COHEN (Hebrew for "priest"), a Jewish family name, implying descent from the ancient Hebrew priests. Many families claiming such descent are, however, not named Cohen. Other forms of the name are Cohn, Cowen, Kahn.

See J. Jacobs, *Jewish Encyclopedia*, iv. 144.

COHN, FERDINAND JULIUS (1828-1898), German botanist, was born on the 24th of January 1828 at Breslau. He was educated at Breslau and Berlin, and in 1859 became extraordinary, and in 1871 ordinary, professor of botany at Breslau University. He had a remarkable career, owing to his Jewish origin. He was contemporary with N. Pringsheim, and worked with H. R. Goepfert, C. G. Nees von Esenbeck, C. G. Ehrenberg and Johannes Müller. At an early date he exhibited astonishing ability with the microscope, which he did much to improve, and his researches on cell-walls and the growth and contents of plant-cells soon attracted attention, especially as he made remarkable advances in the establishment of an improved cell-theory, discovered the cilia in, and analysed the movements of, zoospores, and pointed out that the protoplasm of the plant-cell and the sarcode of the zoologists were one and the same physical vehicle of life. Although these early researches were especially on the Algae, in which group he instituted marked reforms of the rigid system due to F. T. Kützing, Cohn had already displayed that activity in various departments which made him so famous as an all-round naturalist, his attention at various times being turned to such varied subjects as *Aldrovanda*, torsion in trees, the nature of waterspouts, the effects of lightning, physiology of seeds, the proteid crystals in the potato, which he discovered, the formation of travertin, the rotatoria, luminous worms, &c.

It is, however, in the introduction of the strict biological and philosophical analysis of the life-histories of the lower and most minute forms of life that Cohn's greatest achievements consist, for he applied to these organisms the principle that we can only know the phases of growth of microscopic plants by watching every stage of development under the microscope, just as we learn how different are the youthful and adult appearances of an oak or a fern by direct observation. The success with which he attempted and carried out the application of cultural and developmental methods on the Algae, Fungi and Bacteria can only be fully appreciated by those familiar with the minute size and elusive evolutions of these organisms, and with the limited appliances at Cohn's command. Nevertheless his account of the life-histories of *Protococcus* (1850), *Stephanosphaera* (1852), *Volvox* (1856 and 1875), *Hydrodictyon* (1861), and *Sphaeroplea* (1855-1857) among the Algae have never been put aside. The first is a model of what a study in development should be; the last shares with G. Thuret's studies on *Fucus* and Pringsheim's on *Vaucheria* the merit of establishing the existence of a sexual process in Algae. Among the Fungi Cohn contributed important researches on *Pilobolus* (1851), *Empusa* (1855), *Tarichium* (1860), as well as valuable work on the nature of parasitism of Algae and Fungi.

It is as the founder of bacteriology that Cohn's most striking claims to recognition will be established. He seems to have been always attracted particularly by curious problems of fermentation and coloration due to the most minute forms of life, as evinced by his papers on *Monas prodigiosa* (1850) and "Über blutähnliche Färbungen" (1850), on infusoria (1851 and 1852), on organisms in drinking-water (1853), "Die Wunder des Blutes" (1854), and had already published several works on insect epidemics (1869-1870) and on plant diseases, when his first specially bacteriological memoir (*Crenothrix*) appeared in

the journal, *Beiträge zur Biologie*, which he then started (1870-1871), and which has since become so renowned. Investigations on other branches of bacteriology soon followed, among which "Organismen der Pockenlymphe" (1872) and "Untersuchungen über Bacterien" (1872-1875) are most important, and laid the foundations of the new department of science which has now its own laboratories, literature and workers specially devoted to its extension in all directions. When it is remembered that Cohn brought out and helped R. Koch in publishing his celebrated paper on *Anthrax* (1876), the first clearly worked out case of a bacterial disease, the significance of his influence on bacteriology becomes apparent.

Among his most striking discoveries during his studies of the forms and movements of the Bacteria may be mentioned the nature of Zoogloea, the formation and germination of true spores—which he observed for the first time, and which he himself discovered in *Bacillus subtilis*—and their resistance to high temperatures, and the bearing of this on the fallacious experiments supposed to support abiogenesis; as well as works on the bacteria of air and water, the significance of the bright sulphur granules in sulphur bacteria, and of the iron oxide deposited in the walls of *Crenothrix*. His discoveries in these and in other departments all stand forth as mementoes of his acute observation and reasoning powers, and the thoughtful (in every sense of the word) consideration of the work of others, and suggestive ideas attached to his principal papers, bear the same characteristics. If we overcome the always difficult task of bridging in imagination the interval between our present platform of knowledge and that on which bacteriologists stood in, say, 1870, we shall not undervalue the important contributions of Cohn to the overthrow of the then formidable bugbear known as the doctrine of "spontaneous generation," a dogma of despair calculated to impede progress as much in its day as that of "vitalism" did in other periods. Cohn had also clear perceptions of the important bearings of Mycology and Bacteriology in infective diseases, as shown by his studies in insect-killing fungi, microscopic analysis of water, &c. He was a foreign member of the Royal Society and of the Linnean Society, and received the gold medal of the latter in 1895. He died at Breslau on the 25th of June 1898.

Lists of his papers will be found in the *Catalogue of Scientific Papers of the Royal Society*, and in *Ber. d. d. bot. Gesellsch.*, 1899, vol. xvii. p. (196). The latter also contains (p. (172)) a full memoir by F. Rosen. (H. M. W.)

COHN, GUSTAV (1840-), German economist, was born on the 12th of December 1840 at Marienwerder, in West Prussia. He was educated at Berlin and Jena universities. In 1869 he obtained a post at the polytechnic in Riga, and in 1875 was elected a professor at the polytechnic at Zürich. In 1873 he went to England for a period of study, and as a result published his *Untersuchungen über die englische Eisenbahnpolitik* (Leipzig, 1874-1875). In 1884 he was appointed professor of political science at Göttingen. Cohn's best-known works are *System der Nationalökonomie* (Stuttgart, 1885); *Finanzwissenschaft* (1889); *Nationalökonomische Studien* (1886), and *Zur Geschichte und Politik des Verkehrswezens* (1900).

COHOES, a city of Albany county, New York, U.S.A., about 9 m. N. of Albany, at the confluence of the Mohawk and Hudson rivers. Pop. (1890) 22,509; (1900) 23,910, of whom 7303 were foreign-born; (1910) 24,709. It is served by the New York Central & Hudson River and the Delaware & Hudson railways, by electric lines to Troy and Albany, and by the Erie and Champlain canals. It is primarily a manufacturing city. Hosiery and knit goods, cotton cloth, cotton batting, shoddy, underwear and shirts and collars are the principal products, but there are also extensive valve works and manufactories of pulp, paper and paper boxes, beer, pins and needles, tools and machinery, and sash, doors and blinds. The value of the factory products in 1905 was \$10,289,822, of which \$4,126,873, or 40.1%, was the value of hosiery and knit goods, Cohoes ranking fifth among the cities of the United States (of 20,000 inhabitants or more) in this industry, and showing a higher degree of specializa-

tion in it than any other city in the United States except Little Falls, N.Y. The Falls of the Mohawk, which furnish power for the majority of the manufacturing establishments, are 75 ft. high and 900 ft. broad, a large dam above the falls storing the water, which is conveyed through canals to the mills. Below the falls the river is crossed by two fine iron bridges. The city has a public library, a normal training school and the St Bernard's (Roman Catholic) Academy. Cohoes was a part of the extensive manorial grant made to Killian Van Rensselaer in 1629 and it was probably settled very soon afterwards. It was incorporated as a village in 1848 and was chartered as a city in 1876.

COHORT (Lat. *cohors*), originally a place enclosed: in the Roman army, the name of a unit of infantry. The troops of the first grade, the legions, were divided into cohorts, of which there were ten in each legion: the cohort thus contained 600 men. Among the troops of the second grade (the *auxilia*) the cohorts were independent foot regiments 500 or 1000 strong, corresponding to the *alae*, which were similar regiments of cavalry; they were generally posted on the frontiers of the Empire in small forts of four to eight acres, each holding one cohort or *ala*. The special troops of Rome itself, the Praetorian Guard, the Urbanæ Cohortes, and the Vigiles (fire brigade), were divided into cohorts (see further ROMAN ARMY). The phrase *cohors praetoria* or *cohors amicorum* was sometimes used, especially during the Roman republic, to denote the suite of the governor of a province; hence developed the Praetorian cohorts which formed the emperor's bodyguard.

In biology, "cohort" is a term for a group of allied orders or families of plants or animals.

COIF (from Fr. *coiffe*, Ital. *cuffia*, a cap), a close-fitting covering for the head. Originally it was the name given to a head-covering worn in the middle ages, tied like a night-cap under the chin, and worn out of doors by both sexes; this was later worn by men as a kind of night-cap or skull-cap. The coif was also a close-fitting cap of white lawn or silk, worn by English serjeants-at-law as a distinguishing mark of their profession. It became the fashion to wear on the top of the white coif a small skull-cap of black silk or velvet; and on the introduction of wigs at the end of the 17th century a round space was left on the top of the wig for the display of the coif, which was afterwards covered by a small patch of black silk edged with white (see A. Pulling, *Order of the Coif*, 1897). The random conjecture of Sir H. Spelman (*Glossarium archaologicum*) that the coif was originally designed to conceal the ecclesiastical tonsure has unfortunately been quoted by annotators of Blackstone's *Commentaries* as well as by Lord Campbell in his *Lives of the Chief Justices*. It may be classed with the curious conceit, recorded in Brand's *Popular Antiquities*, that the coif was derived from the child's caul, and was worn on the advocate's head for luck.

COIMBATORE, a city and district of British India, in the Madras presidency. The city is situated on the left bank of the Noyil river, 305 m. from Madras by the Madras railway. In 1901 it had a population of 53,080, showing an increase of 14% in the decade. The city stands 1437 ft. above sea-level, is well laid out and healthy, and is rendered additionally attractive to European residents by its picturesque position on the slopes of the Nilgiri hills. It is an important industrial centre, carrying on cotton weaving and spinning, tanning, distilling, and the manufacture of coffee, sugar, manure and saltpetre. It has two second-grade colleges, a college of agriculture, and a school of forestry.

The DISTRICT OF COIMBATORE has an area of 7860 sq. m. It may be described as a flat, open country, hemmed in by mountains on the north, west and south, but opening eastwards on to the great plain of the Carnatic; the average height of the plain above sea-level is about 900 ft. The principal mountains are the Anamalai Hills, in the south of the district, rising at places to a height of between 8000 and 9000 ft. In the west the Palghat and Vallagiri Hills form a connecting link between the Anamalai range and the Nilgiris, with the exception of a remarkable gap known as the Palghat Pass. This gap, which completely intersects the Ghats, is about 20 m. wide. In the north is a range

of primitive trap-hills known as the Cauvery chain, extending eastwards from the Nilgiris, and rising in places to a height of 4000 ft. The principal rivers are the Cauvery, Bhavani, Noyil, and Amravati. Numerous canals are cut from the rivers for the purpose of affording artificial irrigation, which has proved of immense benefit to the country. Well and tank water is also largely used for irrigation purposes. Coimbatore district was acquired by the British in 1799 at the close of the war which ended with the death of Tippoo. In 1901 the population was 2,201,782, showing an increase of 10% in the preceding decade. The principal crops are millet, rice, other food grains, pulse, oilseeds, cotton and tobacco, with a little coffee. Forests cover nearly 1½ million acres, yielding valuable timber (teak, sandalwood, &c.), and affording grazing-ground for cattle. There are several factories for pressing cotton, and for cleaning coffee, oil-cake presses, tanneries and saltpetre refineries. Cereals, cotton, forest products, cattle and hides, and brass and copper vessels are the chief exports from the district. The south-west line of the Madras railway runs through the district, and the South Indian railway (of metre gauge) joins this at Erode.

COIMBRA, the capital of an administrative district formerly included in the province of Beira, Portugal; on the north bank of the river Mondego, 115 m. N.N.E. of Lisbon, on the Lisbon-Oporto railway. Pop. (1900) 18,144. Coimbra is built for the most part on rising ground, and presents from the other side of the river a picturesque and imposing appearance; though in reality its houses have individually but little pretension, and its streets are, almost without exception, narrow and mean. It derives its present importance from being the seat of the only university in the kingdom—an institution which was originally established at Lisbon in 1291, was transferred to Coimbra in 1306, was again removed to Lisbon, and was finally fixed at Coimbra in 1527. There are five faculties—theology, law, medicine, mathematics and philosophy—with more than 1300 students. The library contains about 150,000 volumes, and the museums and laboratories are on an extensive scale. In connexion with the medical faculty there are regular hospitals; the mathematical faculty maintains an observatory from which an excellent view can be obtained of the whole valley of the Mondego; and outside the town there is a botanic garden (especially rich in the flora of Brazil), which also serves as a public promenade. Among the other educational establishments are a military college, a royal college of arts, a scientific and literary institute, and an episcopal seminary.

The city is the seat of a bishop, suffragan to the archbishop of Braga; its new cathedral, founded in 1580, is of little interest; but the old is a fine specimen of 12th-century Romanesque, and retains portions of the mosque which it replaced. The principal churches are Santa Cruz, of the 16th century, and San Salvador, founded in 1160. On the north bank of the Mondego stand the ruins of the once splendid monastery of Santa Clara, established in 1286; and on the south bank is the celebrated *Quinta das lagrimas*, or Villa of Tears, where Inez de Castro (*q.v.*) is believed to have been murdered in 1355. The town is supplied with water by means of an aqueduct of 20 arches. The Mondego is only navigable in flood, and the port of Figueira da Foz is 20 m. W. by S., so that the trade of Coimbra is mainly local; but there are important lamprey fisheries and manufactures of pottery, leather and hats.

A Latin inscription of the 4th century identifies Coimbra with the ancient Aeminium; while Condeixa (3623), 8 m. S.S.W., represents the ancient Conimbriga or Conembrica. In the 9th century, however, when the bishopric of Conimbriga was removed hither, its old title was transferred to the new see, and hence arose the modern name Coimbra. The city was for a long time a Moorish stronghold, but in 1064 it was captured by Ferdinand I. of Castile and the Cid. Until 1260 it was the capital of the country, and no fewer than six kings—Sancho I. and II., Alphonso II. and III., Pedro and Ferdinand—were born within its walls. It was also the birthplace of the poet Francisco Sá de Miranda (1495–1558), and, according to one tradition, of the more famous Luiz de Camoens (1524–1580), who was a student

at the university between 1537 and 1542. In 1755 Coimbra suffered considerably from the earthquake. In 1810 it was sacked by the French under Marshal Masséna. In 1834 Dom Miguel made the city his headquarters; and in 1846 it was the scene of a Miguelist insurrection.

The administrative district of Coimbra coincides with the south-western part of Beira; pop. (1900) 332,168; area 1508 sq. m.

COIN, a town of southern Spain in the province of Málaga; 18 m. W.S.W. of the city of Málaga. Pop. (1900) 12,326. Coin is finely situated on the northern slope of the Sierra de Mijas, overlooking the small river Séco and surrounded by vineyards and plantations of oranges and lemons. There are marble quarries in the neighbourhood, and, despite the lack of a railway, Coin has a thriving agricultural trade. The population increased by more than half between 1880 and 1900.

COIN (older forms of the word are *coyne*, *quoin* and *coign*, all derived through the O. Fr. *coing*, and *cuique* from Lat. *cuneus*, a wedge), properly the term for a wedge-shaped die used for stamping money, and so transferred to the money so stamped; hence a piece of money. The form "quoin" is used for the external angle of a building (see **QUOINS**), and "coign," also a projecting angle, survives in the Shakespearean phrase "a coign of vantage."

COINAGE OFFENCES. The coinage of money is in all states a prerogative of the sovereign power; consequently any infringement of that prerogative is always severely punished, as being an offence likely to interfere with the well-being of the state.

In the United Kingdom the statute law against offences relating to the coin was codified by an act of 1861. The statute provides that whoever falsely makes or counterfeits any coin resembling or apparently intended to resemble or pass for any current gold or silver coin of the realm (s. 2), or gilds, silvers, washes, cases over or colours with materials capable of producing the appearance of gold or silver a coin or a piece of any metal or mixture of metals, or files or alters it, with intent to make it resemble or pass for any current gold or silver coin (s. 3), or who buys, sells, receives or pays a false gold or silver coin at a lower rate than its denomination imports, or who receives into the United Kingdom any false coin knowing it to be counterfeit (ss. 6, 7), or who, without lawful authority or excuse, knowingly makes or mends, buys or sells, or has in his custody or possession, or conveys out of the Royal Mint any coining moulds, machines or tools, is guilty of felony (ss. 24, 25). The punishment for such offences is either penal servitude for life or for not less than three years, or imprisonment for not more than two years, with or without hard labour. Whoever impairs, diminishes or lightens current gold or silver coin, with intent to pass same, is liable to penal servitude for from three to fourteen years (s. 4), and whoever has in his possession filings or clippings obtained by impairing or lightening current coin is liable to the same punishment, or to penal servitude for from three to seven years. The statute also makes provision against tendering or uttering false gold or silver coin, which is a misdemeanour, punishable by imprisonment with or without hard labour. Provision is also made with respect to falsely making, counterfeiting, tendering or uttering copper coin, exporting false coin, or defacing current coin by stamping names or words on it, and counterfeiting, tendering or uttering coin resembling or meant to pass as that of some foreign state. The act of 1861 applies to offences with respect to colonial coins as well as to those of the United Kingdom.

By the constitution of the United States, Congress has the power of coining money, regulating the value thereof and of foreign coin (Art. i. s. viii.), and the states are prohibited from coining money, or making anything but gold and silver money a tender in payment of debts (Art. i. s. x.). The counterfeiting coin or money, uttering the same, or mutilating or defacing it, is an offence against the United States, and is punishable by fine and imprisonment with hard labour for from two to ten years. It has also been made punishable by state legislation.

COIR (from Malay *Kāyar*, cord, *Kāyaru*, to be twisted), a rough, strong, fibrous substance obtained from the outer husk of the coco-nut. (See COCO-NUT PALM.)

COIRE (Ger. *Chur* or *Cur*, Ital. *Coira*, Lat. *Curia Ractorum*, Romansch *Cuera*), the capital of the Swiss canton of the Grisons. It is built, at a height of 1949 ft. above the sea-level, on the right bank of the Plessur torrent, just as it issues from the Schanfigg valley, and about a mile above its junction with the Rhine. It is overshadowed by the Mittenberg (east) and Pizokel (south), hills that guard the entrance to the deep-cut Schanfigg valley. In 1900 it contained 11,532 inhabitants, of whom 9288 were German-speaking, 1466 Romansch-speaking, and 677 Italian-speaking; while 7561 were Protestants, 3962 Romanists and one a Jew. The modern part of the city is to the west, but the old portion, with all the historical buildings, is to the east. Here is the cathedral church of St Lucius (who is the patron of Coire, and is supposed to be a 2nd-century British king, though really the name has probably arisen from a confusion between Lucius of Cyrene—miswritten "*curiensis*"—with the Roman general Lucius Munatius Plancus, who conquered Raetia). Built between 1178 and 1282, on the site of an older church, it contains many curious medieval antiquities (especially in the sacristy), as well as a picture by Angelica Kaufmann, and the tomb of the great Grisons political leader (d. 1637) Jenatsch (*q.v.*). Opposite is the Bishop's Palace, and not far off is the Episcopal Seminary (built on the ruins of a 6th-century monastic foundation). Not far from these ancient monuments is the new Raetian Museum, which contains a great collection of objects relating to Raetia (including the geological collections of the Benedictine monk of Disentis, Placidus a Spescha (1752–1833), who explored the high snowy regions around the sources of the Rhine). One of the hospitals was founded by the famous Capuchin philanthropist, Father Theodosius Florentini (1808–1865), who was long the Romanist curé of Coire, and whose remains were in 1906 transferred from the cathedral here to Ingenbohl (near Schwyz), his chief foundation. Coire is 74 m. by rail from Zürich, and is the meeting-point of the routes from Italy over many Alpine passes (the Lukmanier, the Splügen, the San Bernardino) as well as from the Engadine (Albula, Julier), so that it is the centre of an active trade (particularly in wine from the Valtelline), though it possesses also a few local factories.

The episcopal see is first mentioned in 452, but probably existed a century earlier. The bishop soon acquired great temporal powers, especially after his dominions were made, in 831, dependent on the Empire alone, of which he became a prince in 1170. In 1392 he became head of the league of God's House (originally formed against him in 1367), one of the three Raetian leagues, but, in 1526, after the Reformation, lost his temporal powers, having fulfilled his historical mission (see GRISONS). The bishopric still exists, with jurisdiction over the Cantons of the Grisons, Glarus, Zürich, and the three Forest Cantons, as well as the Austrian principality of Liechtenstein. The gild constitution of the city of Chur lasted from 1465 to 1839, while in 1874 the *Burggemeinde* was replaced by an *Einwohnergemeinde*.

AUTHORITIES.—A. Eichhorn, *Episcopatus Curiensis* (St Blasien, 1797); W. von Juvalt, *Forschungen über die Feudalzeit im Cürischen Raetien*, 2 parts (Zürich, 1871); C. Kind, *Die Reformation in den Bisthümern Chur und Como* (Coire, 1858); Conradin von Moor, *Geschichte von Curraetien* (2 vols., Coire, 1870–1874); P. C. von Planta, *Das alte Raetien* (Berlin, 1872); *Idem*, *Die Curraetischen Herrschaften in der Feudalzeit* (Bern, 1881); *Idem*, *Verfassungsgeschichte der Stadt Cur im Mittelalter* (Coire, 1879); *Idem*, *Geschichte von Graubünden* (Bern, 1892). (W. A. B. C.)

COKE, SIR EDWARD (1552–1634), English lawyer, was born at Mileham, in Norfolk, on the 1st of February 1552. From the grammar school of Norwich he passed to Trinity College, Cambridge; and in 1572 he entered Lincoln's Inn. In 1578 he was called to the bar, and in the next year he was chosen reader at Lyon's Inn. His extensive and exact legal erudition, and the skill with which he argued the intricate libel case of Lord Cromwell (4 Rep. 13), and the celebrated real property case of Shelley (1 Rep. 94, 104), soon brought him a practice never before equalled, and caused him to be universally recognized as the

greatest lawyer of his day. In 1586 he was made recorder of Norwich, and in 1592 recorder of London, solicitor-general, and reader in the Inner Temple. In 1593 he was returned as member of parliament for his native county, and also chosen speaker of the House of Commons. In 1594 he was promoted to the office of attorney-general, despite the claims of Bacon, who was warmly supported by the earl of Essex. As crown lawyer his treatment of the accused was marked by more than the harshness and violence common in his time; and the fame of the victim has caused his behaviour in the trial of Raleigh to be lastingly remembered against him. While the prisoner defended himself with the calmest dignity and self-possession, Coke burst into the bitterest invective, brutally addressing the great courtier as if he had been a servant, in the phrase, long remembered for its insolence and its utter injustice—"Thou hast an English face, but a Spanish heart!"

In 1582 Coke married the daughter of John Paston, a gentleman of Suffolk, receiving with her a fortune of £30,000; but in six months he was left a widower. Shortly after he sought the hand of Lady Elizabeth Hatton, daughter of Thomas, second Lord Burghley, and granddaughter of the great Cecil. Bacon was again his rival, and again unsuccessfully; the wealthy young widow became—not, it is said, to his future comfort—Coke's second wife.

In 1606 Coke was made chief justice of the common pleas, but in 1613 he was removed to the office of chief justice of the king's bench, which gave him less opportunity of interfering with the court. The change, though it brought promotion in dignity, caused a diminution of income as well as of power; but Coke received some compensation in being appointed a member of the privy council. The independence of his conduct as a judge, though not unmixed with the baser elements of prejudice and vulgar love of authority, has partly earned forgiveness for the harshness which was so prominent in his sturdy character. Full of an extreme reverence for the common law which he knew so well, he defended it alike against the court of chancery, the ecclesiastical courts, and the royal prerogative. In a narrow spirit, and strongly influenced, no doubt, by his enmity to the chancellor, Thomas Egerton (Lord Brackley), he sought to prevent the interference of the court of chancery with even the unjust decisions of the other courts. In the case of an appeal from a sentence given in the king's bench, he advised the victorious, but guilty, party to bring an action of praemunire against all those who had been concerned in the appeal, and his authority was stretched to the utmost to obtain the verdict he desired. On the other hand, Coke has the credit of having repeatedly braved the anger of the king. He freely gave his opinion that the royal proclamation cannot make that an offence which was not an offence before. An equally famous but less satisfactory instance occurred during the trial of Edmund Peacham, a divine in whose study a sermon had been found containing libellous accusations against the king and the government. There was nothing to give colour to the charge of high treason with which he was charged, and the sermon had never been preached or published; yet Peacham was put to the torture, and Bacon was ordered to confer with the judges individually concerning the matter. Coke declared such conference to be illegal, and refused to give an opinion, except in writing, and even then he seems to have said nothing decided. But the most remarkable case of all occurred in the next year (1616). A trial was held before Coke in which one of the counsel denied the validity of a grant made by the king to the bishop of Lichfield of a benefice to be held *in commendam*. James, through Bacon, who was then attorney-general, commanded the chief justice to delay judgment till he himself should discuss the question with the judges. At Coke's request Bacon sent a letter containing the same command to each of the judges, and Coke then obtained their signatures to a paper declaring that the attorney-general's instructions were illegal, and that they were bound to proceed with the case. His Majesty expressed his displeasure, and summoned them before him in the council-chamber, where he insisted on his supreme prerogative, which,

he said, ought not to be discussed in ordinary argument. Upon this all the judges fell on their knees, seeking pardon for the form of their letter; but Coke ventured to declare his continued belief in the loyalty of its substance, and when asked if he would in the future delay a case at the king's order, the only reply he would vouchsafe was that he would do what became him as a judge. Soon after he was dismissed from all his offices on the following charges,—the concealment, as attorney-general, of a bond belonging to the king, a charge which could not be proved, illegal interference with the court of chancery and disrespect to the king in the case of commendams. He was also ordered by the council to revise his book of reports, which was said to contain many extravagant opinions (June 1616).

Coke did not suffer these losses with patience. He offered his daughter Frances, then little more than a child, in marriage to Sir John Villiers, brother of the favourite Buckingham. Her mother, supported at first by her husband's great rival and her own former suitor, Bacon, objected to the match, and placed her in concealment. But Coke discovered her hiding-place; and she was forced to wed the man whom she declared that of all others she abhorred. The result was the desertion of the husband and the fall of the wife. It is said, however, that after his daughter's public penance in the Savoy church, Coke had heart enough to receive her back to the home which he had forced her to leave. Almost all that he gained by his heartless diplomacy was a seat in the council and in the star-chamber.

In 1620 a new and more honourable career opened for him. He was elected member of parliament for Liskeard; and henceforth he was one of the most prominent of the constitutional party. It was he who proposed a remonstrance against the growth of popery and the marriage of Prince Charles to the infanta of Spain, and who led the Commons in the decisive step of entering on the journal of the House the famous petition of the 18th of December 1621, insisting on the freedom of parliamentary discussion, and the liberty of speech of every individual member. In consequence, together with Pym and Sir Robert Philips, he was thrown into confinement; and, when in the August of the next year he was released, he was commanded to remain in his house at Stoke Poges during his Majesty's pleasure. Of the first and second parliaments of Charles I. Coke was again a member. From the second he was excluded by being appointed sheriff of Buckinghamshire. In 1628 he was at once returned for both Buckinghamshire and Suffolk, and he took his seat for the former county. After rendering other valuable support to the popular cause, he took a most important part in drawing up the great Petition of Right. The last act of his public career was to bewail with tears the ruin which he declared the duke of Buckingham was bringing upon the country. At the close of the session he retired into private life; and the six years that remained to him were spent in revising and improving the works upon which, at least as much as upon his public career, his fame now rests. He died at Stoke Poges on the 3rd of September 1634.

Coke published *Institutes* (1628), of which the first is also known as *Coke upon Littleton*; *Reports* (1600–1615), in thirteen parts; *A Treatise of Bail and Mainprize* (1635); *The Complete Copyholder* (1630); *A Reading on Fines and Recoveries* (1684).

See Johnson, *Life of Sir Edward Coke* (1837); H. W. Woolrych, *The Life of Sir Edward Coke* (1826); Foss, *Lives of the Judges*; Campbell, *Lives of the Chief Justices*; also ENGLISH LAW.

COKE, SIR JOHN (1563–1644), English politician, was born on the 5th of March 1563, and was educated at Trinity College, Cambridge. After leaving the university he entered public life as a servant of William Cecil, Lord Burghley, afterwards becoming deputy-treasurer of the navy and then a commissioner of the navy, and being specially commended for his labours on behalf of naval administration. He became member of parliament for Warwick in 1621 and was knighted in 1624, afterwards representing the university of Cambridge. In the parliament of 1625 Coke acted as a secretary of state; in this and later parliaments he introduced the royal requests for money, and defended the foreign policy of Charles I. and Buckingham, and afterwards the actions of the king. His actual appointment as

secretary dates from September 1625. Disliked by the leaders of the popular party, his speeches in the House of Commons did not improve the king's position, but when Charles ruled without a parliament he found Coke's industry very useful to him. The secretary retained his post until 1639, when a scapegoat was required to expiate the humiliating treaty of Berwick with the Scots, and the scapegoat was Coke. Dismissed from office, he retired to his estate at Melbourne in Derbyshire, and then resided in London, dying at Tottenham on the 8th of September 1644. Coke's son, Sir John Coke, sided with the parliament in its struggle with the king, and it is possible that in later life Coke's own sympathies were with this party, although in his earlier years he had been a defender of absolute monarchy. Coke, who greatly disliked the papacy, is described by Clarendon as "a man of very narrow education and a narrower mind"; and again he says, "his cardinal perfection was industry and his most eminent infirmity covetousness."

COKE, THOMAS (1747–1814), English divine, the first Methodist bishop, was born at Brecon, where his father was a well-to-do apothecary. He was educated at Jesus College, Oxford, taking the degree of M.A. in 1770 and that of D.C.L. in 1775. From 1772 to 1776 he was curate at South Petherton in Somerset, whence his rector dismissed him for adopting the open-air and cottage services introduced by John Wesley, with whom he had become acquainted. After serving on the London Wesleyan circuit he was in 1782 appointed president of the conference in Ireland, a position which he frequently held, in the intervals of his many voyages to America. He first visited that country in 1784, going to Baltimore as "superintendent" of the Methodist societies in the new world and, in 1787 the American conference changed his title, to "bishop," a nomenclature which he tried in vain to introduce into the English conference, of which he was president in 1797 and 1805. Failing this, he asked Lord Liverpool to make him a bishop in India, and he was voyaging to Ceylon when he died on the 3rd of May 1814. Coke had always been a missionary enthusiast, and was the pioneer of such enterprise in his connexion. He was an ardent opponent of slavery, and endeavoured also to heal the breach between the Methodist and Anglican communions. He published a *History of the West Indies* (3 vols., 1808–1811), several volumes of sermons, and, with Henry Moore, a *Life of Wesley* (1792).

COKE (a northern English word, possibly connected with "colk," core), the product obtained by strongly heating coal out of contact with the air until the volatile constituents are driven off; it consists essentially of carbon, the so-called "fixed carbon," together with the incombustible matters or ash contained in the coal from which it is derived. In addition to these it almost invariably contains small quantities of hydrogen, oxygen and nitrogen, the whole, however, not exceeding 2 or 3%. It also contains water, the amount of which may vary considerably according to the method of manufacture. When produced rapidly and at a low heat, as in gas-making, it is of a dull black colour, and a loose spongy or pumice-like texture, and ignites with comparative ease, though less readily than bituminous coal, so that it may be burnt in open fire-places; but when a long-continued heat is used, as in the preparation of coke for iron and steel melting, the product is hard and dense, is often prismatic in structure, has a brilliant semi-metallic lustre and silvery-grey colour, is a conductor of heat and electricity, and can only be burnt in furnaces provided with a strong chimney draught or an artificial blast. The strength and cohesive properties are also intimately related to the nature and composition of the coals employed, which are said to be caking or non-caking according to the compact or fragmentary character of the coke produced.

Formerly coke was made from large coal piled in heaps with central chimneys like those of the charcoal burner, or in open rectangular clamps or kilns with air flues in the enclosing walls; but these methods are now practically obsolete, closed chambers or ovens being generally used. These vary considerably in construction, but may be classified into three principal types:—(1) direct heated ovens, (2) flue-heated ovens, (3) condensing

ovens. In the first class the heating is done by direct contact or by burning the gases given off in coking within the oven, while in the other two the heating is indirect, the gas being burned in cellular passages or flues provided in the walls dividing the coking chambers, and the heat transmitted through the sides of the latter which are comparatively thin. The arrangement is somewhat similar to that of a gas-works retort, whence the name of "retort ovens" is sometimes applied to them. The difference between the second and third classes is founded on the treatment of the gases. In the former the gas is fired in the side flues immediately upon issuing from the oven, while in the latter the gases are first subjected to a systematic treatment in condensers, similar to those used in gas-works, to remove tar, ammonia and condensable hydrocarbons, the incondensable gases being returned to the oven and burned in the heating flues. These are generally known as "by-product ovens."

The simplest form of coke oven, and probably that still most largely used, is the so-called "beehive oven." This is circular in plan, from 7 to 12 ft. in diameter, with a cylindrical wall about 2½ ft. high and a nearly hemispherical roof with a circular hole at the top. The floor, made of refractory bricks or slabs, is laid with a slight slope towards an arched opening in the ring wall, which is stopped with brickwork during the coking but opened for drawing the finished charge. The ovens are usually arranged in rows or banks of 20 to 30 or more, with their doors outwards, two rows being often placed with a longitudinal flue between them connected by uptakes with the individual ovens on either side. A railway along the top of the bank brings the coal from the screens or washery. The largest ovens take a charge of about 5 tons, which is introduced through the hole in the roof, the brickwork of the empty oven being still red hot from the preceding charge, and when levelled fills the cylindrical part nearly to the springing of the roof. The gas fires as it is given off and fills the dome with flame, and the burning is regulated by air admitted through holes in the upper part of the door stopping. The temperature being very high, a proportion of the volatile hydrocarbons is decomposed, and a film of graphitic carbon is deposited on the coke, giving it a semi-metallic lustre and silvery grey colour. When the gas is burned off, the upper part of the door is opened and the glowing charge cooled by jets of water thrown directly upon it from a hose, and it is subsequently drawn out through the open door. The charge breaks up into prisms or columns whose length corresponds to the depth of the charge, and as a rule is uniform in character and free from dull black patches or "black ends." The time of burning is either 48 or 72 hours, the turns being so arranged as to avoid the necessity of drawing the ovens on Sunday. The longer the heat is continued the denser the product becomes, but the yield also diminishes, as a portion of the finished coke necessarily burns to waste when the gas is exhausted. For this reason the yield on the coal charged is usually less than that obtained in retort ovens, although the quality may be better. Coals containing at most about 35% of volatile matter are best suited for the beehive oven. With less than 25% the gas is not sufficient to effect the coking completely, and when there is a higher percentage the coke is brittle and spongy and unsuited for blast furnace or foundry use. The spent flame from the ovens passes to a range of steam boilers before escaping by the chimney.

The retort oven, which is now generally displacing the beehive form in new installations, is made in a great variety of forms, the differences being mainly in the arrangement of the heating flues, but all have the central feature, the coking chamber, in common. This is a tubular chamber with vertical sides and cylindrical roof, about 30 ft. long, from 17 to 20 in. wide, and 6 or 7 ft. high, and closed at both ends by sliding doors which are raised by crab winches when the charge is to be drawn. The general arrangements of such an oven are shown in fig. 1, which represents one of the earliest and most popular forms, that of Evence Coppée of Brussels. The coking chambers A B connect by rectangular posts at the springing of the roof, where the gas given off from the top of the charge is fired by air introduced through *c c*. The flames pass downwards through the parallel flues *f f* along the bottom flue of one oven, and return in the opposite direction under the next to the chimney flue, a further part of the heat being intercepted by placing a range of steam boilers between the ovens and the chimney stack. The charging of the oven is done through the passages *D D* in the roof from small wagons on transverse lines of rails, the surface being raked level before the doors are closed and luted up. The time of coking is much less than in the beehive ovens and may be from 24 to 36 hours, according to the proportion of volatile matter present. When the gas is completely given off the doors are lifted and the charge is pushed out by the ram—a cast-iron plate of the shape of the cross section of the oven, at the end of a long horizontal bar, which is driven by a rack and pinion movement and pushes the block of coke out of the oven on to the wharf or bank in front where it falls to pieces and is immediately

quenched by jets of water from a hose pipe. When sufficiently cooled it is loaded into railway wagons or other conveyances for removal. The ram, together with its motor, and boiler when steam is used, is mounted upon a carriage running upon a line of rails of about 2 ft. gauge along the back of the range of ovens, so that it can be brought up to any one of them in succession.

In some cases, instead of the small coal being charged through the roof of the oven and levelled by hand, it is formed into blocks by

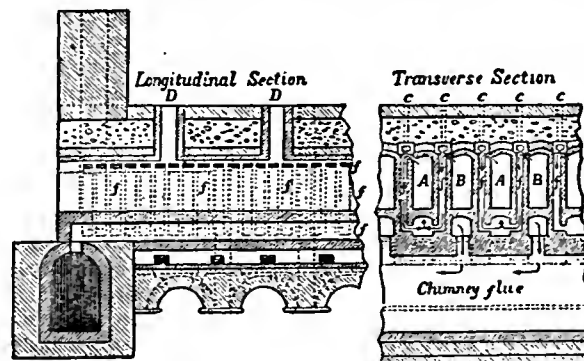

FIG. 1.—Coppée's Coke Oven.

being stamped in a slightly moistened condition in a mould consisting of a bottom plate or peel on a raked rod like that of the ram, with movable sides and ends. This, when the ends are removed, is pushed forward into the oven, and the bottom plate is withdrawn by reversing the rack motion. The moulding box is mounted on a carriage like that of the ram, the two being sometimes carried on the same framing. The moulding is done at a fixed station in the centre of the range of ovens by a series of cast-iron stampers driven by an electric motor. This system is useful for coals low in volatile matter, which do not give a coherent coke under ordinary conditions.

In the distilling or by-product ovens the gases, instead of being burned at the point of origin, pass by an uptake pipe in the roof about the centre of the oven into a water-sealed collecting trough or hydraulic main, whence they are drawn by exhausters through a series of air and water cooled condensers and scrubbers. In the first or atmospheric condensers the tar is removed, and in the second ammoniacal water, which is further enriched by a graduated system of scrubbing with weak ammoniacal liquor until it is sufficiently concentrated to be sent to the ammonia stills. The first treatment by scrubbing with creosote or heavy tar oil removes benzene, after which the permanent gaseous residue consisting chiefly of hydrogen and marsh gas is returned to the ovens as fuel.

In the Otto-Hoffmann oven, one of the most generally used forms, vertical side flues like those of Coppée are adopted. The returned gas enters by a horizontal flue along the bottom of the coking chamber, divided into two parts by a mid-feather wall, and is fired by heated air from a Siemens regenerator on the substructure at one end, and the flame rising through one half of the side flues to a parallel collector at the top returns downwards through the flues of the other half and passes out to the chimney through a similar regenerator at the other end. The course of the gases is reversed at intervals of about an hour, as in the ordinary Siemens furnace, each end of the oven having its own gas supply. In the later modification known as the Otto-Hilgenstock, the regenerators are abandoned, but provision is made for more perfect distribution of the heat by a line of sixteen Bunsen burners in each wall; each of these serves two flues, the course of the flame being continuously upwards without reversal. In the newest Otto ovens the same system of burners is combined with regenerators. In the Bauer system, another vertical flue oven, each flue has its own burner, which is of a simplified construction.

In the Carvés oven, the earliest of the by-product ovens, the heating flues are arranged horizontally in parallel series along the entire length of the side walls, the gas being introduced from both ends but at different levels. This system was further developed by H. Simon of Manchester, who added a continuous air "recuperator" heated by the spent flame; this Simon-Carvés system has been extensively adopted in Great Britain. Another horizontal flue oven, the Semet-Solvay, is distinguished by the structure of the flues, which are independent of the dividing walls of the ovens, so that the latter can be made with thinner sides than those of the earlier systems, and are more readily repaired. In the horizontal ovens it is sometimes difficult to maintain the heat when the flues are continuous along the whole length of the wall, especially when the heating value of the gas is reduced by the removal of the heavy hydrocarbons. This difficulty is met by dividing the flues in the middle so as to shorten the length of travel of the flame, and working each end independently. The Hüssener and Koppers systems are two of the best-known examples of this modification.

Coke from retort ovens is not so dense or brilliant as that made

in beehive ovens, but the waste being less there is a decided saving, apart from the value of the condensed products. In one instance the coke was found to be about 5% less efficient in the blast furnace, while the yield on the coal charged was increased 10%. In the further treatment of the condensed products by distillation the tar gives burning oil and pitch, the benzene is separated from the creosote oil by steam-heated stills, and the ammoniacal liquor, after some lime has been added to decompose fixed ammonium compounds, is heated to vaporize the ammonia, which is condensed in lead or copper-lined tanks containing strong sulphuric acid to produce a crystalline powder of ammonium sulphate, which accumulates in the receiver and is fished out from time to time. The yield of by-products averages about 1% of ammonium sulphate, about 3½% of tar, and 0.6 to 0.9% of benzene, of the weight of the coal carbonized. After the ovens have been heated and steam supplied for the machinery of the condensing plant and the coke ovens, there is usually a surplus of gas, which may be used for lighting or driving gas-engines. For the latter purpose, however, it is necessary to remove the last traces of tar, which acts very prejudicially in fouling the valves when the gas is not completely purified. The gas given off during the earlier part of the coking process is richer in heavy hydrocarbons and of a higher illuminating value than that of the later period when the temperature is higher. This property is utilized in several large coking plants in America, where the gas from the first ten hours' working is drawn off by a second hydraulic main and sent directly to town gas-works, where it passes through the ordinary purifying treatment, the gas from the second period being alone used for heating the ovens.

Coke is essentially a partially graphitized carbon, its density being about midway between that of coal and graphite, and it should therefore occupy less space than the original coal; but owing to the softening of the charge a spongy structure is set up by the escaping gases, which acts in the other direction, so that for equal bulk coke is somewhat lighter than coal. It is this combination of properties that gives it its chief value in iron smelting, the substance being sufficiently dense to resist oxidation by carbon dioxide in the higher regions of the furnace, while the vesicular structure gives an extended surface for the action of heated air and facilitates rapid consumption at the tuyeres. Compact coke, such as that formed on the inner sides of gas retorts (retort carbon), can only be burned with great difficulty in small furnaces of special construction, but it gives out a great amount of heat.

The most deleterious constituents of coke are ash, sulphur and volatile constituents including water. As the coke yield is only from two-thirds to three-quarters of that of the coal, the original proportion of ash is augmented by one-third or one-half in the product. For this reason it is now customary to crush and wash the coal carefully to remove intermingled patches of shale and dirt before coking, so that the ash may not if possible exceed 10% in the coke. About one-half of the sulphur in the coal is eliminated in coking, so that the percentage in the coke is about the same. It should not be much above 1%. According to the researches of F. Wuest (*Journ. Iron and Steel Inst.*, 1906) the sulphur is retained in a complex carbon compound which is not destroyed until the coke is actually consumed.

The older methods of coking and the earlier forms of retort ovens are described in J. Percy, *Metallurgy*, Jordan, *Album du cours de métallurgie*; Phillips and Bauerman, *Handbook of Metallurgy*, and other text-books. A systematic series of articles on the newer forms will be found in *The Engineer*, vol. 82, pp. 205-303 and vol. 83, pp. 207-231; see also Dürre, *Die neuern Koksöfen* (Leipzig, 1892); D. A. Louis, "Von Bauer and Brünck Ovens," *Journ. Iron and Steel Inst.*, 1904, ii. p. 293; C. L. Bell, "Hüssener Oven," *id.*, 1904, i. p. 188; Hurez, "A Comparison of Different Systems of Vertical and Horizontal Flue Ovens," *Bull. soc. industrie minérale*, 1903, p. 777. A well-illustrated description of the Otto system in its American modification was issued by the United Gas & Coke Company of New York, in 1906. (H. B.)

COL (Fr. for "neck," Lat. *collum*), in physical geography, generally any marked depression upon a high and rugged water-parting over which passage is easy from one valley to another. Such is the Col de Balme between the Trient and Chamounix valleys, where the great inaccessible wall crowned with aiguilles running to the massif of Mt. Blanc is broken by a gentle downward curve with smooth upland slopes, over which a footpath gives easy passage. The col is usually formed by the head-waters of a stream eating backward and lowering the water-parting at the head of its valley. In early military operations, the march of an army was always over a col, which has at all times con-

siderable commercial importance in relation to roads in high mountain regions.

COLBERT, JEAN BAPTISTE (1619-1683), French statesman, was born at Reims, where his father and grandfather were merchants. He claimed to be the descendant of a noble Scottish family, but the evidence for this is lacking. His youth is said to have been spent in a Jesuit college, in the office of a Parisian banker, and in that of a Parisian notary, Chapelain, the father of the poet. But the first fact on which we can rely with confidence is that, when not yet twenty, he obtained a post in the war-office, by means of the influence that he possessed through the marriage of one of his uncles to the sister of Michel Le Tellier, the secretary of state for war. During some years he was employed in the inspection of troops and other work of the kind, but at length his ability, his extraordinary energy and his untiring laboriousness induced Le Tellier to make him his private secretary. These qualities, combined, it must be confessed, with a readiness to seize every opportunity of advancement, soon brought Colbert both wealth and influence. In 1647 we find him receiving the confiscated goods of his uncle Pussort, in 1648 obtaining 40,000 crowns with his wife Marie Charron, in 1649 appointed councillor of state.

It was the period of the wars of the Fronde; and in 1651 the triumph of the Condé family drove Cardinal Mazarin from Paris. Colbert, now aged thirty-two, was engaged to keep him acquainted with what should happen in the capital during his absence. At first Colbert's position was far from satisfactory; for the close wary Italian treated him merely as an ordinary agent. On one occasion, for example, he offered him 1000 crowns. The gift was refused somewhat indignantly; and by giving proof of the immense value of his services, Colbert gained all that he desired. His demands were not small; for, with an ambition mingled, as his letters show, with strong family affection, he aimed at placing all his relatives in positions of affluence and dignity; and many a rich benefice and important public office was appropriated by him to that purpose. For these favours, conferred upon him by his patron with no stinted hand, his thanks were expressed in a most remarkable manner; he published a letter defending the cardinal from the charge of ingratitude which was often brought against him, by enumerating the benefits that he and his family had received from him (April 1653). Colbert obtained, besides, the higher object of his ambition; the confidence of Mazarin, so far as it was granted to any one, became his, and he was entrusted with matters of the gravest importance. In 1659 he was giving directions as to the suppression of the revolt of the gentry which threatened in Normandy, Anjou and Poitou, with characteristic decision arresting those whom he suspected and arranging every detail of their trial, the immediate and arbitrary destruction of their castles and woods, and the execution of their chief, Bonnesson. In the same year we have evidence that he was already planning his great attempt at financial reform. His earliest tentative was the drawing up of a *mémoire* to Mazarin, showing that of the taxes paid by the people not one-half reached the king. The paper also contained an attack upon the superintendent Nicholas Fouquet (*q.v.*), and being opened by the postmaster of Paris, who happened to be a spy of Fouquet's, it gave rise to a bitter quarrel, which, however, Mazarin repressed during his lifetime.

In 1661 the death of Mazarin allowed Colbert to take the first place in the administration, and he made sure of the king's favour by revealing to him some of Mazarin's hidden wealth. It was some time before he assumed official dignities; but in January 1664 he obtained the post of superintendent of buildings; in 1665 he was made controller-general; in 1669 he became minister of the marine; and he was also appointed minister of commerce, the colonies and the king's palace. In short, he soon acquired power in every department except that of war.

A great financial and fiscal reform at once claimed all his energies. Not only the nobility, but many others who had no legal claim to exemption, paid no taxes; the weight of the burden fell on the wretched country-folk. Colbert sternly and fearlessly set about his task. Supported by the young king, Louis XIV..

he aimed the first blow at the greatest of the extortioners—the bold and powerful superintendent, Fouquet; whose fall, in addition, secured his own advancement.

The office of superintendent and many others dependent upon it being abolished the supreme control of the finances was vested in a royal council. The sovereign was its president; but Colbert, though for four years he only possessed the title of intendant, was its ruling spirit, great personal authority being conferred upon him by the king. The career on which Colbert now entered must not be judged without constant remembrance of the utter rottenness of the previous financial administration. His ruthlessness in this case, dangerous precedent as it was, was perhaps necessary; individual interests could not be respected. Guilty officials having been severely punished, the fraudulent creditors of the government remained to be dealt with. Colbert's method was simple. Some of the public loans were totally repudiated, and from others a percentage was cut off, which varied, at first according to his own decision, and afterwards according to that of the council which he established to examine all claims against the state.

Much more serious difficulties met his attempts to introduce equality in the pressure of the taxes on the various classes. To diminish the number of the privileged was impossible, but false claims to exemption were firmly resisted, and the unjust direct taxation was lightened by an increase of the indirect taxes, from which the privileged could not escape. The mode of collection was at the same time immensely improved.

Order and economy being thus introduced into the working of the government, the country, according to Colbert's vast yet detailed plan, was to be enriched by commerce. Manufactures were fostered in every way he could devise. New industries were established, inventors protected, workmen invited from foreign countries, French workmen absolutely prohibited to emigrate. To maintain the character of French goods in foreign markets, as well as to afford a guarantee to the home consumer, the quality and measure of each article were fixed by law, breach of the regulations being punished by public exposure of the delinquent and destruction of the goods, and, on the third offence, by the pillory. But whatever advantage resulted from this rule was more than compensated by the disadvantages it entailed. The production of qualities which would have suited many purposes of consumption was prohibited, and the odious supervision which became necessary involved great waste of time and a stereotyped regularity which resisted all improvements. And other parts of Colbert's schemes deserve still less equivocal condemnation. By his firm maintenance of the corporation system, each industry remained in the hands of certain privileged bourgeois; in this way, too, improvement was greatly discouraged; while to the lower classes opportunities of advancement were closed. With regard to international commerce Colbert was equally unfortunate in not being in advance of his age; the tariffs he published were protective to an extreme. The interests of internal commerce were, however, wisely consulted. Unable to abolish the duties on the passage of goods from province to province, he did what he could to induce the provinces to equalize them. The roads and canals were improved. The great canal of Languedoc was planned and constructed by Pierre Paul Riquet (1604–1680) under his patronage. To encourage trade with the Levant, Senegal, Guinea and other places, privileges were granted to companies; but, like the more important East India Company, all were unsuccessful. The chief cause of this failure, as well as of the failure of the colonies, on which he bestowed so much watchful care, was the narrowness and rigidity of the government regulations.

The greatest and most lasting of Colbert's achievements was the establishment of the French marine. The royal navy owed all to him, for the king thought only of military exploits. For its use, Colbert reconstructed the works and arsenal of Toulon, founded the port and arsenal of Rochefort, and the naval schools of Rochefort, Dieppe and Saint-Malo, and fortified, with some assistance from Vauban (who, however, belonged to the party of his rival Louvois), among other ports those of Calais, Dunkirk,

Brest and Havre. To supply it with recruits he invented his famous system of classes, by which each seaman, according to the class in which he was placed, gave six months' service every three or four or five years. For three months after his term of service he was to receive half-pay; pensions were promised; and, in short, everything was done to make the navy popular. There was one department, however, that was supplied with men on a very different principle. Letters exist written by Colbert to the judges requiring them to sentence to the oar as many criminals as possible, including all those who had been condemned to death; and the convict once chained to the bench, the expiration of his sentence was seldom allowed to bring him release. Mendicants also, against whom no crime had been proved, contraband dealers, those who had been engaged in insurrections, and others immeasurably superior to the criminal class, nay, innocent men—Turkish, Russian and negro slaves, and poor Iroquois Indians, whom the Canadians were ordered to entrap—were pressed into that terrible service. By these means the benches of the galleys were filled, and Colbert took no thought of the long unrelieved agony borne by those who filled them.

Nor was the mercantile marine forgotten. Encouragement was given to the building of ships in France by allowing a premium on those built at home, and imposing a duty on those brought from abroad; and as French workmen were forbidden to emigrate, so French seamen were forbidden to serve foreigners on pain of death.

Even ecclesiastical affairs, though with these he had no official concern, did not altogether escape Colbert's attention. He took a subordinate part in the struggle between the king and Rome as to the royal rights over vacant bishoprics; and he seems to have sympathized with the proposal that was made to seize part of the wealth of the clergy. In his hatred of idleness, he ventured to suppress no less than seventeen fêtes, and he had a project for lessening the number of those devoted to clerical and monastic life, by fixing the age for taking the vows some years later than was then customary. With heresy he was at first unwilling to interfere, for he was aware of the commercial value of the Huguenots; but when the king resolved to make all France Roman Catholic, he followed him and urged his subordinates to do all that they could to promote conversions.

In art and literature Colbert took much interest. He possessed a remarkably fine private library, which he delighted to fill with valuable manuscripts from every part of Europe where France had placed a consul. He has the honour of having founded the Academy of Sciences (now called the Institut de France), the Observatory, which he employed Claude Perrault to build and brought G. D. Cassini (1625–1712) from Italy to superintend, the Academies of Inscriptions and Medals, of Architecture and of Music, the French Academy at Rome, and Academies at Arles, Soissons, Nîmes and many other towns, and he reorganized the Academy of Painting and Sculpture which Richelieu had established. He was a member of the French Academy; and one very characteristic rule, recorded to have been proposed by him with the intention of expediting the great Dictionary, in which he was much interested, was that no one should be accounted present at any meeting unless he arrived before the hour of commencement and remained till the hour for leaving. In 1673 he presided over the first exhibition of the works of living painters; and he enriched the Louvre with hundreds of pictures and statues. He gave many pensions to men of letters, among whom we find Molière, Corneille, Racine, Boileau, P. D. Huet (1630–1721) and Antoine Varillas (1626–1696), and even foreigners, as Huyghens, Vossius the geographer, Carlo Dati the Dellacruscan, and Heinsius the great Dutch scholar. There is evidence to show that by this munificence he hoped to draw out praises of his sovereign and himself; but this motive certainly is far from accounting for all the splendid, if in some cases specious, services that he rendered to literature, science and art.

Indeed to everything that concerned the interests of France Colbert devoted unsparing thought and toil. Besides all that

has been mentioned, he found time to do something for the better administration of justice (the codification of ordinances, the diminishing of the number of judges, the reduction of the expense and length of trials for the establishment of a superior system of police) and even for the improvement of the breed of horses and the increase of cattle. As superintendent of public buildings he enriched Paris with boulevards, quays and triumphal arches; he relaid the foundation-stone of the Louvre, and brought Bernin from Rome to be its architect; and he erected its splendid colonnade upon the plan of Claude Perrault, by whom Bernin had been replaced. He was not permitted, however, to complete the work, being compelled to yield to the king's preference for residences outside Paris, and to devote himself to Marly and Versailles.

Amid all these public labours his private fortune was never neglected. While he was reforming the finances of the nation, and organizing its navy, he always found time to direct the management of his smallest farm. He died extremely rich, and left fine estates all over France. He had been created marquis de Seignelay, and for his eldest son he obtained the reversion of the office of minister of marine; his second son became archbishop of Rouen; and a third son, the marquis d'Ormoy, became superintendent of buildings.

To carry out his reforms, Colbert needed peace; but the war department was in the hands of his great rival Louvois, whose influence gradually supplanted that of Colbert with the king. Louis decided on a policy of conquest. He was deaf also to all the appeals against the other forms of his boundless extravagance which Colbert, with all his deference towards his sovereign, bravely ventured to make.¹ Thus it came about that, only a few years after he had commenced to free the country from the weight of the loans and taxes which crushed her to the dust, Colbert was forced to heap upon her a new load of loans and taxes more heavy than the last. Henceforth his life was a hopeless struggle, and the financial and fiscal reform which, with the great exception of the establishment of the navy, was the most valuable service to France contemplated by him, came to nought.

Depressed by his failure, deeply wounded by the king's favour for Louvois, and worn out by overwork, Colbert's strength gave way at a comparatively early age. In 1680 he was the constant victim of severe fevers, from which he recovered for a time through the use of quinine prescribed by an English physician. But in 1683, at the age of sixty-four, he was seized with a fatal illness, and on the 6th of September he expired. It was said that he died of a broken heart, and a conversation with the king is reported in which Louis disparagingly compared the buildings of Versailles, which Colbert was superintending, with the works constructed by Louvois in Flanders. He took to bed, it is true, immediately afterwards, refusing to receive all messages from the king; but his constitution was utterly broken before, and a post-mortem examination proved that he had been suffering from stone. His body was interred in the secrecy of night, for fear of outrage from the Parisians, by whom his name was cordially detested.

Colbert was a great statesman, who did much for France. Yet his insight into political science was not deeper than that of his age; nor did he possess any superiority in moral qualities. His rule was a very bad example of over-government. He did not believe in popular liberty; the parlements and the states-general received no support from him. The technicalities of justice he never allowed to interfere with his plans; but he did not hesitate to shield his friends. He trafficked in public offices for the profit of Mazarin and in his own behalf. He caused the suffering of thousands in the galleys; he had no ear, it is said, for the cry of the suppliant. There was indeed a more human side to his character, as is shown in his letters, full of wise advice and affectionate care, to his children, his brothers, his cousins even. Yet to all outside he was "the man of marble." Madame de Sévigné called him "the North." To diplomacy he never pretended; persuasion and deceit were not the weapons he

¹ See especially a *Mémoire* presented to the king in 1666, published in the *Lettres, &c., de Colbert*, vol. ii.

employed; all his work was carried out by the iron hand of authority. He was a great statesman in that he conceived a magnificent yet practicable scheme for making France first among nations, and in that he possessed a matchless faculty for work, neither shrinking from the vastest undertakings nor scorning the most trivial details.

Numerous *vies* and *éloges* of Colbert have been published; but the most thorough student of his life and administration was Pierre Clément, member of the Institute, who in 1846 published his *Vie de Colbert*, and in 1861 the first of the 9 vols. of the *Lettres, instructions, et mémoires de Colbert*. The historical introductions prefixed to each of these volumes have been published by Mme. Clément under the title of the *Histoire de Colbert et de son administration* (3rd ed., 1892). The best short account of Colbert as a statesman is that in Lavisse, *Histoire de France* (1905), which gives a thorough study of the administration. Among Colbert's papers are *Mémoires sur les affaires de finance de France* (written about 1663), a fragment entitled *Particularités secrètes de la vie du Roy*, and other accounts of the earlier part of the reign of Louis XIV. (J. T. S.)

COLBERT DE CROISSY, CHARLES, MARQUIS (1625–1696), French diplomatist, like his elder brother Jean Baptiste Colbert, began his career in the office of the minister of war Le Tellier. In 1656 he bought a counsellorship at the parlement of Metz, and in 1658 was appointed intendant of Alsace and president of the newly-created sovereign council of Alsace. In this position he had to re-organize the territory recently annexed to France. The steady support of his brother at court gained for him several diplomatic missions—to Germany and Italy (1659–1661). In 1662 he became marquis de Croissy and *président à mortier* of the parlement of Metz. After various intendantships, at Soissons (1665), at Amiens (1666), and at Paris (1667), he turned definitely to diplomacy. In 1668 he represented France at the conference of Aix-la-Chapelle; and in August of the same year was sent as ambassador to London, where he was to negotiate the definite treaty of alliance with Charles II. He arranged the interview at Dover between Charles and his sister Henrietta of Orleans, gained the king's personal favour by finding a mistress for him, Louise de Kéroualle, maid of honour to Madame, and persuaded him to declare war against Holland. The negotiation of the treaty of Nijmegen (1676–1678) still further increased his reputation as a diplomatist and Louis XIV. made him secretary of state for foreign affairs after the disgrace of Arnauld de Pomponne, brought about by his brother, 1679. He at once assumed the entire direction of French diplomacy. Foreign ambassadors were no longer received and diplomatic instructions were no longer given by other secretaries of state. It was he, not Louvois, who formed the idea of annexation during a time of peace, by means of the chambers of reunion. He had outlined this plan as early as 1658 with regard to Alsace. His policy at first was to retain the territory annexed by the chambers of reunion without declaring war, and for this purpose he signed treaties of alliance with the elector of Brandenburg (1681), and with Denmark (1683); but the troubles following upon the revocation of the edict of Nantes (1685) forced him to give up his scheme and to prepare for war with Germany (1688). The negotiations for peace had been begun again when he died, on the 28th of July 1696. His clerk, Bergcret, was his invaluable assistant.

BIBLIOGRAPHY.—His papers, preserved in the *Archives des affaires étrangères* at Paris, have been partially published in the *Recueil des instructions données aux ambassadeurs et ministres de France* (since 1884). See especially the volumes:—*Autriche* (t. i.), *Suède* (t. ii.), *Rome* (t. vi.), *Bavière* (t. viii.), *Savoie* (t. xiv.), *Prusse* (t. xvi.). Other documents have been published in Mignet's *Négociations relatives à la succession d'Espagne*, vol. iv., and in the collection of *Lettres et négociations . . . pour la paix de Nimègue, 1676–1677* (La Haye, 1710). In addition to the *Mémoires* of the time, see Spanheim, *Relation de la cour de France en 1690*, ed. E. Bourgeois (Paris and Lyons, 1900); Baschet, *Histoire du dépôt des affaires étrangères*; C. Rousset, *Histoire de Louvois* (4 vols., Paris, 1863); E. Bourgeois, "Louvois, et Colbert de Croissy," in the *Revue historique*, vol. xxxiv. (1887); A. Waddington, *Le Grand Électeur et Louis XIV* (Paris, 1905); G. Pagis, *Le Grand Électeur et Louis XIV* (Paris, 1905).

COLBURN, HENRY (d. 1855), British publisher, obtained his earliest experience of bookselling in London at the establishment of W. Earle, Albemarle Street, and afterwards as an assistant at Morgan's Library, Conduit Street, of which in 1816 he became

proprietor. He afterwards removed to New Burlington Street, where he established himself as a publisher, resigning the Conduit Street Library to Messrs Saunders & Otley. In 1814 he originated the *New Monthly Magazine*, of which at various times Thomas Campbell, Bulwer Lytton, Theodore Hook and Harrison Ainsworth were editors. Colburn published in 1818 *Evelyn's Diary*, and in 1825 the *Diary of Pepys*, edited by Lord Braybrooke, paying £2200 for the copyright. He also issued Disraeli's first novel, *Vivian Grey*, and a large number of other works by Theodore Hook, G. P. R. James, Marryat and Bulwer Lytton. In 1829 Richard Bentley (*q.v.*) was taken into partnership; and in 1832 Colburn retired, but set up again soon afterwards independently in Great Marlborough Street; his business was taken over in 1841 by Messrs Hurst & Blackett. Henry Colburn died on the 16th of August 1855, leaving property to the value of £35,000.

COLBURN, ZERAH (1804-1840), American mathematical prodigy, was born at Cabot, Vermont, on the 1st of September 1804. At a very early age he developed remarkable powers of calculating with extreme rapidity, and in 1810 his father began to exhibit him. As a performing prodigy he visited Great Britain and France. From 1816 to 1819 he studied in Westminster school, London. After the death of his father in 1824 he returned to America, and from 1825 to 1834 he was a Methodist preacher. As he grew older his extraordinary calculating powers diminished. From 1835 until his death, on the 2nd of March 1840, he was professor of languages at the Norwich University in Vermont. He published a *Memoir* of his life in 1833.

His nephew, also named **ZERAH COLBURN** (1832-1870), was a well-known mechanical engineer; the editor successively of the *Railroad Advocate*, in New York, *The Engineer*, in London, and *Engineering*, in London; and the author of a work entitled *The Locomotive Engine* (1851).

COLBY, THOMAS FREDERICK (1784-1852), British major-general and director of ordnance survey, was born at St Margaret's, Rochester, on the 1st of September 1784, a member of a South Wales family. Entering the Royal Engineers he began in 1802 a life-long connexion with the Ordnance Survey department. His most important work was the survey of Ireland. This he planned in 1824, and was engaged upon it until 1846. The last sheets of this survey were almost ready for issue in that year when he reached the rank of major-general, and according to the rules of the service had to vacate his survey appointment. He was the inventor of the compensation bar, an apparatus used in base-measurements. He died at New Brighton on the 9th of October 1852.

COLCHAGUA, a province of central Chile, bounded N. by Santiago and O'Higgins, E. by Argentina, S. by Curicó, and W. by the Pacific. Its area is officially estimated at 3856 sq. m.; pop. (1895) 157,566. Extending across the great central valley of Chile, the province has a considerable area devoted to agriculture, but much attention is given to cattle and mining. Its principal river is the Rapel, sometimes considered as the southern limit of the Inca empire. Its greatest tributary is the Cachapoal, in the valley of which, among the Andean foothills, are the popular thermal mineral baths of Cauquenes, 2306 ft. above sea-level. The state central railway from Santiago to Puerto Montt crosses the province and has two branches within its borders, one from Rengo to Peumo, and one from San Fernando via Palmilla to Pichilemu on the coast. The principal towns are the capital, San Fernando, Rengo and Palmilla. San Fernando is one of the several towns founded in 1742 by the governor-general José de Manso, and had a population of 7447 in 1895. Rengo is an active commercial town and had a population of 6463 in 1895.

COLCHESTER, CHARLES ABBOT, 1ST BARON (1757-1829), born at Abingdon, was the son of Dr John Abbot, rector of All Saints, Colchester, and, by his mother's second marriage, half-brother of the famous Jeremy Bentham. From Westminster school Charles Abbot passed to Christ Church, Oxford, at which he gained the chancellor's medal for Latin verse as well as the Vinerian scholarship) In 1795, after having practised twelve

years as a barrister, and published a treatise proposing the incorporation of the judicial system of Wales with that of England, he was appointed to the office previously held by his brother of clerk of the rules in the king's bench; and in June of the same year he was elected member of parliament for Helston, through the influence of the duke of Leeds. In 1796 Abbot commenced his career as a reformer in parliament by obtaining the appointment of two committees—the one to report on the arrangements which then existed as to temporary laws or laws about to expire, the other to devise methods for the better publication of new statutes. To the latter committee, and a second committee which he proposed some years later, it is owing that copies of new statutes were thenceforth sent to all magistrates and municipal bodies. To Abbot's efforts were also due the establishment of the Royal Record Commission, the reform of the system which had allowed the public money to lie for some time at long interest in the hands of the public accountants, by charging them with payment of interest, and, most important of all, the act for taking the first census, that of 1801. On the formation of the Addington ministry in March 1801 Abbot became chief secretary and privy seal for Ireland; and in the February of the following year he was chosen speaker of the House of Commons—a position which he held with universal satisfaction till 1817, when an attack of erysipelas compelled him to retire. In response to an address of the Commons, he was raised to the peerage as Baron Colchester, with a pension of £4000, of which £3000 was to be continued to his heir. He died on the 8th of May 1829. His speeches against the Roman Catholic claims were published in 1828.

He was succeeded by his eldest son **CHARLES** (d. 1867), post-master-general in 1858; and the latter by his son **REGINALD CHARLES EDWARD** (b. 1842), as 3rd baron.

COLCHESTER, a market town, river port and municipal and parliamentary borough of Essex, England; 52 m. N.E. by E. from London by the Great Eastern railway. Pop. (1901) 38,373. It lies on the river Colne, 12 m. from the open sea. Among numerous buildings of antiquarian interest the first is the ruined keep of the castle, a majestic specimen of Norman architecture, the largest of its kind in England, covering nearly twice the area of the White Tower in London. It was erected in the reign of William I. or William II., and is quadrangular, turreted at the angles. As in other ancient buildings in Colchester there are evidences of the use of material from the Roman town which occupied the site, but it is clearly of Norman construction. Here is the museum of the Essex Archaeological Society, with a remarkable collection of Roman antiquities, and a library belonging to the Round family, who own the castle. Among ecclesiastical buildings are remains of two monastic foundations—the priory of St Botolph, founded early in the 12th century for Augustinian canons, of which part of the fine Norman west front (in which Roman bricks occur), and of the nave arcades remain; and the restored gateway of the Benedictine monastery of St John, founded by Eudo, steward to William II. This is a beautiful specimen of Perpendicular work, embattled, flanked by spired turrets, and covered with panel work. The churches of Holy Trinity, St Martin and St Leonard at Hythe are of antiquarian interest; the first has an apparently pre-Norman tower and the last preserves some curious frescoes.

The principal modern buildings are the town hall, corn exchange, free library, the Eastern Counties' asylum, Essex county hospital and barracks. The town has long been an important military centre with a large permanent camp. There are a free grammar school (founded 1539), a technical and university extension college, a literary institute and medical and other societies. Castle Park is a public ground surrounding the castle. Colchester is the centre of an agricultural district, and has extensive corn and cattle markets. Industries include founding, engineering, malting, flour-milling, rose-growing and the making of clothing and boots and shoes. The oyster fisheries at the mouth of the Colne, for which the town has been famous for centuries, belong to the corporation, and are held on a ninety-nine years' lease by the Colne Fishery Company, incorporated

under an act of 1870. The harbour, with quays at the suburb of Hythe, is controlled by the corporation. The parliamentary borough, which is co-extensive with the municipal, returns one member. The municipal corporation consists of a mayor, 8 aldermen and 24 councillors. Area 11,333 acres.

The Roman town, *Colonia Victricensis Camalodunum* (or *Camulodunum*), was of great importance. It was founded by Claudius, early in the period of the Roman conquest, as a municipality with discharged Roman soldiers as citizens, to assist the Roman dominion and spread its civilization. Under Queen Boadicea the natives burned the town and massacred the colonists; but Camalodunum soon rose to fresh prosperity and flourished throughout the Roman period. Its walls and some other remains, including the guardroom at the principal gate, can still be clearly traced, and many such relics as sculptures, inscriptions, pavements and pottery have been discovered. When the borough originated is not known, but Domesday Book mentions two hundred and seventy-six burgesses and land in *commune burgensium*, a phrase that may point to a nascent municipal corporation. The first charter given by Richard I. in 1189 granted the burghers leave to choose their bailiffs and a justice to hold the pleas of the crown within the borough, freedom from the obligation of duel, freedom of passage and pontage through England, free warren, fishery and custom as in the time of Henry I., and other privileges. An *inspeximus* of this charter by Henry III. in 1252 granted the burgesses the return of certain writs. The charters were confirmed by various kings, and new grants obtained in 1447 and 1535. In 1635 Charles I. granted a fresh charter, which replaced the bailiffs by a mayor, and in 1653 Cromwell altered it to secure a permanent majority for his party on the corporation. But his action was undone in 1659, and in 1663 Charles II. granted a new charter. In 1684 the charters were surrendered, and a new one obtained reserving to the crown power to remove the mayor and alderman, and this one was further modified by James II. But the charter of 1663 was confirmed in 1693 and remained in force till 1741, when the liberties were allowed to lapse. In 1763 George III. made the borough a renewed grant of its liberties. Colchester returned two members to parliament from 1295 until 1885. Fairs were granted by Richard I. in 1189 to the hospital of St Mary Magdalene, and by Edward II. in 1319 to the town for the eve of and feast of St Denis and the six following days—a fair which is still held. In the 13th century Colchester was sufficiently important as a port to pay a fee-farm of £46, its ships plying to Winchelsea and France. Elizabeth and James I. encouraged Flemish settlers in the manufacture of baize ("bays and says"), which attained great importance, so that a charter of Charles I. speaks of burgesses industriously exercising the manufacture of cloth. Both Camden and Fuller mention the trade in barrelled oysters and candied eringo-root. The most notable event in the history of the town was its siege by Fairfax in 1648, when the raw levies of the Royalists in the second civil war held his army at bay for nearly eleven weeks, only surrendering when starved out, and when Cromwell's victory in the north made further resistance useless. Colchester was made the see of a suffragan bishop by King Henry VIII., and two bishops were in succession appointed by him; no further appointments, however, were made until the see was re-established under Queen Victoria.

See *Victoria County History, Essex; Charters and Letters Patent granted to the Borough of Colchester* (Colchester, 1903); Morant, *History of Colchester* (1748); Harrod's *Report on the Records of Colchester* (1865); Cutts, *Colchester* (Historic Towns) 1888; J. H. Round, "Colchester and the Commonwealth" in *Eng. Hist. Rev.* vol. xv.; Benham, *Red Paper Book of Colchester* (1902), and *Oath Book of Colchester* (1907).

COLCHESTER, a township of Chittenden county, Vermont, U.S.A., on Lake Champlain, immediately N.E. of Burlington, from which it is separated by the Winooski river. Pop. (1900) 5352; (1910) 6450. It is served by the Central Vermont railway. The surface is generally gently rolling, and in places along the banks of the Winooski or Onion river, the shore of the lake, and in the valleys, it is very picturesque. At Mallett's Bay, an arm of Lake Champlain, 2 m. long and 1½ m. wide, several

large private schools hold summer sessions. The soil is varied, much of it being good meadow land or well adapted to the growing of grain and fruit. The township has two villages: Colchester Centre, a small, quiet settlement, and Winooski (pop. in 1900, 3783) on the Winooski river. This stream furnishes good water power, and the village has manufactories of cotton and woollen goods, lumber, woodenware, gold and silver plated ware, carriages, wagons and screens. Within the township there is a United States military reservation, Fort Ethan Allen. The village was founded in 1772 by Ira Allen and for many years it was known as "Allen's Settlement"; but later it was called Winooski Falls, and in 1866 it was incorporated as the Village of Winooski.

COLCHICUM, the Meadow Saffron, or Autumn Crocus (*Colchicum autumnale*), a perennial plant of the natural order Liliaceae, found wild in rich moist meadow-land in England and Ireland, in middle and southern Europe, and in the Swiss Alps. It has pale-purple flowers, rarely more than three in number; the perianth is funnel-shaped, and produced below into a long slender tube, in the upper part of which the six stamens are inserted. The ovary is three-celled, and lies at the bottom of this tube. The leaves are three or four in number, flat, lanceolate, erect and sheathing; and there is no stem. Propagation is by the formation of new corms from the parent corm, and by seeds. The latter are numerous, round, reddish-brown, and of the size of black mustard-seeds. The corm of the meadow-saffron attains its full size in June or early in July. A smaller corm is then formed from the old one, close to its root; and this in September and October produces the crocus-like flowers. In the succeeding January or February it sends up its leaves, together with the ovary, which perfects its seeds during the summer. The young corm, at first about the diameter of the flower-stalk, grows continuously, till in the following July it attains the size of a small apricot. The parent corm remains attached to the new one, and keeps its form and size till April in the third year of its existence, after which it decays. In some cases a single corm produces several new plants during its second spring by giving rise to immature corms.

C. autumnale and its numerous varieties as well as other species of the genus, are well known in cultivation, forming some of the most beautiful of autumn-flowering plants. They are very easy to cultivate and do not require lifting. The most suitable soil is a light, sandy loam enriched with well decomposed manure, in a rather moist situation. The corms should be planted not less than 3 in. deep. Propagation is effected by seed or increase of corms; the seed should be sown as soon as it is ripe in June or July.

Colchicum was known to the Greeks under the name of *Κολχικόν*, from *Κολχίς*, or Colchis, a country in which the plant grew; and it is described by Dioscorides as a poison. In the 17th century the corms were worn by some of the German peasantry as a charm against the plague. The drug was little used till 1763, when Baron Störck of Vienna introduced it for the treatment of dropsy. Its use in febrile diseases, at one time extensive, is now obsolete. As a specific for gout colchicum was early employed by the Arabs; and the preparation known as *eau médicinale*, much resorted to in the 18th century for the cure of gout, owes its therapeutic virtues to colchicum; but general attention was first directed by Sir Everard Home to the use of the drug in gout.

For medical purposes the corm should be collected in the early summer and, after the outer coat has been removed, should be sliced and dried at a temperature of 130° to 150° F.

The chief constituents of colchicum are two alkaloids, *colchicine* and *veratrine*. Colchicine is the active principle and may be given in full form in doses of 3/8 to 1/8 grain. It is a yellow, micro-crystalline powder, soluble in water, alcohol and chloroform, and forming readily decomposed salts with acids. It is the methyl ester of a neutral body *colchicin*, which may be obtained in white acicular crystals.

The official dose of powdered colchicum is 2 to 5 grains, which may be given in a cachet. The British Pharmacopocia contains

(1) an extract of the fresh corm, having doses of $\frac{1}{4}$ to 1 grain, and (2) the *Vinum Colchici*, made by treating the dried corm with sherry and given in doses of 10 to 30 minims. This latter is the preparation still most generally used, though the presence of veratrine both in the corm and the seeds renders the use of colchicine itself theoretically preferable. The dried ripe seeds of this plant are also used in medicine. They are exceedingly hard and difficult to pulverize, odourless, bitter and readily confused with black mustard seeds. They contain a volatile oil which does not occur in the corm, and their proportion of colchicine is higher, for which reason the *Tinctura Colchici Seminum*—dose 5 to 15 minims—is preferable to the wine prepared from the corm. At present this otherwise excellent preparation is not standardized, but the suggestion has been made that it should be standardized to contain 0.1% of colchicine. The salicylate of colchicine is stable in water and may be given in doses of about one-thirtieth of a grain. It is often known as Colchi-Sal.

Pharmacology.—Colchicum or colchicine, when applied to the skin, acts as a powerful irritant, causing local pain and congestion. When inhaled, the powder causes violent sneezing, similar to that produced by veratrine itself, which is, as already stated, a constituent of the corm. Taken internally, colchicum or colchicine markedly increases the amount of bile poured into the alimentary canal, being amongst the most powerful of known cholagogues. Though this action doubtless contributes to its remarkable therapeutic power, it is very far from being an adequate explanation of the virtues of the drug in gout. In larger doses colchicum or colchicine acts as a most violent gastrointestinal irritant, causing terrible pain, colic, vomiting, diarrhoea, hæmorrhage from the bowel, thirst and ultimately death from collapse. This is accelerated by a marked depressant action upon the heart, similar to that produced by veratrine and aconite. Large doses also depress the nervous system, weakening the anterior horns of grey matter in the spinal cord so as ultimately to cause complete paralysis, and also causing a partial insensibility of the cutaneous nerves of touch and pain. The action of colchicum or colchicine upon the kidneys has been minutely studied, and it is asserted on the one hand that the urinary solids are much diminished and, on the other hand, that they are markedly increased, the specific gravity of the secretion being much raised. These assertions, and the total inadequacy of the pharmacology of colchicum, as above detailed, to explain its specific therapeutic property, show that the secret of colchicum is as yet undiscovered.

The sole but extremely important use of this drug is as a specific for gout. It has an extraordinary power over the pain of acute gout; it lessens the severity and frequency of the attacks when given continuously between them, and it markedly controls such symptoms of gout as eczema, bronchitis and neuritis, whilst it is entirely inoperative against these conditions when they are not of gouty origin. Despite the general recognition of these facts, the pharmacology of colchicum has hitherto thrown no light on the pathology of gout, and the pathology of gout has thrown no light upon the manner in which colchicum exerts its unique influence upon this disease. Veratrine is useless in the treatment of gout. A further curious fact, doubtless of very great significance, but hitherto lacking interpretation, is that the administration of colchicum during an acute attack of gout may often hasten the oncoming of the next attack; and this property, familiar to many gouty patients, may not be affected by the administration of small doses after the attack. Altogether colchicum is a puzzle, and will remain so until the efficient poison of gout is isolated and defined. When that is done, colchicine may be found to exhibit a definite chemical interaction with this hitherto undiscovered substance.

In *colchicum poisoning*, empty the stomach, give white of egg, olive or salad oil, and water. Use hot bottles and stimulants, especially trying to counteract the cardiac depression by atropine, caffeine, strophanthin, &c.

COLCHIS, in ancient geography, a nearly triangular district of Asia Minor, at the eastern extremity of the Black Sea, bounded on the N. by the Caucasus, which separated it from Asiatic

Sarmatia, E. by Iberia, S. by the Montes Moschici, Armenia and part of Pontus, and W. by the Euxine. The ancient district is represented roughly by the modern province of Kutais (formerly Mingrelia). The name of Colchis first appears in Aeschylus and Pindar. It was inhabited by a number of tribes whose settlements lay chiefly along the shore of the Black Sea. The chief of those were the Lazi, Moschi, Apsilæ, Abasci, Sagadæ, Suani and Coraxi. These tribes differed so completely in language and appearance from the surrounding nations, that the ancients originated various theories to account for the phenomenon. Herodotus, who states that they, with the Egyptians and the Ethiopians, were the first to practise circumcision, believed them to have sprung from the relics of the army of Sesostris (*q.v.*), and thus regarded them as Egyptians. Apollonius Rhodius (*Argon*, iv. 279) states that the Egyptians of Colchis preserved as heirlooms a number of wooden *κίρβεις* (tablets) showing seas and highways with considerable accuracy. Though this theory was not generally adopted by the ancients, it has been defended, but not with complete success, by some modern writers. It is quite possible that there was an ancient trade connexion between the Colchians and the Mediterranean peoples. We learn that women were buried, while the corpses of men were suspended on trees. The principal coast town was the Milesian colony of Dioscurias (Roman Sebastopolis; mod. Sukhum Kaleh), the ancient name being preserved in the modern C. Iskuria. The chief river was the Phasis (mod. Rion). From Colchis is derived the name of the plant Colchicum (*q.v.*).

Colchis was celebrated in Greek mythology as the destination of the Argonauts, the home of Medea and the special domain of sorcery. Several Greek colonies were founded there by Miletus. At a remote period it seems to have been incorporated with the Persian empire, though the inhabitants evidently enjoyed a considerable degree of independence; in this condition it was found by Alexander the Great, when he invaded Persia. From this time till the era of the Mithradatic wars nothing is known of its history. At the time of the Roman invasion it seems to have paid a nominal homage to Mithradates the Great and to have been ruled over by Machares, his second son. On the defeat of Mithradates by Pompey, it became a Roman province. After the death of Pompey, Pharnaces, the son of Mithradates, rose in rebellion against the Roman yoke, subdued Colchis and Armenia, and made head, though but for a short time, against the Roman arms. After this Colchis was incorporated with Pontus, and the Colchians are not again alluded to in ancient history till the 6th century, when, along with the Abasci or Abasgi, under their king Gobazes, whose mother was a Roman, they called in the aid of Chosroes I. of Persia (541). The importance of the district, then generally called Lazica from the Lazi (cf. mod. Lazistan) who led the revolt, was due to the fact that it was the only remaining bar which held the Persians, already masters of Iberia, from the Black Sea. It had therefore been specially garrisoned by Justinian under first Peter, a Persian slave, and subsequently Johannes Tzibos, who built Petra on the coast as the Roman Headquarters. Tzibos took advantage of the extreme poverty of the Lazi to create a Roman monopoly by which he became a middleman for all the trade both export and import. Chosroes at once accepted the invitation of Gobazes and succeeded in capturing Petra (A.D. 541). The missionary zeal of the Zoroastrian priests soon caused discontent among the Christian inhabitants of Colchis, and Gobazes, perceiving that Chosroes intended to Persianize the district, appealed to Rome, with the result that in 549 one Dagisthaeus was sent out with 7000 Romans and 1000 auxiliaries of the Tzani (Zani, Sanni). The "Lazic War" lasted till 556 with varying success. Petra was recaptured in 551 and Archæopolis was held by the Romans against the Persian general Mermeroes. Gobazes was assassinated in 552, but the Persian general Nachoragan was heavily defeated at Phasis in 553.

By the peace of 562 the district was left in Roman possession, but during the next 150 years it is improbable that the Romans exercised much authority over it. In 697 we hear of a revolt against Rome led by Sergius the Patrician, who allied himself with the Arabs. Justinian II. in his second period of rule sent

Leo the Isaurian, afterwards emperor, to induce the Alans to attack the Abasgi. The Alans, having gained knowledge of the district by a trick, invaded Lazica, and, probably in 712, a Roman and Armenian army laid siege to Archaeopolis. On the approach of a Saracen force they retired, but a small plundering detachment was cut off. Ultimately Leo joined this band and aided by the Apsilian chief Marinus escaped with them to the coast.

From the beginning of the 14th to the end of the 17th century the district under the name Mingrelia (*q.v.*) was governed by an independent dynasty, the Dadians, which was succeeded by a semi-independent dynasty, the Chikovans, who by 1838 had submitted to Russia, though they retained a nominal sovereignty. In 1866 the district was finally annexed by Russia.

For the kings see Stokvis, *Manuel d'histoire*, i. 83. (J. M. M.)

COLCOTHAR (adapted in Romanic languages from Arabic *golgotar*, which was probably a corruption of the Gr. *χαλκανθος*, from *χαλκός*, copper, *ἄνθος*, flower, *i.e.* copper sulphate), a name given to the brownish-red ferric oxide formed in the preparation of fuming sulphuric (Nordhausen) acid by distilling ferrous sulphate. It is used as a polishing powder, forming the rouge of jewellers, and as the pigment Indian red. It is also known as *Crocus Martis*.

COLD (in O. Eng. *cald* and *ceald*, a word coming ultimately from a root cognate with the Lat. *gelu*, *gelidus*, and common in the Teutonic languages, which usually have two distinct forms for the substantive and the adjective, cf. Ger. *Kälte*, *kalt*, Dutch *koude*, *koud*), subjectively the sensation which is excited by contact with a substance whose temperature is lower than the normal; objectively a quality or condition of material bodies which gives rise to that sensation. Whether cold, in the objective sense, was to be regarded as a positive quality or merely as absence of heat was long a debated question. Thus Robert Boyle, who does not commit himself definitely to either view, says, in his *New Experiments and Observations touching Cold*, that "the dispute which is the *primum frigidum* is very well known among naturalists, some contending for the earth, others for water, others for the air, and some of the moderns for nitre, but all seeming to agree that there is some body or other that is of its own nature supremely cold and by participation of which all other bodies obtain that quality." But with the general acceptance of the dynamical theory of heat, cold naturally came to be regarded as a negative condition, depending on decrease in the amount of the molecular vibration that constitutes heat.

The question whether there is a limit to the degree of cold possible, and, if so, where the zero must be placed, was first attacked by the French physicist, G. Amontons, in 1702-1703, in connexion with his improvements in the air-thermometer. In his instrument temperatures were indicated by the height at which a column of mercury was sustained by a certain mass of air, the volume or "spring" of which of course varied with the heat to which it was exposed. Amontons therefore argued that the zero of his thermometer would be that temperature at which the spring of the air in it was reduced to nothing. On the scale he used the boiling-point of water was marked at 73 and the melting-point of ice at $51\frac{1}{2}$, so that the zero of his scale was equivalent to about -240° on the centigrade scale. This remarkably close approximation to the modern value of -273° for the zero of the air-thermometer was further improved on by J. H. Lambert (*Pyrometrie*, 1779), who gave the value -270° and observed that this temperature might be regarded as absolute cold. Values of this order for the absolute zero were not, however, universally accepted about this period. Laplace and Lavoisier, for instance, in their treatise on heat (1780), arrived at values ranging from 1500° to 3000° below the freezing-point of water, and thought that in any case it must be at least 600° below, while John Dalton in his *Chemical Philosophy* gave ten calculations of this value, and finally adopted -3000° C. as the natural zero of temperature. After J. P. Joule had determined the mechanical equivalent of heat, Lord Kelvin approached the question from an entirely different point of view, and in 1848 devised a scale of absolute temperature which was inde-

pendent of the properties of any particular substance and was based solely on the fundamental laws of thermodynamics (see HEAT and THERMODYNAMICS). It followed from the principles on which this scale was constructed that its zero was placed at -273° , at almost precisely the same point as the zero of the air-thermometer.

In nature the realms of space, on the probable assumption that the interstellar medium is perfectly transparent and diathermanous, must, as was pointed out by W. J. Macquorn Rankine, be incapable of acquiring any temperature, and must therefore be at the absolute zero. That, however, is not to say that if a suitable thermometer could be projected into space it would give a reading of -273° . On the contrary, not being a transparent and diathermanous body, it would absorb radiation from the sun and other stars, and would thus become warmed. Professor J. H. Poynting ("Radiation in the Solar System," *Phil. Trans.*, A, 1903, 202, p. 525) showed that as regards bodies in the solar system the effects of radiation from the stars are negligible, and calculated that by solar radiation alone a small absorbing sphere at the distance of Mercury from the sun would have its temperature raised to 483° Abs. (210° C.), at the distance of Venus to 358° Abs. (85° C.), of the earth to 300° Abs. (27° C.), of Mars to 243° Abs. (-30° C.), and of Neptune to only 54° Abs. (-219° C.). The French physicists of the early part of the 19th century held a different view, and rejected the hypothesis of the absolute cold of space. Fourier, for instance, postulated a fundamental temperature of space as necessary for the explanation of the heat-effects observed on the surface of the earth, and estimated that in the interplanetary regions it was little less than that of the terrestrial poles and below the freezing-point of mercury, though it was different in other parts of space (*Ann. chim. phys.*, 1824, 27, pp. 141, 150). C. S. M. Pouillet, again, calculated the temperature of interplanetary space as -142° C. (*Comptes rendus*, 1838, 7, p. 61), and Sir John Herschel as -150° (*Ency. Brit.*, 8th ed., art. "Meteorology," p. 643).

To attain the absolute zero in the laboratory, that is, to deprive a substance entirely of its heat, is a thermodynamical impossibility, and the most that the physicist can hope for is an indefinitely close approach to that point. The lowest steady temperature obtainable by the exhaustion of liquid hydrogen is about -262° C. (11° Abs.), and the liquefaction of helium by Professor Kamerlingh Onnes in 1908 yielded a liquid having a boiling-point of about 4.3° Abs., which on exhaustion must bring us to within about $2\frac{1}{2}$ degrees of the absolute zero. (See LIQUID GASES.)

For a "cold," in the medical sense, see CATARRH and RESPIRATORY SYSTEM: *Pathology*.

COLDEN, CADWALLADER (1688-1776), American physician and colonial official, was born at Duns, Scotland, on the 17th of February 1688. He graduated at the university of Edinburgh in 1705, spent three years in London in the study of medicine, and emigrated to America in 1708. After practising medicine for ten years in Philadelphia, he was invited to settle in New York by Governor Hunter, and in 1718 was appointed the first surveyor-general of the colony. Becoming a member of the provincial council in 1720, he served for many years as its president, and from 1761 until his death was lieutenant-governor; for a considerable part of the time, during the interim between the appointment of governors, he was acting-governor. About 1755 he retired from medical practice. As early as 1729 he had built a country house called Coldenham on the line between Ulster and Orange counties, where he spent much of his time until 1761. Aristocratic and extremely conservative, he had a violent distrust of popular government and a strong aversion to the popular party in New York. Naturally he came into frequent conflict with the growing sentiment in the colony in opposition to royal taxation. He was acting-governor when in 1765 the stamped paper to be used under the Stamp Act arrived in the port of New York; a mob burned him in effigy in his own coach in Bowling Green, in sight of the enraged acting-governor and of General Gage; and Colden was compelled to surrender the stamps to the city council, by whom they were

locked up in the city hall until all attempts to enforce the new law were abandoned. Subsequently Colden secured the suspension of the provincial assembly by an act of parliament. He understood, however, the real temper of the patriot party, and in 1775, when the outbreak of hostilities seemed inevitable, he strongly advised the ministry to act with caution and to concede some of the colonists' demands. When the war began, he retired to his Long Island country seat, where he died on the 28th of September 1776. Colden was widely known among scientists and men of letters in England and America. He was a life-long student of botany, and was the first to introduce in America the classification system of Linnaeus, who gave the name "Coldenia" to a newly recognized genus. He was an intimate friend of Benjamin Franklin. He wrote several medical works of importance in their day, the most noteworthy being *A Treatise on Wounds and Fevers* (1765); he also wrote *The History of the Five Indian Nations depending on the Province of New York* (1727, reprinted 1866 and 1905), and an elaborate work on *The Principles of Action in Matter* (1751), which, with his *Introduction to the Study of Physics* (c. 1756), his *Enquiry into the Principles of Vital Motion* (1766), and his *Reflections* (c. 1770), mark him as the first of American materialists and one of the ablest material philosophers of his day. I. Woodbridge Riley, in *American Philosophy* (New York, 1907), made the first critical study of Colden's philosophy, and said of it that it combined "Newtonian mechanics with the ancient hylozoistic doctrine . . ." and "ultimately reached a kind of dynamic pansychism, substance being conceived as a self-acting and universally diffused principle, whose essence is power and force."

See Alice M. Keys, *Cadwallader Colden, A Representative 18th Century Official* (New York, 1906), a Columbia University doctoral dissertation; J. G. Mumford, *Narrative of Medicine in America* (New York, 1903); and Asa Gray, "Selections from the Scientific Correspondence of Cadwallader Colden" in *American Journal of Science*, vol. 44, 1843.

His grandson, CADWALLADER DAVID COLDEN (1769-1834), lawyer and politician, was educated in London, but returned in 1785 to New York, where he attained great distinction at the bar. He was a colonel of volunteers during the war of 1812, and from 1818 to 1821 was the successor of Jacob Radcliff as mayor of New York City. He was a member of the state assembly (1818) and the state senate (1825-1827), and did much to secure the construction of the Erie Canal and the organization of the state public school system; and in 1821-1823 he was a representative in Congress. He wrote a *Life of Robert Fulton* (1817) and a *Memoir of the Celebration of the Completion of the New York Canals* (1825).

COLD HARBOR, OLD and NEW, two localities in Hanover county, Virginia, U.S.A., 10 m. N.E. of Richmond. They were the scenes of a succession of battles, on May 31-June 12, 1864, between the Union forces under command of General U. S. Grant and the Confederates under General R. E. Lee, who held a strongly entrenched line at New Cold Harbor. The main Union attack on June 3 was delivered by the II. (Hancock), VI. (Wright), and XVIII. (W. F. Smith) corps, and was brought to a standstill in eight minutes. An order from army headquarters to renew the attack was ignored by the officers and men at the front, who realized fully the strength of the hostile position. These troops lost as many as 5000 men in an hour's fighting, the greater part in the few minutes of the actual assault. In the constant fighting of 31st of May to 12th of June on this ground Grant lost 14,000 men. (See WILDERNESS and AMERICAN CIVIL WAR.)

COLDSTREAM, a police burgh of Berwickshire, Scotland. Pop. (1901) 1482. It is situated on the north bank of the Tweed, here spanned by John Smeaton's fine bridge of five arches, erected in 1763-1766, 13½ m. south-west of Berwick by the North Eastern railway. The chief public buildings are the town hall, library, mechanics' institute, and cottage hospital. Some brewing is carried on. Owing to its position on the Border and also as the first ford of any consequence above Berwick, the town played a prominent part in Scottish history during many centuries. Here Edward I. crossed the stream in 1296 with his

invading host, and Montrose with the Covenanters in 1640. Of the Cistercian priory, founded about 1165 by Cospatric of Dunbar, and destroyed by the 1st earl of Hertford in 1545, which stood a little to the east of the present market-place, no trace remains; but for nearly four hundred years it was a centre of religious fervour. Here it was that the papal legate, in the reign of Henry VIII., published a bull against the printing of the Scriptures; and by the irony of fate its site was occupied in the 19th century by an establishment, under Dr Adam Thomson, for the production of cheap Bibles. At Coldstream General Monk raised in 1659 the celebrated regiment of Foot Guards bearing its name. Like Gretna Green, Coldstream long enjoyed a notoriety as the resort of runaway couples, the old toll-house at the bridge being the usual scene of the marriage ceremony. "Marriage House," as it is called, still exists in good repair. Henry Brougham, afterwards lord chancellor, was married in this clandestine way, though in an inn and not at the bridge, in 1821. Birgham, 3 m. west, was once a place of no small importance, for there in 1188 William the Lion conferred with the bishop of Durham concerning the attempt of the English Church to impose its supremacy upon Scotland; there in 1289 was held the convention to consider the question of the marriage of the Maid of Norway with Prince Edward of England; and there, too, in 1290 was signed the treaty of Birgham, which secured the independence of Scotland. Seven miles below Coldstream on the English side, though 6 m. north-east of it, are the massive ruins of Norham Castle, made famous by Scott's *Marmion*, and from the time of its building by Ranulph Flambard in 1121 a focus of Border history during four centuries.

COLDWATER, a city and county-seat of Branch county, Michigan, U.S.A., on Coldwater Stream (which connects two of the group of small lakes in the vicinity), about 80 m. S.S.E. of Grand Rapids. Pop. (1890) 5247; (1900) 6216, of whom 431 were foreign-born; (1904) 6225; (1910) 5945. It is served by the Lake Shore & Michigan Southern railway. It is the seat of a state public school and temporary home (opened in 1874) for dependent, neglected or ill-treated children, who are received at any age under twelve. The city is situated in a fine farming region, has an important flouring and grist mill industry, and also manufactures Portland cement, liniment, lumber, furniture, sashes, doors and blinds, brass castings, sleighs, shoes, &c. The municipality owns and operates the water-works and electric lighting plant. Coldwater was settled in 1829, was laid out as a town under the name of Lyons in 1832, received its present name in the following year, was incorporated as a village in 1837, was reached by railway and became the county-seat in 1851, and was chartered as a city in 1861.

COLE, SIR HENRY (1808-1882), English civil servant, was born at Bath on the 15th of July 1808, and was the son of an officer in the army. At the age of fifteen he became clerk to Sir Francis Palgrave, then a subordinate officer in the record office, and, helped by Charles Buller, to whom he had been introduced by Thomas Love Peacock, and who became chairman of a royal commission for inquiry into the condition of the public records, worked his way up until he became an assistant keeper. He largely assisted in influencing public opinion in support of Sir Rowland Hill's reforms at the post office. A connexion with the Society of Arts caused him to drift gradually out of the record office: he was a leading member of the commission that organized the Great Exhibition of 1851, and upon the conclusion of its labours was made secretary to the School of Design, which by a series of transformations became in 1853 the Department of Science and Art. Under its auspices the South Kensington (now Victoria and Albert) Museum was founded in 1855 upon land purchased out of the surplus of the exhibition, and Cole practically became its director, retiring in 1873. His proceedings were frequently criticized, but the museum owes much to his energy. Indefatigable, genial and masterful, he drove everything before him, and by all sorts of schemes and devices built up a great institution, whose variety and inequality of composition seemed imaged in the anomalous structure in which it was temporarily housed. He also, though

to the financial disappointment of many, conferred a great benefit upon the metropolis by originating the scheme for the erection of the Royal Albert Hall. He was active in founding the national training schools for cookery and music, the latter the germ of the Royal College of Music. He edited the works of his benefactor Peacock; and was in his younger days largely connected with the press, and the author of many useful topographical handbooks published under the pseudonym of "Felix Summerly." He died on the 18th of April 1882.

COLE, THOMAS (1801-1848), American landscape painter, was born at Bolton-le-Moors, England, on the 1st of February 1801. In 1819 the family emigrated to America, settling first in Philadelphia and then at Steubenville, Ohio, where Cole learned the rudiments of his profession from a wandering portrait painter named Stein. He went about the country painting portraits, but with little financial success. Removing to New York (1825), he displayed some landscapes in the window of an eating-house, where they attracted the attention of the painter Colonel Trumbull, who sought him out, bought one of his canvases, and found him patrons. From this time Cole was prosperous. He is best remembered by a series of pictures consisting of four canvases representing "The Voyage of Life," and another series of five canvases representing "The Course of Empire," the latter now in the gallery of the New York Historical Society. They were allegories, in the taste of the day, and became exceedingly popular, being reproduced in engravings with great success. The work, however, was meretricious, the sentiment false, artificial and conventional, and the artist's genuine fame must rest on his landscapes, which, though thin in the painting, hard in the handling, and not infrequently painful in detail, were at least earnest endeavours to portray the world out of doors as it appeared to the painter; their failings were the result of Cole's environment and training. He had an influence on his time and his fellows which was considerable, and with Durand he may be said to have founded the early school of American landscape painters. Cole spent the years 1829-1832 and 1841-1842 abroad, mainly in Italy, and at Florence lived with the sculptor Greenough. After 1827 he had a studio in the Catskills which furnished the subjects of some of his canvases, and he died at Catskill, New York, on the 11th of February 1848. His pictures are in many public and private collections. His "Expulsion from Eden" is in the Metropolitan Museum in New York.

COLE, TIMOTHY (1852-), American wood engraver, was born in London, England, in 1852, his family emigrating to the United States in 1858. He established himself in Chicago, where in the great fire of 1871 he lost everything he possessed. In 1875 he removed to New York, finding work on the *Century* (then *Scribner's*) magazine. He immediately attracted attention by his unusual facility and his sympathetic interpretation of illustrations and pictures, and his publishers sent him abroad in 1883 to engrave a set of blocks after the old masters in the European galleries. These achieved for him a brilliant success. His reproductions of Italian, Dutch, Flemish and English pictures were published in book form with appreciative notes by the engraver himself. Though the advent of new mechanical processes had rendered wood engraving almost a lost art and left practically no demand for the work of such craftsmen, Mr Cole was thus enabled to continue his work, and became one of the foremost contemporary masters of wood engraving. He received a medal of the first class at the Paris Exhibition of 1900, and the only grand prize given for wood engraving at the Louisiana Purchase Exposition at St Louis, Missouri, in 1904.

COLE, VICAT (1833-1893), English painter, born at Portsmouth on the 17th of April 1833, was the son of the landscape painter, George Cole, and in his practice followed his father's lead with marked success. He exhibited at the British Institution at the age of nineteen, and was first represented at the Royal Academy in 1853. His election as an associate of this institution took place in 1870, and he became an Academician ten years later. He died in London on the 6th of April 1893. The wide popularity of his work was due partly to the simple directness of his technical method, and partly to his habitual choice of attractive material.

Most of his subjects were found in the counties of Surrey and Sussex, and along the banks of the Thames. One of his largest pictures, "The Pool of London," was bought by the Chantry Fund Trustees in 1888, and is now in the Tate Gallery.

See Robert Chignell, *The Life and Paintings of Vicat Cole, R.A.* (London, 1899).

COLEBROOKE, HENRY THOMAS (1765-1837), English Orientalist, the third son of Sir George Colebrooke, 2nd baronet, was born in London on the 15th of June 1765. He was educated at home; and when only fifteen he had made considerable attainments in classics and mathematics. From the age of twelve to sixteen he resided in France, and in 1782 was appointed to a writership in India. About a year after his arrival there he was placed in the board of accounts in Calcutta; and three years later he was removed to a situation in the revenue department at Tirhut. In 1789 he was removed to Purneah, where he investigated the resources of that part of the country, and published his *Remarks on the Husbandry and Commerce of Bengal*, privately printed in 1795, in which he advocated free trade between Great Britain and India. After eleven years' residence in India, Colebrooke began the study of Sanskrit; and to him was confided the translation of the great *Digest of Hindu Laws*, which had been left unfinished by Sir William Jones. He translated the two treatises *Mitacshara* and *Dayabhaga* under the title *Law of Inheritance*. He was sent to Nagpur in 1799 on a special mission, and on his return was made a judge of the new court of appeal, over which he afterwards presided. In 1805 Lord Wellesley appointed him professor of Hindu Law and Sanskrit at the college of Fort William. During his residence at Calcutta he wrote his *Sanskrit Grammar* (1805), some papers on the religious ceremonies of the Hindus, and his *Essay on the Vedas* (1805), for a long time the standard work on the subject. He became member of council in 1807 and returned to England seven years later. He died on the 18th of March 1837. He was a director of the Asiatic Society, and many of the most valuable papers in the society's *Transactions* were communicated by him.

His life was written by his son, Sir T. E. Colebrooke, in 1873.

COLEMANITE, a hydrous calcium borate, $\text{Ca}_2\text{B}_6\text{O}_{11} \cdot 5\text{H}_2\text{O}$, found in California as brilliant monoclinic crystals. It contains 50.9% of boron trioxide, and is an important source of commercial borates and boracic acid. Beautifully developed crystals, up to 2 or 3 in. in length, encrust cavities in compact, white colemanite; they are colourless and transparent, and the brilliant lustre of their faces is vitreous to adamantine in character. There is a perfect cleavage parallel to the plane of symmetry of the crystals. Hardness 4-4½; specific gravity 2.42. The mineral was first discovered in 1882 in Death Valley, Inyo county, California, and in the following year it was found in greater abundance near Daggett in San Bernardino county, forming with other borates and borosilicates a bed in sedimentary strata of sandstones and clays; in more recent years very large masses have been found and worked in these localities, and also in Los Angeles county (see Special Report, 1905, of U.S. Census Bureau on *Mines and Quarries*; and *Mineral Resources of the U.S.*, 1907).

Priceite and pandermite are hydrous calcium borates with very nearly the same composition as colemanite, and they may really be only impure forms of this species. They are massive white minerals, the former friable and chalk-like, and the latter firm and compact in texture. Priceite occurs near Chetco in Curry county, Oregon, where it forms layers between a bed of slate and one of tough blue steatite; embedded in the steatite are rounded masses of priceite varying in size from that of a pea to masses weighing 200 lb. Pandermite comes from Asia Minor, and is shipped from the port of Panderma on the Sea of Marmora: it occurs as large nodules, up to a ton in weight, beneath a thick bed of gypsum.

Another borate of commercial importance found abundantly in the California deposits is ulexite, also known as boronatrocalcite or "cotton-ball," a hydrous calcium and sodium borate, $\text{CaNaB}_5\text{O}_{13} \cdot 8\text{H}_2\text{O}$, which forms rounded masses consisting of a loose aggregate of fine fibres. It is the principal species in the borate deposits in the Atacama region of South America. (L. J. S.)

COLENSO, JOHN WILLIAM (1814–1883), English bishop of Natal, was born at St Austell, Cornwall, on the 24th of January 1814. His family were in embarrassed circumstances, and he was indebted to relatives for the means of university education. In 1836 he was second wrangler and Smith's prizeman at Cambridge, and in 1837 he became fellow of St John's. Two years later he went to Harrow as mathematical tutor, but the step proved an unfortunate one. The school was just then at the lowest ebb, and Colenso not only had few pupils, but lost most of his property by a fire. He went back to Cambridge, and in a short time paid off heavy debts by diligent tutoring and the proceeds of his series of manuals of algebra (1841) and arithmetic (1843), which were adopted all over England. In 1846 he became rector of Fornsett St Mary, Norfolk, and in 1853 he was appointed bishop of Natal. He at once devoted himself to acquiring the Zulu language, of which he compiled a grammar and a dictionary, and into which he translated the New Testament and other portions of Scripture. He had already given evidence, in a volume of sermons dedicated to Maurice, that he was not satisfied with the traditional views about the Bible. The puzzling questions put to him by the Zulus strengthened him in this attitude and led him to make a critical examination of the Pentateuch. His conclusions, positive and negative, were published in a series of treatises on the Pentateuch, extending from 1862 to 1879, and, being in advance of his time, were naturally disputed in England with a fervour of conviction equal to his own. On the continent they attracted the notice of Abraham Kuenen, and furthered that scholar's investigations.

While the controversy raged in England, the South African bishops, whose suspicions Colenso had already incurred by the liberality of his views respecting polygamy among native converts and by a commentary upon the Epistle to the Romans (1861), in which he combated the doctrine of eternal punishment, met in conclave to condemn him, and pronounced his deposition (December 1863). Colenso, who had refused to appear before their tribunal otherwise than as sending a protest by proxy, appealed to the privy council, which pronounced that the metropolitan of Cape Town (Robert Gray) had no coercive jurisdiction and no authority to interfere with the bishop of Natal. No decision, therefore, was given upon the merits of the case. His adversaries, though unable to obtain his condemnation, succeeded in causing him to be generally inhibited from preaching in England, and Bishop Gray not only excommunicated him but consecrated a rival bishop for Natal (W. K. Macrorie), who, however, took his title from Maritzburg. The contributions of the missionary societies were withdrawn, but an attempt to deprive him of his episcopal income was frustrated by a decision of the courts. Colenso, encouraged by a handsome testimonial raised in England, to which many clergymen subscribed, returned to his diocese, and devoted the latter years of his life to further labours as a biblical commentator and translator. He also championed the cause of the natives against Boer oppression and official encroachments, a course by which he made more enemies among the colonists than he had ever made among the clergy. He died at Durban on the 20th of June 1883. His daughter Frances Ellen Colenso (1849–1887) published two books on the relations of the Zulus to the British (1880 and 1885), taking a pro-Zulu view; and an elder daughter, Harriette E. Colenso (b. 1847), became prominent as an advocate of the natives in opposition to their treatment by Natal, especially in the case of Dinizulu in 1888–1889 and in 1903–1909.

See his *Life* by Sir G. W. Cox (2 vols., London, 1888).

COLENSO, a village of Natal on the right or south bank of the Tugela river, 16 m. by rail south by east of Ladysmith. It was the scene of an action fought on the 15th of December 1899 between the British forces under Sir Redvers Buller and the Boers, in which the former were repulsed. (See **LADYSMITH**.)

COLEOPTERA, a term used in zoological classification for the true beetles which form one of the best-marked and most natural of the orders into which the class Hexapoda (or Insecta) has been divided. For the relationship of the Coleoptera to other orders

of insects see **HEXAPODA**. The name (Gr. *κολεός*, a sheath, and *πτερά*, wings) was first used by Aristotle, who noticed the firm protective sheaths, serving as coverings for the hind-wings which alone are used for flight, without recognizing their correspondence with the fore-wings of other insects.

These firm fore-wings, or elytra (fig. 1, A), are usually convex above, with straight hind margins (*dorsa*); when the elytra are closed, the two hind margins come together along the mid-dorsal line of the body, forming a *suture*. In many beetles the hind-wings are reduced to mere vestiges useless for flight, or are altogether absent, and in such cases the two elytra are often fused together at the suture; thus organs originally intended for flight have been transformed into an armour-like covering for the beetle's hind-body. In correlation with their heavy build and the frequent loss of the power of flight, many beetles are terrestrial rather than aerial in habit, though a large proportion of the order can fly well.

Aristotle's term was adopted by Linnaeus (1758), and has been universally used by zoologists. The identification of the elytra of beetles with the fore-wings of other insects has indeed been questioned (1880) by F. Meinert, who endeavoured to compare them with the tegulae of Hymenoptera, but the older view was securely established by the demonstration in pupal elytra by J. G. Needham (1898) and W. L. Tower (1903), of nervures similar to those of the hind-wing, and by the proof that the small membranous structures present beneath the elytra of certain beetles, believed by Meinert to represent the whole of the true fore-wings, are in reality only the alulae.

Structure.—Besides the conspicuous character of the elytra, beetles are distinguished by the adaptation of the jaws for biting, the mandibles (fig. 1, Bb) being powerful, and the first pair of maxillae (fig. 1, Bc) usually typical in form. The maxillae of the second pair (fig. 1, Bd) are very intimately fused together to form what is called the "lower lip" or labium, a firm transverse plate representing the fused basal portions of the maxillae, which may carry a small median "ligula," representing apparently the fused inner maxillary lobes, a pair of paraglossae (outer maxillary lobes), and a pair of palps. The feelers of beetles differ greatly in the different families (cf. figs. 2b, 9b and 26 b, c); the number of segments is usually eleven, but may vary from two to more than twenty.

The head is extended from behind forwards, so that the crown (epicranium) is large, while the face (clypeus) is small. The chin (gula) is a very characteristic sclerite in beetles, absent only in a few families, such as the weevils. There is usually a distinct labrum (fig. 1, Ba).

The prothorax is large and "free," *i.e.* readily movable on the mesothorax, an arrangement usual among insects with the power of rapid running. The tergite of the prothorax (pronotum) is prominent in all beetles, reaching back to the bases of the elytra and forming a substantial shield for the front part of the body. The tergal regions of the mesothorax and of the metathorax are hidden under the pronotum and the elytra when the latter are closed, except that the mesothoracic scutellum is often visible—a small triangular or semicircular plate between the bases of the elytra (fig. 1, A). The ventral region of the thoracic skeleton is complex, each segment usually possessing a median sternum with paired episterna (in front) and epimera (behind). The articular surfaces of the haunches (coxae) of the fore-legs are often conical or globular, so that each limb works in a ball-and-socket joint, while the hind haunches are large, displacing the ventral sclerites of the first two abdominal segments (fig. 1, C). The legs themselves (fig. 1, A) are of the usual insectan type, but in many families one, two, or even three of the five foot-segments may be reduced or absent. In beetles of aquatic habit the intermediate and hind legs are modified as swimming-organs (fig. 2, a), while in many beetles that burrow into the earth or climb about on trees the fore-legs are broadened and strengthened for digging, or lengthened and modified for clinging to branches. The hard fore-wings (elytra) are strengthened with marginal ridges, usually inflected ventrally to form epipleura which fit accurately along the edges of the

abdomen. The upper surface of the elytron is sharply folded inwards at intervals, so as to give rise to a regular series of external longitudinal furrows (striae) and to form a set of supports between the two chitinous layers forming the elytron. The upper surface often shows a number of impressed dots (punctures). Along the sutural border of the elytron, the chitinous lamella forms a tubular space within which are numerous glands. The glands occur in groups, and lead into common ducts which open

usually so much reduced that the foremost apparent ventral sclerite of the abdomen represents the third sternite. From this point backwards the successive abdominal segments, as far as the seventh or eighth, can be readily made out. The ninth and tenth segments are at most times retracted within the eighth. The female can protrude a long flexible tube in connexion with the eighth segment, carrying the sclerites of the ninth at its extremity, and these sclerites may carry short hairy processes

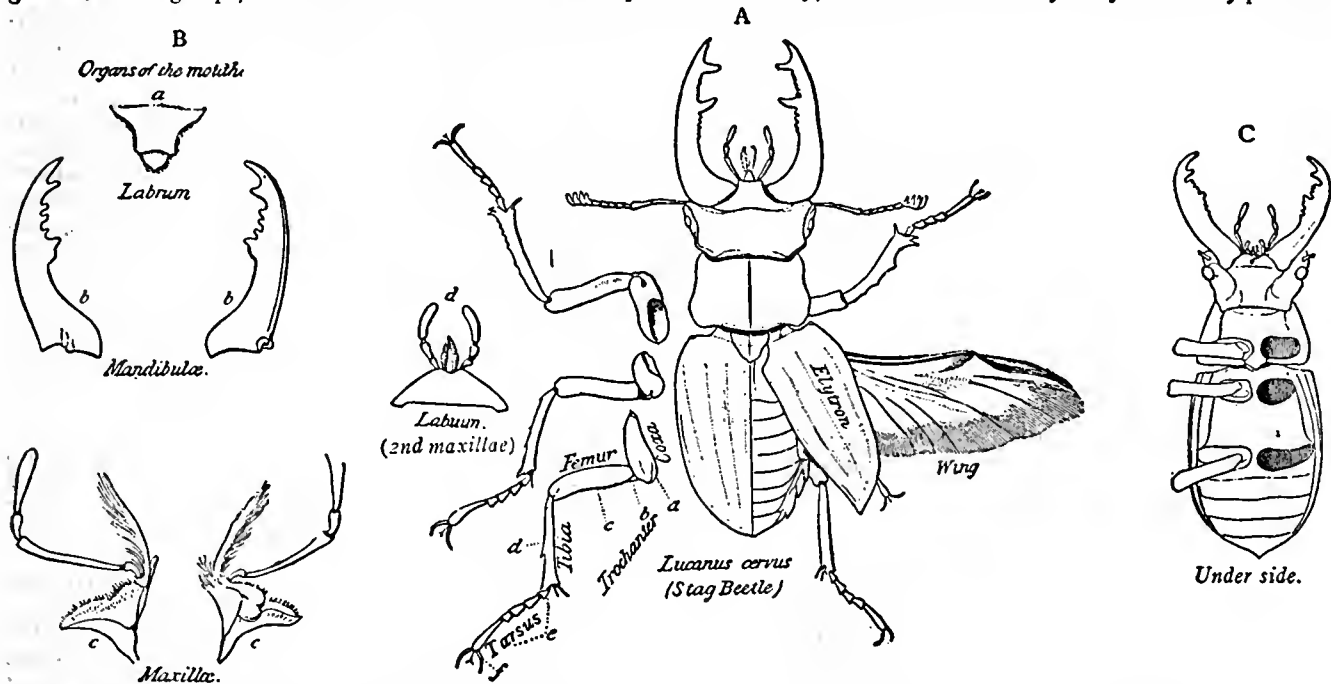

FIG. 1.—Structure of Male Stag-Beetle (*Lucanus cervus*). A, Dorsal view; B, mouth organs; C, under side.

in several series along the suture. Sometimes the glands are found beneath the disk of the elytron, opening by pores on the surface. The hind-wings, when developed, are characteristic in form, possessing a sub-costal nervure with which the reduced radial nervure usually becomes associated. There are several curved median and cubital nervures and a single anal, but few cross nervures or areolets. The wing, when not in use, is folded

—the stylets. This flexible tube is the functional ovipositor, the typical insectan ovipositor with its three pairs of processes (see HEXAPODA) being undeveloped among the Coleoptera. In male beetles, however, the two pairs of genital processes (paramera) belonging to the ninth abdominal segment are always present, though sometimes reduced. Between them is situated, sometimes asymmetrically, the prominent intromittent organ.

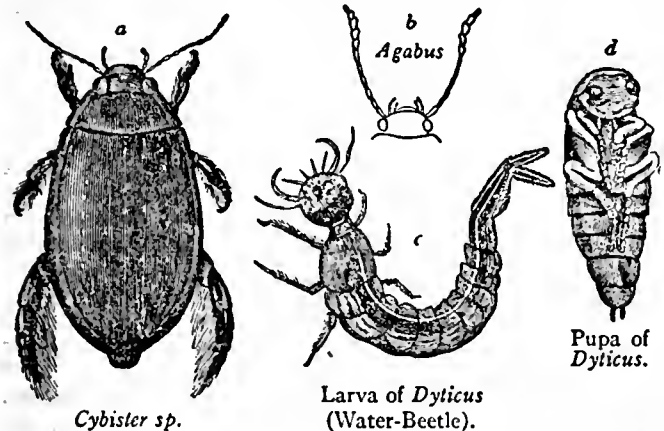

FIG. 2.—Water Beetles (*Dyticidae*). a, Beetle; b, head of beetle with feelers and palps; c, larva; d, pupa.

both lengthwise and transversely, and doubled up beneath the elytron; to permit the transverse folding, the longitudinal nervures are interrupted.

Ten segments can be recognized—according to the studies of K. W. Verhoeff (1894-1896)—in a beetle's abdomen, but the tenth sternite is usually absent. On account of the great extension of the metathorax and the haunches of the large hind-legs, the first abdominal sternite is wanting, and the second is

in the structure of the digestive system, beetles resemble most other mandibulate insects, the food-canal consisting of gullet, crop, gizzard, mid-gut or stomach, intestine and rectum. The stomach is beset throughout its length with numerous small, finger-like caecal tubes. The excretory (malpighian) tubes are few in number, either four or six. Many beetles have, in connexion with the anus, glands which secrete a repellent acid fluid, serving as a defence for the insect when attacked. The "bombardier" ground beetles (fig. 5) have this habit. Oil-beetles (figs. 23 and 24) and ladybirds (fig. 32) defend themselves by ejecting drops of fluid from the knee-joints. The nervous system is remarkably concentrated in some beetles, the abdominal ganglia showing a tendency to become shifted forward and crowded together, and in certain chafers all the thoracic and abdominal ganglia are fused into a single nerve-centre situated in the thorax,—a degree of specialization only matched in the insectan class among the Hemiptera and some muscid flies.

Development.—The embryonic development (see HEXAPODA) has been carefully studied in several genera of beetles. As regards growth after hatching, all beetles undergo a "complete" metamorphosis, the wing-rudiments developing beneath the cuticle throughout the larval stages, and a resting pupal stage intervening between the last larval instar¹ and the imago. The coleopterous pupa (figs. 2d, 3 c) is always "free," the legs, wings and other appendages not being

¹ Instar is a convenient term suggested by D. Sharp to indicate a stage in the life-history of an insect between two successive castings of the cuticle.

fixed to the body as in the pupa of a moth, and the likeness of pupa to perfect insect is very close.

The most striking feature in the development of beetles is the great diversity noticeable in the outward form of the larva in different families. The larva of a ground-beetle or a carnivorous water-beetle (fig. 2 c) is an active elongate grub with well-armoured cuticle. The head—carrying feelers, mandibles and two pairs of maxillae—is succeeded by the three thoracic segments, each bearing a pair of strong five-segmented legs, whose feet, like those of the adult, carry two claws. Ten segments can be distinguished in the tapering abdomen, the ninth frequently bearing a pair of tail-feelers (cerci), and the tenth, attached ventrally to the ninth, having the anal opening at its extremity and performing the function of a posterior limb, supporting and temporarily fixing the tail end of the insect on the surface over which it crawls. Such a typically "campodeiform" grub, moving actively about in pursuit of prey, is the one extreme of larval structure to be noticed among the Coleoptera. The other is exemplified by the white, wrinkled, soft-skinned, legless grub of a weevil, which lives underground feeding on roots, or burrows in the tissues of plants (fig. 3 b). Between these two

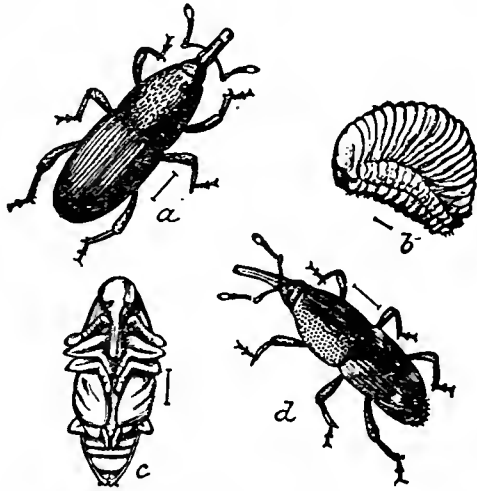

From Chittenden, Yearbook, 1894, U.S. Dept. of Agriculture.

FIG. 3.—Grain Weevils. a, *Calandra granaria*; b, larva; c, pupa; d, *C. oryzae*.

extremes we find various transitional forms: an active larva, as described above, but with four-segmented, single-clawed legs, as among the rove-beetles and their allies; the body well armoured, but slender and worm-like, with very short legs as in wireworms and mealworms (figs. 18, 21 b); the body shortened, with the abdomen swollen, but protected with tubercles and spines, and with longish legs adapted for an active life, as in the predaceous larvae of ladybirds; the body soft-skinned, swollen and caterpillar-like, with legs well developed, but leading a sluggish underground life, as in the grub of a chafer; the body soft-skinned and whitish, and the legs greatly reduced in size, as in the wood-feeding grub of a long-horn beetle. In the case of certain beetles whose larvae do not find themselves amid appropriate food from the moment of hatching, but have to migrate in search of it, an early larval stage, with legs, is followed by later sluggish stages in which legs have disappeared, furnishing examples of what is called hypermetamorphosis. For example, the grub of a pea or bean beetle (*Bruchus*) is hatched, from the egg laid by its mother on the carpel of a leguminous flower, with three pairs of legs and spiny processes on the prothorax. It bores through and enters the developing seed, where it undergoes a moult and becomes legless. Similarly the newly-hatched larva of an oil-beetle (*Meloe*) is an active little campodeiform insect, which, hatched from an egg laid among plants, waits to attach itself to a passing bee. Carried to the bee's nest, it undergoes a moult, and becomes a fat-bodied grub, ready to lead a quiet life feeding on the bee's rich food-stores.

Distribution and Habits.—The Coleoptera are almost world-wide in their distribution, being represented in the Arctic regions and on almost all oceanic islands. Most of the dominant families—such as the *Carabidae* (ground-beetles), *Scarabaeidae* (chafers), or *Curculionidae* (weevils) have a distribution as wide as the order. But while some large families, such as the *Staphylinidae* (rove-beetles) are especially abundant on the great northern continents, becoming scarcer in the tropics, others, the *Cicindelidae* (tiger-beetles), for example, are most strongly represented in the warmer regions of the earth, and become

scarce as the collector journeys far to south or north. The distribution of many groups of beetles is restricted in correspondence with their habits; the *Cerambycidae* (longhorns), whose larvae are wood-borers, are absent from timberless regions, and most abundant in the great tropical forests. Some families are very restricted in their range. The *Amphizoidae*, for example, a small family of aquatic beetles, are known only from western North America and Eastern Tibet, while an allied family, the *Pelobiidae*, inhabit the British Isles, the Mediterranean region, Tibet and Australia. The beetles of the British islands afford some very interesting examples of restricted distribution among species. For example, large and conspicuous European beetles, such as the stag-beetle (fig. 1, *Lucanus cervus*) and the great water-beetle (*Hydrophilus piceus*, fig. 20), are confined to eastern and southern Britain, and are unknown in Ireland. On the other hand, there are Arctic species like the ground-beetle, *Pelophila borealis*, and south-western species like the boring weevil, *Mesites Tardyi*, common in Ireland, and represented in northern or western Britain, but unknown in eastern Britain or in Central Europe. Careful study of insular faunas, such as that of Madeira by T. V. Wollaston, and of the Sandwich Islands by D. Sharp, and the comparison of the species found with those of the nearest continental land, furnish the student of geographical distribution with many valuable and suggestive facts.

Notes on habit are given below in the accounts of the various families. In general it may be stated that beetles live and feed in almost all the diverse ways possible for insects. There are carnivores, herbivores and scavengers among them. Various species among those that are predaceous attack smaller insects, hunt in packs crustaceans larger than themselves, insert their narrow heads into snail-shells to pick out and devour the occupants, or pursue slugs and earthworms underground. The vegetable-feeders attack leaves, herbaceous or woody stems and roots; frequently different parts of a plant are attacked in the two active stages of the life-history; the cockchafers, for example, eating leaves, and their grubs gnawing roots. Some of the scavengers, like the burying beetles, inter the bodies of small vertebrates to supply food for themselves and their larvae, or, like the "sacred" beetle of Egypt, collect for the same purpose stores of dung. Many beetles of different families have become the "unbidden guests" of civilized man, and may be found in dwelling-houses, stores and ships' cargoes, eating food-stuffs, paper, furniture, tobacco and drugs. Hence we find that beetles of some kind can hold their own anywhere on the earth's surface. Some climb trees and feed on leaves, while others tunnel between bark and wood. Some fly through the air, others burrow in the earth, while several families have become fully adapted to life in fresh water. A large number of beetles inhabit the deep limestone caves of Europe and North America, while many genera and some whole families are at home nowhere but in ants' nests. Most remarkable is the presence of a number of beetles along the seashore between tide-marks, where, sheltered in some secure nook, they undergo immersion twice daily, and have their active life confined to the few hours of the low ebb.

Stridulating Organs.—Many beetles make a hissing or chirping sound by rubbing a "scraper," formed by a sharp edge or prominence on some part of their exoskeleton, over a "file" formed by a number of fine ridges situate on an adjacent region. These stridulating organs were mentioned by C. Darwin as probable examples of the action of sexual selection; they are, however, frequently present in both sexes, and in some families also in the larvae. An account of the principal types of stridulators that have been described has been published by C. J. Gahan (1900). The file may be on the head—either upper or lower surface—and the scraper formed by the front edge of the prothorax, as in various wood-boring beetles (*Anobium* and *Scolytus*). Or ridged areas on the sides of the prothorax may be scraped by "files" on the front thighs, as in some ground-beetles. Among the longhorn beetles, the prothorax scrapes over a median file on the mid-dorsal aspect of the mesothorax. In a large number

of beetles of different families, stridulating areas occur on various segments of the abdomen, and are scraped by the elytra. It is remarkable that these organs are found in similar positions in genera belonging to widely divergent families, while two genera of the same family may have them in different positions. It follows, therefore, that they have been independently acquired in the course of the evolution of the Coleoptera.

Stridulating organs among beetle-larvae have been noted, especially in the wood-feeding grub of the stag-beetles (*Lucanidae*) and their allies the *Passalidae*, and in the dung-eating grubs of the dor-beetles (*Geotrupes*), which belong to the chafer family (*Scarabaeidae*). These organs are described by J. C. Schiödt and D. Sharp; in the stag-beetle larva a series of short tubercles on the hind-leg is drawn across the serrate edge of a plate on the haunch of the intermediate legs, while in the Passalid grub the modified tip of the hind-leg acts as a scraper, being so shortened that it is useless for locomotion, but highly specialized for producing sound. Whatever may be the true explanation of stridulating organs in adult beetles, sexual selection can have had nothing to do with the presence of these highly-developed larval structures. It has been suggested that the power of stridulation would be advantageous to wood-boring grubs, the sound warning each of the position of its neighbour, so that adjacent burrowers may not get in each other's way. The root-feeding larvae of the cockchafer and allied members of the *Scarabaeidae* have a ridged area on the mandible, which is scraped by teeth on the maxillae, apparently forming a stridulating organ.

Luminous Organs.—The function of the stridulating organs just described is presumably to afford means of recognition by sound. Some beetles emit a bright light from a portion of their bodies, which leads to the recognition of mate or comrade by sight. In the wingless female glow-worm (*Lampyris*, fig. 15f) the luminous region is at the hinder end, the organ emitting the light consisting, according to H. von Wielowiejski (1882), of cells similar to those of the fat-body, containing a substance that undergoes oxidation. The illumination is intermittent, and appears to be under the control of the insect's nervous system. The well-known "fire-flies" of the tropics are large click-beetles (*Elateridae*), that emit light from paired spots on the prothorax and from the base of the ventral abdominal region. The luminous organs of these beetles consist of a specialized part of the fat-body, with an inner opaque and an outer transparent layer. Its structure has been described by C. Heinemann, and its physiology by R. Dubois (1886), who considers that the luminosity is due to the influence of an enzyme in the cells of the organ upon a special substance in the blood. The eggs and larvae of the fire-flies are luminous as well as the perfect beetles.

Fossil History.—The Coleoptera can be traced back farther in time than any other order of insects with complete transformations, if the structures that have been described from the Carboniferous rocks of Germany are really elytra. In the Triassic rocks of Switzerland remains of weevils (*Curculionidae*) occur, a family which is considered by many students the most specialized of the order. And when we know that the *Chrysomelidae* and *Buprestidae* also lived in Triassic, and the *Carabidae*, *Elateridae*, *Cerambycidae* and *Scarabaeidae*, in Liassic times, we cannot doubt that the great majority of our existing families had already been differentiated at the beginning of the Mesozoic epoch. Coming to the Tertiary we find the Oligocene beds of Aix, of east Prussia (amber) and of Colorado, and the Miocene of Bavaria, especially rich in remains of beetles, most of which can be referred to existing genera.

Classification.—The Coleoptera have been probably more assiduously studied by systematic naturalists than any other order of insects. The number of described species can now hardly be less than 100,000, but there is little agreement as to the main principles of a natural classification. About eighty-five families are generally recognized; the difficulty that confronts the zoologists is the arrangement of these families in "superfamilies" or "sub-orders." Such obvious features as the number of

segments in the foot and the shape of the feeler were used by the early entomologists for distinguishing the great groups of beetles. The arrangement dependent on the number of tarsal segments—the order being divided into tribes *Pentamera*, *Tetramera*, *Heteromera* and *Trimeria*—was suggested by E. L. Geoffroy in 1762, adopted by P. A. Latreille, and used largely through the 19th century. W. S. Macleay's classification (1825), which rested principally on the characters of the larvae, is almost forgotten nowadays, but it is certain that in any systematic arrangement which claims to be natural the early stages in the life-history must receive due attention. In recent years classifications in part agreeing with the older schemes but largely original, in accord with researches on the comparative anatomy of the insects, have been put forward. Among the more conservative of these may be mentioned that of D. Sharp (1899), who divides the order into six great series of families: *Lamellicornia* (including the chafers and stag-beetles and their allies with five-segmented feet and plate-like terminal segments to the feelers); *Adephaga* (carnivorous, terrestrial and aquatic beetles, all with five foot-segments); *Polymorpha* (including a heterogeneous assembly of families that cannot be fitted into any of the other groups); *Heteromera* (beetles with the fore and intermediate feet five-segmented, and the hind-feet four-segmented); *Phytophaga* (including the leaf-beetles, and longhorns, distinguished by the apparently four-segmented feet), and *Rhynchophora* (the weevils and their allies, with head prolonged into a snout, and feet with four segments). L. Ganglbauer (1892) divides the whole order into two sub-orders only, the *Caraboidea* (the *Adephaga* of Sharp and the older writers) and the *Cantharidoidea* (including all other beetles), since the larvae of *Caraboidea* have five-segmented, two-clawed legs, while those of all other beetles have legs with four segments and a single claw. A. Lameere (1900) has suggested three sub-orders, the *Cantharidiformia* (including the *Phytophaga*, the *Heteromera*, the *Rhynchophora* and most of the *Polymorpha* of Sharp's classification), the *Staphyliniformia* (including the rove-beetles, carrion-beetles and a few allied families of Sharp's *Polymorpha*), and the *Carabidiformia* (*Adephaga*). Lameere's classification is founded on the number of abdominal sterna, the nervuration of the wings, the number of malpighian tubules (whether four or six) and other structural characters. Preferable to Lameere's system, because founded on a wider range of adult characters and taking the larval stages into account, is that of H. J. Kolbe (1901), who recognizes three sub-orders: (i.) the *Adephaga*; (ii.) the *Heterophaga*, including the *Staphylinoidae*, the *Actinorhabda* (*Lamellicornia*), the *Heterorhabda* (most of Sharp's *Polymorpha*), and the *Anchistopoda* (the *Phytophaga*, with the ladybirds and some allied families which Sharp places among the *Polymorpha*); (iii.) the *Rhynchophora*.

Students of the Coleoptera have failed to agree not only on a system of classification, but on the relative specialization of some of the groups which they all recognize as natural. Lameere, for example, considers some of his *Cantharidiformia* as the most primitive Coleoptera. J. L. Leconte and G. H. Horn placed the *Rhynchophora* (weevils) in a group distinct from all other beetles, on account of their supposed primitive nature. Kolbe, on the other hand, insists that the weevils are the most modified of all beetles, being highly specialized as regards their adult structure, and developing from legless maggots exceedingly different from the adult; he regards the *Adephaga*, with their active armoured larvae with two foot-claws, as the most primitive group of beetles, and there can be little doubt that the likeness between larvae and adult may safely be accepted as a primitive character among insects. In the Coleoptera we have to do with an ancient yet dominant order, in which there is hardly a family that does not show specialization in some point of structure or life-history. Hence it is impossible to form a satisfactory linear series.

In the classification adopted in this article, the attempt has been made to combine the best points in old and recent schemes, and to avoid the inconvenience of a large heterogeneous group including the vast majority of the families.

ADEPHAGA.—This tribe includes beetles of carnivorous habit with five segments on every foot, simple thread-like feelers with none of the segments enlarged to form club or pectination, and the outer lobes (galea) of the first maxilla usually two-segmented and paliform (fig. 4 b). The transverse fold of the hind-wing is towards the tip, about two-thirds of the wing-length from the base. At this fold the median nervure stops and is joined by a cross nervure to the radial, which can be distinguished throughout its length from the subcostal. There are four malpighian tubules. In the ovarian

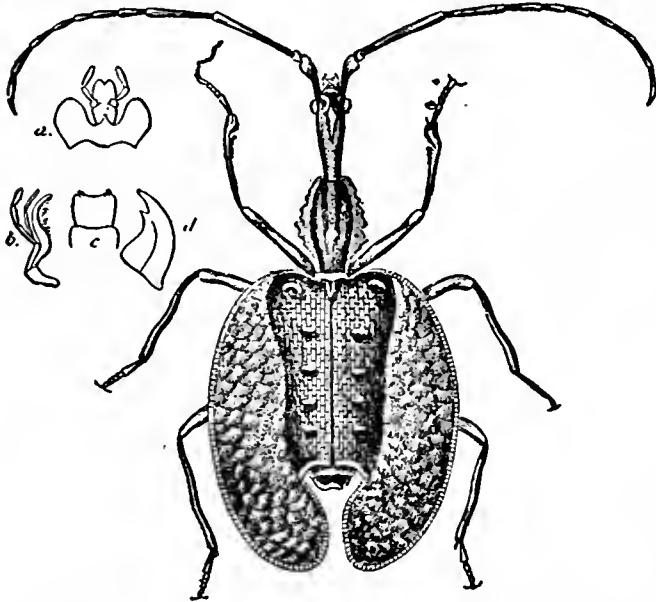

FIG. 4.—*Mormolyce phyllodes*. Java. a, Labium; b, maxilla; c, labrum; d, mandible.

tubes of Adephaga small yolk-chambers alternate with the egg-chambers, while in all other beetles there is only a single large yolk-chamber at the narrow end of the tube. The larvae (fig. 2 c) are active, with well-chitinized cuticle, often with elongate tail-feelers (cerci), and with five-segmented legs, the foot-segment carrying two claws.

The generalized arrangement of the wing-nervure and the nature of the larva, which is less unlike the adult than in other beetles, distinguish this tribe as primitive, although the perfect insects are, in the more dominant families, distinctly specialized. Two very small families of aquatic beetles seem to stand at the base of the series, the *Amphizoidae*, whose larvae are broad and well armoured with



FIG. 5.—*Pheropsophus Jurinei*. W. Africa.



FIG. 6.—*Carabus rutilans*. Spain.

short cerci, and the *Pelobiidae*, which have elongate larvae, tapering to the tail end, where are long paired cerci and a median process, recalling the grub of a Mayfly.

The *Dyticidae* (fig. 2) are Adephaga highly specialized for life in the water, the hind-legs having the segments short, broad and fringed, so as to be well adapted for swimming, and the feet without claws. The metasternum is without the transverse linear impression that is found in most families of Adephaga. The beetles are ovoid in shape, with smooth contours, and the elytra fit over the edges of the abdomen so as to enclose a supply of air, available for use when the insect remains under water: The fore-legs of many male dyticipids have the three proximal foot-segments broad and saucer-shaped, and

covered with suckers, by means of which they secure a firm hold of their mates. Larval dyticipids (fig. 2 b) possess slender, curved, hollow mandibles, which are perforated at the tip and at the base, being thus adapted for sucking the juices of victims. Large dyticipid larvae often attack small fishes and tadpoles. They breathe by piercing the surface film with the tail, where a pair of spiracles are situated. The pupal stage is passed in an earthen cell, just beneath the surface of the ground. Nearly 2000 species of *Dyticidae* are known: they are universally distributed, but are most abundant in cool countries. The *Haliphidae* form a small aquatic family allied to the *Dyticidae*.

The *Carabidae*, or ground-beetles, comprising 13,000 species, form



FIG. 7.—*Cicindela sylvatica* (Wood Tiger-Beetle). Europe.

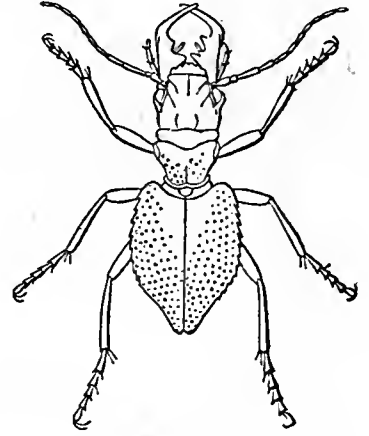
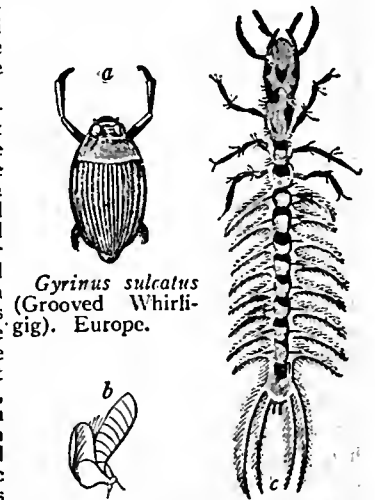

FIG. 8.—*Manticora tuberculata*. S. Africa.

the largest and most typical family of the Adephaga (figs. 4, 5, 6), the legs of all three pairs being alike and adapted for rapid running. In many *Carabidae* the hind-wings are reduced or absent, and the elytra fused together along the suture. Many of our native species spend the day lurking beneath stones, and sally forth at night in pursuit of their prey, which consists of small insects, earthworms and snails. But a number of the more brightly coloured ground-beetles run actively in the sunshine. The carabid larva is an active well-armoured grub with the legs and cerci variable in length. Great differences in the general form of the body may be observed in the family. For example, the stout, heavy body of *Carabus* (fig. 6) contrasts markedly with the wonderful flattened abdomen and elytra of *Mormolyce* (fig. 4), a Malayan genus found beneath fallen trees, a situation for which its compressed shape is admirably adapted. Blind *Carabidae* form a large proportion of cave-dwelling beetles, and several species of great interest live between tide-marks along the seashore.

The *Cicindelidae*, or tiger-beetles (figs. 7, 8) are the most highly organized of all the Adephaga. The inner lobe (lacinia) of the first maxilla terminates in an articulated hook, while in the second maxillae (labium) both inner and outer lobes ("figula" and "para-glossae") are much reduced. The face (clypeus) is broad, extending on either side in front of the insertion of the feelers. The beetles are elegant insects with long, slender legs, running quickly, and flying in the sunshine. The pronotum and elytra are often adorned with bright colours or metallic lustre, and marked with stripes or spots. The beetles are fierce in nature and predaceous in habit, their sharp toothed mandibles being well adapted for the capture of small insect-victims. The larvae are more specialized than those of other Adephaga, the head and prothorax being very large and broad, the succeeding segments slender and incompletely chitinized. The fifth abdominal segment has a pair of strong dorsal hook-like processes, by means of which the larva supports itself in the burrow which it excavates in the earth, the great head blocking the entrance with the mandibles ready to seize on any unwary insect that may venture within reach.

Two or three families may be regarded as aberrant Adephaga.



Antenna of Larva of *Gyrinus*. *Gyrinus*.

FIG. 9.

The *Paussidae* are a very remarkable family of small beetles, mostly tropical, found only in ants' nests, or flying by night, and apparently migrating from one nest to another. The number of antennal segments varies from eleven to two. It is supposed that these beetles secrete a sweet substance on which the ants feed, but they have been seen to devour the ants' eggs and grubs. The *Gyrinidae*, or whirligig beetles (fig. 9), are a curious aquatic family with the feelers (fig. 9, *b*) short and reduced as in most *Paussidae*. They are flattened oval in form, circling with gliding motion over the surface film of the water, and occasionally diving, when they carry down with them a bubble of air. The fore-legs are elongate and adapted for clasping, while the short and flattened intermediate and hind legs form very perfect oar-like propellers. The larva of *Gyrinus* (fig. 9, *c*) is slender with elongate legs, and the abdominal segments carry paired tracheal gills.

STAPHYLINOIDEA.—The members of this tribe may be easily recognized by their wing-nervature. Close to a transverse fold near the base of the wing, the median nervure divides into branches which extend to the wing-margin; there is a second transverse fold near the tip of the wing, and cross nervures are altogether wanting. There are four malpighian tubes, and all five tarsal segments are usually recognizable. With very few exceptions, the larva in this group is active and campodeiform, with cerci and elongate legs as in the Adephaga, but the leg has only four segments and one claw.



FIG. 10.—*Silpha quadripunctata*. Europe.



FIG. 11.—*Necrophorus respillo* (Sexton Beetle). Europe.

The *Silphidae*, or carrion beetles, form one of the best-known families of this group. They are rotund or elongate insects with conical front haunches, the elytra generally covering (fig. 10) the whole dorsal region of the abdomen, but sometimes leaving as many as four terga exposed (fig. 11). Some of these beetles are brightly coloured, while others are dull black. They are usually found in carrion, and the species of *Necrophorus* (fig. 11) and *Necrophaga* are valuable scavengers from their habit of burying small vertebrate carcasses which may serve as food for their larvae. At this work a number of individuals are associated together. The larvae that live underground have spiny dorsal plates, while those of the *Silpha* (fig. 10) and other genera that go openly about in search of food resemble wood-lice. About 1000 species of *Silphidae* are known. Allied to the *Silphidae* are a number of small and obscure families, for which reference must be made to monographs of the order. Of special interest among these are the *Histeridae*, compact beetles (fig. 12) with very hard cuticle and somewhat abbreviated elytra, with over 2000 species, most of which live on decaying matter, and



FIG. 12. *Hister iv-maculatus* (Mimic Beetle). Europe.



FIG. 13. *Oxyporus rufus*. Europe.



FIG. 14. *Stenus biguttatus*. Europe.

the curious little *Pselaphidae*, with three-segmented tarsi, elongate palpi, and shortened abdomen; the latter are usually found in ants' nests, where they are tended by the ants, which take a sweet fluid secreted among little tufts of hair on the beetles' bodies; these beetles, which are carried about by the ants, sometimes devour their larvae. The *Trichopterygidae*, with their delicate narrow fringed wings, are the smallest of all beetles, while the *Platyphylidae* consist of only a single species of curious form found on the beaver.

The *Staphylinidae*, or rove-beetles—a large family of nearly 10,000 species—may be known by their very short elytra, which cover only two of the abdominal segments, leaving the elongate hind-body with seven or eight exposed, firm terga (figs. 13, 14). These segments are very mobile, and as the rove-beetles run along they often curl the abdomen upwards and forwards like the tail of a scorpion. The *Staphylinid* larvae are typically campodeiform. Beetles and larvae are frequently carnivorous in habit, hunting for small insects under stones, or pursuing the soft-skinned grubs of

beetles and flies that bore in woody stems or succulent roots. Many *Staphylinidae* are constant inmates of ants' nests.

MALACODERMATA.—In this tribe may be included a number of families distinguished by the softness of the cuticle, the presence of seven or eight abdominal sterna and of four malpighian tubes, and the firm, well-armoured larva (fig. 15, *c*) which is often predaceous in habit. The mesothoracic epimera bound the coxal cavities of the intermediate legs. The *Lymexylonidae*, a small family of this group, characterized by its slender, undifferentiated feelers and feet, is believed by Lameere to comprise the most primitive of all living beetles, and Sharp lays stress on the undeveloped structure of the tribe generally.

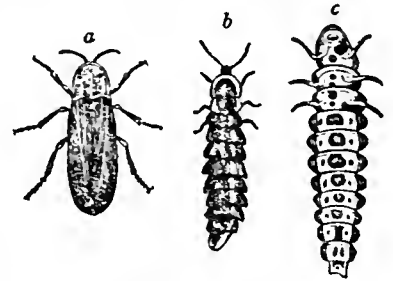

FIG. 15.—Glow-worm. *Lampyris noctiluca*. a, Male; b, female; c, larva (ventral view). Europe.

The *Lampyridae* are a large family, of which the glow-worm (*Lampyris*) and the "soldier beetles" (*Telephorus*) are familiar examples. The female "glow-worm" (fig. 15, *b*), emitting the well-known light (see above), is wingless and like a larva; the luminosity seems to be an attraction to the male, whose eyes are often exceptionally well developed. Some male members of the family have remarkably complex feelers. In many genera of *Lampyridae* the female can fly as well as the male; among these are the South European "fireflies."

TRICHODERMATA.—Several families of rather soft-skinned beetles, such as the *Melyridae*, *Cleridae* (fig. 16), *Corynetidae*, *Dermestidae* (fig. 17), and *Dascillidae*, are included in this tribe. They may be distinguished from the Malacodermata by the presence of only five or six abdominal sterna, while six malpighian tubes are present in some of the families. The beetles are hairy and their larvae well-armoured and often predaceous. Several species of *Dermestidae* are commonly found in houses, feeding on cheeses, dried meat, skins and other such substances. The "bacon beetle" (*Dermestes lardarius*), and its hard hairy larva, are well known. According to Sharp, all Dermestid larvae probably feed on dried animal matters; he mentions one species that can find sufficient food in the horsehair of furniture, and another that eats the dried insect-skins hanging in old cobwebs.



FIG. 16.—*Clerus apiarus* (Hive Beetle). Europe.

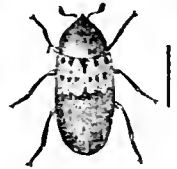

FIG. 17.—*Dermestes lardarius* (Bacon Beetle).

STERNONIA.—This is an important tribe of beetles, including families with four malpighian tubes and only five or six abdominal sterna, while in the thorax there is a backwardly directed process of the prosteronum that fits into a mesosternal cavity. The larvae are elongate and worm-like, with short legs but often with hard strong cuticle.

The *Elateridae* or click beetles (fig. 18) have the prosteronum process

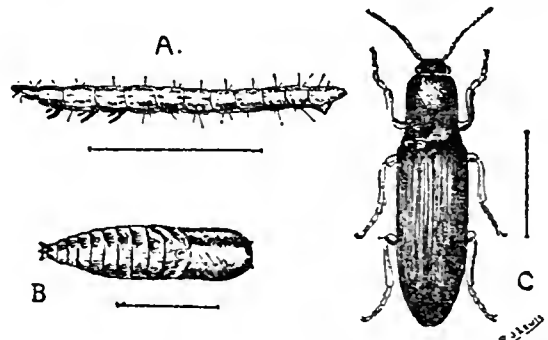

FIG. 18.—A, Wireworm; B, pupa of Click Beetle; C, adult Click Beetle (*Agriotes lineatum*).

just mentioned, capable of movement in and out of the mesosternal cavity, the beetles being thus enabled to leap into the air, hence their popular name of "click-beetles" or "skip-jacks." The prothorax is convex in front, and is usually drawn out behind into a prominent process on either side, while the elytra are elongate and tapering.

Many of the tropical American *Elateridae* emit light from the spots on the prothorax and an area beneath the base of the abdomen; these are "fireflies" (see above). The larvae of *Elateridae* are elongate, worm-like grubs, with narrow bodies, very firm cuticle, short legs, and a distinct anal proleg. They are admirably adapted for moving through the soil, where some of them live on decaying organic matter, while others are predaceous. Several of the elaterid larvae, however, gnaw roots and are highly destructive to farm crops. These are the well-known "wire-worms" (q.v.).

The *Buprestidae* are distinguished from the *Elateridae* by the immobility of the prosternal process in the mesosternal cavity and by the absence of the lateral processes at the hind corners of the prothorax. Many tropical *Buprestidae* are of large size (fig. 19), and exhibit magnificent metallic colours; their elytra are used as ornaments in human dress. The larvae are remarkable for their small head, very broad thorax, with reduced legs, and narrow elongate abdomen. They feed by burrowing in the roots and stems of plants.

BOSTRYCHOIDEA.—This tribe is distinguished from the Malacoderma and allied groups by the mesothoracic epimera not bounding the coxal cavities of the intermediate legs. The downwardly directed head is covered by the pronotum, and the three terminal antennal segments form a distinct club.

To this group belong the *Bostrychidae* and *Plinidae*, well known (especially the latter family) for their ravages in old timber. The larvae are stout and soft-skinned, with short legs in correlation with their burrowing habit. The noises made by some *Plinidae* (*Anobium*) tapping on the walls of their burrows with their mandibles give rise to the "death tick" that has for long alarmed the superstitious.

CLAVICORNIA.—This is a somewhat heterogeneous group, most of whose members are characterized by clubbed feelers and simple, unbroadened tarsal segments—usually five on each foot—but in some families and genera the males have less than the normal number on the feet of one pair. There are either four or six malpighian tubes. A large number of families, distinguished from each other by more or less trivial characters, are included here, and there is considerable diversity in the form of the larvae. The best-known family is the *Hydrophilidae*, in which the feelers are short with less than eleven segments and the maxillary palpi very long. Some members of this family—the large black *Hydrophilus piceus* (fig. 20), for example—are specialized for an aquatic life, the body being convex and smooth as in the *Dytiscidae*, and the intermediate and hind-legs fringed for swimming. When *Hydrophilus* dives it carries a supply of air between the elytra and the dorsal surface of the abdomen, while air is also entangled in the pubescence which extends beneath the abdomen on either side, being scooped in bubbles by the terminal segments of the feelers when the insect rises to the surface. Many of the *Hydrophilidae* construct, for the protection of their eggs, a cocoon formed of a silky material derived from glands opening at the tip of the abdomen. That of *Hydrophilus* is attached to a floating leaf, and is provided with a hollow, tapering process, which projects above the surface and presumably conveys air to the enclosed eggs. Other *Hydrophilidae* carry their egg-cocoons about with them beneath the abdomen. Many *Hydrophilidae*, unmodified for aquatic life,

inhabit marshes. The larvae in this family are well-armoured, active and predaceous. Of the numerous other families of the Clavicornia may be mentioned the *Cucujidae* and *Cryptophagidae*, small beetles, examples of which may be found feeding on stored seeds or vegetable refuse, and the *Mycetophagidae*, which devour fungi. The *Nitidulidae* are a large family with 1600 species, among which members of the genus *Meligethes* are often found in numbers feeding on blossoms, while others live under the bark of trees and prey on the grubs of boring beetles.

HETEROMERA.—This tribe is distinguished by the presence of the normal five segments in the feet of the fore and intermediate legs, while only four segments are visible in the hind-foot. Considerable diversity is to be noticed in details of structure within this group, and for an enumeration of all the various families which have been proposed and their distinguishing characters the reader is referred to one of the monographs mentioned below. Some of the best-known members of the group belong to the *Tenebrionidae*, a large

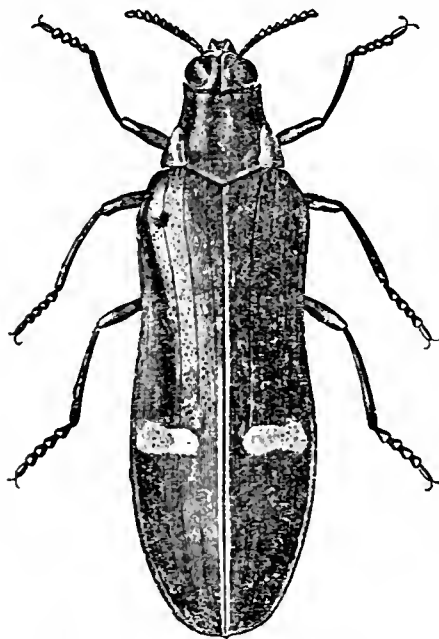

FIG. 19.—*Caloxantha bicolor*. Java.

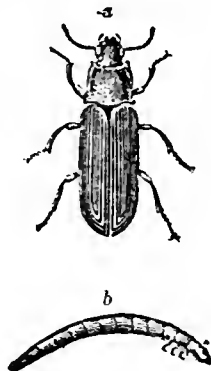

FIG. 21.—(a) *Tenebrio molitor* (Flour Beetle). Europe. (b) Larva, or mealworm.

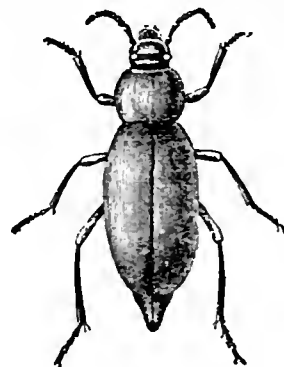

FIG. 22.—*Blaps mortisaga* (Churchyard Beetle). Europe.

family containing over 10,000 species and distributed all over the world. The tenebrionid larva is elongate, with well-chitinized cuticle, short legs and two stumpy tail processes, the common mealworm (fig. 21) being a familiar example. Several species of this family are found habitually in stores of flour or grain. The beetles have feelers with eleven segments, whereof the terminal few are thickened so as to form a club. The true "black-beetles" or "churchyard beetles" (*Blaps*) (fig. 22) belong to this family; like members of several allied genera they are sooty in colour, and somewhat resemble ground beetles (*Carabi*) in general appearance.

The most interesting of the Heteromera, and perhaps of all the Coleoptera, are some beetles which pass through two or more larval forms in the course of the life-history (hypermetamorphosis). These belong to the families *Rhipidophoridae* and *Meloidae*. The latter are the oil beetles (fig. 23) or blister beetles (fig. 24), insects with rather soft cuticle, the elytra (often abbreviated) not fitting closely to the sides of the abdomen, the head constricted behind the eyes to form

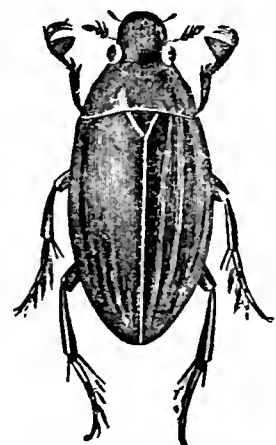

FIG. 20.—*Hydrophilus piceus* (Black Water Beetle). Europe.

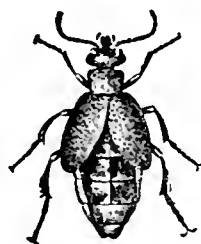

FIG. 23.—*Meloe proscarabaeus* (Oil Beetle). Europe.

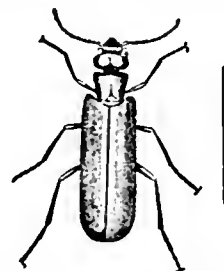

FIG. 24.—*Lytta vesicatoria* (Blister Beetle). Europe.

a neck, and the claws of the feet divided to the base. Several of the *Meloidae* (such as the "Spanish fly," fig. 24) are of economic importance, as they contain a vesicant substance used for raising medicinal blisters on the human skin. The wonderful transformations of these insects were first investigated by G. Newport in 1851, and have recently been more fully studied by C. V. Riley (1878) and J. H. Fabre. The first larval stage is the "triungulin," a tiny, active, armoured larva with long legs (each foot with three claws) and cercopods. In the European species of *Sitaris* and *Meloe* these little larvae have the instinct of clinging to any hairy object. All that do not happen to attach themselves to a bee of the genus *Anthophora* perish, but those that succeed in reaching the right host are carried to the nest, and as the bee lays an egg in the cell the triungulin slips off her body on to the egg, which floats on the surface of the honey. After eating the contents of the egg, the larva moults and becomes a fleshy grub with short legs and with paired spiracles close to the dorsal region, so that, as it floats in and devours the

honey, it obtains a supply of air. After a resting (pseudo-pupal) stage and another larval stage, the pupa is developed. In the American *Epicaula villata* the larva is parasitic on the eggs and egg-cases of a locust. The triangulin searches for the eggs, and, after a moult, becomes changed into a soft-skinned tapering larva. This is followed by a resting (pseudo-pupal) stage, and this by two successive larval stages like the grub of a chafer. The *Rhipidophoridae* are beetles with short elytra, the feelers pectinate in the males and serrate in the females. The life-history of *Meloeus* has been studied by T. A. Chapman, who finds that the eggs are laid in old wood, and that the triangulin seeks to attach itself to a social wasp, who carries it to her nest. There it feeds first as an internal parasite of the wasp-grub, then bores its way out, moults and devours the wasp larva from outside. The wasps are said to leave the larval or pupal *Meloeus* unmolested, but they are hostile to the developed beetles, which hasten to leave the nest as soon as possible.

STREPSIPTERA.—Much difference of opinion has prevailed with regard to the curious, tiny, parasitic insects included in this division, some authorities considering that they should be referred to a distinct order, while others would group them in the family *Meloidae* just described. While from the nature of their life-history there is no doubt that they have a rather close relationship to the *Meloidae*, their structure is so remarkable that it seems advisable to regard them as at least a distinct tribe of Coleoptera.

They may be comprised in a single family, the *Stylopidae*. The males are very small, free-flying insects with the prothorax, mesothorax and elytra greatly reduced, the latter appearing as little, twisted strips, while the metathorax is relatively large, with its wings broad and capable of longitudinal folding. The feelers are branched and the jaws vestigial. The female is a segmented, worm-like creature, spending her whole life within the body of the bee, wasp or bug on which she is parasitic. One end of her body protrudes from between two of the abdominal segments of the host; it has been a subject of dispute whether this protruded end is the head or the tail, but there can be little doubt that it is the latter. While thus carried about by the host-insect, the female is fertilized by the free-flying male, and gives birth to a number of tiny triangulin larvae. The chief points in the life-history of *Stylops* and *Xenos*, which are parasitic on certain bees (*Andrena*) and wasps (*Polistes*), have been investigated by K. T. E. von Siebold (1843) and N. Nessonov (1892). The little triangulins escape on to the body of the bee or wasp; then those that are to survive must leave their host for a non-parasitized insect. Clinging to her hairs they are carried to the nest, where they bore into the body of a bee or wasp larva, and after a moult become soft-skinned legless maggots. The growth of the parasitic larva does not stop the development of the host-larva, and when the latter pupates and assumes the winged form, the stylopid, which has completed its transformation, is carried to the outer world. The presence of a *Stylops* causes derangement in the body of its host, and can be recognized by various external signs. Other genera of the family are parasitic on Hemiptera—bugs and frog-hoppers—but nothing is known as to the details of their life-history.

LAMELLICORNIA.—This is a very well-marked tribe of beetles, characterized by the peculiar elongation and flattening of three or more of the terminal antennal segments, so that the feeler seems to end in a number of leaf-like plates, or small comb-teeth (fig. 26, b, c). The wings are well developed for flight, and there is a tendency in the group, especially among the males, towards an excessive development of the mandibles or the presence of enormous, horn-like processes on the head or pronotum. There are four malpighian tubes. The larvae are furnished with large heads, powerful mandibles and well-developed legs, but the body-segments are feebly chitinized, and the tail-end is swollen. They feed in wood or spend an underground life devouring roots or animal excrement.

The *Lucanidae* or stag beetles (figs. 1 and 25) have the terminal antennal segments pectinate, and so arranged that the comb-like part of the feeler cannot be curled up, while the elytra completely cover the abdomen. There are about 600 species in the family, the males being usually larger than the females, and remarkable for the size of their mandibles. In the same species, however, great variation occurs in the development of the mandibles, and the breadth of the head varies correspondingly, the smallest type of male being but little different in appearance from the female. The larvae of *Lucanidae* live within the wood of trees, and may take three or four years to attain their full growth. The *Passalidae* are a tropical family of beetles generally considered to be intermediate between stag-beetles and chafers, the enlarged segments of the feeler being capable of close approximation.

The *Scarabaeidae* or chafers are an enormous family of about 15,000 species. The plate-like segments of the feeler (fig. 26, b, c) can be brought close together so as to form a club-like termination; usually the hinder abdominal segments are not covered by the elytra. In this family there is often a marked divergence between the sexes; the terminal antennal segments are larger in the male than in the female, and the males may carry large spinous processes on the head or prothorax, or both. These structures were believed by C. Darwin to be explicable by sexual selection. The larvae have the three pairs of legs well developed, and the hinder abdominal segments swollen. Most of the *Scarabaeidae* are vegetable-feeders, but one section

of the family—represented in temperate countries by the dor-beetles (*Geotrupes*) (fig. 28) and *Aphodius*, and in warmer regions by the "sacred" beetles of the Egyptians (*Scarabaeus*) (fig. 27), and allied genera—feed both in the adult and larval stages, on dung or decaying animal matter. The heavy grubs of *Geotrupes*, their

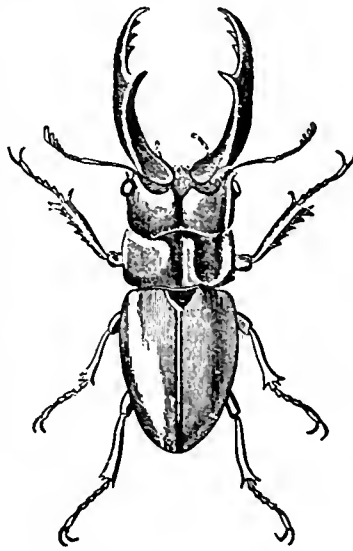

FIG. 25.—*Cladognathus cinnamomeus*. Java.



FIG. 26.—*Melolontha fulva* (Cockchafer). S. Europe. b, Antenna of male; c, antenna of female.

swollen tail-ends black with the contained food-material, are often dug up in numbers in well-manured fields. The habits of *Scarabaeus* have been described in detail by J. H. Fabre. The female beetle in spring-time collects dung, which she forms into a ball by continuous rolling, sometimes assisted by a companion. This ball is buried in a suitable place, and serves the insect as a store of food. During summer the insects rest in their underground retreats, then in autumn



FIG. 27.—*Scarabaeus Aegyptiorum*. Africa.



FIG. 28.—*Geotrupes Blackburnei*. N. America.

they reappear to bury another supply of dung, which serves as food for the larvae. Fabre states that the mother-insect carefully arranges the food-supply so that the most nutritious and easily digested portion is nearest the egg, to form the first meal of the young larva. In some species of *Copris* it is stated that the female



FIG. 29.—*Phaneus Imperator*. S. America.

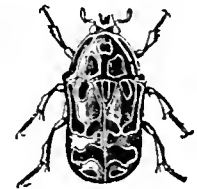

FIG. 30.—*Cetonia Baxii*. W. Africa.

lays only two or three eggs at a time, watching the offspring grow to maturity, and then rearing another brood.

Among the vegetable-feeding chafers we usually find that while the perfect insect devours leaves, the larva lives underground and feeds on roots. Such are the habits of the cockchafer (*Melolontha vulgaris*) and other species that often cause great injury to farm and

garden crops (see CHAFER). Many of these insects, such as the species of *Phanaeus* (fig. 29) and *Cetonia* (fig. 30), are adorned with metallic or other brilliant colours. The African "goliath-beetles" (fig. 31) and the American "elephant-beetles" (*Dynastes*) are the largest of all insects.

ANCHISTOPODA.—The families of beetles included by Kolbe in this group are distinguished by the possession of six malpighian tubes, and a great reduction in one or two of the tarsal segments, so that there seem to be only four or three segments in each foot; hence the names *Tetramera* and *Trimera* formerly applied to them. The larvae have soft-skinned bodies sometimes protected by rows of spiny tubercles, the legs being fairly developed in some families and greatly

segments to the foot, but there are really five, the fourth being greatly reduced. The mandibles are strong, adapted for biting the vegetable substances on which these beetles feed, and the palps of the second maxillae have three segments. Most of the *Chrysomelidae* are metallic in colour and convex in form; in some the head is concealed beneath the prothorax, and the so-called "tortoise" beetles (*Cassidinae*) have the elytra raised into a prominent median ridge. The most active form of larva found in this family resembles in shape that of a ladybird, tapering towards the tail end, and having the trunk segments protected by small firm sclerites. Such larvae, and also many with soft cuticle and swollen abdomen—those of the notorious "Colorado beetle," for example—feed openly

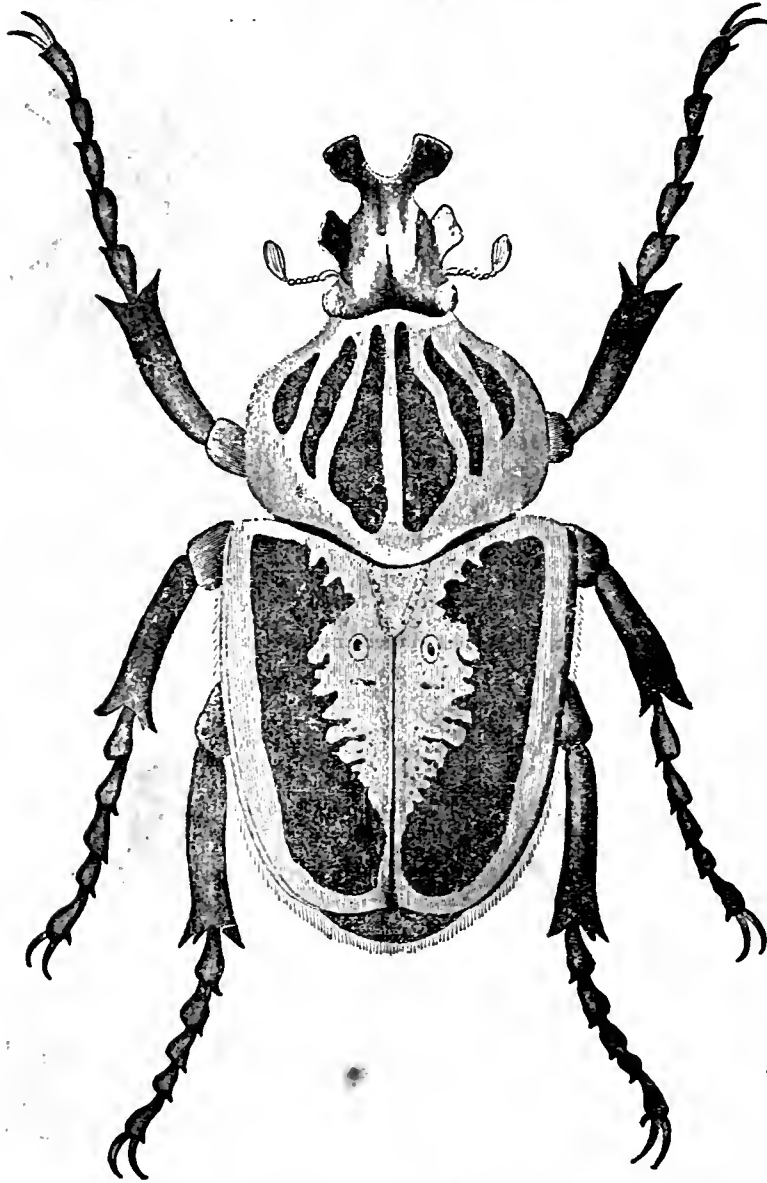

FIG. 31.—*Goliathus giganteus* (Goliath Beetle).

reduced or absent in others. As might be expected, degeneration in larval structure is correlated with a concealed habit of life.

The *Coccinellidae*, or ladybirds (fig. 32), are a large family of beetles, well known by their rounded convex bodies, usually shining and hairless. They have eleven segments to the feeler, which is clubbed at the tip, and apparently three segments only in each foot. Ladybirds are often brightly marked with spots and dashes, their coloration being commonly regarded as an advertisement of inedibility. The larvae have a somewhat swollen abdomen, which is protected by bristle-bearing tubercles. Like the perfect insects, they are predaceous, feeding on plant-lice (*Aphidae*) and scale insects (*Coccidae*). Their rôle in nature is therefore beneficial to the cultivator. The *Endomychidae* (fig. 33), an allied family, are mostly fungus-eaters. In the *Erotylidae* and a few other small related families the feet are evidently four-segmented.

The *Chrysomelidae*, or leaf-beetles (figs. 34, 35), are a very large family, with "tetramerous" tarsi; there seem to be only four



FIG. 32.—*Anatio ocellata* (Eyed Ladybird). Europe.

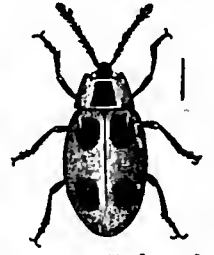

FIG. 33.—*Endomychus coccineus*. Europe



FIG. 34.—*Sagra cyanica*. W. Africa.



FIG. 35.—*Eumorphus in-guttatus*. Sumatra

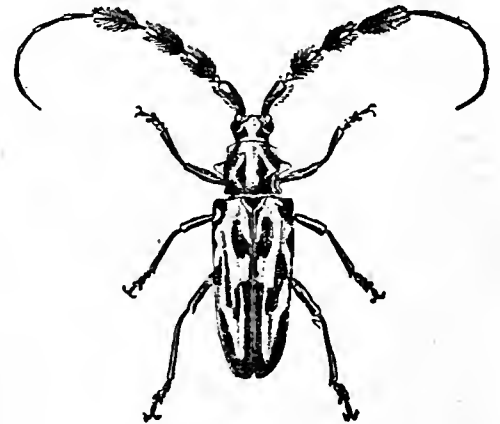

FIG. 36.—*Lophonocerus barbicornis*. S. America.

on foliage. Others, with soft, white, cylindrical bodies, which recall the caterpillars of moths, burrow in the leaves or stems of plants. The larvae of the tortoise-beetles have the curious habit of forming an umbrella-like shield out of their own excrement, held in position by the upturned tail-process. The larvae of the beautiful, elongate, metallic *Donaciae* live in the roots and stems of aquatic plants, obtaining thence both food and air. The larva pierces the vessels of the plant with sharp processes at the hinder end of its body. In this way it is believed that the sub-aqueous cocoon in which the pupal stage is passed becomes filled with air.

The *Cerambycidae*, or longhorn beetles, are recognizable by their slender, elongate feelers, which are never clubbed and rarely serrate. The foot has apparently four segments, as in the *Chrysomelidae*. The beetles are usually elongate and elegant in form, often adorned with bright bands of colour, and some of the tropical species attain a very large size (figs. 36, 37). The feelers are usually longer in the male than in the female, exceeding in some cases by many times the

length of the body. The larvae have soft, fleshy bodies, with the head and prothorax large and broad, and the legs very much reduced. They live and feed in the wood of trees. Consequently, beetles of this family are most abundant in forest regions, and reach their highest development in the dense virgin forests of tropical countries, South America being particularly rich in peculiar genera.

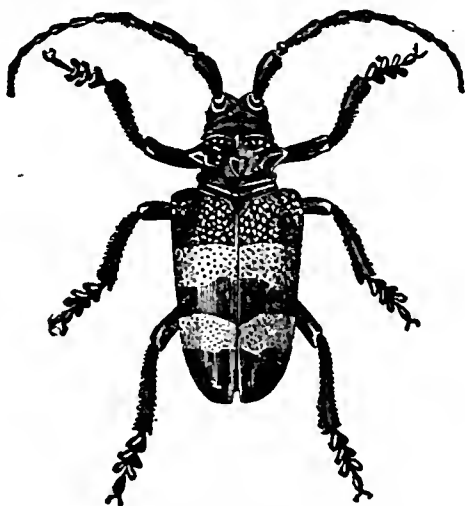

FIG. 37.—*Phryneta aurocincta*. West Africa.

The *Bruchidae*, or seed-beetles, agree with the two preceding families in tarsal structure; the head is largely hidden by the pronotum, and the elytra are short enough to leave the end of the abdomen exposed (fig. 38). The development of the pea and bean-beetles has been carefully studied by C. V. Riley, who finds that the young larva, hatched from the egg laid on the pod, has three pairs of legs, and that these are lost after the moult that occurs when the grub has bored its way into the seed. In Great Britain the beetle, after completing its development, winters in the seed, waiting to emerge and lay its eggs on the blossom in the ensuing spring.



FIG. 38.—*Bruchus pici* (Pea Beetle.) Europe.



FIG. 39.—*Platyrhinus latirostris*. Europe.

RHYNCHOPHORA.—The *Rhynchophora* are a group of beetles easily recognized by the elongation of the head into a beak or snout, which carries the feelers at its sides and the jaws at its tip. The third tarsal segment is broad and bi-lobed, and the fourth is so small that the feet seem to be only four-segmented. There are six malpighian tubes. The ventral sclerite of the head-skeleton (gula), well developed in most families of beetles, is absent among the *Rhynchophora*, while the palps of the maxillae are much reduced. The larvae have soft, white bodies and, with very few exceptions, no legs.



FIG. 40.—*Brenthius anchorago*. Tropical Countries.

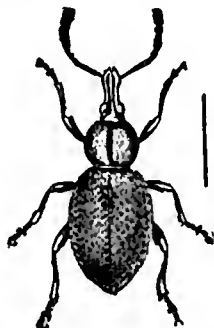

FIG. 41.—*Otiorrhynchus ligustici*. Europe.

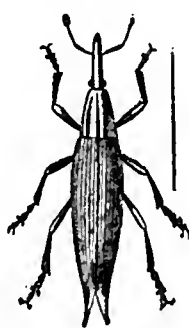

FIG. 42.—*Lixus paraplecticus*. Europe.

Of the four families included in this group, the *Anthribidae* (fig. 39) have jointed, flexible palps, feelers—often of excessive length—with a short basal segment, and the three terminal segments forming

a club, and, in some genera, larvae with legs. There are nearly 1000 known species, most of which live in tropical countries. The *Brenthidae* are a remarkable family almost confined to the tropics; they are elongate and narrow in form (fig. 40), with a straight, cylindrical snout which in some male beetles of the family is longer than the rest of the body.

The *Curculionidae*, or weevils (*q.v.*), comprising 23,000 species, are by far the largest family of the group. The maxillary palps are short and rigid, and there is no distinct labrum, while the feelers are usually of an "elbowed" form, the basal segment being very elongate (figs. 41, 42). They are vegetable feeders, both in the perfect and larval stages, and are often highly injurious. The female uses her snout as a boring instrument to prepare a suitable place for egg-laying. The larvae (fig. 3) of some weevils live in seeds; others devour roots, while the parent-beetles eat leaves; others, again, are found in wood or under bark. The *Scolytidae*, or bark-beetles, are a family of some 1500 species, closely allied to the *Curculionidae*, differing only in the feeble development of the snout. They have clubbed feelers, and their cylindrical bodies (fig. 43) are well adapted for their burrowing habits under the bark of trees. Usually the mother-beetle makes a fairly straight tunnel along which, at short intervals, she lays her eggs. The grubs, when hatched, start galleries nearly at right angles to this, and when fully grown form oval cells in which they pupate; from these the young beetles emerge by making circular holes directly outward through the bark.



FIG. 43.—*Scolytus ulmi*. (Bark Beetle). Europe.

BIBLIOGRAPHY.—In addition to what may be found in numerous important works on the Hexapoda (*q.v.*) as a whole, such as J. O. Westwood's *Modern Classification of Insects*, vol. i. (London, 1838); J. H. Fabre's *Souvenirs Entomologiques* (Paris, 1879-1891); D. Sharp's contribution to the Cambridge Natural History (vol. vi., London, 1899); and L. C. Miall's *Aquatic Insects* (London, 1895), the special literature of the *Coleoptera* is enormous. Classical anatomical memoirs are those of L. Dufour (Ann. Sci. Nat. ii., iii., iv., vi., viii., xiv., 1824-1828); *Ib.* (ser. 2, Zool.) i., 1834; and H. E. Strauss-Dürkheim, *Anatomie comparée des animaux articulés* (Paris, 1828).

The wings of *Coleoptera* (including the elytra) are described and discussed by F. Meinert (*Entom. Tijdskr.* v., 1880); C. Hoffbauer (*Zeit. f. wissen. Zool.* liv., 1892); J. H. Comstock and J. G. Needham (*Amer. Nat.* xxxii., 1898); and W. L. Tower (*Zool. Jahrb. Anat.* xvii., 1903). The morphology of the abdomen, ovipositor and genital armature is dealt with by K. W. Verhoeff (*Ent. Nachr.* xx., 1894, and *Arch. f. Naturg.* lxi., lxii., 1895-1896); and B. Wandolleck (*Zool. Jahrb. Anat.* xxii., 1905).

Luminous organs are described by H. von Wielowiejski (*Zeits. f. wissen. Zool.* xxxvii., 1882); C. Heinemann (*Arch. f. mikr. Anat.* xxvii., 1886); and R. Dubois (*Bull. soc. zool. France*, 1886); and stridulating organs by C. J. Gahan (*Trans. Entom. Soc.*, 1900). See also C. Darwin's *Descent of Man and Selection in Relation to Sex* (London, 1871).

Many larvae of *Coleoptera* are described and beautifully figured by J. C. Schiöde (*Naturh. Tidsskr.* i.-xiii., 1861-1872). Hypermetamorphosis in the *Meloidae* is described by G. Newport (*Trans. Linn. Soc.* xx., xxi., 1851-1853); C. V. Riley (*Rep. U.S. Entom. Comm.* i., 1878); J. H. Fabre (*Ann. Sci. Nat.* (4), ix., xix., 1848-1853); H. Beauregard (*Les Insectes vésicants*, Paris, 1890); and A. Chabaud (*Ann. Soc. Ent. France*, lx., 1891); in the *Bruchidae* by Riley (*Insect Life*, iv., v., 1892-1893); and in the *Strepsiptera* (*Stylopidae*) by K. T. E. von Siebold (*Arch. f. Naturg.* ix., 1843); N. Nasonov (*Bull. Univ. Narovie*, 1892); and C. T. Brues (*Zool. Jahrb. Anat.* xiii., 1903).

For various schemes of classification of the *Coleoptera* see E. L. Geoffroy (*Insectes qui se trouvent aux environs de Paris*, Paris, 1762); A. G. Olivier (*Coléoptères*, Paris, 1789-1808); W. S. MacLeay (*Annulosa Javanica*, London, 1825); the general works of Westwood and Sharp, mentioned above; M. Gemminger and B. de Harold (*Catalogus Coleopterorum*, 12 vols., Munich, 1868-1872); T. Lacordaire and F. Chapuis (*Genera des Coléoptères*, 10 vols., Paris, 1854-1874); J. L. Leconte and G. H. Horn (*Classification of Coleoptera of N. America*, Washington, Smithsonian Inst., 1883); L. Ganglbauer (*Die Käfer von Mitteleuropa*, Vienna, 1892, &c.); A. Lameere (*Ann. Soc. Ent. Belg.* xlv., xlvii., 1900-1903); and H. J. Kolbe (*Arch. f. Naturg.* lxxvii., 1901).

For the British species, W. W. Fowler (*Coleoptera of the British Islands*, 5 vols., London, 1887-1891) is the standard work; and W. F. Johnson and J. N. Halbert's "Beetles of Ireland" (*Proc. R. Irish Acad.*, 3, vi., 1902) is valuable faunistically. Among the large number of systematic writers on the order generally, or on special families, may be mentioned D. Sharp, T. V. Wollaston, H. W. Bates, G. C. Champion, E. Reitter, G. C. Crotch, H. S. Gorham, M. Jacoby, L. Fairmaire and C. O. Waterhouse. (G. H. C.)

COLEPEPER, JOHN COLEPEPER (or **CULPEPPER**), 1st BARON (d. 1660), English politician, was the only son of Sir John Colepeper of Wigsell, Sussex. He began his career in

military service abroad, and came first into public notice at home through his knowledge of country affairs, being summoned often before the council board to give evidence on such matters. He was knighted, and was elected member for Kent in the Long Parliament, when he took the popular side, speaking against monopolies on the 9th of November 1640, being entrusted with the impeachment of Sir Robert Berkeley on the 12th of February 1641, supporting Strafford's attainder, and being appointed to the committee of defence on the 12th of August 1641. He separated, however, from the popular party on the Church question, owing to political rather than religious objections, fearing the effect of the revolutionary changes which were now contemplated. He opposed the London petition for the abolition of episcopacy, the project of religious union with the Scots, and the Root and Branch Bill, and on the 1st of September he moved a resolution in defence of the prayer-book. In the following session he opposed the militia bill and the Grand Remonstrance, and finally on the 2nd of January 1642 he joined the king's party, taking office as chancellor of the exchequer. He highly disapproved of the attempt upon the five members, which was made without his knowledge, but advised the enterprise against Hull. On the 25th of August 1642 he appeared at the bar of the House of Commons to deliver the king's final proposals for peace, and was afterwards present at Edgehill, where he took part in Prince Rupert's charge and opposed the retreat of the king's forces from the battlefield. In December he was made by Charles master of the rolls. He was a leading member of the Oxford Parliament, and was said, in opposition to the general opinion, to have counselled considerable concessions to secure peace. His influence in military affairs caused him to be much disliked by Prince Rupert and the army, and the general animosity against him was increased by his advancement to the peerage on the 21st of October 1644 by the title of Baron Colepeper of Thoresway in Lincolnshire.

He was despatched with Hyde in charge of the prince of Wales to the West in March 1645, and on the 2nd of March 1646, after Charles's final defeat, embarked with the prince for Scilly, and thence to France. He strongly advocated the gaining over of the Scots by religious concessions, a policy supported by the queen and Mazarin, but opposed by Hyde and other leading royalists, and constantly urged this course upon the king, at the same time deprecating any yielding on the subject of the militia. He promoted the mission of Sir John Berkeley in 1647 to secure an understanding between Charles and the army. In 1648 he accompanied the prince in his unsuccessful naval expedition, and returned with him to the Hague, where violent altercations broke out among the royalist leaders, Colepeper going so far, on one occasion in the council, as to challenge Prince Rupert, and being himself severely assaulted in the streets by Sir Robert Walsh. He continued after the execution of the king to press the acceptance on Charles II. of the Scottish proposals. He was sent to Russia in 1650, where he obtained a loan of 20,000 roubles from the tsar, and, soon after his return, to Holland, to procure military assistance. By the treaty, agreed to between Cromwell and Mazarin, of August 1654, Colepeper was obliged to leave France, and he appears henceforth to have resided in Flanders. He accompanied Charles II. to the south of France in September 1659, at the time of the treaty of the Pyrenees. At the Restoration he returned to England, but only survived a few weeks, dying on the 11th of June 1660.

Several contemporary writers agree in testifying to Colepeper's great debating powers and to his resources as an adviser, but complain of his want of stability and of his uncertain temper. Clarendon, with whom he was often on ill terms, speaks generally in his praise, and repels the charge of corruption levelled against him. That he was gifted with considerable political foresight is shown by a remarkable letter written on the 20th of September 1658 on the death of Cromwell, in which he foretells with uncommon sagacity the future developments in the political situation, advises the royalists to remain inactive till the right moment and profit by the division of their opponents, and distinguishes Monck as the one person willing and capable of

effecting the Restoration (*Clarendon State Papers*, iii. 412). Colepeper was twice married, (1) to Philippa, daughter of Sir John Snelling, by whom he had one son, who died young, and a daughter, and (2) to Judith, daughter of Sir J. Colepeper of Hollingbourn, Kent, by whom he had seven children. Of these Thomas (d. 1719; governor of Virginia 1680-1683) was the successor in the title, which became extinct on the death of his younger brother Chency in 1725. (P. C. Y.)

COLERAINE, a seaport and market town of Co. Londonderry, Ireland, in the north parliamentary division, on the Bann, 4 m. from its mouth, and 61½ m. N.W. by N. from Dublin by the Northern Counties (Midland) railway. Pop. of urban district (1901) 6958. The town stands upon both sides of the river, which is crossed by a handsome stone bridge, connecting the town and its suburb, Waterside or Killowen. The principal part is on the east bank, and consists of a central square called the Diamond, and several diverging streets. Among institutions may be mentioned the public schools founded in 1613 and maintained by the Honourable Irish Society, and the Academical Institution, maintained by the Irish Society and the London Clothworkers' Company. The linen trade has long been extensively carried on in the town, from which, indeed, a fine description of cloth is known as "Coleraines." Whisky-distilling, pork-curing, and the salmon and eel fisheries are prosecuted. The mouth of the river was formerly obstructed by a bar, but piers were constructed, and the harbours greatly improved by grants from the Irish Society of London and from a loan under the River Bann Navigation Act 1879. Coleraine ceased to return one member to the Imperial parliament in 1885; having previously returned two to the Irish parliament until the Union. It was incorporated by James I. It owed its importance mainly to the Irish Society, which was incorporated as the Company for the New Plantation of Ulster in 1613. Though fortified only by an earthen wall, it managed to hold out against the rebels in 1641. There are no remains of a former priory, monastery and castle. A Rath or encampment of large size occupies Mount Sandel, 1 m. south-east.

COLERIDGE, HARTLEY (1796-1849), English man of letters, eldest son of the poet Samuel Taylor Coleridge, was born on the 19th of September 1796, near Bristol. His early years were passed under Southey's care at Greta Hall, Keswick, and he was educated by the Rev. John Dawes at Ambleside. In 1815 he went to Oxford, as scholar of Merton College. His university career, however, was very unfortunate. He had inherited the weakness of purpose, as well as the splendid conversational powers, of his father, and lapsed into habits of intemperance. He was successful in gaining an Oriel fellowship, but at the close of the probationary year (1820) was judged to have forfeited it. The authorities could not be prevailed upon to reverse their decision; but they awarded to him a free gift of £300. Hartley Coleridge then spent two years in London, where he wrote short poems for the *London Magazine*. His next step was to become a partner in a school at Ambleside, but this scheme failed. In 1830 a Leeds publisher, Mr. F. E. Bingley, made a contract with him to write biographies of Yorkshire and Lancashire worthies. These were afterwards republished under the title of *Biographia Borealis* (1833) and *Worthies of Yorkshire and Lancashire* (1836). Bingley also printed a volume of his poems in 1833, and Coleridge lived in his house until the contract came to an end through the bankruptcy of the publisher. From this time, except for two short periods in 1837 and 1838 when he acted as master at Sedbergh grammar school, he lived quietly at Grasmere and (1840-1849) Rydal, spending his time in study and wanderings about the countryside. His figure was as familiar as Wordsworth's, and his gentleness and simplicity of manner won for him the friendship of the country-people. In 1839 appeared his edition of Massinger and Ford, with biographies of both dramatists. The closing decade of Coleridge's life was wasted in what he himself calls "the woeful impotence of weak resolve." He died on the 6th of January 1849. The prose style of Hartley Coleridge is marked by much finish and vivacity; but his literary reputation must chiefly rest on the

sanity of his criticisms, and above all on his *Prometheus*, an unfinished lyric drama, and on his sonnets. As a sonneteer he achieved real excellence, the form being exactly suited to his sensitive genius. *Essays and Marginalia*, and *Poems*, with a memoir by his brother Derwent, appeared in 1851.

COLERIDGE, JOHN DUKE COLERIDGE, 1ST BARON (1820–1894), lord chief justice of England, was the eldest son of Sir John Taylor Coleridge. He was born at Heath's Court, Ottery St Mary, on the 3rd of December 1820. He was educated at Eton and Balliol College, Oxford, of which he was a scholar. He was called to the bar in 1846, and went the western circuit, rising steadily, through more than twenty years of hard work, till in 1865 he was returned as member for Exeter in the Liberal interest. The impression which he made on the heads of his party was so favourable that they determined, early in the session of 1867, to put him forward as the protagonist of their attack on the Conservative government. But that move seemed to many of their staunchest adherents unwise, and it was frustrated by the active opposition of a section, including Hastings Russell (later ninth duke of Bedford), his brother Arthur, member for Tavistock, Alexander Mitchell of Stow, A. W. Kinglake and Henry Seymour. They met to deliberate in the tea-room of the House, and were afterwards sometimes confounded with the tea-room party which was of subsequent formation and under the guidance of a different group. The protest was sufficient to prevent the contemplated attack being made, but the Liberals returned to power in good time with a large majority behind them in 1868. Coleridge was made, first solicitor-, and then attorney-general.

As early as 1863 a small body of Oxford men in parliament had opened fire against the legislation which kept their university bound by ecclesiastical swaddling clothes. They had made a good deal of progress in converting the House of Commons to their views before the general election of 1865. That election having brought Coleridge into parliament, he was hailed as a most valuable ally, whose great university distinction, brilliant success as an orator at the bar, and hereditary connexion with the High Church party, entitled him to take the lead in a movement which, although gathering strength, was yet very far from having achieved complete success. The clerically-minded section of the Conservative party could not but listen to the son of Sir John Coleridge, the godson of Keble, and the grand-nephew of the man who had been an indirect cause of the Anglican revival of 1833,—for John Stuart Mill was right when he said that the poet Coleridge and the philosopher Bentham were, so far as England was concerned, the leaders of the two chief movements of their times: "it was they who taught the teachers, and who were the two great seminal minds."

Walking up one evening from the House of Commons to dine at the Athenaeum with Henry Bruce (afterwards Lord Aberdare) and another friend, Coleridge said: "There is a trial coming on which will be one of the most remarkable *causes célèbres* that has ever been heard of." This was the Tichborne case, which led to proceedings in the criminal courts rising almost to the dignity of a political event. The Tichborne trial was the most conspicuous feature of Coleridge's later years at the bar, and tasked his powers as an advocate to the uttermost, though he was assisted by the splendid abilities and industry of Charles (afterwards Lord) Bowen. In November 1873 Coleridge succeeded Sir W. Bovill as chief justice of the common pleas, and was immediately afterwards raised to the peerage as Baron Coleridge of Ottery St Mary. In 1880 he was made lord chief justice of England on the death of Sir Alexander Cockburn.

In jury cases his quickness in apprehending facts and his lucidity in arranging them were very remarkable indeed. He was not one of the most learned of lawyers, but he was a great deal more learned than many people believed him to be, and as an ecclesiastical lawyer had perhaps few or no superiors. His fault—a natural fault in one who had been so successful as an advocate—was that of being too apt to take one side. He allowed, also, certain political or personal prepossessions to colour the tone of his remarks from the bench. A game-preserving

landlord had not to thank the gods when his case, however buttressed by generally accepted claims, came before Coleridge. Towards the end of his life his health failed, and he became somewhat indolent. On the whole, he was not so strong a man in his judicial capacity as Campbell or Cockburn; but it must be admitted that his scholarship, his refinement, his power of oratory, and his character raised the tone of the bench while he sat upon it, and that if it has been adorned by greater judicial abilities, it has hardly ever known a greater combination of varied merits. It is curious to observe that of all judges the man whom he put highest was one very unlike himself, the great master of the rolls, Sir William Grant. Coleridge died in harness on the 14th of June 1894.

Coleridge's work, first as a barrister, and then as a judge, prevented his publishing as much as he otherwise would have done, but his addresses and papers would, if collected, fill a substantial volume and do much honour to his memory. One of the best, and one most eminently characteristic of the man, was his inaugural address to the Philosophical Institution at Edinburgh in 1870; another was a paper on Wordsworth (1873). He was an exceptionally good letter-writer. Of travel he had very little experience. He had hardly been to Paris; once, quite near the end of his career, he spent a few days in Holland, and came back a willing slave to the genius of Rembrandt; but his longest absence from England was a visit, which had something of a representative legal character, to the United States. It is strange that a man so steeped in Greek and Roman poetry, so deeply interested in the past, present and future of Christianity, never saw Rome, or Athens, or the Holy Land. A subsidiary cause, no doubt, was the fatal custom of neglecting modern languages at English schools. He felt himself at a disadvantage when he passed beyond English-speaking lands, and cordially disliked the situation. No notice of Coleridge should omit to make mention of his extraordinary store of anecdotes, which were nearly always connected with Eton, Oxford, the bar or the bench. His exquisite voice, considerable power of mimicry, and perfect method of narration added greatly to the charm. He once told, at the table of Dr Jowett, master of Balliol, anecdotes through the whole of dinner on Saturday evening, through the whole of breakfast, lunch and dinner the next day, through the whole journey on Monday morning from Oxford to Paddington, without ever once repeating himself. He was frequently to be seen at the Athenaeum, was a member both of Grillion's and The Club, as well as of the Literary Society, of which he was president, and whose meetings he very rarely missed. Bishop Copleston is said to have divided the human race into three classes,—men, women and Coleridges. If he did so, he meant, no doubt, to imply that the family of whom the poet of *Christabel* was the chief example regarded themselves as a class to themselves, the objects of a special dispensation. John Duke Coleridge was sarcastic and critical, and at times over-sensitive. But his strongest characteristics were love of liberty and justice. By birth and connexions a Conservative, he was a Liberal by conviction, and loyal to his party and its great leader, Mr Gladstone.

Coleridge had three sons and a daughter by his first wife, Jane Fortescue, daughter of the Rev. George Seymour of Freshwater. She was an artist of real genius, and her portrait of Cardinal Newman was considered much better than the one by Millais. She died in February 1878; a short notice of her by Dean Church of St Paul's was published in the *Guardian*, and was reprinted in her husband's privately printed collection of poems. Coleridge remained for some years a widower, but married in 1885 Amy Augusta Jackson Lawford, who survived him. He was succeeded in the peerage by his eldest son, Bernard John Seymour (b. 1851), who went to the bar and became a K.C. in 1892. In 1907 he was appointed a judge of the Supreme Court. The two other sons were Stephen (b. 1854), a barrister, secretary to the Anti-Vivisection Society, and Gilbert James Duke (b. 1859).

His *Life and Correspondence*, edited by E. H. Coleridge, was published in 1904; see further E. Manson, *Builders of our Law*

(1904); and for the history of the Coleridge family see Lord Coleridge, *The Story of a Devonshire House* (1907). (M. G. D.)

COLERIDGE, SIR JOHN TAYLOR (1790–1876), English judge, the second son of Captain James Coleridge and nephew of the poet S. T. Coleridge, was born at Tiverton, Devon, and was educated at Corpus Christi College, Oxford, where he had a brilliant career. He graduated in 1812 and was soon after made a fellow of Exeter; in 1819 he was called to the bar at the Middle Temple and practised for some years on the western circuit. In 1824, on Gifford's retirement, he assumed the editorship of the *Quarterly Review*, resigning it a year afterwards in favour of Lockhart. In 1825 he published his excellent edition of *Blackstone's Commentaries*, and in 1832 he was made a serjeant-at-law and recorder of Exeter. In 1835 he was appointed one of the judges of the king's bench. In 1852 his university created him a D.C.L., and in 1858 he resigned his judgeship, and was made a member of the privy council. In 1869, although in extreme old age, he produced his pleasant *Memoir of the Rev. John Keble*, whose friend he had been since their college days, a third edition of which was issued within a year. He died on the 11th of February 1876 at Ottery St Mary, Devon, leaving two sons and a daughter; the eldest son, John Duke, 1st Baron Coleridge (*q.v.*), became lord chief justice of England; the second son, Henry James (1822–1893), left the Anglican for the Roman Catholic church in 1852, and became well-known as a Jesuit divine, editor of *The Month*, and author of numerous theological works. Sir John Taylor Coleridge's brothers, James Duke and Henry Nelson (husband of Sara Coleridge), are referred to in other articles; his brother Francis George was the father of Arthur Duke Coleridge (b. 1830), clerk of assizes on the midland circuit and author of *Eton in the Forties*, whose daughter Mary E. Coleridge (1861–1907) became a well-known writer of fiction.

COLERIDGE, SAMUEL TAYLOR (1772–1834), English poet and philosopher, was born on the 21st of October 1772, at his father's vicarage of Ottery St Mary's, Devonshire. His father, the Rev. John Coleridge (1719–1781), was a man of some mark. He was known for his great scholarship, simplicity of character, and affectionate interest in the pupils of the grammar school, of which he was appointed master a few months before becoming vicar of the parish (1760), reigning in both capacities till his death. He had married twice. The poet was the youngest child of his second wife, Anne Bowdon (d. 1809), a woman of great good sense, and anxiously ambitious for the success of her sons. On the death of his father, a presentation to Christ's Hospital was procured for Coleridge by the judge, Sir Francis Buller, an old pupil of his father's. He had already begun to give evidence of a powerful imagination, and he has described in a letter to his valued friend, Tom Poole, the pernicious effect which the admiration of an uncle and his circle of friends had upon him at this period. For eight years he continued at Christ's Hospital. Of these school-days Charles Lamb has given delightful glimpses in the *Essays of Elia*. The headmaster, Bowyer (as he was called, though his name was Boyer), was a severe disciplinarian, but respected by his pupils. Middleton, afterwards known as a Greek scholar, and bishop of Calcutta, reported Coleridge to Bowyer as a boy who read Virgil for amusement, and from that time Bowyer began to notice him and encouraged his reading. Some compositions in English poetry, written at sixteen, and not without a touch of genius, give evidence of the influence which Bowles, whose poems were then in vogue, had over his mind at this time. Before he left school his constitutional delicacy of frame, increased by swimming the New River in his clothes, began to give him serious discomfort.

In February 1791 he was entered at Jesus College, Cambridge. A school-fellow who followed him to the university has described in glowing terms evenings in his rooms, "when Aeschylus, and Plato, and Thucydides were pushed aside, with a pile of lexicons and the like, to discuss the pamphlets of the day. Ever and anon a pamphlet issued from the pen of Burke. There was no need of having the book before us;—Coleridge had read it in the morning, and in the evening he would repeat whole pages

verbatim." William Frend, a fellow of Jesus, accused of sedition and Unitarianism, was at this time tried and expelled from Cambridge. Coleridge had imbibed his sentiments, and joined the ranks of his partisans. He grew discontented with university life and in 1793, pressed by debt, went to London. Perhaps he was also influenced by his passion for Mary Evans, the sister of one of his school-fellows. A poem in the *Morning Chronicle* brought him a guinea, and when that was spent he enlisted in the 15th Dragoons under the name of Silas Tomkyn Comberbache. One of the officers of the dragoon regiment, finding a Latin sentence inscribed on a wall, discovered the condition of the very awkward recruit. Shortly afterwards an old school-fellow (G. L. Tuckett) heard of his whereabouts, and by the intervention of his brother, Captain James Coleridge, his discharge was procured. He returned for a short time to Cambridge, but quitted the university without a degree in 1794. In the same year he visited Oxford, and after a short tour in Wales went to Bristol, where he met Southey. The French Revolution had stirred the mind of Southey to its depths. Coleridge received with rapture his new friend's scheme of Pantisocracy. On the banks of the Susquehanna was to be founded a brotherly community, where selfishness was to be extinguished, and the virtues were to reign supreme. No funds were forthcoming, and in 1795, to the chagrin of Coleridge, the scheme was dropped. In 1794 *The Fall of Robespierre*, of which Coleridge wrote the first act and Southey the other two, appeared. At Bristol Coleridge formed the acquaintance of Joseph Cottle, the bookseller, who offered him thirty guineas for a volume of poems. In October of 1795 Coleridge married Sarah Fricker, and took up his residence at Clevedon on the Bristol Channel. A few weeks afterwards Southey married a sister of Mrs Coleridge, and on the same day quitted England for Portugal.

Coleridge began to lecture in Bristol on politics and religion. He embodied the first two lectures in his first prose publication, *Conciones ad Populum* (1795). The book contained much invective against Pitt, and in after life Coleridge declared that, with this exception, and a few pages involving philosophical tenets which he afterwards rejected, there was little or nothing he desired to retract. The first volume of *Poems* was published by Cottle early in 1796. Coleridge projected a periodical called *The Watchman*, and in 1796 undertook a journey, well described in the *Biographia Literaria*, to enlist subscribers. *The Watchman* had a brief life of two months, but at this time Coleridge began to think of becoming a Unitarian preacher, and abandoning literature for ever. Hazlitt has recorded his very favourable impression of a remarkable sermon delivered at Shrewsbury; but there are other accounts of Coleridge's preaching not so enthusiastic. In the summer of 1795 he met for the first time the brother poet with whose name his own will be for ever associated Wordsworth and his sister had established themselves at Racedown in the Dorsetshire hills, and here Coleridge visited them in 1797. There are few things in literary history more remarkable than this friendship. The gifted Dorothy Wordsworth described Coleridge as "thin and pale, the lower part of the face not good, wide mouth, thick lips, not very good teeth, longish, loose, half-curling, rough, black hair,"—but all was forgotten in the magic charm of his utterance. Wordsworth, who declared, "The only wonderful man I ever knew was Coleridge," seems at once to have desired to see more of his new friend. He and his sister removed in July 1797 to Alfoxden, near Nether Stowey, to be in Coleridge's neighbourhood, and in the most delightful and unrestrained intercourse the friends spent many happy days. It was the delight of each one to communicate to the other the productions of his mind, and the creative faculty of both poets was now at its best. One evening, at Watchett on the British Channel, *The Ancient Mariner* first took shape. Coleridge was anxious to embody a dream of a friend, and the suggestion of the shooting of the albatross came from Wordsworth, who gained the idea from Shelvocke's *Voyage* (1726). A joint volume was planned. Wordsworth was to show the real poetry that lies hidden in commonplace subjects, while Coleridge was to treat supernatural subjects to illustrate

the common emotions of humanity. From this sprang the *Lyrical Ballads*, to which Coleridge contributed *The Ancient Mariner*, the *Nightingale* and two scenes from *Osorio*, and after much cogitation the book was published in 1798 at Bristol by Cottle, to whose reminiscences, often indulging too much in detail, we owe the account of this remarkable time. A second edition of the *Lyrical Ballads* in 1800 included another poem by Coleridge—*Love*, to which subsequently the sub-title was given of *An Introduction to the Tale of the Dark Ladie*. To the Stowey period belong also the tragedy of *Osorio* (afterwards known as *Remorse*), *Kubla Khan* and the first part of *Christabel*. In 1798 an annuity, granted him by the brothers Wedgwood, led Coleridge to abandon his reluctantly formed intention of becoming a Unitarian minister. For many years he had desired to see the continent, and in September 1798, in company with Wordsworth and his sister, he left England for Hamburg. *Satyranes Letters* (republished in *Biog. Lit.* 1817) give an account of the tour.

A new period in Coleridge's life now began. He soon left the Wordsworths to spend four months at Ratzeburg, whence he removed to Göttingen to attend lectures. A great intellectual movement had begun in Germany. Coleridge was soon in the full whirl of excitement. He learnt much from Blumenbach and Eichhorn, and took interest in all that was going on around him. During his stay of nine months in Germany, he made himself master of the language to such purpose that the translation of *Wallenstein*—his first piece of literary work after his return to England—was actually accomplished in six weeks. It was published in 1800, and, although it failed to make any impression on the general public, it became at once prized by Scott and others as it deserved. It is matter for regret that a request to Coleridge that he should undertake to translate *Faust* never received serious attention from him. During these years Coleridge wrote many newspaper articles and some poems, among them "Fire, Famine and Slaughter," for the *Morning Post* (January 8, 1798). He had vehemently opposed Pitt's policy, but a change came over his way of thought, and he found himself separated from Fox on the question of a struggle with Napoleon. He had lost his admiration for the Revolutionists, as his "Ode to France" shows (*Morning Post*, April 16, 1798). Like many other Whigs, he felt that all questions of domestic policy must at a time of European peril be postponed. From this time, however, his value for the ordered liberty of constitutional government increased; and though never exactly to be found among the ranks of old-fashioned Constitutionalists, during the remainder of his life he kept steadily in view the principles which received their full exposition in his well-known work on *Church and State*. In the year 1800 Coleridge left London for the Lakes. Here in that year he wrote the second part of *Christabel*. In 1803 Southey became a joint lodger with Coleridge at Greta Hall, Keswick, of which in 1812 Southey became sole tenant and occupier.

In 1801 begins the period of Coleridge's life during which, in spite of the evidence of work shown in his compositions, he sank more and more under the dominion of opium, in which he may have first indulged at Cambridge. Few things are so sad to read as the letters in which he details the consequences of his transgression. He was occasionally seen in London during the first years of the century, and wherever he appeared he was the delight of admiring circles. He toured in Scotland with the Wordsworths in 1803, visited Malta in 1804, when for ten months he acted as secretary to the governor, and stayed nearly eight months at Naples and Rome in 1805–1806. In Rome he received a hint that his articles in the *Morning Post* had been brought to Napoleon's notice, and he made the voyage from Leghorn in an American ship. On a visit to Somersetshire in 1807 he met De Quincey for the first time, and the younger man's admiration was shown by a gift of £300, "from an unknown friend." In 1809 he started a magazine called *The Friend*, which continued only for eight months. At the same time Coleridge began to contribute to the *Courier*. In 1808 he lectured at the Royal Institution, but with little success, and

two years later he gave his lectures on Shakespeare and other poets. These lectures attracted great attention and were followed by two other series. In 1812 his income from the Wedgwoods was reduced, and he settled the remainder on his wife. His friends were generous in assisting him with money. Eventually Mackintosh obtained a grant of £100 a year for him in 1824 during the lifetime of George IV., as one of the royal associates of the Society of Literature, and at different times he received help principally from Stuart, the publisher, Poole, Sotheby, Sir George Beaumont, Byron and Wordsworth, while his children shared Southey's home at Keswick. But between 1812 and 1817 Coleridge made a good deal by his work, and was able to send money to his wife in addition to the annuity she received. The tragedy of *Remorse* was produced at Drury Lane in 1813, and met with considerable success. Three years after this, having failed to conquer the opium habit, he determined to enter the family of Mr James Gillman, who lived at Highgate. The letter in which he discloses his misery to this kind and thoughtful man gives a real insight into his character. Under judicious treatment the hour of mastery at last arrived. The shore was reached, but the vessel had been miserably shattered in its passage through the rocks. For the rest of his life he hardly ever left his home at Highgate. During his residence there, *Christabel*, written many years before, and known to a favoured few, was first published in a volume with *Kubla Khan* and the *Pains of Sleep* in 1816. He read widely and wisely, in poetry, philosophy and divinity. In 1816 and the following year, he gave his *Lay Sermons* to the world. *Sibylline Leaves* appeared in 1817; the *Biographia Literaria* and a revised edition of *The Friend* soon followed. Seven years afterwards his most popular prose work—*The Aids to Reflection*—first appeared. His last publication, in 1830, was the work on *Church and State*. It was not till 1840 that his *Confessions of an Inquiring Spirit*, by far his most seminal work, was posthumously published. In 1833 he appeared at the meeting of the British Association at Cambridge, but he died in the following year (25th of July 1834), and was buried in the churchyard close to the house of Mr Gillman, where he had enjoyed every consolation which friendship and love could render. Coleridge died in the communion of the Church of England, of whose polity and teaching he had been for many years a loving admirer. An interesting letter to his god-child, written twelve days before his death, sums up his spiritual experience in a most touching form.

Of the extraordinary influence which he exercised in conversation it is impossible to speak fully here. Many of the most remarkable among the younger men of that period resorted to Highgate as to the shrine of an oracle, and although one or two disparaging judgments, such as that of Carlyle, have been recorded, there can be no doubt that since Samuel Johnson there had been no such power in England. His nephew, Henry Nelson Coleridge, gathered together some specimens of the *Table Talk* of the few last years. But remarkable as these are for the breadth of sympathy and extent of reading disclosed, they will hardly convey the impressions furnished in a dramatic form, as in Boswell's great work. Four volumes of *Literary Remains* were published after his death, and these, along with the chapters on the poetry of Wordsworth in the *Biographia Literaria*, may be said to exhibit the full range of Coleridge's power as a critic of poetry. In this region he stands supreme. With regard to the preface, which contains Wordsworth's theory, Coleridge has honestly expressed his dissent:—"With many parts of this preface, in the sense attributed to them, and which the words undoubtedly seem to authorize, I never concurred; but, on the contrary, objected to them as erroneous in principle, and contradictory (in appearance at least) both to other parts of the same preface, and to the author's own practice in the greater number of the poems themselves." This disclaimer of perfect agreement renders the remaining portion of what he says more valuable. Coleridge was in England the creator of that higher criticism which had already in Germany accomplished so much in the hands of Lessing and Goethe. It is enough to refer here to the fragmentary series of his Shakespearian

criticisms, containing evidence of the truest insight, and a marvellous appreciation of the judicial "sanity" which raises the greatest name in literature far above even the highest of the poets who approached him.

As a poet Coleridge's own place is safe. His niche in the great gallery of English poets is secure. Of no one can it be more emphatically said that at his highest he was "of imagination all compact." He does not possess the fiery pulse and humaneness of Burns, but the exquisite perfection of his metre and the subtle alliance of his thought and expression must always secure for him the warmest admiration of true lovers of poetic art. In his early poems may be found traces of the fierce struggle of his youth. The most remarkable is the *Monody on the Death of Chatterton* and the *Religious Musings*. In what may be called his second period, the ode entitled *France*, considered by Shelley the finest in the language, is most memorable. The whole soul of the poet is reflected in the *Ode to Dejection*. The well-known lines—

"O Lady! we receive but what we give,
And in our life alone does nature live;
Ours is her wedding garment, ours her shroud,"

with the passage which follows, contain more vividly, perhaps, than anything which Coleridge has written, the expression of the shaping and colouring function which he assigns, in the *Biographia Literaria*, to imagination. *Christabel* and the *Ancient Mariner* have so completely taken possession of the highest place, that it is needless to do more than allude to them. The supernatural has never received such treatment as in these two wonderful productions of his genius, and though the first of them remains a torso, it is the loveliest torso in the gallery of English literature. Although Coleridge had, for many years before his death, almost entirely forsaken poetry, the few fragments of work which remain, written in later years, show little trace of weakness, although they are wanting in the unearthly melody which imparts such a charm to *Kubla Khan*, *Love and Youth* and *Age*.

(G. D. B.; H. CH.)

In the latter part of his life, and for the generation which followed, Coleridge was ranked by many young English churchmen of liberal views as the greatest religious thinker of their time. As Carlyle has told in his *Life of Sterling*, the poet's distinction, in the eyes of the younger churchmen with philosophic interests, lay in his having recovered and preserved his Christian faith after having passed through periods of rationalism and Unitarianism, and faced the full results of German criticism and philosophy. His opinions, however, were at all periods somewhat mutable, and it would be difficult to state them in any form that would hold good for the whole even of his later writings. He was, indeed, too receptive of thought impressions of all kinds to be a consistent systematizer. As a schoolboy, by his own account, he was for a time a Voltairian, on the strength of a perusal of the *Philosophical Dictionary*. At college, as we have seen, he turned Unitarian. From that position he gradually moved towards pantheism, a way of thought to which he had shown remarkable leanings when, as a schoolboy, he discoursed of Neo-Platonism to Charles Lamb, or—if we may trust his recollection—translated the hymns of Synesius. Early in life, too, he met with the doctrines of Jacob Behmen, of whom, in the *Biographia Literaria*, he speaks with affection and gratitude as having given him vital philosophic guidance. Between pantheism and Unitarianism he seems to have balanced till his thirty-fifth year, always tending towards the former in virtue of the recoil from "anthropomorphism" which originally took him to Unitarianism. In 1796, when he named his first child David Hartley, but would not have him baptized, he held by the "Christian materialism" of the writer in question, whom in his *Religious Musings* he terms "wisest of mortal kind."

When, again, he met Wordsworth in 1797, the two poets freely and sympathetically discussed Spinoza, for whom Coleridge always retained a deep admiration; and when in 1798 he gave up his Unitarian preaching, he named his second child Berkeley, signifying a new allegiance, but still without accepting Christian rites otherwise than passively. Shortly afterwards he went to

Germany, where he began to study Kant, and was much captivated by Lessing. In the *Biographia* he avows that the writings of Kant "more than any other work, at once invigorated and disciplined my understanding"; yet the gist of his estimate there is that Kant left his system undeveloped, as regards his idea of the Noumenon, for fear of orthodox persecution—a judgment hardly compatible with any assumption of Kant's Christian orthodoxy, which was notoriously inadequate. But after his stay at Malta, Coleridge announced to his friends that he had given up his "Socinianism" (of which ever afterwards he spoke with asperity), professing a return to Christian faith, though still putting on it a mystical construction, as when he told Crabb Robinson that "Jesus Christ was a Platonic philosopher." At this stage he was much in sympathy with the historico-rationalistic criticism of the Old Testament, as carried on in Germany; giving his assent, for instance, to the naturalistic doctrine of Schiller's *Die Sendung Moses*. From about 1810 onwards, however, he openly professed Christian orthodoxy, while privately indicating views which cannot be so described. And even his published speculations were such as to draw from J. H. Newman a protest that they took "a liberty which no Christian can tolerate," and carried him to "conclusions which were often heathen rather than Christian." This would apply to some of his positions concerning the Logos and the Trinity. After giving up Unitarianism he claimed that from the first he had been a Trinitarian on Platonic lines; and some of his latest statements of the doctrine are certainly more pantheistic than Christian.

The explanation seems to be that while on Christian grounds he repeatedly denounced pantheism as being in all its forms equivalent to atheism, he was latterly much swayed by the thought of Schelling in the pantheistic direction which was natural to him. To these conflicting tendencies were probably due his self-contradictions on the problem of original sin and the conflicting claims of feeling and reason. It would seem that, in the extreme spiritual vicissitudes of his life, conscious alternately of personal weakness and of the largest speculative grasp, he at times threw himself entirely on the consolations of evangelical faith, and at others reconstructed the cosmos for himself in terms of Neo-Platonism and the philosophy of Schelling. So great were his variations even in his latter years, that he could speak to his friend Allsop in a highly latitudinarian sense, declaring that in Christianity "the miracles are supererogatory," and that "the law of God and the great principles of the Christian religion would have been the same had Christ never assumed humanity."

From Schelling, whom he praised as having developed Kant where Fichte failed to do so, he borrowed much and often, not only in the metaphysical sections of the *Biographia* but in his aesthetic lectures, and further in the cosmic speculations of the posthumous *Theory of Life*. On the first score he makes but an equivocal acknowledgment, claiming to have thought on Schelling's lines before reading him; but it has been shown by Hamilton and Ferrier that besides transcribing much from Schelling without avowal he silently appropriated the learning of Maass on philosophical history. In other directions he laid under tribute Herder and Lessing; yet all the while he cast severe imputations of plagiarism upon Hume and others. His own plagiarisms were doubtless facilitated by the physiological effects of opium.

Inasmuch as he finally followed in philosophy the mainly poetical or theosophic movement of Schelling, which satisfied neither the logical needs appealed to by Hegel nor the new demand for naturalistic induction, Coleridge, after arousing a great amount of philosophic interest in his own country in the second quarter of the century, has ceased to "make a school." Thus his significance in intellectual history remains that of a great stimulator. He undoubtedly did much to deepen and liberalize Christian thought in England, his influence being specially marked in the school of F. D. Maurice, and in the lives of men like John Sterling. And even his many borrowings from the German were assimilated with a rare power of development,

which bore fruit not only in a widening of the field of English philosophy but in the larger scientific thought of a later generation. (J. M. Ro.)

Of Coleridge's four children, two (Hartley and Sara) are separately noticed. His second child, Berkeley, died when a baby. The third, Derwent (1800-1883), a distinguished scholar and author, was master of Helston school, Cornwall (1825-1841), first principal of St Mark's College, Chelsea (1841-1864), and rector of Hanwell (1864-1880); and his daughter Christabel (b. 1843) and son Ernest Hartley (b. 1846) both became well known in the world of letters, the former as a novelist, the latter as a biographer and critic.

After Coleridge's death several of his works were edited by his nephew, Henry Nelson Coleridge, the husband of Sara, the poet's only daughter. In 1847 Sara Coleridge published the *Biographia Literaria*, enriched with annotations and biographical supplement from her own pen. Three volumes of political writings, entitled *Essays on his Own Times*, were also published by Sara Coleridge in 1850. The standard life of Coleridge is that by J. Dykes Campbell (1894); his letters were edited by E. H. Coleridge.

COLERIDGE, SARA (1802-1852), English author, the fourth child and only daughter of Samuel Taylor Coleridge and his wife Sarah Fricker of Bristol, was born on the 23rd of December 1802, at Greta Hall, Keswick. Here, after 1803, the Coleridges, Southey and his wife (Mrs Coleridge's sister), and Mrs Lovell (another sister), widow of Robert Lovell, the Quaker poet, all lived together; but Coleridge was often away from home; and "Uncle Southey" was a *pater familias*. The Wordsworths at Grasmere were their neighbours. Wordsworth, in his poem, the *Triad*, has left us a description, or "poetical glorification," as Sara Coleridge calls it, of the three girls—his own daughter Dora, Edith Southey and Sara Coleridge, the "last of the three, though eldest born." Greta Hall was Sara Coleridge's home until her marriage; and the little Lake colony seems to have been her only school. Guided by Southey, and with his ample library at her command, she read by herself the chief Greek and Latin classics, and before she was five-and-twenty had learnt French, German, Italian and Spanish.

In 1822 Sara Coleridge published *Account of the Abipones*, a translation in three large volumes of Dobrizhoffer, undertaken in connexion with Southey's *Tale of Paraguay*, which had been suggested to him by Dobrizhoffer's volumes; and Southey alludes to his niece, the translator (canto iii. stanza 16), where he speaks of the pleasure the old missionary would have felt if

" . . . he could in Merlin's glass have seen

By whom his tomes to speak our tongue were taught."

In less grandiloquent terms, Charles Lamb, writing about the *Tale of Paraguay* to Southey in 1825, says, "How she Dobrizhoffer it all out, puzzles my slender Latinity to conjecture." In 1825 her second work appeared, a translation from the medieval French of the "Loyal Serviteur," *The Right Joyous and Pleasant History of the Feats, Jests, and Prowesses of the Chevalier Bayard, the Good Knight without Fear and without Reproach: By the Loyal Servant*.

In September 1829, at Crosthwaite church, Keswick, after an engagement of seven years' duration, Sara Coleridge was married to her cousin, Henry Nelson Coleridge (1798-1843), younger son of Captain James Coleridge (1760-1836). He was then a chancery barrister in London. The first eight years of her married life were spent in a little cottage in Hampstead. There four of her children were born, of whom two survived. In 1834 Mrs Coleridge published her *Pretty Lessons in Verse for Good Children; with some Lessons in Latin in Easy Rhyme*. These were originally written for the instruction of her own children, and became very popular. In 1837 the Coleridges removed to Chester Place, Regent's Park; and in the same year appeared *Phantasmion, a Fairy Tale*, Sara Coleridge's longest original work. The songs in *Phantasmion* were much admired at the time by Leigh Hunt and other critics. Some of them, such as "Sylvan Stay" and "One Face Alone," are extremely graceful and musical, and the whole fairy tale is noticeable for the beauty of the story and the richness of its language.

In 1843 Henry Coleridge died, leaving to his widow the unfinished task of editing her father's works. To these she added some compositions of her own, among which are the *Essay on Rationalism, with a special application to the Doctrine of Baptismal*

Regeneration, appended to Coleridge's *Aids to Reflection*, a Preface to the *Essays on his Own Times*, by S. T. Coleridge, and the Introduction to the *Biographia Literaria*. During the last few years of her life Sara Coleridge was a confirmed invalid. Shortly before she died she amused herself by writing a little autobiography for her daughter. This, which reaches only to her ninth year, was completed by her daughter, and published in 1873, together with some of her letters, under the title *Memoirs and Letters of Sara Coleridge*. The letters show a cultured and highly speculative mind. They contain many apt criticisms of known people and books, and are specially interesting for their allusions to Wordsworth and the Lake Poets. Sara Coleridge died in London on the 3rd of May 1852.

Her son, Herbert Coleridge (1830-1861), won a double first class in classics and mathematics at Oxford in 1852. He was secretary to a committee appointed by the Philological Society to consider the project of a standard English dictionary, a scheme of which the *New English Dictionary*, published by the Clarendon Press, was the ultimate outcome. His personal researches into the subject were contained in his *Glossarial Index to the Printed English Literature of the Thirteenth Century* (1859).

COLET, JOHN (1467?-1519), English divine and educationist, the eldest son of Sir Henry Colet (lord mayor of London 1486 and 1495), was born in London about 1467. He was educated at St Anthony's school and at Magdalen College, Oxford, where he took the M.A. degree in 1490. He already held the non-resident rectory of Dennington, Suffolk, and the vicarage of St Dunstan's, Stepney, and was now collated rector of Thurning, Hunts. In 1493 he went to Paris and thence to Italy, studying canon and civil law, patristics and the rudiments of Greek. During his residence abroad he became acquainted with Budaeus (Guillaume Budé) and Erasmus, and with the teaching of Savonarola. On his return to England in 1496 he took orders and settled at Oxford, where he lectured on the epistles of St Paul, replacing the old scholastic method of interpretation by an exegesis more in harmony with the new learning. His methods did much to influence Erasmus, who visited Oxford in 1498, and in after years Erasmus received an annuity from him. Since 1494 he had been prebendary of York, and canon of St Martin le Grand, London. In 1502 he became prebendary of Salisbury, in 1505 prebendary of St Paul's, and immediately afterwards dean of the same cathedral, having previously taken the degree of doctor of divinity. Here he continued his practice of lecturing on the books of the Bible; and he soon afterwards established a perpetual divinity lecture, on three days in each week, in St Paul's church. About the year 1508, having inherited his father's large wealth, Colet formed his plan for the re-foundation of St Paul's school, which he completed in 1512, and endowed with estates of an annual value of £122 and upwards. The celebrated grammarian William Lilly was the first master, and the company of mercers were (in 1510) appointed trustees, the first example of non-clerical management in education. The dean's religious opinions were so much more liberal than those of the contemporary clergy (whose ignorance and corruption he denounced) that they deemed him little better than a heretic; but William Warham, the archbishop, refused to prosecute him. Similarly Henry VIII. held him in high esteem despite his sermons against the French wars. In 1514 he made the Canterbury pilgrimage, and in 1515 preached at Wolsey's installation as cardinal. Colet died of the sweating sickness on the 16th of September 1519. He was buried on the south side of the choir of St Paul's, where a stone was laid over his grave, with no other inscription than his name. Besides the preferments above mentioned, he was rector of the guild of Jesus at St Paul's and chaplain to Henry VIII.

Colet, though never dreaming of a formal breach with the Roman Church, was a keen reformer, who disapproved of auricular confession, and of the celibacy of the clergy. Though no great scholar or writer, he was a powerful force in the England of his day, and helped materially to disintegrate the medieval conditions still obtaining, and to introduce the humanist movement. Among his works, which were first collectively published in

1867-1876, are *Absolutissimus de octo orationis partium constructione libellus* (Antwerp, 1530), *Rudimenta Grammatices* (London, 1539), *Daily Devotions, Monition to a Godly Life, Epistolae ad Erasmus*, and commentaries on different parts of the Bible.

See F. Seebohm, *The Oxford Reformers*; J. H. Lupton, *Life of John Colet* (1887); art. in *The Times*, July 7, 1909.

COLET, LOUISE (1810-1876), French poet and novelist, was born at Aix of a Provençal family named Revoil, on the 15th of September 1810. In 1835 she came to Paris with her husband Hippolyte Colet (1808-1851), a composer of music and professor of harmony and counterpoint at the conservatoire. In 1836 appeared her *Fleurs du Midi*, a volume of verse, of liberal tendency, followed by *Penserosa* (1839), a second volume of verse; by *La Jeunesse de Goethe* (1839), a one-act comedy; by *Les Cœurs brisés* (1843), a novel; *Les Funerailles de Napoléon* (1840), a poem, and *La Jeunesse de Mirabeau* (1841), a novel. Her works were crowned five or six times by the Institute, a distinction which she owed, however, to the influence of Victor Cousin rather than to the quality of her work. The criticisms on her books and on the prizes conferred on her by the Academy exasperated her; and in 1841 Paris was diverted by her attempted reprisals on Alphonse Karr for certain notices in *Les Guêpes*. In 1849 she had to defend an action brought against her by the heirs of Madame Récamier, whose correspondence with Benjamin Constant she had published in the columns of the *Presse*. She produced a host of writings in prose and verse, but she is perhaps best known for her intimate connexion with some of her famous contemporaries, Abel Villemain, Gustave Flaubert and Victor Cousin. Only one of her books is now of interest—*Lui: roman contemporain* (1859), the novel in which she told the story of her life. She died on the 8th of March 1876.

COLEUS, a genus of herbaceous or shrubby plants belonging to the natural order Labiatae, chiefly natives of the tropics. They are very ornamental plants, the colour of their leaves being exceedingly varied, and often very brilliant. They are of the easiest culture. The cuttings of young shoots should be propagated every year, about March, being planted in thumb pots, in sandy loam, and placed in a close temperature of 70°. After taking root shift into 6-in. pots, using ordinary light loamy compost, containing abundance of leaf-mould and sand, and keeping them near the light. They may be passed on into larger pots as often as required, but 8-in. pots will be large enough for general purposes, as they can be fed with liquid manure. The young spring-struck plants like a warm growing atmosphere, but by midsummer they will bear more air and stand in a greenhouse or conservatory. They should be wintered in a temperature of 60° to 65°. The stopping of the young shoots must be regulated by the consideration whether bushy or pyramidal plants are desired. Some of the varieties are half-hardy and are used for summer bedding.

COLFAX, SCHUYLER (1823-1885), American political leader, vice president of the United States from 1869 to 1873, was born in New York city on the 23rd of March 1823. His father died before the son's birth, and his mother subsequently married a Mr Matthews. The son attended the public schools of New York until he was ten, and then became a clerk in his step-father's store, removing in 1836 with his mother and step-father to New Carlisle, Indiana. In 1841 he removed to South Bend, where for eight years he was deputy auditor (his step-father being auditor) of St Joseph county; in 1842-1844 he was assistant enrolling clerk of the state senate and senate reporter for the *Indiana State Journal*. In 1845 he established the *St Joseph Valley Register*, which he published for eighteen years and made an influential Whig and later Republican journal. In 1850 he was a member of the state constitutional convention, and in 1854 took an active part in organizing the "Anti-Nebraska men" (later called Republicans) of his state, and was by them sent to Congress. Here he served with distinction from 1855 until 1869, the last six years as speaker of the House. At the close of the Civil War he was a leading member of the radical wing of the Republican party, advocating the disfranchisement

of all who had been prominent in the service of the Confederacy, and declaring that "loyalty must govern what loyalty has preserved." In 1868 he had presidential aspirations, and was not without supporters. He accepted, however, the Republican nomination as vice-president on a ticket headed by General Grant, and was elected; but he failed in 1872 to secure renomination. During the political campaign of 1872 he was accused, with other prominent politicians, of being implicated in corrupt transactions with the Crédit Mobilier, and a congressional investigation brought out the fact that he had agreed to take twenty shares from this concern, and had received dividends amounting to \$1,200. It also leaked out during the investigation that he had received in 1868, as a campaign contribution, a gift of \$4,000 from a contractor who had supplied the government with envelopes while Colfax was chairman of the post office committee of the House. At the close of his term Colfax returned to private life under a cloud, and during the remainder of his lifetime earned a livelihood by delivering popular lectures. He died at Mankato, Minnesota, on the 13th of January 1885.

See J. C. Hollister's *Life of Schuyler Colfax* (New York, 1886).

COLIC (from the Gr. κόλον or κῶλον, the large intestine), a term in medicine of very indefinite meaning, used by physicians outside England for any paroxysmal abdominal pain, but generally limited in England to a sudden sharp pain having its origin in the pelvis of the kidney, the ureter, gall-bladder, bile-ducts or intestine. Thus it is customary to speak of renal, biliary or intestinal colic. There is a growing tendency, however, among professional men of to-day, to restrict the use of the word to a pain produced by the contraction of the muscular walls of any of the hollow viscera of which the aperture has become more or less occluded, temporarily or otherwise. For renal and biliary colic, see the articles KIDNEY DISEASES and LIVER, only intestinal colic being treated in this place.

In infants, usually those who are "bottle-fed," colic is exceedingly common, and is shown by the drawing up of their legs, their restlessness and their continuous cries.

Among adults one of the most serious causes is that due to lead-poisoning and known as lead colic (*Syn.* painters' colic, *colica Pictorum*, Devonshire colic), from its having been clearly ascertained to be due to the absorption of lead into the system (see LEAD-POISONING). This disease had been observed and described long before its cause was discovered. Its occurrence in an epidemic form among the inhabitants of Poitou was recorded by Francois Citois (1572-1652) under the title of *Novus et popularis apud Pictones dolor colicus biliosus*. The disease was thereafter termed *colica Pictorum*. It was supposed to be due to the acidity of the native wines, but it was afterwards found to depend on lead contained in them. A similar epidemic broke out in certain parts of Germany in the end of the 17th century, and was at the time believed by various physicians to be caused by the admixture of acid wines with litharge to sweeten them.

About the middle of the 18th century this disease, which had long been known to prevail in Devonshire, was carefully investigated by Sir George Baker (1722-1809), who succeeded in tracing it unmistakably to the contamination of the native beverage, cider, with lead, either accidentally from the leadwork of the vats and other apparatus for preparing the liquor, or from its being sweetened with litharge.

In Germany a similar colic resulting from the absorption of copper occurs, but it is almost unknown in England.

The simplest form of colic is that arising from habitual constipation, the muscular wall of the intestines contracting painfully to overcome the resistance of hardened scybalous masses of faeces, which cause more or less obstruction to the onward passage of the intestinal contents. Another equally common cause is that due to irritating or indigestible food such as apples, pears or nuts, heavy pastry, meat pies and puddings, &c. It may then be associated with either constipation or diarrhoea, though the latter is the more common. It may result from any form of enteritis as simple, mucous and ulcerative colitis, or an intestinal malignant growth. The presence

of *ascaris lumbricoides* may, by reflex action, set up a very painful nervous spasm; and certain forms of influenza (*q.v.*) are ushered in by colic of a very pronounced type. Many physicians describe a rheumatic colic due to cold and damp, and among women disease of the pelvic organs may give rise to an exactly similar pain. There are also those forms of colic which must be classed as functional or neuralgic, though this view of the case must never be accepted until every other possible cause is found to be untenable. From this short account of a few of the commoner causes of the trouble, it will be clear that colic is merely a symptom of disease, not a disease in itself, and that no diagnosis has been made until the cause of the pain has been determined.

Intestinal colic is paroxysmal, usually both beginning and ending suddenly. The pain is generally referred to the neighbourhood of the umbilicus, and may radiate all over the abdomen. It varies in intensity from a slight momentary discomfort to a pain so severe as to cause the patient to shriek or even to break out into a cold clammy sweat. It is usually relieved by pressure, and this point is one which aids in the differential diagnosis between a simple colic and peritonitis, the pain of the latter being increased by pressure. But should the colic be due to a malignant growth, or should the intestines be distended with gas, pressure will probably increase the pain. The temperature is usually subnormal, but may be slightly raised, and the pulse is in proportion.

In the treatment of simple colic the patient must be confined to bed, hot fomentations applied to the abdomen and a purge administered, a few drops of laudanum being added when the pain is exceptionally severe. But the whole difficulty lies in making the differential diagnosis. Acute intestinal obstruction (ileus) begins just as an attack of simple colic, but the rapid increase of illness, frequent vomiting, anxious countenance, and still more the condition of the pulse, warn a trained observer of the far more serious state. Appendicitis and peritonitis, as also the gastric crises of locomotor ataxy, must all be excluded.

COLIGNY, GASPARD DE (1519–1572), admiral of France and Protestant leader, came of a noble family of Burgundy, who traced their descent from the 11th century, and in the reign of Louis XI. were in the service of the king of France. His father, Gaspard de Coligny, known as the *maréchal de Châtillon* (d. 1522), served in the Italian wars from 1495 to 1515, and was created marshal of France in 1516. By his wife, Louise de Montmorency, sister of the future constable, he had three sons: Odet, cardinal de Châtillon; Gaspard, the admiral; and Francis, *seigneur d'Andelot*; all of whom played an important part in the first period of the wars of religion. At twenty-two young Gaspard came to court, and there contracted a friendship with Francis of Guise. In the campaign of 1543 Coligny distinguished himself greatly, and was wounded at the sieges of Montmédy and Bains. In 1544 he served in the Italian campaign under the duke of Enghien, and was knighted on the field of Ceresole. Returning to France, he took part in different military operations; and having been made colonel-general of the infantry (April 1547), exhibited great capacity and intelligence as a military reformer. He was made admiral on the death of d'Annebaut (1552). In 1557 he was entrusted with the defence of Saint Quentin. In the siege he displayed great courage, resolution, and strength of character; but the place was taken, and he was imprisoned in the stronghold of L'Ecluse. On payment of a ransom of 50,000 crowns he recovered his liberty. But he had by this time become a Huguenot, through the influence of his brother, d'Andelot—the first letter which Calvin addressed to him is dated the 4th of September 1558—and he busied himself secretly with protecting his co-religionists, a colony of whom he sent to Brazil, whence they were afterwards expelled by the Portuguese.

On the death of Henry II. he placed himself, with Louis, prince of Condé, in the front of his sect, and demanded religious toleration and certain other reforms. In 1560, at the Assembly of Notables at Fontainebleau, the hostility between Coligny and Francis of Guise broke forth violently. When the civil wars began in 1562, Coligny decided to take arms only after long

hesitation, and he was always ready to negotiate. In none of these wars did he show superior genius, but he acted throughout with great prudence and extraordinary tenacity; he was “le héros de la mauvaise fortune.” In 1569 the defeat and death of the prince of Condé at Jarnac left him sole leader of the Protestant armies. Victorious at Arnay-le-Duc, he obtained in 1570 the pacification of St Germain. Returning to the court in 1571, he grew rapidly in favour with Charles XI. As a means of emancipating the king from the tutelage of his mother and the faction of the Guises, the admiral proposed to him a descent on Spanish Flanders, with an army drawn from both sects and commanded by Charles in person. The king's regard for the admiral, and the bold front of the Huguenots, alarmed the queen-mother; and the massacre of St Bartholomew was the consequence. On the 22nd of August 1572 Coligny was shot in the street by Maurevel, a bravo in the pay of the queen-mother and Guise; the bullets, however, only tore a finger from his right hand and shattered his left elbow. The king visited him, but the queen-mother prevented all private intercourse between them. On the 24th of August, the night of the massacre, he was attacked in his house, and a servant of the duke of Guise, generally known as Besme, slew him and cast him from a window into the courtyard at his master's feet. His papers were seized and burned by the queen-mother; among them, according to Fantôme, was a history of the civil war, “très-beau et très-bien fait, et digne d'estre imprimé.”

By his wife, Charlotte de Laval, Coligny had several children, among them being Louise, who married first Charles de Téligny and afterwards William the Silent, prince of Orange, and Francis, admiral of Guienne, who was one of the devoted servants of Henry IV. Gaspard de Coligny (1584–1646), son of Francis, was marshal of France during the reign of Louis XIII.

See Jean du Bouchet, *Preuves de l'histoire généalogique de l'illustre maison de Coligny* (Paris, 1661); biography by François Hotman, 1575 (French translation, 1665); L. J. Delaborde, *Gaspard de Coligny* (1879–1882); Erich Marcks, *Gaspard von Coligny, sein Leben und das Frankreich seiner Zeit* (Stuttgart, 1892); H. Patry, “Coligny et la Papauté,” in the *Bulletin du protestantisme français* (1902); A. W. Whitehead, *Gaspard de Coligny, Admiral of France* (1904); and C. Merki, *L'Amiral de Coligny* (1909).

COLIMA, a small Pacific coast state of Mexico, lying between Jalisco on the N.W. and N., and Michoacan on the E. Including the Revilla Gigédo islands its area is only 2272 sq. m., which thus makes it the second smallest of the Mexican states. Pop. (1895) 55,264; (1900) 65,115. The larger part of its territory is within the narrow, flat coastal plain, beyond which it rises toward the north-east into the foothills of the Sierra Madre, the higher masses of the range, including the Colima volcano, lying outside the state. It is drained by the Ameria and Coahuayana rivers and their affluents, which are largely used for irrigation. There are tidewater lagoons and morasses on the coast which accentuate its malarious character. One of the largest of these, Cuitlán, immediately south of Manzanillo, is the centre of a large salt-producing industry. The soil is generally fertile and productive, but lack of transportation facilities has been a serious obstacle to any production greatly exceeding local demands. The dry and rainy seasons are sharply defined, the rainfall being abundant in the latter. The climate is hot, humid and malarious, becoming drier and healthier on the higher mountain slopes of the interior. Stock-raising is an important industry in the higher parts of the state, but the horses, mules and cattle raised have been limited to local demands. Agriculture, however, is the principal occupation of the state, the more important products being sugar, rice, Indian corn, palm oil, coffee, indigo, cotton and cacao. The production of cacao is small, and that of indigo and cotton is declining, the latter being limited to the requirements of small local mills. There are two crops of Indian corn a year, but sugar and rice are the principal crops. The “Caracolillo” coffee, produced on the slopes of the mountains culminating in the volcano of Colima, is reputed the best in Mexico, and the entire crop (about 506,000 lb. in 1906) is consumed in the country at a price much above other grades. There are important mineral deposits in the

state, including iron, copper and lead, but mining enterprise has made no progress through lack of transportation facilities. Salt is made on the coast and shipped inland, and palm-leaf hats are manufactured and exported. Hides and deerskins are also exported in large quantities. A narrow-gauge railway has been in operation between the capital and Manzanillo for many years, and in 1907 a branch of the Mexican Central was completed between Guadalajara and the capital, and the narrow-gauge line to the coast was widened to the standard gauge. The chief cities of the state are the capital Colima, Manzanillo, Comala (the second largest town in the state), 5 m. from the capital, with which it is connected by an electric railway, Ixtlahuacan Coquimatlan and Almoloayan.

COLIMA, a city of Mexico and capital of a state of the same name, 570 m. (direct) W. by S. of Mexico City and about 36 m. inland from the Pacific coast. Pop. (1895) 18,977; (1900) 20,698. Colima is picturesquely situated on the Colima river, in a large fertile valley about 1650 ft. above the sea, and lies in the midst of fine mountain-scenery. About 30 m. to the north-east the volcano of Colima, in the state of Jalisco, rises to an elevation of 12,685 ft.; it is the most westerly of the active volcanoes of Mexico. Colima enjoys a moderately cool and healthy climate, especially in the dry season (November to June). The city is regularly laid out and is in great part well built, with good public buildings, several churches, a theatre, two hospitals, and a handsome market completed in 1905. Tramways connect the central plaza with the railway station, cemetery, and the suburb of Villa de Alvarez, 2½ m. distant, and an extension of 5 m. was projected in 1906 to Comala. The local industries include two old-fashioned cotton mills, an ice plant, corn-grinding mill, and five cigarette factories. Colima is the commercial centre for a large district, but trade has been greatly restricted by lack of transportation facilities. A railway connects with the port of Manzanillo, and the Mexican Central railway serves Colima itself. Colima was founded in 1522 by Gonzalo de Sandoval. It has not played a very prominent part in Mexican history because of its inaccessibility, and for the same reason has suffered less from revolutionary violence.

COLIN, ALEXANDRE (1526-1612), Flemish sculptor, was born at Malines. In 1563 he went, at the invitation of the emperor Ferdinand I., to Innsbruck, to work on the magnificent monument which was being erected to Maximilian I. in the nave of the Franciscan church. Of the twenty-four marble alti-rilievi, representing the emperor's principal acts and victories, which adorn the sides of this tomb, twenty were executed by Colin, apparently in three years. The work displays a remarkable combination of liveliness and spirit with extreme care and finish, its delicacy rivalling that of a fine cameo. Thorwaldsen is said to have pronounced it the finest work of its kind. Colin, who was sculptor in ordinary both to the emperor and to his son, the archduke Ferdinand of Tirol, did a great deal of work for his patrons at Innsbruck and in its neighbourhood; particular mention may be made of the sepulchres of the archduke and his first wife, Philippine Welser, both in the same church as the Maximilian monument, and of Bishop Jean Nas. His tomb in the cemetery at Innsbruck bears a fine bas-relief executed by one of his sons.

COLL, an island of the Inner Hebrides, Argyllshire, Scotland. Pop. (1901) 432. It is situated about 7 m. west of Caliac Point in Mull, and measures 12 m. from N.E. to S.W., with a breadth varying from ¾ m. to 4 m. It is composed of gneiss, is generally rather flat, save in the west where Ben Hogh reaches a height of 339 ft., and has several lakes. The pasturage is good and the soil fairly fertile. Much dairy produce is exported, besides sheep and cattle. The antiquities include stone circles, duns, the ruins of Breachacha Castle, once a fortress of the Lords of the Isles. A steamer from Oban calls regularly at Arinagour.

COLLAERT, HANS, Flemish engraver, son of Adrian Collaert, a draughtsman and engraver of repute, was born at Antwerp about 1545. After working some years in his father's studio, he went to Rome to perfect himself in his art. His engravings

after Rubens are very highly esteemed. He left many works; among the best may be mentioned a "Life of Saint Francis," 16 prints; a "Last Judgment," folio; "Monilium, Bullarum, Inauriumque Artificiosissimae Icones," 10 prints, 1581; "The Dead Christ in his Mother's Lap"; "Marcus Curtius"; "Moses Striking the Rock," and "The Resurrection of Lazarus," after Lambert Lombard; "The Fathers of the Desert"; and "Biblia Sacra and the History of the Church," after Rubens.

COLLAR, something worn or fastened round the neck (Lat. *collare*, from *collum*, neck), particularly a band of linen, lace or other material, which, under various shapes at different periods, has been worn by men and women to serve as a completion or finish to the neckband of a garment (see **COSTUME**); also a chain, worn as a personal ornament, a badge of livery, a symbol of office, or as part of the insignia of an order of knighthood, an application of the term with which the present article deals. The word is also applied to that part of the draught-harness of a horse which fits over the animal's neck, to which the traces are attached, and against which the strain of the drawing of the vehicle is exercised, and to a circular piece of metal passed round the joints of a rod or pipe, to prevent movement or to make the joint steam- or water-tight.

Necklaces with beads and jewels threaded thereon or the plain laces with a hanging ornament are among the common braveries of all times and countries. From these come the collar and the neck-chain. Torques or twisted collars of metal are found in burying-places of the barbarous people of northern Europe. British chiefs wore them, and gold torques were around the necks of the leaders of the first of the Saxon invaders of Britain, among whose descendants, however, the fashion seems to have languished. Edward the Confessor was buried with a neck-chain of gold 2 ft. long, fastened with a jewelled locket and carrying an enamelled crucifix.

The extravagant age of Richard II. saw a great revival of the neck-chain, heavy links twisted of gold or silver. From this time onward neck chains, with or without pendant devices, were commonly worn by men and women of the richer sort. The men abandoned them in the time of Charles I.

Closely allied to the chain are the livery collars which appeared in the 14th century, worn by those who thus displayed their alliances or their fealty. Thus Charles V. of France in 1378 granted to his chamberlain Geoffrey de Belleville the right of bearing in all feasts and in all companies the collar of the *Cosse de Geneste* or Broomcod, a collar which was accepted and worn even by the English kings, Charles VI. sending such collars to Richard II. and to his three uncles. This French collar, a chain of couples of broom-cods linked by jewels, is seen in the contemporary portrait of Richard II. at Wilton. The like collar was worn by Henry IV. on the way to his crowning. During the sitting of the English parliament in 1394 the complaints of the earl of Arundel against Richard II. are recorded, one of his grievances being that the king was wont to wear the livery of the collar of the duke of Lancaster, his uncle, and that people of the king's following wore the same livery. To which the king answered that soon after the return from Spain (in 1389) of his uncle, the said duke, he himself took the collar from his uncle's neck, putting it on his own, which collar the king would wear and use for a sign of the good and whole-hearted love between them, even as he wore the liveries of his other uncles. Livery collars of the king of France, of Queen Anne and of the dukes of York and Lancaster are numbered with the royal plate and jewels which in the first year of Henry IV. had come to the king's hands. The inventory shows that Queen Anne's collar was made up of sprigs of rosemary garnished with pearls. The York collar had falcons and fetterlocks, and the Lancaster collar was doubtless that collar of Esses (or S S) used by the duke's son, Henry of Bolingbroke, as an earl, duke and king. This famous livery collar, which has never passed out of use, takes many forms, its Esses being sometimes linked together chainwise, and sometimes, in early examples, bestowed as the ornamental bosses of a garter-shaped strap-collar. The oldest effigy bearing it is that in Spratton church of Sir John Swinford, who died in

1371. Swinford was a follower of John of Gaunt, and the date of his death easily disposes of the fancy that the Esses were devised by Henry IV. to stand for his motto or "word" of *Soverayne*. Many explanations are given of the origin of these letters, but none has as yet been established with sufficient proof. During the reigns of Henry IV., his son and grandson, the collar of Esses was a royal badge of the Lancastrian house and party, the white swan being its pendant. In one of Henry VI.'s own collars the S was joined to the Broomcod of the French device, thus symbolizing the king's claim to the two kingdoms.

The kings of the house of York and their chief followers wore the Yorkist collar of suns and roses, with the white lion of March, the Clare bull, or Richard's white boar for a pendant device. Henry VII. brought back the collar of Esses, a portcullis or a rose hanging from it, although in a portrait of this king, now possessed by the Society of Antiquaries, his neck bears the *rose en soleil* alternating with knots, and his son, when young, had a collar of roses red and white. Besides these royal collars, the 14th and 15th centuries show many of private devices. A brass at Mildenhall shows a knight whose badge of a dog or wolf circled by a crown hangs from a collar with edges suggesting a pruned bough or the ragged staff. Thomas of Markenfield (d. c. 1415) on his brass at Ripon has a strange collar of park palings with a badge of a hart in a park, and the Lord Berkeley (d. 1392) wears one set with mermaids.

Collars of various devices are now worn by the grand crosses of the European orders of knighthood. The custom was begun by Philip of Burgundy, who gave his knights of the Golden Fleece, an order founded on the 10th of February 1429-1430, badges of a golden fleece hung from that collar of flints, steels and sparks which is seen in so many old Flemish portraits. To this day it remains the most beautiful of all the collars, keeping in the main the lines of its Flemish designer, although a vulgar fancy sometimes destroys the symbolism of the golden fleece by changing it for an unmeaning fleece of diamonds. Following this new fashion, Louis XI. of France, when instituting his order of St Michael in 1469, gave the knights collars of scallop shells linked on a chain. The chain was doubled by Charles VIII., and the pattern suffered other changes before the order lapsed in 1830. Until the reign of Henry VIII., the Garter, most ancient of the great knightly orders, had no collar. But the Tudor king must needs match in all things with continental sovereigns, and the present collar of the Garter knights, with its golden knots and its buckled garters enclosing white roses set on red roses, has its origin in the Tudor age. An illustration in colours of the Garter collar is given on Plate I. in the article **KNIGHTHOOD AND CHIVALRY**, while descriptions of the collars of the other principal orders are also given. The collar of the Thistle with the thistles and rue-sprigs is as old as the reign of James II. The Bath collar, in its first form of white knots linking closed crowns to roses and thistles issuing from sceptres, dates from 1725, up to which time the knights of the Bath had hung their medallion from a ribbon.

Founding the order of the Saint Esprit in 1578, Henry III. of France devised a collar of enflamed fleur-de-lis and cyphers of H and L, a fashion which was soon afterwards varied by Henry his successor. Elephants have been always borne on the collar of the Elephant founded in Denmark in 1478, the other links of which have taken many shapes. Another Danish order, the Dannebrog, said to be "re-instituted" by Christian V. in 1671, has a collar of crosses formy alternating with the crowned letters C and W, the latter standing for Waldemar the Victorious, whom a legend of no value described as founding the order in 1219. Of other European orders, that of St Andrew, founded by Peter of Russia in 1698, has eagles and Andrew crosses and cyphers, while the Black Eagle of Prussia has the Prussian eagle with thunderbolts in its claws beside roundels charged with cyphers of the letters F.R.

Plain collars of Esses are now worn in the United Kingdom by kings-of-arms, heralds and serjeants-at-arms. Certain legal dignitaries have worn them since the 16th century, the collar of the lord chief-justice having knots and roses between the

letters. Henry IV.'s parliament in his second year restricted the free use of the king's livery collar to his sons and to all dukes, earls, barons and bannerets, while simple knights and squires might use it when in the royal presence or in going to and from the hostel of the king. The giving of a livery collar by the king made a squire of a man even as the stroke of the royal sword made him a knight. Collars of Esses are sometimes seen on the necks of ladies. The queen of Henry IV. wears one. So do the wife of a 16th century Knightley on her tomb at Upton, and Penelope, Lady Spencer (d. 1667), on her Brington monument.

Since 1545 the lord mayor of London has worn a royal livery collar of Esses. This collar, however, has its origin in no royal favour, Sir John Alen, thrice a lord mayor, having bequeathed it to the then lord mayor and his successors "to use and occupie yerely at and upon principall and festivall dayes." It was enlarged in 1567, and in its present shape has 28 Esses alternating with knots and roses and joined with a portcullis. Lord mayors of York use a plain gold chain of a triple row of links given in 1670; this chain, since the day when certain links were found wanting, is weighed on its return by the outgoing mayor. In Ireland the lord mayor of Dublin wears a collar given by Charles II., while Cork's mayor has another which the Cork council bought of a silversmith in 1755, stipulating that it should be like the Dublin one. The lady mayoress of York wears a plain chain given with that of the lord mayor in 1670, and, like his, weighed on its return to official keeping. For some two hundred and thirty years the mayoress of Kingston-on-Hull enjoyed a like ornament until a thrifty council in 1835 sold her chain as a useless thing.

Of late years municipal patriotism and the persuasions of enterprising tradesmen have notably increased the number of English provincial mayors wearing collars or chains of office. Unlike civic maces, swords and caps of maintenance, these gauds are without significance. The mayor of Derby is decorated with the collar once borne by a lord chief-justice of the king's bench, and his brother of Kingston-on-Thames uses without authority an old collar of Esses which once hung over a herald's tabard. By a modern custom the friends of the London sheriffs now give them collars of gold and enamel, which they retain as mementoes of their year of office. (O. BA.)

COLLATERAL (from Med. Lat. *collateralis*,—*cum*, with, and *latus*, *lateris*, side,—side by side, hence parallel or additional), a term used in law in several senses. *Collateral relationship* means the relationship between persons who are descended from the same stock or ancestor, but in a different line; as opposed to *lineal*, which is the relationship between ascendants and descendants in a direct line, as between father and son, grandfather and grandson. A *collateral agreement* is an agreement made contemporaneously with a written contract as part of the transaction, but without being incorporated with it. *Collateral facts*, in evidence, are those facts which do not bear directly on the matters in dispute. *Collateral security* is an additional security for the better safety of the mortgagee, *i.e.* property or right of action deposited to secure the fulfilment of an obligation.

COLLATIA, an ancient town of Latium, 10 m. E. by N. of Rome by the Via Collatina. It appears in the legendary history of Rome as captured by Tarquinius Priscus. Livy tells us it was taken from the Sabines, while Virgil speaks of it as a Latin colony. In the time of Cicero it had lost all importance; Strabo names it as a mere village, in private hands, while for Pliny it was one of the lost cities of Latium. The site is undoubtedly to be sought on the hill now occupied by the large medieval fortified farmhouse of Lunghezza, immediately to the south of the Anio, which occupies the site of the citadel joined by a narrow neck to the tableland to the south-east on which the city stood. This is protected by wide valleys on each side, and is isolated at the south-east end by a deep narrow valley enlarged by cutting. No remains are to be seen, but the site is admirably adapted for an ancient settlement. The road may be traced leading to the south end of this tableland, being identical with the modern road to Lunghezza for the middle part of its course

only. The current identification with Castellaccio, 2 m. to the south-east, is untenable.

See T Ashby in *Papers of the British School at Rome*, i. 138 seq., iii. 201. (T As.)

COLLATION (Lat. *collatio*, from *conferre*, to bring together or compare), the bringing together of things for the special purpose of comparison, and thus, particularly, the critical examination of the texts of documents or MSS. and the result of such comparison. The word is also a term in printing and bookbinding for the register of the "signatures," the number of quires and leaves in each quire of a book or MS. In Roman and Scots law "collation" answers to the English law term "hotch-pot" (*q.v.*). From another meaning of the Latin word, a consultation or conference, and so a treatise or homily, comes the title of a work of Johannes Cassianus (*q.v.*), the *Conferences of the Fathers* (*Collationes Patrum*). Readings from this and similar works were customary in monasteries; by the *regula* of St Benedict it is ordered that on rising from supper there should be read *collationes*, passages from the lives of the Fathers and other edifying works; the word is then applied to the discussions arising from such readings. On fast days it was usual in monasteries to have a very light meal after the *Collatio*, and hence the meal itself came to be called "collation," a meaning which survives in the modern use of the word for any light or quickly prepared repast.

COLLÉ, CHARLES (1709-1783), French dramatist and songwriter, the son of a notary, was born at Paris in 1709. He was early interested in the rhymes of Jean Héguanier, then the most famous maker of couplets in Paris. From a notary's office Collé was transferred to that of M. de Neulan, the receiver-general of finance, and remained there for nearly twenty years. When about seventeen, however, he made the acquaintance of Alexis Piron, and afterwards, through Gallet (d. 1757), of Panard. The example of these three masters of the vaudeville, while determining his vocation, made him diffident; and for some time he composed nothing but *amphigouris*—verses whose merit was measured by their unintelligibility. The friendship of the younger Crébillon, however, diverted him from this by-way of art, and the establishment in 1729 of the famous "Caveau" gave him a field for the display of his fine talent for popular song. In 1739 the Society of the Caveau, which numbered among its members Helvétius, Charles Duclos, Pierre Joseph Bernard, called Gentil-Bernard, Jean Philippe Rameau, Alexis Piron, and the two Crébillons, was dissolved, and was not reconstituted till twenty years afterwards. His first and his best comedy, *La Vérité dans le vin*, appeared in 1747. Meanwhile, the Regent Orleans, who was an excellent comic actor, particularly in representations of low life, and had been looking out for an author to write suitable parts for him, made Collé his reader. It was for the duke and his associates that Collé composed the greater part of his *Théâtre de société*. In 1763 Collé produced at the Théâtre Français *Dupuis et Desronais*, a successful sentimental comedy, which was followed in 1771 by *La Veuve*, which was a complete failure. In 1774 appeared *La Partie de chasse de Henri Quatre* (partly taken from Dodsley's *King and the Miller of Mansfield*), Collé's last and best play. From 1748 to 1772, besides these and a multitude of songs, Collé was writing his *Journal*, a curious collection of literary and personal strictures on his boon companions as well as on their enemies, on Piron as on Voltaire, on La Harpe as on Corneille. Collé died on the 3rd of November 1783. His lyrics are frank and jovial, though often licentious. The subjects are love and wine; occasionally, however, as in the famous lyric (1756) on the capture of Port Mahon, for which the author received a pension of 600 livres, the note of patriotism is struck with no unskilful hand, while in many others Collé shows himself possessed of considerable epigrammatic force.

See also H. Bonhomme's edition (1868) of his *Journal et Mémoires* (1748-1772); Grimm's *Correspondance*; and C. A. Sainte-Beuve, *Nouveaux lundis*, vol. vii.

COLLECTIVISM, a term used to denote the economic principle of the ownership by a community of all the means of production

in order to secure to the people collectively an equitable distribution of the produce of their associated labour. Though often used in a narrow sense to express the economic basis of Socialism, the latter term is so generally employed in the same sense that collectivism is best discussed in connexion with it (see SOCIALISM).

COLLECTOR, a term technically used for various officials, and particularly in India for the chief administrative official of a district. The word was in this case originally a translation of *tahsildar*, and indicates that the special duty of the office is the collection of revenue; but the collector has also magisterial powers and is a species of autocrat within the bounds of his district. The title is confined to the regulation provinces, especially Madras; in the non-regulation provinces the same duties are discharged by the deputy-commissioner (see COMMISSIONER).

COLLE DI VAL D' ELSA, a town and episcopal see of Italy, in the province of Siena, 5 m. by rail S. of Poggibonsi, which is 16 m. N.W. of Siena. Pop. (1901) town 1987; commune 9879. The old (upper) town (732 ft. above sea-level), contains the cathedral, dating from the 13th century, with a pulpit partly of this period; the façade has been modernized. There are also some old palaces of good architecture, and the old house where Arnolfo di Cambio, the first architect of the cathedral at Florence (1232-1301) was born. The lower town (460 ft.) contains glass-works; the paper and iron industries (the former as old as 1377) are less important.

COLLEGE (*Collegium*), in Roman law, a number of persons associated together by the possession of common functions,—a body of colleagues. Its later meaning applied to any union of persons, and *collegium* was the equivalent of *ἐταίρεια*. In many respects, *e.g.* in the distinction between the responsibilities and rights of the society and those of individual members thereof, the collegium was what we should now call a corporation (*q.v.*). Collegia might exist for purposes of trade like the English guilds, or for religious purposes (*e.g.* the college of augurs, of pontifices, &c.), or for political purposes, *e.g.* *tribunorum plebis collegia*. By the Roman law a collegium must have at least three members. The name is now usually applied to educational corporations, such as the colleges of Oxford and Cambridge, with which, in the numerous English statutes relating to colleges, the colleges of Winchester and Eton are usually associated. These colleges are in the eye of the law eleemosynary corporations. In some of the earlier statutes of Queen Elizabeth they are spoken of as having an ecclesiastical character, but the doctrine of the common law since the Reformation has been that they are purely lay corporations, notwithstanding that most or all of their members may be persons in priest's orders. This is said to have been settled by Dr Patrick's case (*Raymond's Reports*, p. 101).

Colleges appear to have grown out of the voluntary association of students and teachers at the university. According to some accounts these must at one time have been numerous and flourishing beyond anything we are now acquainted with. We are told, for example, of 300 halls or societies at Oxford, and 30,000 students. In early times there seems to have been a strong desire to confine the scholars to certain licensed houses beyond the influence of the townspeople. Men of wealth and culture, and notably the political bishops and chancellors of England, obtained charters from the crown for the incorporation of societies of scholars, and these in time became exclusively the places of abode for students attending the university. At the same time the corporations thus founded were not necessarily attached to the locality of the university. The early statutes of Merton College, for example, allow the residence of the college to be shifted as occasion required; and the foundations of Wolsey at Oxford and Ipswich seem to have been the same in intention. In later times (until the introduction of non-collegiate students) the university and the colleges became coextensive; every member of the university had to attach himself to some college or hall, and every person admitted to a college or hall was obliged to matriculate himself in the university.

In Ayliffe's *Ancient and Present State of the University of Oxford* it is stated that a college must be "made up of three persons (at least) joined in community. And the reason of this almost seems

to speak its own necessity, without the help of any express law to countenance it: because among two persons only there cannot be, in fact, a major part; and then if any disagreement should happen to arise between them it cannot be, in fact, brought to a conclusion by such a number alone in case both the parties should firmly adhere to their dissenting opinions; and thus it is declared by the civil law. But by the canon law it is known to be otherwise; for by that law two persons in number may make and constitute a college, forasmuch as according to this law two persons make and constitute an assembly or congregation. The common law of England, or rather the constant usage of our princes in erecting aggregate bodies, which has established this rule among us as a law, has been herein agreeable to the method and doctrine of the civil law, for that in all their grants and charters of incorporation of colleges they have not framed any aggregate body consisting of less than three in number." Another principle, apparently derived from the civil law, is that a man cannot be a fellow in two colleges at the same time. The law of England steadily resisted any attempt to introduce the principle of inequality into colleges. An act of 1542, reciting that divers founders of colleges have given in their statutes a power of veto to individual members, enacts that every statute made by any such founder, whereby the grant or election of the governor or ruler with the assent of the most part of such corporation should be in any wise hindered by any one or more being the lesser number (contrary to the common law), shall be void.

The corporation consists of a head or master, fellows and scholars. Students, not being on the foundation, residing in the college, are not considered to be members of the corporation. The governing body in all cases is the head and fellows.

It is considered essential to corporations of an ecclesiastical or educational character that they should have a Visitor whose duty it is to see that the statutes of the founder are obeyed. The duties of this officer have been ascertained by the courts of law in a great variety of decided cases. Subject to such restrictions as may be imposed on him by the statutes of the college, his duties are generally to interpret the statutes of the college in disputed cases, and to enforce them where they have been violated. For this purpose he is empowered to "visit" the society—usually at certain stated intervals. In questions within his jurisdiction his judgment is conclusive, but his jurisdiction does not extend to any cases under the common laws of the country, or to trusts attached to the college. Generally the visitorship resides in the founder and his heirs unless he has otherwise appointed, and in default of him in the crown.

The fellowships, scholarships, &c., of colleges were until a comparatively recent date subject to various restrictions. Birth in a particular county, education at a particular school, relationship to the founder and holy orders, are amongst the most usual of the conditions giving a preferential or conclusive claim to the emoluments. Most of these restrictions have been or are being swept away. (See UNIVERSITIES; OXFORD; CAMBRIDGE; &c.)

The term "college" (like "academy") is also applied to various institutions, e.g. to colleges of physicians and surgeons, and to the electoral college in the United States presidential elections, &c. For the Sacred College see CARDINAL.

COLLEONI, BARTOLOMMEO (1400–1475), Italian soldier of fortune, was born at Bergamo. While he was still a child his father was attacked and murdered in his castle of Trezzo by Filippo Maria Visconti, duke of Milan. After wandering about Italy he entered the service of various *condottieri*, such as Braccio da Montone and Carmagnola. At the age of thirty-two he was serving the Venetian republic, and although Francesco Maria Gonzaga was commander-in-chief, Colleoni was the life and soul of the army. He recaptured many towns and districts for Venice from the Milanese, and when Gonzaga went over to the enemy he continued to serve the Venetians under Erasmo da Narni (known as Gattamelata) and Francesco A. Sforza, winning battles at Brescia, Verona and on the lake of Garda. When peace was made between Milan and Venice in 1441 Colleoni went over to the Milanese, together with Sforza in 1443. But although

well treated at first, he soon fell under the suspicion of the treacherous Visconti and was imprisoned at Monza, where he remained until the duke's death in 1447. Milan then fell under the lordship of Sforza, whom Colleoni served for a time, but in 1448 he took leave of Sforza and returned to the Venetians. Disgusted at not having been elected captain-general, he went over to Sforza once more, but Venice could not do without him and by offering him increased emoluments induced him to return, and in 1455 he was appointed captain-general of the republic for life. Although he occasionally fought on his own account, when Venice was at peace, he remained at the disposal of the republic in time of war until his death.

Colleoni was perhaps the most respectable of all the Italian *condottieri*, and although he often changed sides, no act of treachery is imputed to him, nor did he subject the territories he passed through to the rapine and exactions practised by other soldiers of fortune. When not fighting he devoted his time to introducing agricultural improvements on the vast estates with which the Venetians had endowed him, and to charitable works. At his death in 1475 he left a large sum to the republic for the Turkish war, with a request that an equestrian statue of himself should be erected in the Piazza San Marco. The statue was made by Verrocchio, but as no monument was permitted in the famous Piazza it was placed opposite the hospital of St Mark by way of compromise.

See G. M. Bonomi, *Il Castello di Cavernago e i conti Martinengo Colleoni* (Bergamo, 1884); for an account of his wars see S. Romanin, *Storia documentata di Venezia*, vol. iv. (Venice, 1855), and other histories of Venice. (L. V. *)

COLLETER (Gr. κόλλος, glue), a botanical term for the gum-secreting hairs on the buds of certain plants.

COLLETTA, PIETRO (1775–1831), Neapolitan general and historian, entered the Neapolitan artillery in 1796 and took part in the campaign against the French in 1798. On the entry of the French into Naples and the establishment of the Parthenopean republic (1799) he adhered to the new government, and when the Bourbon king Ferdinand IV. (*q.v.*) reconquered the city Colletta was thrown into prison and only escaped the death penalty by means of judiciously administered bribes. Turned out of the army he became a civil engineer, but when the Bourbons were expelled a second time in 1806 and Joseph Bonaparte seized the throne of Naples, he was reinstated in his rank and served in the expedition against the brigands and rebels of Calabria. In 1812 he was promoted general, and made director of roads and bridges. He served under Joachim Murat and fought the Austrians on the Panaro in 1815. On the restoration of Ferdinand Colletta was permitted to retain his rank in the army, and given command of the Salerno division. At the outbreak of the revolution of 1820 the king called him to his councils, and when the constitution had been granted Colletta was sent to put down the separatist rising in Sicily, which he did with great severity. He fought in the constitutionalist army against the Austrians at Rieti (7th of March 1821), and on the re-establishment of autocracy he was arrested and imprisoned for three months by order of the prince of Canosa, the chief of police, his particular enemy. He would have been executed had not the Austrians intervened in his favour, and he was exiled instead to Brünn in Moravia; in 1823 he was permitted to settle in Florence, where he spent the rest of his days engaged on his *Storia del reame di Napoli*. He died in 1831. His history (1st ed., Capolago, 1834), which deals with the reigns of Charles III. and Ferdinand IV. (1734–1825), is still the standard work for that period; but its value is somewhat diminished by the author's bitterness against his opponents and the fact that he does not give chapter and verse for his statements, many of which are based on his recollection of documents seen, but not available at the time of writing. Still, having been an actor in many of the events recorded, he is on the whole accurate and trustworthy.

See Gino Capponi's memoir of him published in the *Storia del reame di Napoli* (2nd ed., Florence, 1848). (L. V. *)

COLLEY, SIR GEORGE POMEROY (1835–1881), British general, third son of George Pomeroy Colley, of Rathangan,

Co. Kildare, Ireland, and grandson of the fourth Viscount Harberton, was born on the 1st of November 1835, and entered the 2nd Queen's Regiment from Sandhurst as ensign in 1852. From 1854 to 1860 he served in South Africa, and was employed in surveying and as a magistrate in charge of the Bashi river district in Kaffraria. Early in 1860 he went with his regiment to China to join the Anglo-French expedition, and took part in the capture of the Taku forts and the entry into Peking, returning to South Africa to complete his work in Kaffraria (brevet-majority). In 1862 he entered the Staff College and passed out in one year with honours. After serving as brigade-major at Devonport for five years, he went to the War Office in 1870 to assist in the preparation of (Lord) Cardwell's measures of army reform. He was appointed professor of military administration at the Staff College in 1871. Early in 1873 he joined Sir Garnet Wolseley at the Gold Coast, where he took charge of the transport, and the success of the Ashanti expedition was in no small degree due to his exertions. He was promoted brevet-colonel and awarded the C.B. In 1875 he accompanied Wolseley to Natal (C.M.G.). On his return home he was appointed military secretary to Lord Lytton, governor-general of India, and in 1877 private secretary (K.C.S.I.). In 1879 he joined Wolseley as chief of the staff and brigadier-general in S.E. Africa, but, on the murder of Cavagnari at Kabul, returned to India. In 1880 he succeeded Wolseley in S.E. Africa as high commissioner and general commanding, and conducted the operations against the rebel Boers. He was defeated at Laing's Nek and at the Ingogo river, and killed at Majuba Hill on the 27th of February 1881. He had a very high reputation not only for a theoretical knowledge of military affairs, but also as a practical soldier.

See *Life of Sir George Pomeroy Colley* by Lieut.-Gen. Sir W. F. Butler (London, 1899).

COLLIER, ARTHUR (1680–1732), English philosopher, was born at the rectory of Steeple Langford, Wiltshire, on the 12th of October 1680. He entered at Pembroke College, Oxford, in July 1697, but in October 1698 he and his brother William became members of Balliol. His father having died in 1697, it was arranged that the family living of Langford Magna should be given to Arthur as soon as he was old enough. He was presented to the benefice in 1704, and held it till his death. His sermons show no traces of his bold theological speculations, and he seems to have been faithful in the discharge of his duty. He was often in pecuniary difficulties, from which at last he was obliged to free himself by selling the reversion of Langford rectory to Corpus Christi College, Oxford. His philosophical opinions grew out of a diligent study of Descartes and Malebranche. John Norris of Bemerton also strongly influenced him by his *Essay on the Ideal World* (1701–1704). It is remarkable that Collier makes no reference to Locke, and shows no sign of having any knowledge of his works. As early as 1703 he seems to have become convinced of the non-existence of an external world. In 1712 he wrote two essays, which are still in manuscript, one on substance and accident, and the other called *Clavis Philosophica*. His chief work appeared in 1713, under the title *Clavis Universalis*, or a *New Inquiry after Truth*, being a *Demonstration of the Non-Existence or Impossibility of an External World* (printed privately, Edinburgh, 1836, and reprinted in *Metaphysical Tracts*, 1837, edited by Sam. Parr). It was favourably mentioned by Reid, Stewart and others, was frequently referred to by the Leibnitzians, and was translated into German by von Eschenbach in 1756. Berkeley's *Principles of Knowledge* and *Theory of Vision* preceded it by three and four years respectively, but there is no evidence that they were known to Collier before the publication of his book.

His views are grounded on two presuppositions:—first, the utter aversion of common sense to any theory of representative perception; second, the opinion which Collier held in common with Berkeley, and Hume afterwards, that the difference between imagination and sense perception is only one of degree. The former is the basis of the negative part of his argument; the latter supplies him with all the positive account he has to give, and that is meagre enough. The *Clavis* consists of two parts. After explaining that he will use the term "external world" in the sense of absolute, self-existent, independent matter, he attempts in the first part to prove that the

visible world is not external, by showing—first, that the seeming externality of a visible object is no proof of real externality, and second, that a visible object, as such, is not external. The image of a centaur seems as much external to the mind as any object of sense; and since the difference between imagination and perception is only one of degree, God could so act upon the mind of a person imagining a centaur, that he would perceive it as vividly as any object can be seen. Similar illustrations are used to prove the second proposition, that a visible object, as such, is not external. The first part ends with a reply to objections based on the universal consent of men, on the assurance given by touch of the extra existence of the visible world, and on the truth and goodness of God (Descartes), which would be impugned if our senses deceived us. Collier argues naively that if universal consent means the consent of those who have considered the subject, it may be claimed for his view. He thinks with Berkeley that objects of sight are quite distinct from those of touch, and that the one therefore cannot give any assurance of the other; and he asks the Cartesians to consider how far God's truth and goodness are called in question by their denial of the externality of the secondary qualities. The second part of the book is taken up with a number of metaphysical arguments to prove the impossibility of an external world. The pivot of this part is the logical principle of contradiction. From the hypothesis of an external world a series of contradictions are deduced, such as that the world is both finite and infinite, is movable and immovable, &c.; and finally, Aristotle and various other philosophers are quoted, to show that the external matter they dealt with, as mere potentiality, is just nothing at all. Among other uses and consequences of his treatise, Collier thinks it furnishes an easy refutation of the Romish doctrine of transubstantiation. If there is no external world, the distinction between substance and accidents vanishes, and these become the sole essence of material objects, so that there is no room for any change whilst they remain as before. Sir William Hamilton thinks that the logically necessary advance from the old theory of representative perception to idealism was stayed by anxiety to save this miracle of the church; and he gives Collier credit for being the first to make the discovery.

His *Clavis Universalis* is interesting on account of the resemblance between its views and those of Berkeley. Both were moved by their dissatisfaction with the theory of representative perception. Both have the feeling that it is inconsistent with the common sense of mankind, which will insist that the very object perceived is the sole reality. They equally affirm that the so-called representative image is the sole reality, and discard as unthinkable the unperceiving material cause of the philosophers. Of objects of sense, they say, their *esse is percipi*. But Collier never got beyond a bald assertion of the fact, while Berkeley addressed himself to an explanation of it. The thought of a distinction between direct and indirect perception never dawned upon Collier. To the question how all matter exists in dependence on percipient mind his only reply is, "Just how my reader pleases, provided it be somehow." As cause of our sensations and ground of our belief in externality, he substituted for an unintelligible material substance an equally unintelligible operation of divine power. His book exhibits no traces of a scientific development. The most that can be said about him is that he was an intelligent student of Descartes and Malebranche, and had the ability to apply the results of his reading to the facts of his experience. In philosophy he is a curiosity, and nothing more. His biographer attributes the comparative failure of the *Clavis* to its inferiority in point of style, but the crudeness of his thought had quite as much to do with his failure to gain a hearing. Hamilton (*Discussions*, p. 197) allows greater sagacity to Collier than to Berkeley, on the ground that he did not vainly attempt to enlist men's natural belief against the hypothetical realism of the philosophers. But Collier did so as far as his light enabled him. He appealed to the popular conviction that the proper object of sense is the sole reality, although he despaired of getting men to give up their belief in its externality, and asserted that nothing but prejudice prevented them from doing so; and there is little doubt that, if it had ever occurred to him, as it did to Berkeley, to explain the genesis of the notion of externality, he would have been more hopeful of commending his theory to the popular mind.

In theology Collier was an adherent of the High Church party, though his views were by no means orthodox. In the Jacobite *Mist's Journal* he attacked Bishop Hoadly's defence of sincere errors. His views on the problems of Arianism, and his attempt to reconcile it with orthodox theology, are contained in *A Specimen of True Philosophy* (1730, reprinted in *Metaphysical Tracts*, 1837) and *Logology, or a Treatise on the Logos in Seven Sermons on John i. 1, 2, 3, 14* (1732, analysed in *Metaph. Tracts*). These may be compared with Berkeley's *Siris*.

See Robt. Benson, *Memoirs of the Life and Writings of Arthur Collier* (1837); Tennemann, *History of Philosophy*; Hamilton, *Discussions*; A. C. Fraser, edition of *Berkeley's Works*; G. Lyon, "Un Idéaliste anglais au XVIII. siècle," in *Rev. philos.* (1880), x. 375.

COLLIER, JEREMY (1650–1726), English nonjuring divine, was born at Stow-with-Quy, Cambridgeshire, on the 23rd of September 1650. He was educated at Ipswich free school; over

which his father presided, and at Caius College, Cambridge, graduating B.A. in 1673 and M.A. in 1676. He acted for a short time as a private chaplain, but was appointed in 1679 to the small rectory of Ampton, near Bury St Edmunds, and in 1685 he was made lecturer of Gray's Inn.

At the Revolution he was committed to Newgate for writing in favour of James II. a tract entitled *The Desertion discuss'd in a Letter to a Country Gentleman* (1688), in answer to Bishop Burnet's defence of King William's position. He was released after some months of imprisonment, without trial, by the intervention of his friends. In the two following years he continued to harass the government by his publications: and in 1692 he was again in prison under suspicion of treasonable correspondence with James. His scruples forbade him to acknowledge the jurisdiction of the court by accepting bail, but he was soon released. But in 1696 for his boldness in granting absolution on the scaffold to Sir John Friend and Sir William Parkyns, who had attempted the assassination of William, he was obliged to flee, and for the rest of his life continued under sentence of outlawry.

When the storm had blown over he returned to London, and employed his leisure in works which were less political in their tone. In 1697 appeared the first volume of his *Essays on Several Moral Subjects*, to which a second was added in 1705, and a third in 1709. The first series contained six essays, the most notable being that "On the office of a Chaplain," which throws much light on the position of a large section of the clergy at that time. Collier deprecated the extent of the authority assumed by the patron and the servility of the poorer clergy.

In 1698 Collier produced his famous *Short View of the Immorality and Profaneness of the English Stage*. . . . He dealt with the immodesty of the contemporary stage, supporting his contentions by a long series of references attesting the comparative decency of Latin and Greek drama; with the profane language indulged in by the players; the abuse of the clergy common in the drama; the encouragement of vice by representing the vicious characters as admirable and successful; and finally he supported his general position by the analysis of particular plays, Dryden's *Amphitryon*, Vanbrugh's *Relapse* and D'Urfey's *Don Quixote*. The book abounds in hypercriticism, particularly in the imputation of profanity; and in a useless display of learning, neither intrinsically valuable nor conducive to the argument. He had no artistic appreciation of the subject he discussed, and he mistook cause for effect in asserting that the decline in public morality was due to the flagrant indecency of the stage. Yet, in the words of Macaulay, who gives an admirable account of the discussion in his essay on the comic dramatists of the Restoration, "when all deductions have been made, great merit must be allowed to the work." Dryden acknowledged, in the preface to his *Fables*, the justice of Collier's strictures, though he protested against the manner of the onslaught; but Congreve made an angry reply; Vanbrugh and others followed. Collier was prepared to meet any number of antagonists, and defended himself in numerous tracts. *The Short View* was followed by a *Defence* (1699), a *Second Defence* (1700), and *Mr Collier's Dissuasive from the Playhouse, in a Letter to a Person of Quality* (1703), and a *Further Vindication* (1708). The fight lasted in all some ten years; but Collier had right on his side, and triumphed; his position was, moreover, strengthened by the fact that he was known as a Troy and high churchman, and that his attack could not, therefore, be assigned to Puritan rancour against the stage.

From 1701 to 1721 Collier was employed on his *Great Historical, Geographical, Genealogical and Poetical Dictionary*, founded on, and partly translated from, Louis Moréri's *Dictionnaire historique*, and in the compilation and issue of the two volumes folio of his own *Ecclesiastical History of Great Britain from the first planting of Christianity to the end of the reign of Charles II.*

¹ "He is too much given to horse-play in his raillery, and comes to battle like a dictator from the plough. I will not say, 'the zeal of God's house has eaten him up'; but I am sure it has devoured some part of his good manners and civility" (Dryden, *Works*, ed. Scott, xi. 239).

(1708-1714). The latter work was attacked by Burnet and others but the author showed himself as keen a controversialist as ever. Many attempts were made to shake his fidelity to the lost cause of the Stuarts, but he continued indomitable to the end. In 1712 George Hickes was the only survivor of the nonjuring bishops, and in the next year Collier was consecrated. He had a share in an attempt made towards union with the Greek Church. He had a long correspondence with the Eastern authorities, his last letters on the subject being written in 1725. Collier preferred the version of the *Book of Common Prayer* issued in 1549, and regretted that certain practices and petitions there enjoined were omitted in later editions. His first tract on the subject, *Reasons for Restoring some Prayers* (1717), was followed by others. In 1718 was published a new *Communion Office taken partly from Primitive Liturgies and partly from the first English Reformed Common Prayer Book*, . . . which embodied the changes desired by Collier. The controversy that ensued made a split in the nonjuring communion. His last work was a volume of *Practical Discourses*, published in 1725. He died on the 26th of April 1726.

BIBLIOGRAPHY.—There is an excellent account of Collier in A. Kippis's *Biographia Britannica*, vol. iv. (1789), where some sensible observations by the editor are added to the original biography. A full list of Collier's writings is given by the Rev. Wm. Hunt in the article in the *Dictionary of National Biography*. For particulars of Collier's history as a nonjuring bishop, see Thomas Lathbury, *A History of the Nonjurors* . . . (1845). There is an excellent account of the *Short View* and the controversy arising from it in A. Beljame's *Le Public et les hommes de lettres en Angleterre au XVIII^e siècle* (2nd ed., 1897), pp. 244-263.

COLLIER, JOHN PAYNE (1789-1883), English Shakespearian critic, was born in London, on the 11th of January 1789. His father, John Dyer Collier (1762-1825), was a successful journalist, and his connexion with the press obtained for his son a position on the *Morning Chronicle* as leader writer, dramatic critic and reporter, which continued till 1847; he was also for some time a reporter for *The Times*. He was summoned before the House of Commons in 1819 for giving an incorrect report of a speech by Joseph Hume. He entered the Middle Temple in 1811, but was not called to the bar until 1829. The delay was partly due to his indiscretion in publishing the *Criticisms on the Bar* (1819) by "Amicus Curiae." His leisure was given to the study of Shakespeare and the early English drama. After some minor publications he produced in 1825-1827 a new edition of Dodsley's *Old Plays*, and in 1833 a supplementary volume entitled *Five Old Plays*. In 1831 appeared his *History of English Dramatic Poetry and Annals of the Stage to the Restoration*, a badly arranged, but valuable work. It obtained for him the post of librarian to the duke of Devonshire, and, subsequently, access to the chief collections of early English literature throughout the kingdom, especially to the treasures of Bridgewater House. These opportunities were unhappily misused to effect a series of literary fabrications, which may be charitably, and perhaps not unjustly, attributed to literary monomania, but of which it is difficult to speak with patience, so completely did they for a long time bewilder the chronology of Shakespeare's writings, and such suspicion have they thrown upon MS. evidence in general. After *New Facts*, *New Particulars* and *Further Particulars* respecting Shakespeare had appeared and passed muster, Collier produced (1852) the famous *Perkins Folio*, a copy of the second folio (1632), so called from a name written on the title-page. On this book were numerous MS. emendations of Shakespeare said by Collier to be from the hand of "an old corrector." He published these corrections as *Notes and Emendations to the Text of Shakespeare* (1852), and boldly incorporated them in his edition (1853) of Shakespeare. Their authenticity was disputed by S. W. Singer in *The Text of Shakespeare Vindicated* (1853) and by E. A. Brae in *Literary Cookery* (1855) on internal evidence; and when in 1859 the folio was submitted by its owner, the duke of Devonshire, to experts at the British Museum, the emendations were incontestably proved to be forgeries of modern date. Collier was exposed by Mr Nicholas Hamilton in his *Inquiry* (1860). The point whether he was deceiver or

deceived was left undecided, but the falsifications of which he was unquestionably guilty among the MSS. at Dulwich College have left little doubt respecting it. He had produced the *Memoirs of Edward Alleyn* for the Shakespeare Society in 1841. He followed up this volume with the *Alleyn Papers* (1843) and the *Diary of P. Henslowe* (1845). He forged the name of Shakespeare in a genuine letter at Dulwich, and the spurious entries in Alleyn's *Diary* were proved to be by Collier's hand when the sale of his library in 1884 gave access to a transcript he had made of the *Diary* with interlineations corresponding with the Dulwich forgeries. No statement of his can be accepted without verification, and no manuscript he has handled, without careful examination, but he did much useful work. He compiled a valuable *Bibliographical and Critical Account of the Rarest Books in the English Language* (1865); he reprinted a great number of early English tracts of extreme rarity, and rendered good service to the numerous antiquarian societies with which he was connected, especially in the editions he produced for the Camden Society and the Percy Society. His *Old Man's Diary* (1871-1872) is an interesting record, though even here the taint of fabrication is not absent. Unfortunately what he did amiss is more striking to the imagination than what he did aright, and he will be chiefly remembered by it. He died at Maidenhead, where he had long resided, on the 17th of September 1883.

For an account of the discussion raised by Collier's emendations see C.M. Ingleby, *Complete View of the Shakespeare Controversy* (1861).

COLLIN, HEINRICH JOSEPH VON (1771-1811), Austrian dramatist, was born in Vienna, on the 26th of December 1771. He received a legal education and entered the Austrian ministry of finance where he found speedy promotion. In 1805 and in 1809, when Austria was under the heel of Napoleon, Collin was entrusted with important political missions. In 1803 he was, together with other members of his family, ennobled, and in 1809 made *Hofrat*. He died on the 28th of July 1811. His tragedy *Regulus* (1801), written in strict classical form, was received with enthusiasm in Vienna, where literary taste, less advanced than that of North Germany, was still under the ban of French classicism. But in his later dramas, *Coriolan* (1804), *Polyxena* (1804), *Balboa* (1806), *Bianca della Porta* (1808), he made some attempt to reconcile the pseudo-classic type of tragedy with that of Shakespeare and the German romanticists. As a lyric poet (*Gedichte*, collected 1812), Collin has left a collection of stirring *Wehrmannslieder* for the fighters in the cause of Austrian freedom, as well as some excellent ballads (*Kaiser Max auf der Martinswand*, *Herzog Leopold vor Solothurn*). His younger brother Matthäus von Collin (1779-1824), was, as editor of the *Wiener Jahrbücher für Literatur*, an even more potent force in the literary life of Vienna. He was, moreover, in sympathy with the Romantic movement, and intimate with its leaders. His dramas on themes from Austrian national history (*Belas Krieg mit dem Vater*, 1808, *Der Tod Friedrichs des Streibaren*, 1813) may be regarded as the immediate precursors of Grillparzer's historical tragedies.

His *Gesammelte Werke* appeared in 6 vols. (1812-1814); he is the subject of an excellent monograph by F. Laban (1879). See also A. Hauffen, *Das Drama der klassischen Periode*, ii, 2 (1891), where a reprint of *Regulus* will be found. M. von Collin's *Dramatische Dichtungen* were published in 4 vols. (1815-1817); his *Nachgelassene Schriften*, edited by J. von Hammer, in 2 vols. (1827). A study of his life and work by J. Wihan will be found in *Euphorion*, Ergänzungsheft, v. (1901).

COLLIN D'HARLEVILLE, JEAN FRANCOIS (1755-1806), French dramatist, was born at Mévoisins, near Maintenon (Eure-et-Loire), on the 30th of May 1755. His first dramatic success was *L'Inconstant*, a comedy accepted by the Comédie Française in 1780, but not produced there until six years later, though it was played elsewhere in 1784. This was followed by *L'Optimiste, ou l'homme toujours content* (1788), and *Châteaux en Espagne* (1789). His best play, *Le Vieux Célibataire*, appeared in 1793. Among his other plays are—the one-act comedy *Monsieur de Crac dans son petit castel* (1791), *Les Artistes* (1796), *Les Mœurs du jour* (1800) and *Malice pour malice* (1803).

Collin was one of the original members of the Institute of France, and died in Paris on the 24th of February 1806.

The 1822 edition of his *Théâtre et poésies fugitives* contains a notice by his friend the dramatist Andrieux. His *Théâtre* was also edited by L. Moland in 1876; and by Édouard Thierry in 1882.

COLLING, ROBERT (1749-1820), and **CHARLES** (1751-1836), English stock breeders, famous for their improvement of the Shorthorn breed of cattle, were the sons of Charles Colling, a farmer of Ketton near Darlington. Their lives are closely connected with the history of the Shorthorn breed. Of the two brothers, Charles is probably the better known, and it was his visit to the farm of Robert Bakewell at Dishley that first led the brothers to realize the possibilities of scientific cattle breeding. Charles succeeded to his father's farm at Ketton. Robert, after being first apprenticed to a grocer in Shields, took a farm at Barmpton. An animal which he bought at Charles's advice for £8 and afterwards sold to his brother, became known as the celebrated "Hubback," a bull which formed the basis of both the Ketton and Barmpton herds. The two brothers pursued the same system of "in and in" breeding which they had learned from Bakewell, and both the Ketton and the Barmpton herds were sold by auction in the autumn of 1810. The former with 47 lots brought £7116, and the latter with 61 lots £7852. Robert Colling died unmarried at Barmpton on the 7th of March 1820, leaving his property to his brother. Charles Colling, who is remembered as the owner of the famous bulls "Hubback," "Favourite" and "Comet," was more of a specialist and a business man than his brother. He died on the 16th of January 1836.

See the Journal of the Royal Agricultural Society, 1899, for a biographical sketch of the brothers Colling, by C. J. Bates.

COLLINGWOOD, CUTHBERT COLLINGWOOD, BARON (1750-1810), British naval commander, was born at Newcastle-upon-Tyne, on the 26th of September 1750. He was early sent to school; and when only eleven years of age he was put on board the "Shannon," then under the command of Captain (afterwards Admiral) Brathwaite, a relative of his own, to whose care and attention he was in a great measure indebted for that nautical knowledge which shone forth so conspicuously in his subsequent career. After serving under Captain Brathwaite for some years, and also under Admiral Roddam, he went in 1774 to Boston with Admiral Graves, and served in the naval brigade at the battle of Bunker Hill (17th of June 1775), where he gained his lieutenantcy. In 1779 he was made commander of the "Badger," and shortly afterwards post-captain of the "Hinchinbroke," a small frigate. In the spring of 1780 that vessel, under the command of Nelson, was employed upon an expedition to the Spanish Main, where it was proposed to pass into the Pacific by navigating boats along the river San Juan and the lakes Nicaragua and Leon. The attempt failed, and most of those engaged in it became victims to the deadly influence of the climate. Nelson was promoted to a larger vessel, and Collingwood succeeded him in the command. It is a fact worthy of record that the latter succeeded the former very frequently from the time when they first became acquainted, until the star of Nelson set at Trafalgar—giving place to that of Collingwood, less brilliant certainly, but not less steady in its lustre.

After commanding in another small frigate, Collingwood was promoted to the "Sampson" (64); and in 1783 he was appointed to the "Mediator," destined for the West Indies, where, with Nelson, who had a command on that station, he remained till the end of 1786. With Nelson he warmly co-operated in carrying into execution the provisions of the navigation laws, which had been infringed by the United States, whose ships, notwithstanding the separation of the countries, continued to trade to the West Indies, although that privilege was by law exclusively confined to British vessels. In 1786 Collingwood returned to England, where, with the exception of a voyage to the West Indies, he remained until 1793, in which year he was appointed captain of the "Prince," the flag-ship of Rear-Admiral Bowyer. About two years previous to this event he had married Miss Sarah Roddam—a fortunate alliance, which

continued to be a solace to him amidst the privations to which the life of a seaman must ever be subject.

As captain of the "Barfleur," Collingwood was present at the naval engagement which was fought on the 1st of June 1794; and on that occasion he displayed equal judgment and courage. On board the "Excellent" he shared in the victory of the 14th of February 1797, when Sir John Jervis (Lord St Vincent) humbled the Spanish fleet off Cape St Vincent. His conduct in this engagement was the theme of universal admiration throughout the fleet, and greatly advanced his fame as a naval officer. After blockading Cadiz for some time, he returned for a few weeks to Portsmouth to repair. In the beginning of 1799 Collingwood was raised to the rank of vice-admiral, and hoisting his flag in the "Triumph," he joined the Channel Fleet, with which he proceeded to the Mediterranean, where the principal naval forces of France and Spain were assembled. Collingwood continued actively employed in watching the enemy, until the peace of Amiens restored him once more to the bosom of his family.

The domestic repose, however, which he so highly relished, was cut short by the recommencement of hostilities with France, and in the spring of 1803 he quitted the home to which he was never again to return. The duty upon which he was employed was that of watching the French fleet off Brest, and in the discharge of it he displayed the most unwearied vigilance. Nearly two years were spent in this employment; but Napoleon had at length matured his plans and equipped his armament, and the grand struggle which was to decide the fate of Europe and the dominion of the sea was close at hand. The enemy's fleet having sailed from Toulon, Admiral Collingwood was appointed to the command of a squadron, with orders to pursue them. The combined fleets of France and Spain, after spreading terror throughout the West Indies, returned to Cadiz. On their way thither they bore down upon Admiral Collingwood, who had only three vessels with him; but he succeeded in eluding the pursuit, although chased by sixteen ships of the line. Ere one-half of the enemy had entered the harbour he drew up before it and resumed the blockade, at the same time employing an ingenious artifice to conceal the inferiority of his force. But the combined fleet was at last compelled to quit Cadiz; and the battle of Trafalgar immediately followed. The brilliant conduct of Admiral Collingwood upon this occasion has been much and justly applauded. The French admiral drew up his fleet in the form of a crescent, and in a double line, every alternate ship being about a cable's length to windward of her second, both ahead and astern. The British fleet bore down upon this formidable and skilfully arranged armament in two separate lines, the one led by Nelson in the "Victory," and the other by Collingwood in the "Royal Sovereign." The latter vessel was the swifter sailer, and having shot considerably ahead of the rest of the fleet, was the first engaged. "See," said Nelson, pointing to the "Royal Sovereign" as she penetrated the centre of the enemy's line, "see how that noble fellow Collingwood carries his ship into action!" Probably it was at the same instant that Collingwood, as if in response to the observation of his great commander, remarked to his captain, "What would Nelson give to be here?" The consummate valour and skill evinced by Collingwood had a powerful moral influence upon both fleets. It was with the Spanish admiral's ship that the "Royal Sovereign" closed; and with such rapidity and precision did she pour in her broadsides upon the "Santa Anna," that the latter was on the eve of striking in the midst of thirty-three sail of the line, and almost before another British ship had fired a gun. Several other vessels, however, seeing the imminent peril of the Spanish flag-ship, came to her assistance, and hemmed in the "Royal Sovereign" on all sides; but the latter, after suffering severely, was relieved by the arrival of the rest of the British squadron; and not long afterwards the "Santa Anna" struck her colours. The result of the battle of Trafalgar, and the expense at which it was purchased, are well known. On the death of Nelson, Collingwood assumed the supreme command; and by his skill and judgment greatly contributed to the preserva-

tion of the British ships, as well as of those which were captured from the enemy. He was raised to the peerage as Baron Collingwood of Colburne and Heathpool, and received the thanks of both Houses of Parliament, with a pension of £2000 per annum.

From this period until the death of Lord Collingwood no great naval action was fought; but he was much occupied in important political transactions, in which he displayed remarkable tact and judgment. Being appointed to the command of the Mediterranean fleet, he continued to cruise about, keeping a watchful eye upon the movements of the enemy. His health, however, which had begun to decline previously to the action of Trafalgar in 1805, seemed entirely to give way, and he repeatedly requested government to be relieved of his command, that he might return home; but he was urgently requested to remain, on the ground that his country could not dispense with his services. This conduct has been regarded as harsh; but the good sense and political sagacity which he displayed afford some palliation of the conduct of the government; and the high estimation in which he was held is proved by the circumstance that among the many able admirals, equal in rank and duration of service, none stood so prominently forward as to command the confidence of ministers and of the country to the same extent as he did. After many fruitless attempts to induce the enemy to put to sea, as well as to fall in with them when they had done so (which circumstance materially contributed to hasten his death), he expired on board the "Ville de Paris," then lying off Port Mahon, on the 7th of March 1810.

Lord Collingwood's merits as a naval officer were in every respect of the first order. In original genius and romantic daring he was inferior to Nelson, who indeed had no equal in an age fertile in great commanders. In seamanship, in general talent, and in reasoning upon the probability of events from a number of conflicting and ambiguous statements, Collingwood was equal to the hero of the Nile; indeed, many who were familiar with both give him the palm of superiority. His political penetration was remarkable; and so high was the opinion generally entertained of his judgment, that he was consulted in all quarters, and on all occasions, upon questions of general policy, of regulation, and even of trade. He was distinguished for benevolence and generosity; his acts of charity were frequent and bountiful, and the petition of real distress was never rejected by him. He was an enemy to impressment and to flogging; and so kind was he to his crew, that he obtained amongst them the honourable name of father. Between Nelson and Collingwood a close intimacy subsisted, from their first acquaintance in early life till the fall of the former at Trafalgar; and they lie side by side in the cathedral of St Paul's.

The selections from the public and private correspondence of Lord Collingwood, published in 2 vols., 8vo, in 1828, contain some of the best specimens of letter-writing in the language. See also *A Fine Old English Gentleman exemplified in the Life and Character of Lord Collingwood, a Biographical Study*, by William Davies (London, 1875).

COLLINGWOOD, a city of Bourke county, Victoria, Australia, suburban to Melbourne on the N.E., on the Yarra Yarra river. Pop. (1901) 32,766. It was the first town in Victoria incorporated after Melbourne and Geelong. It is esteemed one of the healthiest of the metropolitan suburbs.

COLLINGWOOD, a town of Simcoe county, Ontario, Canada, 90 m. N.N.W. of Toronto, on Georgian Bay, and on the Grand Trunk railway. Pop. (1901) 5755. It is the eastern terminus of two lines of steamers for the ports of Lakes Huron and Superior. It contains a large stone dry-dock and shipyard, pork factory, and saw and planing mills, and has a large lumber, grain and produce export trade, besides a shipbuilding plant and steel works.

COLLINS, ANTHONY (1676-1729), English deist, was born at Heston, near Hounslow in Middlesex, on the 21st of June 1676. He was educated at Eton and King's College, Cambridge, and was for some time a student at the Middle Temple. The most interesting episode of his life was his intimacy with Locke, who in his letters speaks of him with affection and admiration. In 1715 he settled in Essex, where he held the offices of justice of the peace and deputy-lieutenant, which he had before held in Middlesex.

He died at his house in Harley Street, London, on the 13th of December 1729.

His writings are important as gathering together the results of previous English Freethinkers. The imperturbable courtesy of his style is in striking contrast to the violence of his opponents; and it must be remembered that, in spite of his unorthodoxy, he was not an atheist or even an agnostic. In his own words, "Ignorance is the foundation of atheism, and freethinking the cure of it" (*Discourse of Freethinking*, 105).

His first work of note was his *Essay concerning the Use of Reason in Propositions the Evidence whereof depends on Human Testimony* (1707), in which he rejected the distinction between *above* reason and *contrary to* reason, and demanded that revelation should conform to man's natural ideas of God. Like all his works, it was published anonymously, although the identity of the author was never long concealed. Six years later appeared his chief work, *A Discourse of Freethinking, occasioned by the Rise and Growth of a Sect called Freethinkers* (1713). Notwithstanding the ambiguity of its title, and the fact that it attacks the priests of all churches without moderation, it contends for the most part, at least explicitly, for no more than must be admitted by every Protestant. Freethinking is a right which cannot and must not be limited, for it is the only means of attaining to a knowledge of truth, it essentially contributes to the well-being of society, and it is not only permitted but enjoined by the Bible. In fact the first introduction of Christianity and the success of all missionary enterprise involve freethinking (in its etymological sense) on the part of those converted. In England this essay, which was regarded and treated as a plea for deism, made a great sensation, calling forth several replies, among others from William Whiston, Bishop Hare, Bishop Hoadly, and Richard Bentley, who, under the signature of *Phileleutherus Lipsiensis*, roughly handles certain arguments carelessly expressed by Collins, but triumphs chiefly by an attack on trivial points of scholarship, his own pamphlet being by no means faultless in this very respect. Swift also, being satirically referred to in the book, made it the subject of a caricature.

In 1724 Collins published his *Discourse of the Grounds and Reasons of the Christian Religion, with An Apology for Free Debate and Liberty of Writing* prefixed. Ostensibly it is written in opposition to Whiston's attempt to show that the books of the Old Testament did originally contain prophecies of events in the New Testament story, but that these had been eliminated or corrupted by the Jews, and to prove that the fulfilment of prophecy by the events of Christ's life is all "secondary, secret, allegorical, and mystical," since the original and literal reference is always to some other fact. Since, further, according to him the fulfilment of prophecy is the only valid proof of Christianity, he thus secretly aims a blow at Christianity as a revelation. The canonicity of the New Testament he ventures openly to deny, on the ground that the canon could be fixed only by men who were inspired. No less than thirty-five answers were directed against this book, the most noteworthy of which were those of Bishop Edward Chandler, Arthur Sykes and Samuel Clarke. To these, but with special reference to the work of Chandler, which maintained that a number of prophecies were literally fulfilled in Christ, Collins replied by his *Scheme of Literal Prophecy Considered* (1727). An appendix contends against Whiston that the book of *Daniel* was forged in the time of Antiochus Epiphanes (see DEISM).

In philosophy, Collins takes a foremost place as a defender of Necessitarianism. His brief *Inquiry Concerning Human Liberty* (1715) has not been excelled, at all events in its main outlines, as a statement of the determinist standpoint. One of his arguments, however, calls for special criticism,—his assertion that it is self-evident that nothing that has a beginning can be without a cause is an unwarranted assumption of the very point at issue. He was attacked in an elaborate treatise by Samuel Clarke, in whose system the freedom of the will is made essential to religion and morality. During Clarke's lifetime, fearing perhaps to be branded as an enemy of religion and morality, Collins made no reply, but in 1729 he published an answer, entitled *Liberty and Necessity*.

Besides these works he wrote *A Letter to Mr Dodwell*, arguing that it is conceivable that the soul may be material, and, secondly, that if the soul be immaterial it does not follow, as Clarke had contended, that it is immortal; *Vindication of the Divine Attributes* (1710); *Priestcraft in Perfection* (1709), in which he asserts that the clause "the Church . . . Faith" in the twentieth of the Thirty-nine Articles was inserted by fraud.

See Kippis, *Biographia Britannica*; G. Lechler, *Geschichte des englischen Deismus* (1841); J. Hunt, *Religious Thought in England*, ii. (1871); Leslie Stephen, *English Thought in the 18th Century*, i. (1881); A. W. Benn, *Hist. of English Rationalism in the 19th Century* (London, 1906), vol. i. ch. iii.; J. M. Robertson, *Short History of Freethought* (London, 1906); and DEISM.

COLLINS, JOHN CHURTON (1848–1908), English literary critic, was born on the 26th of March 1848 at Bourton on the Water, Gloucestershire. From King Edward's school, Birmingham, he went to Balliol College, Oxford, where he graduated in 1872, and at once devoted himself to a literary career, as journalist, essayist and lecturer. His first book was a study of Sir Joshua Reynolds (1874), and later he edited various classical English writers, and published volumes on *Bolingbroke and Voltaire in England* (1886), a *Study of English Literature* (1891), a study of *Dean Swift* (1893), *Essays and Studies* (1895), *Ephemera Critica* (1901), *Essays in Poetry and Criticism* (1905), and *Rousseau and Voltaire* (1908), his original essays being sharply controversial in tone, but full of knowledge. In 1904 he became professor of English literature at Birmingham University. For many years he was a prominent University Extension lecturer, and a constant contributor to the principal reviews. On the 15th of September 1908 he was found dead in a ditch near Lowestoft, at which place he had been staying with a doctor for the benefit of his health. The circumstances necessitated the holding of an inquest, the verdict being that of "accidental death."

COLLINS, MORTIMER (1827–1876), English writer, was born at Plymouth, where his father, Francis Collins, was a solicitor, on the 29th of June 1827. He was educated at a private school, and after some years spent as mathematical master at Queen Elizabeth's College, Guernsey, he went to London, where he devoted himself to journalism in the Conservative interest. In 1855 he published his *Idyls and Rhymes*; and in 1865 appeared his first story, *Who is the Heir?* A second volume of lyrics, *The Inn of Strange Meetings*, was issued in 1871; and in 1872 he produced his longest and best sustained poem, *The British Birds, a communication from the Ghost of Aristophanes*. He also wrote several capital novels, the best of which is perhaps *Sweet Anne Page* (1868). Some of his lyrics, in their light grace, their sparkling wit, their airy philosophy, are equal to anything of their kind in modern English. On his second marriage in 1868 he settled at Knowl Hill, Berkshire. Collins was an athlete, an excellent pedestrian, and an enthusiastic lover of country life; and from this time he rarely left his home for a day. Conservative in his political and literary tastes, an ardent upholder of Church and State, he was yet a hater of convention; and his many and very varied gifts endeared him to a large circle of friends. He died on the 28th of July 1876.

COLLINS, WILLIAM (1721–1759), English poet, was born on the 25th of December 1721. He divides with Gray the glory of being the greatest English lyricist of the 18th century. After some childish studies in Chichester, of which his father, a rich hatter, was the mayor, he was sent, in January 1733, to Winchester College, where Whitehead and Joseph Warton were his school-fellows. When he had been nine months at the school, Pope paid Winchester a visit and proposed a subject for a prize poem; it is legitimate to suppose that the lofty forehead, the brisk dark eyes and gracious oval of the childish face, as we know it in the only portrait existing of Collins, did not escape the great man's notice, then not a little occupied with the composition of the *Essay on Man*.

In 1734 the young poet published his first verses, in a sixpenny pamphlet on *The Royal Nuptials*, of which, however, no copy has come down to us; another poem, probably satiric, called *The Battle of the Schoolbooks*, was written about this time, and has also been lost. Fired by his poetic fellows to further feats in verse,

Collins produced, in his seventeenth year, those *Persian Eclogues* which were the only writings of his that were valued by the world during his own lifetime. They were not printed for some years, and meanwhile Collins sent, in January and October 1739, some verses to the *Gentleman's Magazine*, which attracted the notice and admiration of Johnson, then still young and unimportant. In March 1740 he was admitted a commoner of Queen's College, Oxford, but did not go up to Oxford until July 1741, when he obtained a demyship at Magdalen College. At Oxford he continued his affectionate intimacy with the Wartons, and gained the friendship of Gilbert White. Early in 1742 the *Persian Eclogues* appeared in London. They were four in number, and formed a modest pamphlet of not more than 300 lines in all. In a later edition, of 1759, the title was changed to *Oriental Eclogues*. Those pieces may be compared with Victor Hugo's *Les Orientales*, to which, of course, they are greatly inferior. Considered with regard to the time at which they were produced, they are more than meritorious, even brilliant, and one at least—the second—can be read with enjoyment at the present day. The rest, perhaps, will be found somewhat artificial and effete.

In November 1743 Collins was made bachelor of arts, and a few days after taking his degree published his second work, *Verses humbly addressed to Sir Thomas Hanmer*. This poem, written in heroic couplets, shows a great advance in individuality, and resembles, in its habit of personifying qualities of the mind, the riper lyrics of its author. For the rest, it is an enthusiastic review of poetry, culminating in a laudation of Shakespeare. It is supposed that he left Oxford abruptly in the summer of 1744 to attend his mother's death-bed, and did not return. He is said to have now visited an uncle in Flanders. His indolence, which had been no less marked at the university than his genius, combined with a fatal irresolution to make it extremely difficult to choose for him a path in life. The army and the church were successively suggested and rejected; and he finally arrived in London, bent on enjoying a small property as an independent man about town. He made the acquaintance of Johnson and others, and was urged by those friends to undertake various important writings—a *History of the Revival of Learning*, several tragedies, and a version of Aristotle's *Poetics*, among others—all of which he began but lacked force of will to continue. He soon squandered his means, plunged, with most disastrous effects, into profligate excesses, and sowed the seed of his untimely misfortune.

It was at this time, however, that he composed his matchless *Odes*—twelve in number—which appeared on the 12th of December 1746, dated 1747. The original project was to have combined them with the odes of Joseph Warton, but the latter proved at that time to be the more marketable article. Collins's little volume fell dead from the press, but it won him the admiration and friendship of the poet Thomson, with whom, until the death of the latter in 1748, he lived on terms of affectionate intimacy. In 1749 Collins was raised beyond the fear of poverty by the death of his uncle, Colonel Martyn, who left him about £2000, and he left London to settle in his native city. He had hardly begun to taste the sweets of a life devoted to literature and quiet, before the weakness of his will began to develop in the direction of insanity, and he hurried abroad to attempt to dispel the gathering gloom by travel. In the interval he had published two short pieces of consummate grace and beauty—the *Elegy on Thomson*, in 1749, and the *Dirge in Cymbeline*, later in the same year. In the beginning of 1750 he composed the *Ode on the Popular Superstitions of the Highlands*, which was dedicated to the author of *Douglas*, and not printed till long after the death of Collins, and an *Ode on the Music of the Grecian Theatre*, which no longer exists, and in which English literature probably has sustained a severe loss. With this poem his literary career closes, although he lingered in great misery for nearly nine years. From Gilbert White, who jotted down some pages of invaluable recollections of Collins in 1781, and from other friends, we learn that his madness was occasionally violent, and that he was confined for a time in an asylum at Oxford. But for the most part he resided at Chichester, suffering from

extreme debility of body when the mind was clear, and incapable of any regular occupation. Music affected him in a singular manner, and it is recorded that he was wont to slip out into the cathedral cloisters during the services, and moan and howl in horrible accordance with the choir. In this miserable condition he passed out of sight of all his friends, and in 1756 it was supposed, even by Johnson, that he was dead; in point of fact, however, his sufferings did not cease until the 12th of June 1759. No journal or magazine recorded the death of the forgotten poet, though Goldsmith, only two months before, had begun the laudation which was soon to become universal.

No English poet so great as Collins has left behind him so small a bulk of writings. Not more than 1500 lines of his have been handed down to us, but among these not one is slovenly, and few are poor. His odes are the most sculpturesque and faultless in the language. They lack fire, but in charm and precision of diction, exquisite propriety of form, and lofty poetic suggestion they stand unrivalled. The ode named *The Passions* is the most popular; that *To Evening* is the classical example of perfect unrhymed verse. In this, and the *Ode to Simplicity*, one seems to be handling an antique vase of matchless delicacy and elegance. In his descriptions of nature it is unquestionable that he owed something to the influence of Thomson. Distinction may be said to be the crowning grace of the style of Collins; its leading peculiarity is the incessant personification of some quality of the character. In the *Ode on Popular Superstitions* he produced a still nobler work; this poem, the most considerable in size which has been preserved, contains passages which are beyond question unrivalled for rich melancholy fulness in the literature between Milton and Keats.

The life of Collins was written by Dr Johnson; he found an enthusiastic editor in Dr Langhorne in 1765, and in 1858 a kindly biographer in Mr Moy Thomas. (E. G.)

COLLINS, WILLIAM (1787–1847), English painter, son of an Irish picture dealer and man of letters, the author of a *Life of George Morland*, was born in London. He studied under Etty in 1807, and in 1809 exhibited his first pictures of repute—"Boys at Breakfast," and "Boys with a Bird's Nest." In 1815 he was made associate of the Royal Academy, and was elected R. A. in 1820. For the next sixteen years he was a constant exhibitor; his fishermen, shrimp-catchers, boats and nets, stretches of coast and sand, and, above all, his rustic children were universally popular. Then, however, he went abroad on the advice of Wilkie, and for two years (1837–1838) studied the life, manners and scenery of Italy. In 1839 he exhibited the first fruits of this journey; and in 1840, in which year he was appointed librarian to the Academy, he made his first appearance as a painter of history. In 1842 he returned to his early manner and choice of subject, and during the last years of life enjoyed greater popularity than ever. Collins was a good colourist and an excellent draughtsman. His earlier pictures are deficient in breadth and force, but his later work, though also carefully executed, is rich in effects of tone and in broadly painted masses. His biography by his son, W. Wilkie Collins, the novelist, appeared in 1848.

COLLINS, WILLIAM WILKIE (1824–1889), English novelist, elder son of William Collins, R.A., the landscape painter, was born in London on the 8th of January 1824. He was educated at a private school in Highbury, and when only a small boy of twelve was taken by his parents to Italy, where the family lived for three years. On their return to England Wilkie Collins was articled to a firm in the tea trade, but four years later he abandoned that business for the law, and was entered at Lincoln's Inn in 1846, being called to the bar three years later. He found little pleasure in his new career, however; though what he learned in it was exceedingly valuable to him later. On his father's death in 1847 young Collins made his first essay in literature, publishing the *Life of William Collins*, in two volumes, in the following year. In 1850 he put forth his first work of fiction, *Antonina, or the Fall of Rome*, which was clearly inspired by his life in Italy. *Basil* appeared in 1852, and *Hide and Seek* in 1854. About this time he made the acquaintance of Charles Dickens, and began

to contribute to *Household Words*, where *After Dark* (1856) and *The Dead Secret* (1857) ran serially. His great success was achieved in 1860 with the publication of *The Woman in White*, which was first printed in *All the Year Round*. From that time he enjoyed as much popularity as any novelist of his day, *No Name* (1862), *Armada* (1866), and *The Moonstone*, a capital detective story (1868), being among his most successful books. After *The New Magdalen* (1873) his ingenuity became gradually exhausted, and his later stories were little more than faint echoes of earlier successes. He died in Wimpole Street, London, on the 23rd of September 1889. Collins's gift was of the melodramatic order, and while many of his stories made excellent plays, several of them were actually reconstructed from pieces designed originally for stage production. But if his colours were occasionally crude and his methods violent, he was at least a master of situation and effect. His trick of telling a story through the mouths of different characters is sometimes irritatingly disconnected; but it had the merit of giving an air of actual evidence and reality to the elucidation of a mystery. He possessed in the highest degree the gift of absorbing interest; the turns and complexities of his plots are surprisingly ingenious, and many of his characters are not only real, but uncommon. Count Fosco in *The Woman in White* is perhaps his masterpiece; the character has been imitated again and again, but no imitation has ever attained to the subtlety and humour of the original.

COLLODION (from the Gr. *κόλλα*, glue), a colourless, viscid fluid, made by dissolving gun-cotton and the other varieties of pyroxylin in a mixture of alcohol and ether. It was discovered in 1846 by Louis Nicolas Ménard in Paris, and independently in 1848 by Dr J. Parkers Maynard in Boston. The quality of collodion differs according to the proportions of alcohol and ether and the nature of the pyroxylin it contains. Collodion in which there is a great excess of ether gives by its evaporation a very tough film; the film left by collodion containing a large quantity of alcohol is soft and easily torn; but in hot climates the presence of an excess of alcohol is an advantage, as it prevents the rapid evaporation of the ether. Under the microscope, the film produced by collodion of good quality appears translucent and colourless. To preserve collodion it should be kept cool and out of the action of the light; iodized collodion that has been discoloured by the development of free iodine may be purified by the immersion in it of a strip of silver foil. For the iodizing of collodion, ammonium bromide and iodide, and the iodides of calcium and cadmium are the agents employed (see PHOTOGRAPHY). Collodion is used in surgery since, when painted on the skin, it rapidly dries and covers the skin with a thin film which contracts as it dries and therefore affords both pressure and protection. Flexible collodion, containing Canada balsam and castor oil, does not crack, but, on the other hand, does not contract. It is therefore of less value. Collodion is applied to small aseptic wounds, to small-pox pustules, and occasionally to the end of the urethra in boys in order to prevent nocturnal incontinence. Collodion and crystals of carbolic acid, taken in equal parts, are useful in relieving toothache due to the presence of a carious cavity. *Vesicating* or *Blistering Collodion* contains cantharidin as one of its constituents. The styptic collodion of Richardson is a strong solution of tannin in gun-cotton collodion. Similarly collodion may be impregnated with salicylic acid, carbolic acid, iodine and other substances. Small balloons are manufactured from collodion by coating the interior of glass globes with the liquid; the film when dry is removed from the glass by applying suction to the mouth of the vessel. M. E. Gripon found (*Compt. rend.*, 1875) that collodion membranes, like glass, reflect light and polarize it both by refraction and reflection; they also transmit a very much larger proportion of radiant heat, for the study of which they are preferable to mica.

COLLOT D'HERBOIS, JEAN MARIE (1750-1796), French revolutionist, was a Parisian by birth and an actor by profession. After figuring for some years at the principal provincial theatres of France and Holland, he became director of the playhouse at Geneva. He had from the first a share in the revolutionary

tumult; but it was not until 1791 that he became a figure of importance. Then, however, by the publication of *L'Almanach du Père Gérard*,¹ a little book setting forth, in homely style, the advantages of a constitutional monarchy, he suddenly acquired great popularity. His renown was soon increased by his active interference on behalf of the Swiss of the Château-Vieux Regiment, condemned to the galleys for mutiny at Nancy. His efforts resulted in their liberation; he went himself to Brest in search of them; and a civic feast was decreed on his behalf and theirs, which gave occasion for one of the few poems published during his life by André Chénier. But his opinions became more and more radical. He was a member of the Commune of Paris on the 10th of August 1792, and was elected deputy for Paris to the Convention, where he was the first to demand the abolition of royalty (on the 21st of September 1792), and he voted the death of Louis XVI. "*sans sursis*." In the struggle between the Mountain and the Girondists he displayed great energy; and after the *coup d'état* of the 31st of May 1793 he made himself conspicuous by his pitiless pursuit of the defeated party. In June he was made president of the Convention; and in September he was admitted to the Committee of Public Safety, on which he was very active. After having entrusted him with several missions, the Convention sent him, on the 30th of October 1793, to Lyons to punish the revolt of that city. There he introduced the Terror in its most terrible form.

In May 1794 an attempt was made to assassinate Collot; but it only increased his popularity, and this won him the hatred of Robespierre, against whom he took sides on the 9th Thermidor, when he presided over the Convention during a part of the session. During the Thermidorian reaction he was one of the first to be accused of complicity with the fallen leader, but was acquitted. Denounced a second time, he defended himself by pleading that he had acted for the cause of the Revolution, but was condemned with Barère and Billaud-Varenne to transportation to Cayenne (March 1795), where he died early in 1796.

Collot d'Herbois wrote and adapted from the English and Spanish many plays, one of which, *Le Paysan magistrat*, kept the stage for several years. *L'Almanach du Père Gérard* was reprinted under the title of *Étrennes aux amis de la Constitution française, ou entretiens du Père Gérard avec ses concitoyens* (Paris, 1792).

See F. A. Aulard, *Les Orateurs de la Législative et de la Convention* (Paris, 1885-1886), t. ii. pp. 501-512. The principal documents relative to the trial of Collot d'Herbois, Barère and Billaud-Varenne are indicated in Aulard, *Recueil des actes du comité de salut public*, t. i. pp. 5 and 6.

COLLUSION (from Lat. *colludere*, strictly, to play with), a secret agreement or compact for some improper purpose. In judicial proceedings, and particularly in matrimonial causes (see DIVORCE), collusion is a deceitful agreement between two or more persons, or between one of them and a third party, to bring an action against the other in order to obtain a judicial decision, or some remedy which would not have been obtained unless the parties had combined for the purpose or suppressed material facts or otherwise.

COLLYER, ROBERT (1823-), American Unitarian clergyman, was born in Keighley, Yorkshire, England, on the 8th of December 1823. At the age of eight he was compelled to leave school and support himself by work in a linen factory. He was naturally studious, however, and supplemented his scant schooling by night study. At fourteen he was apprenticed to a blacksmith, and for several years worked at this trade at Ilkley. In 1849 he became a local Methodist minister, and in the following year emigrated to the United States, where he obtained employment as a hammer maker at Shoemakersville, Pennsylvania. Here he soon began to preach on Sundays while still employed in the factory on week-days. His earnest, rugged, simple style of oratory made him extremely popular, and at once secured for him a wide reputation. His advocacy of anti-slavery principles, then frowned upon by the Methodist authorities, aroused opposition, and eventually resulted in his trial for heresy and the revocation of his licence. He continued, however, as an

¹ Michel Gérard was a popular Breton peasant deputy (see JACOBINS).

independent preacher and lecturer, and in 1859, having joined the Unitarian Church, became a missionary of that church in Chicago, Illinois. In 1860 he organized and became pastor of the Unity Church, the second Unitarian church in Chicago. Under his guidance the church grew to be one of the strongest of that denomination in the West, and Mr Collyer himself came to be looked upon as one of the foremost pulpit orators in the country. During the Civil War he was active in the work of the Sanitary Commission. In 1879 he left Chicago and became pastor of the church of the Messiah in New York city, and in 1903 he became pastor emeritus. He published: *Nature and Life* (1867); *A Man in Earnest: Life of A. H. Conant* (1868); *The Life That Now is* (1871); *The Simple Truth* (1877); *Talks to Young Men: With Asides to Young Women* (1888); *Things New and Old* (1893); *Father Taylor* (1906); and *A History of the Town and Parish of Ilkley* (with Horsfall Turner, 1886).

COLMAN, SAINT (d. 676), bishop of Lindisfarne, was probably an Irish monk at Iona. Journeying southwards he became bishop of Lindisfarne in 661, and a favoured friend of Oswio, king of Northumbria. He was at the synod of Whitby in 664, when the great dispute between the Roman and the Celtic parties in the church was considered; as spokesman of the latter party he upheld the Celtic usages, but King Oswio decided against him and his cause was lost. After this event Colman and some monks went to Iona and then to Ireland. He settled on the island of Inishbofin, where he built a monastery and where he died on the 8th of August 676.

Colman must be distinguished from St Colman of Cloyne (c. 522–600), an Irish saint, who became a Christian about 570; and also from another Irishman, St Colman Ela (553–610), a kinsman of St Columba. The word Colman is derived from the Latin *columbus*, a dove, and the *Book of Leinster* mentions 209 saints of this name.

COLMAN, GEORGE (1732–1794), English dramatist and essayist, usually called "the Elder," and sometimes "George the First," to distinguish him from his son, was born in 1732 at Florence, where his father was stationed as resident at the court of the grand duke of Tuscany. Colman's father died within a year of his son's birth, and the boy's education was undertaken by William Pulteney, afterwards Lord Bath, whose wife was Mrs Colman's sister. After attending a private school in Marylebone, he was sent to Westminster School, which he left in due course for Christ Church, Oxford. Here he made the acquaintance of Bonnell Thornton, the parodist, and together they founded *The Connoisseur* (1754–1756), a periodical which, although it reached its 140th number, "wanted weight," as Johnson said. He left Oxford after taking his degree in 1755, and, having been entered at Lincoln's Inn before his return to London, he was called to the bar in 1757. A friendship formed with David Garrick did not help his career as a barrister, but he continued to practise until the death of Lord Bath, out of respect for his wishes.

In 1760 he produced his first play, *Polly Honeycomb*, which met with great success. In 1761 *The Jealous Wife*, a comedy partly founded on *Tom Jones*, made Colman famous. The death of Lord Bath in 1764 placed him in possession of independent means. In 1765 appeared his metrical translation of the plays of Terence; and in 1766 he produced *The Clandestine Marriage*, jointly with Garrick, whose refusal to take the part of Lord Ogleby led to a quarrel between the two authors. In the next year he purchased a fourth share in the Covent Garden Theatre, a step which is said to have induced General Pulteney to revoke a will by which he had left Colman large estates. The general, who died in that year, did, however, leave him a considerable annuity. Colman was acting manager of Covent Garden for seven years, and during that period he produced several "adapted" plays of Shakespeare. In 1768 he was elected to the Literary Club, then nominally consisting of twelve members. In 1774 he sold his share in the great playhouse, which had involved him in much litigation with his partners, to Leake; and three years later he purchased of Samuel Foote, then broken in health and spirits, the little theatre in the Haymarket. He was attacked with paralysis in

1785; in 1789 his brain became affected, and he died on the 14th of August 1794. Besides the works already cited, Colman was author of adaptations of Beaumont and Fletcher's *Bonduca*, Ben Jonson's *Epicoene*, Milton's *Comus*, and of other plays. He also produced an edition of the works of Beaumont and Fletcher (1778), a version of the *Ars Poetica* of Horace, an excellent translation from the *Mercator* of Plautus for Bonnell Thornton's edition (1760–1772), some thirty plays, many parodies and occasional pieces. An incomplete edition of his dramatic works was published in 1777 in four volumes.

His son, **GEORGE COLMAN** (1762–1836), known as "the Younger," English dramatist and miscellaneous writer, was born on the 21st of October 1762. He passed from Westminster school to Christ Church, Oxford, and King's College, Aberdeen, and was finally entered as a student of law at Lincoln's Inn, London. While in Aberdeen he published a poem satirizing Charles James Fox, called *The Man of the People*; and in 1782 he produced, at his father's playhouse in the Haymarket, his first play, *The Female Dramatist*, for which Smollett's *Roderick Random* supplied the materials. It was unanimously condemned, but *Two to One* (1784) was entirely successful. It was followed by *Turk and no Turk* (1785), a musical comedy; *Inkle and Yarico* (1787), an opera; *Ways and Means* (1788); *The Iron Chest* (1796), taken from William Godwin's *Adventures of Caleb Williams*; *The Poor Gentleman* (1802); *John Bull, or an Englishman's Fireside* (1803), his most successful piece; *The Heir at Law* (1808), which enriched the stage with one immortal character, "Dr Pangloss," and numerous other pieces, many of them adapted from the French.

The failing health of the elder Colman obliged him to relinquish the management of the Haymarket theatre in 1789, when the younger George succeeded him, at a yearly salary of £600. On the death of the father the patent was continued to the son; but difficulties arose in his way, he was involved in litigation with Thomas Harris, and was unable to pay the expenses of the performances at the Haymarket. He was forced to take sanctuary within the Rules of the King's Bench. Here he resided for many years continuing to direct the affairs of his theatre. Released at last through the kindness of George IV., who had appointed him exon of the Yeomen of the Guard, a dignity disposed of by Colman to the highest bidder, he was made examiner of plays by the duke of Montrose, then lord chamberlain. This office, to the disgust of all contemporary dramatists, to whose MSS. he was as illiberal as he was severe, he held till his death. Although his own productions were open to charges of indecency and profanity, he was so severe a censor of others that he would not pass even such words as "heaven," "providence" or "angel." His comedies are a curious mixture of genuine comic force and sentimentality. A collection of them was published (1827) in Paris, with a life of the author, by J. W. Lake.

Colman, whose witty conversation made him a favourite, was also the author of a great deal of so-called humorous poetry (mostly coarse, though much of it was popular)—*My Night Gown and Slippers* (1797), reprinted under the name of *Broad Grins*, in 1802; and *Poetical Vagaries* (1812). Some of his writings were published under the assumed name of Arthur Griffinhood of Turnham Green. He died in Brompton, London, on the 17th of October 1836. He had, as early as 1784, contracted a runaway marriage with an actress, Clara Morris, to whose brother David Morris, he eventually disposed of his share in the Haymarket theatre. Many of the leading parts in his plays were written especially for Mrs Gibbs (*née* Logan), whom he was said to have secretly married after the death of his first wife.

See the second George Colman's memoirs of his early life, entitled *Random Records* (1830), and R. B. Peake, *Memoirs of the Colman Family* (1842).

COLMAN, SAMUEL (1832–), American landscape painter, was born at Portland, Maine, on the 4th of March 1832. He was a pupil of Ashur B. Durand in New York, and in 1860–1862 studied in Spain, Italy, France and England. In 1871–1876 he was again in Europe. In 1860, with James D. Smilie, he founded

the American Water Color Society, and became its first president (1866-1867), his own water-colour paintings being particularly fine. He was elected a member of the National Academy of Design in 1862. Among his works are "The Ships of the Western Plains," in the Union League Club, New York; and "The Spanish Peaks, Colorado," in the Metropolitan Museum, New York.

COLMAR, or **KOLMAR**, a town of Germany, in the imperial province of Alsace-Lorraine, formerly the capital of the department of Haut-Rhin in France, on the Logelbach and Lauch, tributaries of the Ill, 40 m. S.S.W. from Strassburg on the main line of railway to Basel. Pop. (1905) 41,582. It is the seat of the government for Upper Alsace, and of the supreme court of appeal for Alsace-Lorraine. The town is surrounded by pleasant promenades, on the site of the old fortifications, and has numerous narrow and picturesque streets. Of its edifices the most remarkable are the Roman Catholic parish church of St Martin, known also as the *Münster*, dating from the 13th and 14th centuries, the Lutheran parish church (15th century), the former Dominican monastery (1232-1289), known as "Unterlinden" and now used as a museum, the Kaufhaus (trade-hall) of the 15th century, and the handsome government offices (formerly the Prefecture). Colmar is the centre of considerable textile industries, comprising wool, cotton and silk-weaving, and has important manufactures of sewing thread, starch, sugar and machinery. Bleaching and brewing are also carried on, and the neighbourhood is rich in vineyards and fruit-gardens. The considerable trade of the place is assisted by a chamber of commerce and a branch of the Imperial Bank (Reichsbank).

Colmar (probably the *columbarium* of the Romans) is first mentioned, as a royal *villa*, in a charter of Louis the Pious in 823, and it was here that Charles the Fat held a diet in 884. It was raised to the status of a town and surrounded with walls by Wölfelin, advocate (*Landvogt*) of the emperor Frederick II. in Alsace, a masterful and ambitious man, whose accumulated wealth was confiscated by the emperor in 1235, and who is said to have been murdered by his wife lest her portion should also be seized. In 1226 Colmar became an imperial city, and the civic rights (*Stadtrecht*) conferred on it in 1274 by Rudolph of Habsburg became the model for those of many other cities. Its civic history is much the same as that of other medieval towns: a struggle between the democratic guilds and the aristocratic "families," which ended in 1347 in the inclusion of the former in the governing body, and in the 17th century in the complete exclusion of the latter. In 1255 Colmar joined the league of Rhenish cities, and in 1476 and 1477 took a vigorous share in the struggle against Charles the Bold. In 1632, during the Thirty Years' War, it was taken by the Swedes, and in 1635 by the French, who held it till after the Peace of Westphalia (1649). In 1673 the French again occupied it and dismantled the fortifications. In 1681 it was formally annexed to France by a decree of Louis XIV.'s *Chambre de Réunion*, and remained French till 1871, when it passed with Alsace-Lorraine to the new German empire.

See "Annalen und Chronik von Kolmar," German translation, G. H. Pabst, in *Geschichtsschreiber der deutschen Vorzeit* (2nd ed., G. Wattenbach, Leipzig, 1897); Sigmund Billing, *Kleine Chronik der Stadt Kolmar* (Colmar, 1891); Hund, *Kolmar vor und während seiner Entwicklung zur Reichsstadt* (Strassburg, 1899); J. Liblin, *Chronique de Colmar, 58-1400* (Mülhausen, 1867-1868); T. F. X. Hunkler, *Gesch. der Stadt Kolmar* (Colmar, 1838). For further references see Ulysse Chevalier, *Répertoire des sources. Topographie* (Montbéliard, 1894-1899); and Wältz, *Bibliographie de la ville de Colmar* (Mülhausen, 1902).

COLNE, a market town and municipal borough in the Clitheroe parliamentary division of Lancashire, England, 34½ m. N. by E. from Manchester by the Lancashire & Yorkshire railway; it is served also by a branch of the Midland railway from Skipton. Pop. (1901) 23,000. It stands on a hilly site above a small affluent of the river Calder. The church of St Bartholomew retains some Norman work, but is chiefly of various later periods. There is a cloth hall or piece hall, originally used as an exchange when woollens were the staple of the town. The grammar school is

of interest as the place where John Tillotson (1630-1694), archbishop of Canterbury, received early education. Colne is a place of great antiquity, and many Roman coins have been found on the site. As early as the 14th century it was the seat of a woollen manufacture; but its principal manufactures now are cottons, printed calicoes and muslin. In the neighbourhood are several limestone and slate quarries. The town was incorporated in 1895, and the corporation consists of a mayor, 6 aldermen and 18 councillors. Area, 5063 acres.

COLOCYNTH, **COLOQUINTIDA** or **BITTER APPLE**, *Citrullus Colocynthis*, a plant of the natural order Cucurbitaceae. The flowers are unisexual; the male blossoms have five stamens with sinuous anthers, the female have reniform stigmas, and an ovary with three large fleshy placentas. The fruit is round, and about the size of an orange; it has a thick yellowish rind, and a light, spongy and very bitter pulp, which yields the colocynth of druggists. The seeds, which number from 200 to 300, and are disposed in vertical rows on the three parietal placentas of the fruit, are flat and ovoid and dark-brown; they are used as food by some of the tribes of the Sahara, and a coarse oil is expressed from them. The pulp contains only about 3.5% of fixed oil, whilst the seeds contains about 15%. The foliage resembles that of the cucumber, and the root is perennial. The plant has a wide range, being found in Ceylon, India, Persia, Arabia, Syria, North Africa, the Grecian Archipelago, the Cape Verd Islands, and the south-east of Spain. The term *pakkuoth*, translated "wild gourds" in 2 Kings iv. 39, is thought to refer to the fruit of the colocynth; but, according to Dr Olaf Celsius (1670-1756), a Swedish theologian and naturalist, it signifies a plant known as the squirting cucumber, *Ecbalium Elaterium*.

The commercial colocynth consists of the peeled and dried fruits. In the preparation of the drug, the seeds are always removed from the pulp. Its active principle is an intensely bitter amorphous or crystalline glucoside, colocynthin, $C_{56}H_{84}O_{23}$, soluble in water, ether and alcohol, and decomposable by acids into glucose and a resin, colocynthein, $C_{40}H_{64}O_{13}$. Colocynthein also occurs as such in the drug, together with at least two other resins, citrullin and colocynthiden. Colocynthin has been used as a hypodermic purgative—a class of drugs practically non-existent, and highly to be desired in numberless cases of apoplexy. The dose recommended for hypodermic injection is fifteen minims of a 1% solution in glycerin.

The British Pharmacopeia contains a compound extract of colocynth, which no one ever uses; a compound pill—dose 4 to 8 grains—in which oil of cloves is included in order to relieve the griping caused by the drug; and the *Pilula Colocynthis et Hyoscyami*, which contains 2 parts of the compound pill to 1 of extract of hyoscyamus. This is by far the best preparation, the hyoscyamus being added to prevent the pain and griping which is attendant on the use of colocynth alone. The official dose of this pill is 4 to 8 grains, but the most effective and least disagreeable manner in which to obtain its action is to give four two-grain pills at intervals of an hour or so.

In minute doses colocynth acts simply as a bitter, but is never given for this purpose. In ordinary doses it greatly increases the secretion of the small intestine and stimulates its muscular coat. The gall-bladder is also stimulated, and the biliary function of the liver, so that colocynth is both an excretory and a secretory cholagogue. The action which follows hypodermic injection is due to the excretion of the drug from the blood into the alimentary canal. Though colocynth is a drastic hydragogue cathartic, it is desirable, as a rule, to supplement its action by some drug, such as aloes, which acts on the large intestine, and a sedative must always be added. Owing to its irritant properties, the drug must not be used habitually, but it is very valuable in initiating the treatment of simple chronic constipation, and its pharmacological properties obviously render it especially useful in cases of hepatitis and congestion of the liver.

Colocynth was known to the ancient Greek, Roman and Arabic physicians; and in an Anglo-Saxon herbal of the 11th century (Cockayne, *Leechdoms*, &c., vol. i. p. 325, London, 1864), the following directions are given as to its use:—"For stirring of the

inwards, take the inward neshness of the fruit, without the kernels, by weight of two pennies; give it, pounded in lithe beer to be drunk, it stirreth the inwards."

COLOGNE (Ger. *Köln*, or officially, since 1900, *Cöln*), a city and archiepiscopal see of Germany, in the Prussian Rhine province, a fortress of the first rank, and one of the most important commercial towns of the empire. Pop. (1885) 239,437; (1900) 370,685; (1905) 428,503, of which about 80% are Roman Catholics. It lies in the form of a vast semicircle on the left bank of the Rhine, 44 m. by rail north-east from Aix-la-Chapelle, 24 south-east from Düsseldorf and 57 north-north-west from Coblenz. Its situation on the broad and navigable Rhine, and at the centre of an extensive network of railways, giving it direct communication with all the important cities of Europe, has greatly fostered its trade, while its close proximity to the beautiful scenery of the Rhine, has rendered it a favourite tourist resort. When viewed from a distance, especially from the river, the city, with its medieval towers and buildings, the whole surmounted by the majestic cathedral, is picturesque and imposing. The ancient walls and ditches, which formerly environed the city, were dismantled between 1881 and 1885, and the site of the old fortifications, bought from the government by the municipality, were converted into a fine boulevard, the Ring, nearly 4 m. long. Beyond the Ring, about $\frac{1}{2}$ m. farther out, a new continuous line of wall fortifications, with outlying clusters of earthworks and forts, has since been erected; 1000 acres, now occupied by handsome streets, squares and two public parks, were thus added to the inner town, almost doubling its area.

Cologne is connected by bridges with the suburb of Deutz. Within the outer municipal boundary are included (besides Deutz) the suburbs of Bayenthal, Lindenthal, Ehrenfeld, Nippes, Sülz, Bickendorf, Niehl and Poll, protected by another widely extended circle of detached forts on both banks of the Rhine. Of the former city gates four have been retained, restored and converted into museums: the Severin gate, on the south, contains the geological section of the natural history museum; the Hahnen gate, on the west, is fitted as the historical and antiquarian museum of the city; and the Eigelstein gate, on the north, accommodates the zoological section of the natural history museum.

Cologne, with the tortuous, narrow and dark streets and lanes of the old inner town, is still regarded as one of the least attractive capital cities of Germany; but in modern times it has been greatly improved, and the evil smells which formerly characterized it have yielded to proper sanitary arrangements. The most important squares are the Domhof, the Heumarkt, Neumarkt, Alte Markt and Waidmarkt in the old inner, and the Hansa-platz in the new inner town. The long Hohe-strasse of the old town is the chief business street.

The cathedral or Dom, the principal edifice and chief object of interest in Cologne, is one of the finest and purest monuments of Gothic architecture in Europe (for plan, &c. see ARCHITECTURE: *Romanesque and Gothic in Germany*). It stands on the site of a cathedral begun about the beginning of the 9th century by Hildebold, metropolitan of Cologne, and finished under Willibert in 873. This structure was ruined by the Normans, was rebuilt, but in 1248 was almost wholly destroyed by fire. The foundation of the present cathedral was then laid by Conrad of Hochstaden (archbishop from 1288 to 1261). The original plan of the building has been attributed to Gerhard von Rile (d. c. 1295). In 1322 the new choir was consecrated, and the bones of the Three Kings were removed to it from the place they had occupied in the former cathedral. After Conrad's death the work of building advanced but slowly, and at the time of the Reformation it ceased entirely. In the early part of the 19th century the repairing of the cathedral was taken in hand, in 1842 the building of fresh portions necessary for the completion of the whole structure was begun, and on the 15th of October 1880 the edifice, finally finished, was opened in the presence of the emperor William I. and all the reigning German princes. The cathedral, which is in the form of a cross, has a length of 480, and a breadth of 282 ft.; the height of the central

aisle is 154 ft.; that of each of the towers 511 ft. The heaviest of the seven bells (*Kaiserglocke*), cast in 1874 from the metal of French guns, weighs 543 cwt., and is the largest and heaviest bell that is rung. In the choir the heart of Marie de' Medici is buried; and in the adjoining side-chapels are monuments of the founder and other archbishops of Cologne, and the shrine of the Three Kings, which is adorned with gold and precious stones. The three kings of Cologne (Kaspar, Melchior and Balthazar) were supposed to be the three wise men who came from the East to pay adoration to the infant Christ; according to the legend, the emperor Frederick I. Barbarossa brought their bones from Milan in 1162, and had them buried in Cologne cathedral, and miraculous powers of healing were attributed to these relics. The very numerous and richly-coloured windows, presented at various times to the cathedral, add greatly to the imposing effect of the interior. The view of the cathedral has been much improved by a clearance of the old houses on the Domhof, including the archiepiscopal palace, but the new Hof, though flanked by many fine buildings, is displeasing owing to the intrusion of numerous modern palatial hotels and shops.

Among the other churches of Cologne, which was fondly styled in the middle ages the "holy city" (*heilige Stadt*) and "German Rome," and, according to legend, possessed as many sacred fanes as there are days in the year, are several of interest both for their age and for the monuments and works of art they contain. In St Peter's are the famous altar-piece by Rubens, representing the Crucifixion of St Peter, several works by Lucas van Leyden, and some old German glass-paintings. St Martin's, built between the 10th and 12th centuries, has a fine baptistery; St Gereon's, built in the 11th century on the site of a Roman rotunda, is noted for its mosaics, and glass and oil-paintings; the Minorite church, begun in the same year as the cathedral, contains the tomb of Duns Scotus. Besides these may be mentioned the church of St Pantaleon, a 13th-century structure, with a monument to Theophano, wife of the emperor Otto II.; St Cunibert, in the Byzantine-Moorish style, completed in 1248; St Maria im Capitol, the oldest church in Cologne, dedicated in 1049 by Pope Leo IX., noted for its crypt, organ and paintings; St Cecilia, St Ursula, containing the bones of that saint and, according to legend, of the 11,000 English virgins massacred near Cologne while on a pilgrimage to Rome; St Severin, the church of the Apostles, and that of St Andrew (1220 and 1414), which contains the remains of Albertus Magnus in a gilded shrine. Most of these, and also many other old churches, have been completely restored. Among newer ecclesiastical buildings must be mentioned the handsome Roman Catholic church in Deutz, completed in 1896, and a large synagogue, in the new town west of the Ring, finished in 1899.

Among the more prominent secular buildings are the Gürzenich, a former meeting-place of the diets of the Holy Roman Empire, built between 1441 and 1447, of which the ground floor was in 1875 converted into a stock exchange, and the upper hall, capable of accommodating 3000 persons, is largely utilized for public festivities, particularly during the time of the Carnival; the Rathaus, dating from the 13th century, with beautiful Gobelin tapestries; the Tempelhaus, the ancestral seat of the patrician family of the Overstolzens, a beautiful building dating from the 13th century, and now the chamber of commerce; the Wallraf-Richartz Museum, in which is a collection of paintings by old Italian and Dutch masters, together with some works by modern artists; the Zeughaus, or arsenal, built on Roman foundations; the Supreme Court for the Rhine provinces; the post-office (1893); the Imperial Bank (Reichsbank); and the municipal library and archives. The Wolkenburg, a fine Gothic house of the 15th century, originally a patrician residence, was restored in 1874, and is now the headquarters of the famous men's choral society of Cologne (Kölner Männergesangverein).

A handsome central railway station (high level), on the site of the old station, and close to the cathedral, was built in 1889-1894. The railway to Bonn and the Upper Rhine now follows the line of the *ceinture* of the new inner fortifications, and on this section there are three city stations in addition to the central.

Like all important German towns, Cologne contains many fine monuments. The most conspicuous is the colossal equestrian statue (22½ ft. high) of Frederick William III. of Prussia in the Heumarkt. There are also monuments to Moltke (1881), to Count Johann von Werth (1885), the cavalry leader of the Thirty Years' War, and to Bismarck (1879). Near the cathedral is an archiepiscopal museum of church antiquities. Cologne is richly endowed with literary and scientific institutions. It has an academy of practical medicine, a commercial high school, a theological seminary, four Gymnasias (classical schools), numerous lower-grade schools, a conservatory of music and several high-grade ladies' colleges. Of its three theatres, the municipal theatre (Stadttheater) is famed for its operatic productions.

Commercially, Cologne is one of the chief centres on the Rhine, and has a very important trade in corn, wine, mineral ores, coals, drugs, dyes, manufactured wares, groceries, leather and hides, timber, porcelain and many other commodities. A large new harbour, with spacious quays, has been constructed towards the south of the city. In 1903, the traffic of the port amounted to over one million tons. Industrially, also, Cologne is a place of high importance. Of the numerous manufactures, among which may be especially mentioned sugar, chocolate, tobacco and cigars, the most famous is the perfume known as *eau de Cologne* (*q.v.*) (*Kölnisches Wasser*, *i.e.* Cologne-water).

Of the newspapers published at Cologne the most important is the *Kölnische Zeitung* (often referred to as the "Cologne Gazette"), which has the largest circulation of any paper in Germany, and great weight and influence. It must be distinguished from the *Kölnische Volkszeitung*, which is the organ of the Clerical party in the Prussian Rhine provinces.

History.—Cologne occupies the site of *Oppidum Ubiorum*, the chief town of the Ubii, and here in A.D. 50 a Roman colony, *Colonia*, was planted by the emperor Claudius, at the request of his wife Agrippina, who was born in the place. After her it was named *Colonia Agrippina* or *Agrippinensis*. Cologne rose to be the chief town of *Germania Secunda*, and had the privilege of the *Jus Italicum*. Both Vitellius and Trajan were at Cologne when they became emperors. About 330 the city was taken by the Franks but was not permanently occupied by them till the 5th century, becoming in 475 the residence of the Frankish king Childeric. It was the seat of a *pagus* or *gau*, and counts of Cologne are mentioned in the 9th century.

The succession of bishops in Cologne is traceable, except for a gap covering the troubled 5th century, from A.D. 313, when the see was founded. It was made the metropolitan see for the bishoprics of the Lower Rhine and part of Westphalia by Charlemagne, the first archbishop being Hildebold, who occupied the see from 785 to his death in 819. Of his successors one of the most illustrious was Bruno (*q.v.*), brother of the emperor Otto I., archbishop from 953 to 965, who was the first of the archbishops to exercise temporal jurisdiction, and was also "archduke" of Lorraine. The territorial power of the archbishops was already great when, in 1180, on the partition of the Saxon duchy, the duchy of Westphalia was assigned to them. In the 11th century they became *ex-officio* arch-chancellors of Italy (see ARCH-CHANCELLOR), and by the Golden Bull of 1356 they were finally placed among the electors (*Kurfürsten*) of the Empire. With Cologne itself, a free imperial city, the archbishop-electors were at perpetual feud; in 1262 the archiepiscopal see was transferred to Brühl, and in 1273 to Bonn; it was not till 1671 that the quarrel was finally adjusted. The archbishopric was secularized in 1801, all its territories on the left bank of the Rhine being annexed to France; in 1803 those on the right bank were divided up among various German states; and in 1815 by the congress of Vienna, the whole was assigned to Prussia. The last archbishop-elect, Maximilian of Austria, died in 1801.

In Archbishop Hildebold's day Cologne was still contained by the square of its Roman walls, within which stood the cathedral and the newly-founded church of St Maria (known later as "im Capitol"); the city was, however, surrounded by a ring of churches, among which those of St Gereon, St Ursula, St Severin and St Cunibert were conspicuous. In 881 Norman

pirates, sailing up the Rhine, took and sacked the city; but it rapidly recovered, and in the 11th century had become the chief trading centre of Germany. Early in the 12th century the city was enlarged by the inclusion of suburbs of Oversburg, Niederich and St Aposteln; in 1180 these were enclosed in a permanent rampart which, in the 13th century, was strengthened with the walls and gates that survived till the 19th century.

The municipal history of Cologne is of considerable interest. In general it follows the same lines as that of other cities of Lower Germany and the Netherlands. At first the bishop ruled through his burgrave, advocate, and nominated jurats (*scabini*, *Schöffen*). Then, as the trading classes grew in wealth, his jurisdiction began to be disputed; the *conjuratio pro libertate* of 1112 seems to have been an attempt to establish a commune (see COMMUNE, MEDIEVAL). Peculiar to Cologne, however, was the *Richerzeche* (*rigirzegheide*), a corporation of all the wealthy patricians, which gradually absorbed in its hands the direction of the city's government (the first record of its active interference is in 1225). In the 13th century the archbishops made repeated efforts to reassert their authority, and in 1259 Archbishop Conrad of Hochstaden, by appealing to the democratic element of the population, the "brotherhoods" (*fraternitates*) of the craftsmen, succeeded in overthrowing the *Richerzeche* and driving its members into exile. His successor, Engelbert II., however, attempted to overthrow the democratic constitution set up by him, with the result that in 1262 the brotherhoods combined with the patricians against the archbishop, and the *Richerzeche* returned to share its authority with the elected "great council" (*Weiter Rat*). As yet, however, none of the trade or craft guilds, as such, had a share in the government, which continued in the hands of the patrician families, membership of which was necessary even for election to the council and to the parochial offices. This continued long after the battle of Worringen (1288) had finally secured for the city full self-government, and the archbishops had ceased to reside within its walls. In the 14th century a narrow patrician council selected from the *Richerzeche*, with two burgomasters, was supreme. In 1370 an insurrection of the weavers was suppressed; but in 1396, the rule of the patricians, having been weakened by internal dissensions, a bloodless revolution led to the establishment of a comparatively democratic constitution, based on the organization of the trade and craft guilds, which lasted with but slight modification till the French Revolution.

The greatness of Cologne, in the middle ages as now, was due to her trade. Wine and herrings were the chief articles of her commerce; but her weavers had been in repute from time immemorial, and exports of cloth were large, while her goldsmiths and armourers were famous. So early as the 11th century her merchants were settled in London, their colony forming the nucleus of the Steelyard. When, in 1201, the city joined the Hanseatic League (*q.v.*) its power and repute were so great that it was made the chief place of a third of the confederation.

In spite of their feuds with the archbishops, the burghers of Cologne were staunch Catholics, and the number of the magnificent medieval churches left is evidence at once of their piety and their wealth. The university, founded in 1389 by the sole efforts of the citizens, soon gained a great reputation; in the 15th century its students numbered much more than a thousand, and its influence extended to Scotland and the Scandinavian kingdoms. Its decline began, however, from the moment when the Catholic sentiment of the city closed it to the influence of the Reformers; the number of its students sank to vanishing point, and though, under the influence of the Jesuits, it subsequently revived, it never recovered its old importance. A final blow was dealt it when, in 1777, the enlightened archbishop Maximilian Frederick (d. 1784) founded the university of Bonn, and in 1798, amid the confusion of the revolutionary epoch, it ceased to exist.

The same intolerance that ruined the university all but ruined the city too. It is difficult, indeed, to blame the burghers for resisting the dubious reforming efforts of Hermann of Wied, archbishop from 1515 to 1546, inspired mainly by secular

ambitions; but the expulsion of the Jews in 1414, and still more the exclusion, under Jesuit influence, of Protestants from the right to acquire citizenship, and from the magistracy, dealt severe blows at the prosperity of the place. A variety of other causes contributed to its decay: the opening up of new trade routes, the gradual ossification of the guilds into close and corrupt corporations, above all the wars in the Netherlands, the Thirty Years' War, and the Wars of the Spanish and Austrian Succession. When in 1794 Cologne was occupied by the French, it was a poor and decayed city of some 40,000 inhabitants, of whom only 6000 possessed civic rights. When, in 1801, by the treaty of Lunéville, it was incorporated in France, it was not important enough to be more than the chief town of an arrondissement. On the death of the last elector in 1801 the archiepiscopal see was left vacant. With the assignment of the city to Prussia by the congress of Vienna in 1815 a new era of prosperity began. The university, indeed, was definitively established at Bonn, but the archbishopric was restored (1821) as part of the new ecclesiastical organization of Prussia, and the city became the seat of the president of a governmental district. Its prosperity now rapidly increased; when railways were introduced it became the meeting-place of several lines, and in 1881 its growth necessitated the pushing outward of the circle of fortifications.

See L. Ennen, *Gesch. der Stadt Köln* (5 vols., Cologne, 1863-1880) to 1648, and *Frankreich und der Niederrhein* (2 vols., *ib.*, 1855, 1856), a history of the city and electorate of Cologne since the Thirty Years' War; R. Schultze and C. Steuernagel, *Colonia Agrippinensis* (Bonn, 1895); K. Heldmann, *Der Kölngau und die Civitas Köln* (Halle, 1900); L. Korth, *Köln im Mittelalter* (Cologne, 1890); F. Lau, *Entwicklung der kommunalen Verfassung der Stadt Köln bis zum Jahre 1306* (Bonn, 1898); K. Hegel, *Städle und Gilden der germanischen Völker im Mittelalter* (2 vols., Leipzig, 1891), ii. p. 323; H. Keussen, *Historische Topographie der Stadt Köln im Mittelalter* (Bonn, 1906); W. Behnke, *Aus Kölns Franzosenzeit* (Cologne, 1901); Helmken, *Köln und seine Sehenswürdigkeiten* (20th ed., Cologne, 1903). For sources see L. Ennen and G. Eckertz, *Quellen zur Geschichte der Stadt Köln* (6 vols., Cologne, 1860-1879); later sources will be found in U. Chevalier, *Répertoire des sources hist. Topo-bibliographie* (Montbéliard, 1894-1899), *s.v.* Cologne, which gives also a full list of works on everything connected with the city; also in Dahlmann-Waitz, *Quellenkunde* (ed. Leipzig, 1906), p. 17, Nos. 252, 253. For the archdiocese and electorate of Cologne see Binterim and Mooren, *Die Erzdiözese Köln bis zur französischen Staatsumwälzung*, new ed. by A. Mooren in 2 vols. (Düsseldorf, 1892, 1893).

COLOMAN (1070-1116), king of Hungary, was the son of King Geza of Hungary by a Greek concubine. King Ladislaus would have made the book-loving youth a monk, and even designated him for the see of Eger; but Coloman had no inclination for an ecclesiastical career, and, with the assistance of his friends, succeeded in escaping to Poland. On the death of Ladislaus (1095), he returned to Hungary and seized the crown, passing over his legitimately born younger brother Almos, the son of the Greek princess Sinadene. Almos did not submit to this usurpation, and was more or less of an active rebel till 1108, when the emperor Henry V. espoused his cause and invaded Hungary. The Germans were unsuccessful; but Coloman thought fit to be reconciled with his kinsman and restored to him his estates. Five years later, however, fearing lest his brother might stand in the way of his heir, the infant prince Stephen, Coloman imprisoned Almos and his son Béla in a monastery and had them blinded. Despite his adoption of these barbarous Byzantine methods, Coloman was a good king and a wise ruler. In foreign affairs he preserved the policy of St Ladislaus by endeavouring to provide Hungary with her greatest need, a suitable seaboard. In 1097 he overthrew Peter, king of Croatia, and acquired the greater part of Dalmatia, though here he encountered formidable rivals in the Greek and German emperors, Venice, the pope and the Norman-Italian dukes, all equally interested in the fate of that province, so that Coloman had to proceed cautiously in his expansive policy. By 1102, however, Zara, Traù, Spalato and all the islands as far as the Cetina were in his hands. But it was as a legislator and administrator that Coloman was greatest (see HUNGARY: *History*). He was not only one of the most learned, but also one of the most statesmanlike sovereigns of the earlier middle ages. Coloman was

twice married, (1) in 1097 to Buzella, daughter of Roger, duke of Calabria, the chief supporter of the pope, and (2) in 1112 to the Russian princess, Euphemia, who played him false and was sent back in disgrace to her kinsfolk the following year. Coloman died on the 3rd of February 1116.

COLOMB, PHILIP HOWARD (1831-1899), British vice-admiral, historian, critic and inventor, the son of General G. T. Colomb, was born in Scotland, on the 29th of May 1831. He entered the navy in 1846, and served first at sea off Portugal in 1847; afterwards, in 1848, in the Mediterranean, and from 1848 to 1851 as midshipman of the "Reynard" in operations against piracy in Chinese waters; as midshipman and mate of the "Serpent" during the Burmese War of 1852-53; as mate of the "Phoenix" in the Arctic Expedition of 1854; as lieutenant of the "Hastings" in the Baltic during the Russian War, taking part in the attack on Sveaborg. He became what was known at that time as a "gunner's lieutenant" in 1857, and from 1859 to 1863 he served as flag-lieutenant to rear-admiral Sir Thomas Pasley at Devonport. Between 1858 and 1868 he was employed in home waters on a variety of special services, chiefly connected with gunnery, signalling and the tactical characteristics and capacities of steam warships. From 1868 to 1870 he commanded the "Dryad," and was engaged in the suppression of the slave trade. In 1874, while captain of the "Audacious," he served for three years as flag-captain to vice-admiral Ryder in China; and finally he was appointed, in 1880, to command the "Thunderer" in the Mediterranean. Next year he was appointed captain of the steam reserve at Portsmouth; and after serving three years in that capacity, he remained at Portsmouth as flag-captain to the commander-in-chief until 1886, when he was retired by superannuation before he had attained flag rank. Subsequently he became rear-admiral, and finally vice-admiral on the retired list.

Few men of his day had seen more active and more varied service than Colomb. But the real work on which his title to remembrance rests is the influence he exercised on the thought and practice of the navy. He was one of the first to perceive the vast changes which must ensue from the introduction of steam into the navy, which would necessitate a new system of signals and a new method of tactics. He set himself to devise the former as far back as 1858, but his system of signals was not adopted by the navy until 1867.

What he had done for signals Colomb next did for tactics. Having first determined by experiment—for which he was given special facilities by the admiralty—what are the manœuvring powers of ships propelled by steam under varying conditions of speed and helm, he proceeded to devise a system of tactics based on these data. In the sequel he prepared a new evolutionary signal-book, which was adopted by the royal navy, and still remains in substance the foundation of the existing system of tactical evolutions at sea. The same series of experimental studies led him to conclusions concerning the chief causes of collisions at sea; and these conclusions, though stoutly combated in many quarters at the outset, have since been generally accepted; and were ultimately embodied in the international code of regulations adopted by the leading maritime nations on the recommendation of a conference at Washington in 1889.

After his retirement Colomb devoted himself rather to the history of naval warfare, and to the large principles disclosed by its intelligent study, than to experimental inquiries having an immediate practical aim. As in his active career he had wrought organic changes in the ordering, direction and control of fleets, so by his historic studies, pursued after his retirement, he helped greatly to effect, if he did not exclusively initiate, an equally momentous change in the popular, and even the professional, way of regarding sea-power and its conditions. He did not invent the term "sea-power,"—it is, as is shown elsewhere (see SEA-POWER), of very ancient origin,—nor did he employ it until Captain Mahan had made it a household word with all. But he thoroughly grasped its conditions, and in his great work on naval warfare (first published in 1891) he enunciated its principles with great cogency and with keen historic insight. The central

idea of his teaching was that naval supremacy is the condition precedent of all vigorous military offensive across the seas, and, conversely, that no vigorous military offensive can be undertaken across the seas until the naval force of the enemy has been accounted for—either destroyed or defeated and compelled to withdraw to the shelter of its own ports, or at least driven from the seas by the menace of a force it dare not encounter in the open. This broad and indefeasible principle he enunciated and defended in essay after essay, in lecture after lecture, until what at first was rejected as a paradox came in the end to be accepted as a commonplace. He worked quite independently of Captain Mahan, and his chief conclusions were published before Captain Mahan's works appeared.

He died quite suddenly and in the full swing of his literary activity on the 13th of October 1899, at Steeple Court, Botley, Hants. His latest published work was a biography of his friend Sir Astley Cooper Key, and his last article was a critical examination of the tactics adopted at Trafalgar, which showed his acumen and insight at their best.

His younger brother, SIR JOHN COLOMB (1838-1909), was closely associated in the pioneer work done for British naval strategy and Imperial defence, and his name stands no less high among those who during this period promoted accurate thinking on the subject of sea-power. Entering the Royal Marines in 1854, he rose to be captain in 1867, retiring in 1869; and thenceforth he devoted himself to the study of naval and military problems, on which he had already published some excellent essays. His books on *Colonial Defence and Colonial Opinions* (1873), *The Defence of Great and Greater Britain* (1879), *Naval Intelligence and the Protection of Commerce* (1881), *The Use and the Application of Marine Forces* (1883), *Imperial Federation: Naval and Military* (1887), followed later by other similar works, made him well known among the rising school of Imperialists, and he was returned to parliament (1886-1892) as Conservative member for Bow, and afterwards (1895-1906) for Great Yarmouth. In 1887 he was created C.M.G., and in 1888 K.C.M.G. He died in London on the 27th of May 1909. In Kerry, Ireland, he was a large landowner, and became a member of the Irish privy council (1903), and in 1906 he sat on the Royal Commission dealing with congested districts.

COLOMBES, a town of France in the department of Seine, arrondissement of St Denis, 7 m. N.N.W. of Paris. Pop. (1906) 28,920. It has a 16th-century church with 12th-century tower, a race-course, and numerous villa residences and boarding-schools. Manufactures include oil, vinegar and measuring-instruments. A castle formerly stood here, in which died Henrietta Maria, queen of Charles I. of England.

COLOMBEY, a village of Lorraine, 4 m. E. of Metz, famous as the scene of a battle between the Germans and the French fought on the 14th of August 1870. It is often called the battle of Borny, from another village 2½ m. E. of Metz. (See METZ and FRANCO-GERMAN WAR.)

COLOMBIA, a republic of South America occupying the N.W. angle of that continent and bounded N. by the Caribbean Sea and Venezuela, E. by Venezuela and Brazil, S. by Brazil, Peru and Ecuador, and W. by Ecuador, the Pacific Ocean, Panama and the Caribbean Sea. The republic is very irregular in outline and has an extreme length from north to south of 1050 m., exclusive of territory occupied by Peru on the north bank of the upper Amazon, and an extreme width of 860 m. The approximate area of this territory, according to official calculations, is 481,979 sq. m., which is reduced to 465,733 sq. m. by Gotha planimetric measurements. This makes Colombia fourth in area among the South American states.

The loss of the department of Panama left the republic with unsettled frontiers on every side, and some of the boundary disputes still unsolved in 1909 concern immense areas of territory. The boundary with Costa Rica was settled in 1900 by an award of the President of France, but the secession of Panama in 1903 gave Colombia another unsettled line on the north-west. If the line which formerly separated the Colombian departments of Cauca and Panama is taken as forming the international

boundary, this line follows the water-parting between the streams which flow eastward to the Atrato, and those which flow westward to the Gulf of San Miguel, the terminal points being near Cape Tiburon on the Caribbean coast, and at about 7° 10' N. lat. on the Pacific coast. The boundary dispute with Venezuela was referred in 1883 to the king of Spain, and the award was made in 1891. Venezuela, however, refused to accept the decision. The line decided upon, and accepted by Colombia, starts from the north shore of Calabozo Bay on the west side of the Gulf of Maracaibo, and runs west and south-west to and along the water-parting (Sierra de Perija) between the drainage basins of the Magdalena and Lake Maracaibo as far as the source in lat. 8° 50' N. of a small branch of the Catatumbo river, thence in a south-easterly direction across the Catatumbo and Zulia rivers to a point in 72° 30' W. long., 8° 12' N. lat., thence in an irregular southerly direction across the Cordillera de Mérida to the source of the Sarare, whence it runs eastward along that river, the Arauca, and the Meta to the Orinoco. Thence the line runs south and south-east along the Orinoco, Atabapo and Guainia to the Pedra de Cucuy, which serves as a boundary mark for three republics. Of the eastern part of the territory lying between the Meta and the Brazilian frontier, Venezuela claims as far west as the meridian of 69° 10'. Negotiations for the settlement of the boundary with Brazil (*q.v.*) were resumed in 1906, and were advanced in the following year to an agreement providing for the settlement of conflicting claims by a mixed commission. With Ecuador and Peru the boundary disputes are extremely complicated, certain parts of the disputed territory being claimed by all three republics. Colombia holds possession as far south as the Napo in lat. 2° 47' S., and claims territory occupied by Peru as far south as the Amazon. On the other hand Peru claims as far north as La Chorrera in 0° 49' S. lat., including territory occupied by Colombia, and the eastern half of the Ecuadorean department of Oriente, and Ecuador would extend her southern boundary line to the Putumayo, in long. 71° 1' S., and make that river her northern boundary as far north as the Peruvian claim extends. The provisional line starts from the Japura river (known as the Caqueta in Colombia) in lat. 1° 30' S., long. 69° 24' W., and runs south-west to the 70th meridian, thence slightly north of west to the Igaraparana river, thence up that stream to the Peruvian military post of La Chorrera, in 0° 49' S. lat., thence west of south to Huiririma-chico, on the Napo. Thence the line runs north-west along the Napo, Coca and San Francisco rivers to the Andean watershed, which becomes the dividing line northward for a distance of nearly 80 m., where the line turns westward and reaches the Pacific at the head of Panguapi Bay, into which the southern outlet of the Mira river discharges (about 1° 34' N. lat.).

Physical Geography.—Colombia is usually described as an extremely mountainous country, which is true of much less than half its total area. Nearly one half its area lies south-east of the Andes and consists of extensive llanos and forested plains, traversed by several of the western tributaries of the Amazon and Orinoco. These plains slope gently toward the east, those of the Amazon basin apparently lying in great terraces whose escarpments have the character of low, detached ranges of hills forming successive rims to the great basin which they partly enclose. The elevation and slope of this immense region, which has an approximate length of 640 m. and average width of 320 m., may be inferred from the elevations of the Caqueta, or Japura river, which was explored by Crevaux in 1878-1879. At Santa Maria, near the Cordillera (about 75° 30' W. long.), the elevation is 613 ft. above sea-level, on the 73rd meridian it is 538 ft., and near the 70th meridian 426 ft.—a fall of 187 ft. in a distance of about 400 m. The northern part of this great region has a somewhat lower elevation and gentler slope, and consists of open grassy plains, which are within the zone of alternating wet and dry seasons. In the south and toward the great lower basin of the Amazon, where the rainfall is continuous throughout the year, the plains are heavily forested. The larger part of this territory is unexplored except along the principal rivers, and is inhabited by scattered tribes of Indians. Near the Cordilleras and along some of the larger rivers there are a few small settlements of whites and mestizos, but their aggregate number is small and their economic value to the republic is inconsiderable. There are some cattle ranges on the open plains, however, but they are too isolated to have much importance. A small part of the northern Colombia, on the lower courses of the Atrato and Magdalena, extending across

the country from the Eastern to the Western Cordilleras with a varying width of 100 to 150 m., not including the lower river basins which penetrate much farther inland, also consists of low, alluvial plains, partly covered with swamps and intricate watercourses, densely overgrown with vegetation, but in places admirably adapted to different kinds of tropical agriculture. These plains are broken in places by low ranges of hills which are usually occupied by the principal industrial settlements of this part of the republic, the lower levels being for the most part swampy and unsuited for white occupation.

The other part of the republic, which may be roughly estimated at two-fifths of its total area, consists of an extremely rugged mountainous country, traversed from south to north by the parallel river valleys of the Magdalena, Cauca and Atrato. The mountain chains which cover this part of Colombia are the northern terminal ranges of the great Andean system. In northern Ecuador the Andes narrows into a single massive range which has the character of a confused mass of peaks and ridges on the southern frontier of Colombia. There are several lofty plateaus in this region which form a huge central watershed for rivers flowing east to the Amazon, west to the Pacific, and north to the Caribbean Sea. The higher plateaus are called *paramos*, cold, windswept, mist-drenched deserts, lying between the elevations of 10,000 and 15,000 ft., which are often the only passes over the Cordilleras, and yet are almost impassable because of their morasses, heavy mists, and cold, piercing winds. The *paramos* of Cruz Verde (11,695 ft.) and Pasto, and the volcanoes of Chiles (15,900 ft.), Chumbul (15,715 ft.), and Pasto (13,990 ft.) are prominent landmarks of this desolate region. North of this great plateau the Andes divides into three great ranges, the Western, Central and Eastern Cordilleras. The Central is the axis of the system, is distinguished by a line of lofty volcanoes and *paramos*, some of which show their white mantles 2000 to 3000 ft. above the line of perpetual snow (approx. 15,000 ft. in this latitude), and is sometimes distinguished with the name borne by the republic for the time being. This range runs in a north-north-east direction and separates the valleys of the Magdalena and Cauca, terminating in some low hills south-west of El Banco, a small town on the lower Magdalena. The principal summits of this range are Tajumbina (13,534 ft.), Pan de Azucar (15,978 ft.), Purace (15,420 ft.), Sotara (15,420 ft.), Huila over 18,000 ft., Tolima (18,432 ft.), Santa Isabel (16,700 ft.), Ruiz (18,373 ft.), and Mesa de Herveo (18,300 ft.). The last named affords a magnificent spectacle from Bogotá, its level top which is 5 or 6 m. across, and is formed by the rim of an immense crater, having the appearance of a table, down the sides of which for more than 3000 ft. hangs a spotless white drapery of perpetual snow. The Western Cordillera branches from the main range first and follows the coast very closely as far north as the 4th parallel, where the San Juan and Atrato rivers, though flowing in opposite directions and separated near the 5th parallel by a low transverse ridge, combine to interpose valleys between it and the Cordillera de Baudo, which thereafter becomes the true coast range. It then forms the divide between the Cauca and Atrato valleys, and terminates near the Caribbean coast. The general elevation of this range is lower than that of the others, its culminating points being the volcano Munchique (11,850 ft.) and Cerro Leon (10,847 ft.). The range is covered with vegetation and its Pacific slopes are precipitous and humid. The Cordillera de Baudo, which becomes the coast range above lat. 4° N., is the southern extension of the low mountainous chain forming the backbone of the Isthmus of Panama, and may be considered the southern termination of the great North American system. Its elevations are low and heavily wooded. It divides on the Panama frontier, the easterly branch forming the watershed between the Atrato and the rivers of eastern Panama, and serving as the frontier between the two republics. The passes across these ranges are comparatively low, but they are difficult because of the precipitous character of their Pacific slopes and the density of the vegetation on them. The Eastern Cordillera is in some respects the most important of the three branches of the Colombian Andes. Its general elevation is below that of the Central Cordillera, and it has few summits rising above the line of perpetual snow, the highest being the Sierra Nevada de Cocui, in lat. 6° 30' N. Between Cocui and the southern frontier of Colombia there are no noteworthy elevations except the so-called Paramo de Suma Paz near Bogotá, the highest point of which is 14,146 ft. above sea-level, and the Chita

paramo, or range, north-east of Bogotá (16,700 ft.). Between the 5th and 6th parallels the range divides into two branches, the eastern passing into Venezuela, where it is called the Cordillera de Merida, and the northern continuing north and north-east as the Sierra de Perija and the Sierra de Oca, to terminate at the north-eastern extremity of the Goajira peninsula. The culminating point in the first-mentioned range is the Cerro Pintado (11,800 ft.). West of this range, and lying between the 10th parallel and the Caribbean coast, is a remarkable group of lofty peaks and knotted ranges known as the Sierra Nevada de Santa Marta, the highest snow-crowned summit of which rises 17,389 ft. above the sea according to some, and 16,728 according to other authorities. This group of

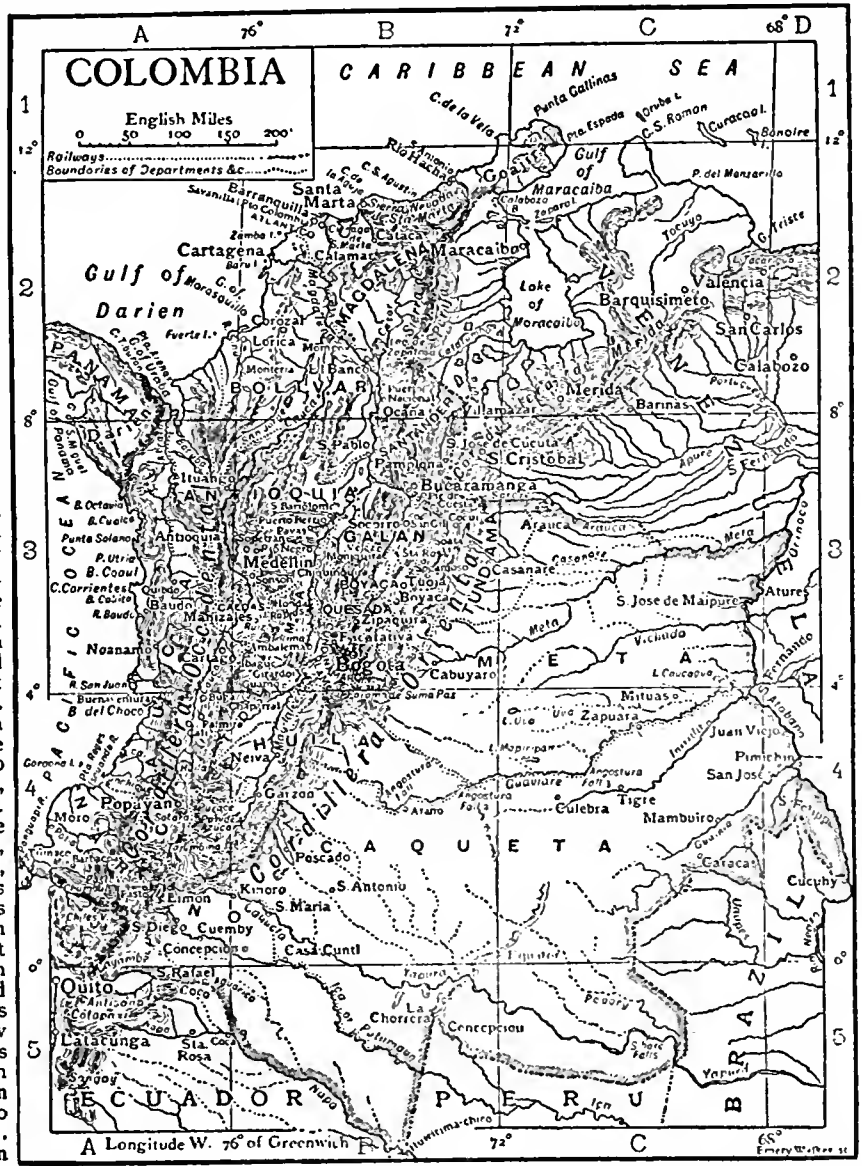

mountains, covering an approximate area of 6500 sq. m., lies immediately on the coast, and its highest summits were long considered inaccessible. It stands detached from the lower ranges of the Eastern Cordillera, and gives the impression that it is essentially independent. The eastern Cordillera region is noteworthy for its large areas of plateau and elevated valley within the limits of the vertical temperate zone. In this region is to be found the greater part of the white population, the best products of Colombian civilization, and the greatest industrial development. The "sabana" of Bogotá is a good illustration of the higher of these plateaus (8563 ft., according to Stieler's *Hand-Atlas*), with its mild temperature, inexhaustible fertility and numerous productions of the temperate zone. It has an area of about 2000 sq. m. The lower valleys, plateaus and mountain slopes of this range are celebrated for their coffee, which, with better means of transportation, would be a greater source of prosperity for the republic than the gold-mines of Antioquia. The mountainous region of Colombia is subject to volcanic disturbances and earthquake shocks are frequent, especially in the south. These shocks, however, are less severe than in Venezuela or in Ecuador.

There are few islands on the coast of Colombia, and the great majority of these are too small to appear on the maps in general use.

Gorgona is one of the larger islands on the Pacific coast, and is situated about 25 m. from the mainland in lat. 3° N. It is $5\frac{1}{2}$ m. long by $1\frac{1}{2}$ m. wide, and rises to an extreme elevation of 1296 ft. above sea-level. It is a beautiful island, and is celebrated as one of Pizarro's stopping places. It has been used by the Colombian government for political offenders. **Malpelo** island, 282 m. west by south of Charambira point, in lat. $3^{\circ} 40'$ N., long $81^{\circ} 24'$ W., nominally belongs to Colombia. It is a small, rocky, uninhabited island, rising to an elevation of 846 ft. above the sea, and has no ascertained value. The famous Pearl islands of the Gulf of Panama are claimed by Colombia, and their pearl oyster fisheries are considered a rentable asset by the government. The group covers an area of about 450 sq. m., and consists of 16 islands and several rocks. The largest is **Rey Island**, which is about 17 m. long, north to south, and 8 m. broad, with an extreme elevation of 600 ft. The other larger islands are **San José**, **Pedro Gonzales**, **Casaya**, **Saboga** and **Pacheca**. There are several fishing villages whose inhabitants are largely engaged in the pearl fisheries, and a number of cocoa-nut plantations. The islands belong chiefly to Panama merchants. There are several groups of small islands on the northern coast, and a few small islands so near the mainland as to form sheltered harbours, as at **Cartagena**. The largest of these islands is **Baru**, lying immediately south of the entrance to **Cartagena** harbour. North-west of Colombia in the Caribbean Sea are several small islands belonging to the republic, two of which (**Great and Little Corn Is.**) lie very near the coast of **Nicaragua**. The largest and most important of these islands is **Vieja Providencia** (**Old Providence**), 120 m. off the **Mosquito Coast**, $4\frac{1}{2}$ m. long, which supports a small population.

The rivers of Colombia may be divided, for convenience of description, into three general classes according to the destination of their waters, the Pacific, Caribbean and Atlantic—the last reaching their destination through the Amazon and **Orinoco**. Of these, the Caribbean rivers are of the greatest economic importance to the country, though those of the eastern plains may at some time become nearly as important as transportation routes in a region possessing forest products of great importance and rich in agricultural and pastoral possibilities. It is worthy of note that the principal rivers of these three classes—the **Patia**, **Cauca**, **Magdalena**, **Caquetá** and **Putumayo**—all have their sources on the high plateaus of southern Colombia and within a comparatively limited area. The Pacific coast rivers are numerous, and discharge a very large volume of water into the ocean in proportion to the area of their drainage basins, because of the heavy rainfall on the western slopes of the Coast range. The proximity of this range to the coast limits them to short, precipitous courses, with comparatively short navigable channels. The principal rivers of this group, starting from the southern frontier, are the **Mira**, **Patia**, **Iscuande**, **Micai**, **Buenaventura** or **Dagua**, **San Juan** and **Baudo**. The **Mira** has its principal sources in **Ecuador**, and for a short distance forms the boundary line between the two republics, but its outlets and navigable channel are within Colombia. It has a large delta in proportion to the length of the river, which is visible evidence of the very large quantity of material brought down from the neighbouring mountain slopes. The **Patia** is the longest river of the Pacific group, and is the only one having its sources on the eastern side of the **Western Cordillera**. It is formed by the confluence of the **Sotara** and **Guaitara** at the point where the united streams turn westward to cut their way through the mountains to the sea. The **Sotara** or upper **Patia** rises on the southern slope of a transverse ridge or dyke, between the **Central** and **Western Cordilleras**, in the vicinity of **Popayan**, and flows southward about 120 m. to the point of confluence with the **Guaitara**. The latter has its sources on the elevated plateau of **Tuquerres** and flows north-west to meet the **Sotara**. The canyon of the **Patia** through the **Western Cordillera** is known as the "Minima gorge," and has been cut to a depth of 1676 ft., above which the perpendicular mountain sides rise like a wall some thousands of feet more. The upper course of the **Guaitara** is known as the **Carchi**, which for a short distance forms the boundary line between Colombia and **Ecuador**. At one point in its course it is crossed by the **Rumichaca** arch, a natural arch of stone, popularly known as the "Inca's bridge," which with the **Minima gorge** should be classed among the natural wonders of the world. There is a narrow belt of low, swampy country between the **Cordillera** and the coast, traversed at intervals by mountain spurs, and across this the river channels are usually navigable. The **San Juan** has built a large delta at its mouth, and is navigable for a distance of 140 m. inland, the river flowing parallel with the coast for a long distance instead of crossing the coastal plain. It rises in the angle between the **Western Cordillera** and a low transverse ridge connecting it with the **Baudo** coast range, and flows westward down to the valley between the two ranges, and then southward through this valley to about lat. $4^{\circ} 15'$ N., where it turns sharply westward and crosses a narrow belt of lowland to the coast. It probably has the largest discharge of water of the Pacific group, and has about 300 m. of navigable channels, including its tributaries, although the river itself is only 190 m. long and the sand-bars at its mouth have only 7 or 8 ft. of water on them. The **San Juan** is distinguished for having been one of the proposed

routes for a ship canal between the Caribbean and Pacific. At one point in its upper course it is so near the **Atrato** that, according to a survey by **Captain C. S. Cochrane, R.N.**, in 1824, a canal 400 yds. long with a maximum cutting of 70 ft., together with some improvements in the two streams, would give free communication. His calculations were made, of course, for the smaller craft of that time.

The rivers belonging to the Caribbean system, all of which flow in a northerly direction, are the **Atrato**, **Bacuba**, **Sinu**, **Magdalena** and **Zulia**. The **Bacuba**, **Suriquilla** or **Leon**, is a small stream rising on the western slopes of the **Cordillera** and flowing into the upper end of the **Gulf of Uraba**. Like the **Atrato** it brings down much silt, which is rapidly filling that depression. There are many small streams and one important river, the **Sinú**, flowing into the sea between this gulf and the mouth of the **Magdalena**. The **Sinu** rises on the northern slopes of the **Alto del Viento** near the 7th parallel, and flows almost due north across the coastal plain for a distance of about 286 m. to the **Gulf of Morosquillo**. It has a very sinuous channel which is navigable for small steamers for some distance, but there is no good port at its outlet, and a considerable part of the region through which it flows is malarial and sparsely settled. The most important rivers of Colombia, however, are the **Magdalena** and its principal tributary, the **Cauca**. They both rise on the high tableland of southern Colombia about 14,000 ft. above sea-level—the **Magdalena** in the **Laguna del Buey** (**Ox Lake**) on the **Las Papas** plateau, and the **Cauca** a short distance westward in the **Laguna de Santiago** on the **Paramo de Guanacas**—and flow northward in parallel courses with the great **Central Cordillera**, forming the water-parting between their drainage basins. The principal tributaries of the **Magdalena** are the **Suaza**, **Neiva**, **Cabrera**, **Prado**, **Fusagasaga**, **Funza** or **Bogotá**, **Carare**, **Opon**, **Sogamoso**, **Lebrija** and **Cesar**, and the western the **La Plata**, **Paez**, **Saldafia**, **Cuello**, **Guali**, **Samana** or **Miel**, **Nare** or **Negro** and **Cauca**. There are also many smaller streams flowing into the **Magdalena** from both sides of the valley. Of those named, the **Funza** drains the "sabana" of **Bogotá** and is celebrated for the great fall of **Tequendama**, about 480 ft. in height; the **Sogamoso** passes through some of the richest districts of the republic; and the **Cesar** rises on the elevated slopes of the **Sierra Nevada de Santa Marta** and flows southward across a low plain, in which are many lakes, to join the **Magdalena** where it bends westward to meet the **Cauca**. The course of the **Magdalena** traverses nine degrees of latitude and is nearly 1000 m. long. It is navigable for steamers up to **La Dorada**, near **Honda**, 561 m. above its mouth, which is closed by sand-bars to all but light-draught vessels, and for 93 m. above the rapids at **Honda**, to **Girardot**. The river is also navigable at high water for small steamers up to **Neiva**, 100 m. farther and 1535 ft. above sea-level, beyond which point it descends precipitously from the plateaus of southern Colombia. The **Honda** rapids have a fall of only 20 ft. in a distance of 2 m., but the current is swift and the channel tortuous for a distance of 20 m., which make it impossible for the light-draught, flat-bottomed steamers of the lower river to ascend them. The **Cauca** differs much from the **Magdalena**, although its principal features are the same. The latter descends 12,500 ft. before it becomes navigable, but at 10,000 ft. below its source the **Cauca** enters a long narrow valley with an average elevation of 3500 ft., where it is navigable for over 200 m., and then descends 2500 ft. through a series of impetuous rapids for a distance of about 250 m., between **Cartago** and **Cáceres**, with a break of 60 m. above **Antioquia**, where smooth water permits isolated navigation. While, therefore, the **Magdalena** is navigable throughout the greater part of its course, or from **Girardot** to the coast, with an abrupt break of only 20 ft. at **Honda** which could easily be overcome, the **Cauca** has only 200 m. of navigable water in the upper valley and another 200 m. on its lower course before it joins the **Magdalena** in lat. $9^{\circ} 30'$, the two being separated by 250 m. of canyon and rapids. So difficult is the country through which the **Cauca** has cut its tortuous course that the fertile upper valley is completely isolated from the Caribbean, and has no other practicable outlet than the overland route from **Cali** to **Buenaventura**, on the Pacific. The upper sources of the **Cauca** flow through a highly volcanic region, and are so impregnated with sulphuric and other acids that fish cannot live in them. This is especially true of the **Rio Vinagre**, which rises on the **Purace** volcano. The principal tributaries are the **Piendamó**, **Ovejas**, **Palo**, **Amaine** and **Nechi**, from the central **Cordillera**, of which the last named is the most important, and the **Jamundi** and a large number of small streams from the **Western**. The largest branch of the **Cauca** on its western side, however, is the **San Jorge**, which, though rising in the **Western Cordillera** on the northern slopes of the **Alto del Viento**, in about lat. 7° N., and not far from the sources of the **Sinú** and **Bacuba**, is essentially a river of the plain, flowing north-east across a level country filled with small lakes and subject to inundations to a junction with the **Cauca** just before it joins the **Magdalena**. Both the **San Jorge** and **Nechi** are navigable for considerable distances. The valley of the **Cauca** is much narrower than that of the **Magdalena**, and between **Cartago** and **Cáceres** the mountain ranges on both sides press down upon the river and confine it to a narrow canyon. The **Cauca** unites with the **Magdalena** about 200 m. from the sea through several widely separated channels, which are continually changing through the wearing away of the alluvial banks. These changes in the channel are also at work

in the Lower Magdalena. The remaining rivers of the Caribbean system, exclusive of the smaller ones rising in the Sierra Nevada de Santa Marta, are the Zulía and Catatumbo, which rise in the mountains of northern Santander and flow across the low plains of the Venezuelan state of Zulía into Lake Maracaibo.

Of the rivers of the great eastern plains, whose waters pass through the Orinoco and Amazon to the Atlantic, little can be said beyond the barest geographical description. The size and courses of many of their affluents are still unknown, as this great region has been only partially explored. The largest of these rivers flow across the plains in an easterly direction, those of the Orinoco system inclining northward, and those of the Amazon system southward. The first include the Guaviare or Guayabero, the Vichada, the Meta, and the upper course of the Arauca. The Guaviare was explored by Crevaux in 1881. It rises on the eastern slopes of the Eastern Cordillera between the 3rd and 4th parallels, about 75 m. south of Bogotá, and flows with a slight southward curve across the llanos to the Orinoco, into which it discharges at San Fernando de Atabapo in lat. 4° N. Its largest tributary is the Inirida, which enters from the south. The Guaviare has about 600 m. of navigable channel. The Meta rises on the opposite side of the Cordillera from Bogotá, and flows with a sluggish current east-north-east across the llanos to the Orinoco, into which it discharges below the Atures rapids, in lat. 6° 22' N. It is navigable throughout almost its whole length, small steamers ascending it to a point within 100 m. of Bogotá. Its principal tributaries, so far as known, are the Tuca, Chire and Casanare. The principal rivers of the Amazon system are the Napo, the upper part of which forms the provisional boundary line with Ecuador, the Putumayo or Iça, and the Caqueta or Japurá (Yapurá), which flow from the Andes entirely across the eastern plains, and the Guainia, which rises on the northern slopes of the Serra Tunaji near the provisional Brazilian frontier, and flows with a great northward curve to the Venezuelan and Brazilian frontiers, and is thereafter known as the Rio Negro, one of the largest tributaries of the Amazon. There are many large tributaries of these rivers in the unexplored regions of south-eastern Colombia, but their names as well as their courses are still unsettled.

The coast of Colombia faces on the Pacific Ocean and the Caribbean Sea, and is divided by the Isthmus of Panama into two completely separated parts. The Pacific coast-line, omitting minor

Coasts. convolutions, has a length of about 500 m., while that of the Caribbean is about 700 m. The former has been of slight service in the development of the country because of the unsettled and unhealthy character of the coast region, and the high mountain barriers between its natural ports and the settled parts of the republic. There are only two commercial ports on the coast, Tumaco and Buenaventura, though there are several natural harbours which would be of great service were there any demand for them. The rivers Mira, Patía and San Juan permit the entrance of small steamers, as also some of the smaller rivers. The larger bays on this coast are Tumaco, Chocó, Magdalena, Cabita, Coqui, Puerto Utria, Solano, Cupica and Octavia—some of them affording exceptionally safe and well-sheltered harbours. The Caribbean coast of Colombia has only four ports engaged in international trade—Barranquilla, Cartagena, Santa Marta and Rio Hacha. There are some smaller ports on the coast, but they are open only to vessels of light draft and have no trade worth mention. Barranquilla, the principal port of the republic, is situated on the Magdalena, and its seaport, or landing-place, is Puerto Colombia at the inner end of Savanilla Bay, where a steel pier 4000 ft. long has been built out to deep water, alongside which ocean-going vessels can receive and discharge cargo. The bay is slowly filling up, however, and two other landing-places—Salgar and Savanilla—had to be abandoned before Puerto Colombia was selected. The pier-head had 24 ft. of water alongside in 1907, but the silt brought down by the Magdalena is turned westward by the current along this coast, and may at any time fill the bay with dangerous shoals. The oldest and best port on the coast is Cartagena, 65 m. south-west of Barranquilla, which has a well-sheltered harbour protected by islands, and is connected with the Magdalena at Calamar by railway. The next best port is that of Santa Marta, about 46 m. east-north-east of Barranquilla (in a straight line), with which it is connected by 23 m. of railway and 50 m. of inland navigation on the Ciénaga de Santa Marta and eastern outlets of the Magdalena. Santa Marta is situated on a small, almost landlocked bay, well protected from prevailing winds by high land on the north and north-east, affording excellent anchorage in waters free from shoaling through the deposit of silt. The depth of the bay ranges from 4½ to 19 fathoms. The town stands at the foot of the Sierra Nevada de Santa Marta, which restricts the area of cultivatable land in its immediate vicinity, and the enclosing high lands make the climate hot and somewhat dangerous for foreigners. Since the development of the fruit trade on the shores of the Caribbean sea and Gulf of Mexico by an important American company, which owns a large tract of land near Santa Marta devoted to banana cultivation, and has built a railway 50 m. inland principally for the transportation of fruit, the trade of the port has greatly increased. The population of this region, however, is sparse, and its growth is slow. The fourth port on this coast is Rio Hacha, an open roadstead, about 93 m. east of Santa Marta, at the mouth of the small river Rancheira descending from

the eastern slopes of the Sierra Nevada de Santa Marta. It has little trade, and the undeveloped, unpopulated state of the country behind it affords no promise of immediate growth. There are other small towns on the coast which are ports for the small vessels engaged in the coasting and river trade, but they have no international importance because of their inaccessibility to ocean-going steamers, or the extremely small volume of their trade. The Gulf of Uraba is a large bight or southerly extension of the Gulf of Darien. It receives the waters of the Atrato, Bacuba, and a number of small rivers, and penetrates the land about 50 m., but has very little commercial importance because of the unhealthy and unsettled character of the neighbouring country, and because of the bar across its entrance formed by silt from the Atrato. The Gulf of Morosquillo, a broad shallow indentation of the coast south of Cartagena, receives the waters of the Rio Sinú, at the mouth of which is the small port of Cispatá. Between the mouth of the Magdalena and Santa Marta is the Ciénaga de Santa Marta, a large marshy lagoon separated from the sea by a narrow sand spit, having its "boca" or outlet at its eastern side. There is some traffic in small steamers on its shallow waters, which is increasing with the development of fruit cultivation on its eastern and southern sides. It extends inland about 31 m., and marks a deep indentation of the coast like the Gulf of Uraba.

Geology.—The geology of Colombia is very imperfectly known, and it is only by a comparison with the neighbouring regions that it is possible to form any clear idea of the geological structure and succession. The oldest rocks are gneisses and schists, together with granite and other eruptive rocks. These are overlaid by sandstones, slates and limestones, alternating with porphyries and porphyrites sometimes in the form of sheets, sometimes as breccias and conglomerates. Cretaceous fossils have been found abundantly in this series, but it is still possible that earlier systems may be represented. Coal-bearing beds, possibly of Tertiary age, occur in Antioquia and elsewhere. Structurally, the four main chains of Colombia differ considerably from one another in geological constitution. The low Cordilleras of the Chocos, on the west coast, are covered by soft Quaternary sandstones and marls containing shells of extant species, such as still inhabit the neighbouring ocean. The Western Cordillera is the direct continuation of the Western Cordillera of Ecuador, and, like the latter, to judge from the scattered observations which are all that are available, consists chiefly of sandstones and porphyritic rocks of the Cretaceous series. Between the Western and the Central Cordilleras is a longitudinal depression along which the river Cauca finds its way towards the sea. On the western side of this depression there are red sandstones with coal-seams, possibly Tertiary; the floor and the eastern side consist chiefly of ancient crystalline and schistose rocks. The Central Cordillera is the direct continuation of the Eastern Cordillera of Ecuador, and is formed chiefly of gneiss and other crystalline rocks, but sedimentary deposits of Cretaceous age also occur. Finally the Eastern branch, known as the Cordillera of Bogotá, is composed almost entirely of Cretaceous beds thrown into a series of regular anticlinals and synclinals similar to those of the Jura Mountains. The older rocks occasionally appear in the centre of the anticlinals. In all these branches of the Andes the folds run approximately in the direction of the chains, but the Sierra de Santa Marta appears to belong to a totally distinct system of folding, the direction of the folds being from west to east, bending gradually towards the south-east. Although volcanoes are by no means absent, they are much less important than in Ecuador, and their products take a far smaller share in the formation of the Andes. In Ecuador the depression between the Eastern and Western Cordilleras is almost entirely filled with modern lavas and agglomerates; in Colombia the corresponding Cauca depression is almost free from such deposits. In the Central Cordillera volcanoes extend to about 5° N.; in the Western Cordillera they barely enter within the limits of Colombia; in the Cordillera of Bogotá they are entirely absent.¹

Climate.—Were it not for the high altitudes of western Colombia, high temperatures would prevail over the whole country, except where modified by the north-east trade winds and the cold ocean current which sweeps up the western coast. The elevated plateaus and summits of the Andes are responsible, however, for many important and profound modifications in climate, not only in respect to the lower temperatures of the higher elevations, but also in respect to the higher temperatures of the sheltered lowland valleys and the varying climatic conditions of the neighbouring plains. The republic lies almost wholly within the north torrid zone, a comparatively small part of the forested Amazonian plain extending beyond

¹ See A. Hettner and G. Linck, "Beiträge zur Geologie und Petrographie der columbianischen Anden," *Zeits. deutsch. geol. Ges.* vol. xl. (1888), pp. 204-230; W. Sievers, "Die Sierra Nevada de Santa Marta und die Sierra de Perijá," *Zeits. Ges. Erdk. Berlin*, vol. xxiii. (1888), pp. 1-158 and p. 442, Pls. i. and iii.; A. Hettner, "Die Cordillere von Bogotá," *Peterm. Mit., Ergänzungsheft* 104 (1892), and "Die Anden des westlichen Columbiens," *Peterm. Mit.* (1893), pp. 129-136; W. Reiss and A. Stübel, *Reisen in Süd America. Geologische Studien in der Republik Colombia* (Berlin, 1892-1899),—a good geological bibliography will be found in part ii. of this work.

the equator into the south torrid zone. The great Andean barrier which crosses the republic from the south to north acts as a condenser to the prevailing easterly winds from the Atlantic, and causes a very heavy rainfall on their eastern slopes and over the forested Amazon plain. High temperatures as well as excessive humidity prevail throughout this region. Farther north, on the open llanos of the Orinoco tributaries, the year is divided into equal parts, an alternating wet and dry season, the sun temperatures being high followed by cool nights, and the temperatures of the rainy season being even higher. The rainfall is heavy in the wet season, causing many of the rivers to spread over extensive areas, but in the dry season the inundated plains become dry, the large rivers fed by the snows and rainfall of the Andes return within their banks, the shallow lagoons and smaller streams dry up, vegetation disappears, and the level plain becomes a desert. The northern plains of the republic are swept by the north-east trades, and here, too, the mountain barriers exercise a strongly modifying influence. The low ridges of the Sierra de Perijá do not wholly shut out these moisture-laden winds, but they cause a heavy rainfall on their eastern slopes, and create a dry area on their western flanks, of which the Vale of Upar is an example. The higher masses of the Sierra Nevada de Santa Marta cover a very limited area, leaving the trade winds a comparatively unbroken sweep across the northern plains until checked by the Western Cordillera, the Panama ranges and the Sierra de Baudo, where a heavy precipitation follows. Farther south the coast ranges cause a very heavy rainfall on their western slopes, which are quite as uninhabitable because of rain and heat as are the coasts of southern Chile through rain and cold. The rainfall on this coast is said to average 73 in., though it is much higher at certain points and in the Atrato Valley. As a result the coastal plain is covered with swamps and tangled forests, and is extremely unhealthy, except at a few favoured points on the coast. High temperatures prevail throughout the greater part of the Magdalena and Cauca valleys, because the mountain ranges which enclose them shut out the prevailing winds. At Honda, on the Magdalena, 664 ft. above sea-level, the mean temperature for the year is 82° F., and the mercury frequently rises to 102° in the shade. These lowland plains and valleys comprise the climatic tropical zone of Colombia, which is characterized by high temperatures, and by excessive humidity and dense forests, an exception to the last-named characteristic being the open llanos where dry summers prevail. Above this tropical zone in the mountainous regions are to be found all the varying gradations of climate which we are accustomed to associate with changes in latitude. There are the subtropical districts of the valleys and slopes between 1500 and 7500 ft. elevation, which include some of the most fertile and productive areas in Colombia; the temperate districts between 7500 and 10,000 ft., the cold, bleak and inhospitable *paramos* between 10,000 and 15,000 ft., and above these the arctic wastes of ice and snow. The temperate and subtropical regions cover the greater part of the departments traversed by the Eastern Cordillera, the northern end of the Central Cordillera, the Santa Marta plateaus, and the Upper Cauca Valley. They include the larger part of the white population and the chief productive industries of the country. There is no satisfactory record of temperatures and rainfall in these widely different climatic zones from which correct averages can be drawn and compared. Observations have been made and recorded at Bogotá and at some other large towns, but for the greater part of the country we have only fragmentary reports. The mean annual temperature on the eastern plains, so far as known, ranges from 87° F. on the forested slopes to 90° and 91° on the llanos of the Meta and Arauca. On the Caribbean coastal plain it ranges from 80° to 84°, but at Tumaco, on the Pacific coast, within two degrees of the equator, it is only 79°. At Medellín, in the mountainous region of Antioquia, 4950 ft. above sea-level, the mean annual temperature is 70°, and the yearly rainfall 55 in., while at Bogotá, 8563 ft., the former is 57° and the latter 44 in. At Tuquerres, near the frontier of Ecuador, 10,200 ft. elevation, the mean annual temperature is said to be 55°. The changes of seasons are no less complicated and confusing. A considerable part of the republic is covered by the equatorial belt of calms, whose oscillations divide the year into a wet and dry season. This division is modified, however, by the location of mountain ranges and by elevation. In the Amazon region there is no great change during the year, and on the northern plains the so-called dry season is one of light rains except where mountain ranges break the sweep of the north-east trades. The alternating wet and dry seasons are likewise to be found on the Pacific coastal plain, though this region is not entirely dry and vegetation never dries up as on the llanos. Above the lowland plains the seasons vary in character according to geographical position and elevation. The two-season division rules in the departments of Santander and Antioquia, but without the extremes of humidity and aridity characteristic of the eastern plains. Farther south, at elevations between 800 and 9500 ft., the year is divided into four distinct seasons—two wet and two dry—the former called *inviernos* (winters) and the latter *veranos* (summers). These seasons are governed by the apparent movements of the sun, the winters occurring at the equinoxes and the summers at the solstices. The *sabana* of Bogotá and neighbouring districts are subject to these changes of season. At higher altitudes long, cold, wet winters are experienced, with so short and cold a summer

between them that the bleak *paramos* are left uninhabited except by a few shepherds in the short dry season.

Fauna.—The geographical position of Colombia gives to it a fauna and flora largely characteristic of the great tropical region of the Amazon on the south-east, and of the mountainous regions of Central America on the north-west. At the same time it is rich in animal and plant types of its own, especially the latter, and is considered one of the best fields in South America for the student and collector. The fauna is essentially tropical, though a few species characteristic of colder regions are to be found in the higher Andes. Of the *Quadrumania* there are at least seventeen distinct species, and this number may be increased after a thorough exploration of the forested eastern plains. They are all arboreal in habit, and are to be found throughout the forested lowlands and lower mountain slopes. The carnivora are represented by seven or eight species of the *Felidae*, the largest of which are the puma (*Felis concolor*) and the jaguar (*F. onca*). These animals, together with the smaller ocelot, have a wide geographical range, and are very numerous in the valley of the Magdalena. Two species of bear and the "coati" (*Nasua*) represent the plantigrades and inhabit the mountain slopes, and, of *Pachydermata*, the peccary (*Dicotyles*) and "danta" or tapir (*Tapirus*) have a wide distribution throughout the lowland and lower plateau forests. The Colombian tapir is known as the *Tapirus Roulini*, and is slightly smaller than the Brazilian species (*T. americanus*). There are deer in the forests and on the open savannahs, the rabbit and squirrel are to be seen on the eastern slopes of the Andes, and partly amphibious rodents, the "capybara" (*Hydrochoerus*) and "guagua" (*Coelogenys subniger*), are very numerous along the wooded watercourses. The sloth, armadillo, opossum, skunk and a species of fox complete the list of the more common quadrupeds so far as known, though it is certain that a careful biological survey would discover many others. The large rivers of Colombia and the lakes of the lowlands are filled with alligators, turtles, and fish, and several species of fish are highly esteemed by the natives as food. The saurians are represented on land by several species of lizard, some of them conspicuous for their brilliant colouring, and by the large "iguana," whose flesh is considered a great delicacy. Among the ophidians, which include many harmless species, are the boa-constrictor, rattlesnake, the dreaded *Lachesis* and the coral snake. The "manatee" (*Manatus americanus*) is found in the Atrato and other large Colombian rivers.

In bird and insect life Colombia is second only to Brazil. The condor, which inhabits the higher Cordilleras, is peculiar to the whole Andean region, and is the largest of the Raptores. Among other members of this order are the eagle, osprey, vulture, buzzard, kite and hawk, with about a dozen species in all. Parrots and paroquets are numerous everywhere in the tropical and subtropical regions, as also the gorgeously coloured macaw and awkward toucan. The largest class, perhaps, is that formed by the astonishing number of water-fowl which throng the shallow lagoons and river beaches at certain seasons of the year. They are mostly migratory in habit, and are to be found in many other countries. Among these are the large white crane and small crane, the blue heron, the snowy-white egret, the roseate spoonbill (*Platalea ajaja*), stork, bittern and many species of ducks. The largest and most conspicuous member of this interesting family is the *Mycteria americana*, the gigantic stork so frequently seen in the Amazon valley, and even more numerous about the lagoons of northern Colombia. One of the best game-birds of the forest is the "crested curassow" (*Cyrax alector*), sometimes weighing 12 lb, which feeds on arboreal fruits and rarely comes to the ground. Colombia also possesses many species of the beautiful little humming-bird, among which are the tiny *Steganura Underwoodi* and the sword-bill, *Docimastes ensiferus*, which were found by Mr Albert Millian on a bleak *paramo* 12,000 ft. above sea-level. One of the most interesting birds found in the country is the "weaver-bird" (*Cassicus persicus*), which lives in colonies and suspends its long, pouch-like nest from the end of a horizontal branch of some high, isolated tree. In regard to insects, what has been said of Brazil will apply very closely to Colombia. Mosquitoes, butterflies, spiders, beetles and ants are infinitely numerous, and some of the species are indescribably troublesome.

Flora.—The Colombian flora is richer in species and individual characteristics than the fauna, owing in part to its greater dependence on climatic conditions. It ranges from the purely tropical types of the lowlands to the Alpine species of the more elevated *paramos*. It should be remembered, however, that large areas of the lowland plains have only a very limited arboreal growth. These plains include the extensive llanos of the Orinoco tributaries where coarse, hardy grasses and occasional clumps of palms are almost the only vegetation to be seen. There are other open plains in northern Colombia, sometimes covered with a shrubby growth, and the "mesas" (flat-topped mountains) and plateaus of the Cordilleras are frequently bare of trees. Farther up, on the cold, bleak *paramos*, only stunted and hardy trees are to be found. On the other hand, a luxuriant forest growth covers a very large part of the republic, including the southern plains of the Amazon tributaries, the foothills, slopes and valleys of the Cordilleras, a larger part of the northern plains, and the whole surface of the Western Cordillera and coast. The most conspicuous and perhaps the most universal type in all these regions, below an approximate elevation of 10,000 ft.,

is the palm, whose varieties and uses are incredibly numerous. On the eastern plains are to be found the "miriti" (*Mauritia flexuosa*) and the "pirijao" or peach palm (*Guilielma speciosa*), called the "pupunha" on the Amazon, whose fruit, fibre, leaf, sap, pith and wood meet so large a part of the primary needs of the aborigines. A noteworthy palm of the eastern Andean slopes is the "corneto" (*Deckeria*), whose tall, slender trunk starts from the apex of a number of aerial roots, rising like a cone 6 to 8 ft. above the ground. It is one of the most fruitful of palms, its clusters weighing from 120 to 200 lb each. Extensive groves of the coco-nut palm are to be found on the Caribbean coast, the fruit and fibre of which figure among the national exports. In north-eastern Colombia, where a part of the year is dry, the "curuas" form the prevailing species, but farther south, on the slopes of the Cordilleras up to an elevation of 10,000 ft., the wax-palm, or "palma de cera" (*Ceroxylon andicola*), is said to be the most numerous. It is a tall slender palm, and is the source of the vegetable wax so largely used in some parts of the country in the manufacture of matches, a single stem sometimes yielding 16-20 lb. Another widely distributed species in central Colombia is known as the "palmita del Azufral" in some localities, and as the "palma real" and "palma dulce" in others. Humboldt says it is not the "palma real" of Cuba (*Oreodoxa regia*), but in the Rio Sinú region is the *Cocos butyracea*, or the "palma dulce," from which palm wine is derived. Another palm of much economic importance in Colombia is the "tagua" (*Phytelephas macrocarpa*), which grows abundantly in the valleys of the Magdalena, Atrato and Patia, and produces a large melon-shaped fruit in which are found the extremely hard, fine-grained nuts or seeds known in the commercial world as vegetable ivory. The Colombian "Panama hat" is made from the fibres extracted from the ribs of the fan-shaped leaves of still another species of palm, *Carludovica palmata*, while in the Rio Sinú region the natives make a kind of butter ("manteca de Corozo") from the *Elaeis melanococca*, Mart., by peeling the nuts in water and then purifying the oil extracted in this way by boiling. This oil was formerly used for illuminating purposes. The forests are never made up wholly of palms, but are composed of trees of widely different characters, including many common to the Amazon region, together with others found in Central American forests, such as mahogany and "vera" or lignum vitae (*Zygothymum arborcum*). Brazilwood (*Caesalpinia echinata*), valuable for its timber and colouring extract, and "roco" (*Bixa orellana*), the "urucú" of Brazil which furnishes the anatto of commerce, are widely distributed in central and southern Colombia, and another species of the first-named genus, the *C. coariaria*, produces the "divi-divi" of the Colombian export trade—a peculiarly shaped seed-pod, rich in tannic and gallic acids, and used for tanning leather. The rubber-producing *Hevea guayanensis* is found in abundance on the Amazon tributaries, and the *Castilloa elastica* is common to all the Caribbean river valleys. Southern Colombia, especially the eastern slopes of the Andes, produces another valuable tree, the *Cinchona calisaya*, from the bark of which quinine is made. These are but a few of the valuable cabinet woods, dye-woods, &c., which are to be found in the forests, but have hardly been reached by commerce because of their inaccessibility and the unsettled state of the country. The adventurous orchid-hunter, however, has penetrated deeply into their recesses in search of choice varieties, and collectors of these valuable plants are largely indebted to Colombia for their specimens of *Catleya Mendelli*, *Warszewiczii* and *Trianae*; *Downiana aurea*, *Odontoglossum crispum*, *Pescatorei*, *Vexillarium*, *odoratum*, *coronarum*, *Harryanum*, and *blandum*; *Miltonia vexillaria*; *Oncidium carthaginense* and *Kramerianum*; *Masdevalliae*, *Epidendrum*, *Schomburgkiae* and many others. Colombia is also the home of the American "Alpine rose" (*Befaria*), which is to be found between 9000 and 11,000 ft. elevation, and grows to a height of 5-6 ft. Tree ferns have a remarkable growth in many localities, their stems being used in southern Cundinamarca to make corduroy roads. The South American bamboo (*Bambusa guadua*) has a very wide range, and is found nearly up to the limit of perpetual snow. The cactus is also widely distributed, and is represented by several well-known species. Among the more common fruit-trees, some of which are exotics, may be mentioned cacao (*Theobroma*), orange, lemon, lime, pine-apple, banana, guava (*Psidium*), breadfruit (*Artocarpus*), cashew (*Anacardium*), alligator pear (*Persea*), with the apple, peach, pear, and other fruits of the temperate zone on the elevated plateaus. Other food and economic plants are coffee, rice, tobacco, sugar-cane, cotton, indigo, vanilla, cassava or "yuca," sweet and white potatoes, wheat, maize, rye, barley, and vegetables of both tropical and temperate climates. It is claimed in Colombia that a species of wild potato found on the *paramos* is the parent of the cultivated potato.

Population.—The number of the population of Colombia is very largely a matter of speculation. A census was taken in 1871, when the population was 2,951,323. What the vegetative increase has been since then (for there has been no immigration) is purely conjectural, as there are no available returns of births and deaths upon which an estimate can be based. Civil war has caused a large loss of life, and the withdrawal from their

homes of a considerable part of the male population, some of them for military service and a greater number going into concealment to escape it, and it is certain that the rate of increase has been small. Some statistical authorities have adopted 1½% as the rate, but this is too high for such a period. All things considered, an annual increase of 1% for the thirty-five years between 1871 and 1906 would seem to be more nearly correct, which would give a population in the latter year—exclusive of the population of Panama—of a little over 3,800,000. The *Statesman's Year Book* for 1907 estimates it at 4,279,674 in 1905, including about 150,000 wild Indians, while Supan's *Die Bevölkerung der Erde* (1904) places it at 3,917,000 in 1899. Of the total only 10% is classed as white and 15% as Indian, 40% as mestizos (white and Indian mixture), and 35% negroes and their mixtures with the other two races. The large proportion of mestizos, if these percentages are correct, is significant because it implies a persistence of type that may largely determine the character of Colombia's future population, unless the more slowly increasing white element can be reinforced by immigration.

The white contingent in the population of Colombia is chiefly composed of the descendants of the Spanish colonists who settled there during the three centuries following its discovery and conquest. Mining enterprises and climate drew them into the highlands of the interior, and there they have remained down to the present day, their only settlements on the hot, unhealthy coast being the few ports necessary for commercial and political intercourse with the mother country. The isolation of these distant inland settlements has served to preserve the language, manners and physical characteristics of these early colonists with less variation than in any other Spanish-American state. They form an intelligent, high-spirited class of people, with all the defects and virtues of their ancestry. Their isolation has made them ignorant to some extent of the world's progress, while a supersensitive patriotism blinds them to the discredit and disorganization which political strife and misrule have brought upon them. A very small proportion of the white element consists of foreigners engaged in commercial and industrial pursuits, but they very rarely become permanently identified with the fortunes of the country. The native whites form the governing class, and enjoy most of the powers and privileges of political office.

Of the original inhabitants there remain only a few scattered tribes in the forests, who refuse to submit to civilized requirements, and a much larger number who live in organized communities and have adopted the language, customs and habits of the dominant race. Their total number is estimated at 15% of the population, or nearly 600,000, including the 120,000 to 150,000 credited to the uncivilized tribes. Many of the civilized Indian communities have not become wholly Hispanized and still retain their own dialects and customs, their attitude being that of a conquered race submitting to the customs and demands of a social organization of which they form no part. According to Uricoechea there are at least twenty-seven native languages spoken in the western part of Colombia, fourteen in Tolima, thirteen in the region of the Caquetá, twelve in Panama, Bolívar and Magdalena, ten in Bogotá and Cundinamarca, and thirty-four in the region of the Meta, while twelve had died out during the preceding century. The tribes of the Caribbean seaboard, from Chiriqui to Goajira, are generally attached to the great Carib stock; those of the eastern plains show affinities with the neighbouring Brazilian races; those of the elevated Tuquerres district are of the Peruvian type; and the tribes of Antioquia, Cauca, Popayan and Neiva preserve characteristics more akin to those of the Aztecs than to any other race. At the time of the Spanish Conquest the most important of these tribes was the Muyscas or Chibchas, who inhabited the tablelands of Bogotá and Tunja, and had attained a considerable degree of civilization. They lived in settled communities, cultivated the soil to some extent, and ascribed their progress toward civilization to a legendary cause remarkably similar to those of the Aztecs of Mexico and the Incas of Peru. They are represented by some tribes living on the head-waters of the Meta,

and their blood flows in the veins of the *mestizos* of the Bogotá plateau. Their ancient language has been partly preserved through the labours of Gonzalo Bermudez, José Dadei, Bernardo de Lugo, and Ezequiel Uriceochea, the last having made it the subject of a special study. According to this author the Chibchas were composed of three loosely united nationalities governed by three independent chiefs—the *Zipa* of Muequetá (the present Funza), the *Zaque* of Hunsa (now Tunja), and the *Jeque* of Iraca, who was regarded as the successor of the god Nemterequeteba, whom they worshipped as the author of their civilization. The latter had his residence at Suamoz, or Sogamoso.

The Tayronas, of the Santa Marta highlands, who have totally disappeared, were also remarkable for the progress which they had made toward civilization. Evidence of this is to be found in the excellent roads which they constructed, and in the skilfully made gold ornaments which have been found in the district which they occupied, as well as in the contemporary accounts of them by their conquerors. Among the tribes which are still living in a savage state are the Mesayas, Caquetas, Mocoas, Amarizanos, Guipanabis and Andaquies of the unsettled eastern territories; the Goajiros, Motilones, Guainetas, and Cocinas of the Rio Hacha, Upar and Santa Marta districts; and the Dariens, Cunacunas, and Chocos of the Atrato basin. These tribes have successfully resisted all efforts to bring them under political and ecclesiastical control, and their subjection is still a matter of no small concern to the Colombian government. As late as the year 1900 Mr Albert Millican, while collecting orchids on the Opon river, a tributary of the Magdalena between Bogotá and the Caribbean coast, was attacked by hostile Indians, and one of his companions was killed by a poisoned arrow. These hostile tribes are usually too small to make much trouble, but they are able to make exploration and settlement decidedly dangerous in some districts.

The *mestizos*, like the whites and Indians, chiefly inhabit the more elevated regions of the interior. They are of a sturdy, patient type, like their Indian ancestors, and are sufficiently industrious to carry on many of the small industries and occupations, and to meet the labour requirements of the inhabited plateau districts. Those of the urban middle classes are shopkeepers and artisans, and those of the lower class are domestics and day labourers. The whites of Spanish descent object to manual labour, and this places all such occupations in the hands of the coloured races. In the country the *mestizos* are small agriculturists, herders, labourers and fishermen; but there are many educated and successful merchants and professional men among them. There are no social barriers in their intercourse with the whites, nor race barriers against those who have political aspirations. The negroes of pure blood are to be found principally on the coastal plains and in the great lowland river valleys, where they live in great part on the bounties of nature. A small percentage of them are engaged in trade and other occupations; a few are small agriculturists.

Bogotá was reputed to be a centre of learning in colonial times, but there was no great breadth and depth to it, and it produced nothing of real value. By nature the Spanish-American loves art and literature, and the poetic faculty is developed in him to a degree rarely found among the Teutonic races. Writing and reciting poetry are universal, and fill as important a place in social life as instrumental music. In Colombia, as elsewhere, much attention has been given to belles-lettres among the whites of Spanish descent, but as yet the republic has practically nothing of a permanent character to show for it. The natural sciences attracted attention very early through the labours of José Celestino Mútis, who was followed by a number of writers of local repute, such as Zea, Cabal, Cálidas, Pombo, Cespedes, Camacho and Lozano. We are indebted to Humboldt for our earliest geographical descriptions of the northern part of the continent, but to the Italian, Augustin Codazzi, who became a Colombian after the War of Independence, Colombia is indebted for the first systematic exploration of her territory. Geographical description has had a peculiar fascination for Colombian writers, and there have been a number of books issued since the

appearance of Codazzi's *Resumen* and *Atlas*. Historical writing has also received much attention, beginning with the early work of José Manuel Restrepo (1827), and a considerable number of histories, compendiums and memoirs have been published, but none of real importance. Some good work has been done in ethnography and archaeology by some writers of the colonial period, and by Ezequiel Uriceochea and Ernesto Restrepo.

Territorial Divisions and Towns.—Previously to 1903 the republic was divided into nine departments, which were then reduced to eight by the secession of Panama. This division of the national territory was modified in 1905, by creating seven additional departments from detached portions of the old ones, and by cutting up the unsettled districts of Goajira and the great eastern plains into four *intendencias*. The fifteen departments thus constituted, with the official estimates of 1905 regarding their areas and populations, are as follows:—

Department.	Area sq. m.	Estimated Population.	Capital.	Estimated Population.
Antioquia . .	24,400	750,000	Medellin .	60,000
Atlantico . .	1,080	104,674	Barranquilla .	40,115
Bolívar . . .	23,940	250,000	Cartagena . .	14,000
Boyacá . . .	4,630	350,000	Tunja	10,000
Caldas . . .	7,920	150,000	Manizales . .	20,000
Cauca	26,030	400,000	Popayán . . .	10,000
Cundinamarca	5,060	225,000	Facatativá . .	12,000
Galán	6,950	300,000	San Gil	15,000
Huila	8,690	150,000	Neiva	10,000
Magdalena . .	20,460	100,000	Santa Marta . .	6,000
Nariño	10,040	200,000	Pasto	6,000
Quesada . . .	2,900	300,000	Zipaquirá . . .	12,000
Santander . .	11,970	300,000	Bucaramanga .	20,000
Tolima	10,900	200,000	Ibagué	12,000
Tundama . . .	2,390	300,000	Santa Rosa . .	6,000
Federal District	..	200,000	Bogotá	120,000
Intendencias (4)	277,620
Totals	444,980	4,279,674

Of these departments the original eight are Antioquia, Bolívar, Boyacá (or Bojacá), Cauca, Cundinamarca, Magdalena, Santander and Tolima. The four *intendencias* are called Goajira, Meta, Alto Caquetá and Putumayo, and their aggregate area is estimated to be considerably more than half of the republic. The first covers the Goajira peninsula, which formerly belonged to the department of Magdalena, and the other three roughly correspond to the drainage basins of the three great rivers of the eastern plains whose names they bear. These territories formerly belonged to the departments of Boyacá, Cundinamarca and Cauca. The seven new departments are: Atlantico, taken from the northern extremity of Bolívar; Cálidas, the southern part of Antioquia; Galán, the southern districts of Santander, including Charalá, Socorro, Velez, and its capital San Gil; Huila, the southern part of Tolima, including the headwaters of the Magdalena and the districts about Neiva and La Plata; Nariño, the southern part of Cauca extending from the eastern Cordillera to the Pacific coast; Quesada, a cluster of small, well-populated districts north of Bogotá formerly belonging to Cundinamarca, including Zipaquirá, Guatavita, Ubaté and Pacho; and Tundama, the northern part of Boyacá lying on the frontier of Galán in the vicinity of its capital Santa Rosa. The Federal District consists of a small area surrounding the national capital taken from the department of Cundinamarca. These fifteen departments are subdivided into provinces, 92 in all, and these into municipalities, of which there are 740.

The larger cities and towns of the republic other than the department capitals, with their estimated populations in 1904, are:—

Aguadas (Antioquia)	13,000
Antioquia "	13,000
Barbacoas (Nariño)	16,000
Buga (Cauca)	12,500
Cali (Cauca)	16,000
Chiquinquirá (Boyacá)	18,000
La Mesa (Cundinamarca)	10,000
Pamplona (Santander)	11,000
Palmira (Cauca)	15,000

Pié de Cuesta (Santander)	12,000
Puerto Nacional	16,000
Río Negro (Antioquia)	12,000
Santa Rosa de Osos (Antioquia)	11,000
Sonson	15,000
San José de Cúcuta (Santander)	13,000
Soatá (Boyacá)	16,000
Socorro (Galán)	20,000
Velez "	15,000

Among the smaller towns which deserve mention are Ambalema on the upper Magdalena, celebrated for its tobacco and cigars; Buenaventura (*q.v.*); Chaparral (9000), a market town of Tolima in the valley of the Saldaña, with coal, iron and petroleum in its vicinity; Honda (6000), an important commercial centre at the head of navigation on the lower Magdalena; Girardot, a railway centre on the upper Magdalena; and Quibdó, a small river town at the head of navigation on the Atrato.

Communications.—The railway problem in Colombia is one of peculiar difficulty. The larger part of the inhabited and productive districts of the republic is situated in the mountainous departments of the interior, and is separated from the coast by low, swampy, malarial plains, and by very difficult mountain chains. These centres of production are also separated from each other by high ridges and deep valleys, making it extremely difficult to connect them by a single transportation route. The one common outlet for these districts is the Magdalena river, whose navigable channel penetrates directly into the heart of the country. From Bogotá the Spaniards constructed two partially-paved highways, one leading down to the Magdalena in the vicinity of Honda, while the other passed down into the upper valley of the same river in a south-westerly direction, over which communication was maintained with Popayan and other settlements of southern Colombia and Ecuador. This highway was known as the *camino real*. Political independence and misrule led to the abandonment of these roads, and they are now little better than the bridle-paths which are usually the only means of communication between the scattered communities of the Cordilleras. In some of the more thickly settled and prosperous districts of the Eastern Cordillera these bridle paths have been so much improved that they may be considered reasonably good mountain roads, the traffic over them being that of pack animals and not of wheeled vehicles. Navigation on the lower Magdalena closely resembles that of the Mississippi, the same type of light-draft, flat-bottomed steamboat being used, and similar obstacles and dangers to navigation being encountered. There is also the same liability to change its channel, as shown in the case of Mompos, once an important and prosperous town of the lower plain situated on the main channel, now a decaying, unimportant place on a shallow branch 20 m. east of the main river. Small steamers also navigate the lower Cauca and Nechi rivers, and a limited service is maintained on the upper Cauca.

With three exceptions all the railway lines of the country lead to the Magdalena, and are dependent upon its steamship service for transportation to and from the coast. In 1906, according to an official statement, these lines were: (1) The Barranquilla and Savanilla (Puerto Colombia), 17½ m. in length; (2) the Cartagena and Calamar, 65 m., (3) the La Dorada & Arancaplumas (around the Honda rapids), 20½ m., (4) the Colombian National, from Girardot to Facatativá, 80 m., of which 48½ m. were completed in 1906; (5) the Girardot to Espinal, 13½ m., part of a projected line running south-west from Girardot; (6) the Sabana railway, from Bogotá to Facatativá, 25 m.; (7) the Northern, from Bogotá to Zipaquirá, 31 m.; (8) the Southern, from Bogotá to Sibaté, 18 m., and (9) the Puerto Berrio & Medellín, about 78 m. long, of which 36 are completed. The three lines which do not connect with the Magdalena are: (1) the Cúcuta and Villamazar, 43½ m., the latter being a port on the Zulia river near the Venezuelan frontier; (2) the Santa Marta railway, running inland from that port through the banana-producing districts, with 41½ m. in operation in 1907; and (3) the Buenaventura and Cali, 23 m. in operation inland from the former. This gives a total extension

of 383 m. in 1906, of which 226 were built to connect with steamship transportation on the Magdalena, 49 to unite Bogotá with neighbouring localities, and 108 to furnish other outlets for productive regions. There is no system outlined in the location of these detached lines, though in 1905-1908 President Reyes planned to connect them in such a way as to form an extensive system radiating from the national capital. Tramway lines were in operation in Bogotá, Barranquilla and Cartagena in 1907.

The telegraph and postal services are comparatively poor, owing to the difficulty of maintaining lines and carrying mails through a rugged and uninhabited tropical country. The total length of telegraph lines in 1903 was 6470 m., the only cable connexion being at Buenaventura, on the Pacific coast. All the principal Caribbean ports and department capitals are connected with Bogotá, but interruptions are frequent because of the difficulty of maintaining lines through so wild a country.

There are only five ports, Buenaventura, Barranquilla, Cartagena, Santa Marta and Río Hacha, which are engaged in foreign commerce, though Tumaco and Villamazar are favourably situated for carrying on a small trade with Ecuador and Venezuela. Colombia has no part in the carrying trade, however, her merchants marine in 1905 consisting of only one steamer of 457 tons and five sailing vessels of 1385 tons. Aside from these, small steamers are employed on some of the small rivers with barges, called "bongoes," to bring down produce and carry back merchandise to the inland trading centres. The coasting trade is insignificant, and does not support a regular service of even the smallest boats. The foreign carrying trade is entirely in the hands of foreigners, in which the Germans take the lead, with the British a close second. The Caribbean ports are in frequent communication with those of Europe and the United States.

Agriculture.—The larger part of the Colombian population is engaged in agricultural and pastoral pursuits. Maize, wheat and other cereals are cultivated on the elevated plateaus, with the fruits and vegetables of the temperate zone, and the European in Bogotá is able to supply his table very much as he would do at home. The plains and valleys of lower elevation are used for the cultivation of coffee and other sub-tropical products, the former being produced in nearly all the departments at elevations ranging from 3500 to 6500 ft. This industry has been greatly prejudiced by civil wars, which not only destroyed the plantations and interrupted transportation, but deprived them of the labouring force essential to their maintenance and development. It is estimated that the revolutionary struggle of 1899-1903 destroyed 10% of the able-bodied agricultural population of the Santa Marta district, and this estimate, if true, will hold good for all the inhabited districts of the Eastern Cordillera. The best coffee is produced in the department of Cundinamarca in the almost inaccessible districts of Fusagasagá and La Palma. Tolima coffee is also considered to be exceptionally good. The department of Santander, however, is the largest producer, and much of its output in the past has been placed upon the market as "Maracaibo," the outlet for this region being through the Venezuelan port of that name. Coffee cultivation in the Santa Marta region is receiving much attention on account of its proximity to the coast.

The tropical productions of the lower plains include, among others, many of the leading products of the world, such as cacao, cotton, sugar, rice, tobacco, and bananas, with others destined wholly for home consumption, as yams, cassava and arracacha. Potatoes are widely cultivated in the temperate and sub-tropical regions, and sweet potatoes in the sub-tropical and tropical. Although it is found growing wild, cacao is cultivated to a limited extent, and the product is insufficient for home consumption. Cotton is cultivated only on a small scale, although there are large areas suitable for the plant. The staple product is short, but experiments have been initiated in the Santa Marta region to improve it. Sugar cane is another plant admirably adapted to the Colombian lowlands, but it is cultivated to so limited an extent that the sugar produced is barely sufficient for home consumption. Both cultivation and manufacture have been carried on in the old time way, by the rudest of methods, and the principal product is a coarse brown sugar, called *panela*, universally used by the poorer classes as an article of food and for making a popular beverage. Antiquated refining processes are also used in the manufacture of an inferior white sugar, but the quantity produced is small, and it is unable to compete with beet-sugar from Germany. A considerable part of the sugar-cane produced is likewise devoted to the manufacture of *chicha* (rum), the consumption of which is common among the Indians and half-breeds of the Andean regions.

Rice is grown to a very limited extent, though it is a common article of diet and the partially submerged lowlands are naturally

adapted to its production. Tobacco was cultivated in New Granada and Venezuela in colonial times, when its sale was a royal monopoly and its cultivation was restricted to specified localities. The Colombian product is best known through the Ambalema, Girardot, and Palmira tobacco, especially the Ambalema cigars, which are considered by some to be hardly inferior to those of Havana, but the plant is cultivated in other places and would probably be an important article of export were it possible to obtain labourers for its cultivation. Banana cultivation for commercial purposes is a comparatively modern industry, dating from 1892 when the first recorded export of fruit was made. Its development is due to the efforts of an American fruit-importing company, which purchased lands in the vicinity of Santa Marta for the production of bananas and taught the natives that the industry could be made profitable. A railway was built inland for the transportation of fruit to Santa Marta, and is being extended toward the Magdalena as fast as new plantations are opened. The growth of the industry is shown in the export returns, which were 171,891 bunches for 1892, and 1,397,388 bunches for 1906, the area under cultivation being about 7000 acres in the last-mentioned year. Yams, sweet potatoes, cassava and arracacha are chiefly cultivated for domestic needs, but in common with other fruits and vegetables they give occupation to the small agriculturalists near the larger towns.

The pastoral industry dates from colonial times and engages the services of a considerable number of people, but its comparative importance is not great. The open plains, "mesas," and plateaus of the north support large herds of cattle, and several cattle ranches have been established on the Meta and its tributaries. Live cattle, to a limited extent, are exported to Cuba and other West Indian markets, but the chief produce from this industry is hides. The department of Santander devotes considerable attention to horse-breeding. Goats are largely produced for their skins, and in some localities, as in Cauca, sheep are raised for their wool. Swine are common to the whole country, and some attention has been given to the breeding of mules.

Minerals.—The mineral resources of Colombia are commonly believed to be the principal source of her wealth, and this because of the precious metals extracted from her mines since the Spanish invasion. The estimate aggregate for three and a half centuries is certainly large, but the exact amount will probably never be known, because the returns in colonial times were as defective as those of disorderly independence have been. Humboldt and Chevalier estimated the total output down to 1845 at £1,200,000, which Professor Soetbeer subsequently increased to £169,422,750. A later Colombian authority, Vicente Restrepo, whose studies of gold and silver mining in Colombia have been generally accepted as conclusive and trustworthy, after a careful sifting of the evidence on which these two widely diverse conclusions were based and an examination of records not seen by Humboldt and Soetbeer, reaches the conclusion that the region comprised within the limits of the republic, including Panama, had produced down to 1886 an aggregate of £127,800,000 in gold and £6,600,000 in silver. This aggregate he distributes as follows:—

16th century	£10,600,000
17th "	34,600,000
18th "	41,000,000
19th "	41,600,000

According to his computations the eight Colombian departments, omitting Panama, had produced during this period in gold and silver:—

Antioquia	£50,000,000
Cauca	49,800,000
Tolima	10,800,000
Santander	3,000,000
Bolívar	1,400,000
Cundinamarca	360,000
Magdalena	200,000
Boyacá	40,000

£115,600,000

Three-fourths of the gold production, he estimates, was derived from alluvial deposits. Large as these aggregates are, it will be seen that the annual production was comparatively small, the highest average, that for the 19th century, being less than £500,000 a year. Toward the end of the 19th century, after a decline in production due to the abolition of slavery and to civil wars, increased interest was shown abroad in Colombian mining operations. Medellín, the capital of Antioquia, is provided with an electrolytic refining establishment, several assaying laboratories, and a mint. The department of Cauca is considered to be the richest of the republic in mineral deposits, but it is less conveniently situated for carrying on mining operations. Besides this, the extreme unhealthiness of its most productive regions, the Chocó and Barbacoas districts on the Pacific slope, has been a serious obstacle to foreign enterprise. Tolima is also considered to be rich in gold and (especially) silver deposits. East of the Magdalena the production of these two metals has been comparatively small. In compensation the famous emerald mines of Muzo and Coscuez are situated in an extremely mountainous region north of Bogotá and near the town of

Chiquinaquirá, in the department of Boyacá. The gems are found in a matrix of black slate in what appears to be the crater of a volcano, and are mined in a very crude manner. The mines are owned by the government. The revenue was estimated at £96,000 for 1904. Platinum is said to have been discovered in Colombia in 1720, and has been exported regularly since the last years of the 18th century. It is found in many parts of the country, but chiefly in the Choco and Barbacoas districts, the annual export from the former being about 10,000 in value. Of the bulkier and less valuable minerals Colombia has copper, iron, manganese, lead, zinc and mercury. Coal is also found at several widely-separated places, but is not mined. There are also indications of petroleum in Tolima and Bolívar. These minerals, however, are of little value to the country because of their distance from the seaboard and the costs of transportation. Salt is mined at Zipaquirá, near Bogotá, and being a government monopoly, is a source of revenue to the national treasury.

Manufactures.—The Pradera iron works, near Bogotá, carry on some manufacturing (sugar boilers, agricultural implements, &c.) in connexion with their mining and reducing operations. Pottery and coarse earthenware are made at Espinal, in Tolima, where the natives are said to have had a similar industry before the Spanish conquest. There are woollen mills at Popayan and Pasto, and small cigar-making industries at Ambalema and Palmira. Hat-making from the "jipijapa" fibre taken from the *Carludovica* palm is a domestic industry in many localities, and furnishes an article of export. Friction matches are made from the vegetable wax extracted from the *Ceroxylon* palm, and are generally used throughout the interior. Rum and sugar are products of a crude manufacturing industry dating from colonial times. A modern sugar-mill and refinery at Sincerin, 28 m. from Cartagena, was the first of its kind erected in the republic. It is partially supported by the government, and the concession provides that the production of sugar shall not be less than 2,600,000 lb per annum.

Commerce.—In the Barranquilla customs returns for 1906 the imports were valued at \$6,787,055 (U.S. gold), on which the import duties were \$4,333,028, or an average rate of 64%. According to a statistical summary issued in 1906 by the U.S. Bureau of Statistics, entitled "Commercial America in 1905," the latest official return to the foreign trade of Colombia was said to be that of 1898, which was: imports 11,083,000 pesos, exports 19,158,000 pesos. Uncertainty in regard to the value of the peso led the compiler to omit the equivalents in U.S. gold, but according to foreign trade returns these totals represent gold values, which at 4s. per peso are: imports £2,216,600, exports £3,831,600. In his annual message to congress on the 1st of April 1907, President Reyes stated that the imports for 1904 were \$14,453,000, and the exports \$12,658,000, presumably U.S. gold, as the figures are taken from the *Monthly Bulletin* of the Bureau of American Republics (July 1907). An approximate equivalent would be: imports £3,011,000, exports £2,637,000; which shows a small increase in the first and a very large decrease in the second. The imports include wheat flour, rice, barley, prepared foods, sugar, coal, kerosene, beer, wines and liquors, railway equipment, machinery and general hardware, fence wire, cotton and other textiles, drugs, lumber, cement, paper, &c., while the exports comprise coffee, bananas, hides and skins, tobacco, precious metals, rubber, cabinet woods, divi-divi, dye-woods, vegetable ivory, Panama hats, orchids, vanilla, &c.

Government.—The government of Colombia is that of a centralized republic composed of 15 departments, 1 federal district, and 4 intendencias (territories). It is divided into three co-ordinate branches, legislative, executive and judicial, and is carried on under the provisions of the constitution of 1886, profoundly modified by the amendments of 1905. Previous to 1886, the departments were practically independent, but under the constitution of that year the powers of the national government were enlarged and strengthened, while those of the departments were restricted to purely local affairs. The departments are provided with biennial departmental assemblies, but their governors are appointees of the national executive.

The legislative branch consists of a senate and chamber of deputies, which meets at Bogotá biennially (after 1908) on February 1st for an ordinary session of ninety days. The Senate is composed of 48 members—3 from each department chosen by the governor and his departmental council, and 3 from the federal district chosen by the president himself and two of his cabinet ministers. Under this arrangement the president practically controls the choice of senators. Their term of office is four years, and is renewed at the same time and for the same period as those of the lower house. The chamber is composed of 67 members, elected by popular suffrage in the departments, on the basis of one representative for each 50,000 of population. The intendencias are represented by one member each, who is chosen by the intendant, his secretary, and 3 citizens elected

by the municipal council of the territorial capital. As the constituent assembly which amended the constitution, according to the president's wishes in 1905, was to continue in office until 1908 and to provide laws for the regulation of elections and other public affairs, it appeared that the president would permit no expression of popular dissent to interfere with his purpose to establish a dictatorial régime in Colombia similar to the one in Mexico.

The executive power is vested in a president chosen by Congress for a period of four years. The first presidential period, dating from the 1st of January 1905, was for ten years, and no restriction was placed upon the choice of President Rafael Reyes to succeed himself. The constituent assembly gave the president exceptional powers to deal with all administrative matters. He is assisted by a cabinet of six ministers, interior, foreign affairs, finance, war, public instruction and public works, who are chosen and may be removed by himself. The office of vice-president is abolished, and the president is authorized to choose a temporary substitute from his cabinet, and in case of his death or resignation his successor is chosen by the cabinet or the governor of a department who happens to be nearest Bogotá at the time. The president is authorized to appoint the governors of departments, the intendants of territories, the judges of the supreme and superior courts, and the diplomatic representatives of the republic. His salary, as fixed by the 1905 budget, is £3600 a year, and his cabinet ministers receive £1200 each. The council of state is abolished and the senate is charged with the duty of confirming executive appointments.

The judicial branch of the government, like the others, has been in great measure reorganized. It consists of a supreme court of seven members at Bogotá, and a superior court in each judicial district. There are various inferior courts also, including magistrates or *juces de paz*, but their organization and functions are loosely defined and not generally understood outside the republic. The supreme court has appellate jurisdiction in judicial matters, and original jurisdiction in impeachment trials and in matters involving constitutional interpretation. Under the constitution of 1886 the judges of the higher courts were appointed for life, but the reforms of 1905 changed their tenure to five years for the supreme court and four years for the superior courts, the judges being eligible for re-appointment.

The departments, which are administered by governors representing the national executive, are permitted to exercise restricted legislative functions relating to purely local affairs. Municipal councils are also to be found in the larger towns. The governor is assisted by a departmental council consisting of his secretaries and the president of the *Corte de Cuentas*, which places the political administration of the department under the direct control of the president at Bogotá.

The strength of the army is determined annually by congress, but every able-bodied citizen is nominally liable to military service. Its peace footing in 1898 was 1000 men. After the war of 1899-1903 its strength was successively reduced to 10,000 and 5000, a part of this force being employed in the useful occupation of making and repairing public roads. The navy in 1906 consisted of only three small cruisers on the Caribbean coast, and two cruisers, two gunboats, one troopship and two steam launches on the Pacific. There was also one small gunboat on the Magdalena.

Education.—Although Bogota was reputed to be an educational centre in colonial times, so slight an influence did this exert upon the country that Colombia ended the 19th century with no effective public school system, very few schools and colleges, and fully 90 % of illiteracy in her population. This is due in great measure to the long reign of political disorder, but there are other causes as well. As in Chile, the indifference of the ruling class to the welfare of the common people is a primary cause of their ignorance and poverty, to which must be added the apathy, if not opposition, of the Church. Under such conditions primary schools in the villages and rural districts were practically unknown, and the parish priest was the only educated person in the community. Nominally there was a school system under the supervision of the national and departmental governments, but its activities were limited to the larger towns, where there were public and private schools of all grades. There were universities in Bogotá and Medellín, the former having faculties

of letters and philosophy, jurisprudence and political science, medicine and natural sciences, and mathematics and engineering, with an attendance of 1200 to 1500 students. The war of 1899-1903 so completely disorganized this institution that only one faculty, medicine and natural sciences, was open in 1907. There were also a number of private schools in the larger towns, usually maintained by religious organizations. The reform programme of President Reyes included a complete reorganization of public instruction, to which it is proposed to add normal schools for the training of teachers, and agricultural and technical schools for the better development of the country's material resources. The supreme direction of this branch of the public service is entrusted to the minister of public instruction, and state aid is to be extended to the secondary, as well as to the normal, technical and professional schools. The secondary schools receiving public aid, however, have been placed in charge of religious corporations of the Roman Catholic Church. The expenditure on account of public instruction, which includes schools of all grades and descriptions, is unavoidably small, the appropriation for the biennium 1905-1906 being only £167,583. The school and college attendance for 1906, according to the president's review of that year, aggregated 218,941, of whom 50,691 were in Antioquia, where the whites are more numerous than in any other department; 4916 in Atlántico, which includes the city of Barranquilla, and in which the negro element preponderates; and only 12,793 in the federal district and city of Bogotá where the *mestizo* element is numerous. Although primary instruction is gratuitous it is not compulsory, and these figures clearly demonstrate that school privileges have not been extended much beyond the larger towns. The total attendance, however, compares well with that of 1897, which was 143,096, although it shows that only 5 % of the population, approximately, is receiving instruction.

Religion.—The religious profession of the Colombian people is Roman Catholic, and is recognized as such by the constitution, but the exercise is permitted of any other form of worship which is not contrary to Christian morals or to the law. There is one Protestant church in Bogotá, but the number of non-Catholics is small and composed of foreign residents. There has been a long struggle between liberals and churchmen in Colombia, and at one time the latter completely lost their political influence over the government, but the common people remained loyal to the Church, and the upper classes found it impossible to sever the ties which bound them to it. The constitution of 1861 disestablished the Church, confiscated a large part of its property, and disfranchised the clergy, but in 1886 political rights were restored to the latter and the Roman Catholic religion was declared to be the faith of the nation. The rulers of the Church have learned by experience, however, that they can succeed best by avoiding partisan conflicts, and the archbishop of Bogotá gave effect to this in 1874 by issuing an edict instructing priests not to interfere in politics. The Church influence with all classes is practically supreme and unquestioned, and it still exercises complete control in matters of education. The Colombian hierarchy consists of an archbishop, residing at Bogotá, 10 bishops, 8 vicars-general, and 2170 priests. There were also in 1905 about 750 members of 10 monastic and religious orders. There were 270 churches and 312 chapels in the republic. Each diocese has its own seminary for the training of priests.

Finance.—In financial matters Colombia is known abroad chiefly through repeated defaults in meeting her bonded indebtedness, and through the extraordinary depreciation of her paper currency. The public revenues are derived from import duties on foreign merchandise, from export duties on national produce, from internal taxes and royalties on liquors, cigarettes and tobacco, matches, hides and salt, from rentals of state emerald mines and pearl fisheries, from stamped paper, from port dues and from postal and telegraph charges. The receipts and expenditure are estimated for biennial periods, but it has not been customary to publish detailed results. Civil wars have of course been a serious obstacle, but it was announced by President Reyes in 1907 that the revenues were increasing. For the two years 1905 and 1906 the revenues were estimated to produce (at \$5 to the £1 sterling) £4,203,823, the expenditures being fixed at the same amount. The expenditures, however, did not include a charge of £424,000, chiefly due on account of war claims and requisitions. During the first year of this period the actual receipts, according to the council of the corporation of foreign bondholders, were \$9,149,591 gold (£1,829,918) and the payments \$7,033,317 gold (£1,406,663). It was expected by the government that the 1906 revenues would largely exceed 1905, but the expectation was not fully realized, chiefly, it may be assumed, because of the inability of an impoverished people to meet an increase in taxation. An instance of this occurred in the promising export of live cattle to Cuba and Panama, which was completely suppressed in 1906 because of a new export tax of \$3 gold per head. Of the expenditures about one-fourth is on account of the war department.

The foreign debt, according to the 1896 arrangement with the bondholders which was renewed in 1905, is £2,700,000, together with unpaid interest since 1896 amounting to £351,000 more. Under the 1905 arrangement the government undertook to pay the first coupons at 2½ %, and succeeding ones at 3 %, pledging 12 to 15 % of the customs receipts as security. The first payments were made according to agreement, and it was believed in 1907 that the

succeeding ones, together with one-half of the unpaid interest since 1896, would also be met. It is worthy of note that this debt, principal and accumulated interest, exceeded six and a half millions sterling in 1873, and that the bondholders surrendered about 60% of the claim in the hope of securing the payment of the balance. It is also worthy of note that Panama refused to assume any part of this debt without a formal recognition of her independence by Colombia, and even then only a sum proportionate to her population. The internal debt of Colombia in June 1906 was as follows:—

Consolidated	5,476,887	dollars silver,
Floating	2,345,658	„ gold.

Whether or not this included the unpaid war claims was not stated.

Money.—The monetary system, which has been greatly complicated by the use of two depreciated currencies, silver and paper, has been undergoing a radical reform since 1905, the government proposing to redeem the depreciated paper and establish a new uniform currency on a gold basis. The paper circulation in 1905 exceeded 700,000,000 pesos. The issue began in 1881 through the Banco Nacional de Colombia, its value then being equal to that of the silver coinage. Political troubles in 1884–1885 led to a suspension of cash payments in 1885, and in 1886 Congress made the notes inconvertible and of forced circulation. In 1894 the Banco Nacional ceased to exist as a corporation, and thenceforward the currency was issued for account of the national treasury. On October 16, 1899—the outstanding circulation then amounting to 46,000,000 pesos,—the government decreed an unlimited issue to meet its expenditures in suppressing the revolution, and later on the departments of Antioquia, Bolívar, Cauca, and Santander were authorized to issue paper money for themselves. This suicidal policy continued until February 28, 1903, when, according to an official statement, the outstanding paper circulation was:—

	Pesos.
National government issues.	600,398,581
Department of Antioquia	35,938,495·60
„ „ Bolívar	18,702,100
„ „ Cauca	44,719,688·70
„ „ Santander	750,000
	<hr/>
	700,598,865·30

So great was the depreciation of this currency that before the end of the war 100 American gold dollars were quoted at 22,500 pesos. The declaration of peace brought the exchange rate down to the neighbourhood of 10,000, where it remained, with the exception of a short period during the Panama Canal negotiations, when it fell to 6000. This depreciation (10,000) was equivalent to a loss of 99% of the nominal value of the currency, a paper peso of 100 centavos being worth only one centavo gold. International commercial transactions were based on the American gold dollar, which was usually worth 100 pesos of this depreciated currency. Even at this valuation, the recognized outstanding circulation (for there had been fraudulent issues as well) amounted to more than £1,400,000. In 1903 Congress adopted a gold dollar of 1·672 grammes weight ·900 fine (equal to the U.S. gold dollar) as the monetary standard created a redemption bureau for the withdrawal of the paper circulation, prohibited the further issue of such currency, and authorized free contracts in any currency. Previous to that time the law required all contracts to specify payments in paper currency. Certain rents and taxes were set aside for the use of the redemption bureau, and a nominally large sum has been withdrawn from circulation through this channel. On the 1st of January 1906, another monetary act came into operation, with additional provisions for currency redemption and improvement of the monetary system. A supplementary act of 1906 also created a new national banking institution, called the Banco Central, which is made a depository of the public revenues and is charged with a considerable part of their administration, including payments on account of the foreign debt and the conversion of the paper currency into coin. The new law likewise reaffirmed the adoption of a gold dollar of 1·672 grammes ·900 fine as the unit of the new coinage, which is:—

Gold:—	
Double condor	= 20 dollars.
Condor	= 10 „
Half condor	= 5 „
Dollar (mon. unit)	= 100 cents.
Silver:—	
Half dollar	= 50 cents.
Peseta	= 20 „
Real	= 10 „
Nickel:— 5 cents.	
Bronze:— 2 cents and 1 cent.	

The silver coinage (·900 fine) is limited to 10%, and the nickel and bronze coins to 2% of the gold coinage. The new customs tariff, which came into force at the same time, was an increase of 70% on the rates of 1904, and provided that the duties should be paid in gold, or in paper at the current rate of exchange. This measure was designed to facilitate the general resumption of specie payments.

Weights and Measures.—The metric system of weights and measures has been the legal standard in Colombia since 1857, but its use is confined almost exclusively to international trade. In the

interior and in all domestic transactions the old Spanish weights and measures are still used—including the Spanish *libra* of 1·102 lb avoirdupois, the *arroba* of 25 *libras* (12½ kilogrammes), the quintal of 100 *libras* (50 kilog.), the *carga* of 250 *libras* (125 kilogs.), the *vara* of 80 centimetres, and the *fanega*. The litre is the standard liquid measure. (A. J. L.)

HISTORY

The coast of Colombia was one of the first parts of the American continent visited by the Spanish navigators. Alonso de Ojeda touched at several points in 1499 and 1501; and Columbus himself visited Veragua, Portobello, and other places in his last voyage in 1502. In 1508 Ojeda obtained from the Spanish crown a grant of the district from Cape Vela westward to the Gulf of Darien, while the rest of the country from the Gulf of Darien to Cape Gracias-a-Dios was bestowed on his fellow-adventurer, Nicuessa. The two territories designated respectively Nueva Andalucia and Castella de Oro were united in 1514 into the province of Tierra-firma, and entrusted to Pedro Arias de Avila. In 1536–1537 an expedition under Gonzalo Jimenez de Quesada made their way from Santa Marta inland by the river Magdalena, and penetrated to Bogotá, the capital of the Muisca or Chibchas. Quesada gave to the country the name of New Granada.

By the middle of the century the Spanish power was fairly established, and flourishing communities arose along the coasts, and in the table-lands of Cundinamarca formerly occupied by the Muisca. For the better government of the colony the Spanish monarch erected a presidency of New Granada in 1564, which continued till 1718, when it was raised to the rank of a viceroyalty. In the following year, however, the second viceroy, D. Jorge Villalonga, Count de la Cueva, expressing his opinion that the maintenance of this dignity was too great a burden on the settlers, the viceroyalty gave place to a simple presidency. In 1740 it was restored, and it continued as long as the Spanish authority, including within its limits not only the present Colombia, but also Venezuela and Ecuador. An insurrection against the home government was formally commenced in 1811, and an incessant war against the Spanish forces was waged till 1824.

In 1819 the great national hero, Bolivar (*q.v.*), effected a union between the three divisions of the country, to which was given the title of the Republic of Colombia; but in 1829 Venezuela withdrew, and in 1830, the year of Bolivar's death, Quito or Ecuador followed her example. The Republic of New Granada was founded on the 21st of November 1831; and in 1832 a constitution was promulgated, and the territory divided into eighteen provinces, each of which was to have control of its local affairs. The president was to hold office for four years, and the first on whom the dignity was bestowed was General Francisco de Paula Santander. His position, however, was far from enviable; for the country was full of all the elements of unrest and contention. One of his measures, by which New Granada became responsible for the half of the debts of the defunct republic of Colombia, gave serious offence to a large party, and he was consequently succeeded not, as he desired, by José Maria Obando, but by a member of the opposition, José Ignacio de Marquez. This gave rise to a civil war, which lasted till 1841, and not only left the country weak and miserable, but afforded an evil precedent which has since been too frequently followed. The contest terminated in favour of Marquez, and he was succeeded in May 1841 by Pedro Alcantara Herran, who had assisted to obtain the victory. In 1840 the province of Cartagena had seceded, and the new president had hardly taken office before Panama and Veragua also declared themselves independent, under the title of the State of the Isthmus of Panama. Their restoration was, however, soon effected; the constitution was reformed in 1843; education was fostered, and a treaty concluded with the English creditors of the republic. Further progress was made under General Tomas de Mosquera from 1845 to 1848; a large part of the domestic debt was cleared off, immigration was encouraged, and free trade permitted in gold and tobacco. The petty war with Ecuador, concluded by the peace of Santa Rosa de Carchi, is hardly worthy of mention. From 1849 to 1852 the reins were

in the hands of General José Hilario Lopez, a member of the democratic party, and under him various changes were effected of a liberal tendency. In January 1852 slavery was entirely abolished. The next president was José María Obando, but his term of office had to be completed by vice-presidents Obaldía and Mallarino.

In 1853 an important alteration of the constitution took place, by which the right was granted to every province to declare itself independent, and to enter into merely federal connexion with the central republic, which was now known as the Granadine Confederation. In 1856 and 1857 Antioquia and Panama took advantage of the permission. The Conservative party carried their candidate in 1857, Mariano Ospino, a lawyer by profession; but an insurrection broke out in 1859, which was fostered by the ex-president Mosquera, and finally took the form of a regular civil war. Bogotá was captured by the democrats in July 1861, and Mosquera assumed the chief power. A congress at Bogotá established a republic, with the name of the United States of Colombia, adopted a new federal constitution, and made Mosquera dictator. Meanwhile the opposite party was victorious in the west; and their leader, Julio Arboleda, formed an alliance with Don García Moreno, the president of Ecuador. He was assassinated, however, in 1862, and his successor, Leonardo Canal, came to terms with Mosquera at Cali. The dictatorship was resigned into the hands of a convention (February 1863) at Rio Negro, in Antioquia; a provisional government was appointed, a constitution was drawn up, and Mosquera elected president till 1864. An unsuccessful attempt was also made to restore the union between the three republics of the former federation. The presidency of Manuel Murillo Toro (1864-1866) was disturbed by various rebellions, and even Mosquera, who next came to the helm, found matters in such a disorganized condition that he offered to retire. On the refusal of his resignation, he entered into a struggle with the majority in the congress, and ultimately resorted to an adjournment and the unconstitutional arrest of 68 of the senators and representatives. To the decree of impeachment published by the congress he replied by a notice of dissolution and a declaration of war; but he soon found that the real power was with his opponents, who effected his arrest, and condemned him first to two years' imprisonment, but afterwards by commutation to two years' exile. The presidency of Santos Gutiérrez (1868-1870) was disturbed by insurrections in different parts of the republic, the most important of which was that in Panama, where the most absolute disorganization prevailed. Under his successor, General E. Salgar, a Liberal candidate elected in opposition to General Herrán, a treaty was finally concluded with the United States in connexion with an interoceanic canal, a bank was established at Bogotá, and educational reforms instituted. Manuel Murillo Toro (1872-1874) and Santiago Pérez (1874-1876) saw the country apparently acquiring constitutional equilibrium, and turning its energies to the development of its matchless resources.

The election for the presidential term 1876-1878 resulted in favour of Aquiles Parra, who was succeeded in April 1878 by General Julian Trujillo. His administration was marked by a strong effort to place the financial position of the government on a more satisfactory footing, and the internal indebtedness was substantially reduced during his rule. In April 1880 Señor Rafael Nuñez acceded to the presidency. During his term of office revolutionary disturbances occurred in the provinces of Cauca and Antioquia, but were suppressed with no great difficulty. Provision was made in 1880 for a settlement of the boundary dispute with Costa Rica, and in July of that year the federal Congress authorized the formation of a naval squadron. A movement was now set afoot in favour of a confederation of the three republics of Colombia, Ecuador and Venezuela on the basis of the original conditions existing after the expulsion of Spanish authority, and a resolution was passed by the chamber of deputies to that effect. The opposition shown by Venezuela and Ecuador to this project prevented any definite result from being achieved. In April 1882 Señor Francisco J. Laldúa became president, but his death occurring a year later, General José

Eusebio Otalora was nominated to exercise the executive power for the unexpired portion of the term. In 1883 the dispute in connexion with the boundary between Colombia and Venezuela was submitted by the two governments to the arbitration of Alphonso XII., king of Spain, and a commission of five members was appointed to investigate the merits of the respective claims. The decision in this dispute was finally given by the queen regent of Spain on the 16th of March 1891. In April 1884 Señor Rafael Nuñez was again proclaimed president of the republic in his absence abroad. Pending his return the administration was left in the hands of General Campo Serrano and General Elisco Payán. The Liberal party had been instrumental in the re-election of Nuñez, and looked for a policy in conformity with their views and political convictions. President Nuñez had no sooner returned to Colombia than the Liberals discovered that his political opinions had changed and had become strongly Conservative. Discontent at this condition of affairs soon spread. Nuñez from motives of ill-health did not openly assume the presidential office, but from his house near Cartagena he practically directed the government of the republic. The Liberals now began to foment a series of revolutionary movements, and these led in 1885 to a civil war extending over the departments of Boyacá, Cundinamarca, Magdalena and Panama. General Reyes and General Velez were the two principal leaders of the revolt. In order to protect the passage of the traffic across the Isthmus of Panama during these disturbed times detachments of United States marines were landed at Panama and Colon, in accordance with the terms of the concession under which the railway had been constructed. After a number of defeats the leaders of the revolt surrendered in August 1885, and on the 5th of September following peace was officially proclaimed. Nuñez, who had meanwhile assumed the presidential duties, now brought about a movement in favour of a fresh Act of Constitution for Colombia, and a new law to that effect was finally approved and promulgated on 4th August 1886. Under the terms of this act the federal system of government for Colombia was abolished, the states becoming departments, the governors of these political divisions being appointed by the president of the republic. Each department has a local legislative assembly elected by the people. The national congress is constituted of the Senate and the House of Representatives. The Senate is composed of twenty-seven members elected for six years, one-third retiring every two years, three of whom are nominated by each of the nine departments. The House of Representatives comprises members elected for four years by universal suffrage, each department forming a constituency and returning one member for every 50,000 inhabitants. Congress convenes every two years. The presidential term of office under the new act was fixed at six years in place of the two years formerly prevailing. The judiciary was irremovable, and trial by jury was allowed for criminal offences. Capital punishment was re-established, and the press was made responsible for matter published. The unlicensed trade in arms and ammunition thitherto existing was prohibited. Previous to 1886 the crime of murder was only punishable by 10 years' imprisonment, a sentence which in practice was reduced to two-thirds of that term; slander and libel were formerly offences which the law had no power to restrain, and no responsibility attached to seditious publications.

After the promulgation of this new Act of Constitution President Nuñez was proclaimed as president of the republic for the term ending in 1892. He was unable, however, in consequence of ill-health, to reside at Bogotá and discharge the presidential duties, and consequently in August 1888 Señor Carlos Holguín was designated to act for him. In 1892 President Nuñez was again elected to the presidency for a term of six years, his continued ill-health, however, forcing him to place the active performance of his duties in the hands of the vice-president, Señor Miguel Caro. In 1895 the Liberals made another attempt to seize the government of the country, but the movement was suppressed without any very great difficulty. In this same year Nuñez died, and Vice-President Caro became the actual president,

an office he had practically filled during the three previous years. In 1898 Señor M. A. Sanclemente, a strong Conservative, and supported by the Church party, was elected to the presidency for the period ending in 1904. In October 1899 the Liberals organized another revolutionary outbreak for the purpose of trying to wrest the power from Conservatives, but this attempt had no better success than the movements of 1885 and 1895. In January 1900, however, Vice-President José Marroquin seized upon the government, imprisoned President Sanclemente (who died in prison in March 1902), and another period of disturbance began. The rebels were defeated in May in a desperate battle at Cartagena, and continuous fighting went on about Panama, where British marines had to be landed to protect foreign interests. As the year 1900 advanced, the conflict went on with varying success, but the government troops were generally victorious, and in August Vice-President Marroquin was recognized as the acting head of the executive, with a cabinet under General Calderon. In 1901 the rebellion continued, and severe fighting took place about Colon. Further complications arose in August, when trouble occurred between Colombia and Venezuela. On the one hand, there were grounds for believing that the Clericals and Conservatives in both countries were acting together; and, on the other, it was expected that President Castro of Venezuela would not be sorry to unite his own countrymen, and to divert their attention from internal affairs, by a war against Colombia. The Colombian revolutionary leaders had made use of the Venezuelan frontier as a base of operations, and the result was an invasion of Venezuelan territory by Colombian government troops, an incident which at once caused a diplomatic quarrel. The United States government in September offered its good offices, but President Castro refused them, and the state of affairs became gradually more menacing. Meanwhile both Panama and Colon were seriously threatened by the rebel forces, who in November succeeded in capturing Colon by surprise. The situation was complicated by the fact that the railway traffic on the Isthmus was in danger of interruption, and on the capture of Colon it became necessary for the American, British and French naval authorities to land men for the protection of the railway and of foreign interests.

On the 18th of September the Venezuelans, who had entered Colombia, were totally routed near La Hacha, and after fierce fighting the insurgents at Colon were compelled to surrender on the 29th of November. But the Civil War was not yet ended. For another eight months it was to continue, causing immense damage to property and trade, and the loss of tens of thousands of lives. In many towns and villages the male population was almost entirely destroyed. Not till June 1903 was internal peace finally restored. In the autumn of that same year Colombia, exhausted and half ruined, was to suffer a further severe loss in the secession of Panama.

The abrogation of the Clayton-Bulwer treaty in 1901, and the failure of the second French company to construct a canal between Colon and Panama (see PANAMA CANAL) had, after many hesitations, induced the United States government to abandon the Nicaragua route and decide on adopting that of Panama. Negotiations were set on foot with Colombia, and an arrangement—under what was known as the Hay-Herran treaty—was made to the following effect. Colombia agreed (1) to the transfer of the rights, under the concession, of the French company to the United States; (2) to cede, on a hundred years' lease, a right of way for the canal, and a strip of land 5 m. broad on either side of the waterway, and the two ports of Colon and Panama. The United States agreed to pay Colombia (1) £2,000,000 down in cash, and, ten years later, an annual rental of £50,000, and further a share of the price paid to the French company, *i.e.* £8,000,000, in which Colombia held 50,000 shares. This treaty was signed by the plenipotentiaries and ratified by the United States Senate. The Colombian Congress, however, refused to ratify the treaty on the ground that when the negotiations had taken place the country was in a state of siege, really in the hope of securing a larger money payment. The adjournment took place on the 31st of October. On the 3rd of November a revolution broke out at

Panama, and the state seceded from Colombia and declared itself to be an independent republic. This opportune revolution was no doubt fomented by persons interested in the carrying through of the United States scheme for piercing the isthmus, but their task was one that presented no difficulties, for the isthmian population had been in a state of perennial insurrection against the central government for many years. Whoever may have instigated the rising, this much is certain, that American warships prevented the Colombian troops from landing to suppress the revolt. On the 7th of November the United States government formally recognized the independence of the republic of Panama (*q.v.*). The other powers in succession likewise recognized the new state; the recognition of Great Britain was given on the 26th of December. Colombia thus sacrificed a great opportunity of obtaining, by the ratification of the Hay-Herran treaty, such a pecuniary recompense for the interest in the territory through which the canal was to be constructed as would have gone far to re-establish her ruined financial credit.

In 1904 the troubled term of President Marroquin came to an end, and by the narrowest of majorities General Rafael Reyes was elected in his place. He had been sent as a special envoy to Washington to protest against the recognition of Panama, and to attempt to revive the Hay-Herran treaty, and to secure favourable terms for Colombia in the matter of the canal. He failed to do so, but it was recognized that he had discharged his difficult task with great skill and ability. On his accession to office as president he found the country exhausted and disorganized, more especially in the department of finance, and the congress was on the whole hostile to him. Finding himself hampered in his efforts to reform abuses, the president dissolved the congress, and summoned a national constituent and legislative assembly to meet on the 15th of March 1905, and with its aid proceeded to modify the constitution.

Having personal acquaintance with the success of the rule of President Porfirio Diaz in Mexico, General Reyes determined to set about the regeneration of Colombia by similar methods. His tenure of the presidency was extended to a term of ten years from the 1st of January 1905, and the restriction as to re-election at the end of that term was withdrawn, other alterations being made in the constitution with the effect of placing General Reyes really in the position of a dictator. He soon proved that he had the ability and the integrity of purpose to use his great opportunity for the benefit of his country. His firm and masterful government and wise measures did much to allay the spirit of unrest which had so long been the bane of Colombia, and though an attempt at assassination was made in the spring of 1906, the era of revolution appeared to be over.

The chief foreign treaties entered into by Colombia in the last quarter of the 19th century were:—(1) A treaty with Great Britain, signed on the 27th of October 1888, for the extradition of criminals; (2) a treaty of friendship, commerce and navigation with Italy, signed on the 27th of October 1892; (3) two protocols with Italy, signed respectively on the 24th of May and on the 25th of August 1886, in connexion with the affair of the Italian subject Cerruti; (4) a consular convention with Holland, signed on the 20th of July 1881; (5) a treaty of peace and friendship with Spain, signed on the 30th of January 1881; (6) a convention with Spain for the reciprocal protection of intellectual property; (7) a concordat with the Vatican, signed on the 31st of December 1887; (8) an agreement with the Vatican, signed on the 20th of August 1892, in connexion with ecclesiastical jurisdiction; (9) an agreement with the republic of San Salvador, signed on the 24th of December 1880, in regard to the despatch of a delegate to an international congress; (10) a treaty of peace, friendship and commerce with Germany, signed on the 23rd of July 1892; (11) a treaty with the republic of Costa Rica, signed in 1880, for the delimitation of the boundary; (12) the postal convention, signed at Washington, on the 4th of July 1891; (13) a convention with Great Britain, signed on the 31st of July 1896, in connexion with the claim of Messrs Punchard, M^{rs} Taggart, Lowther & Co.; (14) a treaty of friendship, commerce and navigation with Peru, signed on the 6th of August

1898; (15) an extradition treaty with Peru, signed on the 6th of August 1898; (16) a treaty of peace, friendship and defensive alliance with Venezuela, signed on the 21st of November 1896, and on the same date a treaty regulating the frontier commerce. (G. E.)

AUTHORITIES.—C. E. Akers, *A History of South America, 1854-1904* (New York, 1905); J. J. Borda, *Compendio de historia de Colombia* (Bogotá, 1890); Salvador Roldan Camacho, *Notas de viaje* (Bogotá, 1890), and *Escritos varios* (Bogotá, 1892); Dr Alfred Heppner, *Reisen in den colombianischen Anden* (Leipzig, 1888); Angel Lemos, *Compendio de geografia de la República de Colombia* (Medellin, 1894); Albert Millican, *Travels and Adventures of an Orchid Hunter* (London, 1891); J. M. Cordovez Mauro, *Reminiscencias Santafé y Bogotá* (Bogotá, 1899); Norris and Laird (Bureau of Navigation), *Telegraphic Determination of Longitudes in Mexico, Central America, the West Indies, and on the North Coast of South America* (Washington, 1891); R. Nuñez and H. Jalhay, *La République de Colombia, géographie, histoire, &c.* (Bruxelles, 1893); J. M. Q. Otero, *Historia Patria* (Bogotá, 1891); Lisimaco Palau, *La República de Colombia* (1893); M. Paz and F. Perez, *Atlas geográfico e histórico de la República de Colombia* (1893); R. S. Pereira, *Les États Unis de Colombia* (Paris, 1883); Felipe Perez, *Geografía general, física y política de los Estados Unidos de Colombia* (Bogotá, 1883); F. Loraine Petrie, *The Republic of Colombia* (London, 1906); Elisée Réclus, *Geografía de Colombia* (Bogotá, 1893); W. Reiss and A. Stübel, *Reisen in Sudamerika. Geologische Studien in der Republik Colombia* (Berlin, 1893); Ernesto Restrepo, *Ensayo etnográfico y arqueológico de la provincia de los Quimbayas* (Bogotá, 1892), and *Estudios sobre los aborígenes de Colombia* (Bogotá, 1892); Vicente Restrepo, *Estudio sobre las minas de oro y plata de Colombia* (Bogotá, 1888, translated by C. W. Fisher, New York, 1886); W. L. Scruggs, *The Colombian and Venezuelan Republics* (London, 1899; Boston, 1900); W. Sievers, *Reisen in der Sierra Nevada de Santa Marta* (Leipzig, 1887); F. J. Vergara y Velasco, *Nueva geografía de Colombia* (Bogotá, 1892); Frank Vincent, *Around and About South America* (New York, 1890); R. G. Watson, *Spanish and Portuguese South America during the Colonial Period* (2 vols., London, 1884).

See also the diplomatic and consular reports of Great Britain and the United States; publications of the International Bureau of American Republics (Washington, D.C.); Bureau of Statistics, *Commercial America in 1905* (Washington, 1906).

COLOMBIER, PIERRE BERTRAND DE (1299-1361), French cardinal and diplomatist, was born at Colombier in Ardèche. He was nephew and namesake of Cardinal Pierre Bertrand of Annonay. After a careful juristic education he was successively advocate at the parlement of Paris, intendant of the council of the count of Nevers (1321), and counsellor-clerk to the parlement (1329). Having taken holy orders, he became dean of St Quentin in 1330, and was employed to negotiate the marriage of the duke of Normandy, the future king John the Good of France, with the daughter of the king of Bohemia. In 1335 he became bishop of Nevers, in 1339 of Arras, and contributed to bring the county of Flanders into the kingdom of France. Created cardinal priest of St Susanna in 1344, he was employed by the pope on important missions, notably to negotiate peace or an armistice between France and England. Having become bishop of Ostia in 1353, he was sent next year to Charles IV. of Germany, and induced him to come to Italy to be crowned emperor at Rome, 1355. In 1356 he went to France to try to arrange a peace with England, and died in 1361 at the priory of Montaud near Avignon.

See A. Mazon, *Essai historique sur l'état du Vivarais pendant la guerre de cent ans* (Paris, 1889), with references there.

COLOMBO, the capital and principal seaport of Ceylon, situated on the west coast of the island. Pop. (1901) 154,691. Colombo stands to the south of the mouth of the river Kelani. The coast-land is here generally low-lying, but broken by slight eminences. The great artificial harbour, enclosed by breakwaters, is bounded on the south by a slight promontory. This is occupied by the quarter of the city known as the Fort, from the former existence of a fort founded by the Portuguese and reconstructed by the Dutch. In 1869 the governor, Sir Hercules Robinson (afterwards Lord Rosmead), obtained authority to demolish the fortifications, which were obsolete for purposes of defence, and required 6000 men to man them properly. The levelling of the walls and filling up of the moat made the Fort much more accessible and healthy, and since then it has become the business centre of the city. Here are situated Queen's

House, the governor's residence; the secretariat or government offices, and other government buildings, such as the fine general post office and the customs house. Here also are most of the principal hotels, which have a peculiarly high reputation among European hotels in the East. A lofty tower serves as the principal lighthouse of the port and also as a clock-tower. On the south side of the Fort are extensive barracks. The old banqueting-hall of the Dutch governors is used as the garrison church of St Peter.

To the north-east of the Fort, skirting the harbour, are the Pettah, the principal native quarter, the districts of Kotahena and Mutwall, and suburbs beyond. In this direction the principal buildings are the Wolfendahl church, a massive Doric building of the Dutch (1749); the splendid Roman Catholic cathedral of St Lucia (completed in 1904); and St Thomas's College (1851), which follows the lines of an English public school. Close to this last is the Anglican cathedral of Christ Church. The Kotahena temple is the chief Buddhist temple in Colombo.

To the north-east of the Fort is the Lake, a ramifying sheet of fresh water, which adds greatly to the beauty of the site of Colombo, its banks being clothed with luxuriant foliage and flowers. The narrow isthmus between this lake and the sea, south of the Fort, is called Galle Face, and is occupied chiefly by promenades and recreation grounds. The peninsula enclosed by two arms of the Lake is known as Slave Island, having been the site of a slave's prison under the Dutch. South-east of this is the principal residential quarter of Colombo, with the circular Victoria Park as its centre. To the east of the park a series of parallel roads, named after former British governors, are lined with beautiful bungalows embowered in trees. This locality is generally known as the Cinnamon Gardens, as it was formerly a Dutch reserve for the cultivation of the cinnamon bush, many of which are still growing here. In the park is the fine Colombo Museum, founded by Sir William Gregory; and near the neighbouring Campbell Park are the handsome buildings of a number of institutions, such as Wesley College, and the General, Victoria Memorial Eye and other hospitals. South of Victoria Park is the Havelock racecourse. Among educational establishments not hitherto mentioned are the Royal College, the principal government institution, the government technical college and St Joseph's Roman Catholic college. Most of the town is lighted by gas, and certain quarters with electric light; and electric tramways have been laid over several miles of the city roads. The water-supply is drawn from a hill region 30 m. distant.

Under British rule Colombo has shared in the prosperity brought to the island by the successive industries of coffee and tea-planting. At the height of the coffee-growing enterprise 20,000 men, women and children, chiefly Sinhalese and Tamils, found employment in the large factories and stores of the merchants scattered over the town, where the coffee was cleaned, prepared, sorted and packed for shipment. Tea, on the contrary, is prepared and packed on the estates; but there is a considerable amount of work still done in the Colombo stores in sorting, blending and repacking such teas as are sold at the local public sales; also in dealing with cacao, cardamoms, cinchona bark and the remnant still left of the coffee industry. But it is its position as one of the great ports of call of the East that Colombo owes its great and increasing importance. A magnificent breakwater, 4200 ft. long, the first stone of which was laid by the prince of Wales in 1875, was completed in 1884. This breakwater changed an open roadstead into a harbour completely sheltered on the most exposed or south-west side; but there was still liability in certain months to storms from the north-west and south-east. Two additional arms were therefore constructed, consisting of a north-east and north-west breakwater, leaving two openings, one 800 ft. and the other 700 ft. wide, between the various sections. The area enclosed is 660 acres. A first-class graving-dock, of which the Admiralty bore half the cost, has also been added. These improvements caused Galle to be abandoned as a port of call for steamers in favour of Colombo, while Trincomalee has been abandoned as a naval station. The port has assumed first-class importance, mail steamers calling

regularly as well as men-of-war and the mercantile marine of all nations; and it is now one of the finest artificial harbours in the world. The extension of railways also has concentrated the trade of the island upon the capital, and contributed to its rise in prosperity.

Colombo was originally known as the Kalantotta or Kalany ferry. By the Arabs the name was changed to Kolambu, and the town was mentioned by Ibn Batuta in 1346 as the largest and finest in Serendib. In 1517 the Portuguese effected a settlement, and in 1520 they fortified their port and bade defiance to the native besiegers. In 1586 the town was invested by Raja Singh, but without success. On its capture by the Dutch in 1636 it was a flourishing colony with convents of five religious orders, churches and public offices, inhabited by no fewer than 900 noble families and 1500 families dependent on mercantile or political occupations. In 1796 it was surrendered to the British.

COLON (formerly known as ASPINWALL), a city of the Republic of Panama, on the Atlantic coast, in the Bay of Limon, and 47 m. by rail N.W. of the city of Panama. Pop. (1908) about 3000, consisting largely of Jamaica negroes and natives of mixed Spanish, Indian and African descent. It is served by the Panama railway, which crosses the Isthmus of Panama from ocean to ocean. Colon has a deep, though poorly sheltered harbour, and is either the terminus or a place of call for seven lines of steamships. It thus serves as an entrepôt for much of the commerce between Atlantic and Pacific ports, and between the interior towns of Central and South America and the cities of Europe and the United States. The city lies on the west side of the low island of Manzanillo, is bordered on the landward sides by swamp, and consists mainly of unimposing frame houses and small shops. The most attractive parts are the American quarter, where the employes of the Panama railway have their homes, and the old French quarter, where dwelt the French officers during their efforts to build the canal. In this last district, near the mouth of the old canal, stands a fine statue of Christopher Columbus, the gift of the empress Eugénie in 1870. Here also stands the mansion erected and occupied by Ferdinand de Lesseps during his residence on the isthmus. With the exception of railway shops, there are no important industrial establishments.

Colon dates its origin from the year 1850, when the island of Manzanillo was selected as the Atlantic terminus of the Panama railway. The settlement was at first called Aspinwall, in honour of William H. Aspinwall (1807–1875), one of the builders of the railway; but some years afterwards its name was changed by legislative enactment to Colon, in honour of Christopher Columbus, who entered Limon Bay in 1502. The original name, however, survived among the English-speaking inhabitants for many years after this change. With the completion of the railway in 1855, the town supplanted Chagres (*q.v.*) as the principal Atlantic port of the isthmus. Later it acquired increased importance through its selection by de Lesseps as the site for the Atlantic entrance to his canal. During the revolution of 1885 it was partly burned and was rebuilt on a somewhat larger plan. As the city has always been notoriously unhealthy, the United States, on undertaking the construction of the Panama Canal (*q.v.*), became interested in preventing its becoming a centre of infection for the Canal Zone, and by the treaty of November 1903 secured complete jurisdiction in the city and harbour over all matters relating to sanitation and quarantine, and engaged to construct a system of waterworks and sewers in the municipality, which had been practically completed in 1907. The United States government has also opened a port at Cristobal, within the Canal Zone.

COLON, a town of Matanzas province, Cuba, on the railway between Matanzas and Santa Clara, and the centre of a rich sugar-planting country. Pop. (1907) 7124.

COLON. (1) (Gr. *κόλον*, miswritten and mispronounced as *κώλον*, the term being taken from *κόλος*, curtailed), in anatomy, that part of the greater intestine which extends from the caecum to the rectum (see ALIMENTARY CANAL). (2) (Gr. *κώλον*, a member or part), originally in Greek rhetoric a short clause

longer than the "comma," hence a mark (:), in punctuation, used to show a break in construction greater than that marked by the semicolon (;), and less than that marked by the period or full stop. The sign is also used in psalters and the like to mark off periods for chanting. The word is applied in palaeography to a unit of measure in MSS., amounting in length to a hexameter line.

COLONEL (derived either from Lat. *columna*, Fr. *colonne*, column, or Lat. *corona*, a crown), the superior officer of a regiment of infantry or cavalry; also an officer of corresponding rank in the general army list. The colonelcy of a regiment formerly implied a proprietary right in it. Whether the colonel commanded it directly in the field or not, he always superintended its finance and interior economy, and the emoluments of the office, in the 18th century, were often the only form of pay drawn by general officers. The general officers of the 17th and 18th centuries were invariably colonels of regiments, and in this case the active command was exercised by the lieutenant-colonels. At the present day, British general officers are often, though not always, given the colonelcy of a regiment, which has become almost purely an honorary office. The sovereign, foreign sovereigns, royal princes and others, hold honorary colonelcies, as colonels-in-chief or honorary colonels of many regiments. In other armies, the regiment being a fighting unit, the colonel is its active commander; in Great Britain the lieutenant-colonel commands in the field the battalion of infantry and the regiment of cavalry. Colonels are actively employed in the army at large in staff appointments, brigade commands, &c. extra-regimentally. Colonel-general, a rank formerly used in many armies, still survives in the German service, a colonel-general (*General-Oberst*) ranking between a general of infantry, cavalry or artillery, and a general field marshal (*General-Feldmarschall*). Colonels-general are usually given the honorary rank of general field marshal.

COLONIAL OFFICE, the department of the administration of the United Kingdom which deals with questions affecting the various colonial possessions of the British crown. The department as it now exists is of comparatively modern creation, dating only from 1854. The affairs of the English colonies began to assume importance at the Restoration, and were at first entrusted to a committee of the privy council, but afterwards transferred to a commission created by letters patent. From 1672 to 1675 the council for trade was combined with this commission, but in the latter year the colonies were again placed under the control of the privy council. This arrangement continued until 1695, when a Board of Trade and Plantations was created; its duty, however, was confined to collecting information and giving advice when required. The actual executive work was performed by the secretary of state for the southern department, who was assisted, from 1768 to 1782, by a secretary of state for the colonies. Both the Board of Trade and Plantations and the additional secretary were abolished in 1782, and the executive business wholly given over to the home office. In 1794 a third secretary of state was reappointed, and in 1801 this secretary was designated as secretary of state for war and the colonies. In 1854 the two offices were separated, and a distinct office of secretary of state for the colonies created.

The secretary of state for the colonies is the official medium of communication with colonial governments; he has certain administrative duties respecting crown colonies, and has a right of advising the veto of an act of a colonial legislature—this veto, however, is never exercised in the case of purely local statutes. He is assisted by a permanent and a parliamentary under-secretary and a considerable clerical staff.

As reorganized in 1907 the colonial office consists of three chief departments: (1) the Dominions Department, dealing with the affairs of the self-governing over-sea dominions of the British crown, and of certain other possessions geographically connected with those dominions; (2) the Colonial Department, dealing with the affairs of crown colonies and protectorates; (3) the General Department, dealing with legal, financial and other general business. In addition to these three departments;

standing committees exist to take a collective view of such matters as contracts, concessions, mineral and other leases, and patronage.

COLONNA, a noble Roman family, second only to the Gaetani di Sermoneta in antiquity, and first of all the Roman houses in importance. The popes Marcellinus, Sixtus III., Stephen IV. and Adrian III. are said to have been members of it, but the authentic pedigree of the family begins with Pietro, lord of Columna, Palestrina and Paliano (about 1100), probably a brother of Pope Benedict IX. His great grandson Giovanni had two sons, respectively the founders of the Colonna di Paliano and Colonna di Sciarra lines. The third, or Colonna-Romano line, is descended from Federigo Colonna (1223). In the 12th century we find the Colonna as counts of Tusculum, and the family was then famous as one of the most powerful and turbulent of the great Roman clans; its feuds with the Orsini and the Gaetani are a characteristic feature of medieval Rome and the Campagna; like the other great nobles of the Campagna the Colonna plundered travellers and cities, and did not even spare the pope himself if they felt themselves injured by him. Boniface VIII. attempted to break their power, excommunicated them in 1297, and confiscated their estates. He proclaimed a crusade against them and captured Palestrina, but they afterwards revenged themselves by besieging him at Anagni, and Sciarra Colonna laid violent hands on His Holiness, being with difficulty restrained from actually murdering him (1303). In 1347 the Colonna, at that time almost an independent power, were defeated by Cola di Rienzi, but soon recovered. Pope Martin V. (1417-1431) was a Colonna, and conferred immense estates on his family, including Marino, Frascati, Rocca di Papa, Nettuno, Palinao, &c., in the Campagna, and other fiefs in Romagna and Umbria. Their goods were frequently confiscated and frequently given back, and the house was subject to many changes of fortune; during the reign of Pope Alexander VI. they were again humbled, but they always remained powerful and important, and members of the family rose to eminence as generals, prelates and statesmen in the service of the Church or other powers. In the war of 1522 between France and Spain there were Colonna on both sides, and at the battle of Lepanto (1571) Marc Antonio Colonna, who commanded the papal contingent, greatly distinguished himself. A detailed record of the Colonna family would be a history of Rome. To-day there are three lines of Colonna: (1) Colonna di Paliano, with two branches, the princes and dukes of Paliano, and the princes of Stigliano; (2) Colonna di Sciarra, with two branches, Colonna di Sciarra, princes of Carbagnano, and Barberini-Colonna, princes of Palestrina; and (3) Colonna-Romano. The Colonna palace, one of the finest in Rome, was begun by Martin V. and contains a valuable picture and sculpture gallery.

.See A. von Reumont, *Geschichte der Stadt Rom* (Berlin, 1868), containing an elaborate account of the family; F. Gregorovius, *Geschichte der Stadt Rom* (Stuttgart, 1872); *Almanach de Gotha*. (L. V.*)

COLONNA, GIOVANNI PAOLO (circa 1637-1695), Italian musician, was born in Bologna about 1637 and died in the same city on the 28th of November 1695. He was a pupil of Filippuzzi in Bologna, and of Abbatini and Benevoli in Rome, where for a time he held the post of organist at S. Apollinare. A dated poem in praise of his music shows that he began to distinguish himself as a composer in 1659. In that year he was chosen organist at S. Petronio in Bologna, where on the 1st of November 1674 he was made chapel-master. He also became president of the Philharmonic Academy of Bologna. Most of Colonna's works are for the church, including settings of the psalms for three, four, five and eight voices, and several masses and motets. He also composed an opera, under the title *Amilcare*, and an oratorio, *La Profecia d' Eliseo*. The emperor Leopold I. received a copy of every composition of Colonna, so that the imperial library in Vienna possesses upwards of 83 church compositions by him. Colonna's style is for the most part dignified, but is not free from the inequalities of style and taste almost unavoidable at a period when church music

was in a state of transition, and had hardly learnt to combine the gravity of the old style with the brilliance of the new.

COLONNA, VITTORIA (1490-1547), marchioness of Pescara, Italian poet, daughter of Fabrizio Colonna, grand constable of the kingdom of Naples, and of Anna da Montefeltro, was born at Marino, a fief of the Colonna family. Betrothed when four years old at the instance of Ferdinand, king of Naples, to Ferrante de Avalos, son of the marquis of Pescara, she received the highest education and gave early proof of a love of letters. Her hand was sought by many suitors, including the dukes of Savoy and Braganza, but at nineteen, by her own ardent desire, she was married to de Avalos on the island of Ischia. There the couple resided until 1511, when her husband offered his sword to the League against the French. He was taken prisoner at the battle of Ravenna (1512) and conveyed to France. During the months of detention and the long years of campaigning which followed, Vittoria and Ferrante corresponded in the most passionate terms both in prose and verse. They saw each other but seldom, for Ferrante was one of the most active and brilliant captains of Charles V.; but Vittoria's influence was sufficient to keep him from joining the projected league against the emperor after the battle of Pavia (1525), and to make him refuse the crown of Naples offered to him as the price of his treason. In the month of November of the same year he died of his wounds at Milan. Vittoria, who was hastening to tend him, received the news of his death at Viterbo; she halted and turned off to Rome, and after a brief stay departed for Ischia, where she remained for several years. She refused several suitors, and began to produce those *Rime spirituali* which form so distinct a feature in her works. In 1529 she returned to Rome, and spent the next few years between that city, Orvieto, Ischia and other places. In 1537 we find her at Ferrara, where she made many friends and helped to establish a Capuchin monastery at the instance of the reforming monk Bernardino Ochino, who afterwards became a Protestant. In 1539 she was back in Rome, where, besides winning the esteem of Cardinals Reginald Pole and Contarini, she became the object of a passionate friendship on the part of Michelangelo, then in his sixty-fourth year. The great artist addressed some of his finest sonnets to her, made drawings for her, and spent long hours in her society. Her removal to Orvieto and Viterbo in 1541, on the occasion of her brother Ascanio Colonna's revolt against Paul III., produced no change in their relations, and they continued to visit and correspond as before. She returned to Rome in 1544, staying as usual at the convent of San Silvestro, and died there on the 25th of February 1547.

Cardinal Bembo, Luigi Alamanni and Baldassare Castiglione were among her literary friends. She was also on intimate terms with many of the Italian Protestants, such as Pietro Carneseccchi, Juan de Valdes and Ochino, but she died before the church crisis in Italy became acute, and, although she was an advocate of religious reform, there is no reason to believe that she herself became a Protestant. Her life was a beautiful one, and goes far to counteract the impression of the universal corruption of the Italian Renaissance conveyed by such careers as those of the Borgia. Her amatory and elegiac poems, which are the fruits of a sympathetic and dainty imitative gift rather than of any strong original talent, were printed at Parma in 1538; a third edition, containing sixteen of her *Rime Spirituali*, in which religious themes are treated in Italian, was published at Florence soon afterwards; and a fourth, including a still larger proportion of the pious element, was issued at Venice in 1544.

A great deal has been written about Vittoria Colonna, but perhaps the best account of her life is A. Luzio's *Vittoria Colonna* (Modena, 1885); A. von Reumont's *Vita di Vittoria Colonna* (Italian corrected edit., Turin, 1883) is also excellent; F. le Fèvre's *Vittoria Colonna* (Paris, 1856) is somewhat inaccurate, but T. Roscoe's *Vittoria Colonna* (London, 1868) may be recommended to English readers; P. E. Visconti's *Le Rime di Vittoria Colonna* (Rome, 1846) deals with her poems. (L. V.*)

COLONNADE, in architecture, a range of columns (Ital. *colonna*) in a row. When extended so as to enclose a temple,

it is called a peristyle, and the same term applies when round an open court, as in the houses at Pompeii. When projecting in front of a building, it is called a portico, as in the Pantheon at Rome and the National Gallery in London. When enclosed between wings, as in Perrault's façade to the Louvre, it is correctly described as a colonnade. Colonnades lined the streets of the towns in Syria and Asia Minor, and they were largely employed in Rome.

COLONSAY, an island of the Inner Hebrides, Argyllshire, Scotland, 10 m. S. of the Ross of Mull. It is $7\frac{1}{2}$ m. long by 3 m. broad. The highest point is Carnan Eoin (470 ft.). Towards the middle of the island lies Loch Fada, nearly 2 m. long but very narrow, and there are two other small lakes and a few streams. The coast-line, with frequent beautiful sandy reaches, is much indented, the chief bays being Kiloran, Kilchattan and Staosunaig. On the north-western coast the cliffs are particularly fine. To the south, separated by a strait that is fordable at low water, lies the isle of ORONSAY, $2\frac{1}{4}$ m. long by $2\frac{3}{4}$ m. wide. Both islands contain a number of ecclesiastical remains, standing stones, and some beautiful sculptured crosses. They are named after Columba and Oran, who are said to have stopped here after they left Ireland. There is regular communication between Scalasaig and Glasgow and the Clyde ports. The golf-course at Kilchattan lends a touch of modernity to these remote islands. Near Scalasaig a granite obelisk has been erected to the memory of Sir Duncan M'Neill (1794-1874), a distinguished Scottish lawyer, who took the title of Lord Colonsay when he became a lord of appeal. The soil of both islands is fertile, potatoes and barley being raised and cattle pastured. Population: Colonsay (1901), 301; Oronsay (1901), 12.

COLONY (Lat. *colonia*, from *colonus*, a cultivator), a term most commonly used to denote a settlement of the subjects of a sovereign state in lands beyond its boundaries, owning no allegiance to any foreign power, and retaining a greater or less degree of dependence on the mother country. The founding and the growth of such communities furnish matter for an interesting chapter in the history as well of ancient as of modern civilization; and the regulation of the relations between the parent state and its dependencies abroad gives rise to important problems alike in national policy and in international economics.

It was mainly the spirit of commercial enterprise that led the Phoenicians to plant their colonies upon the islands and along the southern coast of the Mediterranean; and even beyond the Pillars of Hercules this earliest great colonizing race left enduring traces of its maritime supremacy. Carthage, indeed, chief of the Phoenician settlements, sent forth colonies to defend her conquests and strengthen her military power; and these sub-colonies naturally remained in strict subjection to her power, whereas the other young Phoenician states assumed and asserted entire independence.

In this latter respect the Greek colonies resembled those of the Phoenicians. From a very early period the little civic communities of Greece had sent forth numerous colonizing streams. At points so far asunder as the Tauric Chersonese, Cyrene and Massilia were found prosperous centres of Greek commercial energy; but the regions most thickly peopled by settlers of Greek descent were the western seaboard of Asia Minor, Sicily and the southern parts of the Italian peninsula. Nor were the least prosperous communities those which were sprung from earlier colonies. The causes that led to the foundation of the Greek colonies were very various. As in Phoenicia, pressure created by the narrow limits of the home country coincided with an adventurous desire to seek new sources of wealth beyond seas; but very many Greek emigrations were caused by the expulsion of the inhabitants of conquered cities, or by the intolerable domination of a hated but triumphant faction within the native state. The polity of the new community, often founded in defiance of the home authorities, might either be a copy of that just left behind or be its direct political antithesis. But wherever they went, and whether, as apparently in Asia Minor, Greek blood was kept free from barbaric mixture, or whether, as in Magna Graecia and Sicily, it was mingled with that of the

aboriginal races, the Greek emigrants carried with them the Hellenic spirit and the Hellenic tongue; and the colonies fostered, not infrequently more rapidly and more brilliantly than at home, Greek literature, Greek art and Greek speculation. The relation to be preserved towards the mother states was seldom or never definitely arranged. But filial feeling and established custom secured a measure of kindly sympathy, shown by precedence yielded at public games, and by the almost invariable abstinence of the colony from a hostile share in wars in which the mother city was engaged.

The relation of Rome to her colonies was altogether different. No Roman colony started without the sanction and direction of the public authority; and while the *Colonia Romana* differed from the *Colonia Latina* in that the former permitted its members to retain their political rights intact, the colony, whether planted within the bounds of Italy or in provinces such as Gaul or Britain, remained an integral part of the Roman state. In the earlier colonies, the state allotted to proposing emigrants from amongst the needy or discontented class of citizens portions of such lands as, on the subjection of a hostile people, the state took into its possession as public property. At a later time, especially after the days of Sulla, the distribution of the territories of a vanquished Roman party was employed by the victorious generals as an easy means of satisfying the claims of the soldiery by whose help they had triumphed. The Roman colonies were thus not merely valuable as *propugnacula* of the state, as permanent supports to Roman garrisons and armies, but they proved a most effective means of extending over wide bounds the language and the laws of Rome, and of inoculating the inhabitants of the provinces with more than the rudiments of Roman civilization.

The occupation of the fairest provinces of the Roman empire by the northern barbarians had little in common with colonization. The Germanic invaders came from no settled state; they maintained loosely, and but for a short while, any form of brotherhood with the allied tribes. A nearer parallel to Greek colonization may be found in Iceland, whither the adherents of the old Norse polity fled from the usurpation of Harold Haarfager; and the early history of the English pale in Ireland shows, though not in orderliness and prosperity, several points of resemblance to the Roman colonial system.

Though both Genoese and Venetians in their day of power planted numerous trading posts on various portions of the Mediterranean shores, of which some almost deserve the name of colonies, the history of modern colonization on a great scale opens with the Spanish conquests in America. The first Spanish adventurers came, not to colonize, but to satisfy as rapidly as possible and by the labour of the enslaved aborigines, their thirst for silver and gold. Their conquests were rapid, but the extension of their permanent settlements was gradual and slow. The terrible cruelty at first exercised on the natives was restrained, not merely by the zeal of the missionaries, but by effective official measures; and ultimately home-born Spaniards and Creoles lived on terms of comparative fairness with the Indians and with the half-breed population. Till the general and successful revolt of her American colonies, Spain maintained and employed the latter directly and solely for what she conceived to be her own advantage. Her commercial policy was one of most irrational and intolerable restriction and repression; and till the end of Spanish rule on the American continent, the whole political power was retained by the court at Madrid, and administered in the colonies by an oligarchy of home-bred Spaniards.

The Portuguese colonization in America, in most respects resembling that of Spain, is remarkable for the development there given to an institution sadly prominent in the history of the European colonies. The nearness of Brazil to the coast of Africa made it easy for the Portuguese to supply the growing lack of native labour by the wholesale importation of purchased or kidnapped Africans.

Of the French it is admitted that in their colonial possessions they displayed an unusual faculty for conciliating the prejudices

of native races, and even for assimilating themselves to the latter. But neither this nor the genius of successive governors and commanders succeeded in preserving for France her once extensive colonies in Canada or her great influence in India. In Algeria and West Africa the French government has not merely found practical training schools for her own soldiers, but by opening a recruiting field amongst the native tribes it has added an available contingent to the French army.

The Dutch took early a leading share in the carrying trade of the various European colonies. They have still extensive colonies in the East Indian Archipelago, as well as possessions in the West Indies. The Danish dependencies in the Antilles are but trifling in extent or importance.

It is the English-speaking race, however, that has shown the most remarkable energy and capacity for colonization. The English settlements in Virginia, New England, New York, New Jersey, Maryland, Pennsylvania, Delaware, South Carolina, North Carolina, and Georgia had, between the first decade of the 17th and the seventh decade of the 18th century, developed into a new nation, the United States of America. It is unnecessary here to deal with the development of what have since been the two great independent branches of the English-speaking people—those of the United States (*q.v.*) and of the British Empire (*q.v.*), as their history is given elsewhere. But the colonizing genius which, with the British Isles as centre, has taken up the "white man's burden" in all quarters of the globe, is universally recognized. In the problems of government raised by the organization of the British dominions beyond the seas the system of colonization has been developed to an extent unknown under any other national flag.

COLOPHON, an ancient city of Ionia, situated inland about 15 m. N. of Ephesus. Its port was at Notium or New Colophon. The site, now called *Tracha* (only recognized towards the end of the 19th century), lies near Diermendere, 5 m. S. of Develikeui station on the Smyrna-Aidin railway, and about 2 m. from the farms and hamlet of Malkajik. It is almost entirely under cultivation, and there is little to be seen but remains of the walls and certain tumuli. Rich tombs, however, have been found beside the old roads leading to it, and the site is usually regarded as a particularly promising one for excavation, since Colophon was a very flourishing city in the great period of Ionia and had declined and been largely superseded by Notium before the Roman age. The common belief, however, that it had no existence after the time of Lysimachus is not borne out by the remains on the site. Founded by Andracmon of Pylos, it was at the acme of its prosperity in the 8th and 7th centuries B.C. up to the epoch of its sack by Gyges of Lydia in 665. It claimed to have produced Homer, but its greatest genuine literary name was Mimnermus. It seems to have been ruled by a rich aristocracy which provided a famous troop of horse; and, from the Greek saying, usually supposed to refer to the decisive effect of the final charge of this troop in battle, the word *colophon* has come to be used for the final note appended to old printed books, containing date, &c. In 287 Lysimachus transferred a part of the population to his new city at Ephesus. Though an Ionian colony Colophon did not share in the common festival of the *Apaturia* and seems to have been isolated for some reason among its neighbours, with one of whom, Ephesus, it was constantly at enmity. The forts by which Ephesus protected itself against Colophonian invasion are still to be seen on the hills north of the Caystrus.

Notium or New Colophon contained the important shrine of the Clarian Apollo, whose site has recently been identified with probability by Th. Makridy Bey during excavations conducted for the Ottoman museum.

See C. Schuchardt in *Athen. Mitteil.* (1886); W. M. Ramsay, *Hist. Geog. of Asia Minor* (addenda) (1890). (D. G. H.)

COLOPHON, a final paragraph in some manuscripts and many early printed books (see *BOOK*), giving particulars as to authorship, date and place of production, &c. Before the invention of printing, a scribe when he had finished copying a book occasionally added a final paragraph at the end of the text in

which he recorded the fact, and (if he were so minded) expressed his thankfulness to God, or asked for the prayers of readers. In the famous Bodleian MS. 264 of the *Roman d'Alexandre* there is an unusually full note of this kind recording the completion of the copy on the 18th of December 1338 and ending—

"Explicit iste liber, scriptor sit crimine liber,
Christus scriptorem custodiat ac det honorem."

Both in manuscripts and also in early printed books authors made use of such a final paragraph for expressing similar feelings. Thus the Guillelmus who made a famous collection of sermons on the gospels for Sundays and saints' days records its completion in 1437 and submits it to the correction of charitable readers, and Sir Thomas Malory notes that his *Morte d'Arthur* "was ended the ix yere of the reygne of Kyng Edward the fourth," and bids his readers "praye for me whyle I am on lyue that God sende me good delyuerance, and whan I am deed I praye you all praye for my soule." So again Jacobus Bergomensis records that his *Supplementum Chronicarum* was finished "anno salutis nostre 1483. 3^o Kalendas Julii in ciuitate Bergomi: mihi vero a natiuitate quadragesimo nono," and in the subsequent editions which he revised brings both the year and his own age up to date. Before printing was invented, however, such paragraphs were exceptional, and many of the early printers, notably Gutenberg himself, were content to allow their books to go out without any mention of their own names. Fust and Schoeffer, on the other hand, printed at the end of their famous psalter of 1457 the following paragraph in red ink:—*Presens psalorum (sic for psalorum) codex vcnustate capitalium decorctus Rubricattonibusque sufficienter distinctus, Adinventionone artificiosa imprimendi ac caracterizandi absque colami ulla exaracione sic effigialis, Et ad eusebiam dei industrie est consummalus, Per Iohannem Just ciuem magunlinum, Et Petrum Schoffer de Gernsheim Anno domini Millesimo. cccc. lviii In vigilia Assumpcionis.* Similar paragraphs in praise of printing and of Mainz as the city where the art was brought to perfection appear in most of the books issued by the partners and after Fust's death by Schoeffer alone, and were widely imitated by other printers. In their Latin Bible of 1462 Fust and Schoeffer added a device of two shields at the end of the paragraph, and this addition was also widely copied. Many of these final paragraphs give information of great value for the history of printing; many also, especially those to the early editions of the classics printed in Italy, are written in verse. As the practice grew up of devoting a separate leaf or page to the title of a book at its beginning, the importance of these final paragraphs slowly diminished, and the information they gave was gradually transferred to the title-page. Complete title-pages bearing the date and name of the publishers are found in most books printed after 1520, and the final paragraph, if retained at all, was gradually reduced to a bare statement of the name of the printer. From the use of the word in the sense of a "finishing stroke," such a final paragraph as has been described is called by bibliographers a "colophon" (Gr. *κολοφών*), but at what period this name for it was first used has not been ascertained. It is quite possibly not earlier than the 18th century. (For origin see *COLOPHON* [city].) (A. W. Po.)

COLORADO, a state of the American union, situated between 41° and 37° N. lat. and 102° and 109° W. long., bounded N. by Wyoming and Nebraska, E. by Nebraska and Kansas, S. by Oklahoma and New Mexico, and W. by Utah. Its area is 103,948 sq. m. (of which 290 are water surface). It is the seventh largest state of the Union.

Physiography.—Colorado embraces in its area a great variety of plains, mountains and plateaus. It lies at the junction of the Great Plains—which in their upward slant to the westward attain an average elevation of about 4000 ft. along the east boundary of the state—with the Rocky Mountains, to the west of which is a portion of the Colorado Plateau. These are the three physiographic provinces of the state (see also *UNITED STATES*, section *Geology, ad fin.*, for details of structure). The last-named includes a number of lofty plateaus—the Roan or Book, Uncompahgre, &c., which form the eastern continuation of the high plateaus of Utah—and covers the western quarter of the

state. Its eastern third consists of rich, unbroken plains. On their west edge lies an abrupt, massive, and strangely uniform chain of mountains, known in the neighbourhood of Colorado Springs as the Rampart Range, and in the extreme north as the Front Range, and often denominated as a whole by the latter name. The upturning of the rocks of the Great Plains at the foot of the Front Range develops an interesting type of topography, the harder layers weathering into grotesquely curious forms, as seen in the famous Garden of the Gods at the foot of Pike's Peak. Behind this barrier the whole country is elevated 2000 ft. or so above the level of the plains region. In its lowest portions just behind the front ranges are the natural "parks"—great plateaus basined by superb enclosing ranges; and to the west of these, and between them, and covering the remainder of the state east of the plateau region, is an entanglement of mountains, tier above tier, running from north to south, buttressed laterally with splendid spurs, dominated by scores of magnificent peaks, cut by river valleys, and divided by mesas and plateaus. These various chains are known by a multitude of local names. Among the finest of the chains are the Rampart, Sangre de Cristo, San Juan, Sawatch (Saguache) and Elk ranges. The first, like the other ranges abutting from north to south upon the region of the prairie, rises abruptly from the plain and has a fine, bold outline. It contains a number of fine summits dominated by Pike's Peak (14,108 ft.). Much more beautiful as a whole is the Sangre de Cristo range. At its southern end are Blanca Peak (14,390) and Old Baldy (14,176, Hayden), both in Costilla county; to the northward are Rito Alto Peak (12,989, Wheeler), in Custer county, and many others of almost equal height and equal beauty. The mountains of the south-west are particularly abrupt and jagged. Sultan Mountain (13,366, Hayden), in San Juan county, and Mt. Eolus (14,079), in La Plata county, dominate the fine masses of the San Juan ranges; and Mt. Sneffels (14,158, Hayden), Ouray county, and Uncompahgre Peak (14,289), Hinsdale county, the San Miguel and Uncompahgre ranges, which are actually parts of the San Juan. Most magnificent of all the mountains of Colorado, however, are the Sawatch and adjoining ranges in the centre of the state. The former (the name is used a little loosely) consists of almost a solid mass of granite, has an average elevation of probably 13,000 ft., presents a broad and massive outline, and has a mean breadth of 15 to 20 m. Mt. Ouray (13,956 ft.), in Chaffee county, may be taken as the southern end, and in Eagle county, the splendid Mount of the Holy Cross (14,170)—so named from the figure of its snow-filled ravines—as the northern. Between them lie: in Chaffee county, Mt. Shavano (14,239, Hayden), Mt. Princeton (14,196, Hayden), Mt. Yale (14,187, Hayden), Mt. Harvard (14,375, Hayden), and La Plata Peak (14,342); in Pitkin county, Grizzly Peak (13,956, Hayden); in Lake county, Elbert Peak (14,421), and Massive mountain (14,424), the highest peak in the state; on the boundary between Summit and Park counties, Mt. Lincoln (14,297, Hayden); and, in Summit county, Mt. Fletcher (14,265). The Elk range is geologically interesting for the almost unexampled displacement of the strata of which it is composed, and the apparent confusion which has thence arisen. Among the most remarkable of its separate summits, which rise superbly in a crescent about Aspen, are North Italian Peak (13,225), displaying the red, white and green of Italy's national colours, White Rock Mountain (13,532), Mt. Owen (13,102), Teocalli Mountain (13,220), Snow Mass (13,970, Hayden) and Maroon (14,003, Hayden) mountains, Castle Peak (14,259), Capitol Mountain (13,997, Hayden), Pyramid Peak (13,885, Hayden), Taylor Peak (13,419), and about a dozen other summits above 12,000 ft. A few miles to the north and north-east of the Mount of the Holy Cross are Red Mountain (13,333, Wheeler), in Eagle county, Torrey Peak (14,336, Hayden) and Gray's Peak (14,341, Hayden), in Summit county, Mt. Evans (14,330, Hayden), in Clear Creek county, and Rosalie Peak (13,575), in Park county; a little farther north, in Gilpin, Grand and Clear Creek counties, James Peak (13,283, Hayden), and, in Boulder county, Long's Peak (14,271, Hayden). Many fine mountains are scattered in the lesser ranges of the

state. Altogether there are at least 180 summits exceeding 12,000 ft. in altitude, more than 110 above 13,000 and about 40 above 14,000.

Cirques, valley troughs, numberless beautiful cascades, sharpened alpine peaks and ridges, glacial lakes, and valley moraines offer everywhere abundant evidence of glacial action, which has modified profoundly practically all the ranges. The Park Range east of Leadville, and the Sawatch Range, are particularly fine examples. Much of the grandest scenery is due to glaciation.

One of the most remarkable orographical features of the state are the great mountain "parks"—North, Estes, Middle, South and San Luis—extending from the northern to the southern border of the state, and lying (with the exception of Middle Park) just east of the continental divide. These "parks" are great plateaus, not all of them level, lying below the barriers of surrounding mountain chains. North Park, the highest of all, is a lovely country of meadow and forest. Middle Park is not level, but is traversed thickly by low ranges like the Alleghanies; in the bordering mountain rim are several of the grandest mountain peaks and some of the most magnificent scenery of the state. Estes Park is small, only 20 m. long and never more than 2 m. broad; it is in fact the valley of Thompson Creek. Its surface is one of charming slopes, and by many it is accounted among the loveliest of Colorado valleys. Seven ranges lie between it and the plains. South Park is similarly quiet and charming in character. Much greater than any of these is San Luis Park. The surface is nearly as flat as a lake, and it was probably at one time the bed of an inland sea. In the centre there is a long narrow lake fed by many streams. It has no visible outlet, but is fresh. The San Luis Park, which runs into New Mexico, is traversed by the Rio Grande del Norte and more than a dozen of its mountain tributaries. These parks are frequented by great quantities of large game, and—especially the North and Middle—are famous hunting-grounds. They are fertile, too, and as their combined area is something like 13,000 sq. m. they are certain to be of great importance in Colorado's agricultural development.

The drainage system of the state is naturally very complicated. Eleven topographical and climatic divisions are recognized by the United States Weather Bureau within its borders, including the several parks, the continental divide, and various river valleys. Of the rivers, the North Platte has its sources in North Park, the Colorado (the Gunnison and Grand branches) in Middle Park, the Arkansas and South Platte in South Park—where their waters drain in opposite directions from Palmer's Lake—the Rio Grande in San Luis Park. Three of these flow east and south-east to the Missouri, Mississippi and the Gulf; but the waters of the Colorado system flow to the south-west into the Gulf of California. Among the other streams, almost countless in number among the mountains, the systems of the Dolores, White and Yampa, all in the west, are of primary importance. The scenery on the head-waters of the White and Bear, the upper tributaries of the Gunnison, and on many of the minor rivers of the south-west is wonderfully beautiful. The South Platte falls 4830 ft. in the 139 m. above Denver; the Grand 3600 ft. in the 224 m. between the mouth of the Gunnison and the Forks; the Gunnison 6477 ft. in 200 m. to its mouth (and save for 16 m. never with a gradient of less than 10 ft.); the Arkansas 7000 ft. in its 338 m. west of the Kansas line. Of the smaller streams the Uncompahgre falls 2700 ft. in 134 m., the Las Animas 7190 ft. in 113 m., the Los Pinos 4920 ft. in 75 m., the Roaring Fork 5923 ft. in 64 m., the Mancos 5000 ft. in 62 m., the La Plata 3103 ft. in 43 m., the Eagle 4293 ft. in 62 m., the San Juan 3785 in 303, the Lake Fork of the Gunnison 6047 in 59. The canyons formed in the mountains by these streams are among the glories of Colorado and of America. The grandest are the Toltec Gorge near the Southern boundary line, traversed by the railway 1500 ft. above the bottom; the Red Gorge and Rouge Canyon of the Upper Grand, and a splendid gorge 16 m. long below the mouth of the Eagle, with walls 2000-2500 ft. in height; the Grand Canyon of the Arkansas (8 m.) above Canyon City, with granite walls towering 2600 ft. above the boiling river at the

Royal Gorge; and the superb Black Canyon (15 m.) of the Gunnison and the Cimarron. But there are scores of others which, though less grand, are hardly less beautiful. The exquisite colour contrasts of the Cheyenne canyons near Colorado Springs, Boulder Canyon near the city of the same name, Red Cliff and Eagle River Canyons near Red Cliff, Clear Creek Canyon near Denver—with walls at places 1000 ft. in height—the Granite Canyon (11 m.) of the South Platte west of Florissant, and the fine gorge of the Rio de las Animas (1500 ft.), would be considered wonderful in any state less rich in still more marvellous scenery. One peculiar feature of the mountain landscapes are the mines. In districts like that of Cripple Creek their enormous ore “dumps” dot the mountain flanks like scores of vast ant-hills; and in Eagle River canyon their mouths, like dormer windows into the granite mountain roof, may be seen 2000 ft. above the railway.

Many parts of the railways among the mountains are remarkable for altitude, construction or scenery. More than a dozen mountain passes lie above 10,000 ft. Argentine Pass (13,000 ft.), near Gray's Peak, is one of the highest wagon roads of the world; just east of Silverton is Rio Grande Pass, about 12,400 ft. above sea-level, and in the Elk Mountains between Gunnison and Pitkin counties is Pearl Pass (12,715 ft.). Many passes are traversed by the railways, especially the splendid scenic route of the Denver and Rio Grande. Among the higher passes are Hoosier Pass (10,309 ft.) in the Park Range, and Hayden Divide (10,780) and Veta Pass (9390), both of these across the Sangre de Cristo range; the crossing of the San Miguel chain at Lizard Head Pass (10,250) near Rico; of the Uncompahgre at Dallas Divide (8977) near Ouray; of the Elk and Sawatch ranges at Fremont (11,320), Tennessee (10,229), and Breckenridge (11,470) passes, and the Busk Tunnel, all near Leadville; and Marshall Pass (10,846) above Salida. Perhaps finer than these for their wide-horizoned outlooks and grand surroundings are the Alpine Tunnel under the continental divide of the Lower Sawatch chain, the scenery of the tortuous line along the southern boundary in the Conejos and San Juan mountains, which are crossed at Cumbres (10,003 ft.), and the magnificent scenery about Ouray and on the Silverton railway over the shoulder of Red Mountain (attaining 11,235 ft.). Notable, too, is the road in Clear Creek Canyon—where the railway track coils six times upon itself above Georgetown at an altitude of 10,000 ft.

Climate.—The climate of Colorado is exceptional for regularity and salubrity. The mean annual temperature for the state is about 46°. The mean yearly isothermals crossing the state are ordinarily 35° to 50° or 55° F. Their course, owing to the complex orography of the state, is necessarily extremely irregular, and few climatic generalizations can be made. It can be said, however, that the south-east is the warmest portion of the state, lying as it does without the mountains; that the north-central region is usually coldest; that the normal yearly rainfall for the entire state is about 15.5 in., with great local variations (rarely above 27 in.). Winds are constant and rather high (5 to 10 m.), and for many persons are the most trying feature of the climate. Very intense cold prevails of course in winter in the mountains, and intense heat (110° F. or more in the shade) is often experienced in summer, temperatures above 90° being very common. The locality of least annual thermometric range is Lake Moraine (10,268 ft. above the sea)—normally 91° F.; at other localities the range may be as great as 140°, and for the whole state of course even greater (155° or slightly more). The lowest monthly mean in 16 years (1887-1903) was 17.30. Nevertheless, the climate of Colorado is not to be judged severe, and that of the plains region is in many ways ideal. In the lowlands the snow is always slight and it disappears almost immediately, even in the very foothills of the mountains, as at Denver or Colorado Springs. However hot the summer day, its night is always cool and dewless. Between July and October there is little rain, day after day bringing a bright and cloudless sky. Humidity is moderate (annual averages for Grand Junction, Pueblo, Denver and Cheyenne, Wyo., for 6 A.M. about 50 to 66;

for 6 P.M. 33 to 50); it is supposed to be increasing with the increasing settlement of the country. Sunshine is almost continuous, and splendidly intense. The maximum number of “rainy” days (with a rainfall of more than 0.01 in.) rarely approaches 100 at the most unfortunate locality; for the whole state the average of perfectly “clear” days is normally above 50%, of “partly cloudy” above 30, of “cloudy” under 20, of “rainy” still less. At Denver, through 11 years, the actual sunlight was 70% of the possible; many other points are even more favoured; very many enjoy on a third to a half of the days of the year above 90% of possible sunshine. All through the year the atmosphere is so dry and light that meat can be preserved by the simplest process of desiccation. “An air more delicious to breathe,” wrote Bayard Taylor, “cannot anywhere be found; it is neither too sedative nor too exciting, but has that pure, sweet, flexible quality which seems to support all one's happiest and healthiest moods.” For asthmatic and consumptive troubles its restorative influence is indisputable. Along with New Mexico and Arizona, Colorado has become more and more a sanitarium for the other portions of the Union. Among the secondary hygienic advantages are the numerous mineral wells.

Flora and Fauna.—The life zones of Colorado are simple in arrangement. The boreal embraces the highest mountain altitudes; the transition belts it on both sides of the continental divide; the upper Sonoran takes in about the eastern half of the plains region east of the mountains, and is represented further by two small valley penetrations from Utah. Timber is confined almost wholly to the high mountain sides, the mountain valleys and the parks being for the most part bare. Nowhere is the timber large or dense. The timber-line on the mountains is at about 10,000 ft., and the snow line at about 11,000. It is supposed that the forests were much richer before the settlement of the state, which was followed by reckless consumption and waste, and the more terrible ravages of fire. In 1872-1876 the wooded area was estimated at 32% of the state's area. It is certainly much less now. The principal trees, after the yellow and lodgepole pines, are the red-fir, so-called hemlock and cedar, the Engelmann spruce, the cottonwood and the aspen (*Populus tremuloides*). In 1899 Federal forest reserves had been created, aggregating 4849 sq. m. in extent, and by 1910 this had been increased to 24,528 sq. m. The reserves cover altitudes of 7000 to 14,000 ft. The rainfall is ample for their needs, but no other reserves in the country showed in 1900 such waste by fire and pillage. The minor flora of the country is exceedingly rich. In the plains the abundance of flowers, from spring to autumn, is amazing.

Large game is still very abundant west of the continental divide. The great parks are a favourite range and shelter. Deer and elk frequent especially the mountains of the north-west, in Routt and Rio Blanco counties, adjoining the reservations of the Uncompahgre (White River Ute) and Uintah-Ute Indians—from whose depredations, owing to the negligence of Federal officials, the game of the state has suffered enormous losses. The bison have been exterminated. Considerable bands of antelope live in the parks and even descend to the eastern plains, and the mule-deer, the most common of large game, is abundant all through the mountains of the west. Grizzly or silver-tip, brown and black bears are also abundant in the same region. Rarest of all is the magnificent mountain sheep. Game is protected zealously, if not successfully, by the state, and it was officially estimated in 1898 that there were then probably 7000 elk, as many mountain sheep, 25,000 antelope and 100,000 deer within its borders (by far the greatest part in Routt and Rio Blanco counties). Fish are not naturally very abundant, but the mountain brooks are the finest home for trout, and these as well as bass, cat-fish and some other varieties have been used to stock the streams.

Soil.—The soils of the lowlands are prevailing sandy loams, with a covering of rich mould. The acreage of improved lands in 1900 was returned by the federal census as 2,273,968, three times as much being unimproved; the land improved constituted

3.4% of the state's area. The lands available for agriculture are the lowlands and the mountain parks and valleys.

Speaking generally, irrigation is essential to successful cultivation, but wherever irrigation is practicable the soil proves richly productive. Irrigation ditches having been exempted from taxation in 1872, extensive systems of canals were soon developed, especially after 1880. The Constitution of Colorado declares the waters of its streams the property of the state, and a great body of irrigation law and practice has grown up about this provision. The riparian doctrine does not obtain in Colorado. In no part of the semi-arid region of the country are the irrigation problems so diverse and difficult. In 1903 there were, according to the governor, 10 canals more than 50 m. in length, 51 longer than 20 m., and hundreds of reservoirs. In 1899 there were 7374 m. of main ditches. The average annual cost of water per acre was then estimated at about 79 cents. The acres under ditch in 1902 were greater (1,754,761) than in any other state; and the construction cost of the system was then \$14,769,561 (an increase of 25.6% from 1899 to 1902). There are irrigated lands in every county. Their area increased 8.9% in 1899-1902, and 80.9% from 1890 to 1900; in the latter year they constituted 70.9% of the improved farm-land of the state, as against 48.8 in 1890. The land added to the irrigated area in the decade was in 1890 largely worthless public domain; its value in 1900 was about \$29,000,000. As a result of irrigation the Platte is often dry in eastern Colorado in the summer, and the Arkansas shrinks so below Pueblo that little water reaches Kansas. The water is almost wholly taken from the rivers, but underflow is also utilized, especially in San Luis Park. The South Platte is much the most important irrigating stream. Its valley included 660,495 acres of irrigated land in 1902, no other valley having half so great an area. The diversion of the waters of the Arkansas led to the bringing of a suit against Colorado by Kansas in the United States Supreme Court in 1902, on the ground that such diversion seriously and illegally lessened the waters of the Arkansas in Kansas. In 1907 the Supreme Court of the United States declared that Colorado had diverted waters of the Arkansas, but, since it had not been shown that Kansas had suffered, the case was dismissed, without prejudice to Kansas, should it be injured in future by diversion of water from the river. The exhaustion, or alleged exhaustion, by irrigation in Colorado of the waters of the Rio Grande has raised international questions of much interest between Mexico and the United States, which were settled in 1907 by a convention pledging the United States to deliver 60,000 acre-feet of water annually in the bed of the Rio Grande at the Acequia Madre, just above Juarez, in case of drought this supply being diminished proportionately to the diminution in the United States. As a part of the plans of the national government for reclamation of land in the arid states, imposing schemes have been formulated for such work in Colorado, including a great reservoir on the Gunnison. One of the greatest undertakings of the national reclamation service is the construction of 77 m. of canal and of a six-mile tunnel, beneath a mountain, between the canyon of the Gunnison and the valley of the Uncompahgre, designed to make productive some 140,000 acres in the latter valley.

Apart from mere watering, cultivation is in no way intensive. One of the finest farming regions is the lowland valley of the Arkansas. It is a broad, level plain, almost untimbered, given over to alfalfa, grains, vegetables and fruits. Sugar-beet culture has been found to be exceptionally remunerative in this valley as well as in those of the South Platte and Grand rivers. The growth of this interest has been since 1899 a marked feature in the agricultural development of the state; and in 1905, 1906 and 1907 the state's product of beets and of sugar was far greater than that of any other state; in 1907, 1,523,303 tons of beets were worked—more than two-fifths of the total for the United States. There are various large sugar factories (in 1903, 9, and in 1907, 16), mainly in the north; also at Grand Junction and in the Arkansas valley. The total value of all farm property increased between 1880 and 1900 from \$42,000,000 to \$161,045,101 and 45.9% from 1890 to 1900. In the latter year \$49,954,311

of this was in live-stock (increase 1890-1900, 121.1%), the remaining value in land with improvements and machinery. The total value of farm products in 1899 was \$33,048,576; of this sum 97% was almost equally divided between crop products and animal products, the forests contributing the remainder. Of the various elements in the value of all farm produce as shown by the federal census of 1900, live-stock, hay and grains, and dairying represented 87.2%. The value of cereals (\$4,700,271)—of which wheat and oats represent four-fifths—is much exceeded by that of hay and forage (\$8,159,279 in 1899). Wheat culture increased greatly from 1890 to 1900. Flour made from Colorado wheat ranks very high in the market. As a cereal-producing state Colorado is, however, relatively unimportant; nor in value of product is its hay and forage crop notable, except that of alfalfa, which greatly surpasses that of any other state. In 1906 the state produced 3,157,136 bushels of Indian corn, valued at \$1,578,568; 8,266,538 bushels of wheat, valued at \$5,373,250; 5,902,394 bushels of oats, valued at \$2,683,077; 759,771 bushels of barley, valued at \$410,276; 43,580 bushels of rye, valued at \$24,405; and 1,506,542 tons of hay, valued at \$15,167,149. The value of vegetable products, of fruits, and of dairy products was, relatively, equally small (only \$7,346,415 in 1899). Natural fruits are rare and practically worthless. Apples, peaches, plums, apricots, pears, cherries and melons have been introduced. The best fruit sections are the Arkansas valley, and in the western and south-western parts of the state. Melons are to some extent exported, and peaches also; the musk-melons of the Arkansas valley (Rocky Ford Canteloups) being in demand all over the United States. The fruit industry dates practically from 1890. The dairy industry is rapidly increasing. In the holdings of neat cattle (1,453,971) and sheep (2,045,577) it ranked in 1900 respectively seventeenth and tenth among the states of the Union; in 1907, according to the *Yearbook of the Department of Agriculture*, there were in the state 1,561,712 neat cattle and 1,677,561 sheep. Stock-raising has always been important. The parks and mountain valleys are largely given over to ranges. The native grasses are especially adapted for fodder. The grama, buffalo and bunch varieties cure on the stem, and furnish throughout the winter an excellent ranging food. These native grasses, even the thin bunch varieties of dry hills, are surprisingly nutritious, comparing very favourably with cultivated grasses. Large areas temporarily devoted to cultivation with poor success, and later allowed to revert to ranges, have become prosperous and even noted as stock country. This is true of the sandhill region of eastern Colorado. The grass flora of the lowlands is not so rich in variety nor so abundant in quality as that of high altitudes. Before the plains were fenced large herds drifted to the south in the winter, but now sufficient hay and alfalfa are cut to feed the cattle during the storms, which at longest are brief. An account of Colorado agriculture would not be complete without mentioning the depredations of the grasshopper, which are at times extraordinarily destructive, as also of the "Colorado Beetle" (*Doryphora decemlineata*), or common potato-bug, which has extended its fatal activities eastward throughout the prairie states.

Minerals.—Colorado is pre-eminently a mineral region, and to this fact it owes its colonization. It possesses unlimited supplies, as yet not greatly exploited, of fine building stones, some oil and asphalt, and related bituminous products, a few precious and semi-precious stones (especially tourmalines, beryls and aquamarines found near Canyon near the Royal Gorge of the Arkansas river), rare opalized and jasperized wood (in the eastern part of the El Paso county), considerable wealth of lead and copper, enormous fields of bituminous coal, and enormous wealth of the precious metals. In the exploitation of the last there have been three periods: that before the discovery of the lead-carbonate silver ores of Leadville in 1879, in which period gold-mining was predominant; the succeeding years until 1894, in which silver-mining was predominant; and the period since 1894, in which gold has attained an overwhelming primacy. The two metals are found in more than 50 counties, San Miguel, Gilpin, Boulder, Clear Creek, Lake, El Paso and

Teller being the leading producers. The Cripple Creek field in the last-named county is one of the most wonderful mining districts, past or present, of America. Leadville, in Lake county, is another. The district about Silverton (product 1870-1900 about \$35,000,000, principally silver and lead, and mostly after 1881) has also had a remarkable development; and Creede, in the years of its brief prosperity, was a phenomenal silver-field. From 1858 up to and including 1904 the state produced, according to the State Bureau of Mines (whose statistics have since about 1890 been brought into practical agreement with those of the national government) a value of no less than \$889,203,323 in gold, silver, lead, copper and zinc at market prices. (If the value of silver be taken at coinage value this total becomes vastly greater.) The yield of gold was \$353,913,695—\$229,236,997 from 1895 to 1904; of silver, \$386,455,463—\$115,698,366 from 1889 to 1893; of lead, \$120,742,674—its importance beginning in 1879; of copper, \$17,879,446—\$8,441,783 from 1898 to 1904; and of zinc, \$10,212,045—all this from 1902 to 1904. Silver-mining ceased to be highly remunerative beginning with the closing of the India mints and repeal of the Sherman Law in 1893; since 1900 the yield has shown an extraordinary decrease—in 1905 it was \$6,945,581, and in 1907 \$7,411,652—and it is said that as a result of the great fall in the market value of the metal the mines can now be operated only under the most favourable conditions and by exercise of extreme economy. In Lake county, for example, very much of the argentiferous ore that is too low for remunerative extraction (limit 1903 about \$12.00 per ton) is used for fluxes.¹ The copper output was of slight importance until 1889—\$1,457,749 in 1905, and \$1,544,918 in 1907; and that of zinc was nil until 1902, when discoveries made it possible to rework for this metal enormous dumps of waste material about the mines, and in 1906 the zinc output was valued at \$5,304,884. Lead products declined with silver, but a large output of low ores has continued at Leadville, and in 1905 the product was valued at \$5,111,570, and in 1906 at \$5,933,829. Up to 1895 the gold output was below ten million dollars yearly; from 1898 to 1904 it ran from 21.6 to 28.7 millions. In 1897 the product first exceeded that of California. In 1907 the value was \$20,826,194. Silver values ran, in the years 1880-1902, from 11.3 to 23.1 million dollars; and the quantities in the same years from 11.6 to 26.3 million ounces. In 1907 it was 11,229,776 oz., valued at \$7,411,652. Regarding again the total combined product of the above five metals, its growth is shown by these figures for its value in the successive periods indicated: 1858-1879, \$77,380,140; 1879-1888, \$220,815,709; 1889-1898, \$322,878,362; 1899-1904, \$268,229,112. From 1900 to 1903 Colorado produced almost exactly a third of the total gold and silver (market value) product of the entire country.

In addition, iron ores (almost all brown hematite) occur abundantly, and all material for making steel of excellent quality. But very little iron is mined, in 1907 only 11,714 long tons, valued at \$21,085. Of much more importance are the manganiferous and the silver manganiferous ores, which are much the richest of the country.² Their product trebled from 1889 to 1903; and in 1907 the output of manganiferous ores amounted to 99,711 tons, valued at \$251,207. A small amount is used for spiegeleisen, and the rest as a flux.

The stratified rocks of the Great Plains, the Parks, and the Plateaus contain enormous quantities of coal. The coal-bearing rocks are confined to the Upper Cretaceous, and almost wholly to the Laramie formation. The main areas are on the two flanks of the Rockies, with two smaller fields in the Parks. The east group includes the fields of Canyon City (whose product is the ideal domestic coal of the western states), Raton and the South Platte; the Park group includes the Cones field and the Middle Park; the west group includes the Yampa, La Plata and Grand River fields—the last prospectively (not yet actually) the most valuable of all as to area and quality. About three-

fifths of all the coal produced in the state comes from Las Animas and Huerfano counties. In 1901 about a third and in 1907 nearly two-fifths of the state's output came from Las Animas county. The Colorado fields are superior to those of all the other Rocky Mountain states in area, and in quality of product. In 1907 Colorado ranked seventh among the coal-producing states of the Union, yielding 10,790,236 short tons (2.2% of the total for the United States). The total includes every variety from typical lignite to typical anthracite. The aggregate area of beds is estimated by the United States Geological Survey at 18,100 sq. m. (seventh in rank of the states of the Union); and the accessible coal, on other authority, at 33,897,800,000 tons. The industry began in 1864, in which year 500 tons were produced. The product first exceeded one million tons in 1882, two in 1888, three in 1890, four in 1893, five in 1900. From 1897 to 1902 the yield almost doubled, averaging 5,267,783 tons (lignite, semi-bituminous, bituminous, and a steady average production of 60,038 tons of anthracite). About one-fifth of the total product is made into coke, the output of which increased from 245,746 tons in 1890 to 1,421,579 tons (including a slight amount from Utah) in 1907; in 1907 the coke manufactured in Colorado (and Utah) was valued at \$4,747,436. Colorado holds the same supremacy for coal and coke west of the Mississippi that Pennsylvania holds for the country as a whole. The true bituminous coal produced, which in 1897 was only equal to that of the lignitic and semi-bituminous varieties (1.75 million tons), had come by 1902 to constitute three-fourths (5.46 million tons) of the entire coal output. Much of the bituminous coal, especially that of the Canyon City field, is so hard and clean as to be little less desirable than anthracite; it is the favoured coal for domestic uses in all the surrounding states.

Petroleum occurs in Fremont and Boulder counties. There have been very few flowing wells. The product increased from 76,295 barrels in 1887 to above 800,000 in the early 'nineties; it fell thereafter, averaging about 493,269 barrels from 1899 to 1903; in 1905 the yield was 376,238 barrels; and in 1907, 331,851 barrels. In 1905 the state ranked eleventh, in 1907 twelfth, in production of petroleum. It is mostly refined at Florence, the centre of the older field. The Boulder district developed very rapidly after 1902; its product is a high-grade illuminant with paraffin base. Asphalt occurs in the high north rim of Middle Park (c. 10,000 ft.). Tungsten is found in wolframite in Boulder county. In 1903 about 37,000 men were employed in the mines of Colorado. Labour troubles have been notable in state history since 1890.

Mineral springs have already been mentioned. They are numerous and occur in various parts of the state. The most important are at Buena Vista, Ouray, Wagon Wheel Gap, Poncha or Poncho Springs (90°-185° F.), Canyon City, Manitou, Idaho Springs and Glenwood Springs (120°-140° F., highly mineralized). The last three places, all beautifully situated—the first at the base of Pike's Peak, the second in the Clear Creek Canyon, and the third at the junction of the Roaring Fork with the Grand river—have an especially high repute. In 1904 it was competently estimated that the mineral yield and agricultural yield of the state were almost equal—somewhat above \$47,000,000 each.²

In 1900 only 4.6% of the population were engaged in manufactures. They are mainly dependent on the mining industry. There are many large smelters and reduction plants in the state, most of them at Denver, Leadville, Durango and Pueblo; at the latter place there are also blast-furnaces, a steel plant and rolling mills. Use is made of the most improved methods of treating the ore. The cyanide process, introduced about 1890, is now one of the most important factors in the utilization of low-grade and refractory gold and silver ores. The improved dioxide cyanide process was adopted about 1895. The iron and steel product—mainly at Pueblo—is of great importance, though relatively small as compared with that of some other states. Nevertheless, the very high rank in coal and iron

¹ The market value of silver varied in the years 1870-1885 from \$1.32 to \$1.065 an ounce; 1886-1893, \$0.995 to \$0.782; 1894-1904, \$0.630 to \$0.5722.

² The mineral yield for 1907, according to *The Mineral Resources of the United States*, 1907, amounted to \$71,105,128.

interests of the state among the states west of the Mississippi, the presence of excellent manganiferous ores, a central position for distribution, and much the best railway system of any mountain state, indicate that Colorado will almost certainly eventually entirely or at least largely control the trans-Mississippi market in iron and steel. The Federal census of 1900 credited the manufacturing establishments of the state with a capital of \$62,825,472 and a product of \$102,830,137 (increase 1890-1900, 142.1%); of which output the gold, silver, lead and copper smelted amounted to \$44,625,305. Of the other products, iron and steel (\$6,108,295), flouring and grist-mill products (\$4,528,062), foundry and machine-shop products (\$3,986,985), steam railway repair and construction work (\$3,141,602), printing and publishing, wholesale slaughtering and meat packing, malt liquors, lumber and timber, and coke were the most important. The production of beet sugar is relatively important, as more of it was produced in Colorado in 1905 than in any other state; in 1906 334,386,000 lb (out of a grand total for the United States of 967,224,000 lb) were manufactured here; the value of the product in 1905 was \$7,198,982, being 29.2% of the value of all the beet sugar produced in the United States in that year.¹

Railways.—On the 1st of January 1909 there were 5403 05 m. of railway in operation. The Denver Pacific, built from Cheyenne, Wyoming, reached Denver in June 1870, and the Kansas Pacific, from Kansas City, in August of the same year. Then followed the building of the Denver & Rio Grande (1871), to which the earlier development of the state is largely due. The great Santa Fé (1873), Burlington (1882), Missouri Pacific (1887) and Rock Island (1888) systems reached Pueblo, Denver and Colorado Springs successively from the east. In 1888 the Colorado Midland started from Colorado Springs westward, up the Ute Pass, through the South Park to Leadville, and thence over the continental divide to Aspen and Glenwood Springs. The Colorado & Southern, a consolidation of roads connecting Colorado with the south, has also become an important system.

Population.—The population of the state in 1870 was 39,864; in 1880, 194,327²; in 1890, 413,249; in 1900, 539,700; and in 1910, 799,024. Of the 1900 total, males constituted 54.7%, native born 83.1%. The 10,654 persons of coloured race included 1437 Indians and 647 Chinese and Japanese, the rest being negroes. Of 185,708 males twenty-one or more years of age 7689 (4.1%) were illiterate (unable to write), including a fourth of the Asiatics, a sixth of the Indians, one-nineteenth of the negroes, one in twenty-four of the foreign born, and one in 147.4 of the native born. Of 165 incorporated cities, towns and villages, 27 had a population exceeding 2000, and 7 a population of above 5000. The latter were Denver (133,859), Pueblo (28,137), Colorado Springs (21,085), Leadville (12,455), Cripple Creek (10,147), Boulder (6150) and Trinidad (5345). Creede, county-seat of Mineral county, was a phenomenal silver camp from its discovery in 1891 until 1893; in 1892 it numbered already 7000 inhabitants, but the rapid depreciation of silver soon thereafter caused most of its mines to be closed, and in 1910 the population was only 741. Grand Junction (pop. in 1910, 7754) derives importance from its railway connexions, and from the distribution of the fruit and other products of the irrigated valley of the Grand river. Roman Catholics are in the majority among church adherents, and Methodists and Presbyterians most

¹ The special census of manufactures of 1905 was concerned only with the manufacturing establishments of the state conducted under the so-called factory system. The capital invested in such establishments was \$107,663,500, and the product was valued at \$100,143,999. The corresponding figures for 1900 reduced to the same standard for purposes of comparison were \$58,172,865 and \$89,067,879. Thus during the five years the capital invested in factories increased 85.1%, and the factory product 12.4%. The increase in product would undoubtedly have been much greater but for the labour disturbances (described later in the article), which occurred during this interval. Of the total product in 1905 more than four-fifths were represented by the smelting of lead, copper and zinc ores, the manufacture of iron and steel, the production of coke, and the refining of petroleum. The value of the flour and grist-mill product was \$5,783,421.

² Census figures before 1890 do not include Indians on reservations.

numerous of the Protestant denominations. The South Ute Indian Reservation in the south of the state is the home of the Moache, Capote and Wiminuche Utes, of Shoshonean stock.

Administration.—The first and only state constitution was adopted in 1876. It requires a separate popular vote on any amendment—though as many as six may be (since 1900) voted on at one election. Amendments have been rather freely adopted. The General Assemblies are biennial, sessions limited to 90 days (45 before 1884); state and county elections are held at the same time (since 1902). A declared intention to become a United States citizen ceased in 1902 to be sufficient qualification for voters, full citizenship (with residence qualifications) being made requisite. An act of 1909 provides that election campaign expenses shall be borne "only by the state and by the candidates," and authorized appropriations for this purpose. Full woman suffrage was adopted in 1893 (by a majority of about 6000 votes). Women have served in the legislature and in many minor offices; they are not eligible as jurors. The governor may veto any separate item in an appropriation bill. The state treasurer and auditor may not hold office during two consecutive terms. Convicts are deprived of the privilege of citizenship only during imprisonment. County government is of the commissioner type. There is a State Voter's League similar to that of Illinois.

In 1907 the total bonded debt of the state was \$393,500; the General Assembly in 1906 authorized the issue of \$900,000 worth of bonds to fund outstanding military certificates of indebtedness incurred in suppressing insurrections at Cripple Creek and elsewhere in 1903-1904. The question of issuing bonds for all outstanding warrants was decided to be voted on by the people in November 1908. Taxation has been very erratic. From 1877 to 1893 the total assessment rose steadily from \$3,453,946 to \$238,722,417; it then fell at least partly owing to the depreciation in and uncertain values of mining property, and from 1894 to 1900 fluctuated between 192.2 and 216.8 million dollars; in 1901 it was raised to \$465,874,288, and fluctuated in the years following; the estimated total assessment for 1907 was \$365,000,000.

Of charitable and reformatory institutions a soldiers' and sailors' home (1889) is maintained at Monte Vista, a school for the deaf and blind (1874) at Colorado Springs, an insane asylum (1879) at Pueblo, a home for dependent and neglected children (1895) at Denver, an industrial school for girls (1887) near Morrison, and for boys (1881) at Golden, a reformatory (1889) at Buena Vista, and a penitentiary (1868) at Canyon City. Denver was one of the earliest cities in the country to institute special courts for juvenile offenders; a reform that is widening in influence and promise. The parole system is in force in the state reformatory; and in the industrial school at Golden (for youthful offenders) no locks, bars or cells are used, the theory being to treat the inmates as "students." The state has a parole law and an indeterminate-sentence law for convicts.

The public school system of Colorado dates from 1861, when a school law was passed by the Territorial legislation; this law was superseded by that of 1876, which with subsequent amendments is still in force. In expenditure for the public schools per capita of total population from 1890 to 1903 Colorado was one of a small group of leading states. In 1906 there were 187,836 persons of school age (from 6 to 21) in the state, and of these 144,007 were enrolled in the schools; the annual cost of education was \$4.34 per pupil. In 1902-1903, 92.5% of persons from 5 to 18 years of age were enrolled in the schools. The institutions of the state are: the University of Colorado, at Boulder, opened 1877; the School of Mines, at Golden (1873); the Agricultural College, at Fort Collins (1870); the Normal School (1891) at Greeley; and the above-mentioned industrial schools. All are supported by special taxes and appropriations—the Agricultural College receiving also the usual aid from the federal government. Experiment stations in connexion with the college are maintained at different points. Colorado College (1874) at Colorado Springs, Christian but not denominational, and the University of Denver, Methodist, are on independent

COLORADO

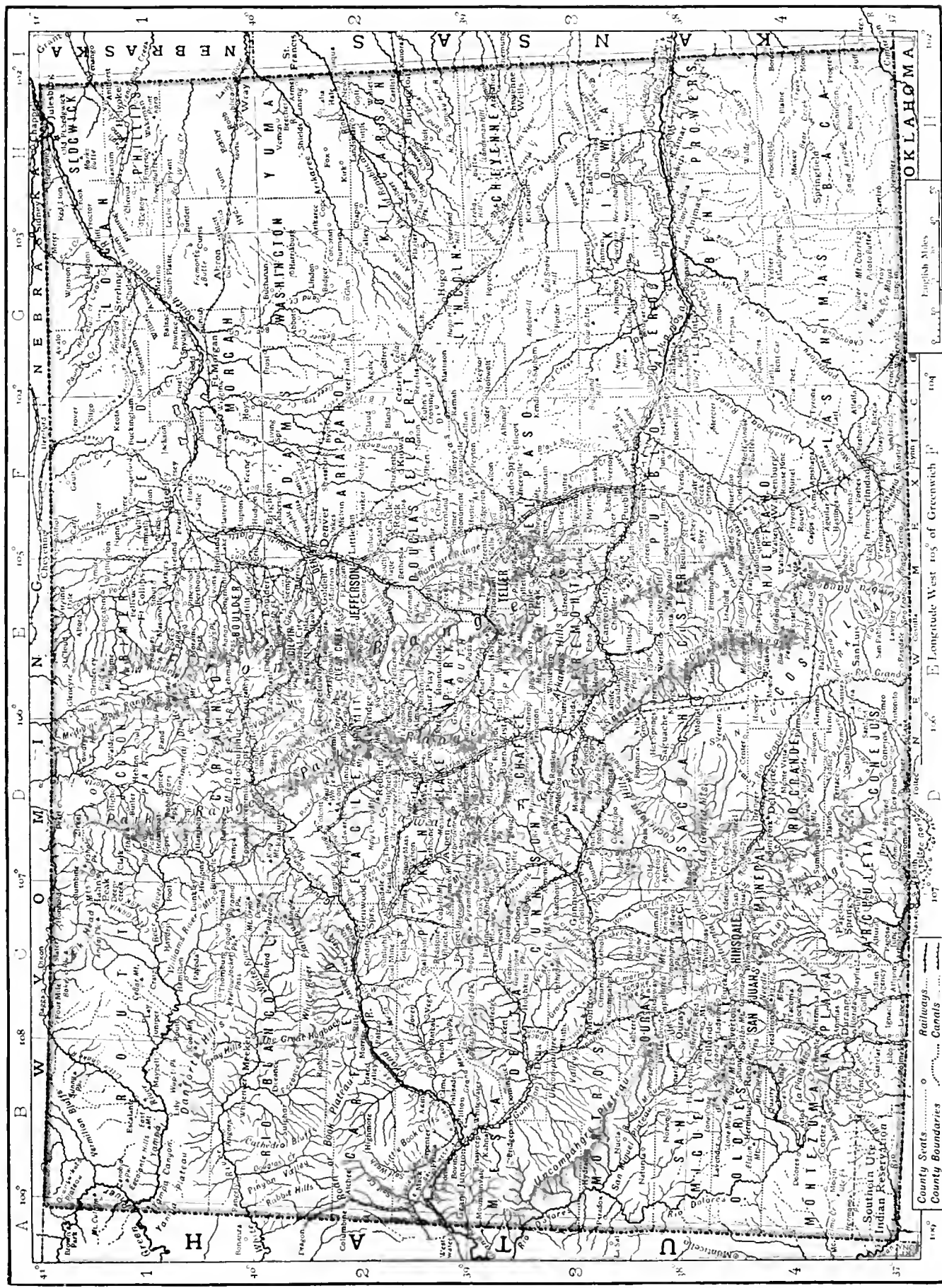

County Seats 0 Railroads Canals
County Boundaries
E Longitude West 105 of Greenwich
English Miles
OKLAHOMA

foundations. The United States maintains an Indian School at Grand Junction.

History.—According as one regards the Louisiana purchase as including or not including Texas to the Rio Grande (in the territorial meaning of the state of Texas of 1845), one may say that all of Colorado east of the meridian of the head of the Rio Grande, or only that north of the Arkansas and east of the meridian of its head, passed to the United States in 1803. At all events the corner between the Rio Grande and the Arkansas was Spanish from 1819 to 1845, when it became American territory as a part of the state of Texas; and in 1850, by a boundary arrangement between that state and the federal government, was incorporated in the public domain. The territory west of the divide was included in the Mexican cession of 1848. Within Colorado there are pueblos and cave dwellings commemorative of the Indian period and culture of the south-west. Coronado may have entered Colorado in 1540; there are also meagre records of indisputable Spanish explorations in the south in the latter half of the 18th century (friars Escalante and Dominguez in 1776). In 1806 Zebulon M. Pike, mapping the Arkansas and Red rivers of the Louisiana Territory for the government of the United States, followed the Arkansas into Colorado, incidentally discovering the famous peak that bears his name. In 1819 Major S. H. Long explored the valleys of the South Platte and Arkansas, pronouncing them uninhabited and uncultivable (as he also did the valley of the Missouri, whence the idea of the "Great American Desert"). His work also is commemorated by a famous summit of the Rockies. There is nothing more of importance in Colorado annals until 1858. From 1804 to 1854 the whole or parts of Colorado were included, nominally, under some half-dozen territories carved successively out of the Trans-Mississippi country; but not one of these had any practical significance for an uninhabited land. In 1828 (to 1832) a fortified trading post was established near La Junta in the Arkansas valley on the Santa Fé trail; in 1834-1836 several private forts were erected on the Platte; in 1841 the first overland emigrants to the Pacific coast crossed the state, and in 1846-1847 the Mormons settled temporarily at the old Mexican town of Pueblo. John C. Frémont had explored the region in 1842-1843 (and unofficially in later years for railway routes), and gave juster reports of the country to the world than his predecessors. Commerce was tributary in these years to the (New) Mexican town of Taos.

Colorado was practically an unknown country when in 1858 gold was discovered in the plains, on the tributaries of the South Platte, near Denver. In 1859 various discoveries were made in the mountains. The history of Denver goes back to this time. Julesburg, in the extreme north-east corner, at the intersection of the Platte valley and the overland wagon route, became transiently important during the rush of settlers that followed. Emigration from the East was stimulated by the panic and hard times following 1857. During 1860, 1861 and 1862 there was a continuous stream of immigration. Denver (under its present name), Black Hawk, Golden, Central City, Mount Vernon and Nevada City were all founded in 1859; Breckenridge, Empire, Gold Hill, Georgetown and Mill City date from 1860 and 1861. The political development of the next few years was very complicated. "Arapahoe County," including all Colorado, was organized as a part of Kansas Territory in 1858; but a delegate was also sent to Congress to work for the admission of an independent territory (called "Jefferson"). At the same time, early in 1860, a movement for statehood was inaugurated, a constitution being framed and submitted to the people, who rejected it, adopting later in the year a constitution of territorial government. Accordingly the Territory of Jefferson arose, assuming to rule over six degrees of latitude (37°-43°) and eight of longitude (102°-110°). Then there was the Kansas territorial government also, and under this a full county organization was maintained. Finally, peoples' court, acting wholly without reference to Kansas, and with no more than suited them (some districts refusing taxes) to the local "provisional" legislature, secured justice in the mining country. The provisional legis-

lature of the Territory of Jefferson maintained a wholly illegal but rather creditable existence somewhat precariously and ineffectively until 1861. Its acts, owing to the indifference of the settlers, had slight importance. Some, such as the first charter of Denver, were later re-enacted under the legal territorial government, organized by the United States in February 1861. Colorado City was the first capital, but was soon replaced by Golden, which was the capital from 1862 until 1868, when Denver was made the seat of government (in 1881 permanently, by vote of the people). In 1862 some Texas forces were defeated by Colorado forces in an attempt to occupy the territory for the Confederacy. From 1864 to 1870 there was trouble with the Cheyenne and Arapahoe Indians. A sanguinary attack on an Indian camp in Kiowa county in 1864 is known as the Sand Creek Massacre. In 1867 the Republican party had prepared for the admission of Colorado as a state, but the enabling act was vetoed by President Johnson, and statehood was not gained until 1876. Finally, under a congressional enabling act of the 3rd of March 1875, a constitution was framed by a convention at Denver (20th of December 1875 to 14th of March 1876) and adopted by the people on the 1st of July 1876. The admission of Colorado to the Union was thereupon proclaimed on the 1st of August 1876.

From this time on the history of the state was long largely that of her great mining camps. After 1890 industrial conditions were confused and temporarily set greatly backward by strikes and lockouts in the mines, particularly in 1894, 1896-1897 and 1903-1904, several times threatening civil war and necessitating the establishment of martial law. Questions of railways, of franchises, union scales and the recognition of the union in contracts, questions of sheep and cattle interests, politics, civic, legal and industrial questions, all entered into the economic troubles of these years. The Colorado "labour wars" were among the most important struggles between labour and capital, and afforded probably the most sensational episodes in the story of all labour troubles in the United States in these years. A state board of arbitration was created in 1896, but its usefulness was impaired by an opinion of the state attorney-general (in 1901) that it could not enforce subpoenas, compel testimony or enforce decisions. A law establishing an eight-hour day for underground miners and smelter employees (1899) was unanimously voided by the state supreme court, but in 1902 the people amended the constitution and ordered the general assembly to re-enact the law for labourers in mines, smelters and dangerous employments. Following the repeal of the Sherman Law and other acts and tendencies unfavourable to silver coinage in 1893 and thereafter, the silver question became the dominant issue in politics, resulting in the success of the Populist-Democratic fusion party in three successive elections, and permanently and greatly altering prior party organizations.

The governors of Colorado have been as follows:—

<i>Territorial.</i>			
W. Gilpin	1861	E. M. McCook	1869
J. Evans	1862	S. H. Elbert	1873
A. Cummings	1865	E. M. McCook	1874
A. C. Hunt.	1867	J. L. Routt.	1875
<i>State.</i>			
J. L. Routt	Republican	1876	
F. W. Pitkin	"	1879	
J. B. Grant	Democrat	1883	
B. H. Eaton	Republican	1885	
A. Adams	Democrat	1887	
J. A. Cooper	Republican	1890	
J. L. Routt	"	1891	
D. H. Waite	Populist	1893	
A. W. McIntire	Republican	1895	
A. Adams	Dem.-Populist	1897	
C. S. Thomas	"	1899	
J. B. Orman	"	1901	
J. H. Peabody	Republican	1903	
A. Adams	Democrat	1905 ¹	
Jesse F. M'Donald	Republican	1905 ¹	
Henry A. Buchtel	"	1907	
John H. Shafroth	Democrat	1909	

¹ Adams was inaugurated on the 10th of January, having been

AUTHORITIES.—For *topography and general description*: Hayden and assistants, reports on *Colorado*, U.S. Department of the Interior, Geological and Geographical Survey of the Territories (13 vols., 1867–1878), various reports, especially annual report for 1874; Captain J. C. Frémont, *Report of the Exploring Expedition to the Rocky Mountains in 1842*, published 1845 as Congressional document 28th Congress, 2nd Session, House Executive Document No. 166, and various other editions. Other early exploring reports are: *The Expeditions of Zebulon Montgomery Pike . . . Through Louisiana Territory and in New Spain in the Years 1805–6–7*, edited by E. Coues (3 vols., New York, 1895); *Account of an Expedition from Pittsburgh to the Rocky Mountains, 1819–20, under the Command of Major S. H. Long; compiled . . . by Edwin James* (3 vols., London; 2 vols., Philadelphia, 1823); Captain H. Stansbury, *Exploration of the Valley of the Great Salt Lake* (2 vols., Philadelphia, 1852; also as Senate Executive Document No. 3, 32nd Congress Special Session); Francis Parkman, *The California and Oregon Trail* (New York, 1849; revised ed., Boston, 1892),—a narrative of personal experience, as are the two following books: Bayard Taylor, *Colorado; A Summer Trip* (New York, 1867); Samuel Bowles, *The Switzerland of America, A Summer Vacation in Colorado* (Springfield, Mass., 1869); F. Fossett, *Colorado; A Historical, Descriptive and Statistical Work on the Rocky Mountain Gold and Silver Region* (Denver, 1878; New York, 1879, 2nd ed., 1880).

On *fauna and flora*: United States Biological Survey, *Bulletins* (especially No. 10), &c.; the *Biennial Report* of the State Game and Fish Commissioner; United States Geological Survey, *19th Annual Report*, pt. v., and 20th A.R., pt. 5, and various publications of the United States Forestry Division for forest and forest reserves; Porter and Coulter, *Synopsis of the Flora of Colorado* (1879); and scattered papers in scientific periodicals. On *climate*: United States Department of Agriculture, *Colorado Climate and Crop Service* (monthly). On *soil and agriculture*: *Annual Report* of the State Board of Agriculture (since 1878), of the State Agricultural College, Agricultural Experiment Station (since 1887), and of the State Board of Horticulture; *Biennial Report* of the State Board of Land Commissioners (since 1879); publications of the United States Department of Agriculture, various bulletins on agrostology, water supply and irrigation, &c. (See Department bibliographies); United States Census, 1900 (States), *Bulletin 177*, "Agriculture in Colorado" (Special), *Bulletin 16*, "Irrigation in the United States" (1902), &c.; United States Geological Survey, various materials, consult bibliographies in its *Bulletins 100, 177, 215, 301*, &c. On *manufactures*: publications of United States Census, 1900, and the special census of manufactures, 1905. On *mineral industries*: United States Geological Survey, *Annual Report*, annual volume on "Mineral Resources"; also the annual *Mineral Industry* (Rothwell's New York-London); Colorado State Bureau of Mines, *Biennial Report*, Inspector of Coal Mines, *Biennial Report* (since 1883–1884); and an enormous quantity of information in the publications of the United States Geological Survey. For labour troubles see below. On *railways*, see annual *Statistics of Railways* of the United States Interstate Commerce Commission, and Poor's Manual (Annual, New York). *Rivers*, see *Index to Reports of the Chief of Engineers*, United States Army (3 vols., 1900, covering 1866–1900); publications United States Geological Survey. On *population*: United States Census, 1900. *Administration*: J. W. Mills' *Annotated Statutes of the State of Colorado . . .* (2 vols., Denver, 1891; vol. iii. 1896); Helen L. Sumner, *Equal Suffrage in Colorado* (New York, 1909); J. E. Snook, *Colorado History and Government* (Denver, 1904), is a reliable school epitome.

On *history*: F. L. Paxson, "A Preliminary Bibliography of Colorado History," being vol. iii., No. 3, of *University of Colorado Studies* (June 1906); H. H. Bancroft, *History of . . . Nevada, Colorado and Wyoming, 1540–1888* (San Francisco, 1890); on *labour conditions and troubles* consult: *Reports* of the State Bureau of Labour Statistics (since 1892); *Annual Reports* of the State Board of Arbitration (since 1898); publications of United States Bureau of Labour (bibliographies); also especially Senate Document 122, 58th Congress, 3rd Session, covering the years 1880–1904. See also CRIPPLE CREEK and LEADVILLE.

COLORADO RIVER, a stream in the south of the Argentine Republic. It has its sources on the eastern slopes of the Andes in the lat. of the Chilean volcano Tinguiririca (about 34° 48' S.), and pursues a general E.S.E. course to the Atlantic, where it discharges through several channels of a delta extending from lat. 39° 30' to 39° 50' S. Its total length is about 620 m., of which about 200 m. from the coast up to Pichemahuida is navigable for vessels of 7 ft. draft. It has been usually described as being formed by the confluence of the Grande and Barrancas, elected on the return of the vote, which had been notoriously corrupted in Denver and elsewhere. The Republican legislature, after investigating the election and upon receiving from Peabody a written promise that he would resign in twenty-four hours, declared on the 16th of March that Peabody was elected. His resignation on the 17th of March made Lieutenant-Governor M'Donald governor of the state.

but as the latter is only a small stream compared with the Grande it is better described as a tributary, and the Grande as a part of the main river under another name. After leaving the vicinity of the Andes the Colorado flows through a barren, arid territory and receives no tributary of note except the Curaco, which has its sources in the Pampa territory and is considered to be part of the ancient outlet of the now closed lacustrine basin of southern Mendoza. The bottom lands of the Colorado in its course across Patagonia are fertile and wooded, but their area is too limited to support more than a small, scattered population.

COLORADO RIVER, a stream in the south-west of the United States of America, draining a part of the high and arid plateau between the Rocky mountains and the Sierra Nevada in California. The light rainfall scarcely suffices over much of the river's course to make good the loss by evaporation from the waters drained from mountain snows at its source. Its headwaters are known as the Green river, which rises in north-west Wyoming and after a course of some 700 m. due south unites in south-east Utah with the Grand river, flowing down from Colorado, to form the main trunk of the Colorado proper. The Green cuts its way through the Uinta mountains of Wyoming; then flowing intermittently in the open, it crosses successive uplifts in a series of deep gorges, and flows finally at the foot of canyon walls 1500 ft. high near its junction with the Grand.

The Colorado in its course below the junction has formed a region that is one of the most wonderful of the world, not only for its unique and magnificent scenery, but also because it affords the most remarkable example known of the work of differential weathering and erosion by wind and water and the exposure of geologic strata on an enormous scale. Above the Paria the river flows through scenery comparatively tame until it reaches the plateau of the Marble Canyon, some 60 m. in length. The walls here are at first only a few score of feet in height, but increase rapidly to almost 5000 ft. At its southern end is the Little Colorado. Above this point eleven rivers with steep mountain gradients have joined either the Green or the Grand or their united system. The Little Colorado has cut a trench 1800 ft. deep into the plateau in the last 27 m. as it approaches the Colorado, and empties into it 2625 ft. above the sea. Here the Colorado turns abruptly west directly athwart the folds and fault line of the plateau, through the Grand Canyon (*q.v.*) of the Colorado, which is 217 m. long and from 4 to 20 m. wide between the upper cliffs. The walls, 4000 to 6000 ft. high, drop in successive escarpments of 500 to 1600 ft., banded in splendid colours, toward the gloomy narrow gorge of the present river. Below the confluence of the Virgin river of Nevada the Colorado abruptly turns again, this time southward, and flows as the boundary between Arizona and California and in part between Arizona and Nevada, and then through Mexican territory, some 450 m. farther to the Gulf of California. Below the Black Canyon the river lessens in gradient, and in its lower course flows in a broad sedimentary valley—a distinct estuarine plain extending northward beyond Yuma—and the channel through much of this region is bedded in a dyke-like embankment lying above the flood-plain over which the escaping water spills in time of flood. This dyke cuts off the flow of the river to the remarkable low area in southern California known as the Salton Sink, or Coahuila Valley, the descent to which from the river near Yuma is very much greater than the fall in the actual river-bed from Yuma to the gulf. In the autumn of 1904, the diversion flow from the river into a canal heading in Mexican territory a few miles below Yuma, and intended for irrigation of California south of the Sink, escaped control, and the river, taking the canal as a new channel, recreated in California a great inland sea—to the bed of which it had frequently been turned formerly, for example, in 1884 and 1891—and for a time practically abandoned its former course through Mexican territory to the Gulf of California. But it was effectively dammed in the early part of 1907 and returned to its normal course, from which, however, there was still much leakage to Salton Sea; in July 1907 the permanent dam was completed. From the Black Canyon to the sea the Colorado normally flows through a desert-like basin,

to the west of which, in Mexico, is Laguna Maquata (or Salada), lying in the so-called Pattie Basin, which was formerly a part of the Gulf of California, and which is frequently partially flooded (like Coahuila Valley) by the delta waters of the Colorado. Of the total length of the Colorado, about 2200 m., 500 m. or more from the mouth are navigable by light steamers, but channel obstacles make all navigation difficult at low water, and impossible about half the year above Mojave. The whole area drained by the river and its tributaries is about 225,000 sq. m.; and it has been estimated by Major J. W. Powell that in its drainage basin there are fully 200,000 sq. m. that have been degraded on an average 6000 ft. It is still a powerful eroding stream in the canyon portion, and its course below the canyons has a shifting bed much obstructed by bars built of sediment carried from the upper course. The desert country toward the mouth is largely a sandy or gravelly aggradation plain of the river. The regular floods are in May and June. Others, due to rains, are rare. The rise of the water at such times is extraordinarily rapid. Enormous drift is left in the canyons 30 or 40 ft. above the normal level. The valley near Yuma is many miles wide, frequently inundated, and remarkably fertile; it is often called the "Nile of America" from its resemblance in climate, fertility, overflows and crops. These alluvial plains are covered with a dense growth of mesquite, cottonwood, willow, arrowwood, quelite and wild hemp. Irrigation is essential to regular agriculture. There is a fine delta in the gulf. The Colorado is remarkable for exceedingly high tides at its mouth and for destructive bores.

In 1540, the second year that Spaniards entered Arizona, they discovered the Colorado. Hernando de Alarcon co-operating with F. V. de Coronado, explored with ships the Gulf of California and sailed up the lower river; Melchior Diaz, marching along the shores of the gulf, likewise reached the river; and Captain García López de Cárdenas, marching from Zuñi, reached the Grand Canyon, but could not descend its walls. In 1604 Juan de Oñate crossed Arizona from New Mexico and descended the Santa Maria, Bill Williams and Colorado to the gulf. The name Colorado was first applied to the present Colorado Chiquito, and probably about 1630 to the Colorado of to-day. But up to 1869 great portions of the river were still unknown. James White, a miner, in 1867, told a picturesque story (not generally accepted as true) of making the passage of the Grand Canyon on the river. In 1869, and in later expeditions, the feat was accomplished by Major J. W. Powell. There have been since then repeated explorations and scientific studies.

See C. E. Dutton, "Tertiary History of the Grand Canyon," *U.S. Geological Survey, Monograph II.* (1882); J. W. Powell, *Exploration of the Colorado River* (Washington, 1875), and *Canyons of the Colorado* (Meadville, Pa. 1895); F. S. Dellenbaugh, *Romance of the Colorado River* (New York, 1902), and *Canyon Voyage* (1908); G. W. James, *Wonders of the Colorado Desert* (2 vols., Boston, 1906).

COLORADO SPRINGS, a city and the county-seat of El Paso county, Colorado, U.S.A., about 75 m. S. of Denver. Pop. (1890) 11,140; (1900) 21,085, of whom 2300 were foreign-born; (1910) 29,078. The city is served by the Atchison, Topeka & Santa Fé, the Denver & Rio Grande, the Chicago, Rock Island & Pacific (of which the city is a terminus), the Colorado & Southern, the Colorado Springs & Cripple Creek District (controlled by the Colorado & Southern), and the Colorado Midland railways, of which the first three are continental systems. Continuous on the west with Colorado Springs is Colorado City (pop. in 1900, 2914), one of the oldest settlements of Colorado, and the first capital (1861). Colorado Springs is superbly situated where the Rocky Mountains rise from the great plains of the prairie states, surrounded on all sides by foothills save in the south-east, where it is open to the prairie. To the south of the mesa (tableland) on which it lies is the valley of Fountain Creek. To the west is the grand background of the canyon-riven Rampart range, with Pike's Peak (*q.v.*) dominating a half-dozen other peaks (among them Cameron Cone, Mt. Rosa, Cheyenne Mt.) 9000 to 12,000 ft. in height. Monument Creek traverses the city. The streets are of generous width (100-140 ft.), and are well shaded by trees. There are several fine parks. The city is

the seat of a state asylum for the deaf, dumb and blind, of a printers' home for union men, which was endowed in 1892 by Anthony J. Drexel and George W. Childs, and of Colorado College (1874), one of the leading educational institutions of the Rocky Mountain states, and the oldest institution for higher education in the state. The college is coeducational and non-sectarian. In 1908 it had a permanent endowment of about \$425,000, a faculty of 46 and 607 students; the library contained 40,000 bound volumes and as many pamphlets. The departments of the institution are a college of arts; schools of engineering (1903), music, and (1906) forestry; and the Cutler Academy, a preparatory school under the control of the college. In 1905 Gen. W. J. Palmer (1836-1909) and W. A. Bell gave to the college Manitou Park, a tract of forest land covering about 13,000 acres and situated about 20 m. from Colorado Springs.

Bright sunshine and a pleasant climate (mean annual temperature about 48° F., rainfall 14 in., falling almost wholly from April to September, relative humidity 59), combined with beautiful scenery, have made the city a favourite health resort and place of residence. Land deeds for city property have always excluded saloons. The municipality owns and operates the water system, water being drawn from lakes near Pike's Peak. The scenery about the city is remarkable. Manitou (6100-6300 ft.) a popular summer resort, lies about 6 m. (by rail) north-west of Colorado Springs, in a glen at the opening of Ute Pass (so-named because it was formerly used by the Ute Indians), with the mountains rising from its edge. Its springs of soda and iron belong to the class of weak compound carbonated soda waters. In the neighbourhood are the Cave of the Winds, the Grand Caverns, charming glens, mountain lakes and picturesque canyons; and the Garden of the Gods (owned by the city)—approached between two tremendous masses of red rock 330 ft. high, and strewn (about 500 acres) with great rocks and ridges of brightly coloured sandstone, whose grotesque shapes and fantastic arrangement have suggested a playground of superhuman beings. At the southern end of the Rampart range is Cheyenne Mt. (9407 ft.), on whose slope was buried Helen Hunt Jackson ("H.H."), who has left many pictures of this country in her stories. The two Cheyenne Canyons, with walls as high as 1000 ft. and beautiful falls, and the road over the mountain side toward Cripple Creek, afford exquisite views. Monument Park (10 m. N.) is a tract of fantastically eroded sandstone rocks, similar to those in the Garden of the Gods.

In 1859 a winter mining party coming upon the sunny valley near the present Manitou, near the old Fontaine-qui-Bouille, settled "El Dorado." Colorado City is practically on the same site. In 1870, as part of the town development work of the Denver & Rio Grande railway, of which General W. J. Palmer was the president, a land company founded Colorado Springs. In 1872 Manitou (first La Fontaine) was founded. Colorado Springs was laid out in 1871, was incorporated in 1872, and was first chartered as a city in 1878. A new charter (May 1900) provided for the recall of elective officials. A road over the Ute Pass to South Park and Leadville was built, and at one time about 12,000 horses and mules were employed in freighting to the Leadville camps. The Chicago, Rock Island & Pacific railway reached the city in 1888. The greatest part of the Cripple Creek mining properties is owned in Colorado Springs, where the exchange is one of the greatest in the world.

COLOSSAE, once the great city of south-west Phrygia, was situated on rising ground (1150 ft.) on the left bank of the Lycus (*Churuk Su*), a tributary of the Maeander, at the upper end of a narrow gorge 2½ m. long, where the river runs between cliffs from 50 to 60 ft. high. It stood on the great trade route from Sardis to Celaenae and Iconium, and was a large, prosperous city (Herod. vii. 30; Xenophon, *Anab.* i. 2, §6), until it was ruined by the foundation of Laodicea in a more advantageous position. The town was celebrated for its wool, which was dyed a purple colour called *colossinus*. Colossae was the seat of an early Christian church, the result of St Paul's activity at Ephesus, though perhaps actually founded by Epaphras.

The church, to which St Paul wrote a letter, was mainly composed of mingled Greek and Phrygian elements deeply imbued with fantastic and fanatical mysticism. Colossae lasted until the 7th and 8th centuries, when it was gradually deserted under pressure of the Arab invasions. Its place was taken by Khonae (*Khonas*)—a strong fortress on a rugged spur of Mt. Kadmus, 3 m. to the south, which became a place of importance during the wars between the Byzantines and Turks, and was the birthplace of the historian, Nicetas Khoniates. The worship of angels alluded to by St Paul (Col. ii. 18), and condemned in the 4th century by a council at Laodicea, reappears in the later worship of St Michael, in whose honour a celebrated church, destroyed by the Seljuks in the 12th century, was built on the right bank of the Lycus.

See Sir W. M. Ramsay, *Cities and Bishoprics of Phrygia*, vol. i.

COLOSSAL CAVERN, a cave in Kentucky, U.S.A., the main entrance of which is at the foot of a steep hill beyond Eden Valley, and 1½ m. from Mammoth Cave. It is connected with what has long been known as the Bed Quilt Cave. Several entrances found by local explorers were rough and difficult. They were closed when the property was bought in 1896 by the Louisville & Nashville railway and a new approach made as indicated on the accompanying map. From the surface to the floor is 240 ft.; under Chester Sandstone and in the St Louis Limestone. Fossil corals fix the geological age of the rock. The temperature is uniformly 54° Fahr., and the atmosphere is optically and chemically pure. Lovely incrustations alternate with queer and grotesque figures. There are exquisite gypsum rosettes and intricately involved helictites.

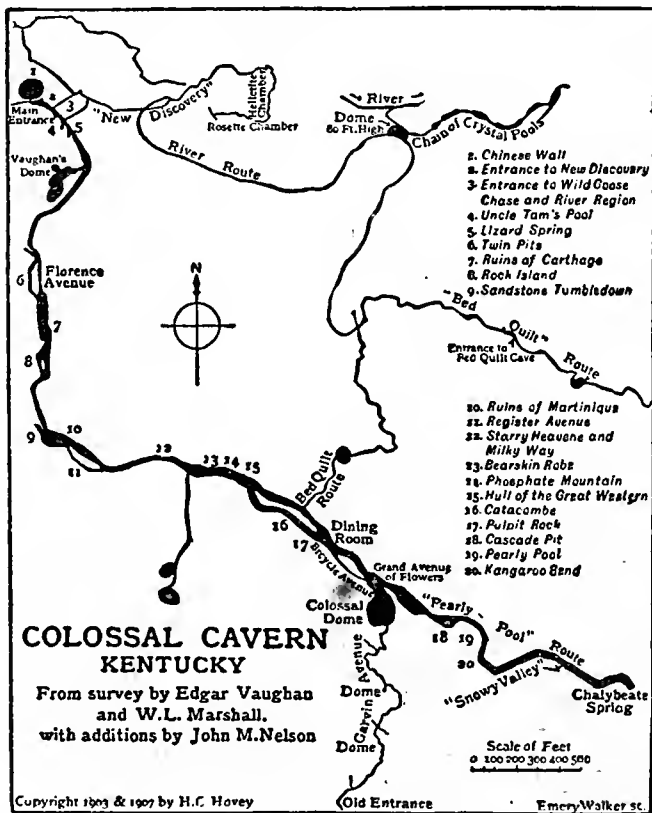

Tremendous forces have been at work, suggesting earthquakes and eruptions; but really all is due to the chemical and mechanical action of water. The so-called "Ruins of Carthage" fill a hall 400 ft. long by 100 ft. wide and 30 ft. high, whose flat roof is a vast homogeneous limestone block. Isolated detached blocks measure from 50 to 100 ft. in length. Edgar Vaughan and W. L. Marshall, civil engineers, surveyed every part of the cave. Vaughan's Dome is 40 ft. wide, 300 ft. long, and 79 ft. high. Numerous other domes exist, and many deep pits. The grandest place of all is the Colossal Dome, which used to be

entered only from the apex by windlass and a rope reaching 135 ft. to the floor. This is now used only for illumination by raising and lowering a fire-basket. The present entrance is by a gateway buttressed by alabaster shafts, one of which, 75 ft. high, is named Henry Clay's Monument. The dome walls arise in a series of richly tinted rings, each 8 or 10 ft. thick, and each fringed by stalactites. The symmetry is remarkable, and the reverberations are strangely musical. The Pearly Pool, in a chamber near a pit 86 ft. deep, glistens with countless cave pearls. The route beyond is between rows of stately shafts, and ends in a copious chalybeate spring. Blind flies, spiders, beetles and crickets abound; and now and then a blind crawfish darts through the waters; but as compared with many caverns the fauna and flora are not abundant. It is conjectured, not without some reason, that there is a connexion, as yet undiscovered, between the Colossal and the Mammoth caves. It seems certain that Eden Valley, which now lies between them, is a vast "tumble-down" of an immense cavern that formerly united them into one. (H. C. H.)

COLOSSIANS, EPISTLE TO THE, the twelfth book of the New Testament, the authorship of which is ascribed to the Apostle Paul. Colossae, like the other Phrygian cities of Laodicea and Hierapolis, had not been visited by Paul, but owed its belief in Jesus Christ to Epaphras, a Colossian, who had been converted by Paul, perhaps in Ephesus, and had laboured not only in his native city but also in the adjacent portions of the Lycus valley,—a Christian in whom Paul reposed the greatest confidence as one competent to interpret the gospel of whose truth Paul was convinced (i. 7; iv. 12, 13). This Epaphras, like the majority of the Colossians, was a Gentile. It is probable, however, both from the letter itself and from the fact that Colossae was a trade centre, that Jews were there with their synagogues (cf. also Josephus, *Ant.* xii. 149). And it is further probable that some of the Gentiles, who afterwards became Christians, were either Jewish proselytes or adherents who paid reverence to the God of the Jews. At all events, the letter indicates a sensitiveness on the part of the Christians not only to oriental mysticism and theosophy (cf. Sir W. M. Ramsay, *Cities and Bishoprics of Phrygia*, and *Church in the Roman Empire*), but also to the Judaism of the Diaspora.

Our first definite knowledge of the Colossian Church dates from the presence of Epaphras in Rome in A.D. 62-64 (or A.D. 56-58), when Paul was a prisoner. He arrived with news, perhaps with a letter (J. R. Harris, *Expositor*, Dec. 1898, pp. 404 ff.), touching the state of religion in Colossae. Paul learns, to his joy, of their faith, hope and love; of the order and stability of their faith; and of their reception of Christ Jesus the Lord (i. 4, 8; ii. 5-7). He sees no sign of an attack upon him or his gospel. On the contrary, loyalty to him and sympathy with him in his sufferings are everywhere manifest (i. 9, 24; ii. 2; iv. 8); and the gospel of Christ is advancing here as elsewhere (i. 6). At the same time he detects a lack of cheerfulness and a lack of spiritual understanding in the Church. The joy of the gospel, expressing itself in songs and thanksgivings, is damped (iii. 15, 16), and, above all, the message of Christ does not dwell richly enough in them. Though the believers know the grace of God they are not filled with a knowledge of his will, so that their conduct is lacking in that strength and joy and perfection, that richness of the fulness of knowledge expected of those who had been made full in Christ (i. 6, 9-11, 28; ii. 2, 7, 10). The reason for this, Paul sees, is the influence of the claim made by certain teachers in Colossae that the Christians, in order to attain unto and be assured of full salvation, must supplement Paul's message with their own fuller and more perfect wisdom, and must observe certain rites and practices (ii. 16, 21, 23) connected with the worship of angels (ii. 18, 23) and elementary spirits (ii. 8, 20).

The origin and the exact nature of this religious movement are alike uncertain. (1) If it represents a type of syncretism as definite as that known to have existed in the developed gnostic systems of the 2nd century, it is inconceivable that Paul should have passed it by as easily as he did. (2) As there is no reference

to celibacy, communism and the worship of the sun, it is improbable that the movement is identical with that of the Essenes. (3) The phenomena might be explained solely on the basis of Judaism (von Soden, Peake). Certainly the asceticism and ritualism might so be interpreted, for there was among the Jews of the Dispersion an increasing tendency to asceticism, by way of protest against the excesses of the Gentiles. The reference in ii. 23 to severity of the body may have to do with fasting preparatory to seeing visions (cf. *Apoc. Baruch*, xxi. 1, ix. 2, v. 7). Even the worship of angels, not only as mediators of revelation and visions, but also as cosmical beings, is a well-known fact in late Judaism (*Apoc. Bar.* lv. 3; *Ethiopic Enoch*, lx. 11, lxi. 10; Col. ii. 8, 20; Gal. iv. 3). As for the word "philosophy" (ii. 8), it is not necessary to take it in the technical Greek sense when the usage of Philo and Josephus permits a looser meaning. Finally the references to circumcision, *paradosis* (ii. 8) and *dogmata* (ii. 20), directly suggest a Jewish origin. If we resort solely to Judaism for explanation, it must be a Judaism of the Diaspora type. (4) The difficulty with the last-mentioned position is that it under-estimates the speculative tendencies of the errorists and ignores the direct influence of oriental theosophy. It is quite true that Paul does not directly attack the speculative position, but rather indicates the practical dangers inherent therein (the denial of the supremacy of Christ and of full salvation through Him); he does not say that the errorists hold Christ to be a mere angel or an aeon, or that words like *pleroma* (borrowed perhaps from their own vocabulary) involve a rigorous dualism. Yet his characterization of the movement as an arbitrary religion (ii. 23), a philosophy which is empty deceit (ii. 8), according to elemental spirits and not according to Christ, and a higher knowledge due to a mind controlled by the flesh (ii. 18); his repeated emphasis on Christ, as supreme over all things, over men and angels, agent in creation as well as in redemption, in whom dwelt bodily the fulness of the Godhead; and his constant stress upon knowledge,—all these combine to reveal a speculation real and dangerous, even if naïve and regardless of consequences, and to suggest (with Jülicher and McGiffert) that in addition to Jewish influence there is also the direct influence of Oriental mysticism.

To meet the pressing need in Colossae, Paul writes a letter and entrusts it to Tychichus, who is on his way to Colossae with Onesimus, Philemon's slave (iv. 7, 9). (On the relation of this letter to Ephesians and to the letter to be sent from Laodicea to Colossae, see **EPHESIANS, EPISTLE TO THE.**) His attitude is prophylactic, rather than polemic, for the "philosophy" has not as yet taken deep root. His purpose is to restore in the hearts of the readers the joy of the Spirit, by making them see that Christ fulfils every need, and that through faith in Him and love from faith, the advance is made unimpeded unto the perfect man. He will eliminate foreign accretions, that the gospel of Christ may stand forth in its native purity, and that Christ Himself may in all things have the pre-eminence.

The letter begins with a thanksgiving to God for the spiritual growth of the Colossians, and continues with a prayer for their fuller knowledge of the divine will, for a more perfect Christian life, and for a spirit of thanksgiving, seeing that it is God who guarantees their salvation in Christ (i. 1-14). It is Christ who is supreme, not angels, for He is the agent in creation; and it is solely on the basis of faith in Him, a faith expressing itself in love, that redemption is appropriated, and not on the basis of any further requirements such as ascetic practices and the worship of angels (i. 15-23). It is with a full message that Paul has been entrusted, the message of Christ, who alone can lead to all the riches of fulness of knowledge. And for this adequate knowledge the readers should be thankful (i. 23-ii. 7). Again he urges, that since redemption is in Christ alone, and that, too, full redemption and on the basis of faith alone, the demand for asceticism and meaningless ceremonies is folly, and moreover robs Christ, in whom dwells the divine fulness, of His rightful supremacy (ii. 8-23). And he exhorts them as members of the Body of Christ to manifest their faith in Christian love, particularly in their domestic relations and in their contact with non-

Christians (iii. 1-iv. 6). He closes by saying that Tychichus will give them the news. Greetings from all to all (iv. 7-18).

A letter like this, clear cut in its thought, teeming with ideas emanating from an unique religious experience, and admirably adjusted to known situations, bears on the face of it the marks of genuineness even without recourse to the unusually excellent external attestation. It is not strange that there is a growing consensus of opinion that Paul is the author. With the critical renaissance of the early part of the 19th century, doubts were raised as to the genuineness of the letter (e.g. by E. T. Mayerhoff, 1838). Quite apart from the difficulties created by the Tübingen theory, legitimate difficulties were found in the style of the letter, in the speculation of the errorists, and in the theology of the author. (1) As to style, it is replied that if there are peculiarities in *Colossians*, so also in the admittedly genuine letters, *Romans*, *Corinthians*, *Galatians*. Moreover, if *Philippians* is Pauline, so also the stylistically similar *Colossians* (cf. von Soden). (2) As to the speculation of the errorists, it is replied that it is explicable in the lifetime of Paul, that some of the elements of it may have their source in pre-Christian Jewish theories, and that recourse to the developed gnosticism of the 2nd century is unnecessary. (3) As to the Christology of the author, it is replied that it does not go beyond what we have already in Paul except in emphasis, which itself is occasioned by the circumstances. What is implicit in *Corinthians* is explicit in *Colossians*. H. J. Holtzmann (1872) subjected both *Colossians* and *Ephesians* to a rigorous examination, and found in *Colossians* at least a nucleus of Pauline material. H. von Soden (1883), with well-considered principles of criticism, made a similar examination and found a much larger nucleus, and later still, (1893), in his commentary, reduced the non-Pauline material to a negligible minimum. Harnack, Jülicher and McGiffert, however, agree with Lightfoot, Weiss, Zahn (and early tradition) in holding that the letter is wholly Pauline—a position which is proving more and more acceptable to contemporary scholarship.

AUTHORITIES.—In addition to the literature already mentioned, see the articles of Sanday on "Colossians" and Robertson on "Ephesians" in *Smith's Bible Dictionary* (2nd ed., 1893), and the article of A. Jülicher on "Colossians and Ephesians" in the *Encyclopaedia Biblica* (1899); the Introductions of H. J. Holtzmann (1892), B. Weiss (1897), Th. Zahn (1900) and Jülicher (1906); the histories of the apostolic age by C. von Weizsäcker (1892), A. C. McGiffert (1897) and O. Pfleiderer (*Urchristentum*, 1902); and the commentaries of J. B. Lightfoot (1875), H. von Soden (1893), T. K. Abbott (1897), E. Haupt (1902), Peake (1903) and P. Ewald (1905).

COLOSSUS, in antiquity a term applied generally to statues of great size (hence the adjective "colossal"), and in particular to the bronze statue of the sun-god Helios in Rhodes, one of the wonders of the world, made from the spoils left by Demetrius Poliorcetes when he raised the siege of the city. The sculptor was Chares, a native of Lindus, and of the school of Lysippus, under whose influence the art of sculpture was led to the production of colossal figures by preference. The work occupied him twelve years, it is said, and the finished statue stood 70 cubits high. It stood near the harbour (*ἐπὶ λιμένι*), but at what point is not certain. When, and from what grounds, the belief arose that it had stood across the entrance to the harbour, with a beacon light in its hand and ships passing between its legs, is not known, but the belief was current as early as the 16th century. The statue was thrown down by an earthquake about the year 224 B.C.; then, after lying broken for nearly 1000 years, the pieces were bought by a Jew from the Saracens, and probably reconverted into instruments of war.

Other Greek colossi were the Apollo of Calamis; the Zeus and Heracles of Lysippus; the Zeus at Olympia, the Athena in the Parthenon, and the Athena Promachos on the Acropolis—all the work of Pheidias.

The best-known Roman colossi are: a statue of Jupiter on the Capitol; a bronze statue of Apollo in the Palatine library; and the colossus of Nero in the vestibule of his Golden House, afterwards removed by Hadrian to the north of the Colosseum, where the basement upon which it stood is still visible (*Pliny, Nat. Hist.* xxxiv. 18).

COLOUR (Lat. *color*, connected with *celare*, to hide, the root meaning, therefore, being that of a covering). The visual apparatus of the eye enables us to distinguish not only differences of form, size and brilliancy in the objects looked upon, but also differences in the character of the light received from them. These latter differences, familiar to us as differences in *colour*, have their physical origin in the variations in wave-length (or frequency) which may exist in light which is capable of exciting the sensation of vision. From the physical point of view, light of a *pure colour*, or homogeneous light, means light whose undulations are mathematically of a simple character and which cannot be resolved by a prism into component parts. All the visible pure colours, as thus defined, are to be found in the spectrum, and there is an infinite number of them, corresponding to all the possible variations of wave-length within the limits of the visible spectrum (see SPECTROSCOPY). On this view, there is a strict analogy between variations of *colour* in light and variations of *pitch* in sound, but the visible spectrum contains a range of frequency extending over about one octave only, whereas the range of audibility embraces about eleven octaves.

Of all the known colours it might naturally be thought that white is the simplest and purest, and, till Sir Isaac Newton's time, this was the prevailing opinion. Newton, however, showed that white light could be decomposed by a prism into the spectral colours red, orange, yellow, green, blue, indigo and violet; the colours appearing in this order and passing gradually into each other without abrupt transitions. White is therefore not a simple colour, but is merely the colour of sunlight, and probably owes its apparently homogeneous character to the fact that it is the average colour of the light which fills the eye when at rest. The colours of the various objects which we see around us are not due (with the exception of self-luminous and fluorescent bodies) to any power possessed by these objects of creating the colours which they exhibit, but merely to the exercise of a selective action on the light of the sun, some of the constituent rays of the white light with which they are illuminated being absorbed, while the rest are reflected or scattered in all directions, or, in the case of transparent bodies, transmitted. White light is thus the basis of all other colours, which are derived from it by the suppression of some one or more of its parts. A red flower, for instance, absorbs the blue and green rays and most of the yellow, while the red rays and usually some yellow are scattered. If a red poppy is illuminated successively by red, yellow, green and blue light it will appear a brilliant red in the red light, yellow in the yellow light, but less brilliant if the red colour is pure; and black in the other colours, the blackness being due to the almost complete absorption of the corresponding colour.

Bodies may be classified as regards colour according to the nature of the action they exert on white light. In the case of ordinary opaque bodies a certain proportion of the incident light is irregularly reflected or scattered from their surfaces. A white object is one which reflects nearly all the light of all colours; a black object absorbs nearly all. A body which reflects only a portion of the light, but which exhibits no predominance in any particular hue, is called *grey*. A white surface looks grey beside a similar surface more brilliantly illuminated.

The next class is that of most transparent bodies, which owe their colour to the light which is transmitted, either directly through, or reflected back again at the farther surface. A body which transmits all the visible rays equally well is said to be colourless; pure water, for example, is nearly quite colourless, though in large masses it appears bluish-green. A translucent substance is one which partially transmits light. Translucency is due to the light being scattered by minute embedded particles or minute irregularities of structure. Some fibrous specimens of tremolite and gypsum are translucent in the direction of the fibres, and practically opaque in a transverse direction. Coloured transparent objects vary in shade and hue according to their size; thus, a conical glass filled with a red liquid commonly appears yellow at the bottom, varying through orange up to red at the upper part. A coloured powder is usually of a much

lighter tint than the substance in bulk, as the light is reflected back after transmission through only a few thin layers. For the same reason the powders of transparent substances are opaque.

Polished bodies, whether opaque or transparent, when illuminated with white light and viewed at the proper angle, reflect the incident light regularly and appear white, without showing much of their distinctive colours.

Some bodies reflect light of one colour and transmit that of another; such bodies nearly always possess the properties of *selective or metallic reflection* and *anomalous dispersion*. Most of the coal-tar dyes belong to this category. Solid eosin, for example, reflects a yellowish-green and transmits a red light. Gold appears yellow under ordinary circumstances, but if the light is reflected many times from the surface it appears a ruby colour. On the other hand, a powerful beam of light transmitted through a thin gold-leaf appears green.

Some solutions exhibit the curious phenomenon of *dichromatism* (from *δι-*, double, and *χρῶμα*, colour), that is, they appear of one colour when viewed in strata of moderate thickness, but of a different colour in greater thicknesses (see ABSORPTION OF LIGHT).

The blue colour of the sky (*q.v.*) has been explained by Lord Rayleigh as due to the scattering of light by small suspended particles and air molecules, which is most effective in the case of the shorter waves (blue). J. Tyndall produced similar effects in the laboratory. The green colour of sea-water near the shore is also due to a scattering of light.

The colours of bodies which are gradually heated to white incandescence occur in the order—red, orange, yellow, white. This is because the longer waves of red light are first emitted, then the yellow as well, so that orange results, then so much green that the total effect is yellow, and lastly all the colours, compounding to produce white. Fluorescent bodies have the power of converting light of one colour into that of another (see FLUORESCENCE).

Besides the foregoing kinds of colorization, a body may exhibit, under certain circumstances, a colouring due to some special physical conditions rather than to the specific properties of the material; such as the colour of a white object when illuminated by light of some particular colour; the colours seen in a film of oil on water or in mother-of-pearl, or soap-bubbles, due to interference (*q.v.*); the colours seen through the eyelashes or through a thin handkerchief held up to the light, due to diffraction (*q.v.*); and the colours caused by ordinary refraction, as in the rainbow, double refraction and polarization (*qq.v.*).

Composition of Colours.—It has been already pointed out that white light is a combination of all the colours in the spectrum. This was shown by Newton, who recombined the spectral colours and produced white. Newton also remarks that if a froth be made on the surface of water thickened a little with soap, and examined closely, it will be seen to be coloured with all the colours of the spectrum, but at a little distance it looks white owing to the combined effect on the eye of all the colours.

The question of the composition of colours is largely a physiological one, since it is possible, by mixing colours, say red and yellow, to produce a new colour, orange, which appears identical with the pure orange of the spectrum, but is physically quite different, since it can be resolved by a prism into red and yellow again. There is no doubt that the sensation of colour-vision is threefold, in the sense that any colour can be produced by the combination, in proper proportions, of three standard colours. The question then arises, what are the three primary colours? Sir David Brewster considered that they were red, yellow and blue; and this view has been commonly held by painters and others, since all the known brilliant hues can be derived from the admixture of red, yellow and blue pigments. For instance, vermilion and chrome yellow will give an orange, chrome yellow and ultramarine a green, and vermilion and ultramarine a purple mixture. But if we superpose the pure spectral colours on a screen, the resulting colours are quite

different. This is especially the case with yellow and blue, which on the screen combine to produce white, generally with a pink tint, but cannot be made to give green. The reason of this difference in the two results is that in the former case we do not get a true combination of the colours at all. When the mixed pigments are illuminated by white light, the yellow particles absorb the red and blue rays, but reflect the yellow along with a good deal of the neighbouring green and orange. The blue particles, on the other hand, absorb the red, orange and yellow, but reflect the blue and a good deal of green and violet. As much of the light is affected by several particles, most of the rays are absorbed except green, which is reflected by both pigments. Thus, the colour of the mixture is not a mixture of the colours yellow and blue, but the remainder of white light after the yellow and blue pigments have absorbed all they can. The effect can also be seen in coloured solutions. If two equal beams of white light are transmitted respectively through a yellow solution of potassium bichromate and a blue solution of copper sulphate in proper thicknesses, they can be compounded on a screen to an approximately white colour; but a single beam transmitted through both solutions appears green. Blue and yellow pigments would produce the effect of white only if very sparsely distributed. This fact is made use of in laundries, where cobalt blue is used to correct the yellow colour of linen after washing.

Thomas Young suggested red, green and violet as the primary colours, but the subsequent experiments of J. Clerk Maxwell appear to show that they should be red, green and blue. Sir William Abney, however, assigns somewhat different places in the spectrum to the primary colours, and, like Young, considers that they should be red, green and violet. All other hues can be obtained by combining the three primaries in proper proportions. Yellow is derived from red and green. This can be done by superposition on a screen or by making a solution which will transmit only red and green rays. For this purpose Lord Rayleigh recommends a mixture of solutions of blue litmus and yellow potassium chromate. The litmus stops the yellow and orange light, while the potassium chromate stops the blue and violet. Thus only red and green are transmitted, and the result is a full compound yellow which resembles the simple yellow of the spectrum in appearance, but is resolved into red and green by a prism. The brightest yellow pigments are those which give both the pure and compound yellow. Since red and green produce yellow, and yellow and blue produce white, it follows that red, green and blue can be compounded into white. H. von Helmholtz has shown that the only pair of simple spectral colours capable of compounding to white are a greenish-yellow and blue.

Just as musical sounds differ in pitch, loudness and quality, so may colours differ in three respects, which Maxwell calls *hue, shade and tint*. All hues can be produced by combining every pair of primaries in every proportion. The addition of white alters the tint without affecting the hue. If the colour be darkened by adding black or by diminishing the illumination,

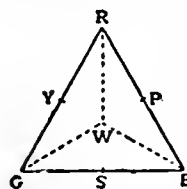

FIG. 1.

a variation in shade is produced. Thus the hue red includes every variation in tint from red to white, and every variation in shade from red to black, and similarly for other hues. We can represent every hue and tint on a diagram in a manner proposed by Young, following a very similar suggestion of Newton's. Let RGB (fig. 1) be an equilateral triangle, and let the angular

points be coloured red, green and blue of such intensities as to produce white if equally combined; and let the colour of every point of the triangle be determined by combining such proportions of the three primaries, that three weights in the same proportion would have their centre of gravity at the point. Then the centre of the triangle will be a neutral tint, white or grey; and the middle points of the sides Y, S, P will be yellow, greenish-blue and purple. The hue varies all round the perimeter. The tint varies along any straight line

through W. To vary the shade, the whole triangle must be uniformly darkened.

The simplest way of compounding colours is by means of Maxwell's colour top, which is a broad spinning-top over the spindle of which coloured disks can be slipped (fig. 2). The disks are slit radially so that they can be slipped partially over each other and the surfaces exposed in any desired ratio. Three disks are used together, and a match is obtained between these and a pair of smaller ones mounted on the same spindle. If any five colours are taken, two of which may be black and white, a match can be got between them by suitable adjustment. This shows that a relation exists between any four colours (the black being only needed to obtain the proper intensity) and that consequently the number of independent colours is three. A still better instrument for combining colours is Maxwell's colour box, in which the colours of the spectrum are combined by means of prisms. Sir W. Abney has also invented an apparatus for the same purpose, which is much the same in principle as Maxwell's colour box. Several methods of colour photography depend on the fact that all varieties of colour can be compounded from red, green and blue in proper proportions.

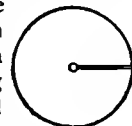
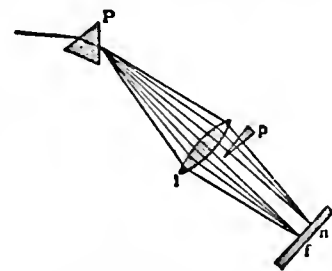

FIG. 2.

Any two colours which together give white are called *complementary colours*. Greenish-yellow and blue are a pair of complementaries, as already mentioned. Any number of pairs may be obtained by a simple device due to Helmholtz and represented in fig. 3. A beam of white light, decomposed by the prism P, is recomposed into white light by the lens l and focussed on a screen at f. If the thin prism p is inserted near the lens, any set of colours may be deflected to another point n, thus producing two coloured and complementary images of the source of light.



(After Müller-Pouillet's *Lehrbuch der Physik*, 1897.)

FIG. 3.

Nature of White Light.—The question as to whether white light actually consists of trains of waves of regular frequency has been discussed in recent years by A. Schuster, Lord Rayleigh and others, and it has been shown that even if it consisted of a succession of somewhat irregular impulses, it would still be resolved, by the dispersive property of a prism or grating, into trains of regular frequency. We may still, however, speak of white light as compounded of the rays of the spectrum, provided we mean only that the two systems are mathematically equivalent, and not that the homogeneous trains exist as such in the original light.

See also Newton's *Opticks*, bk. i. pt. ii.; Maxwell's *Scientific Papers*; Helmholtz's papers in *Poggendorf's Annalen*; Sir G. G. Stokes, *Burnett Lectures for 1884-5-6*; Abney's *Colour Vision* (1895).

COLOURS, MILITARY, the flags carried by infantry regiments and battalions, sometimes also by troops of other arms. Cavalry regiments and other units have as a rule standards and guidons (see **FLAG**). Colours are generally embroidered with mottoes, symbols, and above all with the names of battles.

From the earliest time at which men fought in organized bodies of troops, the latter have possessed some sort of insignia visible over all the field of battle, and serving as a rallying-point for the men of the corps and an indication of position for the higher leaders and the men of other formed bodies. In the Roman army the eagle, the *rexillum*, &c. had all the moral and sentimental importance of the colours of to-day. During the dark and the middle ages, however, the basis of military force being the individual knight or lord, the banner, or other flag bearing his arms, replaced the regimental colour which had signified the corporate body and claimed the devotion of each individual soldier in the ranks, though the original meaning of the

colour as a corps, not a personal distinction, was sometimes maintained by corporate bodies (such as trade-gilds) which took the field as such. An example is the famous *carroccio* or standard on wheels, which was frequently brought into the field of battle by the citizen militia of the Italian cities, and was fought for with the same ardour as the royal standard in other medieval battles.

The application of the word "colour" to such insignia, however, dates only from the 16th century. It has been suggested that, as the professional captain gradually ousted the nobleman from the command of the drilled and organized companies of foot—the man of gentle birth, of course, maintained his ascendancy in the cavalry far longer—the leaders of such bodies, no longer possessing coat-armour and individual banners, had recourse to small flags of distinctive colour instead. "Colour" is in the 16th century a common name in England and middle Europe for the unit of infantry; in German the *Fähnlein* (colour) of landsknechts was a strong company of more than 300 foot. The ceremonial observances and honours paid nowadays to the colours of infantry were in fact founded for the most part by the landsknechts, for whom the flag (carried by their "ensign") was symbolical of their intense regimental life and feeling. The now universal customs of constituting the colour guard of picked men and of saluting the colours were in equal honour then; before that indeed, the appearance of the personal banner of a nobleman implied his actual presence with it, and the due honours were paid, but the colour of the 16th century was not the distinction of one man, but the symbol of the corporate life and unity of the regiment, and thus the new colour ceremonial implied the same allegiance to an impersonal regimental spirit, which it has (with the difference that the national spirit has been blended with the regimental) retained ever since. The old soldier rallied to the colours as a matter of habit in the confusion of battle, and the capture or the loss of a colour has always been considered a special event, glorious or the reverse, in the history of a regiment, the importance of this being chiefly sentimental, but having as a very real background the fact that, if its colour was lost, a regiment was to all intents and purposes dissolved and dispersed. Frederick the Great and Napoleon always attached the highest importance to the maintenance at all costs of the regimental colours. Even over young troops the influence of the colour has been extraordinary, and many generals have steadied their men in the heat of battle by taking a regimental colour themselves to lead the advance or to form up the troops. Thus in the first battle of Bull Run (1861) the raw Confederate troops were rallied under a heavy fire by General Joseph Johnston, their commander-in-chief, who stood with a colour in his hand until the men gathered quickly in rank and file. The archduke Charles at Aspern (1806) led his young troops to the last assault with a colour in his hand. Marshal Schwerin was killed at the battle of Prague while carrying a regimental colour.

In the British army colours are carried by guards and line (except rifle) battalions, each battalion having two colours, the king's and the regimental. The size of the colour is 3 ft. 9 in. by 3 ft., and the length of the stave 8 ft. 7 in. The colour has a gold fringe and gold and crimson tassels, and bears various devices and "battle honours." Both colours are carried by subaltern officers, and an escort of selected non-commissioned officers forms the rest of the colour party. The ceremony of presenting new colours is most impressive. The old colours are "trooped" (see below) before being cased and taken to the rear. The new colours are then placed against a pile of drums and then uncased by the senior majors and the senior subalterns. The consecration follows, after which the colours are presented to the senior subalterns. The battalion gives a general salute when the colours are unfurled, and the ceremony concludes with a march past. "Trooping the colour" is a more elaborate ceremonial peculiar to the British service, and is said to have been invented by the duke of Cumberland. In this, the colour is posted near the left of the line, the right company or guard moves up to it, and an officer receives it, after which the guard with the colour files between the ranks of the remainder from left to right until the right of the line is reached.

In the United States army the infantry regiment has two colours, the national and the regimental. They are carried in action.

In the French army one colour (*drapcau*) is carried by each infantry regiment. It is carried by an officer, usually a *sous-lieutenant*, and the guard is composed of a non-commissioned officer and a party of "first class" soldiers. Regiments which have taken an enemy's colour or standard in battle have their own colours "decorated," that is, the cross of the Legion of Honour is affixed to the stave near the point. Battle honours are embroidered on the white of the tricolour. The *cagle* was, in the First and Third Empires, the infantry colour, and was so called from the gilt eagle which surmounted the stave. The *chasscurs à pied*, like the rifles of the British army, carry no colours, but the battalion quartered for the time being at Vincennes carries a colour for the whole arm in memory of the first *chasscurs de Vincennes*. As in other countries, colours are saluted by all armed bodies and by individual officers and men. When the *drapcau* is not present with the regiment its place is taken by an ordinary flag.

The colours of the German infantry, foot artillery and engineers vary in design with the states to which the corps belong in the first instance; thus, black and white predominate in Prussian colours, red in those of Württemberg regiments, blue in Bavarian, and so on. The point of the colour stave is decorated in some cases with the iron cross, in memory of the War of Liberation and of the war of 1870. Each battalion of an infantry regiment has its own colour, which is carried by a non-commissioned officer, and guarded as usual by a colour party. The colour is fastened to the stave by silver nails, and the ceremony of driving the first nail into the stake of a new colour is one of great solemnity. Rings of silver on the stave are engraved with battle honours, the names of those who have fallen in action when carrying the colour, and other commemorative names and dates. The oath taken by each recruit on joining is sworn on the colour (*Fahnneid*).

The practice in the British army of leaving the colours behind on taking the field dates from the battle of Isandhlwana (22nd January 1879), in which Lieutenants Melvill and Coghill lost their lives in endeavouring to save the colours of the 24th regiment. In savage warfare, in which the British regular army is more usually engaged, it is true that no particular reason can be adduced for imperilling the colours in the field. It is questionable, however, whether this holds good in civilized warfare. Colours were carried in action by both the Russians and the Japanese in the war of 1904-5, and they were supplemented on both sides by smaller flags or camp colours. The conception of the colour as the emblem of union, the rallying-point, of the regiment has been mentioned above. Many hold that such a rallying-point is more than ever required in the modern *guerre de masses*, when a national short-service army is collected in all possible strength on the decisive battle-field, and that scarcely any risks or loss of life would be disproportionate to the advantages gained by the presence of the colours. There is further a most important factor in the problem, which has only arisen in recent years through modern perfection in armament. In the first stages of an attack, the colours could remain, as in the past, with the closed reserves or line of battle, and they would not be uncased and sent into the thick of the fight at all hazards until the decisive assault was being delivered. Then, it is absolutely essential, as a matter of tactics, that the artillery (*q.v.*), which covers the assault with all the power given it by modern science and training, should be well informed as to the progress of the infantry. This covering fire was maintained by the Japanese until the infantry was actually in the smoke of their own shrapnel. With uniforms of neutral tint the need of some means whereby the artillery officers can, at 4000 yds. range, distinguish their own infantry from that of the enemy, is more pronounced than ever. The best troops are apt to be unsteadied by being fired into by their own guns (e.g. at Elandslaagte), and the more powerful the shell, and the more rapid and far-ranging the fire of the guns, the more necessary it

becomes to prevent such accidents. A practicable solution of the difficulty would be to display the colours as of old, and this course would not only have to an enhanced degree the advantages it formerly possessed, but would also provide the simplest means for ensuring the vitally necessary co-operation of infantry and artillery in the decisive assault. The duty of carrying the colours was always one of special danger, and sometimes, in the old short-range battles, every officer who carried a flag was shot. That this fate would necessarily overtake the bearer under modern conditions is far from certain, and in any case the few men on the enemy's side who would be brave enough to shoot accurately under heavy shell fire would, however destructive to the colour party, scarcely inflict as much damage on the battalion as a whole, as a dozen or more accidental shells from the massed artillery of its own side.

COLOUR-SERGEANT, a non-commissioned officer of infantry, ranking, in the British army, as the senior non-commissioned officer of each company. He is charged with many administrative duties, and usually acts as pay sergeant. A special duty of the colour-sergeants of a battalion is that of attending and guarding the colours and the officers carrying them. In some foreign armies the colours are actually carried by colour-sergeants. The rank was created in the British army in 1813.

COLOURS OF ANIMALS. Much interest attaches in modern biology to the questions involved in the colours of animals. The subject may best be considered in two divisions: (1) as regards the uses of colour in the struggle for existence and in sexual relationships; (2) as regards the chemical causation.

I. BIONOMICS

Use of Colour for Concealment.—*Cryptic colouring* is by far the commonest use of colour in the struggle for existence. It is employed for the purpose of attack (*aggressive resemblance* or *anticryptic colouring*) as well as of defence (*protective resemblance* or *procryptic colouring*). The fact that the same method, concealment, may be used both for attack and defence has been well explained by T. Belt (*The Naturalist in Nicaragua*, London, 1888), who suggests as an illustration the rapidity of movement which is also made use of by both pursuer and pursued, which is similarly raised to a maximum in both by the gradual dying out of the slowest through a series of generations. Cryptic colouring is commonly associated with other aids in the struggle for life. Thus well-concealed mammals and birds, when discovered, will generally endeavour to escape by speed, and will often attempt to defend themselves actively. On the other hand, small animals which have no means of active defence, such as large numbers of insects, frequently depend upon concealment alone. Protective resemblance is far commoner among animals than aggressive resemblance, in correspondence with the fact that predaceous forms are as a rule much larger and much less numerous than their prey. In the case of insectivorous Vertebrata and their prey such differences exist in an exaggerated form. Cryptic colouring, whether used for defence or attack, may be either *general* or *special*. In *general resemblance* the animal, in consequence of its colouring, produces the same effect as its environment, but the conditions do not require any special adaptation of shape and outline. General resemblance is especially common among the animals inhabiting some uniformly coloured expanse of the earth's surface, such as an ocean or a desert. In the former, animals of all shapes are frequently protected by their transparent blue colour; on the latter, equally diverse forms are defended by their sandy appearance. The effect of a uniform appearance may be produced by a combination of tints in startling contrast. Thus the black and white stripes of the zebra blend together at a little distance, and "their proportion is such as exactly to match the pale tint which arid ground possesses when seen by moonlight" (F. Galton, *South Africa*, London, 1889). *Special resemblance* is far commoner than general, and is the form which is usually met with on the diversified surface of the earth, on the shores, and in shallow water, as well as on the floating masses of Algae on the surface of the ocean, such as the Sargasso Sea. In these environments

the cryptic colouring of animals is usually aided by special modifications of shape, and by the instinct which leads them to assume particular attitudes. Complete stillness and the assumption of a certain attitude play an essential part in general resemblance on land; but in special resemblance the attitude is often highly specialized, and perhaps more important than any other element in the complex method by which concealment is effected. In special resemblance the combination of colouring, shape and attitude is such as to produce a more or less exact resemblance to some one of the objects in the environment, such as a leaf or twig, a patch of lichen, or flake of bark. In all cases the resemblance is to some object which is of no interest to the enemy or prey respectively. The animal is not hidden from view by becoming indistinguishable from its background, as in the cases of general resemblance, but it is mistaken for some well-known object.

In seeking the interpretation of these most interesting and elaborate adaptations, attempts have been made along two lines. First, it is sought to explain the effect as a result of the direct influence of the environment upon the individual (G. L. L. Buffon), or by the inherited effects of effort and the use and disuse of parts (J. B. P. Lamarck). Second, natural selection is believed to have produced the result, and afterwards maintained it by the survival of the best concealed in each generation. The former suggestions break down when the complex nature of numerous special resemblances is appreciated. Thus the arrangement of colours of many kinds into an appropriate pattern requires the co-operation of a suitable shape and the rigidly exact adoption of a certain elaborate attitude. The latter is instinctive, and thus depends on the central nervous system. The cryptic effect is due to the exact co-operation of all these factors; and in the present state of science the only possible hope of an interpretation lies in the theory of natural selection, which can accumulate any and every variation which tends towards survival. A few of the chief types of methods by which concealment is effected may be briefly described. The colours of large numbers of Vertebrate animals are darkest on the back, and become gradually lighter on the sides, passing into white on the belly. Abbott H. Thayer (*The Auk*, vol. xiii., 1896) has suggested that this gradation obliterates the appearance of solidity, which is due to shadow. The colour-harmony, which is also essential to concealment, is produced because the back is of the same tint as the environment (e.g. earth) bathed in the cold blue-white of the sky, while the belly, being cold blue-white bathed in shadow and yellow earth reflections, produces the same effect. Thayer has made models (in the natural history museums at London, Oxford and Cambridge) which support his interpretation in a very convincing manner. This method of neutralizing shadow for the purpose of concealment by increased lightness of tint was first suggested by E. B. Poulton in the case of a larva (*Trans. Ent. Soc. Lond.*, 1887, p. 294) and a pupa (*Trans. Ent. Soc. Lond.*, 1888, pp. 596, 597), but he did not appreciate the great importance of the principle. In an analogous method an animal in front of a background of dark shadow may have part of its body obliterated by the existence of a dark tint, the remainder resembling, e.g., a part of a leaf (W. Müller, *Zool. Jahrb. J. W. Spengel*, Jena, 1886). This method of rendering invisible any part which would interfere with the resemblance is well known in mimicry. A common aid to concealment is the adoption by different individuals of two or more different appearances, each of which resembles some special object to which an enemy is indifferent. Thus the leaf-like butterflies (*Kallima*) present various types of colour and pattern on the under side of the wings, each of which closely resembles some well-known appearance presented by a dead leaf; and the common British yellow under-wing moth (*Tryphaena pronuba*) is similarly polymorphic on the upper side of its upper wings, which are exposed as it suddenly drops among dead leaves. Caterpillars and pupae are also commonly *dimorphic*, green and brown. Such differences as these extend the area which an enemy is compelled to search in order to make a living. In many cases the cryptic colouring changes appropriately

during the course of an individual life, either seasonally, as in the ptarmigan or Alpine hare, or according as the individual enters a new environment in the course of its growth (such as larva, pupa, imago, &c.). In insects with more than one brood in the year, *seasonal dimorphism* is often seen, and the differences are sometimes appropriate to the altered condition of the environment as the seasons change. The causes of change in these and Arctic animals are insufficiently worked out: in both sets there are observations or experiments which indicate changes from within the organism, merely following the seasons and not caused by them, and other observations or experiments which prove that certain species are susceptible to the changing external influences. In certain species concealment is effected by the use of adventitious objects, which are employed as a covering. Examples of this *allocryptic* defence are found in the tubes of the caddis worms (*Phryganca*), or the objects made use of by crabs of the genera *Hyas*, *Stenorhynchus*, &c. Such animals are concealed in any environment. If sedentary, like the former example, they are covered up with local materials; if wandering, like the latter, they have the instinct to recliothe. Allocryptic methods may also be used for aggressive purposes, as the ant-lion larva, almost buried in sand, or the large frog *Ceratophrys*, which covers its back with earth when waiting for its prey. Another form of allocryptic defence is found in the use of the colour of the food in the digestive organs showing through the transparent body, and in certain cases the adventitious colour may be dissolved in the blood or secreted in superficial cells of the body: thus certain insects make use of the chlorophyll of their food (Poulton, *Proc. Roy. Soc. liv.* 417). The most perfect cryptic powers are possessed by those animals in which the individuals can change their colours into any tint which would be appropriate to a normal environment. This power is widely prevalent in fish, and also occurs in Amphibia and Reptilia (the chameleon affording a well-known example). Analogous powers exist in certain Crustacea and Cephalopoda. All these rapid changes of colour are due to changes in shape or position of superficial pigment cells controlled by the nervous system. That the latter is itself stimulated by light through the medium of the eye and optic nerve has been proved in many cases. Animals with a short life-history passed in a single environment, which, however, may be very different in the case of different individuals, may have a different form of *variable cryptic colouring*, namely, the power of adapting their colour once for all (many pupae, or once or twice (many larvae). In these cases the effect appears to be produced through the nervous system, although the stimulus of light probably acts on the skin and not through the eyes. Particoloured surfaces do not produce particoloured pupae, probably because the antagonistic stimuli neutralize each other in the central nervous system, which then disposes the superficial colours so that a neutral or intermediate effect is produced over the whole surface (Poulton, *Trans. Ent. Soc. Lond.*, 1892, p. 293). Cryptic colouring may incidentally produce superficial resemblances between animals; thus desert forms concealed in the same way may gain a likeness to each other, and in the same way special resemblances, e.g. to lichen, bark, grasses, pine-needles, &c., may sometimes lead to a tolerably close similarity between the animals which are thus concealed. Such likeness may be called *syncryptic* or *common protective* (or *aggressive*) *resemblance*, and it is to be distinguished from mimicry and common warning colours, in which the likeness is not incidental, but an end in itself. Syncryptic resemblances have much in common with those incidentally caused by functional adaptation, such as the mole-like forms produced in the burrowing Insectivora, Rodentia and Marsupialia. Such likeness may be called *syntechnic resemblance*, incidentally produced by dynamic similarity, just as syncryptic resemblance is produced by static similarity.

Use of Colour for Warning and Signalling, or Sematic Coloration.

—The use of colour for the purpose of warning is the exact opposite of the one which has been just described, its object being to render the animal conspicuous to its enemies, so that it can be easily seen, well remembered, and avoided in future.

Warning colours are associated with some quality or weapon which renders the possessor unpleasant or dangerous, such as unpalatability, an evil odour, a sting, the poison-fang, &c. The object being to warn an enemy off, these colours are also called *aposematic*. Recognition markings, on the other hand, are *epismatic*, assisting the individuals of the same species to keep together when their safety depends upon numbers, or easily to follow each other to a place of safety, the young and inexperienced benefiting by the example of the older. Epismatic characters are far less common than aposematic, and these than cryptic; although, as regards the latter comparison, the opposite impression is generally produced from the very fact that concealment is so successfully attained. Warning or aposematic colours, together with the qualities they indicate, depend, as a rule, for their very existence upon the abundance of palatable food supplied by the animals with cryptic colouring. Unpalatability, or even the possession of a sting, is not sufficient defence unless there is enough food of another kind to be obtained at the same time and place (Poulton, *Proc. Zool. Soc.*, 1887, p. 191). Hence insects with warning colours are not seen in temperate countries except at the time when insect life as a whole is most abundant; and in warmer countries, with well-marked wet and dry seasons, it will probably be found that warning colours are proportionately less developed in the latter. In many species of African butterflies belonging to the genus *Junonia* (including *Precis*) the wet-season broods are distinguished by the more or less conspicuous under sides of the wings, those of the dry season being highly cryptic. Warning colours are, like cryptic, assisted by special adaptations of the body-form, and especially by movements which assist to render the colour as conspicuous as possible. On this account animals with warning colours generally move or fly slowly, and it is the rule in butterflies that the warning patterns are similar on both upper and under sides of the wings. Many animals, when attacked or disturbed, "sham death" (as it is commonly but wrongly described), falling motionless to the ground. In the case of well-concealed animals this instinct gives them a second chance of escape in the earth or among the leaves, &c., when they have been once detected; animals with warning colours are, on the other hand, enabled to assume a position in which their characters are displayed to the full (J. Portschinsky, *Lepidopterorum Rossiae Biologia*, St Petersburg, 1890, plate i. figs. 16, 17). In both cases a definite attitude is assumed, which is not that of death. Other warning characters exist in addition to colouring: thus sound is made use of by the disturbed rattlesnake and the Indian *Echis*, &c. Large birds, when attacked, often adopt a threatening attitude, accompanied by a terrifying sound. The cobra warns an intruder chiefly by attitude and the dilation of the flattened neck, the effect being heightened in some species by the "spectacles." In such cases we often see the combination of cryptic and sematic methods, the animal being concealed until disturbed, when it instantly assumes an aposematic attitude. The advantage to the animal itself is clear: a poisonous snake gains nothing by killing an animal it cannot eat; while the poison does not cause immediate death, and the enemy would have time to injure or destroy the snake. In the case of small unpalatable animals with warning colours the enemies would only first become aware of the unpleasant quality by tasting and often destroying their prey; but the species would gain by the experience thus conveyed, even though the individual might suffer. An insect-eating animal does not come into the world with knowledge: it has to be educated by experience, and warning colours enable this education as to what to avoid to be gained by a small instead of a large waste of life. Furthermore, great tenacity of life is usually possessed by animals with warning colours. The tissues of aposematic insects generally possess great elasticity and power of resistance, so that large numbers of individuals can recover after very severe treatment.

The brilliant warning colours of many caterpillars attracted the attention of Darwin when he was thinking over his hypothesis of sexual selection, and he wrote to A. R. Wallace on the subject (C. Darwin, *Life and Letters*, London, 1887, iii. 93). Wallace, in reply, suggested their interpretation as warning

colours, a suggestion since verified by experiment (*Proc. Ent. Soc. Lond.*, 1867, p. lxxx; *Trans. Ent. Soc. Lond.*, 1869, pp. 21 and 27). Although animals with warning colours are probably but little attacked by the ordinary enemies of their class, they have special enemies which keep the numbers down to the average. Thus the cuckoo appears to be an insectivorous bird which will freely devour conspicuously coloured unpalatable larvae. The effect of the warning colours of caterpillars is often intensified by gregarious habits. Another aposematic use of colours and structures is to divert attention from the vital parts, and thus give the animal attacked an extra chance of escape. The large, conspicuous, easily torn wings of butterflies and moths act in this way, as is found by the abundance of individuals which may be captured with notches bitten symmetrically out of both wings when they were in contact. The eye-spots and "tails" so common on the hinder part of the hind wing, and the conspicuous apex so frequently seen on the fore wing, probably have this meaning. Their position corresponds to the parts which are most often found to be notched. In some cases (e.g. many *Lycanidae*) the "tail" and eye-spot combine to suggest the appearance of a head with antennae at the posterior end of the butterfly, the deception being aided by movements of the hind wings. The flat-topped "tussocks" of hair on many caterpillars look like conspicuous fleshy projections of the body, and they are held prominently when the larva is attacked. If seized, the "tussock" comes out, and the enemy is greatly inconvenienced by the fine branched hairs. The tails of lizards, which easily break off, are to be similarly explained, the attention of the pursuer being probably still further diverted by the extremely active movements of the amputated member. Certain crabs similarly throw off their claws when attacked, and the claws continue to snap most actively. The tail of the dormouse, which easily comes off, and the extremely bushy tail of the squirrel, are probably of use in the same manner. Animals with warning colours often tend to resemble each other superficially. This fact was first pointed out by H. W. Bates in his paper on the theory of mimicry (*Trans. Linn. Soc.* vol. xxiii., 1862, p. 495). He showed that the conspicuous, presumably unpalatable, tropical American butterflies, belonging to very different groups, which are mimicked by others, also tend to resemble each other, the likeness being often remarkably exact. These resemblances were not explained by his theory of mimicry, and he could only suppose that they had been produced by the direct influence of a common environment. The problem was solved in 1879 by Fritz Müller (see *Proc. Ent. Soc. Lond.*, 1879, p. xx.), who suggested that life is saved by this resemblance between warning colours, inasmuch as the education of young inexperienced enemies is facilitated. Each species which falls into a group with common warning (*synaposematic*) colours contributes to save the lives of the other members. It is sufficiently obvious that the amount of learning and remembering, and consequently of injury and loss of life involved in the process, are reduced when many species in one place possess the same aposematic colouring, instead of each exhibiting a different "danger-signal." These resemblances are often described as "Müllerian mimicry," as distinguished from true or "Batesian mimicry" described in the next section. Similar synaposematic resemblances between the specially protected groups of butterflies were afterwards shown to exist in tropical Asia, the East Indian Islands and Polynesia by F. Moore (*Proc. Zool. Soc.*, 1883, p. 201), and in Africa by E. B. Poulton (*Report Brit. Assoc.*, 1897, p. 688). R. Meldola (*Ann. and Mag. Nat. Hist.* x., 1882, p. 417) first pointed out and explained in the same manner the remarkable general uniformity of colour and pattern which runs through so many species of each of the distasteful groups of butterflies; while, still later, Poulton (*Proc. Zool. Soc.*, 1887, p. 191) similarly extended the interpretation to the synaposematic resemblances between animals of all kinds in the same country. Thus, for example, longitudinal or circular bands of the same strongly contrasted colours are found in species of many groups with distant affinities.

Certain animals, especially the Crustacea, make use of the special defence and warning colours of other animals. Thus

the English hermit-crab, *Pagurus Bernhardus*, commonly carries the sea-anemone, *Sagartia parasitica*, on its shell; while another English species, *Pagurus Pridcauxii*, inhabits a shell which is invariably clothed by the flattened *Adamsia palliata*.

The white patch near the tail which is frequently seen in the gregarious Ungulates, and is often rendered conspicuous by adjacent black markings, probably assists the individuals in keeping together; and appearances with probably the same interpretation are found in many birds. The white upturned tail of the rabbit is probably of use in enabling the individuals to follow each other readily. The difference between a typical aposematic character appealing to enemies, and episematic intended for other individuals of the same species, is well seen when we compare such examples as (1) the huge banner-like white tail, conspicuously contrasted with the black or black and white body, by which the slow-moving skunk warns enemies of its power of emitting an intolerably offensive odour; (2) the small upturned white tail of the rabbit, only seen when it is likely to be of use and when the owner is moving, and, if pursued, very rapidly moving, towards safety.

Mimicry (see also MIMICRY) or *Pseudo-sematic Colours*.—The fact that animals with distant affinities may more or less closely resemble each other was observed long before the existing explanation was possible. Its recognition is implied in a number of insect names with the termination *-formis*, usually given to species of various orders which more or less closely resemble the stinging Hymenoptera. The usefulness of the resemblance was suggested in Kirby and Spence's *Introduction to Entomology*, London, 1817, ii. 223. H. W. Bates (*Trans. Linn. Soc.* vol. xxiii., 1862, p. 495) first proposed an explanation of mimicry based on the theory of natural selection. He supposed that every step in the formation and gradual improvement of the likeness occurred in consequence of its usefulness in the struggle for life. The subject is of additional interest, inasmuch as it was one of the first attempts to apply the theory of natural selection to a large class of phenomena up to that time well known but unexplained. Numerous examples of mimicry among tropical American butterflies were discussed by Bates in his paper; and in 1866 A. R. Wallace extended the hypothesis to the butterflies of the tropical East (*Trans. Linn. Soc.* vol. xxv., 1866, p. 19); Roland Trimen (*Trans. Linn. Soc.* vol. xxvi., 1870, p. 497) to those of Africa in 1870. The term mimicry is used in various senses. It is often extended, as indeed it was by Bates, to include all the superficial resemblances between animals and any part of their environment. Wallace, however, separated the cryptic resemblances already described, and the majority of naturalists have followed this convenient arrangement. In cryptic resemblance an animal resembles some object of no interest to its enemy (or prey), and in so doing is concealed; in mimicry an animal resembles some other animal which is specially disliked by its enemy, or some object which is specially attractive to its prey, and in so doing becomes conspicuous. Some naturalists have considered mimicry to include all superficial likenesses between animals, but such a classification would group together resemblances which have widely different uses. (1) The resemblance of a mollusc to the coral on which it lives, or an external parasite to the hair or skin of its host, would be *procryptic*; (2) that between moths which resemble lichen, *syncryptic*; (3) between distasteful insects, *synaposematic*; (4) between the Insectivore mole and the Rodent mole-rat, *syntechnic*; (5) the essential element in mimicry is that it is a false warning (pseud-aposematic) or false recognition (pseud-episematic) character. Some have considered that mimicry indicates resemblance to a moving object; but apart from the non-mimetic likenesses between animals classified above, there are ordinary cryptic resemblances to drifting leaves, swaying bits of twig, &c., while truly mimetic resemblances are often specially adapted for the attitude of rest. Many use the term mimicry to include synaposematic as well as pseudo-sematic resemblances, calling the former "Müllerian," the latter "Batesian," mimicry. The objection to this grouping is that it takes little account of the deceptive element which is essential in mimicry. In

synaposematic colouring the warning is genuine, in pseud-aposematic it is a sham. The term mimicry has led to much misunderstanding from the fact that in ordinary speech it implies deliberate imitation. The production of mimicry in an individual animal has no more to do with consciousness or "taking thought" than any of the other processes of growth. Protective mimicry is here defined as an advantageous and superficial resemblance of one animal to another, which latter is specially defended so as to be disliked or feared by the majority of enemies of the groups to which both belong—a resemblance which appeals to the sense of sight, sometimes to that of hearing, and rarely to smell, but does not extend to deep-seated characters except when the superficial likeness is affected by them. *Mutatis mutandis* this definition will apply to aggressive (pseud-episematic) resemblance. The conditions under which mimicry occurs have been stated by Wallace:—“(1) that the imitative species occur in the same area and occupy the same station as the imitated; (2) that the imitators are always the more defenceless; (3) that the imitators are always less numerous in individuals; (4) that the imitators differ from the bulk of their allies; (5) that the imitation, however minute, is *external* and *visible* only, never extending to internal characters or to such as do not affect the external appearance.” It is obvious that conditions 2 and 3 do not hold in the case of Müllerian mimicry. Mimicry has been explained, independently of natural selection, by the supposition that it is the common expression of the direct action of common causes, such as climate, food, &c.; also by the supposition of independent lines of evolution leading to the same result without any selective action in consequence of advantage in the struggle; also by the operation of sexual selection.

It is proposed, in conclusion, to give an account of the broad aspects of mimicry, and attempt a brief discussion of the theories of origin of each class of facts (see Poulton, *Linn. Soc. Journ. Zool.*, 1898, p. 558). It will be found that in many cases the argument here made use of applies equally to the origin of cryptic and sematic colours. The relationship between these classes has been explained: mimicry is, as Wallace has stated (*Darwinism*, London, 1889), merely “an exceptional form of protective resemblance.” Now, protective (cryptic) resemblance cannot be explained on any of the lines suggested above, except natural selection; even sexual selection fails, because cryptic resemblance is especially common in the immature stages of insect life. But it would be unreasonable to explain mimetic resemblance by one set of principles and cryptic by another and totally different set. Again, it may be plausible to explain the mimicry of one butterfly for another on one of the suggested lines, but the resemblance of a fly or moth to a wasp is by no means so easy, and here selection would be generally conceded; yet the appeal to antagonistic principles to explain such closely related cases would only be justified by much direct evidence. Furthermore, the mimetic resemblances between butterflies are not haphazard, but the models almost invariably belong only to certain sub-families, the *Danaïnae* and *Acraeinae* in all the warmer parts of the world, and, in tropical America, the *Ithomiinae* and *Heliconinae* as well. These groups have the characteristics of aposematic species, and no theory but natural selection explains their invariable occurrence as models wherever they exist. It is impossible to suggest, except by natural selection, any explanation of the fact that mimetic resemblances are confined to changes which produce or strengthen a superficial likeness. Very deep-seated changes are generally involved, inasmuch as the appropriate instincts as to attitude, &c., are as important as colour and marking. The same conclusion is reached when we analyse the nature of mimetic resemblance and realize how complex it really is, being made up of *colours*, both pigmentary and structural, *pattern*, *form*, *attitude* and *movement*. A plausible interpretation of colour may be wildly improbable when applied to some other element, and there is no explanation except natural selection which can explain all these elements. The appeal to the direct action of local conditions in common often breaks down upon the slightest investi-

gation, the difference in habits between mimic and model in the same locality causing the most complete divergence in their conditions of life. Thus many insects produced from burrowing larvae mimic those whose larvae live in the open. Mimetic resemblance is far commoner in the female than in the male, a fact readily explicable by selection, as suggested by Wallace, for the female is compelled to fly more slowly and to expose itself while laying eggs, and hence a resemblance to the slow-flying freely exposed models is especially advantageous. The facts that mimetic species occur in the same locality, fly at the same time of the year as their models, and are day-flying species even though they may belong to nocturnal groups, are also more or less difficult to explain except on the theory of natural selection, and so also is the fact that mimetic resemblance is produced in the most varied manner. A spider resembles its model, an ant, by a modification of its body-form into a superficial resemblance, and by holding one pair of legs to represent antennae; certain bugs (Hemiptera) and beetles have also gained a shape unusual in their respective groups, a shape which superficially resembles an ant; a Locustid (*Myrmecophana*) has the shape of an ant painted, as it were, on its body, all other parts resembling the background and invisible; a Membracid (Homoptera) is entirely unlike an ant, but is concealed by an ant-like shield. When we further realize that in this and other examples of mimicry “the likeness is almost always detailed and remarkable, however it is attained, while the methods differ absolutely,” we recognize that natural selection is the only possible explanation hitherto suggested. In the cases of aggressive mimicry an animal resembles some object which is attractive to its prey. Examples are found in the flower-like species of *Mantis*, which attract the insects on which they feed. Such cases are generally described as possessing “alluring colours,” and are regarded as examples of aggressive (anticryptic) resemblance, but their logical position is here.

Colours displayed in Courtship, Secondary Sexual Characters, Epigamic Colours.—Darwin suggested the explanation of these appearances in his theory of *sexual selection* (*The Descent of Man*, London, 1874). The rivalry of the males for the possession of the females he believed to be decided by the preference of the latter for those individuals with especially bright colours, highly developed plumes, beautiful song, &c. Wallace does not accept the theory, but believes that natural selection, either directly or indirectly, accounts for all the facts. Probably the majority of naturalists follow Darwin in this respect. The subject is most difficult, and the interpretation of a great proportion of the examples in a high degree uncertain, so that a very brief account is here expedient. That selection of some kind has been operative is indicated by the diversity of the elements into which the effects can be analysed. The most complete set of observations on epigamic display was made by George W. and Elizabeth G. Peckham upon spiders of the family *Attidae* (*Nat. Hist. Soc. of Wisconsin*, vol. i., 1889). These observations afforded the authors “conclusive evidence that the females pay close attention to the love-dances of the males, and also that they have not only the power, but the will, to exercise a choice among the suitors for their favour.” Epigamic characters are often concealed except during courtship; they are found almost exclusively in species which are diurnal or semi-diurnal in their habits, and are excluded from those parts of the body which move too rapidly to be seen. They are very commonly directly associated with the nervous system; and in certain fish, and probably in other animals, an analogous heightening of effect accompanies nervous excitement other than sexual, such as that due to fighting or feeding. Although there is epigamic display in species with sexes alike, it is usually most marked in those with secondary sexual characters specially developed in the male. These are an exception to the rule in heredity, in that their appearance is normally restricted to a single sex, although in many of the higher animals they have been proved to be latent in the other, and may appear after the essential organs of sex have been removed or become functionless. This is also the case in the Aculeate Hymenoptera when the reproductive organs have been

destroyed by the parasite *Stylops*. J. T. Cunningham has argued (*Sexual Dimorphism in the Animal Kingdom*, London, 1900) that secondary sexual characters have been produced by direct stimulation due to contests, &c., in the breeding period, and have gradually become hereditary, a hypothesis involving the assumption that acquired characters are transmitted. Wallace suggests that they are in part to be explained as "recognition characters," in part as an indication of surplus vital activity in the male.

AUTHORITIES.—The following works may also be consulted:—T. Eimer, *Orthogenesis der Schmetterlinge* (Leipzig, 1898); E. B. Poulton, *The Colours of Animals* (London, 1890); F. E. Beddard, *Animal Coloration* (London, 1892); E. Haase, *Researches on Mimicry* (translation, London, 1896); A. R. Wallace, *Natural Selection and Tropical Nature* (London, 1895); *Darwinism* (London, 1897); A. H. Thayer and G. H. Thayer, *Concealing-Coloration in the Animal Kingdom* (New York, 1910). (E. B. P.)

2. CHEMISTRY

The coloration of the surface of animals is caused either by pigments, or by a certain structure of the surface by means of which the light falling on it, or reflected through its superficial transparent layers, undergoes diffraction or other optical change. Or it may be the result of a combination of these two causes. It plays an important part in the relationship of the animal to its environment, in concealment, in mimicry, and so on; the presence of a pigment in the integument may also serve a more direct physiological purpose, such as a respiratory function. The coloration of birds' feathers, of the skin of many fishes, of many insects, is partially at least due to structure and the action of the peculiar pigmented cells known as "chromatophores" (which W. Garstang defines as pigmented cells specialized for the discharge of the chromatic function), and is much better marked when these have for their background a "reflecting layer" such as is provided by guanin, a substance closely related to uric acid. Such a mechanism is seen to greatest advantage in fishes. Among these, guanin may be present in a finely granular form, causing the light falling on it to be scattered, thus producing a white effect; or it may be present in a peculiar crystalline form, the crystals being known as "iridocytes"; or in a layer of closely apposed needles forming a silvery sheet or mirror. In the iris of some fishes the golden red colour is produced by the light reflected from such a layer of guanin needles having to pass through a thin layer of a reddish pigment, known as a "lipochrome." Again, in some lepidopterous insects a white or a yellow appearance is produced by the deposition of uric acid or a nearly allied substance on the surface of the wings. In many animals, but especially among invertebrates, colouring matters or pigments play an important rôle in surface coloration; in some cases such coloration may be of benefit to the animal, but in others the integument simply serves as an organ for the excretion of waste pigmentary substances. Pigments (1) may be of direct physiological importance; (2) they may be excretory; or (3) they may be introduced into the body of the animal with the food.

Of the many pigments which have been described up to the present time, very few have been subjected to elementary chemical analysis, owing to the great difficulties attending their isolation. An extremely small amount of pigment will give rise to a great amount of coloration, and the pigments are generally accompanied by impurities of various kinds which cling to them with great tenacity, so that when one has been thoroughly cleansed very little of it remains for ultimate analysis. Most of these substances have been detected by means of the spectroscope, their absorption bands serving for their recognition, but mere identity of spectrum does not necessarily mean chemical identity, and a few chemical tests have also to be applied before a conclusion can be drawn. The absorption bands are referred to certain definite parts of the spectrum, such as the Fraunhofer lines, or they may be given in wave-lengths. For this purpose the readings of the spectroscope are reduced to wave-lengths by means of interpolation curves; or if Zeiss's microspectroscope be used, the position of bands in wave-lengths (denoted by the Greek letter λ) may be read directly.

Haemoglobin, the red colouring matter of vertebrate

blood, $C_{755}H_{1205}N_{195}S_3FeO_{218}$, and its derivatives haematin, $C_{32}H_{30}N_4FeO_8$, and haematoporphyrin, $C_{16}H_{18}N_2O_4$, are colouring matters about which we possess definite chemical knowledge, as they have been isolated, purified and analysed. Most of the bile pigments of mammals have likewise been isolated and studied chemically, and all of these are fully described in the text-books of physiology and physiological chemistry. Haemoglobin, though physiologically of great importance in the respiratory process of vertebrate animals, is yet seldom used for surface pigmentation, except in the face of white races of man or in other parts in monkeys, &c. In some worms the transparent skin allows the haemoglobin of the blood to be seen through the integument, and in certain fishes also the haemoglobin is visible through the integument. It is a curious and noteworthy fact that in some invertebrate animals in which no haemoglobin occurs, we meet with its derivatives. Thus haematin is found in the so-called bile of slugs, snails, the limpet and the crayfish. In sea-anemones there is a pigment which yields some of the decomposition-products of haemoglobin, and associated with this is a green pigment apparently identical with biliverdin ($C_{16}H_{18}N_2O_4$), a green bile pigment. Again, haematoporphyrin is found in the integuments of star-fishes and slugs, and occurs in the "dorsal streak" of the earth-worm *Lumbricus terrestris*, and perhaps in other species. Haematoporphyrin and biliverdin also occur in the egg-shells of certain birds, but in this case they are derived from haemoglobin. Haemoglobin is said to be found as low down in the animal kingdom as the Echinoderms, e.g. in *Ophiactis virens* and *Thyonella gemmata*. It also occurs in the blood of *Planorbis cornuus* and in the pharyngeal muscles of other mollusca.

A great number of other pigments have been described; for example, in the muscles and tissues of animals, both vertebrate and invertebrate, are the histohaematin, of which a special muscle pigment, myohaematin, is one. In vertebrates the latter is generally accompanied by haemoglobin, but in invertebrates—with the exception of the pharyngeal muscles of the mollusca—it occurs alone. Although closely related to haemoglobin or its derivative haemochromogen, the histohaematin is yet totally distinct, and they are found in animals where not a trace of haemoglobin can be detected. Another interesting pigment is turacin, which contains about 7% of nitrogen, found by Professor A. H. Church in the feathers of the Cape lory and other plantain-eaters, from which it can be extracted by water containing a trace of ammonia. It has been isolated, purified and analysed by Professor Church. From it may be obtained turacoporphyrin, which is identical with haematoporphyrin, and gives the band in the ultra-violet which J. L. Soret and subsequently A. Gamgee have found to be characteristic of haemoglobin and its compounds. Turacin itself gives a peculiar two-banded spectrum, and contains about 7% of copper in its molecule. Another copper-containing pigment is haemocyanin, which in the oxidized state gives a blue colour to the blood of various Mollusca and Arthropoda. Like haemoglobin, it acts as an oxygen-carrier in respiration, but it takes no part in surface coloration.

A class of pigments widely distributed among plants and animals are the lipochromes. As their name denotes, they are allied to fat and generally accompany it, being soluble in fat solvents. They play an important part in surface coloration, and may be greenish, yellow or red in colour. They contain no nitrogen. As an example of a lipochrome which has been isolated, crystallized and purified, we may mention carotin, which has recently been found in green leaves. Chlorophyll, which is so often associated with a lipochrome, has been found in some Infusoria, and in *Hydra* and *Spongilla*, &c. In some cases it is probably formed by the animal; in other cases it may be due to symbiotic algae, while in the gastric gland of many Mollusca, Crustacea and Echinodermata it is derived from food-chlorophyll. Here it is known as entero-chlorophyll. The black pigments which occur among both vertebrate and invertebrate animals often have only one attribute in common, viz. blackness, for among the discordant results of analysis one thing is certain, viz. that the melanins from vertebrate animals

are not identical with those from invertebrate animals. The melanosis or blackening of insect blood, for instance, is due to the oxidation of a chromogen, the pigment produced being known as a uranidine. In some sponges a somewhat similar pigment has been noticed. Other pigments have been described, such as actinochrome, echinochrome, pentacrinin, antedonin, polyperyrin (which appears to be a haematoporphyrin), the floridines, spongioporphyrin, &c., which need no mention here; all these pigments can only be distinguished by means of the spectroscope.

Most of the pigments are preceded by colourless substances known as "chromogens," which by the action of the oxygen of the air and by other agencies become changed into the corresponding pigments. In some cases the pigments are built up in the tissues of an animal, in others they appear to be derived more or less directly from the food. Derivatives of chlorophyll and lipochromes especially, seem to be taken up from the intestine, probably by the agency of leucocytes, in which they may occur in combination with, or dissolved by, fatty matters and excreted by the integument. In worms especially, the skin seems to excrete many effete substances, pigments included. No direct connexion has been traced between the chlorophyll eaten with the food and the haemoglobin of blood and muscle. Attention may, however, be drawn to the work of Dr E. Schunck, who has shown that a substance closely resembling haematoporphyrin can be prepared from chlorophyll; this is known as phylloporphyrin. Not only does the visible spectrum of this substance resemble that of haematoporphyrin, but the invisible ultra-violet also, as shown by C. A. Schunck.

The reader may refer to E. A. Schäfer's *Text-Book of Physiology* (1898) for A. Gamgee's article "On Haemoglobin, and its Compounds"; to the writer's papers in the *Phil. Trans.* and *Proc. Roy. Soc.* from 1881 onwards, and also *Quart. Journ. Micros. Science* and *Journ. of Physiol.*; to C. F. W. Krukenberg's *Vergleichende physiologische Studien* from 1879 onwards, and to his *Vorträge*. Miss M. I. Newbigin collected in *Colour in Nature* (1898) most of the recent literature of this subject. Dr E. Schunck's papers will be found under the heading "Contribution to the Chemistry of Chlorophyll" in *Proc. Roy. Soc.* from 1885 onwards; and Mr C. A. Schunck's paper in *Proc. Roy. Soc.* vol. lxiii. (C. A. MACM.)

COLSTON, EDWARD (1636-1721), English philanthropist, the son of William Colston, a Bristol merchant of good position, was born at Bristol on the 2nd of November 1636. He is generally understood to have spent some years of his youth and manhood as a factor in Spain, with which country his family was long connected commercially, and whence, by means of a trade in wines and oil, great part of his own vast fortune was to come. On his return he seems to have settled in London, and to have bent himself resolutely to the task of making money. In 1681, the date of his father's decease, he appears as a governor of Christ's hospital, to which noble foundation he afterwards gave frequently and largely. In the same year he probably began to take an active interest in the affairs of Bristol, where he is found about this time embarked in a sugar refinery; and during the remainder of his life he seems to have divided his attention pretty equally between the city of his birth and that of his adoption. In 1682 he appears in the records of the great western port as advancing a sum of £1800 to its needy corporation; in 1683 as "a free burgess and *meire* (St Kitts) merchant" he was made a member of the Merchant's Hall; and in 1684 he was appointed one of a committee for managing the affairs of Clifton. In 1685 he again appears as the city's creditor for about £2000, repayment of which he is found insisting on in 1686. In 1689 he was chosen auditor by the vestry at Mortlake, where he was residing in an old house once the abode of Ireton and Cromwell. In 1691, on St Michael's Hill, Bristol, at a cost of £8000, he founded an almshouse for the reception of 24 poor men and women, and endowed with accommodation for "Six Saylor's," at a cost of £600, the merchant's almshouses in King Street. In 1696, at a cost of £8000, he endowed a foundation for clothing and teaching 40 boys (the books employed were to have in them "no tincture of Whiggism"); and six years afterwards he expended a further sum of £1500 in rebuilding the school-house. In 1708, at a cost of £41,200, he built and endowed his great foundation on Saint

Augustine's Back, for the instruction, clothing, maintaining and apprenticing of 100 boys; and in time of scarcity, during this and next year, he transmitted "by a private hand" some £20,000 to the London committee. In 1710, after a poll of four days, he was sent to parliament, to represent, on strictest Tory principles, his native city of Bristol; and in 1713, after three years of silent political life, he resigned this charge. He died at Mortlake in 1721, having nearly completed his eighty-fifth year; and was buried in All Saints' church, Bristol.

Colston, who was in the habit of bestowing large sums yearly for the release of poor debtors and the relief of indigent age and sickness, and who gave (1711) no less than £6000 to increase Queen Anne's Bounty Fund for the augmentation of small livings, was always keenly interested in the organization and management of his foundations; the rules and regulations were all drawn up by his hand, and the minutest details of their constitution and economy were dictated by him. A high churchman and Tory, with a genuine intolerance of dissent and dissenters, his name and example have served as excuses for the formation of two political benevolent societies—the "Anchor" (founded 1769) and the "Dolphin" (founded 1749),—and also the "Grateful" (founded 1758), whose rivalry has been perhaps as instrumental in keeping their patron's memory green as have the splendid charities with which he enriched his native city (see BRISTOL).

See Garrard, *Edward Colston, the Philanthropist* (4to, Bristol, 1852); Pryce, *A Popular History of Bristol* (1861); Manchee, *Bristol Charities*.

COLT, SAMUEL (1814-1862), American inventor, was born on the 19th of July 1814 at Hartford, Connecticut, where his father had a manufactory of silks and woollens. At the age of ten he left school for the factory, and at fourteen, then being in a boarding school at Amherst, Massachusetts, he made a runaway voyage to India, during which (in 1829) he constructed a wooden model, still existing, of what was afterwards to be the revolver (see PISTOL). On his return he learned chemistry from his father's bleaching and dyeing manager, and under the assumed name "Dr Coult" travelled over the United States and Canada lecturing on that science. The profits of two years of this work enabled him to continue his researches and experiments. In 1835, having perfected a six-barrelled rotating breech, he visited Europe, and patented his inventions in London and Paris, securing the American right on his return, and the same year he founded at Paterson, New Jersey, the Patent Arms Company, for the manufacture of his revolvers only. As early as 1837 revolvers were successfully used by United States troops, under Lieut.-Colonel William S. Harney, in fighting against the Seminole Indians in Florida. Colt's scheme, however, did not succeed; the arms were not generally appreciated; and in 1842 the company became insolvent. No revolvers were made for five years, and none were to be had when General Zachary Taylor wrote for a supply from the seat of war in Mexico. In 1847 the United States government ordered 1000 from the inventor; but before these could be produced he had to construct a new model, for a pistol of the company's make could nowhere be found. This commission was the beginning of an immense business. The little armoury at Whitneyville (New Haven, Connecticut), where the order for Mexico was executed, was soon exchanged for larger workshops at Hartford. These in their turn gave place (1852) to the enormous factory of the Colt's Patent Fire-Arms Manufacturing Company, doubled in 1861, on the banks of the Connecticut river, within the city limits of Hartford, where so many millions of revolvers with all their appendages have been manufactured. Thence was sent, for the Russian and English governments, to Tula and Enfield, the whole of the elaborate machinery devised by Colt for the manufacture of his pistols. Colt introduced and patented a number of improvements in his revolver, and also invented a submarine battery for harbour defence. He died at Hartford on the 10th of January 1862.

COLT'S-FOOT, the popular name of a small herb, *Tussilago Farfara*, a member of the natural order Compositae, which is

common in Britain in damp, heavy soils. It has a stout branching underground stem, which sends up in March and April scapes about 6 in. high, each bearing a head of bright yellow flowers, the male in the centre surrounded by a much larger number of female. The flowers are succeeded by the fruits, which bear a soft snow-white woolly pappus. The leaves, which appear later, are broadly cordate with an angular or lobed outline, and are covered on the under-face with a dense white felt. The botanical name, *Tussilago*, recalls its use as a medicine for cough (*tussis*). The leaves are smoked in cases of asthma.

COLUGO, or **COBEGO**, either of two species of the zoological genus *Galeopithecus*. These animals live in the forests of the Malay Peninsula, Sumatra, Borneo and the Philippine Islands, where they feed chiefly on leaves, and probably also on insects. In size they may be compared with cats; the long slender limbs are connected by a broad fold of skin extending outwards from the sides of the neck and body, the fingers and toes are webbed, and the hind-limbs joined by an outer membrane as in bats. Their habits are nocturnal, and during the daytime they cling to the trunks or limbs of trees head downwards in a state of repose. With the approach of night their season of activity commences, when they may be occasionally seen gliding from tree to tree supported on their cutaneous parachute, and they have been noticed as capable of traversing in this way a space of 70 yds. with a descent of only about one in five. Europeans in the East know these animals as "flying lemurs." (See *GALEOPITHECUS*.)

COLUMBA, SAINT (Irish, *Colum*), Irish saint, was born on the 7th of December 521, in all probability at Gartan in Co. Donegal. His father Feidlimid was a member of the reigning family in Ireland and was closely allied to that of Dalriada (Argyll). His mother Eithne was of Leinster extraction and was descended from an illustrious provincial king. To these powerful connexions as much as to his piety and ability, he owed the immense influence he possessed. Later lives state that the saint was also called Crimthann (fox), and Reeves suggests that he may have had two names, the one baptismal, the other secular. He was afterwards known as Columkille, or Columba of the Church, to distinguish him from others of the same name. During his early years the Irish Church was reformed by Gildas and Finian of Clonard, and numerous monasteries were founded which made Ireland renowned as a centre of learning. Columba himself studied under two of the most distinguished Irishmen of his day, Finian of Moville (at the head of Strangford Lough) and Finian of Clonard. Almost as a matter of course, under such circumstances, he embraced the monastic life. He was ordained deacon while at Moville, and afterwards, when about thirty years of age, was raised to the priesthood. During his residence in Ireland he founded, in addition to a number of churches, two famous monasteries, one named Daire Calgaich (Derry) on the banks of Lough Foyle, the other Dair-magh (Durrow) in King's county.

In 563 he left his native land, accompanied by twelve disciples, and went on a mission to northern Britain, perhaps on the invitation of his kinsman Conall, king of Dalriada. Irish accounts represent Columba as undertaking this mission in consequence of the censure expressed against him by the clergy after the battle of Cooledvny; but this is probably a fabrication. The saint's labours in Scotland must be regarded as a manifestation of the same spirit of missionary enterprise with which so many of his countrymen were imbued. Columba established himself on the island of Hy or Iona, where he erected a church and a monastery. About the year 565 he applied himself to the task of converting the heathen kingdom of the northern Picts. Crossing over to the mainland he proceeded to the residence, on the banks of the Ness, of Brude, king of the Picts. By his preaching, his holy life, and, as his earliest biographers assert, by the performance of miracles, he converted the king and many of his subjects. The precise details, except in a few cases, are unknown, or obscured by exaggeration and fiction; but it is certain that the whole of northern Scotland was converted by the labours of Columba, and his disciples and the

religious instruction of the people provided for by the erection of numerous monasteries. The monastery of Iona was revered as the mother house of all these foundations, and its abbots were obeyed as the chief ecclesiastical rulers of the whole nation of the northern Picts. There were then neither dioceses nor parishes in Ireland and Celtic Scotland; and by the Columbite rule the bishops themselves, although they ordained the clergy, were subject to the jurisdiction of the abbots of Iona, who, like the founder of the order, were only presbyters. In matters of ritual they agreed with the Western Church on the continent, save in a few particulars such as the precise time of keeping Easter and manner of tonsure.

Columba was honoured by his countrymen, the Scots of Britain and Ireland, as much as by his Pictish converts, and in his character of chief ecclesiastical ruler he gave formal benediction and inauguration to Aidan, the successor of Conall, as king of the Scots. He accompanied that prince to Ireland in 575, and took a leading part in a council held at Drumceat in Ulster, which determined once and for all the position of the ruler of Dalriada with regard to the king of Ireland. The last years of Columba's life appear to have been mainly spent at Iona. There he was already revered as a saint, and whatever credit may be given to some portions of the narratives of his biographers, there can be no doubt as to the wonderful influence which he exercised, as to the holiness of his life, and as to the love which he uniformly manifested to God and to his neighbour.

In the summer of 597 he knew that his end was approaching. On Saturday the 8th of June he was able, with the help of one of his monks, to ascend a little hill above the monastery and to give it his farewell blessing. Returning to his cell he continued a labour in which he had been engaged, the transcription of the Psalter. Having finished the verse of the 34th Psalm where it is written, "They who seek the Lord shall want no manner of thing that is good," he said, "Here I must stop:—what follows let Baithen write"; indicating, as was believed, his wish that his cousin Baithen should succeed him as abbot. He was present at evening in the church, and when the midnight bell sounded for the nocturnal office early on Sunday morning he again went thither unsupported, but sank down before the altar and passed away as in a gentle sleep.

Several Irish poems are ascribed to Columba, but they are manifestly compositions of a later age. Three Latin hymns may, however, be attributed to the saint with some degree of certainty.

The original materials for a life of St Columba are unusually full. The earliest biography was written by one of his successors, Cuminius, who became abbot of Iona in 657. Much more important is the enlargement of that work by Adamnan, who became abbot of Iona in 679. These narratives are supplemented by the brief but most valuable notices given by the Venerable Bede. See W. Reeves, *Life of St Columba, written by Adamnan* (Dublin, 1857); W. F. Skene, *Celtic Scotland*, vol. ii. "Church and Culture" (Edinburgh, 1877). (E. C. Q.)

COLUMBAN (543–615), Irish saint and writer, was born in Leinster in 543, and was educated in the monastery of Bangor, Co. Down. About the year 585 he left Ireland together with twelve other monks, and established himself in the Vosges, among the ruins of an ancient fortification called Anagrates, the present Anegray in the department of Haute-Saône. His enemies accused him before a synod of French bishops (602) for keeping Easter according to the old British and now unorthodox way, and a more powerful conspiracy was organized against him at the court of Burgundy by boldly rebuking the crimes of King Theuderich II. and the queen-mother Brunhilda. He was banished and forcibly removed from his monastery, and with St Gall and others of the monks he withdrew into Switzerland, where he preached with no great success to the Suebi and Alamanni. Being again compelled to flee, he retired to Italy, and founded the monastery of Bobbio in the Apennines, where he remained till his death, which took place on the 21st of November 615. His writings, which include some Latin poems, prove him a man of learning, and he appears to have been acquainted not only with the Latin classics, but also with Greek, and even Hebrew.

The collected edition of St Columban's writings was published by Patrick Fleming in his *Collectanea sacra Hiberni* (Louvain, 1667).

and reproduced by Migne, p. 4, vol. lxxxvi (Paris, 1844). See further, Wright's *Biographia Literaria*. Columban's *Regula Coenobialis cum Poenitentiali* is to be found in the *Codex Regularum* (Paris, 1638). A complete bibliography is given in U. Chevallier, *Répertoire des sources hist.* (Bio. Bibliogr.), vol. i. 990 (Paris, 1905).

COLUMBANI, PLACIDO, Italian architectural designer, who worked chiefly in England in the latter part of the 18th century. He belonged to the school of the Adams and Pergolesi, and like them frequently designed the enrichments of furniture. He was a prolific producer of chimney-pieces, which are often mistaken for Adam work, of moulded friezes, and painted plaques for cabinets and the like. There can be no question that the English furniture designers of the end of the 18th century, and especially the Adams, Hepplewhite and Sheraton, owed much to his graceful, flowing and classical conceptions, although they are often inferior to those of Pergolesi. His books are still a valuable store-house of sketches for internal architectural decoration. His principal works are:—*Vases and Tripods* (1770); *A New Book of Ornaments, containing a variety of elegant designs for Modern Panels, commonly executed in Stucco, Wood or Painting, and used in decorating Principal Rooms* (1775); *A variety of Capitals, Friezes and Corniches, and how to increase and decrease them, still retaining their proportions* (1776). He also assisted John Crunden in the production of *The Chimney-piece Makers' Daily Assistant* (1776).

COLUMBARIUM (Lat. *columba*, a dove), a pigeon-house. The term is applied in architecture to those sepulchral chambers in and near Rome, the walls of which were sunk with small niches (*columbaria*) to receive the cinerary urns. Vitruvius (iv. 2) employs the term to signify the holes made in a wall to receive the ends of the timbers of a floor or roof.

COLUMBIA, a city and the county-seat of Boone county, Missouri, U.S.A., situated in the central part of the state, about 145 m. (by rail) W.N.W. of St Louis. Pop. (1890) 4000; (1900) 5651 (1916 negroes); (1910) 9662. Columbia is served by the Wabash and the Missouri, Kansas & Texas railways. It is primarily an educational centre, is a market for grain and farm products, and has grain elevators, a packing house, a shoe factory and brick works. Columbia is the seat of the University of Missouri, a coeducational state institution, established in 1839 and opened in 1841; it received no direct financial support from the state until 1867, and its founding was due to the self-sacrifice of the people of the county. It is now liberally supported by the state; in 1908 its annual income was about \$650,000. In 1908 the university had (at Columbia) 200 instructors and 2419 students, including 680 women; included in its library is the collection of the State Historical Society. The School of Mines of the university is at Rolla, Mo.; all other departments are at Columbia. A normal department was established in 1867 and opened in 1868; and women were admitted to it in 1869. The College of Agriculture and Mechanic Arts became a department of the university in 1870. The law department was opened in 1872, the medical in 1873, and the engineering in 1877. The graduate department was established in 1896, and in 1908 a department of journalism was organized. On the university campus in the quadrangle is the monument of grey granite erected over the grave of Thomas Jefferson, designed after his own plans, and bearing the famous inscription written by him. It was given to the university by descendants of Jefferson when Congress appropriated money for the monument now standing over his grave. Near the city is the farm of the agricultural college and the experiment station. At Columbia, also, are the Parker Memorial hospital, the Teachers College high school, the University Military Academy, the Columbia Business College, Christian College (Disciples) for women, established in 1851, its charter being the first granted by Missouri for the collegiate education of Protestant women; the Bible College of the Disciples of Christ in Missouri; and Stephens College (under Baptist control) for women, established in 1856. The municipality owns the water-works and the electric lighting plant. Columbia was first settled about 1821.

COLUMBIA, a borough of Lancaster county, Pennsylvania, U.S.A., on the W. bank of the Susquehanna river (here crossed

by a long steel bridge), opposite Wrightsville and about 81 m. W. by N. of Philadelphia. Pop. (1890) 10,599; (1900) 12,316, of whom 772 were foreign-born; (1910) 11,454. It is served by the Pennsylvania, the Philadelphia, Baltimore & Washington, the Philadelphia & Reading, and the Northern Central railways, and by interurban electric railways. The river here is about a mile wide, and a considerable portion of the borough is built on the slope of a hill which rises gently from the river-bank and overlooks beautiful scenery. The Pennsylvania railway has repair shops here, and among Columbia's manufactures are silk goods, embroidery and laces, iron and steel pipe, engines, laundry machinery, brushes, stoves, iron toys, umbrellas, flour, lumber and wagons; the city is also a busy shipping and trading centre. Columbia was first settled, by Quakers, in 1726; it was laid out as a town in 1787; and in 1814 it was incorporated. In 1790 it was one of several places considered in Congress for a permanent site of the national capital.

COLUMBIA, the capital city of South Carolina, U.S.A., and the county-seat of Richland county, on the E. bank of the Congaree river, a short distance below the confluence of the Saluda and the Broad rivers, about 130 m. N.W. of Charleston. Pop. (1890) 15,353; (1900) 21,108, of whom 9858 were negroes, and (1910) 26,319. It is served by the Atlantic Coast Line, the Southern, the Seaboard Air Line, and the Columbia, Newberry & Laurens railways. Columbia is picturesquely situated on the level top of a bluff overlooking the Congaree, which falls about 36 ft. in passing by, but is navigable for the remainder of its course. The surrounding country is devoted chiefly to cotton culture. The state house, United States government building and city hall are fine structures. Some of the new business houses are ten or more storeys in height. The state penitentiary and the state insane asylum are located here, and Columbia is an important educational centre, being the seat of the university of South Carolina, the Columbia College for women (Methodist Episcopal South, 1854), the College for women (Presbyterian, 1890), and the Presbyterian Theological Seminary (1828); and the Allen University (African Methodist Episcopal; coeducational, 1880), and the Benedict College (Baptist) for negroes. The University of South Carolina, organized in 1801 and opened in 1805, was known as South Carolina College in 1805-1863, 1878-1887 and 1891-1906, and as the university of South Carolina in 1866-1877, 1888-1891 and after 1906; in 1907-1908 it had departments of arts, science, pedagogy and law, an enrolment of 285 students, and a faculty of 25 instructors. By means of a canal abundant water power is furnished by the Congaree, and the city has some of the largest cotton mills in the world; it has, besides, foundries and machine shops and manufactories of fertilizers and hosiery. The manufactures under the factory system were valued at \$3,133,903 in 1900 and at \$4,676,944 in 1905—a gain, greater than that of any other city in the state, of 49.2% in five years. In the neighbourhood are several valuable granite quarries. The municipality owns and operates its water-works.

While much of the site was still a forest the legislature, in 1786, chose it for the new capital. It was laid out in the same year, and in 1790 the legislature first met here. Until 1805, when it was incorporated as a village, Columbia was under the direct government of the legislature; in 1854 it was chartered as a city. On the morning of the 17th of February 1865 General W. T. Sherman, on his march through the Carolinas, entered Columbia, and on the ensuing night a fire broke out which was not extinguished until most of the city was destroyed. The responsibility for this fire was charged by the Confederates upon the Federals and by the Federals upon the Confederates.

COLUMBIA, a city and the county-seat of Maury county, Tennessee, U.S.A., situated on the Duck river, in the central part of the state, 46 m. S. of Nashville. Ppp. (1890) 5370; (1900) 6052 (2716 negroes); (1910) 5754. Columbia is served by the Louisville & Nashville, and the Nashville, Chattanooga & St Louis railways. It is the seat of the Columbia Institute for girls (under Protestant Episcopal control), founded in 1836, and of the Columbia Military Academy. Columbia is in a fine farming

region; is engaged extensively in the mining and shipping of phosphates; has an important trade in live-stock, especially mules; manufactures cotton, lumber, flour, bricks, pumps and woollen goods; and has marble and stone works. Columbia was settled about 1807 and was incorporated in 1822. During the Civil War it was the base from which General N. B. Forrest operated in 1862-1863, and was alternately occupied by Confederate and Federal forces during General Hood's Nashville campaign (November-December 1864).

COLUMBIA RIVER, a stream of the north-west United States and south-west Canada, about 939 m. in length, draining a basin of about 250,000 sq. m., of which 38,395 are in British Columbia; some 105,000 sq. m. belong to the valley of the Snake and 11,700 to that of the Willamette. The source of the river is partly in the Yellowstone country, partly near the Teton peaks, and partly in the pine-clad mountains of British Columbia. Some American geographers regard the head as that of the Clark Fork, but it is most generally taken to be in British Columbia about 80 m. north of the United States line. From this point it runs some 150 m. to the north-west to the "Big Bend," and then in a great curve southward, enclosing the superb ranges of the Selkirks, crossing the international line near the boundary of Washington and Idaho, where it is joined by the Pend Oreille river, or Clark Fork, already referred to. This latter river rises in the Rocky Mountains west of Helena, Montana, falls with a heavy slope (1323 ft. in 167 m.) to its confluence with the Flathead, flows through Lake Pend Oreille (27 m.) in northern Idaho, and runs in deep canyons (falling 900 ft. in 200 m.) to its junction with the Columbia, which from this point continues almost due south for more than 106 m. Here the Columbia is joined by the Spokane, a large river with heavy fall, and enters the "Great Plain of the Columbia," an area of some 22,000 sq. m., resembling the "parks" of Colorado, shut in on all sides by mountains: the Moses range to the north, the Bitter Root and Cœur d'Alène on the east, the Blue on the south, and the Cascades on the west. The soil is rich, yielding great harvests of grain, and the mountains rich in minerals as yet only slightly prospected. After breaking into this basin the river turns sharply to the west and skirts the northern mountain barrier for about 105 m. Where it strikes the confines of the Cascades, it is joined by the Okanogan, turns due south in the second Big Bend, and flows about 200 m. to its junction with the Snake near Wallula.

After the confluence of the Snake with the Columbia the greater river turns west toward the Pacific. Throughout its course to this point it may be said that the Columbia has no flood plain; everywhere it is cutting its bed; almost everywhere it is characterized by canyons, although above the Spokane the valley is much broken down and there is considerable timbered and fertile bench land. Below the Spokane the canyon becomes more steep and rugged. From the mouth of the Okanogan to Priests Rapids extends a superb canyon, with precipitous walls of black columnar basalt 1000 to 3000 ft. in height. The finest portion is below the Rock Island Rapids. In this part of its course, along the Cascade range in the Great Plain and at its passage of the range westward, rapids and cascades particularly obstruct the imperfectly opened bed. In the lower Columbia, navigation is first interrupted 160 m. from the mouth at the Cascades, a narrow gorge across the Cascade range 4.5 m. long, where the river falls 24 ft. in 2500; the rapids are evaded by a canal constructed (1878-1896) by the Federal government, and by a portage railway (1890-1891). Fifty-three miles above this are the Dalles, a series of falls, rapids and rock obstructions extending some 12 m. and ending at Celilo, 115 m. below Wallula, with a fall of 20 ft. There are also impediments just below the mouth of the Snake; others in the lower course of this river below Riparia; and almost continuous obstructions in the Columbia above Priests Rapids. The commerce of the Columbia is very important, especially that from Portland, Vancouver, Astoria, and other outlets of the Willamette valley and the lower Columbia. The grain region of the Great Plain, the bottom-land orchards and grain field on the plateaus of the Snake, have not since 1880 been

dependent upon the water navigation for freighting, but in their interest costly attempts have been made to open the river below the Snake uninterruptedly to commerce.

The Columbia is one of the greatest salmon streams of the world (see OREGON). The tonnage of deep-sea vessels in and out over the bar at the river's mouth from 1890-1899 was 9,423,637 tons. From 1872-1899 the United States government expended for improvement of the Snake and Columbia \$6,925,649. The mouth of the latter is the only deep-water harbour between San Francisco and Cape Flattery (700 m.), and the only fresh water harbour of the Pacific coast. To facilitate its entrance, which, owing to bars, tides, winds, and the great discharge of the river, has always been difficult, a great jetty has been constructed (1885-1895, later enlarged) to scour the bars. It was about 4.5 miles long, and in 1903 work was begun to make it 2.5 miles longer. The tides are perceptible 150 m. above the mouth (mean tide at Astoria c. 6.2 ft.), the average tidal flow at the mouth being about 1,000,000 cub. ft. per second; while the fresh water outflow is from 90,000 to 300,000 cub. ft. according to the stage of water, and as high as 1,000,000 cub. ft. in time of flood. Improvements were undertaken by the Federal government and a state commission in 1902 in order to secure a 25-ft. channel from Portland to the sea.

In 1792, and possibly also in 1788, the river mouth was entered by Captain Robert Gray (1755-1806) of Boston, Mass., who named the river after his own vessel, "Columbia," which name has wholly supplanted the earlier name, "Oregon." In 1804-1805 the river was explored by Meriwether Lewis and William Clark. Upon these discoveries the United States primarily based its claim to the territory now embraced in the states of Oregon and Washington.

COLUMBIA UNIVERSITY, one of the oldest and most important of the higher institutions of learning in the United States, located for the most part on Morningside Heights, New York city. It embraces Columbia College, founded as King's College in 1754; a school of medicine (the College of Physicians and Surgeons) founded in 1767, in West 59th Street; a school of law, founded in 1858; schools of applied science, including a school of mines and schools of chemistry and engineering, separately organized in 1896; a school of architecture, organized in 1881; graduate schools of political science, organized in 1880, philosophy, organized in 1890, and pure science, organized in 1892; and a school of journalism; closely affiliated with it are the College of Pharmacy, founded in 1829, in West 68th Street; Teachers' College, founded in 1886, as the New York College for the Training of Teachers, and essentially a part of the university since 1899; and Barnard College (for women) founded in 1889, and essentially a part of the university since 1900. Reciprocal relations also exist between the university and both the General Theological Seminary of the Protestant Episcopal Church and the Union Theological Seminary, thus practically adding to the university a theological department. Columbia also nominates the American professors who lecture at German universities by the reciprocal arrangement made in 1905, the German professors lecturing in America being nominated by the Prussian ministry of education. Women are now admitted to all the university courses except those in law, medicine, technology and architecture. Since 1900 a summer session has been held for six weeks and attended largely by teachers. Teachers and others, under the direction of the Teachers' College, are afforded an opportunity to pursue courses *in absentia* and so meet some of the requirements for an academic degree or a teacher's diploma. All students of good ability are enabled to complete the requirements for the bachelor's degree together with any one of the professional degrees by six years of study at the university. Several courses of lectures designed especially for the public—notably the Hewitt Lectures, in co-operation with Cooper Union—are delivered at different places in the city and at the university.

In 1908 there were in Columbia University in all departments 609 instructors and 4096 students; of these 420 were in Barnard College, 850 were in the Teachers' College, and 229 were in the College of Pharmacy. The numerous University publications

include works embodying the results of original research published by the University Press; "Studies" published in the form of a series by each of several departments, various periodicals edited by some members of the faculty, such as the *Columbia University Quarterly*, the *Political Science Quarterly*, and the *School of Mines Quarterly*; and several papers or periodicals published by the students, among which are the *Columbia Spectator*, a daily paper, the *Columbia Law Review*, the *Columbia Monthly* and the *Columbia Jester*.

With two or three unimportant exceptions the buildings of the university on Morningside Heights have been erected since 1896. They include, besides the several department buildings, a library building, a university hall (with gymnasium), Earl Hall (for social purposes), St Paul's chapel (dedicated in 1907), two residence halls for men, and one for women. The library contains about 450,000 volumes exclusive of duplicates and unbound pamphlets. The highest authority in the government of the institution is vested in a board of twenty-four trustees, vacancies in which are filled by co-optation; but the immediate educational interests are directed largely by the members of the university council, which is composed of the president of the university, the dean and one other representative from the faculty of each school. The institution is maintained by the proceeds from an endowment fund exceeding \$15,000,000, by tuition fees ranging, according to the school, from \$150 to \$250 for each student, and by occasional gifts for particular objects.

The charter (1754) providing for the establishment of King's College was so free from narrow sectarianism as to name ministers of five different denominations for ex-officio governors, and the purpose of the institution as set forth by its first president, Dr Samuel Johnson (1696-1772) was about as broad as that now realised. In 1756 the erection of the first building was begun at the lower end of Manhattan Island, near the Hudson, and the institution prospered from the beginning. From 1776 to 1784, during the War of Independence, the exercises of the college were suspended and the library and apparatus were stored in the New York city hall. In 1784 the name was changed to Columbia College, and an act of the legislature was passed for creating a state university, of which Columbia was to be the basis. But the plan was not a success, and three years later, in 1787, the act was repealed and the administration of Columbia was entrusted to a board of trustees of which the present board is a successor. In 1857 there was an extensive re-organization by which the scope of the institution was much enlarged, and at the same time it was removed to a new site on Madison Avenue between 49th and 50th Streets. From 1890 to 1895 much centralization in its administration was effected, in 1896 the name of Columbia University was adopted, and in the autumn of 1897 the old site and buildings were again abandoned for new, this time on Morningside Heights.

See *A History of Columbia University*, by members of the faculty (New York, 1904); and J. B. Pine, "King's College, now Columbia University," in *Historic New York* (New York, 1897).

COLUMBINE (Ital. *columbina*, from *columba*, a dove), in pantomime (*q.v.*) the fairy-like dancer who is courted by Harlequin. In the medieval Italian popular comedy she was Harlequin's daughter.

COLUMBINE, an erect perennial herbaceous plant known botanically as *Aquilegia vulgaris* (natural order Ranunculaceae). In Med. Latin it was known as *Columbina sc. herba*, the dove's plant. The slender stem bears delicate, long-stalked, deeply divided leaves with blunt segments, and a loose panicle of handsome drooping blue or white flowers, which are characterized by having all the five petals spurred. The plant occurs wild in woods and thickets in England and Ireland, and flowers in early summer. It is well known in cultivation as a favourite spring flower, in many varieties, some of which have red flowers.

COLUMBITE, a rare mineral consisting of iron niobate, FeNb_2O_6 , in which the iron and niobium are replaced by varying amounts of manganese and tantalum respectively, the general formula being $(\text{Fe, Mn})(\text{Nb, Ta})_2\text{O}_6$. It was in this mineral that

Charles Hatchett discovered, in 1801, the element niobium, which he himself called columbium after the country (Columbia or America) whence came the specimen in the British Museum collection which he examined. The species has also been called niobite. It crystallizes in the orthorhombic system, and the black, opaque crystals are often very brilliant with a sub-metallic lustre. Twinned crystals are not uncommon, and there is a distinct cleavage parallel to the face marked *b* in the figure. Hardness 6; specific gravity 5.3. With increasing amount of tantalum the specific gravity increases up to 7.3, and members at this end of the series are known as tantalite (FeTa_2O_6). Specimens in which the iron is largely replaced by manganese are known as manganocolumbite or manganotantalite, according as they contain more niobium or more tantalum. Columbite occurs as crystals and compact masses in granite and pegmatite at Rabenstein in Lower Bavaria, the Ilmen Mountains in the Urals, Haddam in Connecticut, and several other localities in the United States; also in the cryolite of Greenland. Tantalite is from Finland, and it has recently been found in some abundance in the deposits of cassiterite in the tin-field of Greenbushes in the Blackwood district, Western Australia.

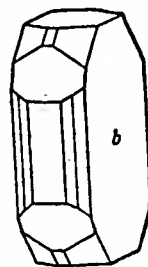

Crystal of Columbite.

Dimorphous with columbite and tantalite are the tetragonal minerals tapiolite (= skogbölite) and mossite, so that the four form an isodimorphous group with the general formula $(\text{Fe, Mn})(\text{Nb, Ta})_2\text{O}_6$. Mossite is from a pegmatite vein near Moss in Norway, and tapiolite is from Finland. All these minerals contain tin in small amount. (L. J. S.)

COLUMBIUM, or **NIObIUM** (symbol Cb or Nb, atomic weight 94), one of the metallic elements of the nitrogen group, first detected in 1801 by C. Hatchett in a specimen of columbite (niobite) from Massachusetts (*Phil. Trans.* 1802, 49). It is usually found associated with tantalum, the chief minerals containing these two elements being tantalite, columbite, fergusonite and ytrotantalite; it is also a constituent of pyrochlor, euxenite and samarskite. Columbium compounds are usually prepared by fusing columbite with an excess of acid potassium sulphate, boiling out the fused mass with much water, and removing tin and tungsten from the residue by digestion with ammonium sulphide, any iron present being simultaneously converted into ferrous sulphide. The residue is washed, extracted by dilute hydrochloric acid, and again well washed with boiling water. It is then dissolved in hydrofluoric acid and heated in order to expel silicon fluoride; finally the columbium, tantalum and titanium fluorides are separated by the different solubilities of their double fluorides (C. Marignac, *Ann. chim. et phys.* 1866 [4], 8, p. 63; 1868, 13, p. 28; see also W. Gibbs, *Jahresb.* 1864, p. 685; R. D. Hall and E. F. Smith, *Proc. Amer. Philos. Soc.* 1905, 44, p. 177).

The metal was first obtained by C. W. Blomstrand (*Journ. prak. Chem.* 1866, 97, p. 37) by reducing the chloride with hydrogen; it has more recently been prepared by H. Moissan by reducing the oxide with carbon in the electric furnace (the product obtained always contains from 2-3% of combined carbon), and by H. Goldschmidt and C. Vautin (*Journ. Soc. Chem. Industry*, 1898, 19, p. 543) by reducing the oxide with aluminium powder. As obtained by the reduction of the chloride, it is a steel grey powder of specific gravity 7.06. It burns on heating in air; and is scarcely attacked by hydrochloric or nitric acids, or by *aqua regia*; it is soluble in warm concentrated sulphuric acid.

Columbium hydride, CbH , is obtained as a greyish metallic powder, when the double fluoride, $\text{CbF}_6 \cdot 2\text{KF}$, is reduced with sodium. It burns when heated in air, and is soluble in warm concentrated sulphuric acid. Three oxides of columbium are certainly known, namely the *dioxide*, Cb_2O_2 , the *tetroxide*, Cb_2O_4 , and the *pentoxide*, Cb_2O_5 , whilst a fourth oxide, *columbium trioxide*, Cb_2O_3 , has been described by E. F. Smith and P. Maas (*Zeit. f. anorg. Chem.* 1894, 7, p. 97). *Columbium dioxide*, Cb_2O_2 , is formed when dry potassium columbium oxyfluoride is reduced by sodium (H. Rose, *Pogg. Ann.* 1858, 104, p. 312). It burns readily in air, and is converted into the pentoxide when fused with acid potassium sulphate. *Columbium*

tetroxide, Cb_2O_4 , is obtained as a black powder when the pentoxide is heated to a high temperature in a current of hydrogen. It is unattacked by acids. *Columbium pentoxide* (columbic acid), Cb_2O_5 , is obtained from columbite, after the removal of tantalum (see above). The mother liquors are concentrated, and the double salt of composition $2\text{KF}\cdot\text{CbOF}_3\cdot\text{H}_2\text{O}$, which separates, is decomposed by sulphuric acid, or by continued boiling with water (C. Marignac; see also G. Krüss and L. F. Nilson, *Ber.* 1887, 20, p. 1676). It is a white amorphous infusible powder, which when strongly heated in sulphuretted hydrogen, yields an oxysulphide. Several hydrated forms are known, yielding salts known as *columbates*. A *percolumbic acid*, $\text{HCbO}_4\cdot n\text{H}_2\text{O}$, has been prepared by P. Melikoff and L. Pissarjewsky (*Zeit. f. anorg. Chem.* 1899, 20, p. 341), as a yellow amorphous powder by the action of dilute sulphuric acid on the potassium salt, which is formed when columbic acid is fused in a silver crucible with eight times its weight of caustic potash (*loc. cit.*). Salts of the acid H_2CbO_5 have been described by C. W. Balke and E. F. Smith (*Jour. Amer. Chem. Soc.* 1908, 30, p. 1637).

Columbium trichloride, CbCl_3 , is obtained in needles or crystalline crusts, when the vapour of the pentachloride is slowly passed through a red-hot tube. When heated in a current of carbon dioxide it forms the oxychloride CbOCl_2 , and carbon monoxide. *Columbium pentachloride*, CbCl_5 , is obtained in yellow needles when a mixture of the pentoxide and sugar charcoal is heated in a current of air-free chlorine. It melts at 194°C . (H. Deville) and boils at $240\text{--}5^\circ\text{C}$. It is decomposed by water, and dissolves in hydrochloric acid. *Columbium oxychloride*, CbOCl_2 , is formed when carbon tetrachloride, and columbic acid are heated together at 440°C .: $3\text{CCl}_4 + \text{Cb}_2\text{O}_5 = 2\text{CbOCl}_2 + 3\text{COCl}_2$, and also by distilling the pentachloride, in a current of carbon dioxide, over ignited columbic acid. It forms a white silky mass which volatilizes at about 400°C . It deliquesces in moist air, and is decomposed violently by water. *Columbium pentafluoride*, CbF_5 , is obtained when the pentoxide is dissolved in hydrofluoric acid. It is only known in solution; evaporation of the solution yields the pentoxide. The *oxyfluoride*, CbOF_2 , results when a mixture of the pentoxide and fluor spar is heated in a current of hydrochloric acid. It forms many double salts with other metallic fluorides.

Columbium oxysulphide, CbOS_2 , is obtained as a dark bronze coloured powder when the pentoxide is heated to a white heat in a current of carbon bisulphide vapour; or by gently heating the oxychloride in a current of sulphuretted hydrogen. It burns when heated in air, forming the pentoxide and sulphur dioxide.

Columbium nitride, Cb_3N_2 (?), is formed when dry ammonia gas is passed into an ethereal solution of the chloride. A heavy white precipitate, consisting of ammonium chloride and columbium nitride, is thrown down, and the ammonium chloride is removed by washing it out with hot water, when the columbium nitride remains as an amorphous residue (Hall and Smith, *loc. cit.*).

Potassium fluoxy percolumbate, $\text{K}_2\text{CbO}_2\text{F}_3\cdot\text{H}_2\text{O}$, is prepared by dissolving potassium columbium oxyfluoride in a 3% solution of hydrogen peroxide. The solution turns yellow in colour, and, when saturated, deposits a pasty mass of crystals. The salt separates from solutions containing hydrofluoric acid in large plates, which are greenish yellow in colour.

The atomic weight was determined by C. Marignac (*Ann. chim. et phys.* 1866 (4), 8, p. 16) to be 94 from the analysis of potassium columbium oxyfluoride, and the same value has been obtained by T. W. Richards (*Journ. Amer. Chem. Soc.* 1898, 20, p. 543).

COLUMBUS, CHRISTOPHER [in Spanish CRISTOBAL COLÓN] (c. 1446, or perhaps rather 1451, -1506) was the eldest son of Domenico Colombo and Suzanna Fontanarossa, and was born at Genoa either about 1446 or in 1451, the exact date being uncertain. His father was a wool-comber, of some small means, who lived till 1498. According to the life of Columbus by his son Ferdinand (a statement supported by Las Casas), young Christopher was sent to the university of Pavia, where he devoted himself to astronomy, geometry and cosmography. Yet, according to the admiral's own statement, he became a sailor at fourteen. Evidently this statement, however, cannot mean the abandonment of all other employment, for in 1470, 1472, and 1473 we find him engaged in trade at Genoa, following the family business of weaving, and (in 1473) residing at the neighbouring Savona. In 1474-1475 he appears to have visited Chios, where he may have resided some time, returning to Genoa perhaps early in 1476. Thence he seems to have again set out on a voyage in the summer of 1476, perhaps bound for England; on the 13th of August 1476, the four Genoese vessels he accompanied were attacked off Cape St Vincent by a privateer, one Guillaume de Casenove, surnamed Coullon or Colombo ("Columbus"); two of the four ships escaped, with Christopher, to Lisbon. In December 1476, the latter resumed their voyage to England, probably carrying with them Columbus, who, after a short stay in England, claims to have made a voyage in the

northern seas, and even to have visited Iceland about February 1477. This last pretension is gravely disputed, but it is perhaps not to be rejected, and we may also trace the Genoese about this time at Bristol, at Galway, and probably among the islands west and north of Scotland. Soon after this he returned to Portugal, where (probably in 1478) he married a lady of some rank, Felipa Moñiz de Perestrello, daughter of Bartholomew Perestrello, a captain in the service of Prince Henry the Navigator, and one of the early colonists and first governor of Porto Santo. Felipa was also a cousin of the archbishop of Lisbon at this time (1478).

About 1479 Columbus visited Porto Santo, here as in Portugal probably employing his time in making maps and charts for a livelihood, while he pored over the logs and papers of his deceased father-in-law, and talked with old seamen of their voyages, and of the mystery of the western seas. About this time, too, if not earlier, he seems to have arrived at the conclusion that much of the world remained undiscovered, and step by step conceived that design of reaching Asia by sailing west which was to result in the discovery of America. In 1474 he is said to have corresponded with Paolo Toscanelli, the Florentine physician and cosmographer, and to have received from him valuable suggestions, both by map and letter, for such a Western enterprise. (The whole of this incident has been disputed by some recent critics.) He had perhaps already begun his studies in a number of works, especially the *Book of Marco Polo* and the *Imago Mundi* of Pierre d'Ailly, by which his cosmographical and geographical conceptions were largely moulded. His views, as finally developed and presented to the courts of Portugal and Spain, were supported by three principal lines of argument, derived from natural reasons, from the theories of geographers, and from the reports and traditions of mariners. He believed the world to be a sphere; he underestimated its size; he overestimated the size of the Asiatic continent. And the farther that continent extended towards the east, the nearer it came towards Spain. Nor were these theories the only supports of his idea. Martin Vicente, a Portuguese pilot, was said to have found, 400 leagues to the westward of Cape St Vincent, and after a westerly gale of many days' duration, a piece of strange wood, wrought, but not with iron; Pedro Correa, Columbus's own brother-in-law, was said to have seen another such waif at Porto Santo, with great canes capable of holding four quarts of wine between joint and joint, and to have heard of two men being washed up at Flores "very broad-faced, and differing in aspect from Christians." West of Europe, now and then, men fancied there hove in sight the mysterious islands of St Brandan, of Brazil, of Antillia or of the Seven Cities. In his northern journey, too, some vague and formless traditions may have reached the explorer's ear of the voyages of Leif Ericson and Thorfinn Karlsefne, and of the coasts of Markland and Vinland. All were hints and rumours to bid the bold mariner sail towards the setting sun, and this he at length determined to do.

The concurrence of some state or sovereign, however, was necessary for the success of this design. Columbus, on the accession of John II. of Portugal, seems to have entered the service of this country, to have accompanied Diego d'Azambuja to the Gold Coast, and to have taken part in the construction of the famous fort of St George at El Mina (1481-1482). On his return from this expedition, he submitted to King John the scheme he had now matured for reaching Asia by a western route across the ocean. The king was deeply interested in the rival scheme (of an eastern or south-eastern route round Africa to India) which had so long held the field, which had been initiated by the Genoese in 1291, and which had been revived, for Portugal, by Prince Henry the Navigator; but he listened to the Genoese, and referred him to a committee of council for geographical affairs. The council's report was adverse; but the king, who was yet inclined to favour the theory of Columbus, assented to the suggestion of the bishop of Ceuta that the plan should be carried out in secret and without its author's knowledge. A caravel was despatched; but it returned after a brief absence, the sailors

Idea of westero passage to Asia.

Quest of a patroa.

having lost heart, and refused to venture farther. Upon discovering this treachery, Columbus left Lisbon for Spain (1484), taking with him his son Diego, the only issue of his marriage with Felipa Moñiz, who was by this time dead. He departed secretly;—according to some writers, to give the slip to King John; according to others, to escape his creditors.

Columbus next betook himself to the south of Spain, and while meditating an appeal to the king of France, opened his plans to the count (from 1491, duke) of Medina Celi. The latter gave him great encouragement, entertained him for two years, and even determined to furnish him with three or four caravels, to carry out his great design. Finally, however, being deterred by the consideration that the enterprise was too vast for a subject, he turned his guest from the determination he had come to of making application at the court of France, by writing on his behalf to Queen Isabella; and Columbus repaired to the court at Cordova at her bidding (1486).

It was an ill moment for the navigator's fortune. Castile and Leon were in the thick of that struggle which resulted in the final conquest of the Granada Moors; and neither Ferdinand nor Isabella had time as yet to give due consideration to Columbus' proposals. The adventurer was indeed kindly received; he was handed over to the care of Alonso de Quintanilla, whom he speedily converted into an enthusiastic supporter of his theory. He made many other friends, and among them Beatriz Enriquez, the mother of his second son Fernando. But the committee, presided over by the queen's confessor, Fray Hernando de Talavera, which had been appointed to consider the new project, reported that it was vain and impracticable.

From Cordova Columbus followed the court to Salamanca, having already been introduced by Quintanilla to the notice of the grand cardinal, Pedro Gonzalez de Mendoza, "the third king of Spain"; the latter had befriended and supported the Genoese, and apparently arranged the first interview between him and Queen Isabella. At Salamanca prolonged discussions took place upon the questions now raised; the Dominicans of San Esteban entertained Columbus during the conferences (1486-1487). In 1487 Columbus, who had been following the court from place to place (billeted in towns as an officer of the sovereigns, and gratified from time to time with sums of money towards his expenses), was present at the siege of Malaga. In 1488 he was invited by the king of Portugal, his "especial friend," to return to that country, and was assured of protection against arrest or proceedings of any kind (March 20): he had probably made fresh overtures to King John shortly before; and in the autumn of 1488 we find him in Lisbon, conferring with his brother Bartholomew and laying plans for the future. We have no record of the final negotiations of Columbus with the Portuguese government, but they clearly did not issue in anything definite, for Christopher now returned to Spain (though not till he had witnessed the return of Bartholomew Diaz from the discovery of the Cape of Good Hope and his reception by King John), while Bartholomew proceeded to England with a mission to interest King Henry VII. in the Columbian schemes. If the London enterprise was unsuccessful (as indeed it proved), it was settled that Bartholomew should carry the same invitation to the French court. He did so; and here he remained till summoned to Spain in 1493. Meantime Christopher, unable throughout 1490 to get a hearing at the Spanish court, was in 1491 again referred to a *junta*, presided over by Cardinal Mendoza; but this *junta*, to Columbus' dismay, once more rejected his proposals; the Spanish sovereigns merely promised him that when the Granada war was over, they would reconsider what he had laid before them.

Columbus was now in despair. He at once betook himself to Huelva, a little maritime town in Andalusia, north-west of Cadiz, with the intention of taking ship for France. He halted, however, at the monastery of La Rabida, near Huelva, and still nearer Palos, where he seems to have made lasting friendships on his first arrival in Spain in January 1485, where he especially enlisted the support of Juan Perez, the guardian, who invited him to take up his quarters in the monastery, and

introduced him to Garcia Fernandez, a physician and student of geography. Juan Perez had been the queen's confessor; he now wrote to her in urgent terms, and was summoned to her presence; and money was sent to Columbus to bring him once more to court. He reached Granada in time to witness the surrender of the city (January 2, 1492), and negotiations were resumed. Columbus believed in his mission, and stood out for high terms; he asked for the rank of admiral at once ("Admiral of the Ocean" in all those islands, seas, and continents that he might discover), the vice-royalty of all he should discover, and a tenth of the precious metals discovered within his admiralty. These conditions were rejected, and the negotiations were again interrupted. An interview with Mendoza appears to have followed; but nothing came of it, and before the close of January 1492, Columbus actually set out for France. At length, however, on the entreaty of the Queen's confidante, the Marquesa de Moya, of Luis de Santangel, receiver of the ecclesiastical revenues of the crown of Aragon, and of other courtiers, Isabella was induced to determine on the expedition. A messenger was sent after Columbus, and overtook him near a bridge called "Pinos," 6 m. from Granada. He returned to the camp at Santa Fé, and on the 17th of April 1492, the agreement between him and their Catholic majesties was signed and sealed.

As his aims included not only the discovery of Cipangu or Japan, but also the opening up of intercourse with the grand khan of Cathay, he received a royal letter of introduction to the latter. The town of Palos was ordered to find him two ships, and these were soon placed at his disposal. But no crews could be got together, in spite of the indemnity offered to criminals and "broken men" who would serve on the expedition; and had not Juan Perez succeeded in interesting in the cause the Palos "magnates" Martin Alonso Pinzon and Vicente Yañez Pinzon, Columbus' departure had been long delayed. At last, however, men, ships and stores were ready. The expedition consisted of the "Santa Maria," a decked ship of 100 tons with a crew of 52 men, commanded by the admiral in person; and of two caravels; the "Pinta" of 50 tons, with 18 men, under Martin Pinzon; and the "Niña," of 40 tons, with 18 men, under his brother Vicente Yañez, afterwards (1499) the first to cross the line in the American Atlantic.

The adventurers numbered 88 souls; and on Friday, the 3rd of August 1492, at eight in the morning, the little fleet weighed anchor, and stood for the Canary Islands. An abstract of the admiral's diary made by Las Casas is yet extant; and from it many particulars may be gleaned concerning this first voyage. First voyage. Three days after the ships had set sail the "Pinta" lost her rudder; the admiral was in some alarm, but comforted himself with the reflection that Martin Pinzon was energetic and ready-witted; they had, however, to put in at Tenerife, to refit the caravel. On the 6th of September they weighed anchor once more with all haste, Columbus having been informed that three Portuguese caravels were on the look-out to intercept him. On the 13th of September the westerly variations of the magnetic needle were for the first time observed; on the 15th a meteor fell into the sea at four or five leagues distance; soon after they arrived at those vast plains of seaweed called the Sargasso Sea; while all the time, writes the admiral, they had most temperate breezes, the sweetness of the mornings being especially delightful, the weather like an Andalusian April, and only the song of the nightingale wanting. On the 17th the men began to murmur; they were frightened by the strange phenomena of the variation of the compass, but the explanation Columbus gave restored their tranquillity. On the 18th they saw many birds, and a great ridge of low-lying cloud; and they expected to see land. On the 20th they saw boobies and other birds, and were sure the land must be near. In this, however, they were disappointed; and thenceforth Columbus, who was keeping all the while a double reckoning, one for the crew and one for himself, had great difficulty in restraining the evil-disposed from the excesses they meditated. On the 25th Martin Alonso Pinzon raised the cry of land, but it proved false, as did the rumour to the same

effect on the 7th of October, from the "Niña." But on the 11th the "Pinta" fished up a cane, a pole, a stick which appeared to have been wrought with iron, and a board, while the "Niña" sighted a branch covered with berries; "and with these signs all of them breathed and were glad." At ten o'clock on that

night Columbus himself perceived and pointed out *America discovered.* a light ahead, and at two in the morning of Friday, the 12th of October 1492, Rodrigo de Triana, a sailor aboard the "Niña," announced the appearance of what proved to be the New World. The land sighted was an island, called by the Indians Guanahani, and named by Columbus San Salvador. It is generally identified with Watling Island.

The same morning Columbus landed, richly clad, and bearing the royal banner of Spain. He was accompanied by the brothers Pinzon, bearing banners of the Green Cross (a device of the admiral's), and by great part of the crew. When they all had "given thanks to God, kneeling upon the shore, and kissed the ground with tears of joy, for the great mercy received," the admiral named the island, and took solemn possession of it for their Catholic majesties of Castile and Leon. At the same time such of the crews as had shown themselves doubtful and mutinous sought his pardon weeping, and prostrated themselves at his feet.

Into the remaining detail of this voyage, of highest interest as it is, it is impossible to go further. It will be enough to say that it resulted in the discovery of the islands of Santa Maria de la Concepcion (Rum Cay), Fernandina (Long Island), Isabella (Crooked Island), Cuba or *Juana* (named by Columbus in honour of the young prince of Spain), and Hispaniola, Haiti, or San Domingo. Of the last of these the "Santa Maria" went aground, owing to the carelessness of the steersman. No lives were lost, but the ship had to be unloaded and abandoned; and Columbus, who was anxious to return to Europe with the news of his achievement, resolved to plant a colony on the island, to build a fort out of the material of the stranded hulk, and to leave the crew. The fort was called La Navidad; 44 Europeans were placed in charge. On the 4th of January 1493 Columbus, who had lost sight of Martin Pinzon, set sail alone in the "Niña" for the east; and two days afterwards the "Pinta" joined her sister-ship. A storm, however, separated the vessels, and it was not until the 18th of February that Columbus reached the island of Santa Maria in the Azores. Here he was threatened with capture by the Portuguese governor, who could not for some time be brought to recognize his commission. On the 24th of February, however, he was allowed to proceed, and on the 4th of March the "Niña" dropped anchor off Lisbon. The king of Portugal received the admiral with the highest honours. On the 13th of March the "Niña" put out from the Tagus, and two days afterwards, Friday, the 15th of March, she reached Palos.

The court was at Barcelona; and thither, after despatching a letter announcing his arrival, Columbus proceeded in person. He entered the city in a sort of triumphal procession, was received by their majesties in full court, and, seated in their presence, related the story of his wanderings, exhibiting the "rich and strange" spoils of the new-found lands,—the gold, the cotton, the parrots, the curious arms, the mysterious plants, the unknown birds and beasts, and the Indians he had brought with him for baptism. All his honours and privileges were confirmed to him; the title of Don was conferred on himself and his brothers; he rode at the king's bridle; he was served and saluted as a grandee of Spain. A new and magnificent scutcheon was also blazoned for him (4th May 1493), whereon the royal castle and lion of Castile and Leon were combined with the five anchors of his own coat of arms. Nor were their Catholic highnesses less busy on their own account than on that of their servant. On the 3rd and 4th of May Alexander VI. granted bulls confirming to the crowns of Castile and Leon all the lands discovered, or to be discovered, west of a line of demarcation drawn 100 leagues west of the Azores, on the same terms as those on which the Portuguese held their colonies along the African coast. A new expedition was got in readiness with all possible despatch, to secure and extend the discoveries already made.

After several delays the fleet weighed anchor on the 24th of September 1493 and steered westwards. It consisted of three great carracks (galleons) and fourteen caravels (light frigates), having on board over 1500 men, besides the animals and materials necessary for colonization. *Second voyage.*

Twelve missionaries accompanied the expedition, under the orders of Bernardo Buil or Boil, a Benedictine; Columbus had been already directed (29th May 1493) to endeavour by all means in his power to Christianize the inhabitants of the islands, to make them presents, and to "honour them much", while all under him were commanded to treat them "well and lovingly" under pain of severe punishment. On the 13th of October the ships, which had put in at the Canaries, left Ferro; and on Sunday, the 3rd of November, after a single storm, "by the goodness of God and the wise management of the admiral" an island was sighted to the west, which was named Dominica. Northwards from this the isles of Marigalante and Guadalupe were next discovered and named; while on the north-western course to La Navidad those of Montserrat, Antigua, San Martin, Santa Cruz and the Virgin Islands were sighted, and the island now called Porto Rico was touched at, hurriedly explored, and named San Juan Bautista. On the 22nd of November Columbus came in sight of Hispaniola, and sailing westward to La Navidad, found the fort burned and the colony dispersed. He decided on building a second fort, and coasting on 30 m. east of Monte Cristi, he pitched on a spot where he founded the city of Isabella.

The climate proved unhealthy; the colonists were greedy of gold, impatient of control, proud, ignorant and mutinous; and Columbus, whose inclination drew him westward, was doubtless glad to escape the worry and anxiety of his post, and to avail himself of the instructions of his sovereigns as to further discoveries. On the 2nd of February 1494 he sent home, by Antonio de Torres, that despatch to their Catholic highnesses by which he may be said to have founded the West Indian slave trade. He established the mining camp of San Tomaso in the gold country of Central Hispaniola; and on the 24th of April 1494, having nominated a council of regency under his brother Diego, and appointed Pedro Margarit his captain-general, he again put to sea. After following the southern shore of Cuba for some days, he steered southwards, and discovered (May 14th) the island of Jamaica, which he named Santiago. He then resumed his exploration of the Cuban coast, threaded his way through a labyrinth of islets which he named the Garden of the Queen (Jardin de la Reyna), and, after coasting westwards for many days, became convinced that he had discovered continental land. He therefore caused Perez de Luna, the notary, to draw up a document to this effect (12th of June 1494), which was afterwards taken round and signed (the admiral's steward witnessing) by the officers, men and boys of his three caravels, the "Niña," the "Cordera," and the "San Juan." He then stood to the south-east, and sighted the island of Evangelista (now Isla de los Pinos), revisited Jamaica, coasted the south of Hispaniola, and on the 24th of September touched at and named the island of La Mona, in the channel between Hispaniola and Porto Rico. Thence he had intended to sail eastwards and complete the survey of the Caribbean Archipelago; but he was exhausted by the terrible tear and wear of mind and body he had undergone (he says himself that on this expedition he was three-and-thirty days almost without sleep), and on the day following his departure from La Mona he fell into a lethargy, that deprived him of sense and memory, and had well-nigh proved fatal to life. At last, on the 29th of September, the little fleet dropped anchor off Isabella, and in his new city the admiral lay sick for five months.

The colony was in a sad plight. Every one was discontented, and many were sick, for the climate was unhealthy and there was nothing to eat. Margarit and Boil had deserted the settlement and fled to Spain, but ere his departure the former, in his capacity of captain-general, had done much to outrage and alienate the Indians. The strongest measures were necessary to undo this mischief, and, backed by his brother Bartholomew, Columbus proceeded to reduce the natives under Spanish sway.

Alonso de Ojeda succeeded by a brilliant *coup de main* in capturing the cacique Caonabo, and the rest submitted. Five ship-loads of Indians were sent off to Seville (24th June 1495) to be sold as slaves; and a tribute was imposed upon their fellows, which must be looked upon as the origin of that system of *repartimientos* or *encomiendas* which was afterwards to work such mischief among the conquered. In October 1495 Juan Aguado arrived at Isabella, with a royal commission to report on the state of the colony; here he took up the position of a judge of Columbus's government; and much recrimination followed. Columbus decided to return home; he appointed his brother Bartholomew *adelantado* of the island; and on the 10th of March 1496 he quitted Hispaniola in the "Niña." The vessel, after a protracted and perilous voyage, reached Cadiz on the 11th of June 1496, where the admiral landed, wearing the habit of a Franciscan. He was cordially received by his sovereigns, and a new fleet of eight vessels was put at his disposal. By royal patent, moreover, a tract of land in Hispaniola, of 50 leagues by 20, was offered to him, with the title of duke or marquis (which he declined); for three years he was to receive an eighth of the gross and a tenth of the net profits on each voyage; the right of creating a *mayorazgo* or perpetual entail of titles and estates was granted him; and his two sons were received into Isabella's service as pages.

Meanwhile, however, the preparing of the fleet proceeded slowly, and it was not till the 30th of May 1498 that he set sail with his main fleet of six ships—two caravels had already been sent on ahead. From San Lucar he steered for Porto Santo, Madeira, and Gomera, despatching three vessels direct from the Canaries to Hispaniola. He next proceeded to the Cape Verde Islands, which he quitted on the 5th of July. On the 31st of the same month, being greatly in need of water, and fearing that no land lay westwards as he had hoped, Columbus had turned his ship's head north, when Alonso Perez de Huelva saw land about 15 leagues to the south-west. It was crowned with three hill-tops, from which circumstance, and in fulfilment of a vow made at starting (to name the first land discovered on this voyage in honour of the Trinity), the admiral named it Trinidad, which name it yet bears. On Wednesday, the 1st of August, he beheld for the first time the mainland of South America, the continent he had sought so long. It seemed to him but an insignificant island, and he called it Isla Santa. Sailing westwards, next day he saw the Gulf of Paria (named by him the Golfo de la Ballena), into which he was borne at immense risk on the ridge of waters formed by the meeting of the sea and the Orinoco estuaries. For several days he coasted the continent, esteeming as islands the various projections he saw, and naming them accordingly, nor was it until he had realized the volume poured out by the Orinoco that he began to perceive the truly continental character of his last discovery. He was now anxious to revisit the colony in Hispaniola; and after sighting Tobago, Grenada, and Margarita, made for San Domingo, the new capital of the settlement, where he arrived on the 31st of August. He found that affairs had not prospered well in his absence. By the vigour and activity of the *adelantado*, the whole island had been reduced under Spanish sway; but under the leadership of Francisco Roldan the malcontent settlers had risen in revolt, and Columbus had to compromise matters in order to restore peace. Roldan retained his office of chief justice; and such of his followers as chose to remain in the island were gratified with *repartimientos* of land and labour.

At home, however, court favour had turned against Columbus. For one thing, the ex-colonists were often bitterly hostile to the admiral and his brothers. They were wont to parade their grievances in the very court-yards of the Alhambra, to surround the king when he came forth with complaints and reclamations, to insult the discoverer's young sons with shouts and jeers. Again, the queen began to criticize severely the shipment of Indians from the new-found lands to Spain. And once more, there was no doubt that the colony itself, whatever the cause, had not prospered so well as might have been desired. Fer-

dinand's support of Columbus had never been very hearty, and his inclination to supersede the Genoese now prevailed over the queen's friendliness. Accordingly, on the 21st of May 1499, Francisco Bobadilla was appointed governor and judge of Hispaniola during royal pleasure, with authority to examine into all complaints. Columbus was ordered to deliver up his charge to Bobadilla, and to accept whatever the latter should deliver him from the sovereigns. Bobadilla left Spain in June 1500, and landed in Hispaniola on the 23rd of August.

Columbus, meanwhile, had restored such tranquillity as was possible in his government. With Roldan's help he had beaten off an attempt on the island of the adventurer Ojeda, his old lieutenant; the Indians were being collected into villages and Christianized. Gold-mining was profitably pursued; in three years, he calculated, the royal revenues might be raised to an average of 60,000,000 reals. The arrival of Bobadilla, however, speedily changed this state of affairs. On landing, he took possession of the admiral's house and summoned him and his brothers before him. Accusations of severity, of injustice, of venality even, were poured down on their heads, and Columbus anticipated nothing less than a shameful death. Bobadilla put all three in irons, and shipped them off to Spain.

Alonso Vallejo, captain of the caravel in which the illustrious prisoners sailed, still retained a proper sense of the honour and respect due to Columbus, and would have removed the fetters; but to this Columbus would not consent. He would wear them, he said, until their highnesses, by whose order they had been affixed, should order their removal; and he would keep them afterwards "as relics and as memorials of the reward of his service." He did so. His son Fernando "saw them always hanging in his cabinet, and he requested that when he died they might be buried with him." Whether this last wish was complied with is not known.

A heart-broken and indignant letter from Columbus to Doña Juana de Torres, formerly nurse of the infante Don Juan, arrived at court before the despatch of Bobadilla. It was read to the queen, and its tidings were confirmed by communications from Alonso Vallejo and the alcaide of Cadiz. There was a great movement of indignation; the tide of popular and royal feeling turned once more in the admiral's favour. He received a large sum to defray his expenses; and when he appeared at court, on the 17th of December 1500, he was no longer in irons and disgrace, but richly apparelled and surrounded with friends. He was received with all honour and distinction. The queen is said to have been moved to tears by the narration of his story. Their majesties not only repudiated Bobadilla's proceedings, but declined to inquire into the charges that he at the same time brought against his prisoners, and promised Columbus compensation for his losses and satisfaction for his wrongs. A new governor, Nicolas de Ovando, was appointed, and left San Lucar on the 13th of February 1502, with a fleet of thirty ships, to supersede Bobadilla. The latter was to be impeached and sent home; the admiral's property was to be restored; and a fresh start was to be made in the conduct of colonial affairs. Thus ended Columbus's history as viceroy and governor of the new Indies which he had presented to the country of his adoption.

His hour of rest, however, was not yet come. Ever anxious to serve their Catholic highnesses, "and particularly the queen," he had determined to find a strait through which he might penetrate westwards into Portuguese Asia. Fourth voyage. After the usual inevitable delays his prayers were granted, and on the 9th of May 1502, with four caravels and 150 men, he weighed anchor from Cadiz, and sailed on his fourth and last great voyage. He first betook himself to the relief of the Portuguese fort of Arzilla, which had been besieged by the Moors, but the siege had been raised before he arrived. He put to sea westwards once more, and on the 15th of June discovered the island of Martinino (probably St Lucia). He had received positive instructions from his sovereigns on no account to touch at Hispaniola; but his largest caravel was greatly in need of repairs, and he had no choice but to abandon her or disobey orders. He preferred the latter alternative, and sent a boat

ashore to Ovando, asking for a new ship and for permission to enter the harbour to weather a hurricane which he saw was coming on. But his requests were refused, and he coasted the island, casting anchor under lee of the land. Here he weathered the storm, which drove the other caravels out to sea, and annihilated the homeward-bound fleet; the richest that had till then been sent from Hispaniola. Roldan and Bobadilla perished with others of the admiral's enemies; and Fernando Columbus, who accompanied his father on this voyage, wrote long afterwards, "I am satisfied it was the hand of God, for had they arrived in Spain they had never been punished as their crimes deserved, but rather been favoured and preferred."

After recruiting his flotilla at Azua, Columbus put in at Jaquimo and refitted his four vessels; and on the 14th of July 1502 he steered for Jamaica. For several days the ships wandered painfully among the keys and shoals he had named the Garden of the Queen, and only an opportune easterly wind prevented the crews from open mutiny. The first land sighted (July 30th) was the islet of Guanaja, about 40 m. east of the coast of Honduras. Here he got news from an old Indian of a rich and vast country lying to the eastward, which he at once concluded must be the long-sought-for empire of the grand khan. Steering along the coast of Honduras, great hardships were endured, but nothing approaching his ideal was discovered. On the 12th of September Cape Gracias-a-Dios was rounded. The men had become clamorous and insubordinate; not until the 5th of December, however, would he tack about and retrace his course. It now became his intention to plant a colony on the river Veragua, which was afterwards to give his descendants a title of nobility; but he had hardly put about when he was caught in a storm, which lasted eight days, wrenched and strained his crazy, worm-eaten ships severely, and finally, on Epiphany Sunday 1503, blew him into an embouchure which he named Belem or Bethlehem. Gold was very plentiful in this place, and here he determined to found his settlement. By the end of March 1503 a number of huts had been run up, and in these the *adelantado* (Bartholomew Columbus), with 80 men, was to remain, while Christopher returned to Spain for men and supplies. Quarrels, however, arose with the natives; the cacique was made prisoner, but escaped again; and before Columbus could leave the coast he had to abandon a caravel, to take the settlers on board, and to relinquish the enterprise of colonization. Steering eastwards, he left a second caravel at Puerto Bello; he thence bore northwards for Cuba, where he obtained supplies from the natives. From Cuba he bore up for Jamaica, and there, in the harbour of San Gloria, now St Ann's Bay, he ran his ships aground in a small inlet still called Don Christopher's Cove (June 23rd, 1503).

The expedition was received with great kindness by the natives, and here Columbus remained upwards of a year, awaiting the return of his lieutenant Diego Mendez, whom he had despatched to Ovando for assistance. During his critical sojourn here, the admiral suffered much from disease and from the lawlessness of his followers, whose misconduct had alienated the natives, and provoked them to withhold their accustomed supplies, until he dexterously worked upon their superstitions by prognosticating an eclipse. Two vessels having at last arrived for his relief, Columbus left Jamaica on the 28th of June 1504, and, after calling at Hispaniola, set sail for Spain on the 12th of September. After a tempestuous voyage he landed once more at San Lucar on the 7th of November 1504.

As he was too ill to go to court, his son Diego was sent thither in his place, to look after his interests and transact his business. Letter after letter followed the young man from Seville—one by the hands of Amerigo Vespucci. A licence to ride on mule-back was granted him on the 23rd of February 1505; and in the following May he was removed to the court at Segovia, and thence again to Valladolid. On the landing of Philip and Juana at Coruña (25th of April 1506), although "much oppressed with the gout and troubled to see himself put by his rights," he is known to have sent off the *adelantado* to pay them his duty and to assure them that he was yet able to do them extraordinary

service. The last documentary note of him is contained in a final codicil to the will of 1498, made at Valladolid on the 19th of May 1506. By this the old will is confirmed; the *mayorazgo* is bequeathed to his son Diego and his heirs male, failing these to Fernando, his second son, and failing these to the heirs male of Bartholomew; only in case of the extinction of the male line, direct or collateral, is it to descend to the females of the family; and those into whose hands it may fall are never to diminish it, but always to increase and ennoble it by all means possible. The head of the house is to sign himself "The Admiral." A tenth of the annual income is to be set aside yearly for distribution among the poor relations of the house. A chapel is founded and endowed for the saying of masses. Beatriz Enriquez is left to the care of the young admiral. Among other legacies is one of "half a mark of silver to a Jew who used to live at the gate of the Jewry, in Lisbon." The codicil was written and signed with the admiral's own hand. Next day (20th of May 1506) he died.

After the funeral ceremonies at Valladolid, Columbus's remains were transferred to the Carthusian monastery of Santa Maria de las Cuevas, Seville, where the bones of his son Diego, the second admiral, were also laid. Exhumed in 1542, the bodies of both father and son were taken over sea to Hispaniola and interred in the cathedral of San Domingo. In 1795-1796, on the cession of that island to the French, the relics were re-exhumed and transferred to the cathedral of Havana, whence, after the Spanish-American War of 1898 and the loss of Cuba, they were finally removed to Seville cathedral, where they remain. The present heir and representative of Columbus belongs to the Larreategui family, descendants of the discoverer through the female line, and retains the titles of admiral and duke of Veragua.

Columbus Cipher.

The interpretation of the seven-lettered cipher, accepting the smaller letters of the second line as the final ones of the words, seems to be *Salve Christus, Maria, Yosephus*. The name *Christopher* (*Christoferens*) appears in the last line.

In person Columbus was tall and shapely. The only authentic portrait of him is that which once belonged to Paulus Jovius, and is still in the possession of the de Orchi family (related to Jovius by female descent) at Como. It shows us a venerable man with clean-shaven face, thin grey hair, high forehead, sad thoughtful eyes. It bears the inscription *Columbus Lygur. novi orbis reperiitor*.

AUTHORITIES.—Fernando Columbus, *Historie del Signor Don Fernando Colombo . . . e vera relatione della vita . . . dell' Ammiraglio D. Christoforo Colombo* (the Spanish original of this, written before 1539, is lost; only the Italian version remains, first published at Venice in 1571; a good edition appeared in London in 1867); Bartolomé de las Casas, *Historia de las Indias*, written 1527-1561, but first printed at Madrid in 1875, after remaining in manuscript more than three centuries; Andres Bernandez, *Historia de los Reyes Catolicos* (contemporary with Fernando Columbus's *Historie*, but first printed at Granada in 1856; best edition, Seville, 1870); Gonzalo Fernandez Oviedo y Valdes, *Historia general de las Indias* (Seville, 1535; best edition, Madrid, 1851-1855); Peter Martyr d'Anghiera, *Opus Epistolarum*, first published in 1530, and *De Orbe Novo (Decades)*, printed in 1511 and 1530; Francisco Lopez de Gomara, *Historia general de las Indias* (Saragossa, 1552-1553, and Antwerp, 1554); Antonio de Herrera, *Historia general de las Indias occidentales* (publication first completed in 1615, but best edition perhaps that of 1730, Madrid); Juan Bautista Muñoz, *Historia del Nuevo Mundo* (Madrid, 1793); Martin Fernandez Navarrete, *Coleccion de los Viajes y descubrimientos que hicieron por mar los Españoles* (Madrid, 1825-1837); Washington Irving, *History of the Life and Voyages of Christopher Columbus* (London, 1827-1828); Alex. von Humboldt, *Examen critique* (Paris, 1836-1839); R. H. Major, *Select Letters of*

Columbus (London, Hakluyt Society, 1847); Fernandez Duro, *Colon y Pinzon* (Madrid, 1883); Henry Harrisse, *Christophe Colomb* (Paris, 1884), and *Christophe Colomb devant l'histoire* (Paris, 1892); Justin Winsor, *Christopher Columbus* (Cambridge, Mass., 1891); José Maria Asensio, *Cristóbal Colon* (Barcelona, 1892); Clements R. Markham, *Life of Christopher Columbus* (London, 1892); John Fiske, *Discovery of America* (Boston and New York, 1892); E. J. Payne, *History of the New World called America*, vol. i. (Oxford, 1892); Paul Gaffarel, *Histoire de la découverte de l'Amérique* (Paris, 1892); Charles I. Elton, *Career of Columbus* (London, 1892); *Raccolta Colombiana* (1892, &c.); Sophus Ruge, *Columbus* (Berlin, 1902); John Boyd Thatcher, *Christopher Columbus* (New York, 1903-1904); Henry Vignaud, *La Lettre et la carte de Toscanelli* (Paris, 1901), and *Études critiques sur la vie de Colomb avant ses découvertes* (Paris, 1905); Filson Young, *Christopher Columbus and the New World of his discovery* (London, 1906). (C. R. B.)

COLUMBUS, a city and the county-seat of Muscogee county, Georgia, U.S.A., on the E. bank and at the head of navigation of the Chattahoochee river, about 100 m. S.S.W. of Atlanta. Pop. (1890) 17,303; (1900) 17,614, of whom 7267 were negroes; (1910, census) 20,554. There is also a considerable suburban population. Columbus is served by the Southern, the Central of Georgia, and the Seaboard Air Line railways, and three steamboat lines afford communication with Apalachicola, Florida. The city has a public library. A fall in the river of 115 ft. within a mile of the city furnishes a valuable water-power, which has been utilized for public and private enterprises. The most important industry is the manufacture of cotton goods; there are also cotton compresses, iron works, flour and woollen mills, wood-working establishments, &c. The value of the city's factory products increased from \$5,061,485 in 1900 to \$7,079,702 in 1905, or 39.9%; of the total value in 1905, \$2,759,081, or 39%, was the value of the cotton goods manufactured. There are many large factories just outside the city limits. Columbus was one of the first cities in the United States to maintain, at public expense, a system of trade schools. It has a large wholesale and retail trade. The city was founded in 1827 and was incorporated in 1828. In the latter year Mirabeau Buonaparte Lamar (1798-1859) established here the *Columbus Independent*, a State's-Rights newspaper. For the first twenty years the city's leading industry was trade in cotton. As this trade was diverted by the railways to Savannah, the water-power was developed and manufactories were established. During the Civil War the city ranked next to Richmond in the manufacture of supplies for the Confederate army. On the 16th of April 1865 it was captured by a Union force under General James Harrison Wilson (b. 1837); 1200 Confederates were taken prisoners; large quantities of arms and stores were seized, and the principal manufactories and much other property were destroyed.

COLUMBUS, a city and the county-seat of Bartholomew county, Indiana, U.S.A., situated on the E. fork of White river, a little S. of the centre of the state. Pop. (1890) 6719; (1900) 8130, of whom 313 were foreign-born and 224 were of negro descent (1910 census) 8813. In 1900 the centre of population of the United States was 5 m. S.E. of Columbus. The city is served by the Cleveland, Cincinnati, Chicago & St. Louis, and the Pittsburg, Cincinnati, Chicago & St. Louis railways, and is connected with Indianapolis and with Louisville, Ky., by an electric interurban line. Columbus is situated in a fine farming region, and has extensive tanneries, threshing-machine and traction and automobile engine works, structural iron works, tool and machine shops, canneries and furniture factories. In 1905 the value of the city's factory product was \$2,983,160, being 28.4% more than in 1900. The water-supply system and electric-lighting plant are owned and operated by the city.

COLUMBUS, a city and the county-seat of Lowndes county, Mississippi, U.S.A., on the E. bank of the Tombigbee river, at the head of steam navigation, 150 m. S. E. of Memphis, Tennessee. Pop. (1890) 4559; (1900) 6484 (3366 negroes); (1910) 8988. It is served by the Mobile & Ohio and the Southern railways, and by passenger and freight steamboat lines. It has cotton and knitting mills, cotton-seed oil factories, machine shops, and wagon, stove, plough and fertilizer factories; and is a market

and jobbing centre for a fertile agricultural region. It has a public library, and is the seat of the Mississippi Industrial Institute and College (1885) for women, the first state college for women—the successor of the Columbus Female Institute (1848)—of Franklin Academy (1821), and of the Union Academy (1873) for negroes. The site was first settled about 1818; the city was incorporated in 1821, and in 1830 it became the county-seat of the newly formed Lowndes county. During the Civil War the legislature met here in 1863 and 1865, and in the former year Governor Charles Clark (1810-1877) was inaugurated here.

COLUMBUS, a city, a port of entry, the capital of Ohio, U.S.A., and the county-seat of Franklin county, at the confluence of the Scioto and Olentangy rivers, near the geographical centre of the state, 120 m. N.E. of Cincinnati, and 138 m. S.S.W. of Cleveland. Pop. (1890) 88,150; (1900) 125,560, of whom 12,328 were foreign-born and 8201 were negroes; (1910) 181,511. Columbus is an important railway centre and is served by the Cleveland, Cincinnati, Chicago & St. Louis, the Pittsburg, Cincinnati, Chicago & St. Louis (Pennsylvania system), the Baltimore & Ohio, the Ohio Central, the Norfolk & Western, the Hocking Valley, and the Cleveland, Akron & Columbus (Pennsylvania system) railways, and by nine interurban electric lines. It occupies a land area of about 17 sq. m., the principal portion being along the east side of the Scioto in the midst of an extensive plain. High Street, the principal business thoroughfare, is 100 ft. wide, and Broad Street, on which are many of the finest residences, is 120 ft. wide, has four rows of trees, a roadway for heavy vehicles in the middle, and a driveway for carriages on either side.

The principal building is the state capitol (completed in 1857) in a square of ten acres at the intersection of High and Broad streets. It is built in the simple Doric style, of grey limestone taken from a quarry owned by the state, near the city; is 304 ft. long and 184 ft. wide, and has a rotunda 158 ft. high, on the walls of which are the original painting, by William Henry Powell (1823-1879), of O. H. Perry's victory on Lake Erie, and portraits of most of the governors of Ohio. Other prominent structures are the U.S. government and the judiciary buildings, the latter connected with the capitol by a stone terrace, the city hall, the county court house, the union station, the board of trade, the soldiers' memorial hall (with a seating capacity of about 4500), and several office buildings. The city is a favourite meeting-place for conventions. Among the state institutions in Columbus are the university (see below), the penitentiary, a state hospital for the insane, the state school for the blind, and the state institutions for the education of the deaf and dumb and for feeble-minded youth. In the capitol grounds are monuments to the memory of Ulysses S. Grant, Rutherford B. Hayes, James A. Garfield, William T. Sherman, Philip H. Sheridan, Salmon P. Chase, and Edwin M. Stanton, and a beautiful memorial arch (with sculpture by H. A. M'Neil) to William McKinley.

The city has several parks, including the Franklin of 90 acres, the Goodale of 44 acres, and the Schiller of 24 acres, besides the Olentangy, a well-equipped amusement resort on the banks of the river from which it is named, the Indianola, another amusement resort, and the United States military post and recruiting station, which occupies 80 acres laid out like a park. The state fair grounds of 115 acres adjoin the city, and there is also a beautiful cemetery of 220 acres.

The Ohio State University (non-sectarian and co-educational), opened as the Ohio Agricultural and Mechanical College in 1873, and reorganized under its present name in 1878, is 3 m. north of the capitol. It includes colleges of arts, philosophy and science, of education (for teachers), of engineering, of law, of pharmacy, of agriculture and domestic science, and of veterinary medicine. It occupies a campus of 110 acres, has an adjoining farm of 325 acres, and 18 buildings devoted to instruction, 2 dormitories, and a library containing (1906) 67,709 volumes, besides excellent museums of geology, zoology, botany and archaeology and history, the last being owned jointly by the university and by

the state archaeological and historical society. In 1908 the faculty numbered 175, and the students 2277. The institution owed its origin to federal land grants; it is maintained by the state, the United States, and by small fees paid by the students; tuition is free in all colleges except the college of law. The government of the university is vested in a board of trustees appointed by the governor of the state for a term of seven years. The first president of the institution (from 1873 to 1881) was the distinguished geologist, Edward Orton (1829-1899), who was professor of geology from 1873 to 1899.

Other institutions of learning are the Capital University and Evangelical Lutheran Theological Seminary (Theological Seminary opened in 1830; college opened as an academy in 1850), with buildings just east of the city limits; Starling Ohio Medical College, a law school, a dental school and an art institute. Besides the university library, there is the Ohio state library occupying a room in the capitol and containing in 1908 126,000 volumes, including a "travelling library" of about 36,000 volumes, from which various organizations in different parts of the state may borrow books; the law library of the supreme court of Ohio, containing complete sets of English, Scottish, Irish, Canadian, United States and state reports, statutes and digests; the public school library of about 68,000 volumes, and the public library (of about 55,000), which is housed in a marble and granite building completed in 1906.

Columbus is near the Ohio coal and iron-fields, and has an extensive trade in coal, but its largest industrial interests are in manufactures, among which the more important are foundry and machine-shop products (1905 value, \$6,259,579); boots and shoes (1905 value, \$5,425,087, being more than one-sixtieth of the total product value of the boot and shoe industry in the United States, and being an increase from \$359,000 in 1890); patent medicines and compounds (1905 value, \$3,214,096); carriages and wagons (1905 value, \$2,197,960); malt liquors (1905 value, \$2,133,955); iron and steel; regalia and society emblems; steam-railway cars, construction and repairing; and oleo-margarine. In 1905 the city's factory products were valued at \$40,435,531, an increase of 16.4% in five years. Immediately outside the city limits in 1905 were various large and important manufactories, including railway shops, foundries, slaughter-houses, ice factories and brick-yards. In Columbus there is a large market for imported horses. Several large quarries also are adjacent to the city.

The waterworks are owned by the municipality. In 1904-1905 the city built on the Scioto river a concrete storage dam, having a capacity of 5,000,000,000 gallons, and in 1908 it completed the construction of enormous works for filtering and softening the water-supply, and of works for purifying the flow of sewage—the two costing nearly \$5,000,000. The filtering works include 6 lime saturators, 2 mixing or softening tanks, 6 settling basins, 10 mechanical filters and 2 clear-water reservoirs. A large municipal electric-lighting plant was completed in 1908.

The first permanent settlement within the present limits of the city was established in 1797 on the west bank of the Scioto, was named Franklinton, and in 1803 was made the county-seat. In 1810 four citizens of Franklinton formed an association to secure the location of the capital on the higher ground of the east bank; in 1812 they were successful and the place was laid out while still a forest. Four years later, when the legislature held its first session here, the settlement was incorporated as the Borough of Columbus. In 1824 the county-seat was removed here from Franklinton; in 1831 the Columbus branch of the Ohio Canal was completed; in 1834 the borough was made a city; by the close of the same decade the National Road extending from Wheeling to Indianapolis and passing through Columbus was completed; in 1871 most of Franklinton, which was never incorporated, was annexed, and several other annexations followed.

See J. H. Studer, *Columbus, Ohio; its History and Resources* (Columbus, 1873); A. E. Lee, *History of the City of Columbus, Ohio* (New York, 1892).

COLUMELLA, LUCIUS JUNIUS MODERATUS, of Gades, writer on agriculture, contemporary of Seneca the philosopher, flourished about the middle of the 1st century A.D. His extant works treat, with great fulness and in a diffuse but not inelegant style which well represents the silver age, of the cultivation of all kinds of corn and garden vegetables, trees, flowers, the vine, the olive and other fruits, and of the rearing of cattle, birds, fishes and bees. They consist of the twelve books of the *De re rustica* (the tenth, which treats of gardening, being in dactylic hexameters in imitation of Virgil), and of a book *De arboribus*, the second book of an earlier and less elaborate work on the same subject.

The best complete edition is by J. G. Schneider (1794). Of a new edition by K. J. Lundström, the tenth book appeared in 1902 and *De arboribus* in 1897. There are English translations by R. Bradley (1725), and anonymous (1745); and treatises, *De Columellae vita et scriptis*, by V. Barberet (1887), and G. R. Becher (1897), a compact dissertation with notes and references to authorities.

COLUMN (Lat. *columna*), in architecture, a vertical support consisting of capital, shaft and base, used to carry a horizontal beam or an arch. The earliest example in wood (2684 B.C.) was that found at Kahun in Egypt by Professor Flinders Petrie, which was fluted and stood on a raised base, and in stone the octagonal shafts of the early temple at Deir-el-Bahri (c. 2850). In the tombs at Beni Hasan (2723 B.C.) are columns of two kinds, the octagonal or polygonal shaft, and the reed or lotus column, the horizontal section of which is a quatrefoil. This became later the favourite type, but it was made circular on plan. In all these examples the column rests on a stone base. (See also CAPITAL and ORDER.)

The column was employed in Assyria in small structures only, such as pavilions or porticoes. In Persia the column, employed to carry timber superstructures only, was very lofty, being sometimes 12 diameters high; the shaft was fluted, the number of flutes varying from 30 to 52.

The earliest example of the Greek column is that represented in the temple fresco at Cnossus (c. 1600 B.C.), of which portions have been found. The columns were in cypress wood raised on a stone base and tapered downwards.¹ The same, though to a less degree, is found in the stone semi-detached columns which flank the doorway of the Tomb of Agamemnon at Mycenae; the shafts of these columns were carved with the chevron design.

The earliest Greek columns in stone as isolated features are those of the Temple of Apollo at Syracuse (early 7th century B.C.), the shafts of which were monoliths, but as a rule the Greek columns were all built of drums, sometimes as many as ten or twelve. There was no base to the Doric column, but the shafts were fluted, 20 flutes being the usual number. In the Archaic Temple of Diana at Ephesus there were 52 flutes. In the later examples of the Ionic order the shaft had 24 flutes. In the Roman temples the shafts were very often monoliths.

Columns were occasionally used as supports for figures or other features. The Naxian column at Delphi of the Ionic order carried a sphinx. The Romans employed columns in various ways: the Trajan and the Antonine columns carried figures of the two emperors; the *columna rostrata* (260 B.C.) in the Forum was decorated with the beaks of ships and was a votive column, the *miliaria column* marked the centre of Rome from which all distances were measured. In the same way the column in the Place Vendôme in Paris carries a statue of Napoleon I.; the monument of the Fire of London, a finial with flames sculptured on it; the duke of York's column (London), a statue of the duke of York.

With the exception of the Cretan and Mycenaean, all the shafts of the classic orders tapered from the bottom upwards, and about one-third up the column had an increment, known as the *entasis*, to correct an optical illusion which makes tapering shafts look concave; the proportions of diameter to height varied with the order employed. Thus, broadly speaking, a Roman Doric column will be eight, a Roman Ionic nine, a Corinthian

¹ The tree-trunk used as a column was inverted to retain the sap; hence the shape.

ten diameters in height. Except in rare cases, the columns of the Romanesque and Gothic styles were of equal diameter at top and bottom, and had no definite dimensions as regards diameter and height. They were also grouped together round piers which are known as clustered piers. When of exceptional size, as in Gloucester and Durham cathedrals, Waltham Abbey and Tewkesbury, they are generally called "pillars," which was apparently the medieval term for column. The word *columna*, employed by Vitruvius, was introduced into England by the Italian writers of the Revival.

In the Renaissance period columns were frequently banded, the bands being concentric with the column as in France, and occasionally richly carved as in Philibert De L'Orme's work at the Tuileries. In England Inigo Jones introduced similar features, but with square blocks sometimes rusticated, a custom lately revived in England, but of which there are few examples either in Italy or Spain.

The word "column" is used, by analogy with architecture, for any upright body or mass, in chemistry, anatomy, typography, &c.

(R. P. S.)

COLURE (from Gr. *κόλος*, shortened, and *οὐρά*, tail), in astronomy, either of the two principal meridians of the celestial sphere, one of which passes through the poles and the two solstices, the other through the poles and the two equinoxes; hence designated as *solstitial colure* and *equinoxial colure*, respectively.

COLUTHUS, or **COLLUTHUS**, of Lycopolis in the Egyptian Thebaid, Greek epic poet, flourished during the reign of Anastasius I. (491-518). According to Suidas, he was the author of *Calydoniaca* (probably an account of the Calydonian boar hunt), *Persica* (an account of the Persian wars), and *Eucomia* (laudatory poems). These are all lost, but his poem in some 400 hexameters on *The Rape of Helen* (*Ἀρπαγή Ἑλένης*) is still extant, having been discovered by Cardinal Bessarion in Calabria. The poem is dull and tasteless, devoid of imagination, a poor imitation of Homer, and has little to recommend it except its harmonious versification, based upon the technical rules of Nonnus. It related the history of Paris and Helen from the wedding of Peleus and Thetis down to the elopement and arrival at Troy.

The best editions are by Van Lennep (1747), G. F. Schäfer (1825), E. Abel (1880).

COLVILLE, JOHN (c. 1540-1605), Scottish divine and author, was the son of Robert Colville of Cleish, in the county of Kinross. Educated at St Andrews University, he became a Presbyterian minister, but occupied himself chiefly with political intrigue, sending secret information to the English government concerning Scottish affairs. He joined the party of the earl of Gowrie, and took part in the Raid of Ruthven in 1582. In 1587 he for a short time occupied a seat on the judicial bench, and was commissioner for Stirling in the Scottish parliament. In December 1591 he was implicated in the earl of Bothwell's attack on Holyrood Palace, and was outlawed with the earl. He retired abroad, and is said to have joined the Roman Church. He died in Paris in 1605. Colville was the author of several works, including an *Oratio Funeris* on Queen Elizabeth, and some political and religious controversial essays. He is said to be the author also of *The Historie and Life of King James the Sixth* (edited by T. Thompson for the Bannatyne Club, Edinburgh, 1825).

Colville's *Original Letters, 1582-1603*, published by the Bannatyne Club in 1858, contains a biographical memoir by the editor, David Laing.

COLVIN, JOHN RUSSELL (1807-1857), lieutenant-governor of the North-West Provinces of India during the mutiny of 1857, belonged to an Anglo-Indian family of Scottish descent, and was born in Calcutta on the 29th of May 1807. Passing through Haileybury he entered the service of the East India Company in 1826. In 1836 he became private secretary to Lord Auckland, and his influence over the viceroy has been held partly responsible for the first Afghan war of 1837; but it has since been shown that Lord Auckland's policy was dictated by the secret committee of the company at home. In 1853 Mr Colvin was

appointed lieutenant-governor of the North-West Provinces by Lord Dalhousie. On the outbreak of the mutiny in 1857 he had with him at Agra only a weak British regiment and a native battery, too small a force to make head against the mutineers; and a proclamation which he issued to the natives was censured at the time for its clemency, but it followed the same lines as those adopted by Sir Henry Lawrence and subsequently followed by Lord Canning. Exhausted by anxiety and misrepresentation he died on the 9th of September, his death shortly preceding the fall of Delhi.

His son, **SIR AUCKLAND COLVIN** (1838-1908), followed him in a distinguished career in the same service, from 1858 to 1879. He was comptroller-general in Egypt (1880 to 1882), and financial adviser to the khedive (1883 to 1887), and from 1883 till 1892 was back again in India, first as financial member of council, and then, from 1887, as lieutenant-governor of the North-West Provinces and Oudh. He was created K.C.M.G. in 1881, and K.C.S.I. in 1892, when he retired. He published *The Making of Modern Egypt* in 1906, and a biography of his father, in the "Rulers of India" series, in 1895. He died at Surbiton on the 24th of March 1908.

COLVIN, SIDNEY (1845-), English literary and art critic, was born at Norwood, London, on the 18th of June 1845. A scholar of Trinity College, Cambridge, he became a fellow of his college in 1868. In 1873 he was Slade professor of fine art, and was appointed in the next year to the directorship of the Fitzwilliam Museum. In 1884 he removed to London on his appointment as keeper of prints and drawings in the British Museum. His chief publications are lives of Landor (1881) and Keats (1887), in the English Men of Letters series; the Edinburgh edition of R. L. Stevenson's works (1894-1897); editions of the letters of Keats (1887), and of the *Vailima Letters* (1899), which R. L. Stevenson chiefly addressed to him; *A Florentine Picture-Chronicle* (1898), and *Early History of Engraving in England* (1905). But in the field both of art and of literature, Mr Colvin's fine taste, wide knowledge and high ideals made his authority and influence extend far beyond his published work.

COLWYN BAY, a watering-place of Denbighshire, N. Wales, on the Irish Sea, 40½ m. from Chester by the London & North-Western railway. Pop. of urban district of Colwyn Bay and Colwyn (1901) 8689. Colwyn Bay has become a favourite bathing-place, being near to, and cheaper than, the fashionable Llandudno, and being a centre for picturesque excursions. Near it is Llanelian village, famous for its "cursing well" (St Eilian's, perhaps Aelianus'). The stream Colwyn joins the Gwynnant. The name Colwyn is that of lords of Ardudwy; a Lord Colwyn of Ardudwy, in the 10th century, is believed to have repaired Harlech castle, and is considered the founder of one of the fifteen tribes of North Wales. Nant Colwyn is on the road from Carnarvon to Beddgelert, beyond Llyn y gader (gadair), "chair pool," and what tourists have fancifully called Pitt's head, a roadside rock resembling, or thought to resemble, the great statesman's profile. Near this is Llyn y dywarchen (sod pool), with a floating island.

COLZA OIL, a non-drying oil obtained from the seeds of *Brassica campestris*, var. *oleifera*, a variety of the plant which produces Swedish turnips. Colza is extensively cultivated in France, Belgium, Holland and Germany; and, especially in the first-named country, the expression of the oil is an important industry. In commerce colza is classed with rape oil, to which both in source and properties it is very closely allied. It is a comparatively inodorous oil of a yellow colour, having a specific gravity varying from 0.912 to 0.920. The cake left after expression of the oil is a valuable feeding substance for cattle. Colza oil is extensively used as a lubricant for machinery, and for burning in lamps.

COMA (Gr. *κόμα*, from *κοιμᾶν*, to put to sleep), a deep sleep; the term is, however, used in medicine to imply something more than its Greek origin denotes, namely, a complete and prolonged loss of consciousness from which a patient cannot be roused. There are various degrees of coma: in the slighter

forms the patient can be partially roused only to relapse again into a state of insensibility; in the deeper states, the patient cannot be roused at all, and such are met with in apoplexy, already described. Coma may arise abruptly in a patient who has presented no pre-existent indication of such a state occurring. Such a condition is called *primary coma*, and may result from the following causes:—(1) concussion, compression or laceration of the brain from head injuries, especially fracture of the skull; (2) from alcoholic and narcotic poisoning; (3) from cerebral hæmorrhage, embolism and thrombosis, such being the causes of apoplexy. *Secondary coma* may arise as a complication in the following diseases:—diabetes, uræmia, general paralysis, meningitis, cerebral tumour and acute yellow atrophy of the liver; in such diseases it is anticipated, for it is a frequent cause of the fatal termination. The depth of insensibility to stimulus is a measure of the gravity of the symptom; thus the conjunctival reflex and even the spinal reflexes may be abolished, the only sign of life being the respiration and heart-beat, the muscles of the limbs being sometimes perfectly flaccid. A characteristic change in the respiration, known as Cheyne-Stokes breathing occurs prior to death in some cases; it indicates that the respiratory centre in the medulla is becoming exhausted, and is stimulated to action only when the venosity of the blood has increased sufficiently to excite it. The breathing consequently loses its natural rhythm, and each successive breath becomes deeper until a maximum is reached; it then diminishes in depth by successive steps until it dies away completely. The condition of apnoea, or cessation of breathing, follows, and as soon as the venosity of the blood again affords sufficient stimulus, the signs of air-hunger commence; this altered rhythm continues until the respiratory centre becomes exhausted and death ensues.

Coma Vigil is a state of unconsciousness met with in the algid stage of cholera and some other exhausting diseases. The patient's eyes remain open, and he may be in a state of low muttering delirium; he is entirely insensible to his surroundings, and neither knows nor can indicate his wants.

There is a distinct word "coma" (Gr. *κόμη*, hair), which is used in astronomy for the envelope of a comet, and in botany for a tuft.

COMA BERENICES ("BERENICE'S HAIR"), in astronomy, a constellation of the northern hemisphere; it was first mentioned by Callimachus, and Eratosthenes (3rd century B.C.), but is not included in the 48 asterisms of Ptolemy. It is said to have been named by Conon, in order to console Berenice, queen of Ptolemy Euergetes, for the loss of a lock of her hair, which had been stolen from a temple to Venus. This constellation is sometimes, but wrongly, attributed to Tycho Brahe. The most interesting member of this group is *24 Comae*, a fine, wide double star, consisting of an orange star of magnitude $5\frac{1}{2}$, and a blue star, magnitude 7.

COMACCHIO, a town of Emilia, Italy, in the province of Ferrara, 30 m. E.S.E. by road from the town of Ferrara, on the level of the sea, in the centre of the lagoon of Valli di Comacchio, just N. of the present mouth of the Reno. Pop. (1901) 7944 (town), 10,745 (commune). It is built on no less than thirteen different islets, joined by bridges, and its industries are the fishery, which belongs to the commune, and the salt-works. The seaport of Magnavacca lies 4 m. to the east. Comacchio appears as a city in the 6th century, and, owing to its position in the centre of the lagoons, was an important fortress. It was included in the "donation of Pippin"; it was taken by the Venetians in 854, but afterwards came under the government of the archbishops of Ravenna; in 1299 it came under the dominion of the house of Este. In 1508 it became Venetian, but in 1597 was claimed by Clement VIII. as a vacant fief.

COMANA, a city of Cappadocia [frequently called **CHRYSE** or **AUREA**, i.e. the golden, to distinguish it from Comana in Pontus; mod. *Shahr*], celebrated in ancient times as the place where the rites of Mâ-Enyo, a variety of the great west Asian Nature-goddess, were celebrated with much solemnity. The service was carried on in a sumptuous temple with great magnificence by many thousands of *hieroduli* (temple-servants). To defray

expenses, large estates had been set apart, which yielded a more than royal revenue. The city, a mere apanage of the temple, was governed immediately by the chief priest, who was always a member of the reigning Cappadocian family, and took rank next to the king. The number of persons engaged in the service of the temple, even in Strabo's time, was upwards of 6000, and among these, to judge by the names common on local tombstones, were many of Persian race. Under Caracalla, Comana became a Roman colony, and it received honours from later emperors down to the official recognition of Christianity. The site lies at Shahr, a village in the Anti-Taurus on the upper course of the Sarus (Sihun), mainly Armenian, but surrounded by new settlements of Avshar Turkomans and Circassians. The place has derived importance both in antiquity and now from its position at the eastern end of the main pass of the western Anti-Taurus range, the Kuru Chai, through which passed the road from Caesarea-Mazaca (mod. *Kaisarieli*) to Melitene (Malatia), converted by Septimius Severus into the chief military road to the eastern frontier of the empire. The extant remains at Shahr include a theatre on the left bank of the river, a fine Roman doorway and many inscriptions; but the exact site of the great temple has not been satisfactorily identified. There are many traces of Severus' road, including a bridge at Kemer, and an immense number of milestones, some in their original positions, others in cemeteries.

See P. H. H. Massy in *Geog. Journ.* (Sept. 1905); E. Chantre, *Mission en Cappadocie* (1898). (D. G. H.)

COMANA (mod. *Gumenek*), an ancient city of Pontus, said to have been colonized from Comana in Cappadocia. It stood on the river Iris (Tozanli Su or Yeshil Irmak), and from its central position was a favourite emporium of Armenian and other merchants. The moon-goddess was worshipped in the city with a pomp and ceremony in all respects analogous to those employed in the Cappadocian city. The slaves attached to the temple alone numbered not less than 6000. St John Chrysostom died there on the way to Constantinople from his exile at Cocysus in the Anti-Taurus. Remains of Comana are still to be seen near a village called Gumenek on the Tozanli Su, 7 m. from Tokat, but they are of the slightest description. There is a mound; and a few inscriptions are built into a bridge, which here spans the river, carrying the road from Niksar to Tokat. (D. G. H.)

COMANCHES, a tribe of North American Indians of Shoshonean stock, so called by the Spaniards, but known to the French as Padoucas, an adaptation of their Sioux name, and among themselves *ashimemim* (people). They numbered some 1400, attached to the Kiowa agency, Oklahoma. When first met by Europeans, they occupied the regions between the upper waters of the Brazos and Colorado on the one hand, and the Arkansas and Missouri on the other. Until their final surrender in 1875 the Comanches were the terror of the Mexican and Texan frontiers, and were always famed for their bravery. They were brought to nominal submission in 1783 by the Spanish general Anza, who killed thirty of their chiefs. During the 19th century they were always raiding and fighting, but in 1867, to the number of 2500, they agreed to go on a reservation. In 1872 a portion of the tribe, the Quanhada or Staked Plain Comanches, had again to be reduced by military measures.

COMAYAGUA, the capital of the department of Comayagua in central Honduras, on the right bank of the river Ulua, and on the interoceanic railway from Puerto Cortes to Fonseca Bay. Pop. (1900) about 8000. Comayagua occupies part of a fertile valley, enclosed by mountain ranges. Under Spanish rule it was a city of considerable size and beauty, and in 1827 its inhabitants numbered more than 18,000. A fine cathedral, dating from 1715, is the chief monument of its former prosperity, for most of the handsome public buildings erected in the colonial period have fallen into disrepair. The present city chiefly consists of low adobe houses and cane huts, tenanted by Indians. The university founded in 1678 has ceased to exist, but there is a school of jurisprudence. In the neighbourhood are many ancient Indian ruins (see CENTRAL AMERICA; *Archæology*).

Founded in 1540 by Alonzo Caceres, who had been instructed

by the Spanish government to find a site for a city midway between the two oceans, Valladolid la Nueva, as the town was first named, soon became the capital of Honduras. It received the privileges of a city in 1557, and was made an episcopal see in 1561. Its decline dates from 1827, when it was burned by revolutionaries; and in 1854 its population had dwindled to 2000. It afterwards suffered through war and rebellion, notably in 1872 and 1873, when it was besieged by the Guatemalans. In 1880 Tegucigalpa (*q.v.*), a city 37 m. east-south-east, superseded it as the capital of Honduras.

COMB (a word common in various forms to Teut. languages, cf. Ger. *Kamm*, the Indo-Europ. origin of which is seen in *γόμφος*, a peg or pin, and Sanskrit, *gambhas*, a tooth), a toothed article of the toilet used for cleaning and arranging the hair, and also for holding it in place after it has been arranged; the word is also applied, from resemblance in form or in use, to various appliances employed for dressing wool and other fibrous substances, to the indented fleshy crest of a cock, and to the ridged series of cells of wax filled with honey in a beehive. Hair combs are of great antiquity, and specimens made of wood, bone and horn have been found in Swiss lake-dwellings. Among the Greeks and Romans they were made of boxwood, and in Egypt also of ivory. For modern combs the same materials are used, together with others such as tortoise-shell, metal, india-rubber and celluloid. There are two chief methods of manufacture. A plate of the selected material is taken of the size and thickness required for the comb, and on one side of it, occasionally on both sides, a series of fine slits are cut with a circular saw. This method involves the loss of the material cut out between the teeth. The second method, known as "twinning" or "parting," avoids this loss and is also more rapid. The plate of material is rather wider than before, and is formed into two combs simultaneously, by the aid of a twinning machine. Two pairs of chisels, the cutting edges of which are as long as the teeth are required to be and are set at an angle converging towards the sides of the plate, are brought down alternately in such a way that the wedges removed from one comb form the teeth of the other, and that when the cutting is complete the plate presents the appearance of two combs with their teeth exactly inosculating or dovetailing into each other. In india-rubber combs the teeth are moulded to shape and the whole hardened by vulcanization.

COMBACONUM, or **KUMBAKONAM**, a city of British India, in the Tanjore district of Madras, in the delta of the Cauvery, on the South Indian railway, 194 m. from Madras. Pop. (1901) 59,623, showing an increase of 10% in the decade. It is a large town with wide and airy streets, and is adorned with pagodas, gateways and other buildings of considerable pretension. The great *gopuram*, or gate-pyramid, is one of the most imposing buildings of the kind, rising in twelve stories to a height of upwards of 100 ft., and ornamented with a profusion of figures of men and animals formed in stucco. One of the water-tanks in the town is popularly reputed to be filled with water admitted from the Ganges every twelve years by a subterranean passage 1200 m. long; and it consequently forms a centre of attraction for large numbers of devotees. The city is historically interesting as the capital of the Chola race, one of the oldest Hindu dynasties of which any traces remain, and from which the whole coast of Coromandel, or more properly Chalamandal, derives its name. It contains a government college. Brass and other metal wares, silk and cotton cloth and sugar are among the manufactures.

COMBE, ANDREW (1797-1847), Scottish physiologist, was born in Edinburgh on the 27th of October 1797, and was a younger brother of George Combe. He served an apprenticeship in a surgery, and in 1817 passed at Surgeons' Hall. He proceeded to Paris to complete his medical studies, and whilst there he investigated phrenology on anatomical principles. He became convinced of the truth of the new science, and, as he acquired much skill in the dissection of the brain, he subsequently gave additional interest to the lectures of his brother George, by his practical demonstrations of the convulsions. He returned to Edinburgh in 1819 with the intention of beginning practice; but

being attacked by the first symptoms of pulmonary disease, he was obliged to seek health in the south of France and in Italy during the two following winters. He began to practise in 1823, and by careful adherence to the laws of health he was enabled to fulfil the duties of his profession for nine years. During that period he assisted in editing the *Phrenological Journal* and contributed a number of articles to it, defended phrenology before the Royal Medical Society of Edinburgh, published his *Observations on Mental Derangement* (1831), and prepared the greater portion of his *Principles of Physiology Applied to Health and Education*, which was issued in 1834, and immediately obtained extensive public favour. In 1836 he was appointed physician to Leopold I., king of the Belgians, and removed to Brussels, but he speedily found the climate unsuitable and returned to Edinburgh, where he resumed his practice. In 1836 he published his *Physiology of Digestion*, and in 1838 he was appointed one of the physicians extraordinary to the queen in Scotland. Two years later he completed his *Physiological and Moral Management of Infancy*, which he believed to be his best work and it was his last. His latter years were mostly occupied in seeking at various health resorts some alleviation of his disease; he spent two winters in Madeira, and tried a voyage to the United States, but was compelled to return within a few weeks of the date of his landing at New York. He died at Gorgie, near Edinburgh, on the 9th of August 1847.

His biography, written by George Combe, was published in 1850.

COMBE, GEORGE (1788-1858), Scottish phrenologist, elder brother of the above, was born in Edinburgh on the 21st of October 1788. After attending Edinburgh high school and university he entered a lawyer's office in 1804, and in 1812 began to practise on his own account. In 1815 the *Edinburgh Review* contained an article on the system of "craniology" of F. J. Gall and K. Spurzheim, which was denounced as "a piece of thorough quackery from beginning to end." Combe laughed like others at the absurdities of this so-called new theory of the brain, and thought that it must be finally exploded after such an exposure; and when Spurzheim delivered lectures in Edinburgh, in refutation of the statements of his critic, Combe considered the subject unworthy of serious attention. He was, however, invited to a friend's house where he saw Spurzheim dissect the brain, and he was so far impressed by the demonstration that he attended the second course of lectures. Investigating the subject for himself, he became satisfied that the fundamental principles of phrenology were true—namely "that the brain is the organ of mind; that the brain is an aggregate of several parts, each subserving a distinct mental faculty; and that the size of the cerebral organ is, *caeteris paribus*, an index of power or energy of function." In 1817 his first essay on phrenology was published in the *Scots Magazine*; and a series of papers on the same subject appeared soon afterwards in the *Literary and Statistical Magazine*; these were collected and published in 1819 in book form as *Essays on Phrenology*, which in later editions became *A System of Phrenology*. In 1820 he helped to found the Phrenological Society, which in 1823 began to publish a *Phrenological Journal*. By his lectures and writings he attracted public attention to the subject on the continent of Europe and in America, as well as at home; and a long discussion with Sir William Hamilton in 1827-1828 excited general interest.

His most popular work, *The Constitution of Man*, was published in 1828, and in some quarters brought upon him denunciations as a materialist and atheist. From that time he saw everything by the light of phrenology. He gave time, labour and money to help forward the education of the poorer classes; he established the first infant school in Edinburgh; and he originated a series of evening lectures on chemistry, physiology, history and moral philosophy. He studied the criminal classes, and tried to solve the problem how to reform as well as to punish them; and he strove to introduce into lunatic asylums a humane system of treatment. In 1836 he offered himself as a candidate for the chair of logic at Edinburgh, but was rejected in favour of Sir William Hamilton. In 1838 he visited America and spent about two years lecturing on phrenology, education and the

treatment of the criminal classes. On his return in 1840 he published his *Moral Philosophy*, and in the following year his *Notes on the United States of North America*. In 1842 he delivered, in German, a course of twenty-two lectures on phrenology in the university of Heidelberg, and he travelled much in Europe, inquiring into the management of schools, prisons and asylums. The commercial crisis of 1855 elicited his remarkable pamphlet on *The Currency Question* (1858). The culmination of the religious thought and experience of his life is contained in his work *On the Relation between Science and Religion*, first publicly issued in 1857. He was engaged in revising the ninth edition of the *Constitution of Man* when he died at Moor Park, Farnham, on the 14th of August 1858. He married in 1833 Cecilia Siddons, a daughter of the great actress.

COMBE, WILLIAM (1741-1823), English writer, the creator of "Dr Syntax," was born at Bristol in 1741. The circumstances of his birth and parentage are somewhat doubtful, and it is questioned whether his father was a rich Bristol merchant, or a certain William Alexander, a London alderman, who died in 1762. He was educated at Eton, where he was contemporary with Charles James Fox, the 2nd Baron Lyttelton and William Beckford. Alexander bequeathed him some £2000—a little fortune that soon disappeared in a course of splendid extravagance, which gained him the nickname of Count Combe; and after a chequered career as private soldier, cook and waiter, he finally settled in London (about 1771), as a law student and bookseller's hack. In 1776 he made his first success in London with *The Diaboliad*, a satire full of bitter personalities. Four years afterwards (1780) his debts brought him into the King's Bench; and much of his subsequent life was spent in prison. His spurious *Letters of the Late Lord Lyttelton*¹ (1780) imposed on many of his contemporaries, and a writer in the *Quarterly Review*, so late as 1851, regarded these letters as authentic, basing upon them a claim that Lyttelton was "Junius." An early acquaintance with Lawrence Sterne resulted in his *Letters supposed to have been written by Yorick and Eliza* (1779). Periodical literature of all sorts—pamphlets, satires, burlesques, "two thousand columns for the papers," "two hundred biographies"—filled up the next years, and about 1789 Combe was receiving £200 yearly from Pitt, as a pamphleteer. Six volumes of a *Devil on Two Sticks in England* won for him the title of "the English le Sage"; in 1794-1796 he wrote the text for Boydell's *History of the River Thames*; in 1803 he began to write for *The Times*. In 1809-1811 he wrote for Ackermann's *Political Magazine* the famous *Tour of Dr Syntax in search of the Picturesque* (descriptive and moralizing verse of a somewhat doggerel type), which, owing greatly to Thomas Rowlandson's designs, had an immense success. It was published separately in 1812 and was followed by two similar *Tours*, "in search of Consolation," and "in search of a Wife," the first Mrs Syntax having died at the end of the first *Tour*. Then came *Six Poems* in illustration of drawings by Princess Elizabeth (1813), *The English Dance of Death* (1815-1816), *The Dance of Life* (1816-1817), *The Adventures of Johnny Quae Genus* (1822)—all written for Rowlandson's caricatures; together with *Histories of Oxford and Cambridge*, and of Westminster Abbey for Ackermann; *Picturesque Tours* along the Rhine and other rivers, *Histories of Madeira*, *Antiquities of York*, texts for *Turner's Southern Coast Views*, and contributions innumerable to the *Literary Repository*. In his later years, notwithstanding a by no means unsullied character, Combe was courted for the sake of his charming conversation and inexhaustible stock of anecdote. He died in London on the 19th of June 1823.

Brief obituary memoirs of Combe appeared in Ackermann's *Literary Repository* and in the *Gentleman's Magazine* for August 1823; and in May 1859 a list of his works, drawn up by his own hand, was printed in the latter periodical. See also *Diary of H. Crabb Robinson, Notes and Queries for 1869*.

¹ Thomas, 2nd Baron Lyttelton (1744-1779), commonly known as the "wicked Lord Lyttelton," was famous for his abilities and his libertinism, also for the mystery attached to his death, of which it was alleged he was warned in a dream three days before the event.

COMBE, or **COOMB**, a term particularly in use in south-western England for a short closed-in valley, either on the side of a down or running up from the sea. It appears in place-names as a termination, e.g. Wiveliscombe, Ilfracombe, and as a prefix, e.g. Combemartin. The etymology of the word is obscure, but "hollow" seems a common meaning to similar forms in many languages. In English "combe" or "cumb" is an obsolete word for a "hollow vessel," and the like meaning attached to Teutonic forms *kumm* and *kumme*. The Welsh *cwm*, in place-names, means hollow or valley, with which may be compared *cwm* in many Scots place-names. The Greek *κῶμῆ* also means a hollow vessel, and there is a French dialect word *combe* meaning a little valley.

COMBERMERE, STAPLETON COTTON, 1st VISCOUNT (1773-1865), British field-marshal and colonel of the 1st Life Guards, was the second son of Sir Robert Salusbury Cotton of Combermere Abbey, Cheshire, and was born on the 14th of November 1773, at Llewenny Hall in Denbighshire. He was educated at Westminster School, and when only sixteen obtained a second lieutenancy in the 23rd regiment (Royal Welsh Fusiliers). A few years afterwards (1793) he became by purchase captain in the 6th Dragoon Guards, and he served in this regiment during the campaigns of the duke of York in Flanders. While yet in his twentieth year, he joined the 25th Light Dragoons (subsequently 22nd) as lieutenant-colonel, and, while in attendance with his regiment on George III. at Weymouth, he became a great favourite of the king. In 1796 he went with his regiment to India, taking part *en route* in the operations in Cape Colony (July-August 1796), and in 1799 served in the war with Tippoo Sahib, and at the storming of Seringapatam. Soon after this, having become heir to the family baronetcy, he was, at his father's desire, exchanged into a regiment at home, the 16th Light Dragoons. He was stationed in Ireland during Emmett's insurrection, became colonel in 1800, and major-general five years later. From 1806 to 1814 he was M.P. for Newark. In 1808 he was sent to the seat of war in Portugal, where he shortly rose to the position of commander of Wellington's cavalry, and it was here that he most displayed that courage and judgment which won for him his fame as a cavalry officer. He succeeded to the baronetcy in 1809, but continued his military career. His share in the battle of Salamanca (22nd of July 1812) was especially marked, and he received the personal thanks of Wellington. The day after, he was accidentally wounded. He was now a lieutenant-general in the British army and a K.B., and on the conclusion of peace (1814) was raised to the peerage under the style of Baron Combermere. He was not present at Waterloo, the command, which he expected, and bitterly regretted not receiving, having been given to Lord Uxbridge. When the latter was wounded Cotton was sent for to take over his command, and he remained in France until the reduction of the allied army of occupation. In 1817 he was appointed governor of Barbadoes and commander of the West Indian forces. From 1822 to 1825 he commanded in Ireland. His career of active service was concluded in India (1826), where he besieged and took Bhurtpore—a fort which twenty-two years previously had defied the genius of Lake and was deemed impregnable. For this service he was created Viscount Combermere. A long period of peace and honour still remained to him at home. In 1834 he was sworn a privy councillor, and in 1852 he succeeded Wellington as constable of the Tower and lord lieutenant of the Tower Hamlets. In 1855 he was made a field-marshal and G.C.B. He died at Clifton on the 21st of February 1865. An equestrian statue in bronze, the work of Baron Marochetti, was raised in his honour at Chester by the inhabitants of Cheshire. Combermere was succeeded by his only son, Wellington Henry (1818-1891), and the viscountcy is still held by his descendants.

See Viscountess Combermere and Captain W. W. Knollys, *The Combermere Correspondence* (London, 1866).

COMBES, [JUSTIN LOUIS] ÉMILE (1835-), French statesman, was born at Roquecourbe in the department of the Tarn. He studied for the priesthood, but abandoned the idea before ordination, and took the diploma of doctor of letters (1860),

Then he studied medicine, taking his degree in 1867, and setting up in practice at Pons in Charente-Inférieure. In 1881 he presented himself as a political candidate for Saintes, but was defeated. In 1885 he was elected to the senate by the department of Charente-Inférieure. He sat in the Democratic left, and was elected vice-president in 1893 and 1894. The reports which he drew up upon educational questions drew attention to him, and on the 3rd of November 1895 he entered the Bourgeois cabinet as minister of public instruction, resigning with his colleagues on the 21st of April following. He actively supported the Waldeck-Rousseau ministry, and upon its retirement in 1903 he was himself charged with the formation of a cabinet. In this he took the portfolio of the Interior, and the main energy of the government was devoted to the struggle with clericalism. The parties of the Left in the chamber, united upon this question in the *Bloc republicain*, supported Combes in his application of the law of 1901 on the religious associations, and voted the new bill on the congregations (1904), and under his guidance France took the first definite steps toward the separation of church and state. He was opposed with extreme violence by all the Conservative parties, who regarded the secularization of the schools as a persecution of religion. But his stubborn enforcement of the law won him the applause of the people, who called him familiarly *le petit père*. Finally the defection of the Radical and Socialist groups induced him to resign on the 17th of January 1905, although he had not met an adverse vote in the Chamber. His policy was still carried on; and when the law of the separation of church and state was passed, all the leaders of the Radical parties entertained him at a noteworthy banquet in which they openly recognized him as the real originator of the movement.

COMBINATION (Lat. *combinare*, to combine), a term meaning an association or union of persons for the furtherance of a common object, historically associated with agreements amongst workmen for the purpose of raising their wages. Such a combination was for a long time expressly prohibited by statute. See **TRADE UNIONS**; also **CONSPIRACY** and **STRIKES AND LOCK OUTS**.

COMBINATORIAL ANALYSIS. The Combinatorial Analysis, as it was understood up to the end of the 18th century, was of limited scope and restricted application. P. Nicholson, in his *Essays on the Combinatorial Analysis*, published in 1818, states that "the Combinatorial Analysis is a branch of mathematics which teaches us to ascertain and exhibit all the possible ways in which a given number of things may be associated and mixed together; so that we may be certain that we have not missed any collection or arrangement of these things that has not been enumerated." Writers on the subject seemed to recognize fully that it was in need of cultivation, that it was of much service in facilitating algebraical operations of all kinds, and that it was the fundamental method of investigation in the theory of Probabilities. Some idea of its scope may be gathered from a statement of the parts of algebra to which it was commonly applied, viz., the expansion of a multinomial, the product of two or more multinomials, the quotient of one multinomial by another, the reversion and conversion of series, the theory of indeterminate equations, &c. Some of the elementary theorems and various particular problems appear in the works of the earliest algebraists, but the true pioneer of modern researches seems to have been Abraham Demoivre, who first published in *Phil. Trans.* (1697) the law of the general coefficient in the expansion of the series $a+bx+cx^2+dx^3+\dots$ raised to any power. (See also *Miscellanea Analytica*, bk. iv. chap. ii. prob. iv.) His work on Probabilities would naturally lead him to consider questions of this nature. An important work at the time it was published was the *De Partitione Numerorum* of Leonhard Euler, in which the consideration of the reciprocal of the product $(1-xz)(1-x^2z)(1-x^3z)\dots$ establishes a fundamental connexion between arithmetic and algebra, arithmetical addition being made to depend upon algebraical multiplication, and a close bond is secured between the theories of discontinuous and continuous quantities. (Cf. **NUMBERS**, **PARTITION OF**.) The

multiplication of the two powers x^a, x^b , viz. $x^a+x^b=x^{a+b}$, showed Euler that he could convert arithmetical addition into algebraical multiplication, and in the paper referred to he gives the complete formal solution of the main problems of the partition of numbers. He did not obtain general expressions for the coefficients which arose in the expansion of his generating functions, but he gave the actual values to a high order of the coefficients which arise from the generating functions corresponding to various conditions of partitionment. Other writers who have contributed to the solution of special problems are James Bernoulli, Ruggiero Giuseppe Boscovich, Karl Friedrich Hindenburg (1741-1808), William Emerson (1701-1782), Robert Woodhouse (1773-1827), Thomas Simpson and Peter Barlow. Problems of combination were generally undertaken as they became necessary for the advancement of some particular part of mathematical science: it was not recognized that the theory of combinations is in reality a science by itself, well worth studying for its own sake irrespective of applications to other parts of analysis. There was a total absence of orderly development, and until the first third of the 19th century had passed, Euler's classical paper remained alike the chief result and the only scientific method of combinatorial analysis.

In 1846 Karl G. J. Jacobi studied the partitions of numbers by means of certain identities involving infinite series that are met with in the theory of elliptic functions. The method employed is essentially that of Euler. Interest in England was aroused, in the first instance, by Augustus De Morgan in 1846, who, in a letter to Henry Warburton, suggested that combinatorial analysis stood in great need of development, and alluded to the theory of partitions. Warburton, to some extent under the guidance of De Morgan, prosecuted researches by the aid of a new instrument, viz. the theory of finite differences. This was a distinct advance, and he was able to obtain expressions for the coefficients in partition series in some of the simplest cases (*Trans. Camb. Phil. Soc.*, 1849). This paper inspired a valuable paper by Sir John Herschel (*Phil. Trans.* 1850), who, by introducing the idea and notation of the circulating function, was able to present results in advance of those of Warburton. The new idea involved a calculus of the imaginary roots of unity. Shortly afterwards, in 1855, the subject was attacked simultaneously by Arthur Cayley and James Joseph Sylvester, and their combined efforts resulted in the practical solution of the problem that we have to-day. The former added the idea of the prime circulator, and the latter applied Cauchy's theory of residues to the subject, and invented the arithmetical entity termed a denumerant. The next distinct advance was made by Sylvester, Fabian Franklin, William Pitt Durfee and others, about the year 1882 (*Amer. Journ. Math.* vol. v.) by the employment of a graphical method. The results obtained were not only valuable in themselves, but also threw considerable light upon the theory of algebraic series. So far it will be seen that researches had for their object the discussion of the partition of numbers. Other branches of combinatorial analysis were, from any general point of view, absolutely neglected. In 1888 P. A. MacMahon investigated the general problem of distribution, of which the partition of a number is a particular case. He introduced the method of symmetric functions and the method of differential operators, applying both methods to the two important subdivisions, the theory of composition and the theory of partition. He introduced the notion of the separation of a partition, and extended all the results so as to include multipartite as well as unipartite numbers. He showed how to introduce zero and negative numbers, unipartite and multipartite, into the general theory; he extended Sylvester's graphical method to three dimensions; and finally, 1898, he invented the "Partition Analysis" and applied it to the solution of novel questions in arithmetic and algebra. An important paper by G. B. Mathews, which reduces the problem of compound partition to that of simple partition, should also be noticed. This is the problem which was known to Euler and his contemporaries as "The Problem of the Virgins," or "the Rule of Ceres"; it is only now, nearly 200 years later, that it has been solved.

The most important problem of combinatorial analysis is connected with the distribution of objects into classes. A number n may be regarded as enumerating n similar objects; it is then said to be unipartite. On the other hand, if the objects be not all similar they cannot be effectively enumerated by a single integer; we require a succession of integers. If the objects be p in number of one kind, q of a second kind, r of a third, &c., the enumeration is given by the succession $pqr \dots$ which is termed a multipartite number, and written,

$$\overline{pqr \dots}$$

where $p+q+r+\dots=n$. If the order of magnitude of the numbers p, q, r, \dots is immaterial, it is usual to write them in descending order of magnitude, and the succession may then be termed a partition of the number n , and is written $(pqr \dots)$. The succession of integers thus has a twofold signification: (i.) as a multipartite number it may enumerate objects of different kinds; (ii.) it may be viewed as a partitionment into separate parts of a unipartite number. We may say either that the objects are represented by the multipartite number $pqr \dots$, or that they are defined by the partition $(pqr \dots)$ of the unipartite number n . Similarly the classes into which they are distributed may be m in number all similar; or they may be p_1 of one kind, q_1 of a second, r_1 of a third, &c., where $p_1+q_1+r_1+\dots=m$. We may thus denote the classes either by the multipartite numbers $p_1q_1r_1 \dots$, or by the partition $(p_1q_1r_1 \dots)$ of the unipartite number m . The distributions to be considered are such that any number of objects may be in any one class subject to the restriction that no class is empty. Two cases arise. If the order of the objects in a particular class is immaterial, the class is termed a *parcel*; if the order is material, the class is termed a *group*. The distribution into parcels is alone considered here, and the main problem is the enumeration of the distributions of objects defined by the partition $(pqr \dots)$ of the number n into parcels defined by the partition $(p_1q_1r_1 \dots)$ of the number m . (See "Symmetric Functions and the Theory of Distributions," *Proc. London Mathematical Society*, vol. xix.) Three particular cases are of great importance. Case I. is the "one-to-one distribution," in which the number of parcels is equal to the number of objects, and one object is distributed in each parcel. Case II. is that in which the parcels are all different, being defined by the partition $(1111 \dots)$, conveniently written (1^m) ; this is the theory of the compositions of unipartite and multipartite numbers. Case III. is that in which the parcels are all similar, being defined by the partition (m) ; this is the theory of the partitions of unipartite and multipartite numbers. Previous to discussing these in detail, it is necessary to describe the method of symmetric functions which will be largely utilized.

Let $\alpha, \beta, \gamma, \dots$ be the roots of the equation

$$x^n - a_1x^{n-1} + a_2x^{n-2} - \dots = 0.$$

The symmetric function $\Sigma \alpha^p \beta^q \gamma^r \dots$, where $p+q+r+\dots=n$ is, in the partition notation, written $(pqr \dots)$. Let $A_{(pqr \dots), (p_1q_1r_1 \dots)}$ denote the number of ways of distributing the n objects defined by the partition $(pqr \dots)$ into the m parcels defined by the partition $(p_1q_1r_1 \dots)$.

The expression

$$\Sigma A_{(pqr \dots), (p_1q_1r_1 \dots)} \cdot (pqr \dots),$$

where the numbers $p_1, q_1, r_1 \dots$ are fixed and assumed to be in descending order of magnitude, the summation being for every partition $(pqr \dots)$ of the number n , is defined to be the distribution function of the objects defined by $(pqr \dots)$ into the parcels defined by $(p_1q_1r_1 \dots)$. It gives a complete enumeration of n objects of whatever species into parcels of the given species.

1. *One-to-One Distribution.* *Parcels m in number (i.e. m=n).*—

Case I. Let h_s be the homogeneous product-sum of degree s of the quantities $\alpha, \beta, \gamma, \dots$ so that

$$(1 - \alpha x - \beta x - \gamma x - \dots)^{-1} = 1 + h_1x + h_2x^2 + h_3x^3 + \dots$$

$$h_1 = \Sigma \alpha = (1)$$

$$h_2 = \Sigma \alpha^2 + \Sigma \alpha\beta = (2) + (1^2)$$

$$h_3 = \Sigma \alpha^3 + \Sigma \alpha^2\beta + \Sigma \alpha\beta\gamma = (3) + (21) + (1^3).$$

Form the product $h_{p_1}h_{q_1}h_{r_1} \dots$

Any term in h_{p_1} may be regarded as derived from p_1 objects distributed into p_1 similar parcels, one object in each parcel, since the order of occurrence of the letters $\alpha, \beta, \gamma, \dots$ in any term is immaterial. Moreover, every selection of p_1 letters from the letters in $\alpha^{p_1}\beta^{q_1}\gamma^{r_1} \dots$ will occur in some term of h_{p_1} , every further selection of q_1 letters will occur in some term of h_{q_1} , and so on. Therefore in the product $h_{p_1}h_{q_1}h_{r_1} \dots$ the term $\alpha^{p_1}\beta^{q_1}\gamma^{r_1} \dots$, and therefore also the symmetric function $(pqr \dots)$, will occur as many times as it is possible to distribute objects defined by $(pqr \dots)$ into parcels defined by $(p_1q_1r_1 \dots)$ one object in each parcel. Hence

$$\Sigma A_{(pqr \dots), (p_1q_1r_1 \dots)} \cdot (pqr \dots) = h_{p_1}h_{q_1}h_{r_1} \dots$$

This theorem is of algebraic importance; for consider the simple particular case of the distribution of objects (43) into parcels (52), and represent objects and parcels by small and capital letters respectively. One distribution is shown by the scheme

$$\begin{array}{cccccc} A & A & A & A & B & B \\ a & a & a & a & b & b \end{array}$$

wherein an object denoted by a small letter is placed in a parcel denoted by the capital letter immediately above it. We may interchange small and capital letters and derive from it a distribution of objects (52) into parcels (43); viz. —

$$\begin{array}{cccccc} A & A & A & B & B & B \\ a & a & a & a & b & b \end{array}$$

The process is clearly of general application, and establishes a one-to-one correspondence between the distribution of objects $(pqr \dots)$ into parcels $(p_1q_1r_1 \dots)$ and the distribution of objects $(p_1q_1r_1 \dots)$ into parcels $(pqr \dots)$. It is in fact, in Case I., an intuitive observation that we may either consider an object placed in or attached to a parcel, or a parcel placed in or attached to an object. Analytically we have

Theorem.—"The coefficient of symmetric function $(pqr \dots)$ in the development of the product $h_{p_1}h_{q_1}h_{r_1} \dots$ is equal to the coefficient of symmetric function $(p_1q_1r_1 \dots)$ in the development of the product $h_p h_q h_r \dots$."

The problem of Case I. may be considered when the distributions are subject to various restrictions. If the restriction be to the effect that an aggregate of similar parcels is not to contain more than one object of a kind, we have clearly to deal with the elementary symmetric functions a_1, a_2, a_3, \dots or $(1), (1^2), (1^3), \dots$ in lieu of the quantities h_1, h_2, h_3, \dots . The distribution function has then the value $a_{p_1}a_{q_1}a_{r_1} \dots$ or $(1^{p_1})(1^{q_1})(1^{r_1}) \dots$, and by interchange of object and parcel we arrive at the well-known theorem of symmetry in symmetric functions, which states that the coefficient of symmetric function $(pqr \dots)$ in the development of the product $a_{p_1}a_{q_1}a_{r_1} \dots$ in a series of monomial symmetric functions, is equal to the coefficient of the function $(p_1q_1r_1 \dots)$ in the similar development of the product $a_p a_q a_r \dots$.

The general result of Case I. may be further analysed with important consequences.

Write

$$\begin{aligned} X_1 &= (1)x_1, \\ X_2 &= (2)x_2 + (1^2)x_1^2, \\ X_3 &= (3)x_3 + (21)x_2x_1 + (1^3)x_1^3 \end{aligned}$$

and generally

$$X_s = \Sigma (\lambda_{\mu\nu} \dots) x_{\lambda} x_{\mu} x_{\nu} \dots$$

the summation being in regard to every partition of s . Consider the result of the multiplication—

$$X_{p_1} X_{q_1} X_{r_1} \dots = \Sigma P x_1^{\sigma_1} x_2^{\sigma_2} x_3^{\sigma_3} \dots$$

To determine the nature of the symmetric function P a few definitions are necessary.

Definition I.—Of a number n take any partition $(\lambda_1 \lambda_2 \lambda_3 \dots \lambda_s)$ and separate it into component partitions thus:—

$$(\lambda_1 \lambda_2) (\lambda_3 \lambda_4 \lambda_5) (\lambda_6) \dots$$

in any manner. This may be termed a *separation* of the partition, the numbers occurring in the separation being identical with those which occur in the partition. In the theory of symmetric functions the separation denotes the product of symmetric functions—

$$\Sigma \alpha^{\lambda_1} \beta^{\lambda_2} \Sigma \alpha^{\lambda_3} \beta^{\lambda_4} \gamma^{\lambda_5} \Sigma \alpha^{\lambda_6} \dots$$

The portions $(\lambda_1 \lambda_2), (\lambda_3 \lambda_4 \lambda_5), (\lambda_6), \dots$ are termed *separates*, and if $\lambda_1 + \lambda_2 = p_1, \lambda_3 + \lambda_4 + \lambda_5 = q_1, \lambda_6 = r_1, \dots$ be in descending order of magnitude, the usual arrangement, the separation is said to have a *species* denoted by the partition $(p_1q_1r_1 \dots)$ of the number n .

Definition II.—If in any distribution of n objects into n parcels (one object in each parcel), we write down a number ξ_i whenever we observe ξ_i similar objects in similar parcels we will obtain a succession of numbers $\xi_1, \xi_2, \xi_3, \dots$, where $(\xi_1, \xi_2, \xi_3, \dots)$ is some partition of n . The distribution is then said to have a *specification* denoted by the partition $(\xi_1 \xi_2 \xi_3 \dots)$.

Now it is clear that P consists of an aggregate of terms, each of which, to a numerical factor $pr\delta s$, is a separation of the partition $(\sigma_1 \sigma_2 \sigma_3 \dots)$ of species $(p_1q_1r_1 \dots)$. Further, P is the distribution function of objects into parcels denoted by $(p_1q_1r_1 \dots)$, subject to the restriction that the distributions have each of them the specification

denoted by the partition $(s_1^{p_1} s_2^{p_2} s_3^{p_3} \dots)$. Employing a more general notation we may write

$$X_{p_1}^{n_1} X_{p_2}^{n_2} X_{p_3}^{n_3} \dots = \Sigma P x_{s_1}^{\sigma_1} x_{s_2}^{\sigma_2} x_{s_3}^{\sigma_3} \dots$$

and then P is the distribution function of objects into parcels $(p_1^{n_1} p_2^{n_2} p_3^{n_3} \dots)$, the distributions being such as to have the specification $(s_1^{\sigma_1} s_2^{\sigma_2} s_3^{\sigma_3} \dots)$. Multiplying out P so as to exhibit it as a sum of monomials, we get a result—

$$X_{p_1}^{n_1} X_{p_2}^{n_2} X_{p_3}^{n_3} \dots = \Sigma \Sigma \theta (\lambda_1^{l_1} \lambda_2^{l_2} \lambda_3^{l_3} \dots) x_{s_1}^{\sigma_1} x_{s_2}^{\sigma_2} x_{s_3}^{\sigma_3} \dots$$

indicating that for distributions of specification $(s_1^{\sigma_1} s_2^{\sigma_2} s_3^{\sigma_3} \dots)$ there are θ ways of distributing n objects denoted by $(\lambda_1^{l_1} \lambda_2^{l_2} \lambda_3^{l_3} \dots)$ amongst n parcels denoted by $(p_1^{n_1} p_2^{n_2} p_3^{n_3} \dots)$, one object in each parcel. Now observe that as before we may interchange parcel and object, and that this operation leaves the specification of the distribution unchanged. Hence the number of distributions must be the same, and if

$$X_{p_1}^{n_1} X_{p_2}^{n_2} X_{p_3}^{n_3} \dots = \dots + \theta (\lambda_1^{l_1} \lambda_2^{l_2} \lambda_3^{l_3} \dots) x_{s_1}^{\sigma_1} x_{s_2}^{\sigma_2} x_{s_3}^{\sigma_3} \dots + \dots$$

then also

$$X_{\lambda_1}^{l_1} X_{\lambda_2}^{l_2} X_{\lambda_3}^{l_3} \dots = \dots + \theta (p_1^{n_1} p_2^{n_2} p_3^{n_3} \dots) x_{s_1}^{\sigma_1} x_{s_2}^{\sigma_2} x_{s_3}^{\sigma_3} \dots + \dots$$

This extensive theorem of algebraic reciprocity includes many known theorems of symmetry in the theory of Symmetric Functions.

The whole of the theory has been extended to include symmetric functions symbolized by partitions which contain as well zero and negative parts

2. *The Compositions of Multipartite Numbers. Parcels denoted by (1^m) .*—There are here no similarities between the parcels.

Let $(\pi_1 \pi_2 \pi_3 \dots)$ be a partition of m .

Case II.

$(p_1^{n_1} p_2^{n_2} p_3^{n_3} \dots)$ a partition of n .

Of the whole number of distributions of the n objects, there will be a certain number such that n_1 parcels each contain p_1 objects, and in general π_s parcels each contain p_s objects, where $s=1, 2, 3, \dots$

Consider the product $h_{p_1}^{n_1} h_{p_2}^{n_2} h_{p_3}^{n_3} \dots$ which can be permuted in

$\frac{m!}{\pi_1! \pi_2! \pi_3! \dots}$ ways. For each of these ways $h_{p_1}^{n_1} h_{p_2}^{n_2} h_{p_3}^{n_3} \dots$ will be a distribution function for distributions of the specified type. Hence, regarding all the permutations, the distribution function is

$$\frac{m!}{\pi_1! \pi_2! \pi_3! \dots} h_{p_1}^{n_1} h_{p_2}^{n_2} h_{p_3}^{n_3} \dots$$

and regarding, as well, all the partitions of n into exactly m parts, the desired distribution function is

$$\Sigma \frac{m!}{\pi_1! \pi_2! \pi_3! \dots} h_{p_1}^{n_1} h_{p_2}^{n_2} h_{p_3}^{n_3} \dots \quad [\Sigma \pi = m, \Sigma \pi p = n],$$

that is, it is the coefficient of x^n in $(h_1 x + h_2 x^2 + h_3 x^3 + \dots)^m$. The value of $A(p_1^{n_1} p_2^{n_2} p_3^{n_3} \dots)$, (1^m) is the coefficient of $(p_1^{n_1} p_2^{n_2} p_3^{n_3} \dots) x^n$ in the development of the above expression, and is easily shown to have the value

$$\begin{aligned} & \binom{p_1+m-1}{p_1}^{n_1} \binom{p_2+m-1}{p_2}^{n_2} \binom{p_3+m-1}{p_3}^{n_3} \dots \\ & - \binom{m}{1} \binom{p_1+m-2}{p_1}^{n_1} \binom{p_2+m-2}{p_2}^{n_2} \binom{p_3+m-2}{p_3}^{n_3} \dots \\ & + \binom{m}{2} \binom{p_1+m-3}{p_1}^{n_1} \binom{p_2+m-3}{p_2}^{n_2} \binom{p_3+m-3}{p_3}^{n_3} \dots \\ & \dots \text{to } m \text{ terms.} \end{aligned}$$

Observe that when $p_1=p_2=p_3=\dots=\pi_1=\pi_2=\pi_3=\dots=1$ this expression reduces to the m th divided differences of 0^n . The expression gives the compositions of the multipartite number $p_1^{n_1} p_2^{n_2} p_3^{n_3} \dots$ into m parts. Summing the distribution function from $m=1$ to $m=\infty$ and putting $x=1$, as we may without detriment, we find that the totality of the compositions is given by $\frac{h_1+h_2+h_3+\dots}{1-h_1-h_2-h_3-\dots}$ which may be given the form $\frac{a_1-a_2+a_3-\dots}{1-2(a_1-a_2+a_3-\dots)}$. Adding $\frac{1}{2}$ we bring this to the still more convenient form

$$\frac{1}{2} \frac{1}{1-2(a_1-a_2+a_3-\dots)}$$

Let $F(p_1^{n_1} p_2^{n_2} p_3^{n_3} \dots)$ denote the total number of compositions of the multipartite $p_1^{n_1} p_2^{n_2} p_3^{n_3} \dots$. Then $\frac{1}{1-2a} = \frac{1}{2} + \Sigma F(p) a^p$, and thence $F(p) = 2^{p-1}$. Again $\frac{1}{1-2(a+\beta-a\beta)} = \frac{1}{2} + \Sigma F(p_1 p_2) a^{p_1} \beta^{p_2}$, and expanding the left-hand side we easily find

$$F(p_1 p_2) = 2^{p_1+p_2-1} \frac{(p_1+p_2)!}{0! p_1! p_2!} - 2^{p_1+p_2-2} \frac{(p_1+p_2-1)!}{1!(p_1-1)!(p_2-1)!} + 2^{p_1+p_2-3} \frac{(p_1+p_2-2)!}{2!(p_1-2)!(p_2-2)!} - \dots$$

We have found that the number of compositions of the multipartite $p_1 p_2 p_3 \dots p_s$ is equal to the coefficient of symmetric function $(p_1 p_2 p_3 \dots p_s)$ or of the single term $a_1^{p_1} a_2^{p_2} a_3^{p_3} \dots a_s^{p_s}$ in the development according to ascending powers of the algebraic fraction

$$\frac{1}{\frac{1}{2} \cdot \frac{1}{1-2(\Sigma a_1 - \Sigma a_1 a_2 + \Sigma a_1 a_2 a_3 - \dots + (-)^{s+1} a_1 a_2 a_3 \dots a_s)}}$$

This result can be put into another suggestive form, for it can be proved that this portion of the expanded fraction

$$\frac{1}{\frac{1}{2} \cdot \frac{1}{|1-l_1(2a_1+a_2+\dots+a_s)| |1-l_2(2a_1+2a_2+\dots+a_s)| \dots |1-l_s(2a_1+2a_2+\dots+2a_s)|}}$$

which is composed entirely of powers of

$$l_1 a_1, l_2 a_2, l_3 a_3, \dots, l_s a_s$$

has the expression

$$\frac{1}{\frac{1}{2} \cdot \frac{1}{1 - (\Sigma l_1 a_1 - \Sigma l_1 l_2 a_1 a_2 + \Sigma l_1 l_2 l_3 a_1 a_2 a_3 - \dots + (-)^{s+1} l_1 l_2 \dots l_s a_1 a_2 \dots a_s)}}$$

and therefore the coefficient of $a_1^{p_1} a_2^{p_2} \dots a_s^{p_s}$ in the latter fraction, when l_1, l_2, \dots are put equal to unity, is equal to the coefficient of the same term in the product

$$\frac{1}{2} (2a_1 + a_2 + \dots + a_s)^{p_1} (2a_1 + 2a_2 + \dots + a_s)^{p_2} \dots (2a_1 + 2a_2 + \dots + 2a_s)^{p_s}$$

This result gives a direct connexion between the number of compositions and the permutations of the letters in the product $a_1^{p_1} a_2^{p_2} \dots a_s^{p_s}$. Selecting any permutation, suppose that the letter a_r occurs q_r times in the last $p_r + p_{r+1} + \dots + p_s$ places of the permutation; the coefficient in question may be represented by $\frac{1}{2} \Sigma 2^{l_1+q_2+\dots+q_s}$, the summation being for every permutation, and since $q_1 = p_1$ this may be written

$$2^{p_1-1} \Sigma 2^{q_2+q_3+\dots+q_s}$$

Ex. Gr.—For the bipartite $\overline{22}$, $p_1 = p_2 = 2$, and we have the following scheme:—

$a_1 a_1$	$a_2 a_2$	$q_2 = 2$
$a_1 a_2$	$a_1 a_2$	$= 1$
$a_2 a_1$	$a_2 a_1$	$= 1$
$a_2 a_2$	$a_2 a_2$	$= 1$
$a_2 a_1$	$a_2 a_1$	$= 1$
$a_2 a_2$	$a_1 a_1$	$= 0$

Hence $F(22) = 2(2^2 + 2 + 2 + 2 + 2^0) = 26$.

We may regard the fraction

$$\frac{1}{\frac{1}{2} \cdot \frac{1}{|1-l_1(2a_1+a_2+\dots+a_s)| |1-l_2(2a_1+2a_2+\dots+a_s)| \dots |1-l_s(2a_1+2a_2+\dots+2a_s)|}}$$

as a redundant generating function, the enumeration of the compositions being given by the coefficient of

$$(l_1 a_1)^{p_1} (l_2 a_2)^{p_2} \dots (l_s a_s)^{p_s}$$

The transformation of the pure generating function into a factorized redundant form supplies the key to the solution of a large number of questions in the theory of ordinary permutations, as will be seen later.

[The transformation of the last section involves *The theory of permutations*, a comprehensive theory of Permutations, which it is convenient to discuss shortly here.

If $X_1, X_2, X_3, \dots, X_n$ be linear functions given by the matricular relation

$$(X_1, X_2, \dots, X_n) = \begin{pmatrix} a_{11} & a_{12} & \dots & a_{1n} \\ a_{21} & a_{22} & \dots & a_{2n} \\ \dots & \dots & \dots & \dots \\ a_{n1} & a_{n2} & \dots & a_{nn} \end{pmatrix} (x_1, x_2, \dots, x_n)$$

that portion of the algebraic fraction,

$$\frac{1}{(1-s_1 X_1)(1-s_2 X_2) \dots (1-s_n X_n)}$$

which is a function of the products $s_1 x_1, s_2 x_2, s_3 x_3, \dots, s_n x_n$ only is

$$\frac{1}{[(1-a_{11}s_1 x_1)(1-a_{22}s_2 x_2)(1-a_{33}s_3 x_3) \dots (1-a_{nn}s_n x_n)]}$$

where the denominator is in a symbolic form and denotes on expansion

$$1 - \Sigma |a_{11}| s_1 x_1 + \Sigma |a_{11} a_{22}| s_1 s_2 x_1 x_2 - \dots + (-)^n |a_{11} a_{22} a_{33} \dots a_{nn}| s_1 s_2 \dots s_n x_1 x_2 \dots x_n$$

where $|a_{11}|, |a_{11} a_{22}|, \dots, |a_{11} a_{22} \dots a_{nn}|$ denote the several co-axial minors of the determinant

$$|a_{11} a_{22} \dots a_{nn}|$$

of the matrix. (For the proof of this theorem see MacMahon, "A certain Class of Generating Functions in the Theory of Numbers," *Phil. Trans. R. S.* vol. clxxxv. A, 1894). It follows that the coefficient of

$$x_1^{f_1} x_2^{f_2} \dots x_n^{f_n}$$

in the product

$(a_{11}x_1 + a_{12}x_2 + \dots + a_{1n}x_n)^{\xi_1} (a_{21}x_1 + a_{22}x_2 + \dots + a_{2n}x_n)^{\xi_2} \dots (a_{n1}x_1 + a_{n2}x_2 + \dots + a_{nn}x_n)^{\xi_n}$ is equal to the coefficient of the same term in the expansion ascending-wise of the fraction

$$\frac{1}{1 - \sum |a_{11}|x_1 + \sum |a_{12}|x_1x_2 - \dots + (-1)^n |a_{11}a_{22} \dots| x_1x_2 \dots x_n}$$

If the elements of the determinant be all of them equal to unity, we obtain the functions which enumerate the unrestricted permutations of the letters in

$$x_1^{\xi_1} x_2^{\xi_2} \dots x_n^{\xi_n}$$

viz.

$$(x_1 + x_2 + \dots + x_n)^{\xi_1 + \xi_2 + \dots + \xi_n}$$

and

$$\frac{1}{1 - (x_1 + x_2 + \dots + x_n)}$$

Suppose that we wish to find the generating function for the enumeration of those permutations of the letters in $x_1^{\xi_1} x_2^{\xi_2} \dots x_n^{\xi_n}$ which are such that no letter x_i is in a position originally occupied by an x_j for all values of s . This is a generalization of the "Problème des rencontres" or of "derangements." We have merely to put

$$a_{11} = a_{22} = a_{33} = \dots = a_{nn} = 0$$

and the remaining elements equal to unity. The generating product is

$$(x_2 + x_3 + \dots + x_n)^{\xi_1} (x_1 + x_3 + \dots + x_n)^{\xi_2} \dots (x_1 + x_2 + \dots + x_{n-1})^{\xi_n}$$

and to obtain the condensed form we have to evaluate the co-axial minors of the invertibrate determinant—

$$\begin{vmatrix} 0 & 1 & 1 & \dots & 1 \\ 1 & 0 & 1 & \dots & 1 \\ 1 & 1 & 0 & \dots & 1 \\ \vdots & \vdots & \vdots & \ddots & \vdots \\ 1 & 1 & 1 & \dots & 0 \end{vmatrix}$$

The minors of the 1st, 2nd, 3rd ... n th orders have respectively the values

$$\begin{matrix} 0 \\ -1 \\ +2 \\ \vdots \\ (-1)^{n-1}(n-1), \end{matrix}$$

therefore the generating function is

$$\frac{1}{1 - \sum x_1x_2 - 2\sum x_1x_2x_3 - \dots - s\sum x_1x_2 \dots x_{s+1} - \dots - (n-1)x_1x_2 \dots x_n}$$

or writing

$$(x - x_1)(x - x_2) \dots (x - x_n) = x^n - a_1x^{n-1} + a_2x^{n-2} - \dots,$$

this is

$$\frac{1}{1 - a_2 - 2a_3 - 3a_4 - \dots - (n-1)a_n}$$

Again, consider the general problem of "derangements." We have to find the number of permutations such that exactly m of the letters are in places they originally occupied. We have the particular redundant product

$$(a_1x_1 + x_2 + \dots + x_n)^{\xi_1} (x_1 + a_2x_2 + \dots + x_n)^{\xi_2} \dots (x_1 + x_2 + \dots + a_nx_n)^{\xi_n}$$

in which the sought number is the coefficient of $a^m x_1^{\xi_1} x_2^{\xi_2} \dots x_n^{\xi_n}$. The true generating function is derived from the determinant

$$\begin{vmatrix} a & 1 & 1 & 1 & \dots & 1 \\ 1 & a & 1 & 1 & \dots & 1 \\ 1 & 1 & a & 1 & \dots & 1 \\ 1 & 1 & 1 & a & \dots & 1 \\ \vdots & \vdots & \vdots & \vdots & \ddots & \vdots \\ 1 & 1 & 1 & 1 & \dots & a \end{vmatrix}$$

and has the form

$$\frac{1}{1 - a \sum x_i + (a-1)(a+1) \sum x_1x_2 - \dots + (-1)^n (a-1)^{n-1} (a+n-1) x_1x_2 \dots x_n}$$

It is clear that a large class of problems in permutations can be solved in a similar manner, viz. by giving special values to the elements of the determinant of the matrix. The redundant product leads uniquely to the real generating function, but the latter has generally more than one representation as a redundant product, in the cases in which it is representable at all. For the existence of a redundant form, the coefficients of $x_1, x_2, \dots, x_1x_2 \dots$ in the denominator of the real generating function must satisfy $2^n - n^2 + n - 2$ conditions, and assuming this to be the case, a redundant form can be constructed which involves $n-1$ undetermined quantities. We are thus able to pass from any particular redundant generating function to one equivalent to it, but involving $n-1$ undetermined quantities. Assuming these quantities at pleasure we obtain a number of different algebraic products, each of which may have its own meaning in arithmetic,

and thus the number of arithmetical correspondences obtainable is subject to no finite limit (cf. MacMahon, *loc. cit.* pp. 125 et seq.)

3. *The Theory of Partitions. Parcels defined by (m).*—When an ordinary unipartite number n is broken up into other numbers, and the order of occurrence of the numbers is immaterial, the collection of numbers is termed a partition of the number n . It is usual to arrange the numbers comprised in the collection, termed the parts of the partition, in descending order of magnitude, and to indicate repetitions of the same part by the use of exponents. Thus (32111), a partition of 8, is written (321³). Euler's pioneering work in the subject rests on the observation that the algebraic multiplication

$$x^a \times x^b \times x^c \times \dots = x^{a+b+c+\dots}$$

is equivalent to the arithmetical addition of the exponents a, b, c, \dots . He showed that the number of ways of composing n with p integers drawn from the series a, b, c, \dots repeated or not, is equal to the coefficient of x^n in the ascending expansion of the fraction

$$\frac{1}{1 - \zeta x^a - \zeta x^b - \zeta x^c - \dots}$$

which he termed the generating function of the partitions in question.

If the partitions are to be composed of p , or fewer parts, it is merely necessary to multiply this fraction by $\frac{1}{1 - \zeta}$. Similarly, if the parts are to be un-repeated, the generating function is the algebraic product

$$(1 + \zeta x^a)(1 + \zeta x^b)(1 + \zeta x^c) \dots ; \dots$$

if each part may occur at most twice,

$$(1 + \zeta x^a + \zeta^2 x^{2a})(1 + \zeta x^b + \zeta^2 x^{2b})(1 + \zeta x^c + \zeta^2 x^{2c}) \dots ;$$

and generally if each part may occur at most $k-1$ times it is

$$\frac{1 - \zeta^k x^{ka}}{1 - \zeta x^a} \cdot \frac{1 - \zeta^k x^{kb}}{1 - \zeta x^b} \cdot \frac{1 - \zeta^k x^{kc}}{1 - \zeta x^c} \dots$$

It is thus easy to form generating functions for the partitions of numbers into parts subject to various restrictions. If there be no restriction in regard to the numbers of the parts, the generating function is

$$\frac{1}{1 - x^a - 1 - x^b - 1 - x^c - \dots}$$

and the problems of finding the partitions of a number n , and of determining their number, are the same as those of solving and enumerating the solutions of the indeterminate equation in positive integers

$$ax + by + cz + \dots = n.$$

Euler considered also the question of enumerating the solutions of the indeterminate simultaneous equation in positive integers

$$\begin{aligned} ax + by + cz + \dots &= n \\ a'x + b'y + c'z + \dots &= n' \\ a''x + b''y + c''z + \dots &= n'' \end{aligned}$$

which was called by him and those of his time the "Problem of the Virgins." The enumeration is given by the coefficient of $x^n y^{n'} z^{n''} \dots$ in the expansion of the fraction

$$\frac{1}{(1 - x^a y^b z^c \dots)(1 - x^{a'} y^{b'} z^{c'} \dots)(1 - x^{a''} y^{b''} z^{c''} \dots) \dots}$$

which enumerates the partitions of the multipartite number $n'n'' \dots$ into the parts

$$abc \dots, a'b'c' \dots, a''b''c'' \dots$$

Sylvester has determined an analytical expression for the coefficient of x^n in the expansion of

$$\frac{1}{(1 - x^a)(1 - x^b) \dots (1 - x^t)}$$

To explain this we have two lemmas:—

Lemma 1.—The coefficient of x^{-1} , i.e., after Cauchy, the residue in the ascending expansion of $(1 - x^i)^{-1}$, is -1 . For when i is unity, it is obviously the case, and

$$\begin{aligned} (1 - x^i)^{-1} &= (1 - x^i)^{-1} + x^i (1 - x^i)^{-1} \\ &= (1 - x^i)^{-1} + \frac{d}{dx} (1 - x^i)^{-1} \cdot \frac{1}{i} \end{aligned}$$

Here the residue of $\frac{d}{dx} (1 - x^i)^{-1}$ is zero, and therefore the residue of $(1 - x^i)^{-1}$ is unchanged when i is increased by unity, and is therefore always -1 for all values of i .

Lemma 2.—The constant term in any proper algebraical fraction developed in ascending powers of its variable is the same as the residue, with changed sign, of the sum of the fractions obtained by substituting in the given fraction, in lieu of the variable, its exponential multiplied in succession by each of its values (zero excepted, if there be such), which makes the given fraction infinite. For write the proper algebraical fraction

$$F(x) = \sum \sum \frac{\gamma_{\lambda, \mu}}{(x - \mu)^{\lambda}} + \sum \frac{\gamma_{\lambda}}{x^{\lambda}}$$

The constant term is $\sum \frac{c_{\lambda, \mu}}{a_{\mu}^{\lambda}}$
 Let a be a value of x which makes the fraction infinite. The residue of

$$\sum \sum \frac{c_{\lambda, \mu}}{(a_{\mu} - a_{\nu} e^{\lambda})^{\lambda}} + \sum \frac{\gamma_{\lambda}}{a_{\nu}^{\lambda} e^{\lambda x}}$$

is equal to the residue of

$$\sum \sum \frac{c_{\lambda, \mu}}{(a_{\mu} - a_{\nu} e^{\lambda})^{\lambda}}$$

and when $\nu = \mu$, the residue vanishes, so that we have to consider

$$\sum \frac{c_{\lambda, \mu}}{a_{\mu}^{\lambda} (1 - e^{\lambda})^{\lambda}}$$

and the residue of this is, by the first lemma,

$$-\sum \frac{c_{\lambda, \mu}}{a_{\mu}^{\lambda}}$$

which proves the lemma.

Take $F(x) = \frac{1}{x^n(1-x^a)(1-x^b)\dots(1-x^l)} = \frac{f(x)}{x^n}$, since the sought number is its constant term.

Let ρ be a root of unity which makes $f(x)$ infinite when substituted for x . The function of which we have to take the residue is

$$\frac{\sum \rho^{-n} e^{nx} f(\rho e^{-x})}{\rho^{-n} e^{nx}} = \sum \frac{1}{(1 - \rho^a e^{-ax})(1 - \rho^b e^{-bx}) \dots (1 - \rho^l e^{-lx})}$$

We may divide the calculation up into sections by considering separately that portion of the summation which involves the primitive q th roots of unity, q being a divisor of one of the numbers a, b, \dots, l . Thus the q th wave is

$$\sum \frac{\rho_q^{-n} e^{nx}}{(1 - \rho_q^a e^{-ax})(1 - \rho_q^b e^{-bx}) \dots (1 - \rho_q^l e^{-lx})}$$

which, putting $\frac{1}{\rho_q}$ for ρ_q and $\nu = n + \frac{1}{2}(a + b + \dots + l)$, may be written

$$\sum \frac{\rho_q^{\nu} e^{\nu x}}{(\rho_q^{\frac{1}{2}a} e^{\frac{1}{2}ax} - \rho_q^{-\frac{1}{2}a} e^{-\frac{1}{2}ax})(\rho_q^{\frac{1}{2}b} e^{\frac{1}{2}bx} - \rho_q^{-\frac{1}{2}b} e^{-\frac{1}{2}bx}) \dots (\rho_q^{\frac{1}{2}l} e^{\frac{1}{2}lx} - \rho_q^{-\frac{1}{2}l} e^{-\frac{1}{2}lx})}$$

and the calculation in simple cases is practicable.

Thus Sylvester finds for the coefficient of x^n in

$$\frac{1}{1-x, 1-x^2, 1-x^3}$$

$$\frac{\nu^3}{12} - \frac{7\nu}{72} - \frac{1}{8}(-)^{\nu} + \frac{1}{9}(\nu_3^{\nu} + \nu_3^{-\nu})$$

the expression where $\nu = n + 3$.

Sylvester, Franklin, Durfee, G. S. Ely and others have evolved a constructive theory of partitions, the object of which is the contemplation of the partitions themselves, and the evolution of their properties from a study of their inherent characters. It is concerned for the most part with the partition of a number into parts drawn from the natural series of numbers 1, 2, 3, Any partition, say (521) of the number 8, is represented by nodes placed in order at the points of a rectangular lattice,

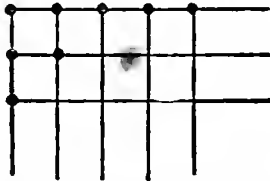

when the partition is given by the enumeration of the nodes by lines. If we enumerate by columns we obtain another partition of 8, viz. (321²), which is termed the conjugate of the former. The fact or conjugacy was first pointed out by Norman Macleod Ferrers. If the original partition is one of a number n in i parts, of which the largest is j , the conjugate is one into j parts, of which the largest is i , and we obtain the theorem:—"The number of partitions of any number into i parts or fewer, and having the largest part equal to j , remains the same when the numbers i and j are interchanged."

The study of this representation on a lattice (termed by

Sylvester the "graph") yields many theorems similar to that just given, and, moreover, throws considerable light upon the expansion of algebraic series.

The theorem of reciprocity just established shows that the number of partitions of n into j parts or fewer, is the same as the number of ways of composing n with the integers 1, 2, 3, . . . j . Hence we can

expand $\frac{1}{1-a, 1-ax, 1-ax^2, 1-ax^3, \dots}$ in ascending powers of a ; for the coefficient of $a^i x^n$ in the expansion is the number of ways of composing n with j or fewer parts, and this we have seen in the

coefficients of x^n in the ascending expansion of $\frac{1}{1-x, 1-x^2, \dots, 1-x^j}$. Therefore

$$\frac{1}{1-a, 1-ax, 1-ax^2, \dots} = 1 + \frac{a}{1-x} + \frac{a^2}{1-x, 1-x^2} + \dots + \frac{a^j}{1-x, 1-x^2, \dots, 1-x^j} + \dots$$

The coefficient of $a^i x^n$ in the expansion of

$$\frac{1}{1-a, 1-ax, 1-ax^2, \dots, 1-ax^i}$$

denotes the number of ways of composing n with j or fewer parts, none of which are greater than i . The expansion is known to be

$$\sum \frac{1-x^{i+1}, 1-x^{i+2}, \dots, 1-x^{i+i}}{1-x, 1-x^2, \dots, 1-x^i} a^j$$

It has been established by the constructive method by F. Franklin (*Amer. Jour. of Math.* v. 254), and shows that the generating function for the partitions in question is

$$\frac{1-x^{i+1}, 1-x^{i+2}, \dots, 1-x^{i+i}}{1-x, 1-x^2, \dots, 1-x^i}$$

which, observe, is unaltered by interchange of i and j .

Franklin has also similarly established the identity of Euler

$$(1-x)(1-x^2)(1-x^3)\dots \text{ad inf.} = \sum_{j=-\infty}^{j=+\infty} (-)^j x^{\frac{1}{2}(3j^2+j)}$$

known as the "pentagonal number theorem," which on interpretation shows that the number of ways of partitioning n into an even number of unrepeat parts is equal to that into an uneven number, except when n has the pentagonal form $\frac{1}{2}(3j^2+j)$, j positive or negative, when the difference between the numbers of the partitions is $(-)^j$.

To illustrate an important dissection of the graph we will consider

those graphs which read the same by columns as by lines; these are called self-conjugate. Such a graph may be obviously dissected into a square, containing say θ^2 nodes, and into two graphs, one lateral and one subjacent, the latter being the conjugate of the former. The former graph is limited to contain not more than θ parts, but is subject to no other condition. Hence the number of self-conjugate partitions of n which are associated with a square of θ^2 nodes is clearly equal to the number of partitions of $\frac{1}{2}(n-\theta^2)$ into θ or few parts, i.e. it is the coefficient of $x^{\frac{1}{2}(n-\theta^2)}$ in

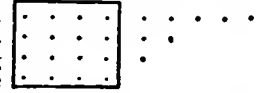

$$\frac{1}{1-x, 1-x^2, 1-x^3, \dots, 1-x^{\theta}}$$

or of x^n in

$$\frac{x^{\theta^2}}{1-x^2, 1-x^4, 1-x^6, \dots, 1-x^{2\theta}}$$

and the whole generating function is

$$1 + \sum_{\theta=1}^{\theta=\infty} \frac{x^{\theta^2}}{1-x^2, 1-x^4, 1-x^6, \dots, 1-x^{2\theta}}$$

Now the graph is also composed of θ angles of nodes, each angle containing an uneven number of nodes; hence the partition is transformable into one containing θ unequal uneven numbers. In the case depicted this partition is (17, 9, 5, 1). Hence the number of the partitions based upon a square of θ^2 nodes is the coefficient of $a^{\theta n}$ in the product $(1+ax)(1+ax^2)(1+ax^3)\dots(1+ax^{2\theta+1})\dots$, and thence

the coefficient of a^{θ} in this product is $\frac{x^{\theta^2}}{1-x^2, 1-x^4, 1-x^6, \dots, 1-x^{2\theta}}$

and we have the expansion

$$(1+ax)(1+ax^2)(1+ax^3)\dots \text{ad inf.}$$

$$= 1 + \frac{x}{1-x^2} a + \frac{x^4}{1-x^2, 1-x^4} a^2 + \frac{x^9}{1-x^2, 1-x^4, 1-x^6} a^3 + \dots$$

Again, if we restrict the part magnitude to i , the largest angle of nodes contains at most $2i-1$ nodes, and based upon a square of θ^2 nodes we have partitions enumerated by the coefficient of $a^{\theta n}$ in the product $(1+ax)(1+ax^2)(1+ax^3)\dots(1+ax^{2i-1})$; moreover the same number enumerates the partition of $\frac{1}{2}(n-\theta^2)$ into θ or fewer parts, of which the largest part is equal to or less than $i-\theta$, and is thus given by the coefficient of $x^{\frac{1}{2}(n-\theta^2)}$ in the expansion of

$$\frac{1-x^{i-\theta+1} \cdot 1-x^{i-\theta+2} \cdot 1-x^{i-\theta+3} \dots 1-x^i}{1-x \cdot 1-x^2 \cdot 1-x^3 \dots 1-x^\theta}$$

or of x^n in

$$\frac{1-x^{2i-2\theta+2} \cdot 1-x^{2i-2\theta+4} \dots 1-x^{2i}}{1-x^2 \cdot 1-x^4 \cdot 1-x^6 \dots 1-x^{2\theta}} x^{\theta^2}$$

hence the expansion

$$(1+ax)(1+ax^3)(1+ax^5)\dots(1+ax^{i-1})$$

$$= 1 + \sum_{\theta=1}^{i-1} \frac{1-x^{2i-2\theta+2} \cdot 1-x^{2i-2\theta+4} \dots 1+x^{2i}}{1-x^2 \cdot 1-x^4 \cdot 1-x^6 \dots 1-x^{2\theta}} x^{\theta^2} a^\theta$$

There is no difficulty in extending the graphical method to three dimensions, and we have then a theory of a special kind of partition of multipartite numbers. Of such kind is the partition

Extension to three dimensions.

$$(a_1 a_2 a_3 \dots, b_1 b_2 b_3 \dots, c_1 c_2 c_3 \dots)$$

of the multipartite number

if $(a_1 + b_1 + c_1 + \dots, a_2 + b_2 + c_2 + \dots, a_3 + b_3 + c_3 + \dots, \dots)$
 $a_1 \geq a_2 \geq a_3 \geq \dots; b_1 \geq b_2 \geq b_3 \geq \dots, \dots$
 $a_i \geq b_i \geq c_i \geq \dots$

for then the graphs of the parts $a_1 a_2 a_3 \dots, b_1 b_2 b_3 \dots, \dots$ are superposable, and we have what we may term a *regular* graph in three dimensions. Thus the partition (643, 632, 411) of the multipartite (16, 8, 6) leads to the graph

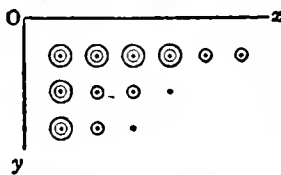

and every such graph is readable in six ways, the axis of z being perpendicular to the plane of the paper.

Ex. Gr.

Plane parallel to xy , direction Ox reads	(643, 632, 411)
" " xy , " Oy "	(333211, 332111, 311100)
" " yz , " Oy "	(333, 331, 321, 211, 110, 110)
" " yz , " Oz "	(333, 322, 321, 310, 200, 200)
" " zx , " Oz "	(333322, 322100, 321000)
" " zx , " Ox "	(664, 431, 321)

the partitions having reference to the multipartite numbers 16, 8, 6, 976422, 13, 11, 6, which are brought into relation through the medium of the graph. The graph in question is more conveniently represented by a numbered diagram, viz.—

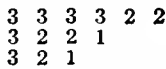

and then we may evidently regard it as a unipartite partition on the points of a lattice,

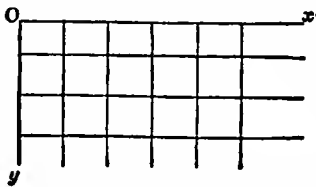

the descending order of magnitude of part being maintained along every line of route which proceeds from the origin in the positive directions of the axes.

This brings in view the modern notion of a partition, which has enormously enlarged the scope of the theory. We consider any number of points *in plano* or *in solido* connected (or not) by lines in pairs in any desired manner and fix upon any condition, such as is implied by the symbols $\geq, >, =, <, \leq, \cong$, as affecting any pair of points so connected. Thus in ordinary unipartite partition we have to solve in integers such a system as

$$a_1 \geq a_2 \geq a_3 \geq \dots \geq a_n$$

$$a_1 + a_2 + a_3 + \dots + a_n = n,$$

the points being in a straight line. In the simplest example of the three-dimensional graph we have to solve the system

$$a_1 \geq a_2$$

$$\forall i \quad a_1 + a_2 + a_3 + a_4 = n,$$

$$a_3 \geq a_4$$

and a system for the general lattice constructed upon the same principle. The system has been discussed by MacMahon, *Phil. Trans.* vol. clxxxvii. A, 1896, pp. 619-673, with the conclusion that if the numbers of nodes along the axes of x, y, z be limited not to

exceed the numbers m, n, l respectively, then writing for brevity $1-x^i = (s)$, the generating function is given by the product of the factors

$$\prod_{x,y} \frac{\binom{l+1}{1} \binom{l+2}{2} \dots \binom{l+m}{m}}{\binom{l+2}{2} \binom{l+3}{3} \dots \binom{l+m+1}{m+1}}$$

one factor appearing at each point of the lattice.

In general, partition problems present themselves which depend upon the solution of a number of simultaneous relations in integers of the form

$$\lambda_1 a_1 + \lambda_2 a_2 + \lambda_3 a_3 + \dots \geq 0,$$

the coefficients λ being given positive or negative integers, and in some cases the generating function has been determined in a form which exhibits the fundamental solutions of the problems from which all other solutions are derivable by addition. (See MacMahon, *Phil. Trans.* vol. cxcii. (1899), pp. 351-401; and *Trans. Camb. Phil. Soc.* vol. xviii. (1899), pp. 12-34.)

The number of distributions of n objects (p_1, p_2, p_3, \dots) into parcels (m) is the coefficient of $b^m (p_1 p_2 p_3 \dots) x^n$ in the development of the fraction.

Method of symmetric functions.

$$\frac{1}{\begin{matrix} (1-bax \cdot 1-b\beta x \cdot 1-b\gamma x \dots) \\ \times (1-ba^2 x^2 \cdot 1-ba\beta x^2 \cdot 1-b\beta^2 x^2 \dots) \\ \times (1-ba^3 x^3 \cdot 1-ba^2 \beta x^3 \cdot 1-ba\beta\gamma x^3 \dots) \end{matrix}}$$

and if we write the expansion of that portion which involves products of the letters a, β, γ, \dots of degree r in the form

$$1 + h_1 b x^r + h_2 b^2 x^{2r} + \dots$$

we may write the development

$$\prod_{r=1}^{\infty} (1 + h_r b x^r + h_r^2 b^2 x^{2r} + \dots),$$

and picking out the coefficient of $b^m x^n$ we find

$$\sum_{h_1 h_2 h_3 \dots} h_1 h_2 h_3 \dots$$

where

$$\sum r = m, \sum 2r = n.$$

The quantities h are symmetric functions of the quantities a, β, γ, \dots which in simple cases can be calculated without difficulty, and then the distribution function can be formed.

Ex. Gr.—Required the enumeration of the partitions of all multipartite numbers ($p_1 p_2 p_3 \dots$) into exactly two parts. We find

$$h_2 = h_4 - h_3 h_1 + h_3^2$$

$$h_4 = h_6 - h_5 h_1 + h_4 h_2$$

$$h_6 = h_8 - h_7 h_1 + h_6 h_2 - h_5 h_3 + h_4^2,$$

and paying attention to the fact that in the expression of h_r the term h_1^r is absent when r is uneven, the law is clear. The generating function is

$$h_2 x^2 + h_2 h_1 x^3 + (h_4 + h_2^2) x^4 + (h_4 h_1 + h_3 h_2) x^5 + (h_6 + 2h_4 h_2) x^6$$

$$+ (h_6 h_1 + h_5 h_2 + h_4 h_3) x^7 + (h_8 + 2h_6 h_2 + h_5^2) x^8 + \dots$$

Taking $h_4 + h_2^2 = h_4 + \{(2) + (1^2)\}^2$
 $= 2(4) + 3(31) + 4(2^2) + 5(21^2) + 7(1^4),$

the term $5(21^2)$ indicates that objects such as a, a, b, c can be partitioned in five ways into two parts. These are $a|a, b, c; b|a, a, c; c|a, a, b; a, a|b, c; a, b|a, c$. The function $h_{p,q}$ has been studied. (See MacMahon, *Proc. Lond. Math. Soc.* vol. xix.) Putting x equal to unity, the function may be written $(h_2 + h_4 + h_6 + \dots) (1 + h_1 + h_2 + h_3 + h_4 + \dots)$, a convenient formula.

The method of differential operators, of wide application to problems of combinatorial analysis, has for its leading idea the designing of a function and of a differential operator, so that when the operator is performed upon the function a number is reached which enumerates the solutions of the given problem. Generally speaking, the problems considered are such as are connected with lattices, or as it is possible to connect with lattices.

Method of differential operators.

To take the simplest possible example, consider the problem of finding the number of permutations of n different letters. The

function is here x^n , and the operator $(\frac{d}{dx})^n = \delta_x^n$, yielding $\delta_x^n x^n = n!$ the number which enumerates the permutations. In fact—

$$\delta_x^n = \delta_x . x . x . x . x . \dots$$

and differentiating we obtain a sum of n terms by striking out an x from the product in all possible ways. Fixing upon any one of these terms, say $x . \delta_x . x . x . \dots$, we again operate with δ_x by striking out an x in all possible ways, and one of the terms so reached is $x . \delta_x . x . \delta_x . x . \dots$. Fixing upon this term, and again operating and continuing the process, we finally arrive at one solution of the problem, which (taking say $n=4$) may be said to be in correspondence with the operator diagram—

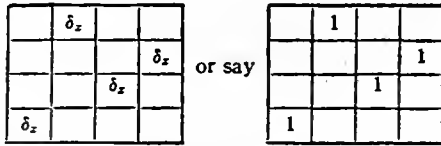

the number in each row of compartments denoting an operation of δ_x . Hence the permutation problem is equivalent to that of placing n units in the compartments of a square lattice of order n in such manner that each row and each column contains a single unit. Observe that the method not only enumerates, but also gives a process by which each solution is actually formed. The same problem is that of placing n rooks upon a chess-board of n^2 compartments, so that no rook can be captured by any other rook.

Regarding these elementary remarks as introductory, we proceed to give some typical examples of the method. Take a lattice of m columns and n rows, and consider the problem of placing units in the compartments in such wise that the s th column shall contain λ_s units ($s=1, 2, 3, \dots, m$), and the t th row ρ_t units ($t=1, 2, 3, \dots, n$).

Writing $1 + a_1x + a_2x^2 + \dots + \dots = (1 + a_1x)(1 + a_2x)(1 + a_3x) \dots$

and $D_p = \frac{1}{p!}(\delta_{a_1} + a_1\delta_{a_2} + a_2\delta_{a_3} + \dots)^p$, the multiplication being symbolic, so that D_p is an operator of order p , the function is

$$a_{1\lambda_1} a_{2\lambda_2} a_{3\lambda_3} \dots a_{m\lambda_m}$$

and the operator $D_{\rho_1} D_{\rho_2} \dots D_{\rho_n}$. The number $D_{\rho_1} D_{\rho_2} \dots D_{\rho_n} a_{1\lambda_1} a_{2\lambda_2} a_{3\lambda_3} \dots a_{m\lambda_m}$ enumerates the solutions. For the mode of operation of D_p upon a product reference must be made to the section on "Differential Operators" in the article ALGEBRAIC FORMS. Writing

$$a_{1\lambda_1} a_{2\lambda_2} \dots a_{m\lambda_m} = \dots + A \sum a_1^{\rho_1} a_2^{\rho_2} \dots a_n^{\rho_n} + \dots$$

or, in partition notation,

$$(1^{\rho_1})(1^{\rho_2}) \dots (1^{\rho_n}) = \dots + A(\rho_1 \rho_2 \dots \rho_n) \dots +$$

$$D_{\rho_1} D_{\rho_2} \dots D_{\rho_n} (1^{\lambda_1})(1^{\lambda_2}) \dots (1^{\lambda_m}) = A,$$

and the law by which the operation is performed upon the product shows that the solutions of the given problem are enumerated by the number A , and that the process of operation actually represents each solution.

Ex. Gr.—Take $\lambda_1=3, \lambda_2=2, \lambda_3=1,$
 $\rho_1=2, \rho_2=2, \rho_3=1, \rho_4=1,$
 $D_2^2 D_1^2 a_1 a_2 a_3 = 8,$

and the process yields the eight diagrams:—

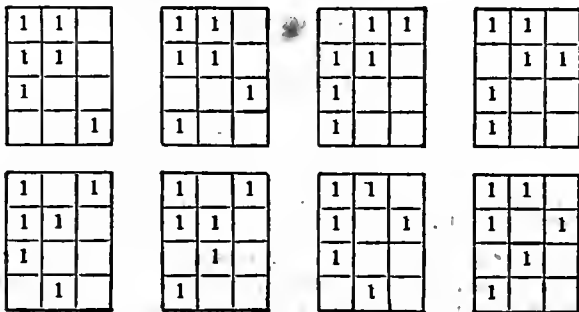

viz. every solution of the problem. Observe that transposition of the diagrams furnishes a proof of the simplest of the laws of symmetry in the theory of symmetric functions.

For the next example we have a similar problem, but no restriction is placed upon the magnitude of the numbers which may appear in the compartments. The function is now $h_{\lambda_1} h_{\lambda_2} \dots h_{\lambda_m}$, h_{λ_m} being the homogeneous product sum of the quantities a , of order λ . The operator is as before

$$D_{\rho_1} D_{\rho_2} \dots D_{\rho_m}$$

and the solutions are enumerated by

$$D_{\rho_1} D_{\rho_2} \dots D_{\rho_m} h_{\lambda_1} h_{\lambda_2} \dots h_{\lambda_m}$$

Putting as before $\lambda_1=3, \lambda_2=2, \lambda_3=1, \rho_1=2, \rho_2=2, \rho_3=1, \rho_4=1$, the reader will have no difficulty in constructing the diagrams of the eighteen solutions.

The next and last example of a multitude that might be given shows the extraordinary power of the method by solving the famous problem of the "Latin Square," which for hundreds of years had proved beyond the powers of mathematicians. The problem consists in placing n letters a, b, c, \dots, n in the compartments of a square lattice of n^2 compartments, no compartment being empty, so that no letter occurs twice either in the same row or in the same column. The function is here

$$(\sum a_1^{n-1} a_2^{n-2} \dots a_{n-1}^1 a_n)^n,$$

and the operator $D_{2^n}^n$, the enumeration being given by

$$D_{2^n}^n (\sum a_1^{n-1} a_2^{n-2} \dots a_{n-1}^1 a_n)^n.$$

See *Trans. Camb. Phil. Soc.* vol. xvi. pt. iv. pp. 262-290.

AUTHORITIES.—P. A. MacMahon, "Combinatory Analysis: A Review of the Present State of Knowledge," *Proc. Lond. Math. Soc.* vol. xxviii. (London, 1897). Here will be found a bibliography of the Theory of Partitions. Whitworth, *Choice and Chance*; Edouard Lucas, *Théorie des nombres* (Paris, 1891); Arthur Cayley, *Collected Mathematical Papers* (Cambridge, 1898), ii. 419; iii. 36, 37; iv. 166-170; v. 62-65, 617; vii. 575; ix. 480-483; x. 16, 38, 611; xi. 61, 62, 357-364, 589-591; xii. 217-219, 273-274; xiii. 47, 93-113, 269; Sylvester, *Amer. Jour. of Math.* v. 119 251; MacMahon, *Proc. Lond. Math. Soc.* xix. 228 et seq.; *Phil. Trans.* clxxxiv. 835-901; clxxxv. 111-160; clxxxvii. 619-673; cxcii. 351-401; *Trans. Camb. Phil. Soc.* xvi. 262-290. (P. A. M.)

COMBUSTION (from the Lat. *comburere*, to burn up), in chemistry, the process of burning or, more scientifically, the oxidation of a substance, generally with the production of flame and the evolution of heat. The term is more customarily given to productions of flame such as we have in the burning of oil, gas, fuel, &c., but it is conveniently extended to other cases of oxidation, such as are met with when metals are heated for a long time in air or oxygen. The term "spontaneous combustion" is used when a substance smoulders or inflames apparently without the intervention of any external heat or light; in such cases, as, for example, in heaps of cotton-waste soaked in oil, the oxidation has proceeded slowly, but steadily, for some time, until the heat evolved has raised the mass to the temperature of ignition.

The explanation of the phenomena of combustion was attempted at very early times, and the early theories were generally bound up in the explanation of the nature of fire or flame. The idea that some extraneous substance is essential to the process is of ancient date; Clement of Alexandria (*c.* 3rd century A.D.) held that some "air" was necessary, and the same view was accepted during the middle ages, when it had been also found that the products of combustion weighed more than the original combustible, a fact which pointed to the conclusion that some substance had combined with the combustible during the process. This theory was supported by the French physician Jean Ray, who showed also that in the cases of tin and lead there was a limit to the increase in weight. Robert Boyle, who made many researches on the origin and nature of fire, regarded the increase as due to the fixation of the particles of fire. Ideas identical with the modern ones were expressed by John Mayow in his *Tractatus quinque medico-physici* (1674), but his death in 1679 undoubtedly accounts for the neglect of his suggestions by his contemporaries. Mayow perceived the similarity of the processes of respiration and combustion, and showed that one constituent of the atmosphere, which he termed *spiritus nitro-aereus*, was essential to combustion and life, and that the second constituent, which he termed *spiritus nitri acidi*, inhibited combustion and life. At the beginning of the 18th century a new theory of combustion was promulgated by Georg Ernst Stahl. This theory regarded combustibility as due to a principle named phlogiston (from the Gr. *φλογιστός*, burnt), which was present in all combustible bodies in an amount proportional to their degree of combustibility; for instance, coal was regarded as practically

pure phlogiston. On this theory, all substances which could be burnt were composed of phlogiston and some other substance, and the operation of burning was simply equivalent to the liberation of the phlogiston. The Stahlian theory, originally a theory of combustion, came to be a general theory of chemical reactions, since it provided simple explanations of the ordinary chemical processes (when regarded qualitatively) and permitted generalizations which largely stimulated its acceptance. Its inherent defect—that the products of combustion were invariably heavier than the original substance instead of less as the theory demanded—was ignored, and until late in the 18th century it dominated chemical thought. Its overthrow was effected by Lavoisier, who showed that combustion was simply an oxidation, the oxygen of the atmosphere (which was isolated at about this time by K. W. Scheele and J. Priestley) combining with the substance burnt.

COMEDY, the general term applied to a type of drama the chief object of which, according to modern notions, is to amuse. It is contrasted on the one hand with tragedy and on the other with farce, burlesque, &c. As compared with tragedy it is distinguished by having a happy ending (this being considered for a long time the essential difference), by quaint situations, and by lightness of dialogue and character-drawing. As compared with farce it abstains from crude and boisterous jesting, and is marked by some subtlety of dialogue and plot. It is, however, difficult to draw a hard and fast line of demarcation, there being a distinct tendency to combine the characteristics of farce with those of true comedy. This is perhaps more especially the case in the so-called "musical comedy," which became popular in Great Britain and America in the later 19th century, where true comedy is frequently subservient to broad farce and spectacular effects.

The word "comedy" is derived from the Gr. κωμῳδία, which is a compound either of κῶμος (revel) and αἰδῶς (singer; αἰδεῖν, φθεῖν, to sing), or of κῶμη (village) and αἰδῶς. It is possible that κῶμος itself is derived from κῶμη, and originally meant a village revel. The word comes into modern usage through the Lat. *comœdia* and Ital. *commedia*. It has passed through various shades of meaning. In the middle ages it meant simply a story with a happy ending. Thus some of Chaucer's Tales are called comedies, and in this sense Dante used the term in the title of his poem, *La Commedia* (cf. his *Epistola X.*, in which he speaks of the comic style as "loquutio vulgaris, in qua et mulierculae communicant"; again "comœdia vero remisse et humiliter"; "differt a tragoedia per hoc, quod t. in principio est admirabilis et quieta, in fine sive exitu est foetida et horribilis"). Subsequently the term is applied to mystery plays with a happy ending. The modern usage combines this sense with that in which Renaissance scholars applied it to the ancient comedies.

The adjective "comic" (Gr. κωμικός), which strictly means that which relates to comedy, is in modern usage generally confined to the sense of "laughter-provoking": it is distinguished from "humorous" or "witty" inasmuch as it is applied to an incident or remark which provokes spontaneous laughter without a special mental effort. The phenomena connected with laughter and that which provokes it, the comic, have been carefully investigated by psychologists, in contrast with other phenomena connected with the emotions. It is very generally agreed that the predominating characteristics are incongruity or contrast in the object, and shock or emotional seizure on the part of the subject. It has also been held that the feeling of superiority is an essential, if not the essential, factor thus Hobbes speaks of laughter as a "sudden glory." Physiological explanations have been given by Kant, Spencer and Darwin. Modern investigators have paid much attention to the origin both of laughter and of smiling, babies being watched from infancy and the date of their first smile being carefully recorded. For an admirable analysis and account of the theories see James Sully, *On Laughter* (1902), who deals generally with the development of the "play instinct" and its emotional expression.

See **DRAMA**; also **HUMOUR**; **CARICATURE**; **PLAY**, &c.

COMENIUS (or **KOMENSKY**), **JOHANN AMOS** (1592-1671), a famous writer on education, and the last bishop of the old church of the Moravian and Bohemian Brethren, was born at Comna, or, according to another account, at Niwnitz, in Moravia, of poor parents belonging to the sect of the Moravian Brethren. Having studied at Herborn and Heidelberg, and travelled in Holland and England, he became rector of a school at Prerau, and after that pastor and rector of a school at Fulnek. In 1621 the Spanish invasion and persecution of the Protestants robbed him of all he possessed, and drove him into Poland. Soon after he was made bishop of the church of the Brethren. He supported himself by teaching Latin at Lissa, and it was here that he published his *Pansophiae prodromus* (1630), a work on education, and his *Janua linguarum reserata* (1631), the latter of which gained for him a widespread reputation, being produced in twelve European languages, and also in Arabic, Persian and Turkish. He subsequently published several other works of a similar kind, as the *Eruditionis scholasticae janua* and the *Janua linguarum trilinguis*. His method of teaching languages, which he seems to have been the first to adopt, consisted in giving, in parallel columns, sentences conveying useful information, in the vernacular and the languages intended to be taught (*i.e.* in Comenius's works, Latin and sometimes Greek). In some of his books, as the *Orbis sensualium pictus* (1658), pictures are added; this work is, indeed, the first children's picture-book. In 1638 Comenius was requested by the government of Sweden to draw up a scheme for the management of the schools of that country; and a few years after he was invited to join the commission that the English parliament then intended to appoint, in order to reform the system of education. He visited England in 1641, but the disturbed state of politics prevented the appointment of the commission, and Comenius passed over to Sweden in August 1642. The great Swedish minister, Oxenstjerna, obtained for him a pension, and a commission to furnish a plan for regulating the Swedish schools according to his own method. Devoting himself to the elaboration of his scheme, Comenius settled first at Elbing, and then at Lissa, but, at the burning of the latter city by the Poles, he lost nearly all his manuscripts, and he finally removed to Amsterdam, where he died in 1671.

As an educationist, Comenius holds a prominent place in history. He was disgusted at the pedantic teaching of his own day, and he insisted that the teaching of words and things must go together. Languages should be taught, like the mother tongue, by conversation on ordinary topics; pictures, object lessons, should be used; teaching should go hand in hand with a happy life. In his course he included singing, economy, politics, world-history, geography, and the arts and handicrafts. He was one of the first to advocate teaching science in schools.

As a theologian, Comenius was greatly influenced by Boehme. In his *Synopsis physicae ad lumen divinum reformatae* he gives a physical theory of his own, said to be taken from the book of Genesis. He was also famous for his prophecies and the support he gave to visionaries. In his *Lux in tenebris* he published the visions of Kotterus, Dabricius and Christina Poniatovia. Attempting to interpret the book of Revelation, he promised the millennium in 1672, and guaranteed miraculous assistance to those who would undertake the destruction of the Pope and the house of Austria, even venturing to prophesy that Cromwell, Gustavus Adolphus, and Rakoczy, prince of Transylvania, would perform the task. He also wrote to Louis XIV., informing him that the empire of the world should be his reward if he would overthrow the enemies of God.

Comenius also wrote against the Socinians, and published three historical works—*Ratio disciplinae ordinisque in unitate fratrum Bohemorum*, which was republished with remarks by Buddacus, *Historia persecutionum ecclesiae Bohemicae* (1648), and *Martyrologium Bohemicum*. See Raumer's *Geschichte der Pädagogik*, and Carpozov's *Religionsuntersuchung der böhmischen und mährischen Brüder*.

COMET (Gr. κομήτης, long-haired), in astronomy, one of a class of seemingly nebulous bodies, moving under the influence of the sun's attraction in very eccentric orbits. A comet is visible only in a small arc of its orbit near perihelion, differing but slightly

from the arc of a parabola. An obvious but not sharp classification of comets is into bright comets visible to the naked eye, and telescopic comets which can be seen only with a telescope. The telescopic class is much the more numerous of the two, only from 20 to 30 bright comets usually appearing in any one century, while several telescopic comets, frequently 6 or 8, are generally observed in the course of a year.

A bright comet consists of (1) a star-like nucleus; (2) a nebulous haze, called the *coma*, surrounding this nucleus, the latter fading into the haze by insensible gradations; (3) a tail or luminous stream flowing from the coma in a direction opposite to that of the sun. The nuclei and comae of different comets exhibit few peculiarities to the unaided vision except in respect to brightness; but the tails of comets differ widely, both in brightness and in extent. They range from a barely visible brush or feather of light to a phenomenon extending over a considerable arc of the heavens, which, comparatively bright near the head of the comet, becomes gradually fainter and more diffuse towards its end, fading out by gradations so insensible that a precise length cannot be assigned to it. When a telescopic comet is first discovered the nucleus is frequently invisible, the object presenting the appearance of a faint nebulous haze, scarcely distinguishable in aspect from a nebula. When the nucleus appears it may at first be only a comparatively faint condensation, and may or may not develop into a point of light as the comet approaches the sun. A tail also is generally not seen at great distances from the sun, but gradually develops as the comet approaches perihelion, to fade away again as the comet recedes from the sun.

A few comets are known to revolve in orbits with a regular period, while, in the case of others, no evidence is afforded by observation that the orbit deviates from a parabola. Were the orbit a parabola or hyperbola the comet would never return (see ORBIT). Periodicity may be recognized in two ways: observations during the apparition may show that the motion is in an elliptic and not in a parabolic orbit; or a comet may have been observed at more than one return. In the latter case the comet is recognized as distinctly periodic, and therefore a member of the solar system. The shortest periods range between 3 and 10 years. The majority of comets which have been observed are shown by observation to be periodic; the period is usually very long, being sometimes measured by centuries, but generally by thousands of years. It is conceivable that a comet might revolve in a hyperbolic orbit. Although there are several of these bodies observations on which indicate such an orbit, the deviation from the parabolic form has not in any case been so well marked as to be fully established. Circumstances lead to the classification of newly appearing comets as *expected* and *unexpected*. An expected comet is a periodic one of which the return is looked for at a determinate time and in a certain region of the heavens. When this is not the case the comet is an unexpected one.

Physical Constitution of Comets.—The subject of the physical constitution of these bodies is one as to the details of which much uncertainty still exists. The considerations on which conclusions in this field rest are very various, and can best be set forth by beginning with what we may consider to be the best established facts.

We must regard it as well established that comets are not, like planets and satellites, permanent in mass, but are continuously losing minute portions of the matter which belongs to them, through a progressive dissipation—at least when they are in the neighbourhood of the sun. When near perihelion the matter of a comet is seen to be undergoing a process in the nature of evaporation, successive envelopes of vapour rising from the nucleus to form the coma, and then gradually repelled from the sun to form the tail. If this process went on indefinitely every comet would, in the course of ages, be entirely dissipated. This result has actually happened in the case of some known comets, the best established example of which is that of Biela, in which the process of disintegration was clearly followed. As the amount of matter lost by a comet at any one return cannot

be estimated, and may be very small, it is impossible to set any limit to the period during which its life may continue. It is still an unsettled question whether, in every case, the evaporation will ultimately cease, leaving a residuum as permanent as any other mass of matter.

The next question in logical order is one of great difficulty. It is whether the nucleus of a comet is an opaque solid body, a cluster of such bodies, or a mass of particles of extreme tenuity. Some light is thrown on this and other questions by the spectroscope. This instrument shows in the spectrum of nearly every comet three bright bands, recognized as those of hydrocarbons. The obvious conclusion is that the light forming these bands is not reflected sunlight, but light radiated by the gaseous hydrocarbons. Since a gas at so great a distance from the sun cannot be heated to incandescence, the question arises how incandescence is excited. The generalizations of recent years growing out of the phenomena of radioactivity make it highly probable that the source is to be found in some form of electrical excitation, produced by electrons or other corpuscles thrown out by the sun. The resemblance of the cometary spectrum to the spectrum of hydrocarbons in the Geissler tube lends great plausibility to this view. It is remarkable that the great comet of 1882 also showed the bright lines of sodium with such intensity that they were observed in daylight by R. Copeland and W. O. Lohse. In addition to these gaseous spectra, all but the fainter comets show a continuous spectrum, crossed by the Fraunhofer lines, which is doubtless due to reflected sunlight. It happens that, since the spectroscope has been perfected, no comet of great brilliancy has been favourably situated for observation. Until the opportunity is offered, the conclusions to be derived from spectroscopic observation cannot be further extended.

In the telescope the nucleus of a bright comet appears as an opaque mass, one or more seconds in diameter, the absolute dimensions comparing with those of the satellites of the planets, sometimes, indeed, equal to our moon. But the actual results of micrometric measures are found to differ very widely. In the case of Donati's comet of 1858 the nucleus seemed to grow smaller as perihelion was approached. This is evidently due to the fact that the coma immediately around the nucleus was so bright as apparently to form a part of it at considerable distances from the sun. G. P. Bond estimated the diameter of the actual nucleus at 500 m. That the nucleus is a body of appreciable mass seems to be made probable by the fact that, except for the central attraction of such a body, a comet would speedily be dissipated by the different attractions of the sun on different parts of the mass, which would result in each particle pursuing an orbit of its own. It follows that there must be a mass sufficient to hold the parts of the comet, if not absolutely together, at least in each other's immediate neighbourhood. How great a central mass may be required for this is a subject not yet investigated. It might be supposed that the amount of matter must be sufficient to make the nucleus quite opaque. But two considerations based on observations militate against this view. One is that an opaque body, reflecting much sunlight, would show a brighter continuous spectrum than has yet been found in any comet. Another and yet more remarkable observation is on record which goes far to prove not only the tenuity, but the transparency of a cometary nucleus. The great comet of 1882 made a transit over the sun on the 17th of September, an occurrence unique in the history of astronomy. But the fact of the transit escaped attention except at the observatory of the Cape of Good Hope. Here the comet was watched by W. H. Finlay and by W. L. Elkin as it approached the sun, and was kept in sight until it came almost or quite in contact with the sun's disk, when it disappeared. It should, if opaque, have appeared a few minutes later, projected on the sun's disk; but not a trace of it could be seen. The sun was approaching Table Mountain at the critical moment, and its limb was undulating badly, making the detection of a minute point difficult. The possibility of a very small opaque nucleus is therefore still left open; yet the remarkable conclusion still holds, that, immediately around a possible central nucleus, the matter of the head of the comet was so rare as not to intercept

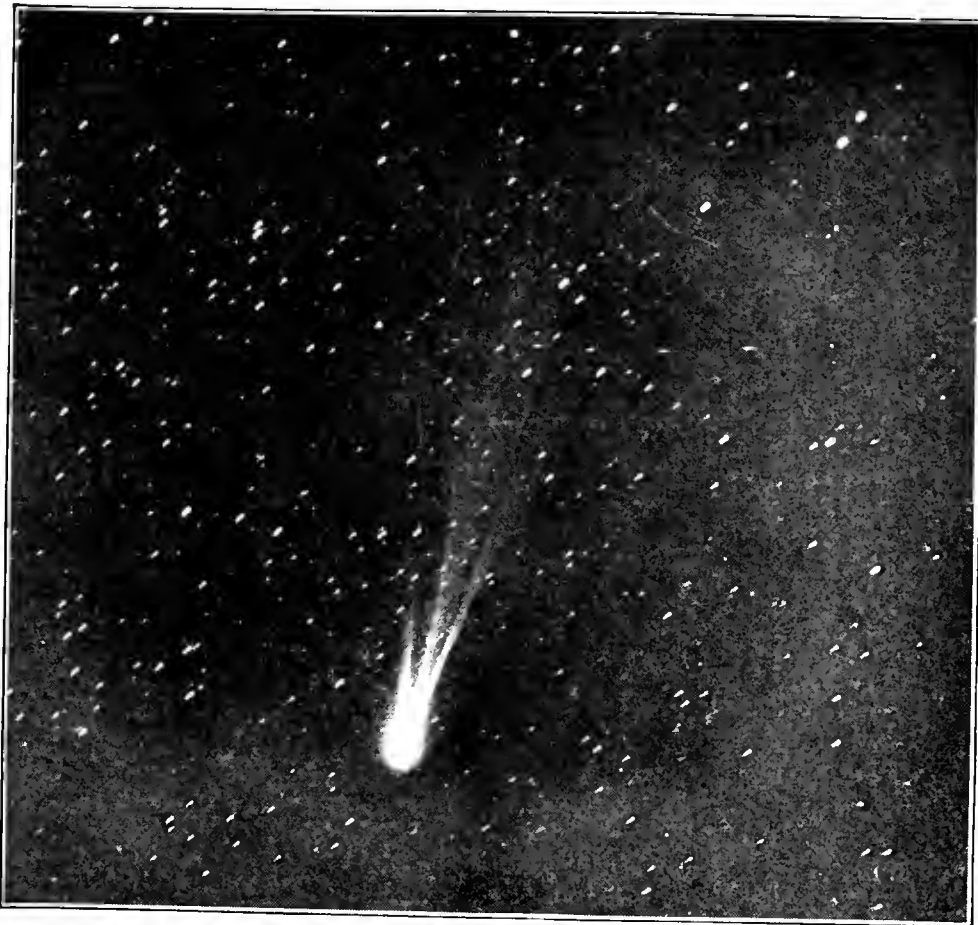

Fig. 1.—Comet 1892, I. (Swift), 1892, April 26.

By permission of Lick Observatory (E. E. Barnard).

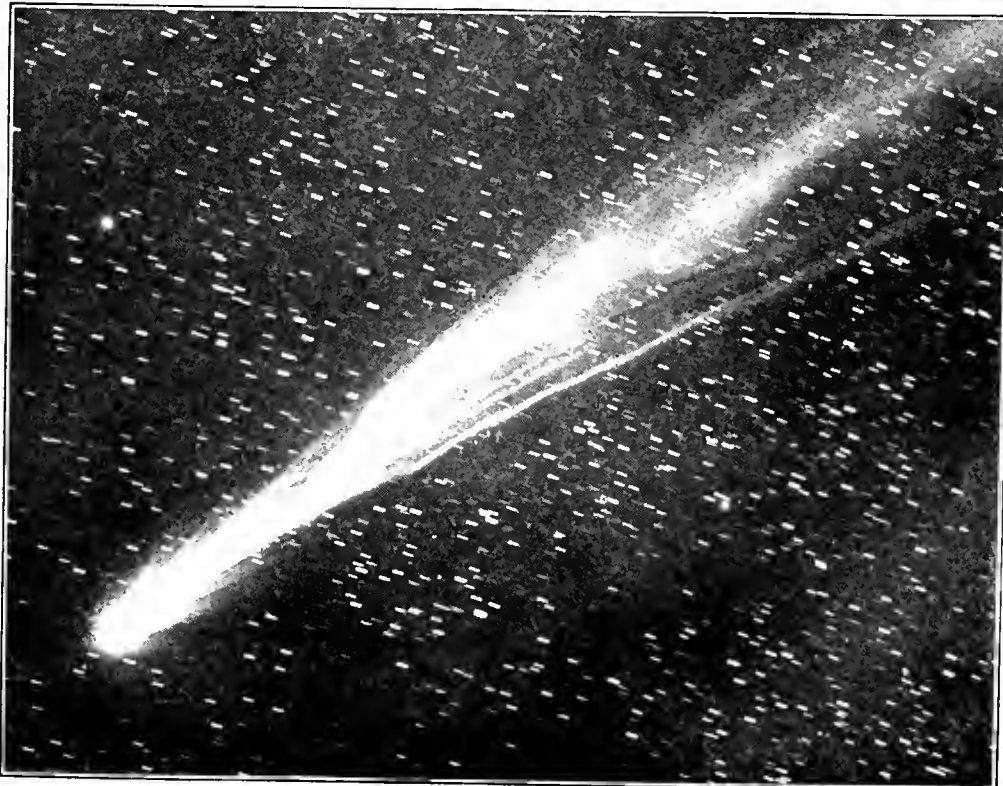

Fig. 2.—Comet C, 1908, Nov. 16d. 13h. 10m.

By permission of Yerkes Observatory (E. E. Barnard.)

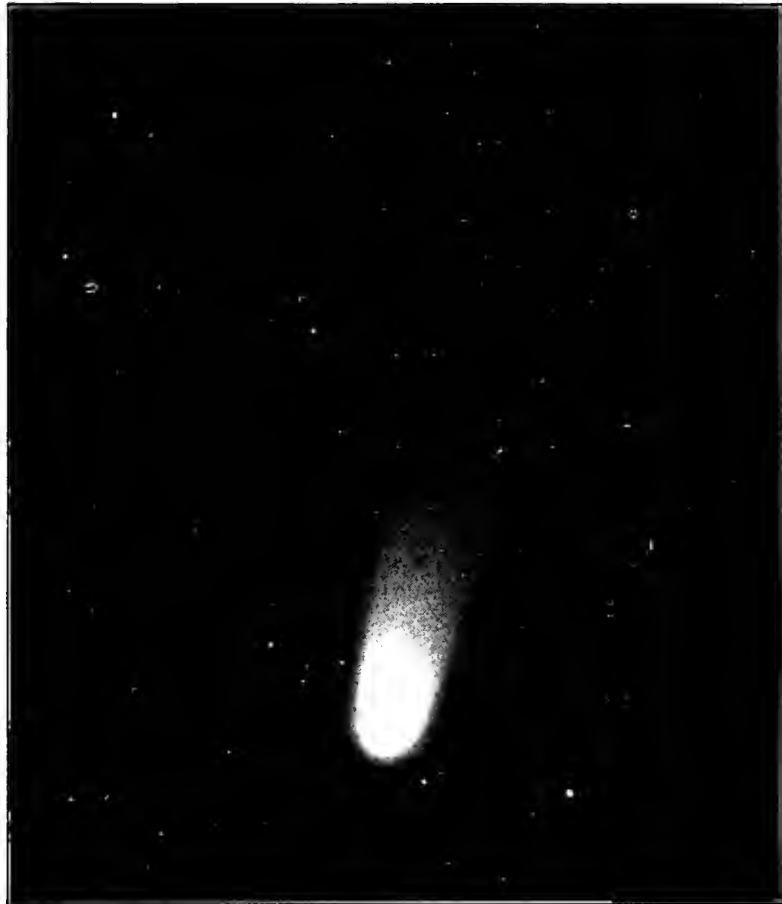

Fig. 3.—Halley's Comet, 1910, April 27.

By permission of Helwân Observatory, Egypt.



Fig. 4.—Halley's Comet, 1910, May 4.

By permission of Yerkes Observatory (E. E. Barnard).

any appreciable fraction of the sun's light. This result seems also to show that, with the possible exception of a very small central mass, what seems to telescopic vision as a nucleus is really only the central portion of the coma, which, as the distance from the centre increases, becomes less and less dense by imperceptible gradations.

Another fact tending towards this same conclusion is that after this comet passed perihelion it showed several nuclei following each other. Evidently the powerful attraction of the sun had separated the parts of the apparent nucleus, which were following each other in nearly the same orbit. As they could not have been completely brought together again, we may suppose that in such cases the smaller nuclei were permanently separated from the main body. In addition to this, the remarkable similarity of the orbit of this comet to that of several others indicates a group of bodies moving in nearly the same orbit. The other members of the group were the great comets of 1843, 1880 and 1887. The latter, though so bright as to be conspicuous to the naked eye, showed no nucleus whatever. The closely related orbits of the four bodies are also remarkable for approaching nearer the sun at perihelion than does the orbit of any other known body. All of these comets pass through the matter of the sun's corona with a velocity of more than 100 m per second without suffering any retardation. As it is beyond all reasonable probability that several independent bodies should have moved in orbits so nearly the same, the conclusion is that the comets were originally portions of one mass, which gradually separated in the course of ages by the powerful attraction of the sun as the collection successively passed the perihelion. It may be remarked that observations on the comet of 1843 seemed to show a slight ellipticity of the orbit, corresponding to a period of several centuries; but the deviation of all the orbits from a parabola is too slight to be established by observations. The periods of the comets are therefore unknown except that they must be counted by centuries and possibly by thousands of years.

Another fact which increases the complexity of the question is the well-established connexion of comets with meteoric showers. The shower of November 13-15, now known as the Leonids, which recurred for several centuries at intervals of about one-third of a century, are undoubtedly due to a stream of particles left behind by a comet observed in 1866. The same is true of Biela's comet, the disintegrated particles of which give rise to the Andromedids, and probably true also of the Perseids, or August meteors, the orbits of which have a great similarity to a comet seen in 1862. The general and well-established conclusion seems to be that, in addition to the visible features of a comet, every such body is followed in its orbit by a swarm of meteoric particles which must have been gradually detached and separated from it. (See METEOR.)

The source of the repulsive force by which the matter forming the tail of a comet is driven away from the sun is another question that has not yet been decisively answered. Two causes have been suggested, of which one has only recently been brought to light. This is the repulsion of the sun's rays, a form of action the probability of which was shown by J. Clerk Maxwell in 1870, and which was experimentally established about thirty years later. The intensity of this action on a particle is proportional to the surface presented by the particle to the rays, and therefore to the square of its diameter, while its mass, and therefore its gravitation to the sun, are proportional to the cube of the diameter. It follows that if the size and mass of a particle in space are below a certain limit, the repulsion of the rays will exceed the attraction of the sun, and the particle will be driven off into space. But, in order that this repulsive force may act, the particles, however minute they may be, must be opaque. Moreover, theory shows that there is a lower as well as an upper limit to their magnitude, and that it is only between certain definable limits of magnitude that the force acts. Conceiving the particle to be of the density of water, and considering its diameter as a diminishing variable, theory shows that the repulsion will balance gravity when the diameter has reached 0.0015 of a millimetre. As the diameter is reduced below this limit

the ratio of the repulsive to the attractive force increases, but soon reaches a maximum, after which it diminishes down to a diameter of 0.00007 mm., when the two actions are again balanced. Below this limit the light speedily ceases to act. It follows that a purely gaseous body, such as would emit a characteristic bright line spectrum, would not be subject to the repulsion. We must therefore conclude that both the solid and gaseous forms of matter are here at play, and this view is consonant with the fact that the comet leaves behind it particles of meteoric matter.

Another possible cause is electrical repulsion. The probability of this cause is suggested by recent discoveries in radioactivity and by the fact that the sun undoubtedly sends forth electrical emanations which may ionize the gaseous molecules rising from the nucleus, and lead to their repulsion from the sun, thus resulting in the phenomena of the tail. But well-established laws are not yet sufficiently developed to lead to definite conclusions on this point, and the question whether both causes are combined, and, if not, to which one the phenomena in question are mainly due, must be left to the future.

A curious circumstance, which may be explained by a duplex character of the matter forming a cometary tail, is the great difference between the visual and photographic aspect of these bodies. The soft, delicate, feathery-like form which the comet with its tail presents to the eye is wanting in a photograph, which shows principally a round head with an irregularly formed tail much like the knotted stalk of a plant. It follows that the light emitted by the central axis of the tail greatly exceeds in actinic power the diffuse light around it. A careful comparison of the form and intensity of the photographic and visual tails may throw much light on the question of the constitution of these bodies, but no good opportunity of making the comparison has been afforded since the art of celestial photography has been brought to its present state of perfection.

The main conclusion to which the preceding facts and considerations point is that the matter of a comet is partly solid and partly gaseous. The gaseous form is shown conclusively by the spectroscope, but in view of the extreme delicacy of the indications with this instrument no quantitative estimate of the gas can be made. As there is no central mass sufficient to hold together a continuous atmosphere of elastic gas of any sort, it seems probable that the gaseous molecules are only those rising from the coma, possibly by ordinary evaporation, but more probably by the action of the ultra-violet and other rays of the sun giving rise to an ionization of disconnected gaseous molecules. The matter cannot be wholly gaseous because in this case there could be no central force sufficient to keep the parts of the comet together.

The facts also point to the conclusion that the solid matter of a comet is formed of a swarm or cloud of small disconnected masses, probably having much resemblance to the meteoric masses which are known to be flying through the solar system and possibly of the same general kind as these. The question whether there is any central solid of considerable mass is still undecided; it can only be said that if so, it is probably small relative to cosmic masses in general—more likely less than greater than 100 m. in diameter. The light of the comet therefore proceeds from two sources: one the incandescence of gases, the other the sunlight reflected from the solid parts. No estimate can be formed of the ratio between these two kinds of light until a bright comet shall be spectroscopically observed during an entire apparition.

Origin and Orbits of Comets.—The great difference which we have pointed out between comets and the permanent bodies of the solar system naturally suggested the idea that these bodies do not belong to that system at all, but are nebulous masses, scattered through the stellar spaces, and brought one by one into the sphere of the sun's attraction. The results of this view are easily shown to be incompatible with the observed facts. The sun, carrying the whole solar system with it, is moving through space with a speed of about 10 m. per second. If it approached a comet nearly at rest the result would be a relative motion of this amount which, as the comet came nearer,

would be constantly increased, and would result in the comet describing relative to the sun a markedly hyperbolic orbit, deviating too widely from a parabola to leave any doubt, even in the most extreme cases. Moreover, a large majority of comets would then have their aphelia in the direction of the sun's motion, and therefore their perihelia in the opposite direction. Neither of these results corresponds to the fact. The conclusion is that if we regard a comet as a body not belonging to the solar system, it is at least a body which before its approach to the sun had the same motion through the stellar spaces that the sun has. As this unity of motion must have been maintained from the beginning, we may regard comets as belonging to the solar system in the sense of not being visitors from distant regions of space.

The acceptance of this seemingly inevitable conclusion leads to another: that no comet yet known moves in a really hyperbolic orbit, but that the limit of eccentricity must be regarded as 1, or that of the parabola. It is true that seeming evidence of hyperbolic eccentricity is sometimes afforded by observations and regarded by some astronomers as sufficient. The objections to the reality of the hyperbolic orbit are two. (1) A comet moving in a decidedly hyperbolic orbit must have come from so great a distance within a finite time, say a few millions of years, as to have no relation to the sun, and must after its approach to the sun return into space, never again to visit our system. In this case the motion of the sun through space renders it almost infinitely improbable that the orbit would have been so nearly a parabola as all such orbits are actually found to be. (2) The apparent deviation from a very elongated ellipse has never been in any case greater than might have been the result of errors of observation on bodies of this class.

This being granted, a luminous view of the causes which lead to the observed orbits of comets is readily gained by imagining these bodies to be formed of nebulous masses, which originally accompanied the sun in its journey through space, but at distances, in most cases, vastly greater than that of the farthest planet. Such a mass, when drawn towards the sun, would move round it in a nearly parabolic orbit, similar to the actual orbits of the great majority of comets. The period might be measured by thousands, tens of thousands, or hundreds of thousands of years, according to the distances of the comet in the beginning; but instead of bodies extraneous to the system, we should have bodies properly belonging to the system and making revolutions around the sun.

Were it not for the effect of planetary attraction long periods like these would be the general rule, though not necessarily universal. But at every return to perihelion the motion of a comet will be to some extent either accelerated or retarded by the action of Jupiter or any other planet in the neighbourhood of which it may pass. Commonly the action will be so slight as to have little influence on the orbit and the time of revolution. But should the comet chance to pass the orbit of Jupiter just in front of the planet, its motion would be retarded and the orbit would be changed into one of shorter period. Should it pass behind the planet, its motion would be accelerated and its period lengthened. In such cases the orbit might be changed to a hyperbola, and then the comet would never return. It follows that there is a tendency towards a gradual but constant diminution in the total number of comets. If we call Δe the amount by which the eccentricity of a cometary orbit is less than unity, Δe will be an extremely minute fraction in the case of the original orbits. If we call $\pm \delta$ the change which the eccentricity $1 - \Delta e$ undergoes by the action of the planets during the passage of the comet through our system, it will leave the system with the eccentricity $1 - \Delta e \pm \delta$. The possibilities are even whether δ shall be positive or negative. If negative, the eccentricity will be diminished and the period shortened. If positive, and greater than Δe , the eccentricity $1 - \Delta e + \delta$ will be greater than 1, and then the comet will be thrown into a hyperbolic orbit and become for ever a wanderer through the stellar spaces.

The nearer a comet passes to a planet, especially to Jupiter,

the greater planet, the greater δ may be. If δ is a considerable negative fraction, the eccentricity will be so reduced that the comet will after the approach be one of short period. It follows that, however long the period of a comet may be, there is a possibility of its becoming one of short period if it approaches Jupiter. There have been several cases of this during the past two centuries, the most recent being that of Brooks's comet, 1889, V. Soon after its discovery this body was found to have a period of only about seven years. The question why it had not been observed at previous returns was settled after the orbit had been determined by computing its motion in the past. It was thus found that in October 1886 the comet had passed in the immediate neighbourhood of Jupiter, the action of which had been such as to change its orbit from one of long period to the short observed period. A similar case was that of Lexel's comet, seen in 1770. Originally moving in an unknown orbit, it encountered the planet Jupiter, made two revolutions round the sun, in the second of which it was observed, then again encountered the planet, to be thrown out of its orbit into one which did not admit of determination. The comet was never again found.

A general conclusion which seems to follow from these conditions, and is justified by observations, so far as the latter go, is that comets are not to be regarded as permanent bodies like the planets, but that the conglomerations of matter which compose them are undergoing a process of gradual dissipation in space. This process is especially rapid in the case of the fainter periodic comets. It was first strikingly brought out in the case of Biela's comet. This object was discovered in 1772, was observed to be periodic after several revolutions had been made, and was observed with a fair degree of regularity at different returns until 1852. At the previous apparition it was found to have separated into two masses, and in 1852 these masses were so widely separated that they might be considered as forming two comets. Notwithstanding careful search at times and places when the comet was due, no trace of it has since been seen. An examination of the table of periodic comets given at the end of this article will show that the same thing is probably true of several other comets, especially Brorsen's and Tempel's, which have each made several revolutions since last observed, and have been sought for in vain.

In view of the seemingly inevitable dissipation of comets in the course of ages, and of the actually observed changes of their orbits by the attraction of Jupiter, the question arises whether the orbits of all comets of short period may not have been determined by the attraction of the planets, especially of Jupiter. In this case the orbit would, for a period of several centuries, have continued to nearly intersect that of the planet. We find, as a matter of fact, that several periodic comets either pass near Jupiter or have their aphelia in the neighbourhood of the orbit of Jupiter. The approach, however, is not sufficiently close to have led to the change unless in former times the proximity of the orbits was much greater than it is now. As the orbits of all the bodies of the solar system are subject to a slow secular change of their form and position, this may only show that it must have been thousands of years since the comet became one of short period. The two cases of most difficulty are those of Halley's and Encke's comets. The orbit of the former is so elongated and so inclined to the general plane of the planetary orbits that its secular variation must be very slow indeed. But it does not pass near the orbit of any planet except Venus; and even here the proximity is far from being sufficient to have produced an appreciable change in the period. The orbit of Encke's comet is entirely within the orbit of Jupiter, and it also cannot have passed near enough to a planet for thousands of years to have had its orbit changed by the action in question. It therefore seems difficult to regard these two comets as other than permanent members of the solar system.

Special Periodic Comets.—One of the most remarkable periodic comets with which we are acquainted is that known to astronomers as Halley's. Having perceived that the elements of the comet of 1682 were nearly the same as those of two comets which had respectively appeared in 1531 and 1607, Edmund

Halley concluded that all the three orbits belonged to the same comet, of which the periodic time was about 76 years. After a rough estimate of the perturbations it must sustain from the attraction of the planets, he predicted its return for 1757,—a bold prediction at that time, but justified by the event, for the comet again made its appearance as was expected, though it did not pass through its perihelion till the month of March 1759, the attraction of Jupiter and Saturn having caused, as was computed by Clairault previously to its return, a retardation of 618 days. This comet had been observed in 1066, and the accounts which have been preserved represent it as having then appeared to be four times the size of Venus, and to have shone with a light equal to a fourth of that of the moon. History is silent respecting it from that time till the year 1456, when it passed very near to the earth: its tail then extended over 60° of the heavens, and had the form of a sabre. It returned to its perihelion in 1835, and was well observed in almost every observatory. But its brightness was far from comparing with the glorious accounts of its former apparitions. That this should have been due to the process of dissipation does not seem possible in so short a period; we must therefore consider either that the earlier accounts are greatly exaggerated, or that the brightness of the comet is subject to changes from some unknown cause. Previous appearances of Halley's comet have been calculated by J. R. Hind, and more recently by P. H. Cowell and A. C. D. Crommelin of Greenwich, the latter having carried the comet back to 87 B.C. with certainty, and to 240 B.C. with fair probability. It was detected by Max Wolf at Heidelberg on plates exposed on Sept. 11, 1909, and subsequently on a Greenwich plate of Sept. 9.

The known comet of shortest period bears the name of J. F. Encke, the astronomer who first investigated its orbit and showed its periodicity. It was originally discovered in 1789, but its periodicity was not recognized until 1818, after it had been observed at several returns. This comet has given rise to a longer series of investigations than any other, owing to Encke's result that the orbit was becoming smaller, and the revolutions therefore accelerated, by some unknown cause, of which the most plausible was a resisting medium surrounding the sun. As this comet is almost the only one that passes within the orbit of Mercury, it is quite possible that it alone would show the effect of such a medium. Recent investigations of this subject have been made at the Pulkova Observatory, first by F. E. von Asten and later by J. O. Backlund who, in 1909, was awarded the Gold Medal of the Royal Astronomical Society for his researches in this field. During some revolutions there was evidence of a slight acceleration of the return, and during others there was not.

The following is a list (compiled in 1909) of comets which are well established as periodic, through having been observed at

when the resemblance of the two orbits led to the conclusion of the identity of the bodies, the period of which was soon made evident by continued observations. The comets of Pons and Olbers are remarkable for having an almost equal period. But their orbits are otherwise totally different, so that there does not seem to be any connexion between them. Brorsen's comet seems also to be completely dissipated, not having been seen since 1879.

There are also a number of cases in which a comet has been observed through one apparition, and found to be apparently periodic, but which was not seen to return at the end of its supposed period. In some of these cases it seems likely that the comet passed near the planet Jupiter and thus had its orbit entirely changed. It is possible that in other cases the apparent periodicity is due to the unavoidable errors of observation to which, owing to their diffused outline, the nuclei of comets are liable. (S. N.)

COMET-SEEKER, a small telescope (*q.v.*) adapted especially to searching for comets: commonly of short focal length and large aperture, in order to secure the greatest brilliancy of light.

COMILLA, or **KUMILLA**, a town of British India, headquarters of Tippera district in Eastern Bengal and Assam, situated on the river Gumti, with a station on the Assam-Bengal railway, 96 m. from the coast terminus at Chittagong. Pop. (1901) 19,169. The town has many large tanks and an English church, built in 1875.

COMINES, or **COMMINES** (Flem. *Komen*), a town of western Flanders, 13 m. N.N.W. of Lille by rail. It is divided by the river Lys, leaving one part on French (department of Nord), the other on Belgian territory (province of West Flanders). Pop. of the French town 6359 (1906); of the Belgian town, 6453 (1904). The former has a belfry of the 14th century, restored in the 17th and 19th centuries, and remains of a château. Comines carries on the spinning of flax, wool and cotton.

COMITIA, the name applied, always in technical and generally in popular phraseology, to the most formal types of gathering of the sovereign people in ancient Rome. It is the plural of *comitium*, the old "meeting-place" (Lat. *cum*, together, *ire*, to go) on the north-west of the Forum. The Romans had three words for describing gatherings of the people. These were *concilium*, *comitia* and *contio*. Of these *concilium* had the most general significance. It could be applied to any kind of meeting and is often used to describe assemblies in foreign states. It was, therefore, a word that might be employed to denote an organized gathering of a portion of the Roman people such as the plebs, and in this sense is contrasted with *comitia*, which when used strictly should signify an assembly of the whole people. Thus the Roman draughtsman who wishes to express the idea "magistrates of any kind as president of assemblies" writes

"Magistratus queiquomque comitia conciliumve habebit" (*Lex Latina tabulae Bantinae*, l. 5), and formalism required that a magistrate who summoned only a portion of the people to meet him should, in his summons, use the word *concilium*. This view is expressed by Laelius Felix, a lawyer probably of the age of Hadrian, when he writes "Is qui non universum populum, sed partem aliquam adesse jubet, non comitia, sed concilium edicere debet" (*Gellius, Noctes Atticae*, xv. 27). But popular phraseology did not conform to this canon, and *comitia*, which gained in current Latin the sense of "elections" was sometimes used of the assemblies of the plebs (see the instances in Botsford, distinction between *Comitia* and *Concilium*, p. 23). The distinction between *comitia* and *contio* was more clearly marked. Both were

List of Periodic Comets observed at more than one Return.

Designation.	1st Perih. Passage.	Last Perih. Passage obs.	Period Years.	Least Dist. Ast. Units.	Gr. Dist. Ast. Units.
Halley . . .	1456 June 8.2	1835 Nov. 15.9	75.9	0.58	35.42
Biela . . .	1772 Feb. 16.7	1852 Sept. 23.4	6.67	0.98	6.18
Encke . . .	1786 Jan. 30.9	1905 Jan. 11.4	3.29	0.34	4.08
Tuttle . . .	1790 Jan. 30.9	1899 May 4.5	13.78	1.03	10.53
Pons . . .	1812 Sept. 15.3	1884 Jan. 25.7	72.28	0.78	33.70
Olbers . . .	1815 April 26.0	1887 Oct. 8.5	73.32	1.21	33.99
Winnecke . . .	1819 July 18.9	1898 Mar. 20.4	5.67	0.77	5.55
Faye . . .	1843 Oct. 17.1	1896 Mar. 19.3	7.50	1.69	5.93
De Vico . . .	1844 Sept. 2.5	1894 Oct. 12.2	5.66	1.19	5.01
Brorsen . . .	1846 Feb. 11.1	1879 Mar. 30.5	5.52	0.65	5.63
D'Arrest . . .	1851 July 8.7	1897 May 21.7	6.56	1.17	5.71
Tempel I. . .	1867 May 23.9	1879 May 7.0	5.84	1.56	4.82
Tempel-Swift . . .	1869 Nov. 18.8	1891 Nov. 15.0	5.51	1.06	5.16
Tempel II. . .	1873 June 25.2	1904 Nov. 10.5	5.28	1.34	4.66
Wolf . . .	1884 Nov. 17.8	1898 July 4.6	6.80	1.59	5.57
Finlay . . .	1886 Nov. 22.4	1893 July 12.2	6.64	0.99	6.17
Brooks . . .	1889 Sept. 30.3	1903 Dec. 6.5	7.10	1.95	5.44
Holmes . . .	1892 June 13.2	1899 April 28.1	6.89	2.14	4.50

one or more returns. In addition to what has already been said of several comets in this list the following remarks may be made. Tuttle's comet was first seen by P. F. A. Méchain in 1790, but was not recognized as periodic until found by Tuttle in 1858,

formal assemblies convened by a magistrate; but while, in the case of the *comitia*, the magistrate's purpose was to ask a question of the people and to elicit their binding response, his object in summoning a *contio* was merely to bring the people together either

for their instruction or for a declaration of his will as expressed in an edict ("contionem habere est verba facere ad populum sine ulla rogatione," Gell. *op. cit.* xiii. 6). The word *comitia* merely means "meetings."

The earliest *comitia* was one organized on the basis of parishes (*curiae*) and known in later times as the *comitia curiata*. The *curia* voted as a single unit and thus furnished the type for that system of group-voting which runs through all the later organization of the popular assemblies. This *comitia* must originally have been composed exclusively of patricians (*q.v.*); but there is reason to believe that, at an early period of the Republic, it had, in imitation of the centuriate organization, come to include plebeians (see *CURIA*). The organization which gave rise to the *comitia centuriata* was the result of the earliest steps in the political emancipation of the plebs. Three stages in this process may be conjectured. In the first place the plebeians gained full rights of ownership and transfer, and could thus become freeholders of the land which they occupied and of the appurtenances of this land (*res mancipi*). This legal capacity rendered them liable to military service as heavy-armed fighting men, and as such they were enrolled in the military units called *centuriae*. When the enrolment was completed the whole host (*exercitus*) was the best organized and most representative gathering that Rome could show. It therefore either usurped, or became gradually invested with voting powers, and gained a range of power which for two centuries (508-287 B.C.) made it the dominant assembly in the state. But its aristocratic organization, based as this was on property qualifications which gave the greatest voting power to the richest men, prevented it from being a fitting channel for the expression of plebeian claims. Hence the plebs adopted a new political organization of their own. The tribunate called into existence a purely plebeian assembly, firstly, for the election of plebeian magistrates; secondly, for jurisdiction in cases where these magistrates had been injured; thirdly, for presenting petitions on behalf of the plebs through the consuls to the *comitia centuriata*. This right of petitioning developed into a power of legislation. The stages of the process (marked by the Valerio-Horatian laws of 449 B.C., the Publilian law of 339 B.C., and the Hortensian law of 287 B.C.) are unknown; but it is probable that the two first of the laws progressively weakened the discretionary power of senate and consuls in admitting such petitions; and that the Hortensian law fully recognized the right of resolutions of the plebs (*plebiscita*) to bind the whole community. The plebeian assembly, which had perhaps originally met by *curiae*, was organized on the basis of the territorial tribes in 471 B.C. This change suggested a renewed organization of the whole people for comitial purposes. The *comitia tributa populi* was the result. This assembly seems to have been already in existence at the epoch of the Twelve Tables in 451 B.C., its electoral activity is perhaps attested in 447 B.C., and it appears as a legislative body in 357 B.C.

In spite of the formal differences of these four assemblies and the real distinction springing from the fact that patricians were not members of the plebeian bodies, the view which is appropriate to the developed Roman constitution is that the people expressed its will equally through all, although the mode of expression varied with the channel. This will was in theory unlimited. It was restricted only by the conservatism of the Roman, by the condition that the initiative must always be taken by a magistrate, by the *de facto* authority of the senate, and by the magisterial veto which the senate often had at its command (see *SENATE*). There were no limitations on the legislative powers of the *comitia* except such as they chose to respect or which they themselves created and might repeal. They never during the Republican period lost the right of criminal jurisdiction, in spite of the fact that so many spheres of this jurisdiction had been assigned in perpetuity to standing commissions (*quaestiones perpetuae*). This power of judging exercised by the assemblies had in the main developed from the use of the right of appeal (*provocatio*) against the judgments of the magistrates. But it is probable that, in the developed procedure, where it was known that the judgment pronounced might legally give rise to the appeal, the magistrate pronounced

no sentence, but brought the case at once before the people. The case was then heard in four separate *contiones*. After these hearings the *comitia* gave its verdict. Finally, the people elected to every magistracy with the exception of the occasional offices of Dictator and Interrex. The distribution of these functions amongst the various *comitia*, and the differences in their organization, were as follows:—

The *comitia curiata* had in the later Republic become a merely formal assembly. Its main function was that of passing the *lex curiata* which was necessary for the ratification both of the *imperium* of the higher magistracies of the people, and of the *potestas* of those of lower rank. This assembly also met, under the name of the *comitia calata* and under the presidency of the pontifex maximus, for certain religious acts. These were the inauguration of the rex sacrorum and the flamens, and that abjuration of hereditary worship (*detestatio sacrorum*) which was made by a man who passed from his clan (*gens*) either by an act of adrogation (see *ROMAN LAW AND ADOPTION*) or by transition from the patrician to the plebeian order. For the purpose of passing the *lex curiata*, and probably for its other purposes as well, this *comitia* was in Cicero's day represented by but thirty lictors (*Cic. de Lege Agraria*, ii. 12, 31).

The *comitia centuriata* could be summoned and presided over only by the magistrates with *imperium*. The consuls were its usual presidents for elections and for legislation, but the praetors summoned it for purposes of jurisdiction. It elected the magistrates with *imperium* and the censors, and alone had the power of declaring war. According to the principle laid down in the Twelve Tables (*Cicero, de Legibus*, iii. 4. 11) capital cases were reserved for this assembly. It was not frequently employed as a legislative body after the two assemblies of the tribes, which were easier to summon and organize, had been recognized as possessing sovereign rights. The internal structure of the *comitia centuriata* underwent a great change during the Republic—a change which has been conjecturally attributed to the censorship of Flaminius in 220 B.C. (*Mommsen, Staatsrecht*, iii. p. 270). In the early scheme, at a time when a pecuniary valuation had replaced land and its appurtenances (*res mancipi*) as the basis of qualification, five divisions (*classes*) were recognized whose property was assessed respectively at 100,000, 75,000, 50,000, 25,000 and 11,000 (or 12,500) asses. The first class contained 80 centuries; the second, third and fourth 20 each; the fifth 30. Added to these were the 18 centuries of knights (see *EQUITES*). The combined vote of the first class and the knights was thus represented by 98 centuries; that of the whole of the other *classes* (including 4 or 5 centuries of professional corporations connected with the army, such as the *fabri* and 1 century of *proletarii*, i.e. of all persons below the minimum census) was represented by 95 or 96 centuries. Thus the upper classes in the community possessed more than half the votes in the assembly. The newer scheme aimed at a greater equality of voting power; but it has been differently interpreted. The interpretation most usually accepted, which was first suggested by Pantagathus, a 17th-century scholar, is based on the view that the five *classes* were distributed over the tribes in such a manner that there were 2 centuries of each class in a single tribe. As the number of the tribes was 35, the total number of centuries would be 350. To these we must add 18 centuries of knights, 4 of *fabri*, &c., and 1 of *proletarii*. Here the first class and the knights command but 88 votes out of a total of 373. Mommsen's interpretation (*Staatsrecht*, iii. p. 275) was different. He allowed the 70 votes for the 70 centuries of the first class, but thought that the 280 centuries of the other classes were so combined as to form only 100 votes. The total votes in the *comitia* would thus be 70+100+5 (*fabri*, &c.)+18 (knights), i.e. 193, as in the earlier arrangement. In 88 B.C. a return was made to the original and more aristocratic system by a law passed by the consuls Sulla and Pompeius. At least this seems to be the meaning of Appian (*Bellum Civile*, i. 59) when he says ἐσηγοῦντο . . . τὰς χειροτονίας μὴ κατὰ φυλὰς ἀλλὰ κατὰ λόχους . . . γίνεσθαι: But this change was not permanent as the more liberal system prevails in the Ciceronian period.

The *comitia tribula* was in the later Republic the usual organ for laws passed by the whole people. Its presidents were the magistrates of the people, usually the consuls and praetors, and, for purposes of jurisdiction, the curule aediles. It elected these aediles and other lower magistrates of the people. Its jurisdiction was limited to monetary penalties.

The *concilium plebis*, although voting, like this last assembly, by tribes could be summoned and presided over only by plebeian magistrates, and never included the patricians. Its utterances (*plebiscita*) had the full force of law; it elected the tribunes of the plebs and the plebeian aediles, and it pronounced judgment on the penalties which they proposed. The right of this assembly to exercise capital jurisdiction was questioned; but it possessed the undisputed right of pronouncing outlawry (*aquae et ignis interdictio*) against any one already in exile (Livy xxv. 4, and xxvi. 3).

When the tenure of the religious colleges—formerly filled up by co-optation—was submitted to popular election, a change effected by a *lex Domitia* of 104 B.C., a new type of *comitia* was devised for this purpose. The electoral body was composed of 17 tribes selected by lot from the whole body of 35.

There was a body of rules governing the *comitia* which were concerned with the time and place of meeting, the forms of promulgation and the methods of voting. Valid meetings might be held on any of the 194 "comitial" days of the year which were not market or festal days (*nundinae, feriae*). The *comitia curiata* and the two assemblies of the tribes met within the walls, the former usually in the Comitium, the latter in the Forum or on the Area Capitolii; but the elections at these assemblies were in the later Republic held in the Campus Martius outside the walls. The *comitia centuriata* was by law compelled to meet outside the city and its gathering place was usually the Campus. Promulgation was required for the space of 3 *nundinae* (i.e. 24 days) before a matter was submitted to the people. The voting was preceded by a *contio* at which a limited debate was permitted by the magistrate. In the assemblies of the *curiae* and the tribes the voting of the groups took place simultaneously, in that of the centuries in a fixed order. In elections as well as in legislative acts an absolute majority was required, and hence the candidate who gained a mere relative majority was not returned.

The *comitia* survived the Republic. The last known act of comitial legislation belongs to the reign of Nerva (A.D. 96–98). After the essential elements in the election of magistrates had passed to the senate in A.D. 14, the formal announcement of the successful candidates (*renuntiatio*) still continued to be made to the popular assemblies. Early in the 3rd century Dio Cassius still saw the *comitia centuriata* meeting with all its old solemnities (Dio Cassius lviii. 20).

BIBLIOGRAPHY.—Mommsen, *Römisches Staatsrecht*, iii. p. 300 foll. (3rd ed., Leipzig, 1887), and *Römische Forschungen*, Bd. i. (Berlin, 1879); Soltau, *Entstehung und Zusammensetzung der altrömischen Volksversammlungen*, and *Die Gültigkeit der Plebiscite* (Berlin, 1884); Huschke, *Die Verfassung des Königs Servius Tullius als Grundlage zu einer römischen Verfassungsgeschichte* (Heidelberg, 1838); Borgeaud, *Le Plébiscite dans l'antiquité. Grèce et Rome* (Geneva, 1838); Greenidge, *Roman Public Life*, p. 65 foll., 102, 238 foll. and App. i. (1901); G. W. Botsford, *Roman Assemblies* (1909). (A. H. J. G.)

COMITY (from the Lat. *comitas*, courtesy, from *comis*, friendly, courteous), friendly or courteous behaviour; a term particularly used in international law, in the phrase "comity of nations," for the courtesy of nations towards each other. This has been held by some authorities to be the basis for the recognition by courts of law of the judgments and rules of law of foreign tribunals (see INTERNATIONAL LAW, PRIVATE). "Comity of nations" is sometimes wrongly used, from a confusion with the Latin *comes*, a companion, for the whole body or company of nations practising such international courtesy.

COMMA (Gr. *κόμμα*, a thing stamped or cut off, from *κόπτειν*, to strike), originally, in Greek rhetoric, a short clause, something less than the "colon"; hence a mark (,) ; in punctuation, to show the smallest break in the construction of a sentence. The mark is also used to separate numerals, mathematical symbols and the like. Inverted commas, or "quotation-marks," i.e.

pairs of commas, the first inverted, and the last upright, are placed at the beginning and end of a sentence or word quoted, or of a word used in a technical or conventional sense; single commas are similarly used for quotations within quotations. The word is also applied to comma-shaped objects, such as the "comma-bacillus," the causal agent in cholera.

COMMANDEER (from the South African Dutch *kommanderen*, to command), properly, to compel the performance of military duty in the field, especially of the military service of the Boer republics (see COMMANDO); also to seize property for military purposes; hence used of any peremptory seizure for other than military purposes.

COMMANDER, in the British navy, the title of the second grade of captains. He commands a small vessel, or is second in command of a large one. A staff commander is entrusted with the navigation of a large ship, and ranks above a navigating lieutenant. Since 1838 the officer next in rank to a captain in the U.S. navy has been called commander.

COMMANDERY (through the Fr. *commanderie*, from med. Lat. *commendaria*, a trust or charge), a division of the landed property in Europe of the Knights Hospitallers (see ST JOHN OF JERUSALEM). The property of the order was divided into "priorates," subdivided into "bailiwicks," which in turn were divided into "commanderies"; these were placed in charge of a "commendator" or commander. The word is also applied to the emoluments granted to a commander of a military order of knights.

COMMANDO, a Portuguese word meaning "command," adopted by the Boers in South Africa through whom it has come into English use, for military and semi-military expeditions against the natives. More particularly a "commando" was the administrative and tactical unit of the forces of the former Boer republics, "commandeered" under the law of the constitutions which made military service obligatory on all males between the ages of sixteen and sixty. Each "commando" was formed from the burghers of military age of an electoral district.

COMMEMORATION, a general term for celebrating some past event. It is also the name for the annual act, or *Encaenia*, the ceremonial closing of the academic year at Oxford University. It consists of a Latin oration in commemoration of benefactors and founders; of the recitation of prize compositions in prose and verse, and the conferring of honorary degrees upon English or foreign celebrities. The ceremony, which is usually on the third Wednesday after Trinity Sunday, is held in the Sheldonian Theatre, in Broad St., Oxford. "Commencement" is the term for the equivalent ceremony at Cambridge, and this is also used in the case of American universities.

COMMENDATION (from the Lat. *commendare*, to entrust to the charge of, or to procure a favour for), approval, especially when expressed to one person on behalf of another, a recommendation. The word is used in a liturgical sense for an office commending the souls of the dying and dead to the mercies of God. In feudal law the term is applied to the practice of a freeman placing himself under the protection of a lord (see FEUDALISM), and in ecclesiastical law to the granting of benefices *in commendam*. A benefice was held *in commendam* when granted either temporarily until a vacancy was filled up, or to a layman, or, in case of a monastery or abbey, to a secular cleric to enjoy the revenues and privileges for life (see ABBOT), or to a bishop to hold together with his see. An act of 1836 prohibited the holding of benefices *in commendam* in England.

COMMENTARII (Lat. = Gr. *ὑπομνήματα*), notes to assist the memory, memoranda. This original idea of the word gave rise to a variety of meanings: notes and abstracts of speeches for the assistance of orators; family memorials, the origin of many of the legends introduced into early Roman history from a desire to glorify a particular family; diaries of events occurring in their own circle kept by private individuals,—the day-book, drawn up for Trimalchio in Petronius (*Satyricon*, 53) by his *actuarium* (a slave to whom the duty was specially assigned) is quoted as an example; memoirs of events in which they had taken part drawn up by public men,—such were the "Commentaries" of Caesar on the

Gallic and Civil wars, and of Cicero on his consulship. Different departments of the imperial administration and certain high functionaries kept records, which were under the charge of an official known as a *commentariis* (cf. *a secretis, ab epistulis*). Municipal authorities also kept a register of their official acts.

The *Commentarii Principis* were the register of the official acts of the emperor. They contained the decisions, favourable or unfavourable, in regard to certain citizens; accusations brought before him or ordered by him; lists of persons in receipt of special privileges. These must be distinguished from the *commentarii diurni*, a daily court-journal. At a later period records called *ephemerides* were kept by order of the emperor; these were much used by the *Scriptores Historiae Augustae* (see AUGUSTAN HISTORY). The *Commentarii Senatus*, only once mentioned (Tacitus, *Annals*, xv. 74) are probably identical with the *ACTA SENATUS* (*q.v.*). There were also *Commentarii* of the priestly colleges: (a) *Pontificum*, collections of their decrees and responses for future reference, to be distinguished from their *Annales*, which were historical records, and from their *Acta*, minutes of their meetings; (b) *Augurum*, similar collections of augural decrees and responses; (c) *Decemvirorum*; (d) *Fratrum Arvalium*. Like the priests, the magistrates also had similar notes, partly written by themselves, and partly records of which they formed the subject. But practically nothing is known of these *Commentarii Magistratum*. Mention should also be made of the *Commentarii Regum*, containing decrees concerning the functions and privileges of the kings, and forming a record of the acts of the king in his capacity of priest. They were drawn up in historical times like the so-called *leges regiae* (*jus Papirianum*), supposed to contain the decrees and decisions of the Roman kings.

See the exhaustive article by A. von Premerstein in Pauly-Wissowa, *Realencyclopädie* (1901); Teuffel-Schwabe, *Hist. of Roman Lit.* (Eng. trans.), pp. 72, 77-79; and the concise account by H. Thédenat in Darmberg and Saglio, *Dictionnaire des antiquités*.

COMMENTRY, a town of central France, in the department of Allier, 42 m. S.W. of Moulins by the Orléans railway. Pop. (1906) 7581. Commentry gives its name to a coalfield over 5000 acres in extent, and has important foundries and forges.

COMMERCE (Lat. *commercium*, from *cum*, together, and *merx*, merchandise), in its general acceptation, the international traffic in goods, or what constitutes the foreign trade of all countries as distinct from their domestic trade.

In tracing the history of such dealings we may go back to the early records found in the Hebrew Scriptures. Such a transaction as that of Abraham, for example, weighing down "four hundred shekels of silver, current with the merchant," for the field of Ephron, is suggestive of a group of facts and ideas indicating an advanced condition of commercial intercourse,—property in land, sale of land, arts of mining and purifying metals, the use of silver of recognized purity as a common medium of exchange, and merchandise an established profession, or division of labour. That other passage in which we read of Joseph being sold by his brethren for twenty pieces of silver to "a company of Ishmaelites, coming from Gilead, with their camels bearing spicery and balm and myrrh to Egypt," extends our vision still farther, and shows us the populous and fertile Egypt in commercial relationship with Chaldaea, and Arabians, foreign to both, as intermediaries in their traffic, generations before the Hebrew commonwealth was founded.

The first foreign merchants of whom we read, carrying goods and bags of silver from one distant region to another, were the southern Arabs, reputed descendants of Ishmael and Esau. The first notable navigators and maritime carriers of goods were the Phoenicians. In the commerce of the ante-Christian ages the Jews do not appear to have performed any conspicuous part. Both the agricultural and the theocratic constitution of their society were unfavourable to a vigorous prosecution of foreign trade. In such traffic as they had with other nations they were served on their eastern borders by Arabian merchants, and on the west and south by the Phoenician shippers. The abundance of gold, silver and other precious commodities gathered from

distant parts, of which we read in the days of greatest Hebrew prosperity, has more the character of spoils of war and tributes of dependent states than the conquest by free exchange of their domestic produce and manufacture. It was not until the Jews were scattered by foreign invasions, and finally cast into the world by the destruction of Jerusalem, that they began to develop those commercial qualities for which they have since been famous.

There are three conditions as essential to extensive international traffic as diversity of natural resources, division of labour, accumulation of stock, or any other primal element—(1) means of transport, (2) freedom of labour and exchange, and (3) security; and in all these conditions the ancient world was signally deficient.

The great rivers, which became the first seats of population and empire, must have been of much utility as channels of transport, and hence the course of human power of which they are the geographical delineation, and probably the idolatry with which they were sometimes honoured. Nor were the ancient rulers insensible of the importance of opening roads through their dominions, and establishing post and lines of communication, which, though primarily for official and military purposes, must have been useful to traffickers and to the general population. But the free navigable area of great rivers is limited, and when diversion of traffic had to be made to roads and tracks through deserts, there remained the slow and costly carriage of beasts of burden, by which only articles of small bulk and the rarest value could be conveyed with any hope of profit. Corn, though of the first necessity, could only be thus transported in famines, when beyond price to those who were in want, and under this extreme pressure could only be drawn from within a narrow sphere, and in quantity sufficient to the sustenance of but a small number of people. The routes of ancient commerce were thus interrupted and cut asunder by barriers of transport, and the farther they were extended became the more impassable to any considerable quantity or weight of commodities. As long as navigation was confined to rivers and the shores of inland gulfs and seas, the oceans were a *terra incognita*, contributing nothing to the facility or security of transport from one part of the world to another, and leaving even one populous part of Asia as unapproachable from another as if they had been in different hemispheres. The various routes of trade from Europe and north-western Asia to India, which have been often referred to, are to be regarded more as speculations of future development than as realities of ancient history. It is not improbable that the ancient traffic of the Red Sea may have been extended along the shores of the Arabian Sea to some parts of Hindustan, but that vessels braved the Indian Ocean and passed round Cape Comorin into the Bay of Bengal, 2000 or even 1000 years before mariners had learned to double the Cape of Good Hope, is scarcely to be believed. The route by the Euxine and the Caspian Sea has probably never in any age reached India. That by the Euphrates and the Persian Gulf is shorter, and was besides the more likely from passing through tracts of country, which in the most remote times were seats of great population. There may have been many merchants who traded on all these various routes, but that commodities were passed in bulk over great distances is inconceivable. It may be doubted whether in the ante-Christian ages there was any heavy transport over even 500 m., save for warlike or other purposes, which engaged the public resources of imperial states, and in which the idea of commerce, as now understood, is in a great measure lost.

The advantage which absolute power gave to ancient nations in their warlike enterprises, and in the execution of public works of more or less utility, or of mere ostentation and monumental magnificence, was dearly purchased by the sacrifice of individual freedom, the right to labour, produce and exchange under the steady operation of natural economic principles, which more than any other cause vitalizes the individual and social energies, and multiplies the commercial resource of communities. Commerce in all periods and countries has obtained a certain freedom and hospitality from the fact that the foreign merchant has something

Primary
conditions
of com-
merce.

desirable to offer; but the action of trading is reciprocal, and requires multitudes of producers and merchants, as free agents, on both sides, searching out by patient experiment wants more advantageously supplied by exchange than by direct production, before it can attain either permanence or magnitude, or can become a vital element of national life. The ancient polities offered much resistance to this development, and in their absolute power over the liberty, industry and property of the masses of their subjects raised barriers to the extension of commerce scarcely less formidable than the want of means of communication itself. The conditions of security under which foreign trade can alone flourish equally exceeded the resources of ancient civilization. Such roads as exist must be protected from robbers, the rivers and seas from pirates; goods must have safe passage and safe storage, must be held in a manner sacred in the territories through which they pass, be insured against accidents, be respected even in the madness of hostilities; the laws of nations must give a guarantee on which traders can proceed in their operations with reasonable confidence; and the governments, while protecting the commerce of their subjects with foreigners as if it were their own enterprise, must in their fiscal policy, and in all their acts, be endued with the highest spirit of commercial honour. Every great breach of this security stops the continuous circulation, which is the life of traffic and of the industries to which it ministers. But in the ancient records we see commerce exposed to great risks, subject to constant pilage, hunted down in peace and utterly extinguished in war. Hence it became necessary that foreign trade should itself be an armed force in the world; and though the states of purely commercial origin soon fell into the same arts and wiles as the powers to which they were opposed, yet their history exhibits clearly enough the necessity out of which they arose. Once organized, it was inevitable that they should meet intrigue with intrigue, and force with force. The political empires, while but imperfectly developing industry and traffic within their own territories, had little sympathy with any means of prosperity from without. Their sole policy was either to absorb under their own spirit and conditions of rule, or to destroy, whatever was rich or great beyond their borders. Nothing is more marked in the past history of the world than this struggle of commerce to establish conditions of security and means of communication with distant parts. When almost driven from the land, it often found both on the sea; and often, when its success had become brilliant and renowned, it perished under the assault of stronger powers, only to rise again in new centres and to find new channels of intercourse.

While Rome was giving laws and order to the half-civilized tribes of Italy, Carthage, operating on a different base, and by other methods, was opening trade with less accessible parts of Europe. The strength of Rome was in her legions, that of Carthage in her ships; and her ships could cover ground where the legions were powerless. Her mariners had passed the mythical straits into the Atlantic, and established the port of Cadiz. Within the Mediterranean itself they founded Carthage and Barcelona on the same Iberian peninsula, and ahead of the Roman legions had depots and traders on the shores of Gaul. After the destruction of Tyre, Carthage became the greatest power in the Mediterranean, and inherited the trade of her Phœnician ancestors with Egypt, Greece and Asia Minor, as well as her own settlements in Sicily and on the European coasts. An antagonism between the great naval and the great military power, whose interests crossed each other at so many points, was sure to occur; and in the three Punic wars Carthage measured her strength with that of Rome both on sea and on land with no unequal success. But a commercial state impelled into a series of great wars has departed from its own proper base; and in the year 146 B.C. Carthage was so totally destroyed by the

Roman conquests. Romans that of the great city, more than 20 m. in circumference, and containing at one period near a million of inhabitants, only a few thousands were found within its ruined walls. In the same year Corinth, one of the greatest of the Greek capitals and seaports, was captured, plundered of vast wealth and given to the flames by a Roman

consul. Athens and her magnificent harbour of the Piræus fell into the same hands 60 years later. It may be presumed that trade went on under the Roman conquests in some degree as before; but these were grave events to occur within a brief period, and the spirit of the seat of trade in every case having been broken, and its means and resources more or less plundered and dissipated—in some cases, as in that of Carthage, irreparably—the most necessary commerce could only proceed with feeble and languid interest under the military, consular and proconsular licence of Rome at that period. Tyre, the great seaport of Palestine, having been destroyed by Alexander the **Palmyra**. Great, Palmyra, the great inland centre of Syrian trade, was visited with a still more complete annihilation by the Roman Emperor Aurelian within little more than half a century after the capture and spoliation of Athens. The walls were razed to their foundations; the population—men, women, children and the rustics round the city—were all either massacred or dispersed; and the queen Zenobia was carried captive to Rome. Palmyra had for centuries, as a centre of commercial intercourse and transit, been of great service to her neighbours, east and west. In the wars of the Romans and Parthians she was respected by both as an asylum of common interests which it would have been simple barbarity to invade or injure; and when the Parthians were subdued, and Palmyra became a Roman *annexe*, she continued to flourish as before. Her relations with Rome were more than friendly; they became enthusiastic and heroic; and her citizens having inflicted signal chastisement on the king of Persia for the imprisonment of the emperor Valerian, the admiration of this conduct at Rome was so great that their spirited leader Odaenathus, the husband of Zenobia, was proclaimed Augustus, and became co-emperor with Gallienus. It is obvious that the destruction of Palmyra must not only have doomed Palestine, already bereft of her seaports, to greater poverty and commercial isolation than had been known in long preceding ages, but have also rendered it more difficult to Rome herself to hold or turn to any profitable account her conquests in Asia; and, being an example of the policy of Rome to the seats of trade over nearly the whole ancient world, it may be said to contain in graphic characters a presage of what came to be the actual event—the collapse and fall of the Roman empire itself.

The repeated invasions of Italy by the Goths and Huns gave rise to a seat of trade in the Adriatic, which was to sustain during more than a thousand years a history of unusual splendour. The Veneti cultivated fertile lands on the **Venice**. Po, and built several towns, of which Padua was the chief. They appear from the earliest note of them in history to have been both an agricultural and trading people; and they offered a rich prey to the barbarian hordes when these broke through every barrier into the plains of Italy. Thirty years before Attila razed the neighbouring city of Aquileia, the consuls and senate of Padua, oppressed and terrified by the prior ravages of Alaric, passed a decree for erecting Rialto, the largest of the numerous islets at the mouth of the Po, into a chief town and port, not more as a convenience to the islanders than as a security for themselves and their goods. But every fresh incursion, every new act of spoliation by the dreaded enemies, increased the flight of the rich and the industrious to the islands, and thus gradually arose the second Venice, whose glory was so greatly to exceed that of the first. Approachable from the mainland only by boats, through river passes easily defended by practised sailors against barbarians who had never plied an oar, the Venetian refugees could look in peace on the desolation which swept over Italy; their warehouses, their markets, their treasures were safe from plunder; and stretching their hands over the sea, they found in it fish and salt, and in the rich possessions of trade and territory which it opened to them more than compensation for the fat lands and inland towns which had long been their home. The Venetians traded with Constantinople, Greece, Syria and Egypt. They became lords of the Morea, and of Candia, Cyprus and other islands of the Levant. The trade of Venice with India, though spoken of, was probably never great. But the crusades of the 12th and 13th centuries against the Saracens in Palestine

extended her repute more widely east and west, and increased both her naval and her commercial resources. It is enough, indeed, to account for the grandeur of Venice that in course of centuries, from the security of her position, the growth and energy of her population, and the regularity of her government at a period when these sources of prosperity were rare, she became the great emporium of the Mediterranean—all that Carthage, Corinth and Athens had been in a former age on a scene the most remarkable in the world for its fertility and facilities of traffic,—and that as Italy and other parts of the Western empire became again more settled her commerce found always a wider range. The bridge built from the largest of the islands to the opposite bank became the “Rialto,” or famous exchange of Venice, whose transactions reached farther, and assumed a more consolidated form, than had been known before. There it was where the first public bank was organized; that bills of exchange were first negotiated, and funded debt became transferable; that finance became a science and book-keeping an art. Nor must the effect of the example of Venice on other cities of Italy be left out of account. Genoa, following her steps, rose into great prosperity and power at the foot of the Maritime Alps, and became her rival, and finally her enemy. Naples, Gaeta, Florence, many other towns of Italy, and Rome herself, long after her fall, were encouraged to struggle for the preservation of their municipal freedom, and to foster trade, arts and navigation, by the brilliant success set before them on the Adriatic; but Venice, from the early start she had made, and her command of the sea, had the commercial pre-eminence.

The state of things which arose on the collapse of the Roman empire presents two concurrent facts, deeply affecting the course of trade—(1) the ancient seats of industry and civilization were undergoing constant decay, while (2) the energetic races of Europe were rising into more civilized forms and manifold vigour and copiousness of life. The fall of the Eastern division of the empire prolonged the effect of the fall of the Western empire; and the advance of the Saracens over Asia Minor, Syria, Greece, Egypt, over Cyprus and other possessions of Venice in the Mediterranean, over the richest provinces of Spain, and finally across the Hellespont into the Danubian provinces of Europe, was a new irruption of barbarians from another point of the compass, and revived the calamities and disorders inflicted by the successive invasions of Goths, Huns and other Northern tribes. For more than ten centuries the naked power of the sword was vivid and terrible as flashes of lightning over all the seats of commerce, whether of ancient or more modern origin. The feudal system of Europe, in organizing the open country under military leaders and defenders subordinated in possession and service under a legal system to each other and to the sovereign power, must have been well adapted to the necessity of the times in which it spread so rapidly; but it would be impossible to say that the feudal system was favourable to trade, or the extension of trade. The commercial spirit in the feudal, as in preceding ages, had to find for itself places of security, and it could only find them in towns, armed with powers of self-regulation and defence, and prepared, like the feudal barons themselves, to resist violence from whatever quarter it might come. Rome, in her best days, had founded the municipal system, and when this system was more than ever necessary as the bulwark of arts and manufactures, its extension became an essential element of the whole European civilization. Towns formed themselves into leagues for mutual protection, and out of leagues not infrequently arose commercial republics. The Hanseatic League, founded as early as 1241, gave the first note of an increasing traffic between countries on the Baltic and in northern Germany, which a century or two before were sunk in isolated barbarism. From Lübeck and Hamburg, commanding the navigation of the Elbe, it gradually spread over 85 towns, including Amsterdam, Cologne and Frankfort in the south, and Danzig, Königsberg and Riga in the north. The last trace of this league, long of much service in protecting trade, and as a means of political mediation, passed away in the erection of the German empire (1870), but only from the same cause that had brought about its gradual

dissolution—the formation of powerful and legal governments—which, while leaving to the free cities their municipal rights, were well capable of protecting their mercantile interests. The towns of Holland found lasting strength and security from other causes. Their foundations were laid as literally in the sea as those of Venice had been. They were not easily attacked whether by sea or land, and if attacked had formidable means of defence. The Zuyder Zee, which had been opened to the German Ocean in 1282, carried into the docks and canals of Amsterdam the traffic of the ports of the Baltic, of the English Channel and of the south of Europe, and what the seas did for Amsterdam from without the Rhine and the Maese did for Dort and Rotterdam from the interior. By the Union of Utrecht in 1579 Holland became an independent republic, and for long after, as it had been for some time before, was the greatest centre of maritime traffic in Europe. The rise of the Dutch power in a low country, exposed to the most destructive inundations, difficult to cultivate or even to inhabit, affords a striking illustration of those conditions which in all times have been found specially favourable to commercial development, and which are not indistinctly reflected in the mercantile history of England, preserved by its insular position from hostile invasions, and capable by its fleets and arms to protect its goods on the seas and the rights of its subjects in foreign lands.

The progress of trade and productive arts in the middle ages, though not rising to much international exchange, was very considerable both in quality and extent. The republics of Italy, which had no claim to rival Venice or Genoa in maritime power or traffic, developed a degree of art, opulence and refinement commanding the admiration of modern times; and if any historian of trans-Alpine Europe, when Venice had already attained some greatness, could have seen it five hundred years afterwards, the many strong towns of France, Germany and the Low Countries, the great number of their artisans, the products of their looms and anvils, and their various cunning workmanship, might have added many a brilliant page to his annals. Two centuries before England had discovered any manufacturing quality, or knew even how to utilize her most valuable raw materials, and was importing goods from the continent for the production of which she was soon to be found to have special resources, the Flemings were selling their woollen and linen fabrics, and the French their wines, silks and laces in all the richer parts of the British Islands. The middle ages placed the barbarous populations of Europe under a severe discipline, trained them in the most varied branches of industry, and developed an amount of handicraft and ingenuity which became a solid basis for the future. But trade was too walled in, too much clad in armour, and too incessantly disturbed by wars and tumults, and violations of common right and interest, to exert its full influence over the general society, or even to realize its most direct advantages. It wanted especially the freedom and mobility essential to much international increase, and these it was now to receive from a series of the most pregnant events.

The mariner's compass had become familiar in the European ports about the beginning of the 14th century, and the seamen of Italy, Portugal, France, Holland and England entered upon a more enlightened and adventurous course of navigation. The Canary Islands were sighted by a French vessel in 1330, and colonized in 1418 by the Portuguese, who two years later landed on Madeira. In 1431 the Azores were discovered by a shipmaster of Bruges. The Atlantic was being gradually explored. In 1486, Diaz, a Portuguese, steering his course almost unwittingly along the coast of Africa, came upon the land's-end of that continent; and eleven years afterwards Vasco da Gama, of the same nation, not only doubled the Cape of Good Hope, but reached India. About the same period Portuguese travellers penetrated to India by the old time-honoured way of Suez; and a land which tradition and imagination had invested with almost fabulous wealth and splendour was becoming more real to the European world at the moment when the expedition of Vasco da Gama had made an oceanic route to its shores distinctly visible. One can hardly now realize the impression made by these discoveries

The middle ages.

Opening of a new era.

in an age when the minds of men were awakening out of a long sleep, when the printing press was disseminating the ancient classical and sacred literature, and when geography and astronomy were subjects of eager study in the seats both of traffic and of learning. But their practical effect was seen in swiftly-succeeding events. Before the end of the century Columbus had thrice crossed the Atlantic, touched at San Salvador, discovered Jamaica, Porto Rico and the Isthmus of Darien, and had seen the waters of the Orinoco in South America. Meanwhile Cabot, sent out by England, had discovered Newfoundland, planted the English flag on Labrador, Nova Scotia and Virginia, and made known the existence of an expanse of land now known as Canada. This tide of discovery by navigators flowed on without intermission. But the opening of a maritime route to India and the discovery of America, surprising as these events must have been at the time, were slow in producing the results of which they were a sure prognostic. The Portuguese established in Cochin the first European factory in India a few years after Vasco da Gama's expedition, and other maritime nations of Europe traced a similar course. But it was not till 1600 that the English East India Company was established, and the opening of the first factory of the Company in India must be dated some ten or eleven years later. So also it was one thing to discover the two Americas, and another, in any real sense, to possess or colonize them, or to bring their productions into the general traffic and use of the world. Spain, following the stroke of the valiant oar of Columbus, found in Mexico and Peru remarkable remains of an ancient though feeble civilization, and a wealth of gold and silver mines, which to Europeans of that period was fascinating from the rarity of the precious metals in their own realms, and consequently gave to the Spanish colonizations and conquests in South America an extraordinary but unsolid prosperity. The value of the precious metals in Europe was found to fall as soon as they began to be more widely distributed, a process in itself at that period of no small tediousness; and it was discovered further, after a century or two, that the production of gold and silver is limited like the production of other commodities for which they exchange, and only increased in quantity at a heavier cost, that is only reduced again by greater art and science in the process of production. Many difficulties, in short, had to be overcome, many wars to be waged, and many deplorable errors to be committed, in turning the new advantages to account. But given a maritime route to India and the discovery of a new world of continent and islands in the richest tropical and sub-tropical latitudes, it could not be difficult to foresee that the course of trade was to be wholly changed as well as vastly extended.

The substantial advantage of the oceanic passage to India by the Cape of Good Hope, as seen at the time, was to enable European trade with the East to escape from the Moors, Algerines and Turks who now swarmed round the shores of the Mediterranean, and waged a predatory war on ships and cargoes which would have been a formidable obstacle even if traffic, after running this danger, had not to be further lost, or filtered into the smallest proportions, in the sands of the Isthmus, and among the Arabs who commanded the navigation of the Red and Arabian Seas. Venice had already begun to decline in her wars with the Turks, and could inadequately protect her own trade in the Mediterranean. Armed vessels sent out in strength from the Western ports often fared badly at the hands of the pirates. European trade with India can scarcely be said, indeed, to have yet come into existence. The maritime route was round about, and it lay on the hitherto almost untrodden ocean, but the ocean was a safer element than inland seas and deserts infested by the lawlessness and ferocity of hostile tribes of men. In short, the maritime route enabled European traders to see India for themselves, to examine what were its products and its wants, and by what means a profitable exchange on both sides could be established; and on this basis of knowledge, ships could leave the ports of their owners in Europe with a reasonable hope, via the Cape, of reaching the places to which they were destined without transshipment or other intermediary obstacle. This is the explanation to be given of the

Maritime route to India.

joy with which the Cape of Good Hope route was received, as well as the immense influence it exerted on the future course and extension of trade, and of the no less apparent satisfaction with which it was to some extent discarded in favour of the ancient line, via the Mediterranean, Isthmus of Suez and the Red Sea.

The maritime route to India was the discovery to the European nations of a "new world" quite as much as the discovery of North and South America and their central isthmus and islands. The one was the far, populous Eastern world, heard of from time immemorial, but with which there had been no patent lines of communication. The other was a vast and comparatively unpeopled solitude, yet full of material resources, and capable in a high degree of European colonization. America offered less resistance to the action of Europe than India, China and Japan; but on the other hand this new populous Eastern world held out much attraction to trade. These two great terrestrial discoveries were contemporaneous; and it would be difficult to name any conjuncture of material events bearing with such importance on the history of the world. The Atlantic Ocean was the medium of both; and the waves of the Atlantic beat into all the bays and tidal rivers of western Europe. The centre of commercial activity was thus physically changed; and the formative power of trade over human affairs was seen in the subsequent phenomena—the rise of great seaports on the Atlantic seaboard, and the ceaseless activity of geographical exploration, manufactures, shipping and emigration, of which they became the outlets.

Discovery of America.

The Portuguese are entitled to the first place in utilizing the new sources of wealth and commerce. They obtained Macao as a settlement from the Chinese as early as 1537, and their trading operations followed close on the discoveries of their navigators on the coast of Africa, in India and in the Indian Archipelago. Spain spread her dominion over Central and South America, and forced the labour of the subject natives into the gold and silver mines, which seemed in that age the chief prize of her conquests. France introduced her trade in both the East and West Indies, and was the first to colonize Canada and the Lower Mississippi. The Dutch founded New York in 1621; and England, which in boldness of naval and commercial enterprise had attained high rank in the reign of Elizabeth, established the thirteen colonies which became the United States, and otherwise had a full share in all the operations which were transforming the state of the world. The original disposition of affairs was destined to be much changed by the fortune of war; and success in foreign trade and colonization, indeed, called into play other qualities besides those of naval and military prowess. The products of so many new countries—tissues, dyes, metals, articles of food, chemical substances—greatly extended the range of European manufacture. But in addition to the mercantile faculty of discovering how they were to be exchanged and wrought into a profitable trade, their use in arts and manufactures required skill, invention and aptitude for manufacturing labour, and those again, in many cases, were found to depend on abundant possession of natural materials, such as coal and iron. In old and populous countries, like India and China, modern manufacture had to meet and contend with ancient manufacture, and had at once to learn from and improve economically on the established models, before an opening could be made for its extension. In many parts of the New World there were vast tracts of country, without population or with native races too wild and savage to be reclaimed to habits of industry, whose resources could only be developed by the introduction of colonies of Europeans; and innumerable experiments disclosed great variety of qualification among the European nations for the adventure, hardship and perseverance of colonial life. There were countries which, whatever their fertility of soil or favour of climate, produced nothing for which a market could be found; and products such as the sugar-cane and the seed of the cotton plant had to be carried from regions where they were indigenous to other regions where they might be successfully cultivated, and the art of planting had to pass through an ordeal of risk and speculation. There were

Increase of trading settlements and colonies.

also countries where no European could labour; and the ominous work of transporting African negroes as slaves into the colonies—begun by Spain in the first decade of the 16th century, followed up by Portugal, and introduced by England in 1562 into the West Indies, at a later period into New England and the Southern States, and finally domiciled by royal privilege of trade in the Thames and three or more outports of the kingdom,—after being done on an elaborate scale, and made the basis of an immense superstructure of labour, property and mercantile interest over nearly three centuries, had, under a more just and ennobling view of humanity, to be as elaborately undone at a future time.

These are some of the difficulties that had to be encountered in utilizing the great maritime and geographical conquests of the new epoch. But one cannot leave out of view the obstacles, arising from other sources, to what might be expected to be the regular and easy course of affairs. Commerce, though an undying and prevailing interest of civilized countries, is but one of the forces acting on the policy of states, and has often to yield the pace to other elements of national life. It were needless to say what injury the great but vain and purposeless wars of Louis XIV. of France inflicted in that country, or how largely the fruitful and heroic energies of England were absorbed in the civil wars between Charles and the Parliament, to what poverty Scotland was reduced, or in what distraction and savagery Ireland was kept by the same course of events. The grandeur of Spain in the preceding century was due partly to the claim of her kings to be Holy Roman emperors, in which imperial capacity they entailed intolerable mischief on the Low Countries and on the commercial civilization of Europe, and partly to their command of the gold and silver mines of Mexico and Peru, in an eager lust of whose produce they brought cruel calamities on a newly-discovered continent where there were many traces of antique life, the records of which perished in their hands or under their feet. These ephemeral causes of greatness removed, the hollowness of the situation was exposed; and Spain, though rich in her own natural resources, was found to be actually poor—poor in number of people, poor in roads, in industrial art, and in all the primary conditions of interior development. An examination of the foreign trade of Europe two centuries after the opening of the maritime route to India and the discovery of America would probably give more reason to be surprised at the smallness than the magnitude of the use that had been made of these events.

By the beginning of the 19th century the world had been well explored. Colonies had been planted on every coast; great nations had sprung up in vast solitudes or in countries inhabited only by savage or decadent races of men; the most haughty and exclusive of ancient nations had opened their ports to foreign merchantmen; and all parts of the world had been brought into habitual commercial intercourse. The seas, subdued by the progress of navigation to the service of man, had begun to yield their own riches in great abundance and the whale, seal, herring, cod and other fisheries, prosecuted with ample capital and hardy seamanship, had become the source of no small traffic in themselves. The lists of imports and exports and of the places from which they flowed to and from the centres of trade, as they swelled in bulk from time to time, show how busily and steadily the threads of commerce had been weaving together the labour and interests of mankind, and extending a security and bounty of existence unknown in former ages. The 19th century witnessed an extension of the commercial relations of mankind of which there was no parallel in previous history. The heavy debts and taxes, and the currency complications in which the close of the Napoleonic wars left the European nations, as well as the fall of prices which was the necessary effect of the sudden closure of a vast war expenditure and absorption of labour, had a crippling effect for many years on trading energies. Yet even under such circumstances commerce is usually found, on its well-established modern basis, to make steady progress from one series of years to another. The powers of production had been greatly increased by a brilliant development of mechanical arts and inventions. The United States

had grown into a commercial nation of the first rank. The European colonies and settlements were being extended, and assiduously cultivated, and were opening larger and more varied markets for manufactures. In 1819 the first steamboat crossed the Atlantic from New York to Liverpool, and a similar adventure was accomplished from England to India in 1825—events in themselves the harbingers of a new era in trade. China, after many efforts, was opened under treaty to an intercourse with foreign nations which was soon to attain surprising dimensions. These various causes supported the activity of commerce in the first four decades; but the great movement which made the 19th century so remarkable was chiefly disclosed in practical results from about 1840. The outstanding characteristics of the 19th century were the many remarkable inventions which so widened the field of commerce by the discovery of new and improved methods of production, the highly organized division of labour which tended to the same end, and, above all, the powerful forces of steam navigation, railways and telegraphs.

Commerce has thus acquired a security and extension, in all its most essential conditions, of which it was void in any previous age. It can hardly ever again exhibit that wandering course from route to route, and from one solitary centre to another, which is so characteristic of its ancient history, because it is established in every quarter of the globe, and all the seas and ways are open to it on terms fair and equal to every nation. Wherever there is population, industry, resource, art and skill, there will be international trade. Commerce will have many centres, and one may relatively rise or relatively fall; but such decay and ruin as have smitten many once proud seats of wealth into dust cannot again occur without such cataclysms of war, violence and disorder as the growing civilization and reason of mankind, and the power of law, right and common interest forbid us to anticipate. But the present magnitude of commerce devolves serious work on all who are engaged in it. If in the older times it was thought that a foreign merchant required to be not only a good man of business, but even a statesman, it is evident that all the higher faculties of the mercantile profession must still more be called into request when imports and exports are reckoned by hundreds instead of fives or tens of millions, when the markets are so much larger and more numerous, the competition so much more keen and varied, the problems to be solved in every course of transaction so much more complex, the whole range of affairs to be overseen so immensely widened. It is not a company of merchants, having a monopoly, and doing whatever they please, whether right or wrong, that now hold the commerce of the world in their hands, but large communities of free merchants in all parts of the world, affiliated to manufacturers and producers equally free, each under strong temptation to do what may be wrong in the pursuit of his own interest, and the only security of doing right being to follow steady lights of information and economic science common to all. Easy transport of goods by land and sea, prompt intelligence from every point of the compass, general prevalence of mercantile law and safety, have all been accomplished; and the world is opened to trade. But intellectual grasp of principles and details, and the moral integrity which is the root of all commercial success, are severely tested in this vaster sphere.

See TRADE ORGANIZATION; ECONOMICS; COMMERCIAL TREATIES, and the sections under the headings of countries.

COMMERCE, the name of a card-game. Any number can play with an ordinary pack. There are several variations of the game, but the following is a common one. Each player receives three cards, and three more are turned up as a "pool." The first player may exchange one or two of his cards for one or two of the exposed cards, putting his own, face upwards, in their place. His object is to "make his hand" (see below), but if he changes all three cards at once he cannot change again. The next player can do likewise, and so on. Usually there are as many rounds as there are players, and a fresh card is added to the pool at the beginning of each. If a player passes once he cannot exchange afterwards. When the rounds are finished the hands are shown, the holder of the best either receiving a stake from

all the others, or, supposing each has started with three "lives," taking one life from the lowest. The hands, in order of merit, are: (i.) *Tricon*—three similar cards, three aces ranking above three kings, and so on. (ii.) *Sequence*—three cards of the same suit in consecutive order; the highest sequence is the best. (iii.) *Flush*—three cards of the same suit, the highest "point" wins, *i.e.* the highest number of pips, ace counting eleven and court-cards ten. (iv.) *Pair*—two similar cards, the highest pair winning. (v.) *Point*—the largest number of pips winning, as in "flush," but there is no restriction as to suit. Sometimes "pair" and "point" are not recognized. A popular variation of Commerce is *Pounce Commerce*. In this, if a player has already three similar cards, *e.g.* three nines, and the fourth nine comes into the pool, he says "Pounce!" and takes it, thus obtaining a hand of four, which is higher than any hand of three: whenever a pounce occurs, a new card is turned up from the pack.

COMMERCIAL COURT, in England, a court presided over by a single judge of the king's bench division, for the trial, as expeditiously as may be, of commercial cases. By the Rules of the Supreme Court, Order xviii. a (made in November 1893), a plaintiff was allowed to dispense with pleadings altogether, provided that the indorsement of his writ of summons contained a statement sufficient to give notice of his claim, or of the relief or remedy required in the action, and stating that the plaintiff intended to proceed to trial without pleadings. The judge might, on the application of the defendant, order a statement of claim to be delivered, or the action to proceed to trial without pleadings, and if necessary particulars of the claim or defence to be delivered. Out of this order grew the commercial court. It is not a distinct court or division or branch of the High Court, and is not regulated by any special rules of court made by the rule committee. It originated in a notice issued by the judges of the queen's bench division, in February 1895 (see *W.N.*, 2nd of March 1895), the provisions contained in which represent only "a practice agreed on by the judges, who have the right to deal by convention among themselves with this mode of disposing of the business in their courts" (per Lord Esher in *Barry v. Peruvian Corporation*, 1896, 1 Q. B. p. 209). A separate list of causes of a commercial character is made and assigned to a particular judge, charged with commercial business, to whom all applications before the trial are made. The 8th paragraph is as follows:—

Such judge may at any time after appearance and without pleadings make such order as he thinks fit for the speedy determination, in accordance with existing rules, of the questions really in controversy between the parties.

Practitioners before Sir George Jessel, at the rolls, in the years 1873 to 1880, will be reminded of his mode of ascertaining the point in controversy and bringing it to a speedy determination. Obviously the scheme is only applicable to cases in which there is some single issue of law or fact, or the case depends on the construction of some contract or other instrument or section of an act of parliament, and such issue or question is either agreed upon by the parties or at once ascertainable by the judge. The success of the scheme also depends largely on the personal qualities of the judge to whom the list is assigned. Under the able guidance of Mr (afterwards Lord) Justice Mathew (d. 1908), the commercial court became very successful in bringing cases to a speedy and satisfactory determination without any technicality or unnecessary expense.

COMMERCIAL LAW, a term used rather indefinitely to include those main rules and principles which, with more or less minor differences, characterize the commercial transactions and customs of most European countries. It includes within its compass such titles as principal and agent; carriage by land and sea; merchant shipping; guarantee; marine, fire, life and accident insurance; bills of exchange, partnership, &c.

COMMERCIAL TREATIES. A commercial treaty is a contract between states relative to trade. It is a bilateral act whereby definite arrangements are entered into by each contracting party towards the other—not mere concessions. As regards technical distinctions, an "agreement," an "exchange of notes," or a "convention" properly applies to one specific

subject; whereas a "treaty" usually comprises several matters, whether commercial or political.

In ancient times foreign intercourse, trade and navigation were in many instances regulated by international arrangements. The text is extant of treaties of commerce and navigation concluded between Carthage and Rome in 509 and 348 B.C. Aristotle mentions that nations were connected by commercial treaties; and other classical writers advert to these engagements. Under the Roman empire the matters thus dealt with became regulated by law, or by usages sometimes styled laws. When the territories of the empire were contracted, and the imperial authority was weakened, some kind of international agreements again became necessary. At Constantinople in the 10th century treaties cited by Gibbon protected "the person, effects and privileges of the Russian merchant"; and, in western Europe, intercourse, trade and navigation were carried on, at first tacitly by usage derived from Roman times, or under verbal permission given to merchants by the ruler to whose court they resorted. Afterwards, security in these transactions was afforded by means of formal documents, such as royal letters, charters, laws and other instruments possessing the force of government measures. Instances affecting English commercial relations are the letter of Charlemagne in 796, the Brabant Charter of 1305, and the Russian ukase of 1569. Medieval treaties of truce or peace often contained a clause permitting in general terms the renewal of personal and commercial communication as it subsisted before the war. This custom is still followed. But these medieval arrangements were precarious: they were often of temporary duration, and were usually only effective during the lifetime of the contracting sovereigns.

Passing over trade agreements affecting the Eastern empire, the modern commercial treaty system came into existence in the 12th century. Genoa, Pisa and Venice were then well-organized communities, and were in keen rivalry. Whenever their position in a foreign country was strong, a trading centre was established, and few or no specific engagements were made on their part. But in serious competition or difficulty another course was adopted: a formal agreement was concluded for the better security of their commerce and navigation. The arrangements of 1140 between Venice and Sicily; the Genoese conventions of 1149 with Valencia, of 1161 with Morocco, and of 1181 with the Balearic Islands; the Pisan conventions of 1173 with Sultan Saladin, and of 1184 with the Balearic Islands, were the earliest Western commercial treaties. Such definite arrangements, although still of a personal character, were soon perceived to be preferable to general provisions in a treaty of truce or peace. They afforded also greater security than privileges enjoyed under usage; or under grants of various kinds, whether local or royal. The policy thus inaugurated was adopted gradually throughout Europe. The first treaties relative to the trade of the Netherlands were between Brabant and Holland in 1203, Holland and Utrecht in 1204, and Brabant and Cologne in 1251. Early northern commercial treaties are those between Riga and Smolensk 1229, and between Lübeck and Sweden 1269. The first commercial relations between the Hanse Towns and foreign countries were arrangements made by guilds of merchants, not by public authorities as a governing body. For a long period the treaty system did not entirely supersede conditions of intercourse between nations dependent on permission.

The earliest English commercial treaty is that with Norway in 1217. It provides "ut mercatores et homines qui sunt de potestate vestra liberè et sine impedimento terram nostram adire possint, et homines et mercatores nostri similiter vestram." These stipulations are in due treaty form. The next early English treaties are:—with Flanders, 1274 and 1314; Portugal, 1308, 1352 and 1386; Baltic Cities, 1319 and 1388; Biscay and Castile, 1351; Burgundy, 1417 and 1496; France, 1471, 1497 and 1510; Florence, 1490. The commercial treaty policy in England was carried out systematically under Henry IV. and Henry VII. It was continued under James I. to extend to Scotland English trading privileges. The results attained in the 17th century were—regularity in treaty arrangements; their

urable instead of personal nature; the conversion of permissive into perfect rights; questions as to contraband and neutral trade stated in definite terms. Treaties were at first limited to exclusive and distinct engagements between the contracting states; each treaty differing more or less in its terms from other similar compacts. Afterwards by extending to a third nation privileges granted to particular countries, the *most favoured nation article* began to be framed, as a unilateral engagement by a particular state. The Turkish capitulations afford the earliest instances; and the treaty of 1641 between the Netherlands and Portugal contains the first European formula. Cromwell continued the commercial treaty policy partly in order to obtain a formal recognition of the commonwealth from foreign powers. His treaty of 1654 with Sweden contains the first reciprocal "most favoured nation clause":—Article IV. provides that the people, subjects and inhabitants of either confederate "shall have and possess in the countries, lands, dominions and kingdoms of the other as full and ample privileges, and as many exemptions, immunities and liberties, as any foreigner doth or shall possess in the dominions and kingdoms of the said confederate." The government of the Restoration replaced and enlarged the Protectorate arrangements by fresh agreements. The general policy of the commonwealth was maintained, with further provisions on behalf of colonial trade. In the new treaty of 1661 with Sweden the privileges secured were those which "any foreigner whatsoever doth or shall enjoy in the said dominions and kingdoms on both sides."

In contemporary treaties France obtained from Spain (1659) that French subjects should enjoy the same liberties as had been granted to the English; and England obtained from Denmark (1661) that the English should not pay more or greater customs than the people of the United Provinces and other foreigners, the Swedes only excepted. The colonial and navigation policy of the 17th century, and the proceedings of Louis XIV., provoked animosities and retaliatory tariffs. During the War of the Spanish Succession the Methuen Treaty of 1703 was concluded. Portugal removed prohibitions against the importation of British woollens; Great Britain engaged that Portuguese wines should pay one-third less duty than the rate levied on French wines. At the peace of Utrecht in 1713 political and commercial treaties were concluded. England agreed to remove prohibitions on the importation of French goods, and to grant most favoured nation treatment in relation to goods and merchandise of the like nature from any other country in Europe; the French general tariff of the 18th of September 1664, was to be again put in force for English trade. The English provision was at variance with the Methuen Treaty. A violent controversy arose as to the relative importance in 1713 of Anglo-Portuguese or Anglo-French trade. In the end the House of Commons, by a majority of 9, rejected the bill to give effect to the commercial treaty of 1713; and trade with France remained on an unsatisfactory footing until 1786. The other commercial treaties of Utrecht were very complete in their provisions, equal to those of the present time; and contained most favoured nation articles—England secured in 1715 reduction of duties on woollens imported into the Austrian Netherlands; and trading privileges in Spanish America. Moderate import duties for woollens were obtained in Russia by the commercial treaty of 1766. In the meanwhile the Bourbon family compact of the 15th of August 1761 assured national treatment for the subjects of France, Spain and the Two Sicilies, and for their trade in the European territories of the other two states; and most favoured nation treatment as regards any special terms granted to any foreign country. The first commercial treaties concluded by the United States with European countries contained most favoured nation clauses: this policy has been continued by the United States, but the wording of the clause has often varied.

In 1786 France began to effect tariff reform by means of commercial treaties. The first was with Great Britain, and it terminated the long-continued tariff warfare. But the wars of the French Revolution swept away these reforms, and brought about a renewal of hostile tariffs. Prohibitions and differential

duties were renewed, and prevailed on the continent until the sixth decade of the 19th century. In 1860 a government existed in France sufficiently strong and liberal to revert to the policy of 1786. The bases of the Anglo-French treaty of 1860, beyond its most favoured nation provisions, were in France a general transition from prohibition or high customs duties to a moderate tariff; in the United Kingdom abandonment of all protective imposts, and reduction of duties maintained for fiscal purposes to the lowest rates compatible with these exigencies. Other European countries were obliged to obtain for their trade the benefit of the conventional tariff thus established in France, as an alternative to the high rates inscribed in the general tariff. A series of commercial treaties was accordingly concluded by different European states between 1861 and 1866, which effected further reductions of customs duties in the several countries that came within this treaty system. In 1871 the Republican government sought to terminate the treaties of the empire. The British negotiators nevertheless obtained the relinquishment of the attempt to levy protective duties under the guise of compensation for imposts on raw materials; the duration of the treaty of 1860 was prolonged; and stipulations better worded than those before in force were agreed to for shipping and most favoured nation treatment. In 1882, however, France terminated her existing European tariff treaties. Belgium and some other countries concluded fresh treaties, less liberal than those of the system of 1860, yet much better than anterior arrangements. Great Britain did not formally accept these higher duties; the treaty of the 28th of February 1882, with France, which secured most favoured nation treatment in other matters, provided that customs duties should be "henceforth regulated by the internal legislation of each of the two states." In 1892 France also fell out of international tariff arrangements; and adopted the system of double columns of customs duties—one, of lower rates, to be applied to the goods of all nations receiving most favoured treatment; and the other, of higher rates, for countries not on this footing. Germany then took up the treaty tariff policy; and between 1891 and 1894 concluded several commercial treaties.

International trade in Europe in 1909 was regulated by a series of tariffs which came into operation, mainly on the initiative of Germany in 1906. Austria-Hungary, Belgium, Bulgaria, Germany, Italy, Rumania, Russia, Servia and Switzerland, were parties to them. Their object and effect was protectionist. The British policy then became one of obtaining modifications to remedy disadvantages to British trade, as was done in the case of Bulgaria and Rumania. An important series of commercial arrangements had been concluded between 1884 and 1900 respecting the territories and spheres of interest of European powers in western, central and eastern Africa. In these regions exclusive privileges were not claimed; most favoured nation treatment was recognized, and there was a disposition to extend national treatment to all Europeans and their trade.

The Turkish *Capitulations (q.v.)* are grants made by successive sultans to Christian nations, conferring rights and privileges in favour of their subjects resident or trading in the Ottoman dominions, following the policy towards European states of the Eastern empire. In the first instance capitulations were granted separately to each Christian state, beginning with the Genoese in 1453, which entered into pacific relations with Turkey. Afterwards new capitulations were obtained which summed up in one document earlier concessions, and added to them in general terms whatever had been conceded to one or more other states; a stipulation which became a most favoured nation article. The English capitulations date from 1569, and then secured the same treatment as the Venetians, French, Poles and the subjects of the emperor of Germany; they were revised in 1675, and as then settled were confirmed by treaties of subsequent date "now and for ever." Capitulations signify that which is arranged under distinct "headings"; the Turkish phrase is "ahid nameh," whereas a treaty is "mouahedé"—the latter does, and the former does not, signify a reciprocal engagement. Thus, although the Turkish capitulations are not in themselves treaties, yet by subsequent confirmation they have acquired the force of commercial

treaties of perpetual duration as regards substance and principles, while details, such as rates of customs duties, may, by mutual consent, be varied from time to time.

The *most favoured nation* article already referred to concedes to the state in the treaty with which it is concluded whatever advantages in the matters comprised within its stipulations have been allowed to any foreign or third state. It does not in itself directly confer any particular rights, but sums up the whole of the rights in the matters therein mentioned which have been or may be granted to foreign countries. The value of the privileges under this article accordingly varies with the conditions as to these rights in each state which concedes this treatment.

The article is drafted in different form:

(1) That contracting states A. and B. agree to extend to each other whatever rights and privileges they concede to countries C. and D., or to C. and D. and any other country. The object in this instance is to ensure specifically to B. and A. whatever advantages C. and D. may possess. A recent instance is Article XI. of the treaty of May 10, 1871, between France and Germany, which binds them respectively to extend to each other whatever advantages they grant to Austria, Belgium, Great Britain, the Netherlands, Russia and Switzerland.

(2) The present general formula: A. and B. agree to extend to each other whatever advantages they concede to any third country; and engage that no other or higher duties shall be levied on the importation into A. and B. respectively of goods the produce or manufacture of B. and A. than are levied on the like goods the produce or manufacture of any third country the most favoured in this respect. There is a similar clause in regard to exportation.

(3) The conditional or reciprocity formula, often used in the 18th and in the early part of the 19th century, namely, that whenever A. and B. make special concessions in return for corresponding concessions, B. and A. respectively are either excluded from participation therein, or must make some additional equivalent concession in order to participate in those advantages.

It may further be observed that the word "like" relates to the goods themselves, to their material or quality, not to conditions of manufacture, mode of conveyance or anything beyond the fact of their precise description; small local facilities allowed to traffic between conterminous land districts are not at variance with this article.

A recent complete and concise English formula is that of Article 2 of the treaty of commerce and navigation of the 31st of October 1905, with Rumania. "The contracting parties agree that, in all matters relating to commerce, navigation and industry, any privilege, favour or immunity which either contracting party has actually granted, or may hereafter grant, to the subjects or citizens of any other foreign state, shall be extended immediately and unconditionally to the subjects of the other; it being their intention that the commerce, navigation and industry of each country shall be placed, in all respects, on the footing of the most favoured nation."

Colonies.—The application of commercial treaties to colonies depends upon the wording of each treaty. The earlier colonial policy of European states was to subordinate colonial interests to those of the mother country, to reserve colonial trade for the mother country, and to abstain from engagements contrary to these general rules. France, Portugal and Spain have adhered in principle to this policy. Germany and Holland have been more liberal. The self-government enjoyed by the larger British colonies has led since 1886 to the insertion of an article in British commercial and other treaties whereby the assent of each of these colonies, and likewise of India, is reserved before they apply to each of these possessions. And further, the fact that certain other British colonies are now within the sphere of commercial intercourse controlled by the United States, has since 1891 induced the British government to enter into special agreements on behalf of colonies for whose products the United States is now the chief market. As regards the most favoured nation article, it is to be remembered that the mother country and colonies are not distinct—not foreign or third—countries with respect to each other. The most favoured nation article, therefore, does not preclude special arrangements between the mother country and colonies, nor between colonies.

Termination.—Commercial treaties are usually concluded for a term of years, and either lapse at the end of this period, or are terminable then, or subsequently, if either state gives the required notice. When a portion of a country establishes its independence, for example the several American republics, according to present usage foreign trade is placed on a uniform most favoured nation

footing, and fresh treaties are entered into to regulate the commercial relations of the new communities. In the case of former Turkish provinces, the capitulations remain in force in principle until they are replaced by new engagements. If one state is absorbed into another, for instance Texas into the United States, or when territory passes by conquest, for instance Alsace to Germany, the commercial treaties of the new supreme government take effect. In administered territories, as Cyprus and formerly Bosnia, and in protected territories, it depends on the policy of the administering power how far the previous fiscal system shall remain in force. When the separate Italian states were united into the kingdom of Italy in 1861, the commercial engagements of Sardinia superseded those of the other states, but fresh treaties were concluded by the new kingdom to place international relations on a regular footing. When the German empire was established under the king of Prussia in 1871, the commercial engagements of any state which were at variance with a Zollverein treaty were superseded by that treaty.

Scope.—The scope of commercial treaties is well expressed by Calvo in his work on international law. They provide for the importation, exportation, transit, transhipment and bonding of merchandise; customs tariffs; navigation charges; quarantine; the admission of vessels to roadsteads, ports and docks; coasting trade; the admission of consuls and their rights; fisheries; they determine the local position of the subjects of each state in the other country in regard to residence, property, payment of taxes or exemptions, and military service; nationality; and a most favoured nation clause. They usually contain a termination, and sometimes a colonial article. Some of the matters enumerated by Calvo—consular privileges, fisheries and nationality—are now frequently dealt with by separate conventions. Contraband and neutral trade are not included as frequently as they were in the 18th century.

The preceding statement shows that commercial treaties afford to foreigners, personally, legal rights, and relief from technical disabilities: they afford security to trade and navigation, and regulate other matters comprised in their provisions. In Europe the general principles established by the series of treaties 1860–1866 hold good, namely, the substitution of uniform rates of customs duties for prohibitions or differential rates. The disadvantages urged are that these treaties involve government interference and bargaining, whereas each state should act independently as its interests require, that they are opposed to free trade, and restrict the fiscal freedom of the legislature. It may be observed that these objections imply some confusion of ideas. All contracts may be designated bargains, and some of the details of commercial treaties in Calvo's enumeration enter directly into the functions of government; moreover, countries cannot remain isolated. If two countries agree by simultaneous action to adopt fixed rates of duty, this agreement is favourable to commerce, and it is not apparent how it is contrary, even to free trade principles. Moreover, security in business transactions, a very important consideration, is provided.

Our conclusions are—

- (1) that under the varying jurisprudence of nations commercial treaties are adopted by common consent;
- (2) that their provisions depend upon the general and fiscal policy of each state;
- (3) that tariff arrangements, if judiciously settled, benefit trade;
- (4) that commercial treaties are now entered into by all states; and that they are necessary under present conditions of commercial intercourse between nations. (C. M. K.*)

See the British parliamentary *Return* (Cd. 4080) of all commercial treaties between various countries in force on Jan. 1, 1908.

COMMERCE, a town of north-eastern France, capital of an arrondissement in the department of Meuse, on the left bank of the Meuse, 26 m. E. of Bar-le-Duc by rail. Pop. (1906) 5622. Commerce possesses a chateau of the 17th century, now used as cavalry barracks, a Benedictine convent occupied by a training-college for primary teachers, and a communal college for boys. A statue of Dom Calmet, the historian, born in the vicinity, stands

in one of the squares. The industries include iron-working and the manufacture of nails, boots and shoes, embroidery and hosiery. The town has trade in cattle, grain and wood, and is well known for its cakes (*madeleines*). Commercency dates back to the 9th century, and at that time its lords were dependent on the bishop of Metz. In 1544 it was besieged by Charles V. in person. For some time the lordship was in the hands of François Paul de Gondi, cardinal de Retz, who lived in the town for a number of years, and there composed his memoirs. From him it was purchased by Charles IV., duke of Lorraine. In 1744 it became the residence of Stanislas, king of Poland, who spent a great deal of care on the embellishment of the town, castle and neighbourhood.

COMMERS (from Lat. *commercium*), the German term for the German students' social gatherings held annually on occasions such as the breaking-up of term and the anniversary of the university's founding. A Commers consists of speeches and songs and the drinking of unlimited quantities of beer. The arrangements are governed by officials (*Chargierte*) elected by the students from among themselves. Strict rules as to drinking exist, and the chairman after each speech calls for what is called a salamander (*ad exercitium Salamandris bibite, tergite*). All rise and having emptied their glasses hammer three times on the table with them. On the death of a student, his memory is honoured with a salamander, the glasses being broken to atoms at the close.

COMMINES, PHILIPPE DE (c. 1445–c. 1511), French historian, called the father of modern history, was born at the castle of Renescure, near Hazebrouck in Flanders, a little earlier than 1447. He lost both father and mother in his earliest years. In 1463 his godfather, Philip V., duke of Burgundy, summoned him to his court, and soon after transferred him to the household of his son, afterwards known as Charles the Bold. He speedily acquired considerable influence over Charles, and in 1468 was appointed chamberlain and councillor; consequently when in the same year Louis XI. was entrapped at Péronne, Commines was able both to soften the passion of Charles and to give useful advice to the king, whose life he did much to save. Three years later he was charged with an embassy to Louis, who gained him over to himself by many brilliant promises, and in 1472 he left Burgundy for the court of France. He was at once made chamberlain and councillor; a pension of 6000 livres was bestowed on him; he received the principality of Talmont, the confiscated property of the Amboise family, over which the family of La Trémoille claimed to have rights. The king arranged his marriage with Hélène de Chambes, who brought him the fine lordship of Argenton, and Commines took the name d'Argenton from then (27th of January 1473). He was employed to carry out the intrigues of Louis in Burgundy, and spent several months as envoy in Italy. On his return he was received with the utmost favour, and in 1479 obtained a decree confirming him in possession of his principality.

On the death of Louis in 1483 a suit was commenced against Commines by the family of La Trémoille, and he was cast in heavy damages. He plotted against the regent, Anne of Beaujeu, and joined the party of the duke of Orleans, afterwards Louis XII. Having attempted to carry off the king, Charles VIII., and so free him from the tutelage of his sister, he was arrested, and put in one of his old master's iron cages at Loches. In 1489 he was banished to one of his own estates for ten years, and made to give bail to the amount of 10,000 crowns of gold for his good behaviour. Recalled to the council in 1492, he strenuously opposed the Italian expedition of Charles VIII., in which, however, he took part, notably as representing the king in the negotiations which resulted in the treaty of Vercelli. During the rest of his life, notwithstanding the accession of Louis XII., whom he had served as duke of Orleans, he held no position of importance; and his last days were disturbed by lawsuits. He died at Argenton on the 18th of October, probably in 1511. His wife Hélène de Chambes survived him till 1532; their tomb is now in the Louvre.

The *Memoirs* to which Commines owes his reputation as a

statesman and man of letters, were written during his latter years. The graphic style of his narrative and above all the keenness of his insight into the motives of his contemporaries, an insight undimmed by undue regard for principles of right and wrong, make this work one of the great classics of history. His portrait of Louis XI. remains unique, in that to such a writer was given such a subject. Scott in *Quentin Durward* gives an interesting picture of Commines, from whom he largely draws. Sainte-Beuve, after speaking of Commines as being in date the first truly modern writer, and comparing him with Montaigne, says that his history remains the definitive history of his time, and that from it all political history took its rise. None of this applause is undeserved, for the pages of Commines abound with excellences. He analyses motives and pictures manners; he delineates men and describes events; his reflections are pregnant with suggestiveness, his conclusions strong with the logic of facts.

The *Memoirs* divided themselves into two parts, the first from the reign of Louis XI., 1464–1483, the second on the Italian expedition and the negotiations at Venice leading to the Vercelli treaty, 1494–1495. The first part was written between 1489 and 1491, while Commines was at the château of Dreux, the second from 1495 to 1498. Seven MSS. are known, derived from a single holograph, and as this was undoubtedly badly written, the copies were inaccurate; the best is that which belonged to Anne de Polignac, niece of Commines, and it is the only one containing books vii. and viii.

The best edition of Commines is the one edited by B. de Mandrot and published at Paris in 1901–1903. For this edition the author used a manuscript hitherto unknown and more complete than the others, and in his introduction he gives an account of the life of Commines.

BIBLIOGRAPHY.—The *Memoirs* remained in MS. till 1524, when part of them were printed by Galliot du Pré, the remainder first seeing light in 1525. Subsequent editions were put forth by Denys Sauvage in 1552, by Denys Godefroy in 1649, and by Lenglet Dufresnoy in 1747. Those of Mademoiselle Dupont (1841–1848) and of M. de Chantelauze (1881) have many merits, but the best was given by Bernard de Mandrot *Memoirs de Philippe de Commines*, from the MS. of Anne de Polignac (1901). Various translations of Commines into English have appeared, from that of T. Danett in 1596 to that, based on the Dupont edition, which was printed in Bohn's series in 1855. (C. B. *)

COMMISSARIAT, the department of an army charged with the provision of supplies, both food and forage, for the troops. The supply of military stores such as ammunition is not included in the duties of a commissariat. In almost every army the duties of transport and supply are performed by the same corps of departmental troops.

COMMISSARY (from Med. Lat. *commissarius*, one to whom a charge or trust is committed), generally, a representative; e.g., the emperor's representative who presided in his absence over the imperial diet; and especially, an ecclesiastical official who exercises in special circumstances the jurisdiction of a bishop (*q.v.*); in the Church of England this jurisdiction is exercised in a Consistory Court (*q.v.*), except in Canterbury, where the court of the diocesan as opposed to the metropolitan jurisdiction of the archbishop is called a commissary court, and the judge is the commissary general of the city and diocese of Canterbury. When a see is vacant the jurisdiction is exercised by a "special commissary" of the metropolitan. Commissary is also a general military term for an official charged with the duties of supply, transport and finance of an army. In the 17th and 18th centuries the *commissaire des guerres*, or *Kriegskommissär* was an important official in continental armies, by whose agency the troops, in their relation to the civil inhabitants, were placed upon semi-political control. In French military law, *commissaires du gouvernement* represent the ministry of war on military tribunals, and more or less correspond to the British judge-advocate (see COURT-MARTIAL).

COMMISSION (from Lat. *commissio, committere*), the action of committing or entrusting any charge or duty to a person, and the charge or trust thus committed, and so particularly an authority, or the document embodying such authority, given to some person to act in a particular capacity. The term is thus applied to the

written authority to command troops, which the sovereign or president, as the ultimate commander-in-chief of the nation's armed forces, grants to persons selected as officers, or to the similar authority issued to certain qualified persons to act as justices of the peace. For the various commissions of assize see *ASSIZE*. The word is also used of the order issued to a naval officer to take the command of a ship of war, and when manned, armed and fully equipped for active service she is said to be "put in commission."

In the law of evidence (*q.v.*) the presence of witnesses may, for certain necessary causes, be dispensed with by the order of the court, and the evidence be taken by a commissioner. Such evidence in England is said to be "on commission" (see *R.S.C. Order XXXVII.*) Such causes may be illness, the intention of the witness to leave the country before the trial, residence out of the country or the like. Where the witness is out of the jurisdiction of the court, and his place of residence is a foreign country where objection is taken to the execution of a commission, or is a British colony or India, "letters of request" for the examination of the witness are issued, addressed to the head of the tribunal in the foreign country, or to the secretary of state for the colonies or for India.

Where the functions of an office are transferred from an individual to a body of persons, the body exercising these delegated functions is generally known as a commission and the members as commissioners; thus the office of lord high admiral of Great Britain is administered by a permanent board, the lords of the admiralty. Such a delegation may be also temporary, as where the authority under the great seal to give the royal assent to legislation is issued to lords commissioners. Similarly bodies of persons or single individuals may be specially charged with carrying out particular duties; these may be permanent, such as the Charity Commission or the Ecclesiastical and Church Estates Commission, or may be temporary, such as various international bodies of inquiry, like the commission which met in Paris in 1905 to inquire into the North Sea incident (see *DOGGER BANK*), or such as the various commissions of inquiry, royal, statutory or departmental, of which an account is given below.

A commission may be granted by one person to another to act as his agent, and particularly in business; thus the term is applied to that method of business in which goods are entrusted to an agent for sale, the remuneration being a percentage on the sales. This percentage is known as the "commission," and hence the word is extended to all remuneration which is based on a percentage on the value of the work done. The right of an agent to remuneration in the form of a "commission" is always founded upon an express or implied contract between himself and his principal. Such a contract may be implied from custom or usage, from the conduct of the principal or from the circumstances of the particular case. Such commissions are only payable on transactions directly resulting from agency and may be payable though the principal acquires no benefit. In order to claim remuneration an agent must be legally qualified to act in the capacity in which he claims remuneration. He cannot recover in respect of unlawful or wagering transactions, or in cases of misconduct or breach of duty.

Secret Commissions.—The giving of a commission, in the sense of a bribe or unlawful payment to an agent or employé in order to influence him in relation to his principal's or employer's affairs, has grown to considerable proportions in modern times; it has been rightly regarded as a gross breach of trust upon the part of employés and agents, inasmuch as it leads them to look to their own interests rather than to those of their employers. In order to suppress this bribing of employés the English legislature in 1906 passed the Prevention of Corruption Act, which enacts that if an agent corruptly accepts or obtains for himself or for any other person any gift or consideration as an inducement or reward for doing or forbearing to do any act or business, or for showing or forbearing to show favour or disfavour to any person in relation to his principal's affairs, he shall be guilty of a misdemeanour and shall be liable on conviction or indictment to imprisonment with or without hard labour for a term not exceeding two years, or to a

fine not exceeding £500, or to both, or on summary conviction to imprisonment not exceeding four months with or without hard labour or to a fine not exceeding £50, or both. The act also applies the same punishment to any person who corruptly gives or offers any gift or consideration to an agent. Also if a person knowingly gives an agent, or if an agent knowingly uses, any receipt, account or document with intent to mislead the principal, they are guilty of a misdemeanour and liable to the punishment already mentioned. For the purposes of the act "consideration" includes valuable consideration of any kind, and "agent" includes any person employed by or acting for another. No prosecution can be instituted without the consent of the attorney-general, and every information must be upon oath.

Legislation to the same effect has been adopted in Australia. A federal act was passed in 1905 dealing with secret commissions, and in the same year both Victoria and Western Australia passed drastic measures to prevent the giving or receiving corruptly of commissions. The Victorian act applies to trustees, executors, administrators and liquidators as well as to agents. Both the Victorian and the Western Australian acts enact that gifts to the parent, wife, child, partner or employer of an agent are to be deemed gifts to the agent unless the contrary is proved; also that the custom of any trade or calling is not in itself a defence to a prosecution.

Commissions of Inquiry, i.e. commissions for the purpose of eliciting information as to the operation of laws, or investigating particular matters, social, educational, &c., are distinguished, according to the terms of their appointment, as *royal, statutory and departmental*. A royal commission in England is appointed by the crown, and the commissions usually issue from the office of the executive government which they specially concern. The objects of the inquiry are carefully defined in the warrant constituting the commission, which is termed the "reference." The commissioners give their services gratuitously, but where they involve any great degree of professional skill compensation is allowed for time and labour. The expenses incurred are provided out of money annually voted for the purpose. Unless expressly empowered by act of parliament, a commission cannot compel the production of documents or the giving of evidence, nor can it administer an oath. A commission may hold its sittings in any part of the United Kingdom, or may institute and conduct experiments for the purpose of testing the utility of invention, &c. When the inquiry or any particular portion of it is concluded, a report is presented to the crown through the home department. All the commissioners, if unanimous, sign the report, but those who are unable to agree with the majority can record their dissent, and express their individual opinions, either in paragraphs appended to the report or in separately signed memoranda.

Statutory commissions are created by acts of parliament, and, with the exception that they are liable to have their proceedings questioned in parliament, have absolute powers within the limits of their prescribed functions and subject to the provisions of the act defining the same. Departmental commissions or committees are appointed either by a treasury minute or by the authority of a secretary of state, for the purpose of instituting inquiries into matters of official concern or examining into proposed changes in administrative arrangements. They are generally composed of two or more permanent officials of the department concerned in the investigation, along with a subordinate member of the administration. Reports of such committees are usually regarded as confidential documents.

A full account of the procedure in royal commissions will be found in A. Todd's *Parliamentary Government in England*, vol. ii.

COMMISSIONAIRE, the designation of an attendant, messenger or subordinate employé in hotels on the continent of Europe, whose chief duty is to attend at railway stations, secure customers, take charge of their luggage, carry out the necessary formalities with respect to it and have it sent on to the hotel. They are also employed in Paris as street messengers, light porters, &c. The Corps of Commissionaires, in England, is an association of pensioned soldiers of trustworthy character, founded in 1859 by Captain Sir Edward Walter, K.C.B. (1823-1904).

It was first started in a very small way, with the intention of providing occupation for none but wounded soldiers. The nucleus of the corps consisted of eight men, each of whom had lost a limb. The demand, however, for neat, uniformed, trusty men, to perform certain light duties, encouraged the founder to extend his idea, and the corps developed into a large self-supporting organization. In 1906 there were over 3000 members of the corps, more than 2000 of whom served in London. Out-stations were established in various large towns of the kingdom, and the corps extended its operations also to the colonies.

COMMISSIONER, in general an officer appointed to carry out some particular work, or to discharge the duty of a particular office; one who is a member of a commission (*q.v.*). In this sense the word is applied to members of a permanently constituted department of the administration, as civil service commissioners, commissioners of income tax, commissioners in lunacy, &c. It is also the title given to the heads of or important officials in various governmental departments, as commissioner of customs. In some British possessions in Africa and the Pacific the head of the government is styled high commissioner. In India a commissioner is the chief administrative official of a division which includes several districts. The office does not exist in Madras, where the same duties are discharged by a board of revenue, but is found in most of the other provinces. The commissioner comes midway between the local government and the district officer. In the regulation provinces the district officer is called a collector (*q.v.*), and in the non-regulation provinces a deputy-commissioner. In the former he must always be a member of the covenanted civil service, but in the latter he may be a military officer.

A chief commissioner is a high Indian official, governing a province inferior in status to a lieutenant-governorship, but in direct subordination to the governor-general in council. The provinces which have chief commissioners are the Central Provinces and Berar, the North-West Frontier Province and Coorg. The agent to the governor-general of Baluchistan is also chief commissioner of British Baluchistan, the agent to the governor-general of Rajputana is also chief commissioner of the British district of Ajmere-Merwara, and there is a chief commissioner of the Andaman and Nicobar islands. Several provinces, such as the Punjab, Oudh, Burma and Assam, were administered by chief commissioners before they were raised to the status of lieutenant-governorships (see **LIEUTENANT**).

A commissioner for oaths in England is a solicitor appointed by the lord chancellor to administer oaths to persons making affidavits for the purpose of any cause or matter. The Commissioner for Oaths Act 1889 (with an amending act 1891), amending and consolidating various other acts, regulates the appointment and powers of such commissioners. In most large towns the minimum qualification for appointment is six-years' continuous practice, and the application must be supported by two barristers, two solicitors and at least six neighbours of the applicant. The charge made by commissioners for every oath, declaration, affirmation or attestation upon honour is one shilling and sixpence; for marking each exhibit (a document or other thing sworn to in an affidavit and shown to a deponent when being sworn), one shilling.

COMMITMENT, in English law, a precept or warrant *in writing*, made and issued by a court or judicial officer (including, in cases of treason, the privy council or a secretary of state), directing the conveyance of a person named or sufficiently described therein to a prison or other legal place of custody, and his detention therein for a time specified, or until the person to be detained has done a certain act specified in the warrant, *e.g.* paid a fine imposed upon him on conviction. Its character will be more easily grasped by reference to a form now in use under statutory authority:—

In the county of A, Petty Sessional Division of B.

To each and all of the constables of the county of A and the governor of His Majesty's Prison at C.

E. F. hereinafter called the defendant has this day been convicted before the court of summary jurisdiction sitting at D.

(Here the conviction and adjudication is stated.)

You the said constables are hereby commanded to convey the defendant to the said prison, and there deliver him to the governor thereof together with this warrant: and you the governor of the said prison to receive the defendant into your custody and keep him to hard labour for the space of three calendar months.

Dated

Signature and seal of
a justice of the peace.

A commitment as now understood differs from "committal," which is the decision of a court to send a person to prison, and not the document containing the directions to executive and ministerial officers of the law which are consequent on the decision. An interval must necessarily elapse between the decision to commit and the making out of the warrant of commitment, during which interval the detention in custody of the person committed is undoubtedly legal. A commitment differs also from a warrant of arrest (*mandat d'amener*), in that it is not made until after the person to be detained has actually appeared, or has been summoned, before the court which orders committal, to answer to some charge.

If not always, at any rate since 1679, a warrant of commitment has been necessary to justify officers of the law in conveying a prisoner to gaol and a gaoler in receiving and detaining him there. It is ordinarily essential to a valid commitment that it should contain a specific statement of the particular cause of the detention ordered. To this the chief, if not the only exception, is in the case of commitments by order of either House of Parliament (May, *Parl. Pr.*, 11th ed., 63, 70, 90). Commitments by justices of the peace must be under their hands and seals. Commitments by a court of record if formally drawn up are under the seal of the court.

Every person in custody is entitled, under the Habeas Corpus Act 1679, to receive within six hours of demand from the officer in whose custody he is, a copy of any warrant of commitment under which he is detained, and may challenge its legality by application for a writ of habeas corpus.

So far as concerns the acts of justices and tribunals of limited jurisdiction, the stringency of the rules as to commitments is an important aid to the liberty of the subject.

In the case of superior courts no statutory forms of commitment exist, and the same formalities are not so strictly enforced. Committal of a person present in court for contempt of the court is enforced by his immediate arrest by the tipstaff as soon as committal is ordered, and he may be detained in prison on a memorandum of the clerk or registrar of the court while a formal order is being drawn up. And in the case of persons sentenced at assizes and quarter sessions the only written authority for enforcement is a calendar of the prisoners tried, on which the sentences are entered up, signed by the presiding judge.

Commitments are usually made by courts of criminal jurisdiction in respect of offences against the criminal law, but are also occasionally made as a punishment for disobedience to the orders made in a civil court, *e.g.* where a judgment debtor having means to pay refuses to satisfy the judgment debt, or in cases where the person committed has been guilty of a direct contempt of the court.

The expenses of executing a warrant of commitment, so far as not paid by the prisoner, are defrayed out of the parliamentary grants for the maintenance of prisons.

COMMITTEE (from *committé*, an Anglo-Fr. past participle of *commettre*, Lat. *committere*, to entrust; the modern Fr. equivalent *comité* is derived from the Eng.), a person or body of persons to whom something is "committed" or entrusted. The term is used of a person or persons to whom the charge of the body ("committee of the person") or of the property and business affairs ("committee of the estate") of a lunatic is committed by the court (see **INSANITY**). In this sense the English usage is to pronounce the word *commi-tee*. The more common meaning of "committee" (pronounced *committ-y*) is that of a body of persons elected or appointed to consider and deal with certain matters of business, specially or generally referred to it.

COMMODIANUS, a Christian Latin poet, who flourished about A.D. 250. The only ancient writers who mention him are Gennadius, presbyter of Massilia (end of 5th century), in his *De*

scriptoribus ecclesiasticis, and Pope Gelasius in *De libris recipiendis et non recipiendis*, in which his works are classed as *Apocryphi*, probably on account of certain heterodox statements contained in them. Commodianus is supposed to have been an African. As he himself tells us, he was originally a heathen, but was converted to Christianity when advanced in years, and felt called upon to instruct the ignorant in the truth. He was the author of two extant Latin poems, *Instructiones* and *Carmen apologeticum* (first published in 1852 by J. B. Pitra in the *Spicilegium Solesmense*, from a MS. in the Middlehill collection, now at Cheltenham, supposed to have been brought from the monastery of Bobbio). The *Instructiones* consist of 80 poems, each of which is an acrostic (with the exception of 60, where the initial letters are in alphabetical order). The initials of 80, read backwards, give Commodianus Mendicus Christi. The *Apologeticum*, undoubtedly by Commodianus, although the name of the author (as well as the title) is absent from the MS., is free from the acrostic restriction. The first part of the *Instructiones* is addressed to the heathens and Jews, and ridicules the divinities of classical mythology; the second contains reflections on Antichrist, the end of the world, the Resurrection, and advice to Christians, penitents and the clergy. In the *Apologeticum* all mankind are exhorted to repent, in view of the approaching end of the world. The appearance of Antichrist, identified with Nero and the Man from the East, is expected at an early date. Although they display fiery dogmatic zeal, the poems cannot be considered quite orthodox. To the classical scholar the metre alone is of interest. Although they are professedly written in hexameters, the rules of quantity are sacrificed to accent. The first four lines of the *Instructiones* may be quoted by way of illustration:

"Praefatio nostra viam erranti demonstrat,
Respectumque bonum, cum venerit sacculi meta,
Aeternum fieri, quod discredunt inscicia corda:
Ego similiter erravi tempore multo."

These *versus politici* (as they are called) show that the change was already passing over Latin which resulted in the formation of the Romance languages. The use of cases and genders, the construction of verbs and prepositions, and the verbal forms exhibit striking irregularities. The author, however, shows an acquaintance with Latin poets—Horace, Virgil, Lucretius.

The best edition of the text is by B. Dombart (Vienna, 1887), and a good account of the poems will be found in M. Manitius, *Geschichte der christlich-lateinischen Poesie* (1891), with bibliography, to which may be added G. Boissier, "Commodien," in the *Mélanges Renier* (1887); H. Brewer, *Kommodian von Gaza* (Paderborn, 1906); L. Vernier, "La Versification latine populaire en Afrique," in *Revue de philologie*, xv. (1891); and C. E. Freppel, *Commodien, Arnobe, Laclance* (1893). Teuffel-Schwabe, *Hist. of Roman Literature* (Eng. trans., 384), should also be consulted.

COMMODORE (a form of "commander"; in the 17th century the term "commandore" is used), a temporary rank in the British navy for an officer in command of a squadron. There are two kinds, one with and the other without a captain below him in his ship, the first holding the temporary rank, pay, &c., of a rear-admiral, the other that of captain. It is also given as a courtesy title to the senior officer of a squadron of more than three vessels. In the United States navy "commodore" was a courtesy title given to captains who had been in command of a squadron. In 1862 it was made a commissioned rank, but was abolished in 1899. The name is given to the president of a yacht club, as of the Royal Yacht Squadron, and to the senior captain of a fleet of merchant vessels.

COMMODUS, LUCIUS AELIUS AURELIUS (161–192), also called Marcus Antoninus, emperor of Rome, son of Marcus Aurelius and Faustina, was born at Lanuvium on the 31st of August 161. In spite of a careful education he soon showed a fondness for low society and amusement. At the age of fifteen he was associated by his father in the government. On the death of Aurelius, whom he had accompanied in the war against the Quadi and Marcomanni, he hastily concluded peace and hurried back to Rome (180). The first years of his reign were uneventful, but in 183 he was attacked by an assassin at the instigation of his sister

Lucilla and many members of the senate, which felt deeply insulted by the contemptuous manner in which Commodus treated it. From this time he became tyrannical. Many distinguished Romans were put to death as implicated in the conspiracy, and others were executed for no reason at all. The treasury was exhausted by lavish expenditure on gladiatorial and wild beast combats and on the soldiery, and the property of the wealthy was confiscated. At the same time Commodus, proud of his bodily strength and dexterity, exhibited himself in the arena, slew wild animals and fought with gladiators, and commanded that he should be worshipped as the Roman Hercules. Plots against his life naturally began to spring up. That of his favourite Perennis, praefect of the praetorian guard, was discovered in time. The next danger was from the people, who were infuriated by the dearth of corn. The mob repelled the praetorian guard, but the execution of the hated minister Cleander quieted the tumult. The attempt also of the daring highwayman Maternus to seize the empire was betrayed; but at last Eclectus the emperor's chamberlain, Laetus the praefect of the praetorians, and his mistress Marcia, finding their names on the list of those doomed to death, united to destroy him. He was poisoned, and then strangled by a wrestler named Narcissus, on the 31st of December 192. During his reign unimportant wars were successfully carried on by his generals Clodius Albinus, Pescennius Niger and Ulpius Marcellus. The frontier of Dacia was successfully defended against the Scythians and Sarmatians, and a tract of territory reconquered in north Britain. In 1874 a statue of Commodus was dug up at Rome, in which he is represented as Hercules—a lion's skin on his head, a club in his right and the apples of the Hesperides in his left hand.

See Aelius Lampridius, Herodian, and fragments in Dio Cassius; H. Schiller, *Geschichte der römischen Kaiserzeit*; J. Zürcher, "Commodus" (1868, in Büdinger's *Untersuchungen zur römischen Kaiser-geschichte*, a criticism of Herodian's account); Pauly-Wissowa, *Realencyclopädie*, ii. 2464 ff. (von Rohden); Heer, "Der historische Wert des Vita Commodi" (*Philologus*, Supplementband ix.).

COMMON LAW, like "civil law," a phrase with many shades of meaning, and probably best defined with reference to the various things to which it is opposed. It is contrasted with statute law, as law not promulgated by the sovereign body; with equity, as the law prevailing between man and man, unless when the court of chancery assumed jurisdiction; and with local or customary law, as the general law for the whole realm, tolerating variations in certain districts and under certain conditions. It is also sometimes contrasted with civil, or canon, or international law, which are foreign systems recognized in certain special courts only and within limits defined by the common law. As against all these contrasted kinds of law, it may be described broadly as the universal law of the realm, which applies wherever they have not been introduced, and which is supposed to have a principle for every possible case. Occasionally, it would appear to be used in a sense which would exclude the law developed by at all events the more modern decisions of the courts.

Blackstone divides the civil law of England into *lex scripta* or statute law, and *lex non scripta* or common law. The latter, he says, consists of (1) general customs, which are the common law strictly so called, (2) particular customs prevailing in certain districts, and (3) laws used in particular courts. The first is the law by which "proceedings and determinations in the king's ordinary courts of justice are guided and directed." That the eldest son alone is heir to his ancestor, that a deed is of no validity unless sealed and delivered, that wills shall be construed more favourably and deeds more strictly, are examples of common law doctrines, "not set down in any written statute or ordinance, but depending on immemorial usage for their support." The validity of these usages is to be determined by the judges—"the depositaries of the law, the living oracles who must decide in all cases of doubt, and who are bound by an oath to decide according to the law of the land." Their judgments are preserved as records, and "it is an established rule to abide by former precedents where the same points come again in litigation." The extraordinary deference paid to precedents is the source of the most striking peculiarities of the English common law. There

can be little doubt that it was the rigid adherence of the common law courts to established precedent which caused the rise of an independent tribunal administering justice on more equitable principles—the tribunal of the chancellor, the court of chancery. And the old common law courts—the king's bench, common pleas and exchequer—were always, as compared with the court of chancery, distinguished for a certain narrowness and technicality of reasoning. At the same time the common law was never a fixed or rigid system. In the application of old precedents to the changing circumstances of society, and in the development of new principles to meet new cases, the common law courts displayed an immense amount of subtlety and ingenuity, and a great deal of sound sense. The continuity of the system was not less remarkable than its elasticity. Two great defects of form long disfigured the English law. One was the separation of common law and equity. The Judicature Act of 1873 remedied this by merging the jurisdiction of all the courts in one supreme court, and causing equitable principles to prevail over those of the common law where they differ. The other is the overwhelming mass of precedents in which the law is embedded. This can only be removed by some well-conceived scheme of the nature of a code or digest; to some extent this difficulty has been overcome by such acts as the Bills of Exchange Act 1882, the Partnership Act 1890 and the Sale of Goods Act 1893.

The English common law may be described as a pre-eminently national system. Based on Saxon customs, moulded by Norman lawyers, and jealous of foreign systems, it is, as Bacon says, as mixed as the English language and as truly national. And like the language, it has been taken into other English-speaking countries, and is the foundation of the law in the United States.

COMMON LODGING-HOUSE, "a house, or part of a house, where persons of the poorer classes are received for gain, and in which they use one or more rooms in common with the rest of the inmates, who are not members of one family, whether for eating or sleeping" (*Langdon v. Broadbent*, 1877, 37 L.T. 434; *Booth v. Ferrell*, 1890, 25 Q.B.D. 87). There is no statutory definition of the class of houses in England intended to be included in the expression "common lodging-house," but the above definition is very generally accepted as embracing those houses which, under the Public Health and other Acts, must be registered and inspected. The provisions of the Public Health Act 1875 are that every urban and rural district council must keep registers showing the names and residences of the keepers of all common lodging-houses in their districts, the situation of every such house, and the number of lodgers authorized by them to be received therein. They may require the keeper to affix and keep undecorated and legible a notice with the words "registered common lodging-house" in some conspicuous place on the outside of the house, and may make by-laws fixing the number of lodgers, for the separation of the sexes, for promoting cleanliness and ventilation, for the giving of notices and the taking of precautions in case of any infectious disease, and generally for the well ordering of such houses. The keeper of a common lodging-house is required to limewash the walls and ceilings twice a year—in April and October—and to provide a proper water-supply. The whole of the house must be open at all times to the inspection of any officer of a council. The county of London (except the city) is under the Common Lodging Houses Acts 1851 and 1853, with the Sanitary Act 1866 and the Sanitary Law Amendment Act 1874. The administration of these acts was, from 1851 to 1894, in the hands of the chief commissioner of police, when it was transferred to the London County Council.

COMMON ORDER, BOOK OF, sometimes called *The Order of Geneva* or *Knox's Liturgy*, a directory for public worship in the Reformed Church in Scotland. In 1557 the Scottish Protestant lords in council enjoined the use of the English Common Prayer, i.e. the Second Book of Edward VI. Meanwhile, at Frankfort, among British Protestant refugees, a controversy was going on between the upholders of the English liturgy and the French Reformed Order of Worship respectively. By way of compromise John Knox and other ministers drew up a new liturgy based upon earlier Continental Reformed Services,

which was not deemed satisfactory, but which on his removal to Geneva he published in 1556 for the use of the English congregations in that city. The Geneva book made its way to Scotland, and was used here and there by Reformed congregations. Knox's return in 1559 strengthened its position, and in 1562 the General Assembly enjoined the uniform use of it as the "Book of Our Common Order" in "the administration of the Sacraments and solemnization of marriages and burials of the dead." In 1564 a new and enlarged edition was printed in Edinburgh, and the Assembly ordered that "every Minister, exhorter and reader" should have a copy and use the Order contained therein not only for marriage and the sacraments but also "in Prayer," thus ousting the hitherto permissible use of the Second Book of Edward VI. at ordinary service. "The rubrics as retained from the Book of Geneva made provision for an extempore prayer before the sermon, and allowed the minister some latitude in the other two prayers. The forms for the special services were more strictly imposed, but liberty was also given to vary some of the prayers in them. The rubrics of the Scottish portion of the book are somewhat stricter, and, indeed, one or two of the Geneva rubrics were made more absolute in the Scottish emendations; but no doubt the 'Book of Common Order' is best described as a discretionary liturgy."

It will be convenient here to give the contents of the edition printed by Andrew Hart at Edinburgh in 1611, and described (as was usually the case) as *The Psalmes of David in Meeter, with the Prose, whereunto is added Prayers commonly used in the Kirke, and private houses; with a perpetuall Kalendar and all the Changes of the Moone that shall happen for the space of Six Yeeres to come*. They are as follows:—

(i.) The Calendar; (ii.) The names of the Faires of Scotland; (iii.) The Confession of Faith used at Geneva and received by the Church of Scotland; (iv.-vii.) Concerning the election and duties of Ministers, Elders and Deacons, and Superintendent; (viii.) An order of Ecclesiastical Discipline; (ix.) The Order of Excommunication and of Public Repentance; (x.) The Visitation of the Sick; (xi.) The Manner of Burial; (xii.) The Order of Public Worship—Forms of Confession and Prayer after Sermon; (xiii.) Other Public Prayers; (xiv.) The Administration of the Lord's Supper; (xv.) The Form of Marriage; (xvi.) The Order of Baptism; (xvii.) A Treatise on Fasting with the order thereof; (xviii.) The Psalmes of David; (xix.) Conclusions or Doxologies; (xx.) Hymns—metrical versions of the Decalogue, Magnificat, Apostles' Creed, &c.; (xxi.) Calvin's Catechism; (xxii. and xxiii.) Prayers for Private Houses and Miscellaneous Prayers, e.g. for a man before he begins his work.

The Psalmes and Catechism together occupy more than half the book. The chapter on burial is significant. In place of the long office of the Catholic Church we have simply this statement:—"The corpse is reverently brought to the grave, accompanied with the Congregation, without any further ceremonies: which being buried, the Minister (if he be present and required) goeth to the Church, if it be not far off, and maketh some comfortable exhortation to the people, touching death and resurrection." This (with the exception of the bracketed words) was taken over from the Book of Geneva. The Westminster Directory which superseded the Book of Common Order also enjoins interment "without any ceremony," such being stigmatized as "no way beneficial to the dead and many ways hurtful to the living." Civil honours may, however, be rendered.

Revs. G. W. Sprott and Thomas Leishman, in the introduction to their edition of the Book of Common Order, and of the Westminster Directory published in 1868, collected a valuable series of notices as to the actual usage of the former book for the period (1564-1645) during which it was enjoined by ecclesiastical law. Where ministers were not available suitable persons (often old priests, sometimes schoolmasters) were selected as readers. Good contemporary accounts of Scottish worship are those of W. Cowper (1568-1619), bishop of Galloway, in his *Seven Days' Conference between a Catholic Christian and a Catholic Roman* (c. 1615), and Alexander Henderson in *The Government and Order of the Church of Scotland* (1641). There was doubtless a good

deal of variety at different times and in different localities. Early in the 17th century under the twofold influence of the Dutch Church, with which the Scottish clergy were in close connexion, and of James I.'s endeavours to "juggle out" a liturgy which gave the liberty of "conceiving" prayers, ministers began in prayer to read less and extemporize more.

Turning again to the legislative history, in 1567 the prayers were done into Gaelic; in 1579 parliament ordered all gentlemen and yeomen holding property of a certain value to possess copies. The assembly of 1601 declined to alter any of the existing prayers but expressed a willingness to admit new ones. Between 1606 and 1618 various attempts were made under English and Episcopal influence, by assemblies afterwards declared unlawful, to set aside the "Book of Common Order." The efforts of James I., Charles I. and Archbishop Laud proved fruitless; in 1637 the reading of Laud's draft of a new form of service based on the English prayer book led to riots in Edinburgh and to general discontent in the country. The General Assembly of Glasgow in 1638 abjured Laud's book and took its stand again by the Book of Common Order, an act repeated by the assembly of 1639, which also demurred against innovations proposed by the English separatists, who objected altogether to liturgical forms, and in particular to the Lord's Prayer, the *Gloria Patri* and the minister kneeling for private devotion in the pulpit. An Aberdeen printer named Raban was publicly censured for having on his own authority shortened one of the prayers. The following years witnessed a counter attempt to introduce the Scottish liturgy into England, especially for those who in the southern kingdom were inclined to Presbyterianism. This effort culminated in the Westminster Assembly of divines which met in 1643, at which six commissioners from the Church of Scotland were present, and joined in the task of drawing up a Common Confession, Catechism and Directory for the three kingdoms. The commissioners reported to the General Assembly of 1644 that this Common Directory "is so begun . . . that we could not think upon any particular Directory for our own Kirk." The General Assembly of 1645 after careful study approved the new order. An act of Assembly on the 3rd of February and an act of parliament on the 6th of February ordered its use in every church, and henceforth, though there was no act setting aside the "Book of Common Order," the Westminster Directory was of primary authority. The Directory was meant simply to make known "the general heads, the sense and scope of the Prayers and other parts of Public Worship," and if need be, "to give a help and furniture." The act of parliament recognizing the Directory was annulled at the Restoration and the book has never since been acknowledged by a civil authority in Scotland. But General Assemblies have frequently recommended its use, and worship in Presbyterian churches is largely conducted on the lines of the Westminster Assembly's Directory.

The modern *Book of Common Order* or *Euchologion* is a compilation drawn from various sources and issued by the Church Service Society, an organization which endeavours to promote liturgical usages within the Established Church of Scotland.

COMMONPLACE, a translation of the Gr. *κοινὸς τόπος*, i.e. a passage or argument appropriate to several cases; a "common-place book" is a collection of such passages or quotations arranged for reference under general heads either alphabetically or on some method of classification. To such a book the name *adversaria* was given, which is an adaptation of the Latin *adversaria scripta*, notes written on one side, the side opposite (*adversus*), of a paper or book. From its original meaning the word came to be used as meaning something hackneyed, a platitude or truism, and so, as an adjective, equivalent to trivial or ordinary. It was first spelled as two words, then with a hyphen, and so still in the sense of a "common-place book."

COMMON PLEAS, COURT OF, formerly one of the three English common law courts at Westminster—the other two being the king's bench and exchequer. The court of common pleas was an offshoot of the Curia Regis or king's council. Previous to Magna Carta, the king's council, especially that portion of it which was charged with the management of judicial

and revenue business, followed the king's person. This, as far as private litigation was concerned, caused great inconvenience to the unfortunate suitors whose complaints awaited the attention of the court, for they had, of necessity, also to follow the king from place to place, or lose the opportunity of having their causes tried. Accordingly, Magna Carta enacted that common pleas (*communia placita*) or causes between subject and subject, should be held in some fixed place and not follow the court. This place was fixed at Westminster. The court was presided over by a chief (*capitalis justiciarius de communi banco*) and four puisne judges. The jurisdiction of the common pleas was, by the Judicature Act 1873, vested in the king's bench division of the High Court of Justice.

COMMONS,¹ the term for the lands held in commonalty, a relic of the system on which the lands of England were for the most part cultivated during the middle ages. The country was divided into vills, or townships—often, *Early history.* though not necessarily, or always, coterminous with the parish. In each stood a cluster of houses, a village, in which dwelt the men of the township, and around the village lay the arable fields and other lands, which they worked as one common farm. Save for a few small inclosures near the village—for gardens, orchards or paddocks for young stock—the whole township was free from permanent fencing. The arable lands lay in large tracts divided into compartments or fields, usually three in number, to receive in constant rotation the triennial succession of wheat (or rye), spring crops (such as barley, oats, beans or peas), and fallow. Low-lying lands were used as meadows, and there were sometimes pastures fed according to fixed rules. The poorest land of the township was left waste—to supply feed for the cattle of the community, fuel, wood for repairs, and any other commodity of a renewable or practically inexhaustible character.² This waste land is the common of our own days.

It would seem likely that at one time there was no division, as between individual inhabitants or householders, of any of the lands of the township, but only of the products. But so far back as accurate information extends the arable land is found to be parcelled out, each householder owning strips in each field. These strips are always long and narrow, and lie in sets parallel with one another. The plough for cultivating the fields was maintained at the common expense of the village, and the draught oxen were furnished by the householders. From the time when the crop was carried till the next sowing, the field lay open to the cattle of the whole vill, which also had the free run of the fallow field throughout the year. But when two of the three fields were under crops, and the meadows laid up for hay, it is obvious that the cattle of the township required some other resort for pasturage. This was supplied by the waste or common. Upon it the householder turned out the oxen and horses which he contributed to the plough, and the cows and sheep, which were useful in manuring the common fields,—in the words of an old law case: "horses and oxen to plough the land, and cows and sheep to compester it." Thus the use of the common by each householder was naturally measured by the stock which he kept for the service of the common fields; and when, at a later period, questions arose as to the extent of the rights on the common, the necessary practice furnished the rule, that the commoner could turn out as many head of cattle as he could keep by means of the lands which were parcelled out to him,—the rule of *levancy and couchancy*, which has come down to the present day.

In the earliest post-conquest times the vill or township is found to be associated with an over-lord. There has been much controversy on the question, whether the vill originally owned its lands free from any control, and was subse- *Status of township.* quently reduced to a state of subjection and to a large extent deprived of its ownership, or whether its whole history has been one of gradual emancipation, the ownership of the waste,

¹ For the commons (*communitates*) in a socio-political sense see REPRESENTATION and PARLIAMENT.

² There is an entry on the court rolls of the manor of Wimbledon of the division amongst the inhabitants of the vill of the crab-apples growing on the common.

or common now ascribed by the law to the lord being a remnant of his ownership of all the lands of the vill. (See MANOR.)

At whatever date the over-lord first appeared, and whatever may have been the personal relations of the villagers to him from time to time after his appearance, there can be hardly any doubt that the village lands, whether arable, meadow or waste, were substantially the property of the villagers for the purposes of use and enjoyment. They resorted freely to the common for such purposes as were incident to their system of agriculture, and regulated its use amongst themselves. The idea that the common was the "lord's waste," and that he had the power to do what he liked with it, subject to specific and limited qualifying rights in others, was, there is little doubt, the creation of the Norman lawyers.

One of the earliest assertions of the lord's proprietary interest in waste lands is contained in the Statute of Merton, a statute which, it is well to notice, was passed in one of the first assemblies of the barons of England, before the commons of the realm were summoned to parliament. This statute, which became law in the year 1235, provided "that the great men of England (which had enfeoffed knights and their freeholders of small tenements in their great manors)" might "make their profit of their lands, wastes, woods and pastures," if they left sufficient pasture for the service of the tenements they had granted. Some fifty years later, another statute, that of Westminster the Second, supplemented the Statute of Merton by enabling the lord of the soil to inclose common lands, not only against his own tenants, but against "neighbours" claiming pasture there. These two pieces of legislation undoubtedly mark the growth of the doctrine which converted the over-lord's territorial sway into property of the modern kind, and a corresponding loosening of the hold of the rural townships on the wastes of their neighbourhood. To what extent the two acts were used, it is very difficult to say. We know, from later controversies, that they made no very great change in the system on which the country was cultivated, a system to which, as we have seen, commons were essential. In some counties, indeed, inclosures had, by the Tudor period, made greater progress than in others. T. Tusser, in his eulogium on inclosed farming, cites Suffolk and Essex as inclosed counties by way of contrast to Norfolk, Cambridgeshire and Leicestershire, where the open or "champion" (champain) system prevailed. The Statutes of Merton and Westminster may have had something to do with the progress of inclosed farming; but it is probable that their chief operation lay in furnishing the lord of the manor with a farm on the new system, side by side with the common fields, or with a deer park.

The first event which really endangered the village system was the coming of the Black Death. This scourge is said to have swept away half the population of the country. The disappearance, by no means uncommon, of a whole family gave the over-lord of the vill the opportunity of appropriating, by way of escheat, the holding of the household in the common fields. The land-holding population of the townships and the persons interested in the commons were thus sensibly diminished.

During the Wars of the Roses the small cultivator is thought to have again made headway. But his diminished numbers, and the larger interest which the lords had acquired in the lands of each vill, no doubt facilitated the determined attack on the common-field system which marked the reigns of Henry VIII. and Edward VI.

This attack, which had for its chief object the conversion of arable land into pasture for the sake of sheep-breeding, was the outcome of many causes. It was no longer of importance to a territorial magnate to possess a large body of followers pledged to his interests by their connexion with the land. On the other hand, wool commanded a high price, and the growth of towns and of foreign commerce supplied abundant markets. At the same time the confiscation of the monastic possessions introduced a race of new over-lords—not bound to their territories by any family traditions, and also tended to spread the view that the strong

hand was its own justification. In order to keep large flocks and send many bales of wool to market, each landowner strove to increase his range of pasture, and with this view to convert the arable fields of his vill into grass land. There is abundant evidence both from the complaints of writers such as Latimer and Sir Thomas More, and from the Statutes and royal commissions of the day, that large inclosures were made at this time, and that the process was effected with much injustice and accompanied by great hardship. "Where," says Bishop Latimer in one of his courageous and vigorous denunciations of "inclosers and rent-raisers," "there have been many householders and inhabitants, there is now but a shepherd and his dog." In the full tide of this movement, and despite Latimer's appeals, the Statutes of Merton and Westminster the Second were confirmed and re-enacted. Both common fields and commons no doubt disappeared in many places; and the country saw the first notable instalment of inclosure. But from the evidence of later years it is clear that a very large area of the country was still cultivated on the common-field system for another couple of centuries. When inclosure on any considerable scale again came into favour, it was effected on quite different principles; and before describing what was essentially a modern movement, it will be convenient to give a brief outline of the principles of law applicable to commons at the present day.

Law.—The distinguishing feature in law of common land is, that it is land the soil of which belongs to one person, and from which certain other persons take certain profits—for example, the bite of the grass by the mouth of cattle, or gorse, bushes or heather for fuel or litter. The right to take such a profit is a right of common; the right to feed cattle on common land is a right of common of pasture; while the right of cutting bushes, gorse or heather (more rarely of lopping trees) is known as a right of common of *estovers* (*estouviers*) or *boles* (respectively from the Norman-French *estouffer*, and the Saxon *botan*, to furnish). Another right of common is that of *turbary*, or the right to cut turf or peat for fuel. There are also rights of taking sand, gravel or loam for the repair and maintenance of land. The persons who enjoy any of these rights are called commoners.

From the sketch of the common-field system of agriculture which has been given, we shall readily infer that a large proportion of the commons of the country, and of the peculiarities of the law relating to commons, are traceable to that system. Thus, common rights are mostly attached to, or enjoyed with, certain lands or houses. A right of common of pasture usually consists of the right to turn out as many cattle as the farm or other private land of the commoner can support in winter; for, as we have seen, the enjoyment of the common, in the village system, belonged to the householders of the village, and was necessarily measured by their holdings in the common fields. The cattle thus commonable are said to be *levant* and *couchant*, i.e. uprising and down-lying on the land. But it has now been decided that they need not in fact be so kept. At the present day a commoner may turn out any cattle belonging to him, wherever they are kept, provided they do not exceed in number the head of cattle which can be supported by the stored summer produce of the land in respect of which the right is claimed, together with any winter herbage it produces. The animals which a commoner may usually turn out are those which were employed in the village system—horses, oxen, cows and sheep. These animals are termed commonable animals. A right may be claimed for other animals, such as donkeys, pigs and geese; but they are termed non-commonable, and the right can only be established on proof of special usage. A right of pasture attached to land in the way we have described is said to be *appendant* or *appurtenant* to such land. Common of pasture appendant to land can only be claimed for commonable cattle; and it is held to have been originally attached only to arable land, though in claiming the right no proof that the land was originally arable is necessary. This species of common right is, in fact, the direct survival of the use by the village householder of the common of the township; while common of pasture appurtenant

Statutes of Merton and Westminster the Second.

Rights of common.

The Black Death.

The Tudor agrarian revolution.

represents rights which grew up between neighbouring townships, or, in later times, by direct grant from the owner of the soil of the common to some other landowner, or (in the case of copyholders) by local custom.

The characteristic of connexion with house or land also marks other rights of common. Thus a right of taking gorse or bushes, or of lopping wood for fuel, called *fire-bote*, is limited to the taking of such fuel as may be necessary for the hearths of a particular house, and no more may be taken than is thus required. The same condition applies to common of *turbary*, which in its more usual form authorizes the commoner to cut the heather, which grows thickly upon poor soils, with the roots and adhering earth, to a depth of about 9 in. Similarly, wood taken for the repairs of buildings (*house-bote*), or of hedges (*hedge-bote* or *hey-bote*), must be limited in quantity to the requirements of the house, farm buildings and hedges of the particular property to which the right is attached. And heather taken for litter cannot be taken in larger quantities than is necessary for manuring the lands in respect of which the right is enjoyed. It is illegal to take the wood or heather from the common, and to sell it to any one who has not himself a right to take it. So, also, a right of digging sand, gravel, clay or loam is usually appurtenant to land, and must be exercised with reference to the repair of the roads, or the improvement of the soil, of the particular property to which the right is attached.

We have already alluded to the fact that, in Norman and later days, every vill or township was associated with some over-lord,—some one responsible to the crown, either directly or through other superior lords, for the holding of the land and the performance of certain duties of defence and military support. To this lord the law has assigned the ownership of the soil of the common of the vill; and the common has for many centuries been styled the waste of the manor. The trees and bushes on the common belong to the lord, subject to any rights of lopping or cutting which the commoners may possess. The ground, sand and subsoil are his, and even the grass, though the commoners have the right to take it by the mouths of their cattle. To the over-lord, also, was assigned a seignory over all the other lands of the vill; and the vill came to be termed his manor. At the present day it is the manorial system which must be invoked in most cases as the foundation of the curiously conflicting rights which co-exist on a common. (See MANOR.)

Within the bounds of a manor, speaking generally, there are three classes of persons possessing an interest in the land, viz. :—

(a) Persons holding land freely of the manor, or freehold tenants.

(b) Persons holding land of the manor by copy of court roll, or copyhold tenants.

(c) Persons holding from the lord of the manor, by lease or agreement, or from year to year, land which was originally demesne, or which was once freehold or copyhold and has come into the lord's hands by escheat or forfeiture.

Amongst the first two classes we usually find the majority of the commoners on the wastes or commons of the manor. To every freehold tenant belongs a right of common of pasture on the commons, such right being "appendant" to the land which he holds freely of the manor. This right differs from most other rights of common in the characteristic that actual exercise of the right need not be proved. When once it is shown that certain land is held freely of the manor, it follows of necessity that a right of common of pasture for commonable cattle attaches to the land, and therefore belongs to its owner, and may be exercised by its occupant. "Common appendant," said the Elizabethan judges, "is of common right, and commences by operation of law and in favour of tillage."

Now this is exactly what we saw to be the case with reference to the use of the common of the vill by the householder cultivating the arable fields. The use was a necessity, not depending upon the habits of this or that householder; it was a use for commonable cattle only, and was connected with the tillage of the arable lands. It seems almost necessarily to follow that the freehold

tenants of the manor are the representatives of the householders of the vill. However this may be, it is amongst the freehold tenants of the manor that we must first look for commoners on the waste of the manor.

Owing, however, to the light character of the services rendered by the freeholders, the connexion of their lands with the manor is often difficult to prove. Copyhold tenure, on the other hand, cannot be lost sight of; and in many manors copyholders are numerous, or were, till quite recently. Copyholders almost invariably possess a right of common on the waste of the manor; and when (as is usual) they exist side by side with freeholders, their rights are generally of the same character. They do not, however, exist as of common right, without proof of usage, but by the custom of the manor. Custom has been defined by a great judge (Sir George Jessel, M.R., in *Hammerton v. Honey*) as local law. Thus, while the freehold tenants enjoy their rights by the general law of the land, the copyholders have a similar enjoyment by the local law of the manor. This, again, is what one might expect from the ancient constitution of a village community. The copyholders, being originally serfs, had no rights at law; but as they had a share in the tillage of the land, and gradually became possessed of strips in the common fields, or of other plots on which they were settled by the lord, they were admitted by way of indulgence to the use of the common; and the practice hardened into a custom. As might be expected, there is more variety in the details of the rights they exercise. They may claim common for cattle which are not commonable, if the custom extends to such cattle; and their claim is not necessarily connected with arable land.

In the present day large numbers of copyhold tenements have been enfranchised, *i.e.* converted into freehold. The effect of this step is to sever all connexion between the land enfranchised and the manor of which it was previously held. Technically, therefore, the common rights previously enjoyed in respect of the land would be gone. When, however, there is no indication of any intention to extinguish such rights, the courts protect the copyholders in their continued enjoyment; and when an enfranchisement is effected under the statutes passed in modern years, the rights are expressly preserved. The commoners on a manorial common then will be, *prima facie*, the freeholders and copyholders of the manor, and the persons who own lands which were copyhold of the manor but have been enfranchised.

The occupants of lands belonging to the lord of the manor, though they usually turn out their cattle on the common, do so by virtue of the lord's ownership of the soil of the common, and can, as a rule, make no claim to any right of common as against the lord, even though the practice of turning out may have obtained in respect of particular lands for a long series of years. When, however, lands have been sold by the lord of the manor, although no right of common attached by law to such lands in the lord's hands, their owners may subsequently enjoy such a right, if it appears from the language of the deeds of conveyance, and all the surrounding circumstances, that there was an intention that the use of the common should be enjoyed by the purchaser. The rules on this point are very technical; it is sufficient here to indicate that lands bought from a lord of a manor are not necessarily destitute of common rights.

So far we have considered common rights as they have arisen out of the manorial system, and out of the still older system of village communities. There may, however, be rights of common quite unconnected with the manorial system. Such rights may be proved either by producing a specific grant from the owner of the manor or by long usage. It is seldom that an actual grant is produced, although it would seem likely that such grants were not uncommon at one time. But a claim founded on actual user is by no means unusual. Such a claim may be based (a) on immemorial usage, *i.e.* usage for which no commencement later than the coronation of Richard I. (1189) can be shown, (b) on a presumed modern grant which has been lost, or (c) (in some cases) on the Prescription Act 1832. There are special rules applicable to each kind of claim.

Rights of common not connected with manorial system.

A right of common not connected with the manorial system may be, and usually is, attached to land; it may be measured, like a manorial right, by levancy and couchancy, or it may be limited to a fixed number of animals. Rights of the latter character seem to have been not uncommon in the middle ages. In one of his sermons against inclosure, Bishop Latimer tells us his father "had walk (*i.e.* right of common) for 100 sheep." This may have been a right in gross, but was more probably attached to the "farm of £3 or £4 by year at the uttermost" which his father held. A right of common appurtenant may be sold separately, and enjoyed by a purchaser independently of the tenement to which it was originally appurtenant. It then becomes a right of common in gross.

A right of common in gross is a right enjoyed irrespective of the ownership or occupancy of any lands. It may exist by express grant, or by user implying a modern lost grant, or by immemorial usage. It must be limited to a certain number of cattle, unless the right is claimed by actual grant. Such rights seldom arise in connexion with commons in the ordinary sense, but are a frequent incident of regulated or stinted pastures; the right is then generally known as a cattle-gate or beast-gate.

There may be rights over a common which exclude the owner of the soil from all enjoyment of some particular product of the common. Thus a person, or a class of persons, may be entitled to the whole of the corn, grass, underwood, or sweepage, (*i.e.* everything which falls to the sweep of the scythe) of a tract of land, without possessing any ownership in the land itself, or in the trees or mines. Such a right is known as a right of sole vesture.

A more limited right of the same character is a right of sole pasturage—the exclusive right to take everything growing on the land in question by the mouths of cattle, but not in any other way. Either of these rights may exist throughout the whole year, or during part only. A right of sole common pasturage and herbage was given to a certain class of commoners in Ashdown Forest on the partition of the forest at the end of the 18th century.

We have seen that the common arable fields and common meadows of a vill were thrown open to the stock of the community between harvest and seed-time. There is still to be found, here and there, a group of arable common fields, and occasionally a piece of grass land with many of the characteristics of a common, which turns out to be a common field or meadow. The Hackney Marshes and the other so-called commons of Hackney are really common fields or common meadows, and along the valley of the Lea a constant succession of such meadows is met with. They are still owned in parcels marked by metes; the owners have the right to grow a crop of hay between Lady day and Lammas day; and from Lammas to March the lands are subject to the depasturage of stock. In the case of some common fields and meadows the right of feed during the open time belongs exclusively to the owners; in others to a larger class, such as the owners and occupiers of all lands within the bounds of the parish. Anciently, as we have seen, the two classes would be identical. In some places newcomers not owning strips in the fields were admitted to the right of turn out; in others, not. Hence the distinction. Similar divergences of practice will be found to exist in Switzerland at the present day; *nieder-glassene*, or newcomers, are in some communes admitted to all rights, while, in others, privileges are reserved to the *bürger*, or old inhabitant householders.

Some of the largest tracts of waste land to be found in England are the waste or commonable lands of royal forests or chases.

The thickets and pastures of Epping Forest, now happily preserved for London under the guardianship of the city corporation, and the noble woods and far-stretching heaths of the New Forest, will be called to mind. Cannock Chase, unhappily inclosed according to law, though for the most part still lying waste, Dartmoor, and Ashdown Forest in Sussex, are other instances; and the list might be greatly lengthened. Space will not permit of any

description of the forest system; it is enough, in this connexion, to say that the common rights in a forest were usually enjoyed by the owners and occupiers of land within its bounds (the class may differ in exact definition, but is substantially equivalent to this) without reference to manorial considerations. Epping Forest was saved by the proof of this right. It is often said that the right was given, or confirmed, to the inhabitants in consideration of the burden of supporting the deer for the pleasure of the king or of the owner of the chase. It seems more probable that the forest law prevented the growth of the manorial system, and with it those rules which have tended to restrict the class of persons entitled to enjoy the waste lands of the district.

We have seen that in the case of each kind of common there is a division of interest. The soil belongs to one person; other persons are entitled to take certain products of the soil. This division of interest preserves the common as an open space. The commoners cannot inclose, because the land does not belong to them. The owner of the soil cannot inclose, because inclosure is inconsistent with the enjoyment of the commoners' rights. At a very early date it was held that the right of a commoner proceeded out of every part of the common, so that the owner of the soil could not set aside part for the commoner and inclose the rest. The Statutes of Merton and Westminster the Second were passed to get over this difficulty. But under these statutes the burden of proving that sufficient pasture was left was thrown upon the owner of the soil; such proof can very seldom be given. Moreover, the statutes have never enabled an inclosure to be made against commoners entitled to *cstovers* or *turbary*. It seems clear that the statutes had become obsolete in the time of Edward VI., or they would not have been re-enacted. And we know that the zealous advocates of inclosure in the 18th century considered them worthless for their purposes. Practically it may be taken that, save where the owner of the soil of a common acquires all the lands in the township (generally coterminous with the parish) with which the common is connected, an inclosure cannot legally be effected by him. And even in the latter case it may be that rights of common are enjoyed in respect of lands outside the parish, and that such rights prevent an inclosure.

Modern Inclosure.—When, therefore, the common-field system began to fall out of gear, and the increase of population brought about a demand for an increased production of corn, it was felt to be necessary to resort to parliament for power to effect inclosure. The legislation which ensued was based on two principles. One was that all persons interested in the open land to be dealt with should receive a proportionate equivalent in inclosed land; the other, that inclosure should not be prevented by the opposition, or the inability to act, of a small minority. Assuming that inclosure was desirable, no more equitable course could have been adopted, though in details particular acts may have been objectionable. The first act was passed in 1709; but the precedent was followed but slowly, and not till the middle of the 18th century did the annual number of acts attain double figures. The high-water mark was reached in the period from 1765 to 1785, when on an average forty-seven acts were passed every year. From some cause, possibly the very considerable expense attending upon the obtaining of an act, the numbers then began slightly to fall off. In the year 1793 a board of agriculture, apparently similar in character to the chambers of commerce of our own day, was established. Sir John Sinclair was its president, and Arthur Young, the well-known agricultural reformer, was its secretary. Owing to the efforts of this body, and of a select committee appointed by the House of Commons on Sinclair's motion, the first General Inclosure Act was passed in 1801. This act would at the present day be called an Inclosure Clauses Act. It contained a number of provisions applicable to inclosures, which could be incorporated by reference, in a private bill. By this means, it was hoped, the length and complexity, and consequently the expense, of inclosure bills would be greatly diminished. Under the stimulus thus applied inclosure proceeded apace. In the year 1801 no less than 119 acts were passed, and the total

Prevention of Inclosure.

The modern Inclosure Act.

Rights in common fields.

Rights in royal forests.

area inclosed probably exceeded 300,000 acres. Three inclosures in the Lincolnshire Fens account for over 53,000 acres. As before, the movement after a time spent its force, the annual average of acts falling to about twelve in the decade 1830-1840. Another parliamentary committee then sat to consider how inclosure might be promoted; and the result was the Inclosure Act 1845, which, though much amended by subsequent legislation, still stands on the statute-book. The chief feature of that act was the appointment of a permanent commission to make in each case all the inquiries previously made (no doubt capriciously and imperfectly) by committees of the two Houses. The commission, on being satisfied of the propriety of an inclosure was to draw up a provisional order prescribing the general conditions on which it was to be carried out, and this order was to be submitted to parliament by the government of the day for confirmation. It is believed that these inclosure orders afford the first example of the provisional order system of legislation, which has attained such large proportions.

Again inclosure moved forward, and between 1845 and 1869 (when it received a sudden check) 600,000 acres passed through the hands of the inclosure commission. Taking the whole period of about a century and a half, when parliamentary inclosure was in favour, and making an estimate of acreage where the acts do not give it, the result may be thus summarized:—

	Acres.
From 1709 to 1797	2,744,926
„ 1801 to 1842	1,307,964
„ 1845 to 1869	618,000
Add for Forests inclosed under Special Acts	100,000
	<hr/>
	4,770,890

The total area of England being 37,000,000 acres, we shall probably not be far wrong in concluding that about one acre in every seven was inclosed during the period in question. During the first period, the lands inclosed consisted mainly of common arable fields; during the second, many great tracts of moor and fen were reduced to severalty ownership. In the third period, inclosure probably related chiefly to the ordinary manorial common; and it seems likely that, on the whole, England would have gained, had inclosure stopped in 1845.

As a fact it stopped in 1869. Before the inclosure commission had been in existence twenty years the feeling of the nation towards commons began to change. The rapid growth of towns, and especially of London, and the awakening sense of the importance of protecting the public health, brought about an appreciation of the value of commons as open spaces. Naturally, the metropolis saw the birth of this sentiment. An attempted inclosure in 1864 of the commons at Epsom and Wimbledon aroused strong opposition; and a select committee of the House of Commons was appointed to consider how the London commons could best be preserved. The Metropolitan Board of Works, then in the vigour of youth, though eager to become the open-space authority for London, could make no better suggestion than that all persons interested in the commons should be bought out, that the board should defray the expense by selling parts for building, and should make parks of what was left. Had this advice been followed, London would probably have lost two-thirds of the open space which she now enjoys. Fortunately a small knot of men, who afterwards formed the Commons Preservation Society, took a broader and wiser view. Chief amongst them were the late Philip Lawrence, who acted as solicitor to the Wimbledon opposition, and subsequently organized the Commons Preservation Society, George Shaw-Lefevre, chairman of that society since its foundation, the late John Locke, and the late Lord Mount Temple (then Mr W. F. Cowper). They urged that the conflict of legal interests, which is the special characteristic of a common, might be trusted to preserve it as an open space, and that all that parliament could usefully do, was to restrict parliamentary inclosure, and to pass a measure of police for the protection of commons as open spaces. The select committee adopted this view. On their report, was passed the Metropolitan Commons Act 1866, which prohibited any further parliamentary inclosures within the

metropolitan police area, and provided means by which a common could be put under local management. The lords of the manors in which the London commons lay felt that their opportunity of making a rich harvest out of land, valuable for building, though otherwise worthless, was slipping away; and a battle royal ensued. Inclosures were commenced, and the Statute of Merton prayed in aid. The public retorted by legal proceedings taken in the names of commoners. These proceedings—which culminated in the mammoth suit as to Epping Forest, with the corporation of London as plaintiffs and fourteen lords of manors as defendants—were uniformly successful; and London commons were saved. By degrees the manorial lords, seeing that they could not hope to do better, parted with their interest for a small sum to some local authority; and a large area of the common land, not only in the county of London, but in the suburbs, is now in the hands of the representatives of the ratepayers, and is definitely appropriated to the recreation of the public.

Moreover, the Commons Preservation Society was able to base, upon the uniform success of the commoners in the law courts, a plea for the amendment of the law. The Statute of Merton, we have seen, purports to enable the lord of the soil to inclose a common, if he leaves sufficient pasture for the commoners. This statute was constantly vouched in the litigation about London commons; but in no single instance was an inclosure justified by virtue of its provisions. It thus remained a trap to lords of manors, and a source of controversy and expense. In the year 1893 Lord Thring, at the instance of the Commons Preservation Society, carried through parliament the Commons Law Amendment Act, which provided that in future no inclosure under the Statute of Merton should be valid, unless made with the consent of the Board of Agriculture, which was to consider the expediency of the inclosure from a public point of view.

The movement to preserve commons as open spaces soon spread to the rural districts. Under the Inclosure Act of 1845 provision was made for the allotment of a part of the land to be inclosed for field gardens for the labouring poor, and for recreation. But those who were interested in effecting an inclosure often convinced the inclosure commissioners that for some reason such allotments would be useless. To such an extent did the reservation of such allotments become discredited that, in 1869, the commission proposed to parliament the inclosure of 13,000 acres, with the reservation of only one acre for recreation, and none at all for field gardens. This proposal attracted the attention of Henry Fawcett, who, after much inquiry and consideration, came to the conclusion that inclosures were, speaking generally, doing more harm than good to the agricultural labourer, and that, under such conditions as the commissioners were prescribing, they constituted a serious evil. With characteristic intrepidity he opposed the annual inclosure bill (which had come to be considered a mere form) and moved for a committee on the whole subject. The ultimate result was the passing, seven years later, of the Commons Act 1876. This measure, introduced by a Conservative government, laid down the principle that an inclosure should not be allowed unless distinctly shown to be for the benefit, not merely of private persons, but of the neighbourhood generally and the public. It imposed many checks upon the process, and following the course already adopted in the case of metropolitan commons, offered an alternative method of making commons more useful to the nation, viz. their management and regulation as open spaces. The effect of this legislation and of the changed attitude of the House of Commons towards inclosure has been almost to stop that process, except in the case of common fields or extensive mountain wastes.

We have alluded to the regulation of commons as open spaces. The primary object of this process is to bring a common under the jurisdiction of some constituted authority, which may make by-laws, enforceable in a summary way before the magistrates of the district, for its protection, and may appoint watchers or keepers to preserve order and prevent wanton mischief. There are several means of attaining

Amendment of Statute of Merton.

Rural commons.

Regulation.

Open space movement.

this object. Commons within the metropolitan police district—the Greater London of the registrar-general—are in this respect in a position by themselves. Under the Metropolitan Commons Acts, schemes for their local management may be made by the Board of Agriculture (in which the inclosure commission is now merged) without the consent either of the owner of the soil or the commoners—who, however, are entitled to compensation if they can show that they are injuriously affected. Outside the metropolitan police district a provisional order for regulation may be made under the Commons Act 1876, with the consent of the owner of the soil and of persons representing two-thirds in value of all the interests in the common. And under an act passed in 1899 the council of any urban or rural district may, with the approval of the Board of Agriculture and without recourse to parliament, make a scheme for the management of any common within its district, provided no notice of dissent is served on the board by the lord of the manor or by persons representing one-third in value of such interests in the common as are affected by the scheme. There is yet another way of protecting a common. A parish council may, by agreement, acquire an interest in it, and may make by-laws for its regulation under the Local Government Act 1894. The acts of 1894 and 1899 undoubtedly proceed on right lines. For, with the growth of efficient local government, commons naturally fall to be protected and improved by the authority of the district.

It remains to say a word as to the extent of common land still remaining open in England and Wales. In 1843 it was *Statistics* estimated that there were still 10,000,000 acres of common land and common-field land. In 1874 another return made by the inclosure commission made a guess of 2,632,772. These two returns were made from the same materials, viz. the tithe commutation awards. As less than 700,000 acres had been inclosed in the intervening period, it is obvious that the two estimates are mutually destructive. In July 1875 another version was given in the Return of Landowners (generally known as the Modern Domesday Book), compiled from the valuation lists made for the purposes of rating. This return put the commons of the country (not including common fields) at 1,542,648 acres. It is impossible to view any of these returns as accurate. Those compiled from the tithe commutation awards are based largely on estimates, since there are many parishes where the tithes had not been commuted. On the other hand, the valuation lists do not show waste and unoccupied land (which is not rated), and consequently the information as to such lands in the Return of Landowners was based on any materials which might happen to be at the disposal of the clerk of the guardians. All we can say, therefore, is that the acreage of the remaining common land of the country is probably somewhere between 1,500,000 and 2,000,000 acres. It is most capriciously distributed. In the Midlands there is very little to be found, while in a county of poor soil, like Surrey, nearly every parish has its common, and there are large tracts of heath and moor. In 1866, returns were made to parliament by the overseers of the poor of the commons within 15 and within 25 m. of Charing Cross. The acreage within the larger area was put at 38,450 acres, and within the smaller at 13,301; but owing to the difference of opinion which sometimes prevails upon the question, whether land is common or not, and the carelessness of some parish authorities as to the accuracy of their returns, even these figures cannot be taken as more than approximately correct. The metropolitan police district, within which the Metropolitan Commons Acts are in force, approaches in extent to a circle of 15 miles' radius. Within this district nearly 12,000 acres of common land have been put under local management, either by means of the Commons Acts or under special legislation. London is fortunate in having secured so much recreation ground on its borders. But when the enormous population of the capital and its rapid growth and expansion are considered, the conclusion is inevitable, that not one acre of common land within an easy railway journey of the metropolis can be spared.

AUTHORITIES.—Marshall, *Elementary and Practical Treatise on Landed Property* (London, 1804); F. W. Maitland, *Domesday Book and Beyond* (Cambridge, 1897); *Borough and Township* (Cambridge, 1898); F. Seebohm, *The English Village Community* (London, 1883); Williams, Joshua, *Rights of Common* (London, 1880); C. I. Elton, *A Treatise on Commons and Waste Lands* (1868); T. E. Scrutton, *On Commons and Common Fields* (1887); H. R. Woolrych, *Rights of Common* (1850); G. Shaw-Lefevre, *English Commons and Forests* (London, 1894); Sir W. Hunter, *The Preservation of Open Spaces* (London, 1896); "The Movements for the Inclosure and Preservation of Open Lands," *Journal of the Royal Statistical Society*, vol. ix. part ii. (June 1897); *Returns to House of Commons* (1843), No. 325; (1870), No. 326; (1874), No. 85; *Return of Landowners* (1875); *Annual Reports of Inclosure Commission and Board of Agriculture*; Revised Statutes and Statutes at large. (R. H. *)

COMMONWEALTH, a term generally synonymous with commonweal, i.e. public welfare, but more particularly signifying a form of government in which the general public have a direct voice. "The Commonwealth" is used in a special sense to denote the period in English history between the execution of Charles I. in 1649 and the Restoration in 1660. Commonwealth is also the official designation in America of the states of Massachusetts, Pennsylvania, Virginia and Kentucky. The Commonwealth of Australia is the title of the federation of Australian colonies carried out in 1900.

COMMUNE (Med. Lat. *communia*, Lat. *communis*, common), in its most general sense, a group of persons acting together for purposes of self-government, especially in towns. (See **BOROUGH**, and **COMMUNE, MEDIEVAL**, below.) "Commune" (Fr. *commune*, Ital. *comune*, Ger. *Gemeinde*, &c.) is now the term generally applied to the smallest administrative division in many European countries. (See the sections dealing with the administration of these countries under their several headings.) "The Commune" is the name given to the period of the history of Paris from March 18 to May 28, 1871, during which the commune of Paris attempted to set up its authority against the National Assembly at Versailles. It was a political movement, intended to replace the centralized national organization by one based on a federation of communes. Hence the "communists" were also called "federalists." It had nothing to do with the social theories of Communism (*q.v.*). (See **FRANCE: History**.)

COMMUNE, MEDIEVAL. Under this head it is proposed to give a short account of the rise and development of towns in central and western continental Europe since the downfall of the Roman Empire. All these, including also the British towns (for which, however, see **BOROUGH**), may be said to have formed one unity, inasmuch as all arose under similar conditions, economic, legal and political, irrespective of local peculiarities. Kindred economic conditions prevailed in all the former provinces of the Western empire, while new law concepts were everywhere introduced by the Germanic invaders. It is largely for the latter reason that it seems advisable to begin with an account of the German towns, the term German to correspond to the limits of the old kingdom of Germany, comprising the present empire, German Austria, German Switzerland, Holland and a large portion of Belgium. In their development the problem, as it were, worked out least tainted by foreign interference, showing at the same time a rich variety in detail; and it may also be said that their constitutional and economic history has been more thoroughly investigated than any other.

Like the others, the German towns should be considered from three points of view, viz. as jurisdictional units, as self-administrative units and as economic units. One of the chief distinguishing features of early as opposed to modern town-life is that each town formed a jurisdictional district distinct from the country around. Another trait, more in accordance with the conditions of to-day, is that local self-government was more fully developed and strongly marked in the towns than without. And, thirdly, each town in economic matters followed a policy as independent as possible of that of any other town or of the country in general. The problem is, how this state of things arose.

From this point of view the German towns may be divided into two main classes: those that gradually resuscitated on the ruins of former Roman cities in the Rhine and Danube countries, and

those that were newly founded at a later date in the interior.¹ Foremost in importance among the former stand the episcopal cities. Most of these had never been entirely destroyed during the Germanic invasion. Roman civic institutions perished; but probably parts of the population survived, and small Christian congregations with their bishops in most cases seem to have weathered all storms. Much of the city walls presumably remained standing, and within them German communities soon settled.

In the 10th century it became the policy of the German emperors to hand over to the bishops full jurisdictional and administrative powers within their cities. The bishop henceforward directly or indirectly appointed all officers for the town's government. The chief of these was usually the *advocatus* or *Vogt*, some neighbouring noble who served as the proctor of the church in all secular affairs. It was his business to preside three times a year over the chief law-court, the so-called *echte* or *ungebotene Ding*, under the cognizance of which fell all cases relating to real property, personal freedom, bloodshed and robbery. For the rest of the legal business and as president of the ordinary court he appointed a *Schultheiss*, *centenarius* or *causidicus*. Other officers were the *Burggraf*² or *praefectus* for military matters, including the preservation of the town's defences, walls, moat, bridges and streets, to whom also appertained some jurisdiction over the craft-gilds in matters relating to their crafts; further the customs-officer or *telconarius* and the mint-master or *monetae magister*. It was not, however, the fact of their being placed under the bishop that constituted these towns as separate jurisdictional units. The chief feature rather is the existence within their walls of a special law, distinct in important points from that of the country at large. The towns enjoyed a special peace, as it was called, *i.e.* breaches of the peace were more severely punished if committed in a town than elsewhere. Besides, the inhabitants might be sued before the town court only, and to fugitives from the country who had taken refuge in the town belonged a similar privilege. This special legal status probably arose from the towns being considered in the first place as the king's fortresses³ or burgs (see BOROUGH), and, therefore, as participating in the special peace enjoyed by the king's palace. Hence the terms "burgh," "borough" in English, *burgs* in Gothic, the earliest Germanic designations for a town; "burgher," "burgess" for its inhabitants. What struck the townless early Germans most about the Roman towns was their mighty walls. Hence they applied to all fortified habitations the term in use for their own primitive fortifications; the walls remained with them the main feature distinguishing a town from a village; and the fact of the town being a fortified place likewise necessitated the special provisions mentioned for maintaining the peace.

The new towns in the interior of Germany were founded on land belonging to the founder, some ecclesiastical or lay lord, and frequently adjoining the cathedral close of one of the new sees or the lord's castle, and they were laid out according to a regular plan. The most important feature was the market-square, often surrounded by arcades with stalls for the sale of the principal commodities, and with a number of straight streets leading thence to the city gates.⁴ As for the fortifications, some time naturally passed before they were completed. Furthermore, the governmental machinery would be less complex than in the older towns. The legal peculiarities distinguishing town and country, on the other hand, may be said to have been conferred

¹ As to the former, see S. Rietschel, *Die Civitas auf deutschem Boden bis zum Ausgange der Karolingerzeit* (Leipzig, 1894); and, for the newly founded towns, the same author, *Markt und Stadt in ihrem rechtlichen Verhältnis* (Leipzig, 1897).

² About the *Burggraf*, see S. Rietschel, *Das Burggrafnamt und die hohe Gerichtsbarkeit in den deutschen Bischofsstädten während des früheren Mittelalters* (Leipzig, 1905).

³ As to the towns as fortresses, see also F. Keutgen, *Untersuchungen über den Ursprung der deutschen Stadtverfassung* (Leipzig, 1895); and "Der Ursprung der deutschen Stadtverfassung" (*Neue Jahrbücher für die klassische Altertum*, &c., N.F. vol. v.).

⁴ See S. Rietschel, *Markt und Stadt*, and J. Fritz, *Deutsche Stadtanlagen* (Strassburg, 1894).

on the new towns in a more clearly defined form from the beginning.

An important difference lay in the mode of settlement. There is evidence that in the quondam Roman towns the German newcomers settled much as in a village, *i.e.* each full member of the community had a certain portion of arable land allotted to him and a share in the common. Their pursuits would at first be mainly agricultural. The new towns, on the other hand, general economic conditions having meanwhile begun to undergo a marked change, were founded with the intention of establishing centres of trade. Periodical markets, weekly or annual, had preceded them, which already enjoyed the special protection of the king's ban, acts of violence against traders visiting them or on their way towards them being subject to special punishment. The new towns may be regarded as markets made permanent. The settlers invited were merchants (*mercatores personali*) and handicraftsmen. The land now allotted to each member of the community was just large enough for a house and yard, stabling and perhaps a small garden (50 by 100 ft. at Freiburg, 60 by 100 ft. at Bern). These building plots were given as free property or, more frequently, at a merely nominal rent (*Wurtzins*) with the right of free disposal, the only obligation being that of building a house. All that might be required besides would be a common for the pasture of the burgesses' cattle.

The example thus set was readily followed in the older towns. The necessary land was placed at the disposal of new settlers, either by the members of the older agricultural community, or by the various churches. The immigrants were of widely differing status, many being serfs who came either with or without their lords' permission. The necessity of putting a stop to belated prosecutions on this account in the town court led to the acceptance of the rule that nobody who had lived in a town undisturbed for the term of a year and a day could any longer be claimed by a lord as his serf. But even those who had migrated into a town with their lords' consent could not very well for long continue in serfdom. When, on the other hand, certain bishops attempted to treat all new-comers to their city as serfs, the emperor Henry V. in charters for Spire and Worms proclaimed that in these towns all serf-like conditions should cease. This ruling found expression in the famous saying: *Stadluft macht frei*, "town-air renders free." As may be imagined, this led to a rapid increase in population, mainly during the 11th to 13th centuries. There would be no difficulty for the immigrants to find a dwelling, or to make a living, since most of them would be versed in one or other of the crafts in practice among villagers.

The most important further step in the history of the towns was the establishment of an organ of self-government, the town-council (*Rat*, *consilium*, its members, *Ratmänner*, *consules*, less frequently *consiliarii*), with one, two or more burgomasters (*Bürgermeister*, *magistri civium*, *proconsules*) at its head. (It was only after the Renaissance that the town-council came to be styled *senate*, and the burgomasters in Latin documents, *consules*.) As units of local government the towns must be considered as originally placed on the same legal basis as the villages, *viz.* as having the right of taking care of all common interests below the cognizance of the public courts or of those of their lord.⁵ In the towns, however, this right was strengthened at an early date by the *jus negotiale*. At least as early as the beginning of the 11th century, but probably long before that date, mercantile communities claimed the right, confirmed by the emperors, of settling mercantile disputes according to a law of their own, to the horror of certain conservative-minded clerics.⁶ Furthermore, in the rapidly developing towns, opportunities for the exercise of self-administrative functions constantly increased. The new self-governing body soon began to legislate in matters of local government, imposing fines for the breach

⁵ G. von Below, *Die Entstehung der deutschen Stadtgemeinde* (Düsseldorf, 1889); and *Der Ursprung der deutschen Stadtverfassung* (Düsseldorf, 1892).

⁶ F. Keutgen, *Urkunden zur städtischen Verfassungsgeschichte*, No. 74 and No. 75 (Berlin, 1901).

of its by-laws. Thus it assumed a jurisdiction, partly concurrent with that of the lord, which it further extended to breaches of the peace. And, finally, it raised funds by means of an excise-duty, *Ungeld* (cf. the English *malatolla*) or *Accise, Zeise*. In the older and larger towns it soon went beyond what the bishops thought proper to tolerate; conflicts ensued; and in the 13th century several bishops obtained decrees in the imperial court, either to suppress the *Rat* altogether, or to make it subject to their nomination, and more particularly to abolish the *Ungeld*, as detrimental to episcopal finances. In the long run, however, these attempts proved of little avail.

Meanwhile the tendency towards self-government spread even to the lower ranks of town society, resulting in the establishment of craft-gilds. From a very early period there is reason to believe merchants among themselves formed gilds for social and religious purposes, and for the furtherance of their economic interests. These gilds would, where they existed, no doubt also influence the management of town affairs; but nowhere has the *Rat*, as used to be thought, developed out of a gild, nor has the latter anywhere in Germany played a part at all similar in importance to that of the English gild merchant, the only exception being for a time the *Richerzeche*, or Gild of the Rich of Cologne, from early times by far the largest, the richest, and the most important trading centre among German cities, and therefore provided with an administration more complex, and in some respects more primitive, than any other. On the other hand, the most important commodities offered for sale in the market had been subject to official examination already in Carolingian times. Bakers', butchers', shoemakers' stalls were grouped together in the market-place to facilitate control, and with the same object in view a master was appointed for each craft as its responsible representative. By and by these crafts or "offices" claimed the right of electing their master and of assisting him in examining the goods, and even of framing by-laws regulating the quality of the wares and the process of their manufacture. The bishops at first resented these attempts at self-management, as they had done in the case of the town council, and imperial legislation in their interests was obtained. But each craft at the same time formed a society for social, beneficial and religious purposes, and, as these were entirely in accordance with the wishes of the clerical authorities, the other powers could not in the long run be withheld, including that of forcing all followers of any craft to join the gild (*Zunfzwang*). Thus the official inspection of markets, community of interests on the part of the craftsmen, and co-operation for social and religious ends, worked together in the formation of craft-gilds. It is not suggested that in each individual town the rise of the gilds was preceded by an organization of crafts on the part of the lord and his officers; but it is maintained that as a general thing voluntary organization could hardly have proceeded on such orderly lines as the whole it did, unless the framework had in the first instance been laid down by the authorities: much as in modern times the working together in factories has practically been an indispensable preliminary to the formation of trade unions. Much less would the principle of forced entrance have found such ready acceptance both on the part of the authorities and on that of the men, unless it had previously been in full practice and recognition under the system of official market-control. The different names for the societies, viz. *fraternitas*, *Brüderschaft*, *officium*, *Amt*, *conductum*, *Zunft*, *unio*, *Innung*, do not signify different kinds of societies, but only different aspects of the same thing. The word *Gilde* alone forms an exception, inasmuch as, generally speaking, it was used by merchant gilds only.¹

From an early date the towns, more particularly the older episcopal cities, took a part in imperial politics. Legally the bishops were in their cities mere representatives of the imperial government. This fact found formal expression mainly in two ways. The *Vogt*, although appointed by the bishop, received the "ban," i.e. the power of having justice executed, which he passed on to the lesser officers, from the king or emperor direct. Secondly, whenever the emperor held a *curia generalis*

¹ F. Keutgen, *Ämter und Zünfte* (Jena, 1903).

(or general assembly, or diet) in one of the episcopal cities, and for a week before and after, all jurisdictional and administrative power reverted to him and his immediate officers. The citizens on their part clung to this connexion and made use of it whenever their independence was threatened by their bishops, who strongly inclined to consider themselves lords of their cathedral cities, much as if these had been built on church-lands. As early as 1073, therefore, we find the citizens of Worms successfully rising against their bishop in order to provide the emperor Henry IV. with a refuge against the rebellious princes. Those of Cologne made a similar attempt in 1074. But a second class of imperial cities (*Reichsstädte*), much more numerous than the former, consisted of those founded on demesne-land belonging either to the Empire or to one of the families who rose to imperial rank. This class was largely reinforced, when after the extinction of the royal house of Hohenstaufen in the 13th century, a great number of towns founded by them on their demesne successfully claimed immediate subjection to the crown. About this time, during the interregnum, a federation of more than a hundred towns was formed, beginning on the Rhine, but spreading as far as Bremen in the north, Zürich in the south, and Regensburg in the east, with the object of helping to preserve the peace. After the death of King William in 1256, they resolved to recognize no king unless unanimously elected. This league was joined by a powerful group of princes and nobles and found recognition by the prince-electors of the Empire; but for want of leadership it did not stand the test, when Richard of Cornwall and Alphonso of Castile were elected rival kings in 1257.² In the following centuries the imperial cities in south Germany, where most of them were situated, repeatedly formed leagues to protect their interests against the power of the princes and the nobles, and destructive wars were waged; but no great political issue found solution, the relative position of the parties after each war remaining much what it had been before. On the part of the towns this was mainly due to lack of leadership and of unity of purpose. At the time of the Reformation the imperial towns, like most of the others, stood forward as champions of the new cause and did valuable service in upholding and defending it. After that, however, their political part was played out, mainly because they proved unable to keep up with modern conditions of warfare. It should be stated that seven among the episcopal cities, viz. Cologne, Mainz, Worms, Spire, Strassburg, Basel and Regensburg, claimed a privileged position as "Free Cities," but neither is the ground for this claim clearly established, nor its nature well defined. The general obligations of the imperial cities towards the Empire were the payment of an annual fixed tax and the furnishing of a number of armed men for imperial wars, and from these the above-named towns claimed some measure of exemption. Some of the imperial cities lost their independence at an early date, as unredeemed pledges to some prince who had advanced money to the emperor. Others seceded as members of the Swiss Confederation. But a considerable number survived until the reorganization of the Empire in 1803. At the peace in 1815, however, only four were spared, namely, Frankfort, Bremen, Hamburg and Lübeck, these being practically the only ones still in a sufficiently flourishing and economically independent position to warrant such preferential treatment. But finally Frankfort, having chosen the wrong side in the war of 1866, was annexed by Prussia, and only the three seaboard towns remain as full members of the new confederate Empire under the style of *Freie und Hansestädte*. But until modern times most of the larger *Landstädte* or mesne-towns for all intents and purposes were as independent under their lords as the imperial cities were under the emperor. They even followed a foreign policy of their own, concluded treaties with foreign powers or made war upon them. Nearly all the *Hanseatic towns* belonged to this category. With others like Bremen, Hamburg and Magdeburg, it was long in the balance which class they belonged to. All towns of any importance, however, were for a considerable time far ahead of the principalities in administration.

² J. Weizsäcker, *Der rheinische Bund* (Tübingen, 1879).

It was largely this fact that gave them power. When, therefore, from about the 15th century the princely territories came to be better organized, much of the *raison d'être* for the exceptional position held by the towns disappeared. The towns from an early date made it their policy to suppress the exercise of all handicrafts in the open country. On the other hand, they sought an increase of power by extending rights of citizenship to numerous individual inhabitants of the neighbouring villages (*Pfalzbürger*, a term not satisfactorily explained). By this and other means, e.g. the purchase of estates by citizens, many towns gradually acquired a considerable territory. These tendencies both princes and lesser nobles naturally tried to thwart, and the mediate towns or *Landstädte* were finally brought to stricter subjection, at least in the greater principalities such as Austria and Brandenburg. Besides, the less favourably situated towns suffered through the concentration of trade in the hands of their more fortunate sisters. But the economic decay and consequent loss of political influence among both imperial and territorial towns must be chiefly ascribed to inner causes.

Certain leading political economists, notably K. Bücher (*Die Bevölkerung von Frankfurt a. M. im 14ten und 15ten Jahrhundert*, i., Tübingen, 1886; *Die Entstehung der Volkswirtschaft*, 5th ed., Tübingen, 1906), and, in a modified form, W. Sombart (*Der moderne Kapitalismus*, 2 vols., Leipzig, 1902), have propounded the doctrine of one gradual progression from an agricultural state to modern capitalistic conditions. This theory, however, is nothing less than an outrage on history. As a matter of fact, as far as modern Europe is concerned, there has twice been a progression, separated by a period of retrogression, and it is to the latter that Bücher's picture of the agricultural and strictly protectionist town (the *geschlossene Stadtwirtschaft*) of the 14th and 15th centuries belongs, while Sombart's notion of an entire absence of a spirit of capitalistic enterprise before the middle of the 15th century in Europe north of the Alps, or the 14th century in Italy, is absolutely fantastic.¹ The period of the rise of cities till well on in the 13th century was naturally a period of expansion and of a considerable amount of freedom of trade. It was only afterwards that a protectionist spirit gained the upper hand, and each town made it its policy to restrict as far as possible the trade of strangers. In this revolution the rise of the lower strata of the population to power played an important part.

The craft-gilds had remained subordinate to the *Rat*, but by-and-by they claimed a share in the government of the towns. Originally any inhabitant holding a certain measure of land, freehold or subject to the mere nominal ground-rent above-mentioned, was a full citizen independently of his calling, the clergy and the lord's retainers and servants of whatever rank, who claimed exemption from scot and lot, to use the English formula, alone excepted. The majority of the artisans, however, were not in this happy position. Moreover, the town council, instead of being freely elected, filled up vacancies in its ranks by co-optation, with the result that all power became vested in a limited number of rich families. Against this state of things the crafts rebelled, alleging mismanagement, malversation and the withholding of justice. During the 14th and 15th centuries revolutions and counter-revolutions, sometimes accompanied by considerable slaughter, were frequent, and a great variety of more democratic constitutions were tried. Zürich, however, is the only German place where a kind of *tyrannis*, so frequent in Italy, came to be for a while established. On the whole it must be said that in those towns where the democratic party gained the upper hand an unruly policy abroad and a narrow-minded protection at home resulted. An inclination to hasty measures of war and an unwillingness to observe treaties among the democratic towns of Swabia were largely responsible for the

disasters of the war of the Swabian League in the 14th century. At home, whereas at first markets had been free and open to any comer, a more and more protective policy set in, traders from other towns being subjected more and more to vexatious restrictions. It was also made increasingly difficult to obtain membership in the craft-gilds, high admission fees and so-called masterpieces being made a condition. Finally, the number of members became fixed, and none but members' sons and sons-in-law, or members' widows' husbands were received. The first result was the formation of a numerous proletariat of life-long assistants and of men and women forcibly excluded from following any honest trade; and the second consequence, the economic ruin of the town to the exclusive advantage of a limited number. From the end of the 15th century population in many towns decreased, and not only most of the smaller ones, but even some once important centres of trade, sank to the level almost of villages. Those cities, on the other hand, where the mercantile community remained in power, like Nuremberg and the seaboard towns, on the whole followed a more enlightened policy, although even they could not quite keep clear of the ever-growing protective tendencies of the time. Many even of the richer towns, notably Nuremberg, ran into debt irretrievably, owing partly to an exorbitant expenditure on magnificent public buildings and extensive fortifications, calculated to resist modern instruments of destruction, partly to a faulty administration of the public debt. From the 13th century the towns had issued ("sold," as it was called) annuities, either for life or for perpetuity in ever-increasing number, until it was at last found impossible to raise the funds necessary to pay them.

One of the principal achievements of the towns lay in the field of *legislation*. Their law was founded originally on the general national (or provincial) law, on custom, and on special privilege. New foundations were regularly provided by their lord with a charter embodying the most important points of the special law of the town in question. This miniature code would thenceforth be developed by means of statutes passed by the town council. The codification of the law of Augsburg in 1276 already fills a moderate volume in print (ed. by Christian Meyer, Augsburg, 1872). Later foundations were frequently referred by their founders to the nearest existing town of importance, though that might belong to a different lord. Afterwards, if a question in law arose which the court of a younger town found itself unable to answer, the court next senior in affiliation was referred to, which in turn would apply to the court above, until at last that of the original mother town was reached, whose decision was final. This system was chiefly developed in the colonial east, where most towns were affiliated directly or indirectly either to Lübeck or to Magdeburg; but it was by no means unknown in the home country. A number of collections of such judgments (*Schöffensprüche*) have been published. It is also worth mentioning that it was usual to read the police by-laws of a town at regular intervals to the assembled citizens in a morning-speech (*Morgensprache*).²

To turn to *Italy*, the country for so many centuries in close political connexion with Germany, the foremost thing to be noted is that here the towns grew to even greater independence, many of them in the end acknowledging no overlord whatever after the yoke of the German kings had been shaken off. On the other hand, nearly all of them in the long run fell under the sway of some local tyrant-dynasty.

From Roman times the country had remained thickly studded with towns, each being the seat of a bishop. From this arose their most important peculiarity. For it was largely due to an identification of dioceses and municipal territories that the nobles of the surrounding country took up their headquarters in the cities, either voluntarily or because forced to do so by the citizens, who made it their policy thus to turn possible opponents into partisans and defenders. In Germany, on the other hand,

¹ G. v. Below, *Der Untergang der mittelalterlichen Stadtwirtschaft; Über Theorien der wirtschaftlichen Entwicklung der Völker*; F. Keutgen, "Hansische Handelsgesellschaften, vornehmlich des 14ten Jahrhunderts," in *Vierteljahrsschrift für Sozial- und Wirtschaftsgeschichte*, vol. iv. (1906).

² On this whole subject see Richard Schröder, *Lehrbuch der deutschen Rechtsgeschichte* (5th ed., Leipzig, 1907), § 56, "Die Stadtrechte." Also Charles Gross, *The Guild Merchant* (Oxford, 1890), vol. i. Appendix E, "Affiliation of Medieval Boroughs."

nobles and knights were carefully shut out so long as the town's independence was at stake, the members of a princely garrison being required to take up their abode in the citadel, separated from the town proper by a wall. Only in the comparatively few cathedral cities this rule does not obtain. It will be seen that, in consequence of this, municipal life in Italy was from the first more complex, the main constituent parts of the population being the *capitani*, or greater nobles, the *valvassori*, or lesser nobles (knights) and the people (*popolo*). Furthermore, the bishops being in most cases the exponents of the imperial power, the struggle for freedom from the latter ended in a radical riddance from all temporal episcopal government as well. Foremost in this struggle stood the cities of Lombardy, most of which all through the barbarian invasions had kept their walls in repair and maintained some importance as economic centres, and whose *popolo* largely consisted of merchants of some standing. As early as the 8th century the laws of the Langobard King Aistulf distinguished three classes of merchants (*negotiantes*), among whom the *maiores et potentes* were required to keep themselves provided with horse, lance, shield and a cuirass. The valley of the Po formed the main artery of trade between western Europe and the East, Milan being besides the point of convergence for all Alpine passes west of the Brenner (the St Gotthard, however, was not made accessible until early in the 13th century). Lombard merchants soon spread all over western Europe, a chief source of their ever-increasing wealth being their employment as bankers of the papal see.

The struggle against the bishops, in which a clamour for a reform of clerical life and a striving for local self-government were strangely interwoven, had raged for a couple of generations when King Henry V., great patron of municipal freedom as he was, legalized by a series of charters the *status quo* (Cremona, 1114, Mantua, 1116). But under his weak successors the independence of the cities reached such a pitch as to be manifestly intolerable to an energetic monarch like Frederick I. Besides, the more powerful among them would subdue or destroy their weaker neighbours, and two parties were formed, one headed by Milan, the other by Cremona. Como and Lodi complained of the violence used to them by the former city. Therefore in 1158 a commission was appointed embracing four Roman legists as representatives of the emperor, as well as those of fourteen towns, to examine into the imperial and municipal rights. The claims of the imperial government, jurisdictional and other, were acknowledged, only such rights of self-government being admitted as could be shown to be grounded on imperial charters. But when it came to carrying into effect these Roncaglian decrees, a general rising resulted. Milan was besieged by the emperor and destroyed in 1162 in accordance with the verdict of her rivals. Nevertheless, after a defeat at Legnano in 1176, Frederick was forced to renounce all pretensions to interference with the government of the cities, merely retaining an overlordship that was not much more than formal (peace of Constance in 1183). All through this war the towns had been supported by Pope Alexander III. Similarly under Frederick II. the renewal of the struggle between emperor and pope dovetailed with a fresh outbreak of the war with the cities, who feared lest an imperial triumph over the church would likewise threaten their independence. The emperor's death finally decided the issue in their favour.

Constitutionally, municipal freedom was based on the formation of a commune headed by elected consuls, usually to the number of twelve, representing the three orders of *capitani*, *valvassori* and *popolo*. Frequently, however, the number actually wielding power was much more restricted, and their position altogether may rather be likened to that of their Roman predecessors than to that of their German contemporaries. In all important matters they asked the advice and support of "wise men," *sapientes, discretiores, prudentes*, as a body called the *credenza*, while the popular assembly (*parlamentum, concio, consilium generale*) was the true sovereign. The consuls with the assistance of *judices* also presided in the law-courts; but besides the consuls of the commune there were *consules de placitis* specially appointed for jurisdictional purposes.

In spite of these multifarious safeguards, however, family factions early destroyed the fabric of liberty, especially as, just as there was an imperial, or Ghibelline, and a papal, or Guelph party among the cities as a whole, thus also within each town each faction would allege adherence to and claim support by one or other of the great world-powers. To get out of the dilemma of party-government, resort was thereupon had to the appointment as chief magistrate of a *podestà* from among the nobles or knights of a different part of the country not mixed up with the local feuds. But the end was in most cases the establishment of the despotism of some leading family, such as the Visconti at Milan, the Gonzaga at Mantua, the della Scala in Verona and the Carrara in Padua.

In Tuscany, the historic rôle of the cities, with the exception of Pisa, begins at a later date, largely owing to the overlordship of the powerful margraves of the house of Canossa and their successors, who here represented the emperor. Pisa, however, together with Genoa, all through the 11th century distinguished itself by war waged in the western Mediterranean and its isles against the Saracens. Both cities, along with Venice, but especially the Genoese, also did excellent service in reducing the Syrian coast towns still in the hands of the Turks in the reigns of Kings Baldwin I. and Baldwin II. of Jerusalem, while more particularly Pisa with great constancy placed her fleet at the disposal of the Hohenstaufen emperors for warfare with Sicily.

Meanwhile communes with consuls at their head were formed in Tuscany much as elsewhere. On the other hand the Tuscan cities managed to prolong the reign of liberty to a much later epoch, no *podestà* ever quite succeeding here in his attempts to establish the rule of his dynasty. Even when in the second half of the 15th century the Medici in Florence attained to power, the form at least of a republic was still maintained, and not till 1531 did one of them, supported by Charles V., assume the ducal title.

Long before the last stage, the rule of *signori*, was reached, however, the commune as originally constituted had everywhere undergone radical changes. As early as the 13th century the lower orders among the inhabitants formed an organization under officers of their own, side by side with that of the commune, which was controlled by the great and the rich; e.g. at Florence the people in 1250 rose against the turbulent nobles and chose a *capitano del popolo* with twelve *anziani*, two from each of the six city-wards (*sestieri*), as his council. The *popolo* itself was divided into twenty armed companies, each under a *gonfaloniere*. But later the *arti* (craft-gilds), some of whom, however, can be shown to have existed under consuls of their own as early as 1203, attained supreme importance, and in 1282 the government was placed in the hands of their *priori*, under the name of the *signoria*. The Guelph nobles were at first admitted to a share in the government, on condition of their entering a gild, but in 1293 even this privilege was withdrawn. The *ordinamenti della giustizia* of that year robbed the nobility of all political power. The lesser or lower *arti* on the other hand, were conceded a full share in it, and a *gonfaloniere della giustizia* was placed at the head of the militia. In the 14th century twelve *buoni uomini* representing the wards (*sestieri*) were superadded, all these dignitaries holding office for two months only. And besides all these, there existed three competing chief justices and commanders of the forces called in from abroad and holding office for six months, viz. the *podestà*, the *capitano del popolo*; and the *esecutore della giustizia*. In spite of all this complicated machinery of checks and balances, revolution followed upon revolution, nor could an occasional reign of terror be prevented like that of the Signore Gauthier de Brienne, duke of Athens (1342-1343). It was not till after a rising of the lowest order of all, the industrial labourers, had been suppressed in 1378 (*tumulto dei Ciompi*, the wool-combers), that quieter times ensued under the wise leadership, first of the Albizzi and finally of the Medici.

The history of the other Tuscan towns was equally tumultuous, all of them save Lucca, after many fitful changes finally passing under the sway of Florence, or the grand-duchy of Tuscany, as the state was now called. Pisa, one time the mightiest, had been

crushed between its inland neighbour and its maritime rival Genoa (battle of Meloria, 1282).

Apart in its constitutional development from all other towns in Italy, and it might be added, in Europe, stands Venice. Almost alone among Italian cities its origin does not go back to Roman times. It was not till the invasions of Hun and Lombard that fugitives from the Venetian mainland took refuge among the poor fishermen on the small islands in the lagoons and on the *lido*—the narrow stretch of coast-line which separates the lagoons from the Adriatic—some at Grado, some at Malamocco, others on Rialto. A number of small communities were formed under elected tribunes, acknowledging as their sovereign the emperor at Constantinople. Treaties of commerce were concluded with the Lombard kings, thus assuring a market for the sale of imports from the East and for the purchase of agricultural produce. Just before or after A.D. 700 the young republic seems to have thrown off the rule of the Byzantine *dux Histriae et Venetiae* and elected a duke (*doge*) of its own, in whom was vested the executive power, the right to convoke the popular assembly (*concio*) and appoint tribunes and justices. Political unity was thus established, but it was not till after another century of civil war that Rialto was definitely chosen the seat of government and thus the foundation of the present city laid. After a number of attempts to establish a hereditary dukedom, Duke Domenico Flabianico in 1032 passed a law providing that no duke was to appoint his successor or procure him to be elected during his own lifetime. Besides this two councils were appointed without whose consent nothing of importance was to be done. After the murder by the people of Duke Vitale Michiel in 1172, who had suffered naval defeat, it was deemed necessary to introduce a stricter constitutional order. According to the orthodox account, some details of which have, however, recently been impugned,¹ the irregular popular meeting was replaced by a great council of from 450 to 480 members elected annually by special appointed electors in equal proportion from each of the six wards. One of the functions of this body was to appoint most of the state officials or their electors. There was also an executive council of six, one from each ward. Besides these, the duke, who was henceforward elected by a body of eleven electors from among the aristocracy, would invite persons of prominence (the *pregadi*) in order to secure their assent and co-operation, whenever a measure of importance was to be placed before the great council. Only under extraordinary circumstances the *concio* was still to be called. The tenure of the duke's office was for life. The general tendency of constitutional development in Venice henceforward ran in an exactly opposite direction to that of all other Italian cities towards a growing restriction of popular rights, until in 1296 the great council was for all future time closed to all but the descendants of a limited number of noble families, whose names were in that year entered in the Golden Book. It still remained to appoint a board to superintend the executive power. These were the *avogadori di commune*, and, since Tiepolo's conspiracy in 1310, the *Consiglio dei Dieci*, the Council of Ten, which controlled the whole of the state, and out of which there developed in the 16th century the state inquisition.

While in all prominent Italian cities the leading classes of the community were largely made up of merchants, in Venice the nobility was entirely commercial. The marked steadiness in the evolution of the Venetian constitution is no doubt largely due to this fact. Elsewhere the presence of large numbers of turbulent country nobles furnished the first germ for the unending dissensions which ruined such promising beginnings. In Venice, on the contrary, its businesslike habits of mind led the ruling class to make what concessions might seem needful, while both the masses and the head of the state were kept in due subjection to the laws. Too much stability, however, finally changed into stagnation, and decay followed. The foreign policy of Venice was likewise mainly dictated by commercial motives, the chief objectives being commercial privilege in the Byzantine empire and in the Frankish states in the East, domination of the Adriatic,

occupation of a sufficient hinterland on the *terra firma*, non-sufferance of the rivalry of Genoa, and, finally, maintenance of trade-supremacy in the eastern Mediterranean through a series of alternating wars and treaties with Turkey, the lasting monument of which was the destruction of the Parthenon in 1685 by a Venetian bomb. At last the proud republic surrendered to Napoleon without a stroke.

The cities of southern Italy do not here call for special attention. Several of them developed a certain amount of independence and free institutions, and took an important part in trade with the East, notably so Amalfi. But after incorporation in the Norman kingdom all individual history for them came to an end.

Rome, finally, derived its importance from being the capital of the popes and from its proud past. From time to time spasmodic attempts were made to revive the forms of the ancient republic, as under Arnold of Brescia in the 12th and by Niccolò di Rienzo in the 14th century; but there was no body of stalwart, self-reliant citizens to support such measures: nothing but turbulent nobles on the one hand and a rabble on the other.

In no country is there such a clear grouping of the towns on geographical lines as in France, these geographical lines, of course, having in the first instance been drawn by historical causes. Another feature is the extent to which, in the unruly times preceding the civic movement, serfdom had spread among the inhabitants even of the towns throughout the greater part of the country, and the application of feudal ideas to town government. In some other respects the constitution of the cities in the south of France, as will be seen, has more in common with that of the Italian communes, and that of the northern French towns with those of Germany, than the constitutions of the various groups of French towns have among each other.

In the group of the *villes consulaires*, comprising all important towns in the south, the executive was, as in Italy, in the hands of a body of *consules*, whose number in most cases rose to twelve. They were elected for the term of one year and re-eligible only after an interval, and they were supported by a municipal council (*commune consilium*, *consilium magnum* or *secretum* or *generale*, or *colloquium*) and a general assembly (*parlamentum*, *concio*, *commune consilium*, *commune*, *universitas civium*), which, however, as a rule was far from comprising the whole body of citizens. Another feature which these southern towns had in common with their Italian neighbours was the prominent part played by the native nobility. The relations with the clergy were generally of a more friendly character than in the north, and in some cases the bishop or archbishop even retained a considerable influence in the management of the town's affairs. Dissensions among the citizens, or between the nobles and the bourgeois, frequently ended in the adoption of a *podestat*. And in several cities of the Languedoc, each of the two classes composing the population retained its separate laws and customs. It is matter of dispute whether vestiges of Roman institutions had survived in these parts down to the time when the new constitutions sprang into being; but all investigators are pretty well agreed that in no case did such remnants prove of any practical importance. Roman law, however, was never quite superseded by Germanic law, as appears from the *statuts municipaux*. In the improvement and expansion of these statutes a remarkable activity was displayed by means of an annual *correctio statutorum* carried out by specially appointed *statutores*. In the north, on the other hand, the *carta communiae*, forming as it were the basis of the commune's existence, seems to have been considered almost as something sacred and unchangeable.

The constitutional history of the communes in northern France in a number of points widely differed from that of these *villes consulaires*. First of all the movement for their establishment in most cases was to a far greater degree of a revolutionary character. These revolutions were in the first place directed against the bishops; but the position both of the higher clergy and of the nobility was here of a nature distinctly more hostile to the aspirations of the citizens than it was in the south. As a result the clergy and the nobles were excluded from all membership of

¹ H. Kretschmayr, *Geschichte von Venedig*, vol. i. (Gotha, 1905).

the commune, except inasmuch as that those residing in the town might be required to swear not to conspire against it. The commune (*communia, communa, communio, communitas, conjuratio, confederatio*) was formed by an oath of mutual help (*sacramentum, juramentum communiae*). The members were described as *asjurati* (also *burgenses, vicini, amici*), although in some communes that term was reserved for the members of the governing body. None but men of free and legitimate birth, and free from debt and contagious or incurable disease were received. The members of the governing body were styled *jurés (jurati), pairs (pares) or échevins (scabini)*. The last was, however, as in Germany, more properly the title of the jurors in the court of justice, which in many cases remained in the hands of the lord. In some cases the town council developed out of this body; but in the larger cities, like Rouen, several councils worked and all these names were employed side by side. The number of the members of the governing body proper varies from twelve to a hundred, and its functions were both judicial and administrative. There was also known an arrangement corresponding to the German *alte und sitzende Rat*, viz. of retired members who could be called in to lend assistance on important occasions. The most striking distinction, however, as against the *villes consulaires* was the elevation of the president of the body to the position of *maire* or *mayer* (sometimes also called *prévôt, praepositus*). As elsewhere, at first none but the civic aristocracy were admitted to take part in the management of the town's affairs; but from the end of the 13th century a share had to be conceded to representatives of the crafts. Dissatisfaction, however, was not easily allayed; the lower orders applied for the intervention of the king; and that effectively put an end to political freedom. This tendency of calling in state help marks a most striking difference as against the policy followed by the German towns, where all classes appear to have been always far too jealous of local independence. The result for the nation was in the one case despotism, equality and order, in the other individual liberty and an inability to move as a whole. At an earlier stage the king had frequently come to the assistance of the communes in their struggle with their lords. By-and-by the king's confirmation came to be considered necessary for their lawful existence. This proved a powerful lever for the extension of the king's authority. It may seem strange that in France the towns never had recourse to those interurban leagues which played so important a part in Italian and in German history.

These two varieties, the *communes* and the *villes consulaires* together form the group of *villes libres*. As opposed to these stand the *villes franches*, also called *villes prévôtales* after the chief officer, *villes de bourgeoisie* or *villes soumises*. They make up by far the majority of French towns, comprising all those situated in the centre of the kingdom, and also a large number in the north and the south. They are called *villes franches* on account of their possessing a franchise, a charter limiting the services due by the citizens to their lord, but political status they had little or none. According to the varying extent of the liberties conceded them, there may be distinguished towns governed by an elective body and more or less fully authorized to exercise jurisdiction; towns possessing some sort of municipal organization, but no rights of jurisdiction, except that of simple police; and, thirdly, those governed entirely by seignorial officers. To this last class belong some of the most important cities in France, wherever the king had power enough to withhold liberties deemed dangerous and unnecessary. On the other hand, towns of the first category often come close to the *villes libres*. A strict line of demarcation, however, remains in the mutual oath which forms the basis of the civic community in both varieties of the latter, and in the fact that the *ville libre* stands to its lord in the relation of vassal and not in that of an immediate possession. But however *complètement assujettie* Paris might be, its organization, naturally, was immensely more complex than that of hundreds of smaller places which, formally, might stand in an identical relationship to their lords. Like other *villes franches* under the king, Paris was governed by a *prévôt* (provost), but certain functions of self-government for

the city were delegated to the company of the *marchands de l'eau, mercatores aquae*, also called *mercatores ansati*, that is, the gild of merchants whose business lay down the river Seine, in other words, a body naturally exclusive, not, however, to the citizens as such. At their head stood a *prévôt des marchands* and four *eschevins de la marchandise*. Other *prud'hommes* were occasionally called in, and from 1296 *prévôt* and *échevins* appointed twenty-four councillors to form with themselves a *parloir aux bourgeois*. The crafts of Paris were organized in *métiers*, whose masters were appointed, some by the *prévôt de Paris*, and some by certain great officers of the court. In the tax rolls of A.D. 1292 to 1300 no fewer than 448 names of crafts occur, while the *Livre des métiers* written in 1268 by Étienne de Boileau, then *prévôt de Paris*, enumerates 101 organized bodies of tradesmen or women and artisans. Among the duties of these bodies, as elsewhere, was the *guet* or night-watch, which necessitated a military organization under *quartiniers, cinquaintiers* and *dixainiers*. This gave them a certain power. But both their revolutions, under the *prévôt des marchands*, Étienne Marcel, after the battle of Maupertuis, and again in 1382, were extremely short-lived, and the only tangible result was a stricter subjection to the king and his officers.

An exceptional position among the cities of France is taken up by those of *Flanders*, more particularly the three "Great Towns," Bruges, Ghent and Ypres, whose population was Flemish, i.e. German. They sprang up at the foot of the count's castles and rose in close conjunction with his power. On the accession of a new house they made their power felt as early as 1128. Afterwards the counts of the house of Dampierre fell into financial dependence on the burghers, and therefore allied themselves with the rising artisans, led by the weavers. These, however, proved far more unruly, bloody conflicts ensued, and for a considerable period the three great cities ruled the whole of Flanders with a high hand. Their influence in the foreign relations of the country was likewise great, it being in their interest to keep up friendly relations with England, on whose wool the flourishing state of the staple industry of Flanders depended. It is a remarkable fact that the historical position taken up by these cities, which politically belonged to France, is much more akin to the part played by the German towns, whereas Cambrai, whose population was French, is the only city politically situated in Germany, where a commune came to be established.

In the *Spanish peninsula*, the chief importance of the numerous small towns lay in the part they played as fortresses during the unceasing wars with the Moors. The kings therefore extended special privileges (*fueros*) to the inhabitants, and they were even at an early date admitted to representation in the Cortes (parliament). Of greater individual importance than all the rest was Barcelona. Already in 1068 Count Berengarius gave the city a special law (*usatici*) based on its ancient usages, and from the 14th century its commercial code (*libro del consolat del mar*) became influential all over southern Europe.

The constitutions of the *Scandinavian* towns were largely modelled on those of Germany, but the towns never attained anything like the same independence. Their dependence on the royal government most strongly comes out in the fact of their being uniformly regulated by royal law in each of the three kingdoms. In Sweden particularly, German merchants by law took an equal share in the government of the towns. In Denmark their influence was also great, and only in Norway did they remain in the position of foreigners in spite of their famous settlement at Bergen. The details, as well as those of the German settlement at Wisby and on the east coast of the Baltic, belong rather to the history of the Hanseatic League (*q.v.*). Denmark appears to be the only one of the three kingdoms where guilds at an early date played a part of importance.

BIBLIOGRAPHY.—The only book dealing with the subject in general, viz. K. D. Hüllmann, *Städtewesen des Mittelalters* (4 vols., Bonn, 1826–1828), is quite antiquated. For Germany it is best to consult Richard Schröder, *Lehrbuch der deutschen Rechtsgeschichte* (5th ed., Leipzig, 1907), §§ 51 and 56, where a bibliography as complete as need be is given, both of monographs dealing with various

aspects of the question, and of works on the history of individual towns. The latter alone covers two large octavo pages of small print. As a sort of complement to Schröder's chapters may be considered, F. Keutgen, *Urkunden zur städtischen Verfassungsgeschichte* (Berlin; 1901 = *Ausgewählte Urkunden zur deutschen Verfassungsgeschichte*, by G. von Below and F. Keutgen, vol. i.), a collection of 437 select charters and other documents, with a very full index. The great work of G. L. von Maurer, *Geschichte der Städteverfassung von Deutschland* (4 thick vols., Erlangen, 1869-1871), contains an enormous mass of information not always treated quite so critically as the present age requires. There is an excellent succinct account for general readers by Georg von Below, "Das ältere deutsche Städtewesen und Bürgertum," *Monographien zur Weltgeschichte*, vol. vi. (Bielefeld and Leipzig, 1898, illustrated). A number of the most important recent monographs have been mentioned above. As for Italy, the most valuable general work for the early times is still Carl Hegel, *Geschichte der Städteverfassung von Italien seit der Zeit der römischen Herrschaft bis zum Ausgang des zwölften Jahrhunderts* (2 small vols., Leipzig, 1847, price second-hand, M. 40), in which it was for the first time fully proved that there is no connexion between Roman and modern municipal constitutions. For the period from the 13th century it will perhaps be best to consult W. Assmann, *Geschichte des Mittelalters*, 3rd ed., by L. Viereck, dritte Abteilung, *Die letzten beiden Jahrhunderte des Mittelalters: Deutschland, die Schweiz, und Italien*, by R. Fischer, R. Scheppig and L. Viereck (Brunswick, 1906). In this volume, pp. 679-943 contain an excellent account of the various Italian states and cities during that period, with a full bibliography for each. Among recent critical contributions to the history of individual towns, the following works deserve to be specially mentioned: Robert Davidsohn, *Geschichte von Florenz* (Berlin, 1896-1908); down to the beginning of the 14th century); the same, *Forschungen zur Geschichte von Florenz* (vols. i.-iv., Berlin, 1896-1908); Heinrich Kretschmayr, *Geschichte von Venedig* (vol. i., Gotha, 1905, to 1205). For France, there are the works by Achille Luchaire, *Les Communes françaises à l'époque des Capétiens directs* (Paris, 1890), and Paul Viollet, "Les Communes françaises au moyen âge," *Mémoires de l'Académie des Inscriptions et Belles-lettres*, tome xxxvi. (Paris, 1900). There are, of course, also accounts in the great works on French institutions by Flach, Glasson, Viollet, Luchaire, but perhaps the one in Luchaire's *Manuel des institutions françaises, période des Capétiens directs* (Paris, 1892) deserves special recommendation. Another valuable account for France north of the Loire is that contained in the great work by Karl Hegel, *Städte und Gilden der germanischen Völker im Mittelalter* (2 vols., Leipzig, 1891; see *English Historical Review*, viii. 120-127). Of course, there are also numerous monographs, among which the following may be mentioned: Edouard Bonvalot, *Le Tiers État d'après la charte de Beaumont et ses filiales* (Paris, 1884); and A. Giry, *Les Établissements de Rouen* (2 vols., Paris, 1883-1885); also a collection of documents by Gustave Fagniez, *Documents relatifs à l'histoire de l'industrie et du commerce en France* (2 vols., Paris, 1898, 1900). Some valuable works on the commercial history of southern Europe should still be mentioned, such as W. Heyd, *Geschichte des Levantehandels im Mittelalter* (2 vols., Stuttgart, 1879; French edition by Furcy Raynaud, 2 vols., Paris, 1885 seq., improved by the author), recognized as a standard work; Adolf Schaube, *Handelsgeschichte der romanischen Völker des Mittelmeergebietes bis zum Ende der Kreuzzüge* (Munich and Berlin, 1906); Aloys Schulte, *Geschichte des mittelalterlichen Handels und Verkehrs zwischen Westdeutschland und Italien mit Ausschluss Venedigs* (2 vols., Leipzig, 1900); L. Goldschmidt, *Universalgeschichte des Handelsrechts* (vol. i., Stuttgart, 1891). As for the Scandinavian towns, the best guide is perhaps the book by K. Hegel, *Städte und Gilden der germanischen Völker*, already mentioned; but see also Dietrich Schäfer, "Der Stand der Geschichtswissenschaft im skandinavischen Norden," *Internationale Wochenschrift*, November 16, 1907. (F. K.)

COMMUNISM, the name loosely given to schemes of social organizations depending on the abolition of private property and its absorption into the property of a community as such. It is a form of what is now generally called socialism (*q.v.*), the terminology of which has varied a good deal according to time and place; but the expression "communism" may be conveniently used, as opposed to "socialism" in its wider political sense, or to the political and municipal varieties known as "collectivism," "state socialism," &c., in order to indicate more particularly the historical schemes propounded or put into practice for establishing certain ideally arranged communities composed of individuals living and working on the basis of holding their property in common. It has nothing, of course, to do with the Paris Commune, overthrown in May 1871, which was a political and not an economic movement. Communistic schemes have been advocated in almost every age and country, and have to be distinguished from mere anarchism or from the selfish desire to transfer other people's property into one's own pockets. The opinion that a communist is merely a man who

has no property to lose, and therefore advocates a redistribution of wealth, is contrary to the established facts as to those who have historically supported the theory of communism. The Corn-law Rhymer's lines on this subject are amusing, but only apply to the baser sort:—

"What is a Communist! One that hath yearnings
For equal division of unequal earnings.
Idler or bungler, or both, he is willing
To fork out his penny and pocket your shilling."

This is the communism of hostile criticism—a criticism, no doubt, ultimately based on certain fundamental facts in human nature, which have usually wrecked communistic schemes of a purely altruistic type in conception. But the great communists, like Plato, More, Saint-Simon, Robert Owen, were the very reverse of selfish or idle in their aims; and communism as a force in the historical evolution of economic and social opinion must be regarded on its ideal side, and not merely in its lapses, however natural the latter may be in operation, owing to the defects of human character. As a theory it has inspired not only some of the finest characters in history, but also much of the gradual evolution of economic organization—especially in the case of co-operation (*q.v.*); and its opportunities have naturally varied according to the state of social organization in particular countries. The communism of the early Christians, for instance, was rather a voluntary sharing of private property than any abnegation of property as such. The Essenes and the Therapeutae, however, in Palestine, had a stricter form of communism, and the former required the surrender of individual property; and in the middle ages various religious sects, followed by the monastic orders, were based on the communistic principle.

Communistic schemes have found advocates in almost every age and in many different countries. The one thing that is shared by all communists, whether speculative or practical, is deep dissatisfaction with the economic conditions by which they are surrounded. In Plato's *Republic* the dissatisfaction is not limited to merely economic conditions. In his examination of the body politic there is hardly any part which he can pronounce to be healthy. He would alter the life of the citizens of his state from the very moment of birth. Children are to be taken away from their parents and nurtured under the supervision of the state. The old nursery tales, "the blasphemous nonsense with which mothers fool the manhood out of their children," are to be suppressed. Dramatic and imitative poetry are not to be allowed. Education, marriage, the number of births, the occupations of the citizens are to be controlled by the guardians or heads of the state. The most perfect equality of conditions and careers is to be preserved; the women are to have similar training with the men, no careers and no ambition are to be forbidden to them; the inequalities and rivalries between rich and poor are to cease, because all will be provided for by the state. Other cities are divided against themselves. "Any ordinary city, however small, is in fact two cities, one the city of the poor, the other of the rich, at war with one another" (*Republic*, bk. iv. p. 249, Jowett's translation). But this ideal state is to be a perfect unit; although the citizens are divided into classes according to their capacity and ability, there is none of the exclusiveness of birth, and no inequality is to break the accord which binds all the citizens, both male and female, together into one harmonious whole. The marvellous comprehensiveness of the scheme for the government of this ideal state makes it belong as much to the modern as to the ancient world. Many of the social problems to which Plato draws attention are yet unsolved, and some are in process of solution in the direction indicated by him. He is not appalled by the immensity of the task which he has sketched out for himself and his followers. He admits that there are difficulties to be overcome, but he says in a sort of parenthesis, "Nothing great is easy." He refuses to be satisfied with half measures and patchwork reforms. "Enough, my friend! but what is enough while anything remains wanting?" These sentences indicate the spirit in which philosophical as distinguished from practical communists from the time of Plato till to-day have undertaken to reconstruct human society.

Sir Thomas More's *Utopia* has very many of the characteristics of *The Republic*. There is in it the same wonderful power of shaking off the prejudices of the place and time in which it was written. The government of Utopia is described as founded on popular election; community of goods prevailed, the magistrates distributed the instruments of production among the inhabitants, and the wealth resulting from their industry was shared by all. The use of money and all outward ostentation of wealth were forbidden. All meals were taken in common, and they were rendered attractive by the accompaniment of sweet strains of music, while the air was filled by the scent of the most delicate perfumes. More's ideal state differs in one important respect from Plato's. There was no community of wives in Utopia. The sacredness of the family relation and fidelity to the marriage contract were recognized by More as indispensable to the well-being of modern society. Plato, notwithstanding all the extraordinary originality with which he advocated the emancipation of women, was not able to free himself from the theory and practice of regarding the wife as part and parcel of the property of her husband. The fact, therefore, that he advocated community of property led him also to advocate community of wives. He speaks of "the possession and use of women and children," and proceeds to show how this possession and use must be regulated in his ideal state. Monogamy was to him mere exclusive possession on the part of one man of a piece of property which ought to be for the benefit of the public. The circumstance that he could not think of wives otherwise than as the property of their husbands only makes it the more remarkable that he claimed for women absolute equality of training and careers. The circumstance that communists have so frequently wrecked their projects by attacking marriage and advocating promiscuous intercourse between the sexes may probably be traced to the notion which regards a wife as being a mere item among the goods and chattels of her husband. It is not difficult to find evidence of the survival of this ancient habit of mind. "I will be master of what is mine own," says Petruccio. "She is my goods, my chattels."

The Perfectionists of Oneida, on the other hand, held that there was "no intrinsic difference between property in persons and property in things; and that the same spirit which abolished exclusiveness in regard to money would abolish, if circumstances allowed full scope to it, exclusiveness in regard to women and children" (Nordhoff's *Communitistic Societies of the United States*). It is this notion of a wife as property that is responsible for the wild opinions communists have often held in favour of a community of wives and the break-up of family relations. If they could shake off this notion and take hold of the conception of marriage as a contract, there is no reason why their views on the community of property should lead them to think that this contract should not include mutual fidelity and remain in force during the life of the contracting parties. It was probably not this conception of the marriage relation so much as the influence of Christianity which led More to discountenance community of wives in Utopia. It is strange that the same influence did not make him include the absence of slavery as one of the characteristics of his ideal state. On the contrary, however, we find in Utopia the anomaly of slavery existing side by side with institutions which otherwise embody the most absolute personal, political and religious freedom. The presence of slaves in Utopia is made use of to get rid of one of the practical difficulties of communism, viz. the performance of disagreeable work. In a society where one man is as good as another, and the means of subsistence are guaranteed to all alike, it is easy to imagine that it would be difficult to ensure the performance of the more laborious, dangerous and offensive kinds of labour. In Utopia, therefore, we are expressly told that "all the uneasy and sordid services" are performed by slaves. The institution of slavery was also made supplementary to the criminal system of Utopia, as the slaves were for the most part men who had been convicted of crime; slavery for life was made a substitute for capital punishment.

In many respects, however, More's views on the labour question

were vastly in advance of his own time. He repeats the indignant protest of the *Republic* that existing society is a warfare between rich and poor. "The rich," he says, "desire every means by which they may in the first place secure to themselves what they have amassed by wrong, and then take to their own use and profit, at the lowest possible price, the work and labour of the poor. And so soon as the rich decide on adopting these devices in the name of the public, then they become law." One might imagine these words had been quoted from the programme of The International (*q.v.*), so completely is their tone in sympathy with the hardships of the poor in all ages. More shared to the full the keen sympathy with the hopeless misery of the poor which has been the strong motive power of nearly all speculative communism. The life of the poor as he saw it was so wretched that he said, "Even a beast's life seems enviable!" Besides community of goods and equality of conditions, More advocated other means of ameliorating the condition of the people. Although the hours of labour were limited to six a day there was no scarcity, for in Utopia every one worked; there was no idle class, no idle individual even. The importance of this from an economic point of view is insisted on by More in a passage remarkable for the importance which he attaches to the industrial condition of women. "And this you will easily apprehend," he says, "if you consider how great a part of all other nations is quite idle. First, women generally do little, who are the half of mankind." Translated into modern language his proposals comprise universal compulsory education, a reduction of the hours of labour to six a day, the most modern principles of sanitary reform, a complete revision of criminal legislation, and the most absolute religious toleration. The romantic form which Sir Thomas More gave to his dream of a new social order found many imitators. The *Utopia* may be regarded as the prototype of Campanella's *City of the Sun*, Harrington's *Oceana*, Bacon's *Nova Atlantis*, Defoe's *Essay on Projects*, Fénelon's *Voyage dans l'Île des Plaisirs*, and other works of minor importance.

All communists have made a great point of the importance of universal education. All ideal communes have been provided by their authors with a perfect machinery for securing the education of every child. One of the first things done in every attempt to carry communistic theories into practice has been to establish a good school and guarantee education to every child. The first impulse to national education in the 19th century probably sprang from the very marked success of Robert Owen's schools in connexion with the cotton mills at New Lanark. Compulsory education, free trade, and law reform, the various movements connected with the improvement of the condition of women, have found their earliest advocates among theoretical and practical communists. The communists denounce the evils of the present state of society; the hopeless poverty of the poor, side by side with the self-regarding luxury of the rich, seems to them to cry aloud to Heaven for the creation of a new social organization. They proclaim the necessity of sweeping away the institution of private property, and insist that this great revolution, accompanied by universal education, free trade, a perfect administration of justice, and a due limitation of the numbers of the community, would put an end to half the self-made distress of humanity.

The various communistic experiments in America are the most interesting in modern times, opportunities being naturally greater there for such deviations from the normal forms of regulations as compared with the closely organized states of Europe, and particularly in the means of obtaining land cheaply for social settlements with peculiar views. They have been classified by Morris Hillquit (*History of Socialism in the United States*, 1903) as (1) sectarian, (2) Owenite, (3) Fourieristic, (4) Icarian.

1. The oldest of the sectarian group was the society of the Shakers (*q.v.*), whose first settlement at Watervliet was founded in 1776. The Harmony Society or Rappist Community was introduced into Pennsylvania by George Rapp (1770-1847) from Württemberg in 1804, and in 1815 they moved to a settlement (New Harmony) in Indiana, returning to Pennsylvania again in 1824, and founding the village of Economy, from which they were

also known as Economites. Emigrants from Württemberg also founded the community of Zoar in Ohio in 1817, being incorporated in 1832 as the Society of Separatists of Zoar; it was dissolved in 1898. The Amana (*q.v.*) community, the strongest of all American communistic societies, originated in Germany in the early part of the 18th century as "the True Inspiration Society," and some 600 members removed to America in 1842-1844. The Bethel (Missouri) and Aurora (Oregon) sister communities were founded by Dr Keil (1812-1877) in 1844 and 1856 respectively, and were dissolved in 1880 and 1881. The Oneida Community (*q.v.*), created by John Humphrey Noyes (1811-1886), the author of a famous *History of American Socialisms* (1870), was established in 1848 as a settlement for the Society of Perfectionists. All these bodies had a religious basis, and were formed with the object of enjoying the free exercise of their beliefs, and though communistic in character they had no political or strictly economic doctrine to propagate.

2. The Owenite communities rose under the influence of Robert Owen's work at New Lanark, and his propaganda in America from 1824 onwards, the principal being New Harmony (acquired from the Rappists in 1825); Yellow Springs, near Cincinnati, 1824; Nashoba, Tennessee, 1825; Haverstraw, New York, 1826; its short-lived successors, Coxsackie, New York, and the Kendal Community, Canton, Ohio, 1826. All these had more or less short existences, and were founded on Owen's theories of labour and economics.

3. The Fourierist communities similarly were due to the Utopian teachings of the Frenchman Charles Fourier (*q.v.*), introduced into America by his disciple Albert Brisbane (1809-1890), author of *The Social Destiny of Man* (1840), who was efficiently helped by Horace Greeley, George Ripley and others. The North American Phalanx, in New Jersey, was started in 1843 and lasted till 1855. Brook Farm (*q.v.*) was started as a Fourierist Phalanx in 1844, after three years' independent career, and became the centre of Fourierist propaganda, lasting till 1847. The Wisconsin Phalanx, or Ceresco, was organized in 1844, and lasted till 1850. In Pennsylvania seven communities were established between 1843 and 1845, the chief of which were the Sylvania Association, the Peace Union Settlement, the Social Reform Unity, and the Leraysville Phalanx. In New York state the chief were the Clarkson Phalanx, the Sodus Bay Phalanx, the Bloomfield Association, and the Ontario Union. In Ohio the principal were the Trumbull Phalanx, the Ohio Phalanx, the Clermont Phalanx, the Integral Phalanx, and the Columbian Phalanx; and of the remainder the Alphadelphia Phalanx, in Michigan, was the best-known. It is pointed out by Morris Hillquit that while only two Fourierist Phalanxes were established in France, over forty were started in the United States.

4. The Icarian communities were due to the communistic teachings of another Frenchman, Étienne Cabet (*q.v.*) (1788-1856), the name being derived from his social romance, *Voyage en Icarie* (1840), sketching the advantages of an imaginary country called Icaria, with a co-operative system, and criticizing the existing social organization. It was his idea, in fact, of a Utopia. Robert Owen advised him to establish his followers, already numerous, in Texas, and thither about 1500 went in 1848. But disappointment resulted, and their numbers dwindled to less than 500 in 1849; some 280 went to Nauvoo, Illinois; after a schism in 1856 some formed a new colony (1858) at Cheltenham, near St Louis; others went to Iowa, others to California. The last branch was dissolved in 1895.

See also the articles SOCIALISM; OWEN; SAINT-SIMON; FOURIER, &c.; and the bibliography to SOCIALISM. The whole subject is admirably covered in Morris Hillquit's work, referred to above; and see also Noyes's *History of American Socialisms* (1870); Charles Nordhoff's *Communistic Societies of the United States* (1875); and W. A. Hinds's *American Communities* (1878; 2nd edition, 1902), a very complete account.

COMMUTATION (from Lat. *commutare*, to change), a process of exchanging one thing for another, particularly of one method of payment for another, such as payment in money for payment in kind or by service, or of payment of a lump sum for periodical payments; for various kinds of such substitution see ANNUITY;

COPYHOLD and TITHES. The word is also used similarly of the substitution of a lesser sentence on a criminal for a greater. In electrical engineering, the word is applied to the reversal of the course of an electric current, the contrivance for so doing being known as a "commutator" (see DYNAMO). In America, a "commutation ticket" on a railway is one which allows a person to travel at a lower rate over a particular route for a certain time or for a certain number of times; the person holding such a ticket is known as a "commuter."

COMNENUS, the name of a Byzantine family which from 1081 to 1185 occupied the throne of Constantinople. It claimed a Roman origin, but its earliest representatives appear as landed proprietors in the district of Castamon (mod. *Kastamuni*) in Paphlagonia. Its first member known in Byzantine history is MANUEL EROTICUS COMNENUS, an able general who rendered great services to Basil II. (976-1025) in the East. At his death he left his two sons Isaac and John in the care of Basil, who gave them a careful education and advanced them to high official positions. The increasing unpopularity of the Macedonian dynasty culminated in a revolt of the nobles and the soldiery of Asia against its feeble representative Michael VI. Stratioticus, who abdicated after a brief resistance. Isaac was declared emperor, and crowned in St Sophia on the 2nd of September 1057. For the rulers of this dynasty see ROMAN EMPIRE, LATER, and separate articles.

With Andronicus I. (1183-1185) the rule of the Comneni proper at Constantinople came to an end. A younger line of the original house, after the establishment of the Latins at Constantinople in 1204, secured possession of a fragment of the empire in Asia Minor, and founded the empire of Trebizond (*q.v.*), which lasted till 1461, when David Comnenus, the last emperor, was deposed by Mahammed II.

For a general account of the family and its alleged survivors see article "Komnenen," by G. F. Hertzberg, in Ersch and Gruber's *Allgemeine Encyclopädie*, and an anonymous monograph, *Précis historique de la maison impériale des Comnènes* (Amsterdam, 1784); and, for the history of the period, the works referred to under ROMAN EMPIRE, LATER.

COMO (anc. *Comum*), a city and episcopal see of Lombardy, Italy, the capital of the province of Como, situated at the S. end of the W. branch of the Lake of Como, 30 m. by rail N. by W. of Milan. Pop. (1881) 25,560; (1905) 34,272 (town), 41,124 (commune). The city lies in a valley enclosed by mountains, the slopes of which command fine views of the lake. The old town, which preserves its rectangular plan from Roman times, is enclosed by walls, with towers constructed in the 12th century. The cathedral, built entirely of marble, occupies the site of an earlier church, and was begun in 1396, from which period the nave dates: the façade belongs to 1457-1486, while the east of the exterior was altered into the Renaissance style, and richly decorated with sculptures by Tommaso Rodari in 1487-1526. The dome is an unsuitable addition of 1731 by the Sicilian architect Filippo Juvara (1685-1735), and its baroque decorations spoil the effect of the fine Gothic interior. It contains some good pictures and fine tapestries. In the same line as the façade of the cathedral are the Broletto (in black and white marble), dating from 1215, the seat of the original rulers of the commune, and the massive clock-tower. The Romanesque church of S. Abondio outside the town was founded in 1013 and consecrated in 1095; it has two fine campanili, placed at the ends of the aisles close to the apse. It occupies the site of the 5th-century church of SS. Peter and Paul. Near it is the Romanesque church of S. Carpofo. Above it is the ruined castle of Baradello. The churches of S. Giacomo (1095-1117) and S. Fedele (12th century), both in the town, are also Romanesque, and the apses have external galleries. The Palazzo Giovo contains the Museo Civico. Como is a considerable tourist resort, and the steamboat traffic on the lake is largely for travellers. A climate station is established on the hill of Brunate (2350 ft.) above the town to the E., reached by a funicular railway. The Milanese possess many villas here. Como is an industrial town, having large silk factories and other industries (see LOMBARDY). It is connected with Milan by two lines of railway, one via Monza (the main line,

which goes on to Chiasso—Swiss frontier—and the St Gotthard), the other via Saronno and also with Lecco and Varese.

Of the Roman Comum little remains above ground; a portion of its S.E. wall was discovered and may be seen in the garden of the Liceo Volta, 88 ft. within the later walls: later fortifications (but previous to 1127), largely constructed with Roman inscribed sepulchral urns and other fragments, had been superimposed on it. Thermae have also been discovered (see V. Barelli in *Notizie degli scavi*, 1880, 333; 1881, 333; 1882, 285). The inscriptions, on the other hand, are numerous, and give an idea of its importance. The statements as to the tribe which originally possessed it are various. It belonged to Gallia Cisalpina, and first came into contact with Rome in 196 B.C., when M. Claudius Marcellus conquered the Insubres and the Comenses. In 89 B.C., having suffered damage from the Raetians, it was restored by Cn. Pompeius Strabo, and given Latin rights with the rest of Gallia Transpadana. Shortly after this 3000 colonists seem to have been sent there; 5000 were certainly sent by Caesar in 59 B.C., and the place received the name Novum Comum. It appears in the imperial period as a *municipium*, and is generally spoken of as Comum simply. The place was prosperous; it had an important iron industry; and the banks of the lake were, as now, dotted with villas. It was also important as the starting-point for the journey across the lake in connexion with the Splugen and Septimer passes (see CHIAVENNA). It was the birthplace of both the elder and the younger Pliny, the latter of whom founded baths and a library here and gave money for the support of orphan children. There was a *praefectus classis Comensis* under the late empire, and it was regarded as a strong fortress. See Ch. Hulsen in Pauly-Wissowa, *Realencyclopädie*, Suppl. Heft i. (Stuttgart, 1903), 326.

Como suffered considerably from the early barbarian invasions, many of the inhabitants taking refuge on the Isola Comacina off Sala, but recovered in Lombard times. It was from that period that the *magistri Comacini* formed a privileged corporation of architects and sculptors, who were employed in other parts of Italy also, until, at the end of the 11th century, individuals began to come more to the front (G. T. Rivoira, *Origini dell'architettura Lombarda*, Rome, 1901, i. 127 f.). Como then became subject to the archbishops of Milan, but gained its freedom towards the end of the 11th century. At the beginning of the 12th century war broke out between Como and Milan, and after a ten years' war Como was taken and its fortifications dismantled in 1127. In 1154, however, it took advantage of the arrival of Barbarossa, and remained faithful to him throughout the whole war of the Lombard League. After frequent struggles with Milan, it fell under the power of the Visconti in 1335. In 1535, like the rest of Lombardy, it fell under Spanish dominion, and in 1714 under Austrian. Thenceforth it shared the fortunes of Milan, becoming in the Napoleonic period the chief town of the department of the Lario. Its silk industry and its position at the entrance to the Alpine passes gave it some importance even then. It bore a considerable part in the national risings of 1848-1859 against Austrian rule. (T. As.)

COMO, LAKE OF (the *Lacus Larius* of the Romans, and so sometimes called LARIO to the present day, though in the 4th century it is already termed *Lacus Comacinus*), one of the most celebrated lakes in Lombardy, Northern Italy. It lies due N. of Milan and is formed by the Adda that flows through the Valtelline to the north end of the lake (here falls in the Maira or Mera, coming from the Val Bregaglia) and flows out of it at its south-eastern extremity, on the way to join the Po. Its area is 55½ sq. m., it is about 43 m. from end to end (about 30½ m. from the north end of Bellagio), it is from 1 to 2½ m. in breadth, its surface is 653 ft. above the sea, and its greatest depth is 1365 ft. A railway line now runs along its eastern shore from Colico to Lecco (24½ m.), while on its western shore Menaggio is reached by a steam tramway from Porlezza on the Lake of Lugano (8 m.). Colico, at the northern extremity, is by rail 17 m. from Chiavenna and 42 m. from Tirano, while at its southern end Como (on the St Gotthard line) is 32 m. from Milan, and Lecco about the same distance. The lake fills a remarkable depression, which

has been cut through the limestone ranges that enclose it, and once doubtless extended as far as Chiavenna, the Lake of Mezzola being a surviving witness of its ancient bed. Towards the south the promontory of Bellagio divides the lake into two arms. That to the south-east ends at Lecco and is the true outlet, for the south-western arm, ending at Como, is an enclosed bay. During the morning the *Tivano* wind blows from the north, while in the afternoon the *Breva* wind blows from the south. But, like other Alpine lakes, the Lake of Como is exposed to sudden violent storms. Its beauties have been sung by Virgil and Claudian, while the two Plinys are among the celebrities associated with the lake. The shores are bordered by splendid villas, while perhaps the most lovely spot on it is Bellagio, built in an unrivalled position. Among the other villages that line the lake, the best-known are Varenna (E.) and Menaggio (W.), nearly opposite one another, while Cadenabbia (W.) faces Bellagio. (W. A. B. C.)

COMONFORT, IGNACIO (1812-1863), a Mexican soldier and politician, who, after occupying a variety of civil and military posts, was in December 1855 made provisional president by Alvarez, and from December 1857 was for a few weeks constitutional president. (See MEXICO.)

COMORIN, CAPE, a headland in the state of Travancore, forming the extreme southern point of the peninsula of India. It is situated in 8° 4' 20" N., 77° 35' 35" E., and is the terminating point of the western Ghats. The village of Comorin, with the temple of Kanniyambal, the "virgin goddess," on the coast at the apex of the headland, is a frequented place of pilgrimage.

COMORO ISLANDS, a group of volcanic islands belonging to France, in the Indian Ocean, at the northern entrance of the Mozambique Channel midway between Madagascar and the African continent. The following table of the area and population of the four largest islands gives one of the sets of figures offered by various authorities:—

	Area sq. m.	Population.
Great Comoro	385	50,000
Anjuan or Johanna	145	12,000
Mayotte	140	11,000
Moheli	90	9,000
Total	760	82,000

There are besides a large number of islets of coral formation. Particulars of the four islands named follow.

1. Great Comoro, or Angazia, the largest and most westerly, has a length of about 38 m., with a width of about 12 m. Near its southern extremity it rises into a fine dome-shaped volcanic mountain, Kartola (Karthala), which is over 8500 ft. high, and is visible for more than 100 m. Up to about 6000 ft. it is clothed with dense vegetation. Eruptions are recorded for the years 1830, 1855 and 1858; and another eruption occurred in 1904. In the north the ground rises gradually to a plateau some 2000 ft. above the sea; from this plateau many regularly shaped truncated cones rise another 2000 ft. The centre of the island consists of a desert field of lava streams, about 1600 ft. high. The chief towns are Maroni (pop. about 2000), Itzanda and Mitsamuli; the first, situated at the head of a bay in 11° 40' S., being the seat of the French administrator.

2. Anjuan, or Johanna, next in size, lies E. by S. of Comoro. It is some 30 m. long by 20 at its greatest breadth. The land rises in a succession of richly wooded heights till it culminates in a central peak, upwards of 5000 ft. above the sea, in 12° 14' S., 44° 27' E. The former capital, Mossamondou, on the N.W. coast, is substantially built of stone, surrounded by a wall, and commanded by a dilapidated citadel; it is the residence of the sultan and of the French administrator. There is a small but safe anchorage at Pomony, on the S. side, formerly used as a coal depot by ships of the British navy.

3. Mayotte, about 21 m. long by 6 or 7 m. broad, is surrounded by an extensive and dangerous coral reef. The principal heights on its extremely irregular surface are: Mavegani Mountain, which rises in two peaks to a maximum of 2164 ft., and Uchongin,

2100 ft. The French headquarters are on the islet of Zaudzi, which lies within the reef in 12° 46' S., 45° 20' E. There are substantial government buildings and store-houses. On the mainland opposite Zaudzi is Msapéré, the chief centre of trade. Mayotte was devastated in 1898 by a cyclone of great severity.

4. Moheli or Mohilla lies S. of and between Anjuan and Grand Comoro. It is 15 m. long and 7 or 8 m. at its maximum breadth. Unlike the other three it has no peaks, but rises gradually to a central ridge about 1900 ft. in height. Fomboni (pop. about 2000) in the N.W. and Numa Choa in the S.W. are the chief towns.

All the islands possess a very fertile soil; there are forests of coco-nut palms, and among the products are rice, maize, sweet-potatoes, yams, coffee, cotton, vanilla and various tropical fruits, the papaw tree being abundant. The fauna is allied to that of Madagascar rather than to the mainland of Africa; it includes some land birds and a species of lemur peculiar to the islands. Large numbers of cattle and sheep, the former similar to the small species at Aden, are reared as well as, in Great Comoro, the zebra. Turtles are caught in abundance along the coasts, and form an article of export. The climate is in general warm, but not torrid nor unsuitable for Europeans. The dry season lasts from May to the end of October, the rest of the year being rainy. The natives are of mixed Malagasy, Negro and Arab blood. The majority are Mahomedans. The European inhabitants, mostly French, number about 600. There are some 200 British Indians, traders, in the islands. The external trade of the islands has developed since the annexation of Madagascar to France, and is of the value of about £100,000 a year. Sugar refineries, distilleries of rum, and sawmills are worked in Mayotte by French settlers. Cane sugar and vanilla are the chief exports. The islands are regularly visited by vessels of the Messageries Maritimes fleet, and a coaling station for the French navy has been established.

The islands were first visited by Europeans in the 16th century; they are marked on the map of Diego Ribero made in 1527. At that time, and for long afterwards, the dominant influence in, and the civilization of, the islands was Arab. According to tradition the islands were first peopled by Arab voyagers driven thither by tempests. The petty sultans who exercised authority were notorious slave traders. A Sakalava chief who had been driven from Madagascar by the Hovas took refuge in Mayotte c. 1830, and, with the aid of the sultan of Johanna, conquered the island, which for a century had been given over to civil war. French naval officers having reported on the strategic value of Mayotte, Admiral de Hell, governor of Réunion, sent an officer there in 1841, and a treaty was negotiated ceding the island to France. Possession was taken in 1843, the sultan of Johanna renouncing his claims in the same year. In 1886 the sultans of the other three islands were placed under French protection, France fearing that otherwise the islands would be taken by Germany. The French experienced some difficulty with the natives, but by 1892 had established their position. The islands, as regulated by the decree of the 9th of April 1908, are under the supreme authority of the governor-general of Madagascar. The local administration is in the hands of an official who himself governs Mayotte but is represented in the other islands by administrators. On the council which assists the governor are two nominated native notables. In 1910 the sultan of Great Comoro ceded his sovereign rights to France. In Anjuan the native government is continued under French supervision. The budgets of the four islands in 1904 came to some £30,000, that of Mayotte being about half the total. The chief sources of revenue are poll and house taxes, and, in Mayotte, a land tax.

The *Iles Glorieuses*, three islets 160 m. N.E. of Mayotte, with a population of some 20 souls engaged in the collection of guano and the capture of turtles, were in 1892 annexed to France and placed under the control of the administrator of Mayotte.

See *Notice sur Mayotte et les Comores*, by Emile Vienne, one of the memoirs on the French colonies prepared for the Paris Exhibition of 1900; *Le Sultanat d'Anjuan*, by Jules Repiquet (Paris, 1901), a systematic account of the geography, ethnology and history of Johanna; *Les colonies françaises* (Paris, 1900), vol. ii. pp. 179-197,

in which the story of the archipelago is set forth by various writers; an account of the islands by A. Voeltzkow in the *Zeitschrift* of the Berlin Geog. Soc. (No. 9, 1906), and *Carte des Iles Comores*, by A. Meunier (Paris, 1904).

COMPANION (through the O. Fr. *compaignon* or *compagnon*, from the Late Lat. *companio*,—*cum*, with, and *panis*, bread,—one who shares meals with another; the word has been wrongly derived from the Late Lat. *compagnus*, one of the same *pagus* or district), a mess-mate or "comrade" (a term which itself has a similar origin, meaning one who shares the same *camera* or room). "Companion" is particularly used of soldiers, as in the expression "companion in arms," and so is the title of the lowest rank in a military or other order of knighthood; the word is also used of a person who lives with another in a paid position for the sake of company, and is looked on rather as a friend than a servant; and of a pair or match, as of pictures and the like. Similar in ultimate origin but directly adapted from the Fr. *chambre de la compagne*, and Ital. *camera della compagna*, the storeroom for provisions on board ship, is the use of "companion" for the framed windows over a hatchway on the deck of a ship, and also for the hooded entrance-stairs to the captain's cabin.

COMPANY, one of a number of words like "partnership," "union," "gild," "society," "corporation," denoting—each with its special shade of meaning—the association of individuals in pursuit of some common object. The taking of meals together was, as the word signifies (*cum*, with, *panis*, bread,) a characteristic of the early company. Gild had a similar meaning; but this characteristic, though it survives in the Livery company (see **LIVERY COMPANIES**), has in modern times disappeared. The word "company" is now monopolized—in British usage—by two great classes of companies—(1) the joint stock company, constituted under the Companies (Consolidation) Act 1908, which consolidated the various acts from 1862 to 1907, and (2) the "public company," constituted under a special act to carry on some work of public utility, such as a railway, docks, gas-works or waterworks, and regulated by the Companies Clauses Acts 1845 and 1863.

1. Joint Stock Companies.

The joint stock company may be defined as an association of persons incorporated to promote by joint contributions to a common stock the carrying on of some commercial enterprise. Associations formed not for "the acquisition of gain" but to promote art, science, religion, charity or some other useful or philanthropic object, though they may be constituted under the Companies (Consolidation) Act 1908, seldom call themselves companies, but adopt some name more appropriate to express their objects, such as society, club, institute, college or chamber. The joint stock company has had a long history which can only be briefly sketched here. The name of "joint stock company" is—or was—used to distinguish such a company from the "regulated company," which did not trade on a joint stock but was in the nature of a trade gild, the members of which had a monopoly of foreign trade with particular countries or places (see Adam Smith, *Wealth of Nations*, bk. v. ch. i. pt. iii.).

The earliest kind of joint stock company is the chartered (see **CHARTERED COMPANIES**). The grant of a charter is one of the exclusive privileges of the crown, and the crown has from time to time exercised it in furtherance of trading enterprise. Examples of such grants are the Merchant Adventurers of England, chartered by Richard II. (1390); the East India Co., chartered by Queen Elizabeth (1600); the Bank of England, chartered by William and Mary (1694); the Hudson's Bay Co.; the Royal African Co.; the notorious South Sea Co.; and in later times the New Zealand Co., the North Borneo Co., and the Royal Niger Co. Chartered companies had, however, several disadvantages. A charter was not easily obtainable. It was costly. The members could not be made personally liable for the debts of the company; and once created—though only for defined objects—such a company was invested with entire independence and could not be kept to the conditions imposed by the grant, which was against public policy. A new form of commercial association was wanted, free from these defects, and it was found in the common law

company—the lineal ancestor of the modern trading company. The common law company was not an incorporated association: it was simply a great partnership with transferable shares. Companies of this kind multiplied rapidly towards the close of the 17th century and the beginning of the 18th century, but they were regarded with strong disfavour by the law, for reasons not very intelligible to modern notions; the chief of these reasons being that such companies purported to act as corporate bodies, raised transferable stock, used charters for purposes not warranted by the grant, and were—or were supposed to be—dangerous and mischievous, tending (in the words of the preamble of the Bubble Act) to “the common grievance, prejudice and inconvenience of His Majesty’s subjects or great numbers of them in trade, commerce or other lawful affairs.” They were too often—and this no doubt was the real ground of the prejudice against them—utilized by unprincipled persons to promote fantastic and often fraudulent schemes. Matthew Green, in his poem “The Spleen,” notes how

“Wrecks appear each day,
And yet fresh fools are cast away.”

The result was that by the act (6 Geo. I. c. 18) commonly known as the Bubble Act (1719) such companies were declared to be common nuisances and indictable as such. But the act, though it remained on the statute book for more than one hundred years and was not formally repealed till 1825, proved quite ineffectual to check the growth of joint stock enterprise, and the legislature, finding that such companies had to be tolerated, adopted the wiser course of regulating what it could not repress. One great inconvenience of these common law trading companies arose from their being unincorporated. They were formed of large fluctuating bodies of individuals, and a person dealing with them did not know with whom he was contracting or whom he was to sue. This evil the legislature sought to rectify by empowering the crown to grant to companies by letters patent without incorporation the privilege of suing and being sued by a public officer. Ten years afterwards—in 1844—a more important line of policy was adopted, and all companies with some exceptions were enabled to obtain a certificate of incorporation without applying for a charter or special act. The act of 1862 carried this policy one step farther by prohibiting all associations of more than twenty persons from carrying on business without registering under the act. These were all useful amendments, but they were amendments of form rather than substance. The real vitality of joint stock enterprise lies in the co-operative principle, and the natural growth and expansion of this fruitful principle was checked until the middle of the 19th century by the notorious risks attaching to unlimited liability. In the case of an ordinary partnership, though their liability is unlimited (or was until the Limited Partnerships Act 1907), the partners can generally tell what risks they are incurring. Not so the shareholders of a company. They delegate the management of their business to a board of directors, and they may easily find themselves committed by the fraud or folly of its members to engagements which in the days of unlimited liability meant ruin. Failures like those of Overend and Gurney, and of the Glasgow Bank, caused widespread misery and alarm. It was not until limited liability had been grafted on the stock of the co-operative system that the real potency of the principle of industrial co-operation became apparent. We owe the adoption of the limited liability principle to the clear-sightedness of Lord Sherbrooke—then Mr Robert Lowe—and to the vigorous advocacy of Lord Bramwell. We owe it to Lord Bramwell also that the principle was made a feasible one. The practical difficulty was how to bring home to persons dealing with the company notice that the liability of the shareholders was limited. Lord Bramwell solved the problem by a happy suggestion—“write it on my tombstone,” he said humorously to a friend. This was that the company should add to its name the word “Limited”—paint it up on its premises, and use it on all invoices, bills, promissory notes and other documents. The proposal was adopted by the Legislature and has worked successfully. While limited companies have been

multiplying at the rate of over 4000 a year, the unlimited company has become practically an extinct species. The growth of limited companies is, indeed, one of the most striking phenomena of our day. Their number may be estimated at quite 40,000. Their paid-up capital amounts to the stupendous sum of £1,850,000,000 and, what is even more significant, as the 1st Viscount Goschen remarks in his *Essays and Addresses*, is that “the number of shareholders has grown in a much greater ratio than the colossal growth of the aggregate capital. The profits and risks of nearly every kind of business have been spread from year to year over fresh thousands of individuals, and the middle class with moderate incomes are more and more participating in that accumulation of wealth from business of every description which formerly built up the fortunes of individual traders or of bankers or of single families.”

It is with the limited company then—the company limited by shares—as the normal type and incomparably the most important, that this article mainly deals.

Companies Limited by Shares.—The Companies Act 1862, was intended to constitute a comprehensive code of law applicable to joint stock trading companies for the whole of the United Kingdom. Recognizing the mischief above alluded to—of trading concerns being carried on by large and fluctuating bodies, the act begins by declaring that no company, association or partnership, consisting of more than twenty persons, or ten in the case of banking, shall be formed after the commencement of the act for the purpose of carrying on any business which has for its object the acquisition of gain by the company, association or partnership, or by the individual members thereof, unless it is registered as a company under the act, or is formed in pursuance of some other act of parliament or of letters patent, or is a company engaged in working mines within and subject to the jurisdiction of the Stannaries. Broadly speaking, the meaning of the act is that all commercial undertakings, as distinguished from literary or charitable associations, shall be registered. “Business” has a more extensive signification than “trade.” Having thus cleared the ground the act goes on to provide in what manner a company may be formed under the act. The machinery is simple, and is described as follows:—

“Any seven or more persons associated for any lawful purpose may, by subscribing their names to a memorandum of association and otherwise complying with the requisitions of this act in respect of registration, form an incorporated company with or without limited liability” (§ 6). It is not necessary that the subscribers should be traders nor will the fact that six of the subscribers are mere dummies, clerks or nominees of the seventh affect the validity of the company; so the House of Lords decided in *Salomon v. Salomon & Co.*, 1897, A. C. 22.

The document to be subscribed—the Memorandum of Association—corresponds, in the case of companies formed under the Companies Act 1862, to the charter or deed of settlement in the case of other companies. The form of it is given in the schedule to the act, and varies slightly according as the company is limited by shares or guaranteed, or is unlimited. (See the 3rd schedule to the Consolidation Act 1908, forms A, B, C, D.) It is required to state, in the case of a company limited by shares, the five following matters:—

1. The name of the proposed company, with the addition of the word “limited” as the last word in such name.
2. The part of the United Kingdom, whether England, Scotland or Ireland, in which the registered office of the company is proposed to be situate.
3. The objects for which the proposed company is to be established.
4. A declaration that the liability of the members is limited.
5. The amount of capital with which the company proposes to be registered, divided into shares of a certain fixed amount.

No subscriber of the memorandum is to take less than one share, and each subscriber is to write opposite his name the number of shares he takes.

These five matters the legislature has deemed of such intrinsic importance that it has required them to be set out in the

Memorandum of Association.

company's Memorandum of Association. They are the essential conditions of incorporation, and as such they must not only be stated, but the policy of the legislature has made them with certain exceptions unalterable.

The most important of these five conditions is the third, and its importance consists in this, that the objects defined in the memorandum circumscribe the sphere of the company's activities. This principle, which is one of public policy and convenience, and is known as the "*ultra vires* doctrine," carries with it important consequences, because every act done or contract made by a company *ultra vires*, i.e. in excess of its powers, is absolutely null and void. The policy, too, is a sound one. Shareholders contribute their money on the faith that it is to be employed in prosecuting certain objects, and it would be a violation of good faith if the company, i.e. the majority of shareholders, were to be allowed to divert it to something quite different. So strict is the rule that not even the consent of every individual shareholder can give validity to an *ultra vires* act.

The articles of association are the regulations for internal management of the company—the terms of the partnership

agreed upon by the shareholders among themselves. A model or specimen set of articles known as Table A was given by the Companies Act 1862, and is appended in a revised form to the Companies (Consolidation) Act 1908. When a company is to be registered the memorandum of association accompanied by a copy of the articles is taken to the office of the registrar of joint stock companies at Somerset House, together with the following documents:—

1. A list of persons who have consented to be directors of the company (fee stamp 5s.).

2. A statutory declaration by a solicitor of the High Court engaged in the formation of the company, or by a person named in the articles of association as a director or secretary of the company, that the requisitions of the act in respect of registration and of matters precedent and incidental thereto have been complied with (fee stamp 5s.).

3. A statement as to the nominal share capital (stamped with an *ad valorem* duty of 5s. per £100).

4. If no prospectus is to be issued, a company must now (Companies Act 1907, s. 1; Consolidation Act 1908, s. 82) in lieu thereof file with the registrar a statement, in the form prescribed by the 1st schedule to the act, of all the material facts relating to the company. Till this has been done the company cannot allot any shares or debentures.

If these documents are in order the registrar registers the company and issues a certificate of incorporation (see Companies (Consolidation) Act 1908, sect. 82); on registration, the memorandum and articles of association become public documents, and any person may inspect them on payment of a fee of one shilling. This has important consequences, because every person dealing with the company is presumed to be acquainted with its constitution, and to have read its memorandum and articles. The articles also, upon registration, bind the company and its members to the same extent as if each member had subscribed his name and affixed his seal to them.

The total cost of registering a company with a capital of £1000 is about £7; £10,000 about £34; £100,000 about £280.

The capital which is required to be stated in the memorandum of association, and which represents the amount which the

Capital. company is empowered to issue, is what is known as the nominal capital. This nominal capital must be distinguished from the subscribed capital. Subscribed capital is the aggregate amount agreed to be paid by those who have taken shares in the company. Under the Companies Act 1900, Companies Act 1908, s. 85, a "minimum subscription" may be fixed by the articles, and if it is the directors cannot go to allotment on less: if it is not, then the whole of the capital offered for subscription must be subscribed. A company may increase its capital, consolidate it, subdivide it into shares of smaller amount and convert paid-up shares into stock. It may also, with the sanction of the court, otherwise reorganize its capital (Companies Act 1907, s. 39; Companies (Consolidation) Act

1908, s. 45), and for this purpose modify its Memorandum of Association; but a limited company cannot reduce its capital either by direct or indirect means without the sanction of the court. The inviolability of the capital is a condition of incorporation—the price of the privilege of trading with limited liability, and by no subterfuge will a company be allowed to evade this cardinal rule of policy, either by paying dividends out of capital, or buying its own shares, or returning money to shareholders. But the prohibition against reduction means that the capital must not be reduced by the voluntary act of the company, not that a company's capital must be kept intact. It is embarked in the company's business, and it must run the risks of such business. If part of it is lost there is no obligation on the company to replace it and to cease paying dividends until such lost capital is repaid. The company may in such a case write off the lost capital and go on trading with the reduced amount. But for this purpose the sanction of the court must be obtained by petition.

A share is an aliquot part of a company's nominal capital. The amount may be anything from 1s. to £1000. The tendency of late years has been to keep the denomination low, and so to appeal to a wider public. Shares of £100, or even £10, are now the exception. The most common amount is either £1 or £5. Shares are of various kinds—ordinary, preference, deferred, founders' and management. Into what classes of shares the original capital of the company shall be divided, what shall be the amount of each class, and their respective rights, privileges and priorities, are matters for the consideration of the promoters of the company, and must depend on its special circumstances and requirements.

A company may issue preference shares even if there is no mention of them in the Memorandum of Association, and any preference or special privilege so given to a class of shares cannot be interfered with on any reorganization of capital except by a resolution passed by a majority of shareholders of that class representing three-fourths of the capital of that class (Companies (Consolidation) Act 1908, s. 45). The preference given may be as to dividends only, or as to dividends and capital. The dividend, again, may be payable out of the year's profits only, or it may be cumulative, that is, a deficiency in one year is to be made good out of the profits of subsequent years. *Prima facie*, a preferential dividend is cumulative. For issuing preference shares the question for the directors is, what must be offered to attract investors. Preference shareholders are given by the Companies Act 1907, s. 23; Companies (Consolidation) Act 1908, s. 114, the right to inspect balance sheets. Founders' shares—which originated with private companies—are shares which usually take the whole or half the profits after payment of a dividend of 7 or 10% to the ordinary shareholders. They are much less in favour than they used to be.

The machinery of company formation is generally set in motion by a person known as a promoter. This is a term of business, not law. It means, to use Chief Justice Cockburn's words, a person "who undertakes to form a company with reference to a given project and to set it going, and who takes the necessary steps to accomplish that purpose." Whether what a person has done towards this end constitutes him a promoter or not, is a question of fact; but once an affirmative conclusion is reached, equity clothes such promoter with a fiduciary relation towards the company which he has been instrumental in creating. This doctrine is now well established, and its good sense is apparent when once the position of the promoter towards the company is understood. Promoters—to use Lord Cairns's language in *Erlanger v. New Sombrero Phosphate Co.*, 3 A. C. 1236—"have in their hands the creation and moulding of the company. They have the power of defining how and when and in what shape and under what supervision it shall start into existence and begin to act as a trading corporation." Such a control over the destinies of the company involves correlative obligations towards it, and one of these obligations is that the promoter must not take advantage of the company's helplessness. A promoter

may sell his property to the company, but he must first see that the company is furnished with an independent board of directors to protect its interests and he must make full and fair disclosure of his interest in order that the company may determine whether it will or will not authorize its trustee or agent (for such the promoter in equity is) to make a profit out of the sale. It is not a sufficient disclosure in such a case for the promoter merely to refer in the prospectus to a contract which, if read by the shareholders, would inform them of his interest. They are under no obligation to inquire. It is for the promoter to bring home notice, not constructive but actual, to the shareholders.

When a company is promoted for acquiring property—to work a mine or patent, for instance, or carry on a going business—the usual course is for the promoter to frame a draft agreement for the sale of the property to the company or to a trustee on its behalf. The memorandum and articles of the intended company are then prepared, and an article is inserted authorizing or requiring the directors to adopt the draft agreement for sale. In pursuance of this authority the directors at the first meeting after incorporation take the draft agreement into consideration; and if they approve, adopt it. Where they do so in the exercise of an honest and independent judgment, no exception can be taken to the transaction; but where the directors happen to be nominees of the promoter, perhaps qualified by him and acting in his interest, the situation is obviously open to grave abuse. It is not too much, indeed, to say that the fastening of an onerous or imprudent contract on a company at its start, by interested promoters acting in collusion with the directors, has been the principal cause of the scandals associated with company promotion.

Concurrently with the adoption of the contract for the acquisition of the property which is the company's *raison d'être*, the directors have to consider how they will best get the company's capital subscribed. Down to the passing of the Companies Act 1900 the usual mode of doing this was to issue a prospectus inviting the public to subscribe for shares. After the act of 1900 the prospectus fell into general disuse. In the year 1903, out of a total of 3596 companies which registered, only 358 issued a prospectus, the directors preferring, it would seem, to place the share capital through the medium of brokers, financial agents and other intermediaries rather than run the risk of incurring, personally, liability under the stringent provisions for disclosure contained in the act (s. 10). Of late the prospectus has, however, returned into favour. Under the act of 1907, incorporated in the Consolidation Act 1908 (s. 82), a company, if it does not issue a prospectus, must file a statement of all the material facts relating to the company.

A prospectus is an invitation to the public to take shares on the faith of the statements therein contained, and is thus the basis of the agreement to take the shares; there therefore rests on those who are responsible for its issue an obligation to act with the most perfect good faith—*uberrima fides*—and this obligation has been repeatedly emphasized by judges of the highest eminence. (See the observations of Kindersley, V.C., in *New Brunswick Railway Co. v. Muggeridge*, 1860, 1 Dr. & Sm. 383, and of Lord Herschell in *Derry v. Peck*, 1889, 14 A. C. 376.) Directors must be perfectly candid with the public; they must not only state what they do state with strict and scrupulous accuracy, but they must not omit any fact which, if disclosed, would falsify the statements made. This is the general obligation of directors when issuing a prospectus; but on this general obligation the legislature has engrafted special requirements. By the Companies Act 1867, it required the dates and names of the parties to any contract entered into by the company or its promoters or directors before the issue of the prospectus, to be disclosed in the prospectus; otherwise the prospectus was to be deemed fraudulent. This enactment was repealed by the Companies Act 1900, but only in favour of more stringent provisions incorporated in the Consolidation Act of 1908. Now, not only is every prospectus to be signed and filed with the registrar of Joint Stock Companies before it can be issued, but the prospectus must set forth a long

and elaborate series of particulars about the company—the contents of the Memorandum of Association, with the names of the signatories, the share qualification (if any) of the directors, the minimum subscription on which the directors may proceed to allotment, the shares and debentures issued otherwise than for cash, the names and addresses of the vendors, the amount paid for underwriting the company, the amount of preliminary expenses, of promotion money (if any), and the interest (if any) of every director in the promotion or in property to be acquired by the company. Neglect of this statutory duty of disclosure will expose directors to personal liability. For false or fraudulent statements—as distinguished from non-disclosure—in a prospectus directors are liable in an action of deceit or under the Directors' Liability Act 1890, now incorporated in the act of 1908. This act was passed to meet the decision of the House of Lords in *Peck v. Derry* (12 A. C. 337), that a director could not be made liable in an action of deceit for an untrue statement in a prospectus, unless the plaintiff could prove that the director had made the untrue statement fraudulently. The Directors' Liability Act enacted in substance that when once a prospectus is proved to contain a material statement of fact which is untrue, the persons responsible for the prospectus are to be liable to pay compensation to any one who has subscribed on the faith of the prospectus, unless they can prove that they had reasonable ground to believe, and did in fact believe, the statement to be true. Actions under this act have been rare, but their rarity may be due to the act having had the effect of making directors more careful in their statements.

Before the passing of the Companies Act 1900, it was a matter for directors' discretion on what subscription they should go to allotment. They often did so on a scandalously inadequate subscription. To remedy this abuse the Companies Act 1900 (Companies (Consolidation) Act 1908, s. 85) provided that no allotment of any share capital offered to the public for subscription is to be made unless the amount fixed by the memorandum and articles of association and named in the prospectus as "the minimum subscription" upon which the directors may proceed to allotment has been subscribed and the application moneys—which must not be less than 5% of the nominal amount of the share—paid to and received by the company. If no minimum is fixed the whole amount of the share capital offered for subscription must have been subscribed before the directors can go to allotment. The "minimum subscription" is to be reckoned exclusively of any amount payable otherwise than in cash. If these conditions are not complied with within forty days the application moneys must be returned. Any "waiver clause" or contract to waive compliance with the section is to be void.

An allotment of shares made in contravention of these provisions is irregular and voidable at the option of the applicant for shares within one month after the first or statutory meeting of the company (Companies (Consolidation) Act, s. 86). Even when a company has got what under the name of the "minimum subscription" the directors deem enough capital for its enterprise, it cannot now commence business or make any binding contract or exercise any borrowing powers until it has obtained a certificate entitling it to commence business (Companies (Consolidation) Act 1908, s. 87). To obtain this certificate the company must have fulfilled certain statutory conditions, which are briefly these:—

- (a) The company must have allotted shares to the amount of not less than the "minimum subscription."
- (b) Every director must have paid up his shares in the same proportion as the other members of the company.
- (c) A statutory declaration, made by the secretary of the company or one of the directors, must have been filed with the registrar of joint stock companies, that these conditions have been complied with.

These conditions fulfilled, the company gets its certificate and starts on its business career, carrying on its business through the agency of directors, as to whose powers and duties see DIRECTORS.

The Companies Act as consolidated in the act of 1908, and

Allotment
of shares.

Pro-
spectus.

the regulations under them, treat the directors of a company as the persons in whom the management of the company's affairs is vested. But they also contemplate the ultimate controlling power as residing in the shareholders. A controlling power of this kind can only assert itself through general meetings; and that it may have proper opportunities of doing so, every company is required to hold a general meeting, commonly called the statutory meeting, within—as fixed by the Companies Act 1900—three months from the date at which it is entitled to commence business. This first statutory meeting acquired new significance under the Companies Act of 1900 and marks an important stage in the early history of a company. Seven days before it takes place the directors are required to send round to the members a certified report informing them of the general state of the company's affairs—the number of shares allotted, cash received for them, and names and addresses of the members, the amount of preliminary expenses, the particulars of any contract to be submitted to the meeting, &c. Furnished with this report the members come to the meeting in a position to discuss and exercise an intelligent judgment upon the state and prospects of the company. Besides the statutory meeting a company must hold one general meeting at least in every calendar year, and not more than fifteen months after the holding of the last preceding general meeting (Companies (Consolidation) Act 1908, s. 64). This annual general meeting is usually called the ordinary general meeting. Other meetings are extraordinary general meetings. Notices convening a general meeting must inform the shareholders of the particular business to be transacted; otherwise any resolutions passed at the meeting will be invalidated. Voting is generally regulated by the articles. Sometimes a vote is given to a shareholder for every share held by him, but more often a scale is adopted; for instance, one vote is given for every share up to ten, with an additional vote for every five shares beyond the first ten shares up to one hundred, and an additional vote for every ten shares beyond the first hundred. In default of any regulations, every member has one vote only. Sometimes preference shareholders are given no vote at all. A poll may be demanded on any special resolution by three persons unless the articles require five (Companies (Consolidation) Act 1908, s. 69).

A contract to take shares is like any other contract. It is constituted by offer, acceptance and communication of the acceptance to the offerer. The offer in the case of shares is usually in the form of an application in writing to the company, made in response to a prospectus, requesting the company to allot the applicant a certain number of shares in the undertaking on the terms of the prospectus, and agreeing to accept the shares, or any smaller number, which may be allotted to the applicant. An allottee is under the Companies (Consolidation) Act 1908, s. 86, entitled to rescind his contract where the allotment is irregular, e.g. where the minimum subscription has not been obtained. When an application is accepted the shares are allotted, and a letter of allotment is posted to the applicant. Allotment is the usual, but not the only, evidence of acceptance. As soon as the letter of allotment is posted the contract is complete, even though the letter never reaches the applicant. An application for shares can be withdrawn at any time before acceptance. As soon as the contract is complete, it is the duty of the company to enter the shareholder's name in the register of members, and to issue to him a certificate under the seal of the company, evidencing his title to the shares.

The register of members plays an important part in the scheme of the company system, under the Companies Act 1862.

The principle of limited liability having been once adopted by the legislature, justice required not only that such limitation of liability should be brought home by every possible means to persons dealing with the company, but also that such persons should know as far as possible what was the limited capital which was the sole fund available to satisfy their claims—what amount had been called up, what remained uncalled, who were the persons to pay,

and in what amounts. These data might materially assist a person dealing with the company in determining whether he would give it credit or not; in any case they are matters which the public had a right to know. The legislature, recognizing this, has exacted as a condition of the privilege of trading with limited liability that the company shall keep a register with those particulars in it, which shall be accessible to the public at all reasonable times. In order that this register may be accurate, and correspond with the true liability of membership for the time being, the court is empowered under the Companies Act 1862, and the Companies (Consolidation) Act 1908, s. 32, to rectify it in a summary way, on application by motion, by ordering the name of a person to be entered on or removed therefrom. This power can be exercised by the court, whether the dispute as to membership is one between the company and an alleged member, or between one alleged member and another, but the machinery of the section is not meant to be used to try claims to rescind agreements to take shares. The proper proceeding in such cases is by action.

The same policy of guarding against an abuse of limited liability is evinced in the Companies Act 1862, which required that shares in the case of a limited company should be paid for in full. The legislature has allowed such companies to trade with limited liability, but the price of the privilege is that the limited capital to which alone the creditors can look shall at least be a reality. It is therefore *ultra vires* for a limited company to issue its shares at a discount; but there was nothing in the Companies Act 1862 which required that the shares of a limited company, though they must be paid up in full, must be paid up in cash. They might be paid "in meal or in malt," and it accordingly became common for shares to be allotted in payment for furniture, plate, advertisements or services. The result was that the consideration was often illusory, shares being issued to be paid for in some commodity which had no certain criterion of value. To remedy this evil the legislature enacted in the Companies Act 1867, s. 25, that every share in any company should be held subject to the payment of the whole amount thereof in cash, unless otherwise determined by a contract in writing filed with the registrar of joint stock companies at or before the issue of the shares. This section not infrequently caused hardship where shares had been honestly paid for in the equivalent of cash, but owing to inadvertence no contract had been filed; and it was repealed by the Companies Act 1900, and the old law restored. In reverting to the earlier law, and allowing shares to be paid for in any adequate consideration, the legislature has, however, exacted a safeguard. It has required the company to file with the registrar of joint stock companies a return stating, in the case of shares allotted in whole or in part for a consideration other than cash, the number of the shares so allotted, and the nature of the consideration—property, services, &c.—for which they have been allotted.

Though every share carries with it the liability to pay up the full amount in cash or its equivalent, the liability is only to pay when and if the directors call for it to be paid up. A call must fix the time and place for payment, otherwise it is bad.

When a person takes shares from a company on the faith of a prospectus containing any false or fraudulent representations of fact material to the contract, he is entitled to rescind the contract. The company cannot keep a contract obtained by the misrepresentation or fraud of its agents. This is an elementary principle of law.

The misrepresentation, for purposes of rescission, need not be fraudulent; it is sufficient that it is false in fact: fraud or recklessness of assertion will give the shareholder a further remedy by action of deceit, or under the Directors' Liability Act 1890 (see *supra*); but, to entitle a shareholder to rescind, he must show that he took the shares on the faith or partly on the faith of the false representation: if not, it was innocuous. A shareholder claiming to rescind must do so promptly. It is too late to commence proceedings after a winding-up has begun.

Meetings.**Agreement for shares.****Agreement for shares.****Register of members.****Payment for shares.****Rescission of agreement.**

The shares or other interest of any member in a company are personal estate and may be transferred in the manner provided by the regulations of the company. As Lord Blackburn said, one of the chief objects when joint stock companies were established was that the shares should be capable of being easily transferred; but though every shareholder has a prima facie right to transfer his shares, this right is subject to the regulations of the company, and the company may and usually does by its regulations require that a transfer shall receive the approval of the board of directors before being registered,—the object being to secure the company against having an insolvent or undesirable shareholder (the nominee perhaps of a rival company) substituted for a solvent and acceptable one. This power of the directors to refuse a transfer must not, however, be exercised arbitrarily or capriciously. If it were, it would amount to a confiscation of the shares. Directors, for instance, cannot veto a transfer because they disapprove of the purpose for which it is being made (e.g. to multiply votes), if there is no objection to the transferee.

It is a common and convenient practice to deposit share or stock certificates with bankers and others to secure an advance.

Blank transfers. When this is done the share or stock certificate is usually accompanied by a blank transfer—that is, a transfer executed by the shareholder borrower, but with a blank left for the name of the transferee. The handing over by the borrower of such blank transfer signed by him is an implied authority to the banker, or other pledgee, if the loan is not paid, to fill in the blank with his name and get himself registered as the owner.

A company can only pay dividends out of profits—which have been defined as the “earnings of a concern after deducting the expenses of earning them.” To pay dividends out of capital is not only *ultra vires* but illegal, as constituting a return of capital to shareholders. Before paying dividends, directors must take reasonable care to secure the preparation of proper balance-sheets and estimates, and must exercise their judgment as business men on the balance-sheets and estimates submitted to them. If they fail to do this, and pay dividends out of capital, they will not be held excused, unless the court should think that they ought to be under the new discretion given to the court by ss. 32-34 of the Companies Act 1907 (Companies (Consolidation) Act 1908, s. 279). The onus is on them to show that the dividends have been paid out of profits. The court as a rule does not interfere with the discretion of directors in the matter of paying dividends, unless they are doing something *ultra vires*.

By the Companies (Consolidation) Act 1908, ss. 112, 113, incorporating provisions of the act of 1900 (ss. 21-23), as amended by the act of 1907 (s. 19), the legislature has made strict provisions for the appointment and remuneration of auditors by a company, and has defined their rights and duties. Prior to the act of 1900 audit clauses, except in the case of banking companies, were left to the articles of association and were not matter of statutory obligation.

The “private company” may best be described as an incorporated partnership. The term is statutorily defined—for the first time—by s. 37 of the Companies Act 1907 (s. 121 of the Consolidating Act of 1908). Individual traders and trading firms have in recent years become much more alive to the advantages offered by incorporation. They have discovered that incorporation gives them the protection of limited liability; that it prevents dislocation of a business by the death, bankruptcy or lunacy of any of its members; that it enables a trader to distribute among the members of his family interests in his business on his decease through the medium of shares; that it facilitates borrowing on debentures or debenture stock, and with a view to secure these advantages thousands of traders have converted their businesses into limited companies. To so large an extent has this been done that private companies now form one-third of the whole number of companies registered.

A private company does not appeal to the public to subscribe its capital, but in the main features of its constitution a private

company differs little from a public one. It is only in one or two particulars that special provisions are requisite. It is generally desired for instance: (1) to keep all the shares among the members—the partners or the family—and not to let them get into the hands of the public; and (2) to give the principal shareholders, the original partners, a paramount control over the management. For this purpose it is usual to provide specially in the articles that no share shall be transferred to a stranger so long as any member is willing to purchase it at a fair value; that a member desirous of transferring his shares shall give notice to the company; that the company shall offer the shares to the other members; that if within a certain period the company finds a purchaser the shares shall be transferred to him, and that in case of dispute the value shall be settled by arbitration or shall be such a sum as the auditor certifies to be in his opinion the fair value. So in regard to the management it is common to provide that the owner or owners of the business shall be entitled to hold office as directors for a term of years or for life, provided he or they continue to hold a certain number of shares; or an owner is empowered to authorize his executors or trustees whilst holding a certain number of shares to appoint directors. Directors holding office on these special terms are described as “governing” or “permanent” or “life” directors. This union of interest and management in the same persons gives a private company an unquestionable advantage over a public company.

The so-called “one-man company” is merely a variety of the private company. The fact that a company is formed by one man, with the aid of six dummy subscribers, is not in itself (as was at one time supposed) a fraud on the policy of the Companies Act, but it is occasionally used for the purpose of committing a fraud, as where an insolvent trader turns himself into a limited company in order to evade bankruptcy; and it is to an abuse of this kind that the term “one-man company” owes its opprobrious signification.

Companies Limited by Guarantee.—The second class of limited companies are those limited by guarantee, as distinguished from those limited by shares. In the company limited by guarantee each member agrees, in the event of a winding-up, to contribute a certain amount to the assets,—£5, £1 or 10s.—whatever may be the amount of the guarantee. The peculiarity of this form of company is that the interests of the members of a guarantee company are not expressed in any terms of nominal money value like the shares of other companies, a form of constitution designed, as stated by Lord Thring, the draftsman of the Companies Act 1862, to give a superior elasticity to the company. The property of the company simply belongs to the company in certain fractional amounts. This makes it convenient for clubs, syndicates and other associations which do not require the interest of members to be expressed in terms of cash.

Companies not for Gain.—Associations formed to promote commerce, art, science, religion, charity or any other useful object may, with the sanction of the Board of Trade, register under the Companies Act 1862, with limited liability, but without the addition of the word “Limited,” upon proving to the board that it is the intention of the association to apply the profits or income of the association in promoting its objects, and not in payment of dividends to members (C.A. 1867, s. 23). This licence was made revocable by s. 42 of the Companies Act 1907 (Consolidation Act of 1908, ss. 19, 20). In lieu of the word “Company,” the association may adopt as part of its name some such title as chamber, club, college, guild, institute or society. The power given by this section has proved very useful, and many kinds of associations have availed themselves of it, such as medical institutes, law societies, nursing homes, chambers of commerce, clubs, high schools, archaeological, horticultural and philosophical societies. The guarantee form (see *supra*) is well adapted for associations of this kind intended as they usually are to be supported by annual subscriptions. No such association can hold more than two acres of land without the licence of the Board of Trade.

Cost-Book Mining Companies.—These are in substance mining partnerships. They derive their name from the fact of

the partnership agreement, the expenses and receipts of the mine, the names of the shareholders, and any transfers of shares being entered in a "cost-book." The affairs of the company are managed by an agent known as a "purser," who from time to time makes calls on the members for the expenses of working. A cost-book company is not bound to register under the Companies Act 1862, but it may do so.

A company once incorporated under the Companies Act 1862 cannot be put an end to except through the machinery of a winding-up, though the name of a company which is commercially defunct may be struck off the register of joint stock companies by the registrar (s. 242 of the Companies (Consolidation) Act 1908, incorporating s. 7 of the act of 1880, as amended by s. 26 of the act of 1900). Winding-up is of two kinds: (1) voluntary winding-up, either purely voluntary or carried on under the supervision of the court; and (2) winding-up by the court. Of these voluntary winding-up is by far the more common. Of the companies that come to an end

90% are so wound up; and this is in accordance with the policy of the legislature, evinced throughout the Companies Acts, that shareholders should manage their own affairs—winding-up being one of such affairs. A voluntary winding-up is carried out by the shareholders passing a special resolution requiring the company to be wound up voluntarily, or an extraordinary resolution (now defined by s. 182 of the Companies (Consolidation) Act 1908) to the effect that it has been proved to the shareholders' satisfaction that the company cannot, by reason of its liabilities, continue its business, and that it is advisable to wind it up (C.A. 1862, s. 129). The resolution is generally accompanied by the appointment of a liquidator. In a purely voluntary winding-up there is a power given by s. 138 for the company or any contributory to apply to the court in any matter arising in the winding-up, but seemingly by an oversight of the legislature the same right was not given to creditors. This was rectified by the Companies Act 1900, s. 25. Section 27 of the Companies Act 1907 (s. 188 of the Consolidation Act 1908) further provides for the liquidator under a voluntary winding-up summoning a meeting of creditors to determine on the choice of a liquidator. A creditor may also in a proper case obtain an order for continuing the voluntary winding-up under the supervision of the court. Such an order has the advantage of operating as a stay of any actions or executions pending against the company. Except in these respects, the winding-up remains a voluntary one. The court does not actively intervene unless set in motion; but it requires the liquidator to bring his accounts into chambers every quarter, so that it may be informed how the liquidation is proceeding. When the affairs of the company are fully wound up, the liquidator calls a meeting, lays his accounts before the shareholders, and the company is dissolved by operation of law three months after the date of the meeting (C.A. 1862, ss. 142, 143).

Irrespective of voluntary winding-up, the legislature has defined certain events in which a company formed under the Companies Act 1862 may be wound up by the court. These events are: (1) when the company has passed a resolution requiring the company to be wound up by the court; (2) when the company does not commence its business within a year or suspends it for a year; (3) when the members are reduced to less than seven; (4) when the company is unable to pay its debts, and (5) whenever the court is of opinion that it is just and equitable that the company should be wound up (C.A. 1862, s. 79; s. 129 of the Consolidation Act 1908). A petition for the purpose may be presented either by a creditor, a contributory or the company itself. Where the petition is presented by a creditor who cannot obtain payment of his debt, a winding-up order is *ex debito justitiae* as against the company or shareholders, but not as against the wishes of a majority of creditors. A winding-up order is not to be refused because the company's assets are over mortgaged (Companies Act 1907, s. 29; s. 141 of Consolidation Act 1908).

The procedure on the making of a winding-up order is now governed by ss. 7, 8, 9 of the Winding-up Act 1890. The official

receiver, as liquidator *pro tem.*, requires a statement of the affairs of the company verified by the directors, and on it reports to the court as to the causes of the company's failure and whether further inquiry is desirable. If he further reports that in his opinion fraud has been committed in the promotion or formation of the company by a particular person, the court may order such person to be publicly examined.

A liquidator's duty is to protect, collect, realize and distribute the company's assets in due course of administration; and for this purpose he advertises for creditors, makes calls on contributories, sues debtors, takes misfeasance proceedings, if necessary, against directors or promoters, and carries on the company's business—supposing the goodwill to be an asset of value—with a view to selling it as a going concern. He may be assisted, like a trustee in bankruptcy, by a committee of inspection, composed of creditors and contributories.

When the affairs of the company have been completely wound up the court is, by s. 111 of the Companies Act 1862 (s. 127 of the act of 1908), to make an order that the company be dissolved from the date of such order, and the company is dissolved accordingly. A company which has been dissolved may, where necessary, on petition to the court be reinstated on the register (Companies Act 1880, s. 1).

A large number of companies now wind up only to reconstruct. The reasons for a reconstruction are generally either to raise fresh capital, or to get rid of onerous preference shares, or to enlarge the scope of the company's objects, which is otherwise impracticable owing to the unalterability of the Memorandum of Association. Reconstructions are carried out in one of three ways: (1) by sale and transfer of the company's undertaking and assets to a new company, under a power to sell contained in the company's memorandum of association, or (2) by sale and transfer under s. 161 of the Companies Act 1862; or (3) by a scheme of arrangement, sanctioned by the court, under the Joint Stock Companies Arrangements Act 1870, as amended by the Companies Act 1907, s. 38 (C.A. 1908, s. 192).

The first of these modes is now the most in favour.

A company, though a mere legal abstraction, without mind or will, may, it is now well settled, be liable in damages for malicious prosecution, for nuisance, for fraud, for negligence, for trespass. The sense of the thing is that the "company" is a *nomen collectivum* for the members. It is they who have put the directors there to carry on their business and they must be answerable, collectively, for what is done negligently, fraudulently or maliciously by their agents.

2. Public Companies.

Besides trading companies there is another large class, exceeding in their number even trading companies, which for shortness may be called public companies, that is to say, companies constituted by special act of parliament for the purpose of constructing and carrying on undertakings of public utility, such as railways, canals, harbours, docks, waterworks, gasworks, bridges, ferries, tramways, drainage, fisheries or hospitals. The objects of such companies nearly always involve an interference with the rights of private persons, often necessitate the commission of a public nuisance, and require therefore the sanction of the legislature. For this purpose a special act has to be obtained. A private bill to authorize the undertaking is introduced before one or other of the Houses of Parliament, considered in committee, and either passed or rejected like a public bill. These parliamentary (private bill) committees are tribunals acknowledging certain rules of policy, taking evidence from witnesses and hearing arguments from professional advocates. In many of these special acts, dealing as they do with a similar subject matter, similar provisions are required, and to avoid repetition and secure uniformity the legislature has passed certain general acts—codes of law for particular subject matters frequently recurring—which can be incorporated by reference in any special act with the necessary modifications. Thus the

Companies Clauses Acts 1845, 1863 and 1869 supply the general powers and provisions which are commonly inserted in the constitution of such public company, regulating the distribution of capital, the transfer of shares, payment of calls, borrowing and general meetings. The Lands Clauses Consolidation Act 1845 supplies the machinery for the compulsory taking of land incident to most undertakings of a public character. The Railway Clauses Consolidation Act, the Waterworks Clauses Acts 1847 and 1863, the Gasworks Clauses Act 1847, and the Electric Lighting (Clauses) Act 1899 are other codes of law designed for incorporation in special acts creating companies for the construction of railways or the supply of water, gas or electric light. A distinguishing feature of these companies is that, being sanctioned by the legislature for undertakings of public utility, the policy of the law will not allow them to be broken up or destroyed by creditors. It gives creditors only a charge—by a receiver—on the earnings of the undertaking—the “fruit of the tree.”

3. *British Companies Abroad.*

The status of British companies trading abroad, so far as Germany, France, Belgium, Greece, Italy and Spain are concerned, is expressly recognized in a series of conventions entered into between those countries and Great Britain. The value of the convention with France has been much impaired by the interpretation put upon the words of it by the court of cassation in *La Construction Lim.* According to this case the nationality of a company depends not on its place of origin but on where it has its centre of affairs, its principal establishment. The result is that a company registered in Britain under the Companies Acts may be transmuted by a French court into a French company in direct violation of the convention. The convention with Germany, which is in similar terms to that with France, has also been narrowed by judicial construction. The “power of exercising all their rights” given by the convention to British companies has been construed to mean that a British company will be recognized as a corporate body in Germany, but it does not follow from the terms of the convention that any British company may as a matter of course establish a branch and carry on business within the German empire. It must still get permission to trade, permission to hold land. It must register itself in the communal register. It must pay stamp duties.

Foreign companies may found an affiliated company or have a branch establishment in Italy, provided they publish their memorandum and articles and the names of their directors. Where no convention exists the status of an immigrant corporation depends upon international comity, which allows foreign corporations, as it does foreign persons, to sue, to make contracts and hold real estate, in the same way as domestic corporations or citizens; provided the stranger corporation does not offend against the policy of the state in which it seeks to trade.

There is, however, a growing practice now for states to impose by express legislation conditions on foreign corporations coming to do business within their territory. These conditions are mainly directed to securing that the immigrant corporation shall make known its constitution and shall be amenable to the jurisdiction of the courts of the country where it trades. Thus, by the law of Western Australia—to take a typical instance,—a foreign company is not to commence or carry on business until it empowers some person to act as its attorney to sue and be sued and has an office or place of business within the state, to be approved of by the registrar, where all legal proceedings may be served. New Zealand, Mapitoba and many other states have adopted similar precautions; and by the Companies Act 1907, s. 35; C.A. 1908, s. 274 foreign companies having a place of business within the United Kingdom are required to file with the registrar of joint stock companies a copy of the company's charter or memorandum and articles, a list of directors, and the names and addresses of one or more persons authorized to accept service of process. Special conditions of a more stringent nature are often imposed in the case of particular classes of companies of a quasi-public character, such as banking companies, building

societies or insurance companies. Regulations of this kind are perfectly legitimate and necessary. They are in truth only an application of the law of vagrancy to corporations, and have their analogy in the restrictions now generally imposed by states on the immigration of aliens.

4. *Company Law outside the United Kingdom.*

Australia.—Company law in Australia and in New Zealand follows very closely the lines of company legislation in the United Kingdom.

In New South Wales the law is consolidated by Act No. 40 of 1899, amended 1900 and 1906. In Victoria the law is contained in the Acts Nos. 1074 of 1890 and 355 of 1896; in Queensland in a series of Acts—No. 4 of 1863, No. 18 of 1899, No. 10 of 1891, No. 24 of 1892, No. 3 of 1893, No. 19 of 1894 and No. 21 of 1896; in South Australia in No. 56 of 1892, amended by No. 576 of 1893; in Tasmania by Nos. 22 of 1869, 19 of 1895 and 3 of 1896; in Western Australia by No. 8 of 1893, amended 1897 and 1898.

In New Zealand the law was consolidated in 1903.

Canada.—The act governing joint stock companies in Canada is the Companies Act 1902, amended 1904. It empowers the secretary of state by letters patent to grant a charter to any number of persons not less than five for any objects other than railway or telegraph lines, banking or insurance.

Applicants must file an application—analogue to the British memorandum of association—showing certain particulars—the purposes of incorporation, the place of business, the amount of the capital stock, the number of shares and the amount of each, the names and addresses of the applicants, the amount of stock taken by each and the amount and mode of payment. Other provisions may also be embodied. A company cannot commence business until 10% of its authorized capital has been subscribed and paid for. The word “limited” as part of the company's name is—as in the case of British companies—to be conspicuously exhibited and used in all documents. The directors are not to be less than three or more than fifteen, and must be holders of stock. Directors are jointly and severally liable to the clerks, labourers and servants of the company for six months' wages. Borrowing powers may be taken by a vote of holders of two-thirds in value of the subscribed stock of the company.

South Africa.—In Cape Colony the law is contained in No. 25 of 1892, amended 1895 and 1906; it follows English law.

In Natal the law is contained in Nos. 10 of 1864, 18 of 1865, 19 of 1893 and 3 of 1896.

In the Orange Free State in Law Ch. 100 and Nos. 2 and 4 of 1892.

For the Transvaal see Nos. 5 of 1874, 6 of 1874, 1 of 1894 and 30 of 1904.

In Rhodesia companies are regulated by the Companies Ordinance 1895—a combination of the Cape Companies Act 1892, and the British Companies Acts 1862–1890.

France.—There are two kinds of limited liability companies in France—the *société en commandite* and the *société anonyme*. The *société en commandite* corresponds in some respects to the British private company or limited partnership, but with this difference, that in the *société en commandite* the managing partner is under unlimited liability of creditors; the sleeping partner's liability is limited to the amount of his capital. The French equivalent of the English ordinary joint stock company is the *société anonyme*. The minimum number of subscribers necessary to form such a company is (as in the case of a British trading company) seven, but, unlike a British company, the *société anonyme* is not legally constituted unless the whole capital is subscribed and one-fourth of each share paid up. Another precaution unknown to British practice is that assets, not in money, brought into a company are subject to verification of value by a general meeting. The minimum nominal value of shares, where the company's capital is less than 200,000 fcs., is 25 fcs.; where the capital is more than 200,000 fcs., 100 fcs. The *société* is governed by articles which appoint the directors, and there is one general meeting held every year. A *société anonyme* may, since 1902, issue preference shares. The doctrine

that a corporation never dies has no place in French law. A *société anonyme* may come to an end.

Germany.—In Germany the class of companies most nearly corresponding to English companies limited by shares are "share companies" (*Aktiengesellschaften*) and "commandite companies" with a share capital (*Kommanditgesellschaften auf Aktien*). Since 1892 a new form of association has come into existence known by the name of partnership with limited liability (*Gesellschaften mit beschränkter Haftung*), which has largely superseded the commandite company.

The "share" In forming this paid-up company certain preliminary "company" steps have to be taken before registration:—

1. The articles must be agreed on;
2. A managing board and a board of supervision must be appointed;
3. The whole of the share capital must be allotted and 25 % at least, must be paid up in coin or legal tender notes;
4. Reports on the formation of the company must be made by certain persons; and
5. Certain documents must be filed in the registry.

In all cases where shares are issued for any consideration, not being payment in full in cash, or in which contracts for the purchase of property have been entered into, the promoters must sign a declaration in which they must state on what grounds the prices agreed to be given for such property appear to be justified. In the great majority of cases shares are issued in certificates to bearer. The amount of such a share—to bearer—must as a general rule be not less than £50, but registered shares of £10 may be issued. Balance sheets have to be published periodically.

Partnerships with limited liability may be formed by two or more members. The articles of partnership must be signed by all the members, and must contain particulars as to the amount of the capital and of the individual shares. If the liability on any shares is not to be satisfied in cash this also must be stated. The capital of a limited partnership must amount to £1000. Shares must be registered. Insolvent companies in Germany are subject to the bankruptcy law in the same manner as natural persons.

For further information see a memorandum on German companies printed in the appendix to the *Report of Lord Davey's Committee on the Amendment of Company Law*, pp. 13-26.

Italy.—Commercial companies in Italy are of three kinds:—(1) General partnerships, in which the members are liable for all debts incurred; (2) companies in *accomodita*, in which some members are liable to an unlimited extent and others within certain limits; (3) joint stock companies, in which the liability is limited to the capital of the company and no member is liable beyond the amount of his holding. None of these companies needs authority from the government for its constitution; all that is needed is a written agreement brought before the public in the ways indicated in the code (Art. 90 et seq.). In joint stock companies the trustees (directors) must give security. They are appointed by a general meeting for a period not exceeding four years (Art. 124). The company is not constituted until the whole of its capital is subscribed, and until three-tenths of the capital at least has been actually paid up. When a company's capital is diminished by one-third, the trustees must call the members together and consult as to what is to be done.

An ordinary meeting is held once at least every year. Shares may not be made payable "to bearer" until fully paid up (Art. 166). A company may issue debentures if this is agreed to by a certain majority (Art. 172). One-twentieth, at least, of the dividends of the company must be added to the reserve fund, until this has become equal to one-fifth of the company's capital (Art. 182). Three or five assessors—members or non-members—keep watch over the way in which the company is carried on.

United States.—In the United States the right to create corporations is a sovereign right, and as such is exercisable by the several states of the Union. The law of private corporations must therefore be sought in some fifty collections or groups of statutory and case-made rules. These collections or groups of rules differ in many cases essentially from each other. The acts

regulating business corporations generally provide that the persons proposing to form a corporation shall sign and acknowledge an instrument called the articles of association, setting forth the name of the corporation, the object for which it is to be formed, the principal place of business, the amount of its capital stock, and the number of shares into which it is to be divided, and the duration of its corporate existence. These articles are filed in the office of the secretary of state or in designated courts of record, and a certificate is then issued reciting that the provisions of the act have been complied with, and thereupon the incorporators are vested with corporate existence and the general powers incident thereto. This certificate is the charter of the corporation. The power to make bylaws is usually vested in the stockholders, but it may be conferred by the certificate on the directors. Stockholders remain liable until their subscriptions are fully paid. Nothing but money is considered payment of capital stock except where property is purchased. Directors must usually be stockholders.

The right of a state to forfeit a corporation's charter for misuser or non-user of its franchises is an implied term of the grant of incorporation. Corporations are liable for every wrong they commit, and in such cases cannot set up by way of protection the doctrine of *ultra vires*.

See for authorities *Commentaries on the Law of Private Corporations*, by Seymour D. Thompson, LL.D., 6 vols.; *Beach on Corporations*, and the *American Encyclopaedia of Law*. (E. MA.)

COMPARATIVE ANATOMY, a term employed to designate the study of the structure of man as compared with that of lower animals, and sometimes the study of lower animals in contradistinction to human anatomy; the term is now falling into desuetude, and lingers practically only in the titles of books or in the designation of university chairs. The change in terminology is chiefly the result of modern conceptions of zoology. From the point of view of structure, man is one of the animals; all investigations into anatomical structure must be comparative, and in this work the subject is so treated throughout. See ANATOMY and ZOOLOGY.

COMPARETTI, DOMENICO (1835–), Italian scholar, was born at Rome on the 27th of June 1835. He studied at the university of Rome, took his degree in 1855 in natural science and mathematics, and entered his uncle's pharmacy as assistant. His scanty leisure was, however, given to study. He learned Greek by himself, and gained facility in the modern language by conversing with the Greek students at the university. In spite of all disadvantages, he not only mastered the language, but became one of the chief classical scholars of Italy. In 1857 he published, in the *Rheinisches Museum*, a translation of some recently discovered fragments of Hypereides, with a dissertation on that orator. This was followed by a notice of the annalist Granus Licinianus, and one on the oration of Hypereides on the Lamian War. In 1859 he was appointed professor of Greek at Pisa on the recommendation of the duke of Sermoneta. A few years later he was called to a similar post at Florence, remaining emeritus professor at Pisa also. He subsequently took up his residence in Rome as lecturer on Greek antiquities and greatly interested himself in the Forum excavations. He was a member of the governing bodies of the academies of Milan, Venice, Naples and Turin. The list of his writings is long and varied. Of his works in classical literature, the best known are an edition of the *Euxenippus* of Hypereides, and monographs on Pindar and Sappho. He also edited the great inscription which contains a collection of the municipal laws of Gortyn in Crete, discovered on the site of the ancient city. In the *Kalewala and the Traditional Poetry of the Finns* (English translation by I. M. Anderton, 1898) he discusses the national epic of Finland and its heroic songs, with a view to solving the problem whether an epic could be composed by the interweaving of such national songs. He comes to a negative conclusion, and applies this reasoning to the Homeric problem. He treats this question again in a treatise on the so-called Peisistratæan edition of Homer (*La Commissione omerica di Pisistrato*, 1881). His *Researches concerning the Book of Sindibad* have been translated

Fig. 4 shows the general arrangement of mounting all compass cards in the bowl. In fig. 5 another form of compass called a liquid or spirit compass is shown partly in section. The card nearly floats in a bowl filled with distilled water, to which 35% of alcohol is added to prevent freezing; the bowl is hermetically sealed with pure india-rubber, and a corrugated expansion chamber is attached to the bottom to allow for the expansion and contraction of the liquid. The card is a mica disk, either painted as in fig. 1, or covered with linen upon which the degrees and points are printed, the needles being enclosed in brass.

Great steadiness of card under severe shocks and vibrations, combined with a minimum of friction in the cap and pivot, is obtained with this compass. All compasses are fitted with a gimbal ring to keep the bowl and card level under every circumstance of a ship's motion in a seaway, the ring being connected with the binnacle or pedestal by means of journals or knife edges. On the inside of every compass bowl a vertical black line is drawn, called the "lubber's point," and it is imperative

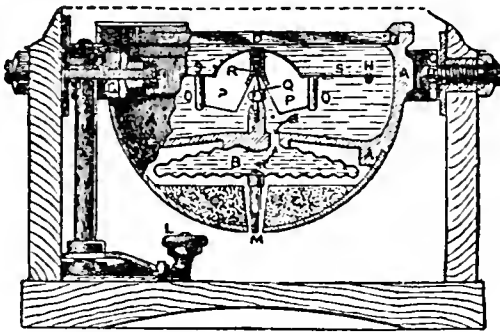

FIG. 5.—Liquid Compass.

- | | |
|---|---------------------------------------|
| A, Bowl, partly in section. | N, Hole for filling, with screw plug. |
| B, Expansion chamber. | O, O, Magnetic needles. |
| D, The glass. | P, Buoyant chamber. |
| C, Gimbal ring. | Q, Iridium pivot. |
| L, Nut to expand chamber when filling bowl. | R, Sapphire cap. |
| M, Screw connector. | S, Mica card. |

that when the compass is placed in the binnacle the line joining the pivot and the lubber's point be parallel to the keel of the vessel. Thus, when a degree on the card is observed opposite the lubber's point, the angle between the direction in which the ship is steering and the north point of the compass or course is at once seen; and if the magnetic variation and the disturbing effects of the ship's iron are known, the desired angle between the ship's course and the geographical meridian can be computed. In every ship a position is selected for the navigating or standard compass as free from neighbouring iron as possible, and by this compass all courses are shaped and bearings taken. It is also provided with an azimuth circle or mirror and a shadow pin or style placed in the centre of the glass cover, by either of which the variable angle between the compass north and true north, called the "total error," or variation and deviation combined, can be observed. The binnacles or pedestals for compasses are generally constructed of wood about 45 in. high, and fitted to receive and alter at pleasure the several magnet and soft iron correctors. They are also fitted with different forms of suspension in which the compass is mounted to obviate the mechanical disturbance of the card caused by the vibration of the hull in ships driven by powerful engines.

The effects of the iron and steel used in the construction of ships upon the compass occupied the attention of the ablest physicists of the 19th century, with results which enable navigators to conduct their ships with perfect safety. The hull of an iron or steel ship is a magnet, and the distribution of its magnetism depends upon the direction of the ship's head when building, this result being produced by induction from the earth's magnetism, developed and impressed by the hammering of the plates and frames during the process of building. The disturbance of the compass by the magnetism of the hull is generally modified, sometimes favourably, more often un-

favourably, by the magnetized fittings of the ship, such as masts, conning towers, deck houses, engines and boilers. Thus in every ship the compass needle is more or less subject to deviation differing in amount and direction for every azimuth of the ship's head. This was first demonstrated by Commander Matthew Flinders by experiments made in H.M.S. "Investigator" in 1800-1803, and in 1810 led that officer to introduce the practice of placing the ship's head on each point of the compass, and noting the amount of deviation whether to the east or west of the magnetic north, a process which is in full exercise at the present day, and is called "swinging ship." When speaking of the magnetic properties of iron it is usual to adopt the terms "soft" and "hard." Soft iron is iron which becomes instantly magnetized by induction when exposed to any magnetic force, but has no power of retaining its magnetism. Hard iron is less susceptible of being magnetized, but when once magnetized it retains its magnetism permanently. The term "iron" used in these pages includes the "steel" now commonly employed in shipbuilding. If an iron ship be swung when upright for deviation, and the mean horizontal and vertical magnetic forces at the compass positions be also observed in different parts of the world, mathematical analysis shows that the deviations are caused partly by the permanent magnetism of hard iron, partly by the transient induced magnetism of soft iron both horizontal and vertical, and in a lesser degree by iron which is neither magnetically hard nor soft, but which becomes magnetized in the same manner as hard iron, though it gradually loses its magnetism on change of conditions, as, for example, in the case of a ship, repaired and hammered in dock, steaming in an opposite direction at sea. This latter cause of deviation is called sub-permanent magnetism. The horizontal directive force on the needle on board is nearly always less than on land, sometimes much less, whilst in armour-plated ships it ranges from .8 to .2 when the directive force on land = 1.0. If the ship be inclined to starboard or to port additional deviation will be observed, reaching a maximum on north and south points, decreasing to zero on the east and west points. Each ship has its own magnetic character, but there are certain conditions which are common to vessels of the same type.

Instead of observing the deviation solely for the purposes of correcting the indications of the compass when disturbed by the iron of the ship, the practice is to subject all deviations to mathematical analysis with a view to their mechanical correction. The whole of the deviations when the ship is upright may be expressed nearly by five co-efficients, A, B, C, D, E. Of these A is a deviation constant in amount for every direction of the ship's head. B has reference to horizontal forces acting in a longitudinal direction in the ship, and caused partly by the permanent magnetism of hard iron, partly by vertical induction in vertical soft iron either before or abaft the compass. C has reference to forces acting in a transverse direction, and caused by hard iron. D is due to transient induction in horizontal soft iron, the direction of which passes continuously under or over the compass. E is due to transient induction in horizontal soft iron unsymmetrically placed with regard to the compass. When data of this character have been obtained the compass deviations may be mechanically corrected to within 1°—always adhering to the principal that "like cures like." Thus the part of B caused by the permanent magnetism of hard iron must be corrected by permanent magnets horizontally placed in a fore and aft direction; the other part caused by vertical soft iron by means of bars of vertical soft iron, called Flinders bars, before or abaft the compass. C is compensated by permanent magnets athwartships and horizontal; D by masses of soft iron on both sides of the compass, and generally in the form of cast-iron spheres, with their centres in the same horizontal plane as the needles; E is usually too small to require correction; A is fortunately rarely of any value, as it cannot be corrected. The deviation observed when the ship inclines to either side is due—(1) to hard iron acting vertically upwards or downwards; (2) to vertical soft iron immediately below the compass; (3) to vertical induction in horizontal soft iron when inclined. To compensate (1)

vertical magnets are used; (3) is partly corrected by the soft iron correctors of D; (2) and the remaining part of (3) cannot be conveniently corrected for more than one geographical position at a time. Although a compass may thus be made practically correct for a given time and place, the magnetism of the ship is liable to changes on changing her geographical position, and especially so when steaming at right angles or nearly so to the magnetic meridian, for then sub-permanent magnetism is developed in the hull. Some vessels are more liable to become sub-permanently magnetized than others, and as no corrector has been found for this source of deviation the navigator must determine its amount by observation. Hence, however carefully a compass may be placed and subsequently compensated, the mariner has no safety without constantly observing the bearings of the sun, stars or distant terrestrial objects, to ascertain its deviation. The results of these observations are entered in a compass journal for future reference when fog or darkness prevails.

Every compass and corrector supplied to the ships of the British navy is previously examined in detail at the Compass Observatory established by the admiralty at Deptford. A trained observer acting under the superintendent of compasses is charged with this important work. The superintendent, who is a naval officer, has to investigate the magnetic character of the ships, to point out the most suitable positions for the compasses when a ship is designed, and subsequently to keep himself informed of their behaviour from the time of the ship's first trial. A museum containing compasses of various types invented during the 19th century is attached to the Compass Observatory at Deptford.

The mariner's compass during the early part of the 19th century was still a very imperfect instrument, although numerous inventors had tried to improve it. In 1837 the Admiralty Compass Committee was appointed to make a scientific investigation of the subject, and propose a form of compass suitable alike for azimuth and steering purposes. The committee reported in July 1840, and after minor improvements by the makers the admiralty compass, the card of which is shown in figs. 1 and 2, was adopted by the government. Until 1876, when Sir William Thomson introduced his patent compass, this compass was not only the regulation compass of the British navy, but was largely used in other countries in the same or a modified form. The introduction of powerful engines causing serious vibration to compass cards of the admiralty type, coupled with the prevailing desire for larger cards, the deviation of which could also be more conveniently compensated, led to the gradual introduction of the Thomson compass. Several important points were gained in the latter: the quadrantal deviation could be finally corrected for all latitudes; frictional error at the cap and pivot was reduced to a minimum, the average weight of the card being 200 grains; the long free vibrational period of the card was found to be favourable to its steadiness when the vessel was rolling. The first liquid compass used in England was invented by Francis Crow, of Faversham, in 1813. It is said that the idea of a liquid compass was suggested to Crow by the experience of the captain of a coasting vessel whose compass card was oscillating wildly until a sea broke on board filling the compass bowl, when the card became steady. Subsequent improvements were made by E. J. Dent, and especially by E. S. Ritchie, of Boston, Massachusetts. In 1888 the form of liquid compass (fig. 5) now solely used in torpedo boats and torpedo boat destroyers was introduced. It has also proved to be the most trustworthy compass under the shock of heavy gun fire at present available. The deflector is an instrument designed to enable an observer to reduce the deviations of the compass to an amount not exceeding 2° during fogs, or at any time when bearings of distant objects are not available. It is certain that if the directive forces on the north, east, south and west points of a compass are equal, there can be no deviation. With the deflector any inequality in the directive force can be detected, and hence the power of equalizing the forces by the usual soft iron and magnet correctors. Several kinds of deflector have been invented, that of Lord Kelvin (Sir William Thomson) being the simplest, but Dr Waghorn's is also very effective. The use of the deflector is generally confined to experts.

The Magnetism of Ships.—In 1814 Flinders first showed (see Flinders's *Voyage*, vol. ii. appx. ii.) that the abnormal values of the variation observed in the wood-built ships of his day was due to deviation of the compass caused by the iron in the ship; that the deviation was zero when the ship's head was near the north and south points; that it attained its maximum on the east and west points, and varied as the sine of the azimuth of the ship's head reckoned from the zero points. He also described a method of correcting deviation by means of a bar of vertical iron so placed as to correct the deviation nearly in all latitudes. This bar, now

known as a "Flinders bar," is still in general use. In 1820 Dr T. Young (see Brande's *Quarterly Journal*, 1820) investigated mathematically the magnetism of ships. In 1824 Professor Peter Barlow (1776–1862) introduced his correcting plate of soft iron. Trials in certain ships showed that their magnetism consisted partly of hard iron, and the use of the plate was abandoned. In 1835 Captain E. J. Johnson, R.N., showed from experiments in the iron steamship "Garry Owen" that the vessel acted on an external compass as a magnet. In 1838 Sir G. B. Airy magnetically examined the iron steamship "Rainbow" at Deptford, and from his mathematical investigations (see *Phil. Trans.*, 1839) deduced his method of correcting the compass by permanent magnets and soft iron, giving practical rules for the same in 1840. Airy's and Flinders's correctors form the basis of all compass correctors to this day. In 1838 S. D. Poisson published his *Memoir on the Deviations of the Compass caused by the Iron in a Vessel*. In this he gave equations resulting from the hypothesis that the magnetism of a ship is partly due to the permanent magnetism of hard iron and partly to the transient induced magnetism of soft iron; that the latter is proportional to the intensity of the inducing force, and that the length of the needle is infinitesimally small compared to the distance of the surrounding iron. From Poisson's equations Archibald Smith deduced the formulae given in the *Admiralty Manual for Deviations of the Compass* (1st ed., 1862), a work which has formed the basis of numerous other manuals since published in Great Britain and other countries. In view of the serious difficulties connected with the inclining of every ship, Smith's formulae for ascertaining and providing for the correction of the heeling error with the ship upright continue to be of great value to safe navigation. In 1855 the Liverpool Compass Committee began its work of investigating the magnetism of ships of the mercantile marine, resulting in three reports to the Board of Trade, all of great value, the last being presented in 1861.

See also MAGNETISM, and NAVIGATION; articles on Magnetism of Ships and Deviations of the Compass, *Phil. Trans.*, 1839–1883, *Journal United Service Inst.*, 1859–1889, *Trans. Inst. Nav. Archit.*, 1860–1861–1862, *Report of Brit. Assoc.*, 1862, *London Quarterly Rev.*, 1865; also *Admiralty Manual*, edit. 1862–1863–1869–1893–1900; and *Towson's Practical Information on Deviations of the Compass* (1886). (E. W. C.)

History of the Mariner's Compass.

The discovery that a lodestone, or a piece of iron which has been touched by a lodestone, will direct itself to point in a north and south position, and the application of that discovery to direct the navigation of ships, have been attributed to various origins. The Chinese, the Arabs, the Greeks, the Etruscans, the Finns and the Italians have all been claimed as originators of the compass. There is now little doubt that the claim formerly advanced in favour of the Chinese is ill-founded. In Chinese history we are told how, in the sixty-fourth year of the reign of Hwang-ti (2634 B.C.), the emperor Hiuan-yuan, or Hwang-ti, attacked one Tchi-yeou, on the plains of Tchou-lou, and finding his army embarrassed by a thick fog raised by the enemy, constructed a chariot (Tchi-nan) for indicating the south, so as to distinguish the four cardinal points, and was thus enabled to pursue Tchi-yeou, and take him prisoner. (Julius Klaproth, *Lettre à M. le Baron Humboldt sur l'invention de la boussole*, Paris, 1834. See also Mailla, *Histoire générale de la Chine*, tom. i. p. 316, Paris, 1777.) But, as other versions of the story show, this account is purely mythical. For the south-pointing chariots are recorded to have been first devised by the emperor Hian-tsoung (A.D. 806–820); and there is no evidence that they contained any magnet. There is no genuine record of a Chinese marine compass before A.D. 1297, as Klaproth admits. No sea-going ships were built in China before 139 B.C. The earliest allusion to the power of the lodestone in Chinese literature occurs in a Chinese dictionary, finished in A.D. 121, where the lodestone is defined as "a stone with which an attraction can be given to a needle," but this knowledge is no more than that existing in Europe at least five hundred years before. Nor is there any nautical significance in a passage which occurs in the Chinese encyclopaedia, *Poei-wen-yun-fou*, in which it is stated that under the Tsin dynasty, or between A.D. 265 and 419, "there were ships indicating the south."

The Chinese, Sir J. F. Davis informs us, once navigated as far as India, but their most distant voyages at present extend not farther than Java and the Malay Islands to the south (*The Chinese*, vol. iii. p. 14, London, 1844). According to an Arabic manuscript, a translation of which was published by Eusebius Renaudot (Paris, 1718), they traded in ships to the Persian Gulf

and Red Sea in the 9th century. Sir G. L. Staunton, in vol. i. of his *Embassy to China* (London, 1797), after referring to the early acquaintance of the Chinese with the property of the magnet to point southwards, remarks (p. 445), "The nature and the cause of the qualities of the magnet have at all times been subjects of contemplation among the Chinese. The Chinese name for the compass is *ting-nan-ching*, or needle pointing to the south; and a distinguishing mark is fixed on the magnet's southern pole, as in European compasses upon the northern one." "The sphere of Chinese navigation," he tells us (p. 447), "is too limited to have afforded experience and observation for forming any system of laws supposed to govern the variation of the needle. . . . The Chinese had soon occasion to perceive how much more essential the perfection of the compass was to the superior navigators of Europe than to themselves, as the commanders of the 'Lion' and 'Hindustan,' trusting to that instrument, stood out directly from the land into the sea." The number of points of the compass, according to the Chinese, is twenty-four, which are reckoned from the south pole; the form also of the instrument they employ is different from that familiar to Europeans. The needle is peculiarly poised, with its point of suspension a little below its centre of gravity, and is exceedingly sensitive; it is seldom more than an inch in length, and is less than a line in thickness. "It may be urged," writes Mr T. S. Davies, "that the different manner of constructing the needle amongst the Chinese and European navigators shows the independence of the Chinese of us, as theirs is the *worse* method, and had they copied from us, they would have used the better one" (Thomson's *British Annual*, 1837, p. 291). On the other hand, it has been contended that a knowledge of the mariner's compass was communicated by them directly or indirectly to the early Arabs, and through the latter was introduced into Europe. Sismondi has remarked (*Literature of Europe*, vol. i.) that it is peculiarly characteristic of all the pretended discoveries of the middle ages that when the historians mention them for the first time they treat them as things in general use. Gunpowder, the compass, the Arabic numerals and paper, are nowhere spoken of as discoveries, and yet they must have wrought a total change in war, in navigation, in science, and in education. G. Tiraboschi (*Storia della letteratura italiana*, tom. iv. lib. ii. p. 204, et seq., ed. 2., 1788), in support of the conjecture that the compass was introduced into Europe by the Arabs, adduces their superiority in scientific learning and their early skill in navigation. He quotes a passage on the polarity of the lodestone from a treatise translated by Albertus Magnus, attributed by the latter to Aristotle, but apparently only an Arabic compilation from the works of various philosophers. As the terms *Zoron* and *Aphron*, used there to signify the south and north poles, are neither Latin nor Greek, Tiraboschi suggests that they may be of Arabian origin, and that the whole passage concerning the lodestone may have been added to the original treatise by the Arabian translators.

Dr W. Robertson asserts (*Historical Disquisition concerning Ancient India*, p. 227) that the Arabs, Turks and Persians have no original name for the compass, it being called by them *Bossola*, the Italian name, which shows that the thing signified is foreign to them as well as the word. The Rev. G. P. Badger has, however, pointed out (*Travels of Ludovico di Varthema*, trans. J. W. Jones, ed. G. P. Badger, Hakluyt Soc., 1863, note, pp. 31 and 32) that the name of Bushla or Busba, from the Italian *Bussola*, though common among Arab sailors in the Mediterranean, is very seldom used in the Eastern seas,—*Dairah* and *Beit el-Ibrah* (the Circle, or House of the Needle) being the ordinary appellatives in the Red Sea, whilst in the Persian Gulf *Kiblah-nâmch* is in more general use. Robertson quotes Sir J. Chardin as boldly asserting "that the Asiatics are beholden to us for this wonderful instrument, which they had from Europe a long time before the Portuguese conquests. For, first, their compasses are exactly like ours, and they buy them of Europeans as much as they can, scarce daring to meddle with their needles themselves. Secondly, it is certain that the old navigators only coasted it along, which I impute to their want of this instrument to guide and instruct

them in the middle of the ocean. . . . I have nothing but argument to offer touching this matter, having never met with any person in Persia or the Indies to inform me when the compass was first known among them, though I made inquiry of the most learned men in both countries. I have sailed from the Indies to Persia in Indian ships, when no European has been aboard but myself. The pilots were all Indians, and they used the forestaff and quadrant for their observations. These instruments they have from us, and made by our artists, and they do not in the least vary from ours, except that the characters are Arabic. The Arabs are the most skillful navigators of all the Asiatics or Africans; but neither they nor the Indians make use of charts, and they do not much want them; some they have, but they are copied from ours, for they are altogether ignorant of perspective." The observations of Chardin, who flourished between 1643 and 1713, cannot be said to receive support from the testimony of some earlier authorities. That the Arabs must have been acquainted with the compass, and with the construction and use of charts, at a period nearly two centuries previous to Chardin's first voyage to the East, may be gathered from the description given by Barros of a map of all the coast of India, shown to Vasco da Gama by a Moor of Guzerat (about the 15th of July 1498), in which the bearings were laid down "after the manner of the Moors," or "with meridians and parallels very small (or close together), without other bearings of the compass; because, as the squares of these meridians and parallels were very small, the coast was laid down by these two bearings of N. and S., and E. and W., with great certainty, without that multiplication of bearings of the points of the compass usual in our maps, which serves as the root of the others." Further, we learn from Osorio that the Arabs at the time of Gama "were instructed in so many of the arts of navigation, that they did not yield much to the Portuguese mariners in the science and practice of maritime matters." (See *The Three Voyages of Vasco da Gama*, Hakluyt Soc., 1869; note to chap. xv. by the Hon. H. E. J. Stanley, p. 138.) Also the Arabs that navigated the Red Sea at the same period are shown by Varthema to have used the mariner's chart and compass (*Travels*, p. 31).

Again, it appears that compasses of a primitive description, which can hardly be supposed to have been brought from Europe, were employed in the East Indies certainly as early as several years previous to the close of the 16th century. In William Barlowe's *Navigators Supply*, published in 1597, we read:—"Some fewe yeeres since, it so fell out that I had severall conferences with two East Indians which were brought into England by master Candish [Thomas Cavendish], and had learned our language: The one of them was of Mamilia [Manila] in the Isle of Luzon, the other of Miaco in Japan. I questioned with them concerning their shipping and manner of sayling. They described all things farre different from ours, and shewed, that in steade of our Compas, they use a magnetically needle of six ynches long, and longer, upon a pinne in a dish of white China earth filled with water; In the bottome whereof they have two crosse lines, for the foure principall windes; the rest of the divisions being reserved to the skill of their Pilots." Bailak Kibdjaki, also, an Arabian writer, shows in his *Merchant's Treasure*, a work given to the world in 1282, that the magnetized needle, floated on water by means of a splinter of wood or a reed, was employed on the Syrian seas at the time of his voyage from Tripoli to Alexandria (1242), and adds:—"They say that the captains who navigate the Indian seas use, instead of the needle and splinter, a sort of fish made out of hollow iron, which, when thrown into the water, swims upon the surface, and points out the north and south with its head and tail" (Klaproth, *Lettre*, p. 57). E. Wiedemann, in *Erlangen Sitzungsberichte* (1904, p. 330), translates the phrase given above as splinter of wood, by the term wooden cross. Furthermore, although the sailors in the Indian vessels in which Niccola de' Conti traversed the Indian seas in 1420 are stated to have had no compass, still, on board the ship in which Varthema, less than a century later, sailed from Borneo to Java, both the mariner's chart and compass were used; it has been questioned, however, whether in this case the compass was of

Eastern manufacture (*Travels of Varthema*, Introd. xciv, and p. 249). We have already seen that the Chinese as late as the end of the 18th century made voyages with compasses on which but little reliance could be placed; and it may perhaps be assumed that the compasses early used in the East were mostly too imperfect to be of much assistance to navigators, and were therefore often dispensed with on customary routes. The Arab traders in the Levant certainly used a floating compass, as did the Italians before the introduction of the pivoted needle; the magnetized piece of iron being floated upon a small raft of cork or reeds in a bowl of water. The Italian name of *calamita*, which still persists, for the magnet, and which literally signifies a frog, is doubtless derived from this practice.

The simple water-compass is said to have been used by the Coreans so late as the middle of the 18th century; and Dr T. Smith, writing in the *Philosophical Transactions* for 1683-1684, says of the Turks (p. 439), "They have no genius for Sea-voyages, and consequently are very raw and unexperienced in the art of Navigation, scarce venturing to sail out of sight of land. I speak of the natural *Turks*, who trade either into the *black Sea* or some part of the *Morea*, or between *Constantinople* and *Alexandria*, and not of the *Pyrats of Barbary*, who are for the most part *Renegado's*, and learnt their skill in Christendom. . . . The Turkish compass consists but of 8 points, the four Cardinal and the four Collateral." That the value of the compass was thus, even in the latter part of the 17th century, so imperfectly recognized in the East may serve to explain how in earlier times that instrument, long after the first discovery of its properties, may have been generally neglected by navigators.

The Arabic geographer, Edrisi, who lived about 1100, is said by Boucher to give an account, though in a confused manner, of the polarity of the magnet (Hallam, *Mid. Ages*, vol. iii. chap. 9, part 2); but the earliest definite mention as yet known of the use of the mariner's compass in the middle ages occurs in a treatise entitled *De utensilibus*, written by Alexander Neckam in the 12th century. He speaks there of a needle carried on board ship which, being placed on a pivot, and allowed to take its own position of repose, shows mariners their course when the polar star is hidden. In another work, *De naturis rerum*, lib. ii. c. 89, he writes,—“Mariners at sea, when, through cloudy weather in the day which hides the sun, or through the darkness of the night, they lose the knowledge of the quarter of the world to which they are sailing, touch a needle with the magnet, which will turn round till, on its motion ceasing, its point will be directed towards the north” (W. Chappell, *Nature*, No. 346, June 15, 1876). The magnetical needle, and its suspension on a stick or straw in water, are clearly described in *La Bible Guiot*, a poem probably of the 13th century, by Guiot de Provins, wherein we are told that through the magnet (*la manette* or *l'amanière*), an ugly brown stone to which iron turns of its own accord, mariners possess an art that cannot fail them. A needle touched by it, and floated by a stick on water, turns its point towards the pole-star, and a light being placed near the needle on dark nights, the proper course is known (*Hist. littéraire de la France*, tom. ix. p. 199; Barbazan, *Fabliaux*, tom. ii. p. 328). Cardinal Jacques de Vitry, bishop of Acon in Palestine, in his *History* (cap. 89), written about the year 1218, speaks of the magnetic needle as “most necessary for such as sail the sea”;¹ and another French crusader, his contemporary, Vincent de Beauvais, states that the adamant (lodestone) is found in Arabia, and mentions a method of using a needle magnetized by it which is similar to that described by Kibdjaki. In 1248 Hugo de Bercy notes a change in the construction of compasses, which are now supported on two floats in a glass cup. From quotations given by Antonio Capmany (*Questiones Criticas*) from the *De contemplatione* of Raimon Lull, of the date 1272, it appears that the latter was well acquainted with the use of

¹ Adamas in India reperitur . . . Ferrum occulta quadam natura ad se trahit. Acus ferrea postquam adamantem contigerit, ad stellam septentrionalem . . . semper convertitur, unde valde necessarius est navigantibus in mari.

the magnet at sea;² and before the middle of the 13th century Gauthier d'Espinois alludes to its polarity, as if generally known, in the lines:—

“Tous autresi comme l'aimant decoit [detourne]
L'aiguillette par force de vertu,
A ma dame tor le mont [monde] retenue
Qui sa beauté connoit et aperçoit.”

Guido Guinizzelli, a poet of the same period, writes:—“In those parts under the north are the mountains of lodestone, which give the virtue to the air of attracting iron; but because it [the lodestone] is far off, [it] wishes to have the help of a similar stone to make it [the virtue] work, and to direct the needle towards the star.”³ Brunetto Latini also makes reference to the compass in his encyclopaedia *Livres dou trésor*, composed about 1260 (Livre i. pt. ii. ch. cxx.):—“Por ce nagent li marinier à l'enseigne des estoiles qui i sont, que il apellent tramontaines, et les gens qui sont en Europe et es parties decà nagent à la tramontaine de septentrion, et li autre nagent à cele de midi. Et qui n'en set la verité, praigne une pierre d'aimant, et trouverez que ele a ij faces: l'une qui gist vers l'une tramontaine, et l'autre gist vers l'autre: Et à chascune des ij faces la pointe d'une aiguille vers cele tramontaine à cui cele face gist. Et por ce seroient li marinier deceu se il ne se preissent garde” (p. 147, Paris edition, 1863). Dante (*Paradiso*, xii. 28-30) mentions the pointing of the magnetic needle toward the pole star. In Scandinavian records there is a reference to the nautical use of the magnet in the *Hauksbók*, the last edition of the *Landnámabók* (Book of the Colonization of Iceland):—“Floki, son of Vilgerd, instituted a great sacrifice, and consecrated three ravens which should show him the way (to Iceland); for at that time no men sailing the high seas had lodestones up in northern lands.”

Haukr Erendsson, who wrote this paragraph about 1300, died in 1334; his edition was founded on material in two earlier works, that of Styrmir Karason (who died 1245), which is lost, and that of Hurla Thordson (died 1284) which has no such paragraph. All that is certain is a knowledge of the nautical use of the magnet at the end of the 13th century. From T. Torfaeus we learn that the compass, fitted into a box, was already in use among the Norwegians about the middle of the 13th century (*Hisi. rer. Norvegarum*, iv. c. 4, p. 345, Hafniae, 1711); and it is probable that the use of the magnet at sea was known in Scotland at or shortly subsequent to that time, though King Robert, in crossing from Arran to Carrick in 1306, as Barbour writing in 1375 informs us, “na nedill had na stane,” but steered by a fire on the shore. Roger Bacon (*Opus majus* and *Opus minus*, 1266-1267) was acquainted with the properties of the lodestone, and wrote that if set so that it can turn freely (swimming on water) it points toward the poles; but he stated that this was not due to the pole-star, but to the influence of the northern region of the heavens.

The earliest unquestionable description of a pivoted compass is that contained in the remarkable *Epistola de magnele* of Petrus Peregrinus de Maricourt, written at Lucera in 1269 to Sigerus de Foncaucourt. (First printed edition Augsburg, 1558. See also Bertelli in Boncompagni's *Bollettino di bibliografia*, t. i., or S. P. Thompson in *Proc. British Academy*, vol. ii.) Of this work twenty-eight MSS. exist; seven of them being at Oxford. The first part of the epistle deals generally with magnetic attractions and repulsions, with the polarity of the stone, and with the supposed influence of the poles of the heavens upon the poles of the stone. In the second part Peregrinus describes first an improved floating compass with fiducial line, a circle graduated with 90 degrees to each quadrant, and provided with movable sights for taking bearings. He then describes a new compass with a needle thrust through a pivoted axis, placed in a box with transparent cover, cross index of brass or silver, divided circle, and an external “rule” or alhidade provided with a pair of sights. In the Leiden MS. of this work, which for long was erroneously ascribed to one Peter Adsiger, is a spurious passage, long believed to mention the variation of the compass.

² Sicut acus per naturam vertitur ad septentrionem dum sit tacta a magnete.—Sicut acus nautica dirigit marinarios in sua navigatione.

³ Ginguené, *Hist. lit. de l'Italie*, t. i. p. 413.

Prior to this clear description of a pivoted compass by Peregrinus in 1269, the Italian sailors had used the floating magnet, probably introduced into this region of the Mediterranean by traders belonging to the port of Amalfi, as commemorated in the line of the poet Panormita:—

“Prima dedit nautis usum magnetis Amalphis.”

This opinion is supported by the historian Flavius Blondus in his *Italia illustrata*, written about 1450, who adds that its certain origin is unknown. In 1511 Baptista Pio in his *Commentary* repeats the opinion as to the invention of the use of the magnet at Amalfi as related by Flavius. Gyraldus, writing in 1540 (*Libellus de re nautica*), misunderstanding this reference, declared that this observation of the direction of the magnet to the poles had been handed down as discovered “by a certain Flavius.” From this passage arose a legend, which took shape only in the 17th century, that the compass was invented in the year 1302 by a person to whom was given the fictitious name of Flavio Gioja, of Amalfi.

From the above it will have been evident that, as Barlowe remarks concerning the compass, “the lame tale of one Flavius at Amalphus, in the kingdom of Naples, for to have devised it, is of very slender probability”; and as regards the assertion of Dr Gilbert, of Colchester (*De magnete*, p. 4, 1600), that Marco Polo introduced the compass into Italy from the East in 1260,¹ we need only quote the words of Sir H. Yule (*Book of Marco Polo*):—“Respecting the mariner’s compass and gunpowder, I shall say nothing, as no one now, I believe, imagines Marco to have had anything to do with their introduction.”

When, and by whom, the compass card was added is a matter of conjecture. Certainly the *Rosa Ventorum*, or *Wind-rose*, is far older than the compass itself; and the naming of the eight principal “winds” goes back to the Temple of the Winds in Athens built by Andronicus Cyrrhestes. The earliest known wind-roses on the *portulani* or sailing charts of the Mediterranean pilots have almost invariably the eight principal points marked with the initials of the principal winds, Tramontano, Greco, Levante, Scirocco, Ostro, Africo (or Libeccio), Ponente and Maestro, or with a cross instead of L, to mark the east point. The north point, indicated in some of the oldest compass cards with a broad arrow-head or a spear, as well as with a T for Tramontano, gradually developed by a combination of these, about 1492, into a *fleur de lis*, still universal. The cross at the east continued even in British compasses till about 1700. Wind-roses with these characteristics are found in Venetian and Genoese charts of early 14th century, and are depicted similarly by the Spanish navigators. The naming of the intermediate subdivisions making up the thirty-two points or rhumbs of the compass card is probably due to Flemish navigators; but they were recognized even in the time of Chaucer, who in 1391 wrote, “Now is thin Orisonte departed in xxiii partiez by thi azymutz, in significacion of xxiii partiez of the world: al be it so that ship men rikne thilke partiez in xxxii” (*Treatise on the Astrolabe*, ed. Skeat, Early English Text Soc., London, 1872). The mounting of the card upon the needle or “flie,” so as to turn with it, is probably of Amalphian origin. Da Buti, the Dante commentator, in 1380 says the sailors use a compass at the middle of which is pivoted a wheel of light paper to turn on its pivot, on which wheel the needle is fixed and the star (wind-rose) painted. The placing of the card at the bottom of the box, fixed, below the needle, was practised by the compass-makers of Nuremberg in the 16th century, and by Stevinus of Bruges about 1600. The gimbals or rings for suspension hinged at right-angles to one another, have been erroneously attributed to Cardan, the proper term being *cardine*, that is hinged or pivoted. The earliest description of them is about 1604. The term *binnacle*, originally *bittacle*, is a corruption of the Portuguese *abitacolo*, to denote the housing enclosing the compass, probably originating with the Portuguese navigators.

The improvement of the compass has been but a slow process.

¹ “According to all the texts he returned to Venice in 1295 or, as is more probable, in 1296.”—Yule.

The Libel of English Policie, a poem of the first half of the 15th century, says with reference to Iceland (chap. x.)—

“Out of Bristowe, and costes many one,
Men haue practised by nedle and by stone
Thider wardes within a litle while.”

Hakluyt, *Principal Navigations*, p. 201 (London, 1599).

From this it would seem that the compasses used at that time by English mariners were of a very primitive description. Barlowe, in his treatise *Magnetical Advertisements*, printed in 1616 (p. 66), complains that “the Compassee needle, being the most admirable and usefull instrument of the whole world, is both amongst ours and other nations for the most part, so bunglerly and absurdly contrived, as nothing more.” The form he recommends for the needle is that of “a true circle, having his Axis going out beyond the circle, at each end narrow and narrower, unto a reasonable sharpe point, and being pure steele as the circle it selfe is, having in the midst a convenient receptacle to place the capitell in.” In 1750 Dr Gowan Knight found that the needles of merchant-ships were made of two pieces of steel bent in the middle and united in the shape of a rhombus, and proposed to substitute straight steel bars of small breadth, suspended edgewise and hardened throughout. He also showed that the Chinese mode of suspending the needle conduces most to sensibility. In 1820 Peter Barlow reported to the Admiralty that half the compasses in the British Navy were mere lumber and ought to be destroyed. He introduced a pattern having four or five parallel straight strips of magnetized steel fixed under a card, a form which remained the standard admiralty type until the introduction of the modern Thomson (Kelvin) compass in 1876. (F. H. B.; S. P. T.)

COMPASS PLANT, a native of the North American prairies, which takes its name from the position assumed by the leaves. These turn their edges to north and south, thus avoiding the excessive mid-day heat, while getting the full benefit of the morning and evening rays. The plant is known botanically as *Silphium laciniatum*, and belongs to the natural order Compositae. Another member of the same order, *Lactuca Scariola*, which has been regarded as the origin of the cultivated lettuce (*L. sativa*), behaves in the same way when growing in dry exposed places; it is a native of Europe and northern Asia which has got introduced into North America.

COMPAYRE, JULES GABRIEL (1843–), French educationalist, was born at Albi. He entered the École Normale Supérieure in 1862 and became professor of philosophy. In 1876 he was appointed professor in the Faculty of Letters of Toulouse, and upon the creation of the École normale d’institutrices at Fontenay aux Roses he became teacher of pedagogy (1880). From 1881 to 1889 he was deputy for Lavour in the chamber, and took an active part in the discussions on public education. Defeated at the elections of 1889, he was appointed rector of the academy of Poitiers in 1890, and five years later to the academy of Lyons. His principal publications are his *Histoire critique des doctrines de l’éducation en France* (1879); *Éléments d’éducation civique* (1881), a work placed on the index at Rome, but very widely read in the primary schools of France; *Cours de pédagogie théorique et pratique* (1885, 13th ed., 1897); *The Intellectual and Moral Development of the Child*, in English (2 vols., New York, 1896–1902); and a series of monographs on *Les Grands Éducateurs*.

COMPENSATION (from Lat. *compensare*, to weigh one thing against another), a term applied in English law to a number of different forms of legal reparation; e.g. under the Forfeiture Act 1870 (s. 4), for loss of property caused by felony, or—under the Riot (Damages) Act 1886—to persons whose property has been stolen, destroyed or injured by rioters (see RIOT). It is due, under the Agricultural Holdings Acts 1883–1906, for agricultural improvements (see LANDLORD AND TENANT; cf. also ALLOTMENTS AND SMALL HOLDINGS), and under the Workmen’s Compensation Act 1906 to workmen, in respect of accidents in the course of their employment (see EMPLOYERS’ LIABILITY); and under the Licensing Act 1904, to the payments to be made on the extinction of licences to sell intoxicants. The term

"Compensation water" is used to describe the water given from a reservoir in compensation for water abstracted from a stream, under statutory powers, in connexion with public works (see WATER SUPPLY). As to the use of the word "compensation" in horology, see CLOCK; WATCH.

Compensation, in its most familiar sense, is however a *nomen juris* for the reparation or satisfaction made to the owners of property which is taken by the state or by local authorities or by the promoters of parliamentary undertakings, under statutory authority, for public purposes. There are two main legal theories on which such appropriation of private property is justified. The American may be taken as a representative illustration of the one, and the English of the other. Though not included in the definition of "eminent domain," the necessity for compensation is recognized as incidental to that power. (See EMINENT DOMAIN, under which the American law of compensation, and the closely allied doctrine of *expropriation pour cause d'utilité publique* of French law, and the law of other continental countries, are discussed.) The rule of English constitutional law, on the other hand, is that the property of the citizen cannot be seized for purposes which are really "public" without a fair pecuniary equivalent being given to him; and, as the money for such compensation must come from parliament, the practical result is that the seizure can only be effected under legislative authority. An action for illegal interference with the property of the subject is not maintainable against officials of the crown or government sued in their official capacity or as an official body. But crown officials may be sued in their individual capacity for such interference, even if they acted with the authority of the government (cp *Raleigh v. Goschen* [1898], 1 Ch. 73).

Law of England.—Down to 1845 every act authorizing the purchase of lands had, in addition to a number of common form clauses, a variety of special clauses framed with a view to meeting the particular circumstances with which it dealt. In 1845, however, a statute based on the recommendations of a select committee, appointed in the preceding year, was passed; the object being to diminish the bulk of the special acts, and to introduce uniformity into private bill legislation by classifying the common form clauses, embodying them in general statutes, and facilitating their incorporation into the special statutes by reference. The statute by which this change was initiated was the Lands Clauses Consolidation Act 1845; and the policy has been continued by a series of later statutes which, together with the act of 1845, are now grouped under the generic title of the Lands Clauses Acts.

The public purposes for which lands are taken are threefold. Certain public departments, such as the war office and the admiralty, may acquire lands for national purposes (see the Defence Acts 1842 to 1873; and the Lands Clauses Consolidation Act 1860, s. 7). Local authorities are enabled to exercise similar powers for an enormous variety of municipal purposes, e.g. the housing of the working classes, the improvement of towns, and elementary and secondary education. Lastly, the promoters of public undertakings of a commercial character, such as railways and harbours, carry on their operations under statutes in which the provisions of the Lands Clauses Acts are incorporated.

Lands may be taken under the Lands Clauses Acts either by agreement or compulsorily. The first step in the proceedings is a "notice to treat," or intimation by the promoters of their readiness to purchase the land, coupled with a demand for particulars as to the estate and the interests in it. The landowner on whom the notice is served may meet it by agreeing to sell, and the terms may then be settled by consent of the parties themselves, or by arbitration, if they decide to have recourse to that mode of adjusting the difficulty. If the property claimed is a house, or other building or manufactory, the owner has a statutory right to require the promoters by a counter-notice to take the whole, even although a part would serve their purpose. This rule, however, is, in modern acts, often modified by special clauses. On receipt of the counter-notice the promoters must either assent to the requirement contained in it, or abandon

their notice to treat. On the other hand, if the landowner fails within twenty-one days after receipt of the notice to treat to give the particulars which it requires, the promoters may proceed to exercise their compulsory powers and to obtain assessment of the compensation to be paid. As a general rule, it is a condition precedent to the exercise of these powers by a company that the capital of the undertaking should be fully subscribed. Compensation, under the Lands Clauses Acts, is assessed in four different modes:—(1) by justices, where the claim does not exceed £50, or a claimant who has no greater interest than that of a tenant for a year, or from year to year, is required to give up possession before the expiration of his tenancy; (2) by arbitration (a) when the claim exceeds £50, and the claimant desires arbitration, and the interest is not a yearly tenancy, (b) when the amount has been ascertained by a surveyor, and the claimant is dissatisfied, (c) when superfluous lands are to be sold, and the parties entitled to pre-emption and the promoters cannot agree as to the price. (Lands become "superfluous" if taken compulsorily on an erroneous estimate of the area needed, or if part only was needed and the owner compelled the promoters under the power above mentioned to take the whole, or in cases of abandonment); (3) by a jury, when the claim exceeds £50, and (a) the claimant does not signify his desire for arbitration, or no award has been made within the prescribed time, or (b) the claimant applies in writing for trial by jury; (4) by surveyors, nominated by justices, where the owner is under disability, or does not appear at the appointed time, or the claim is in respect of commonable rights, and a committee has not been appointed to treat with the promoters.

Promoters are not allowed without the consent of the owner to enter upon lands which are the subject of proceedings under the Lands Clauses Acts, except for the purpose of making a survey, unless they have executed a statutory bond and made a deposit, at the Law Courts Branch of the Bank of England, as security for the performance of the conditions of the bond.

Measure of Value.—(1) Where land is taken, the basis on which compensation is assessed is the commercial value of the land to the owner at the date of the notice to treat. Potential value may be taken into account, and also good-will of the property in a business. This rule, however, excludes any consideration of the principle of "betterment." (2) Where land, although not taken, is "injuriously affected" by the works of the promoters, compensation is payable for loss or damage resulting from any act, legalized by the promoters' statutory powers, which would otherwise have been actionable, or caused by the execution (not the use) of the works authorized by the undertaking.

The following examples of how land may be "injuriously affected," so as to give a right to compensation under the acts, may be given:—narrowing or obstructing a highway which is the nearest access to the lands in question; interference with a right of way; substantial interference with ancient lights; noise of children outside a board school.

Scotland and Ireland.—The Lands Clauses Act 1845 extends to Ireland. There is a Scots enactment similar in character (Lands Clauses [Scotland] Act 1845). The principles and practice of the law of compensation are substantially the same throughout the United Kingdom.

India and the British Colonies.—Legislation analogous to the Lands Clauses Acts is in force in India (Land Acquisition Act 1894 [Act 1 of 1894]) and in most of the colonies (see western Australia, Lands Resumption Act 1894 [58 Vict. No. 33], Victoria, Lands Compensation Act 1890 [54 Vict. No. 1109]; New Zealand, Public Works Act 1894 [58 Vict. No. 42]; Ontario [Revised Stats. 1897, c. 37]).

AUTHORITIES.—*English Law:* Balfour Browne and Allan, *Compensation* (2nd ed., London, 1903); Cripps, *Compensation* (5th edition, London, 1905); Hudson, *Compensation* (London, 1906); Boyle and Waghorn, *Compensation* (London, 1903); Lloyd, *Compensation* (6th ed. by Brooks, London, 1895); Clifford, *Private Bill Legislation*, London, 1885 (vol. i.), 1887 (vol. ii.). *Scots Law:* Deas, *Law of Railways in Scotland* (ed. by Ferguson; Edinburgh, 1897); Rankine, *Law of Landownership* (3rd ed., 1891). (A. W. R.)

COMPIÈGNE, a town of northern France, capital of an arrondissement in the department of Oise, 52 m. N.N.E. of Paris on the Northern railway between Paris and St Quentin. Pop. (1906) 14,052. The town, which is a favourite summer resort, stands on the north-west border of the forest of Compiègne and on the left bank of the Oise, less than 1 m. below its confluence with the Aisne. The river is crossed by a bridge built in the reign of Louis XV. The Rue Collérino, a continuation of the bridge ending at the Place de l'Hôtel de Ville, is the busy street of the town; elsewhere, except on market days, the streets are quiet. The hôtel de ville, with a graceful façade surmounted by a lofty belfry, is in the late Gothic style of the early 16th century and was completed in modern times. Of the churches, St Antoine (13th and 16th centuries) with some fine Renaissance stained glass, and St Jacques (13th and 15th centuries), need alone be mentioned. The remains of the ancient abbey of St Corneille are used as a military storehouse. Compiègne, from a very early period until 1870, was the occasional residence of the French kings. Its palace, one of the most magnificent structures of its kind, was erected, chiefly by Louis XV and Louis XVI., on the site of a château of King Charles V. of France. It now serves as an art museum. It has two façades, one overlooking the Place du Palais and the town, the other, more imposing, facing towards a fine park and the forest, which is chiefly of oak and beech and covers over 36,000 acres. Compiègne is the seat of a subprefect, and has tribunals of first instance and of commerce, a communal college, library and hospital. The industries comprise boat-building, rope-making, steam-sawing, distilling and the manufacture of chocolate, machinery and sacks and coarse coverings, and at Margny, a suburb, there are manufactures of chemicals and felt hats. Asparagus is cultivated in the environs. There is considerable trade in timber and coal, chiefly river-borne.

Compiègne, or as it is called in the Latin chronicles, Compendium, seems originally to have been a hunting-lodge of the early Frankish kings. It was enriched by Charles the Bald with two castles, and a Benedictine abbey dedicated to Saint Corneille, the monks of which retained down to the 18th century the privilege of acting for three days as lords of Compiègne, with full power to release prisoners, condemn the guilty, and even inflict sentence of death. It was in Compiègne that King Louis I. the Debonair was deposed in 833; and at the siege of the town in 1430 Joan of Arc was taken prisoner by the English. A monument to her faces the hôtel de ville. In 1624 the town gave its name to a treaty of alliance concluded by Richelieu with the Dutch; and it was in the palace that Louis XV. gave welcome to Marie Antoinette, that Napoleon I. received Marie Louise of Austria, that Louis XVIII. entertained the emperor Alexander of Russia, and that Leopold I., king of the Belgians, was married to the princess Louise. In 1814 Compiègne offered a stubborn resistance to the Prussian troops. Under Napoleon III. it was the annual resort of the court during the hunting season. From 1870 to 1871 it was one of the headquarters of the German army.

COMPLEMENT (Lat. *complementum*, from *complere*, to fill up), that which fills up or completes anything, e.g. the number of men necessary to man a ship. In geometry, the complement of an angle is the difference between the angle and a right angle; the complements of a parallelogram are formed by drawing parallel to adjacent sides of a parallelogram two lines intersecting on a diagonal; four parallelograms are thus formed, and the two not about the diagonal of the original parallelogram are the complements of the parallelogram. In analysis, a complementary function is a partial solution to a differential equation (*q.v.*); complementary operators are reciprocal or inverse operators, i.e. two operations A and B are complementary when both operating on the same figure or function leave it unchanged. A "complementary colour" is one which produces white when mixed with another (see COLOUR). In Spanish the word *cumplimento* was used in a particular sense of the fulfilment of the duties of polite behaviour and courtesy, and it came through the French and Italian forms into use in English, with a change in spelling to "compliment," with the sense of an act of politeness, especially of a polite expression of praise, or of social regard and

greetings. The word "comply," meaning to act in accordance with wishes, orders or conditions, is also derived from the same origin, but in sense is connected with "ply" or "pliant," from Lat. *plicare*, to bend, with the idea of subserviently yielding to the wishes of another.

COMPLUVIUM (from Lat. *compluere*, to flow together, i.e. in reference to the rain being collected and falling through), in architecture, the Latin term for the open space left in the roof of the atrium of a Roman house for lighting it and the rooms round (see CAVAEDIUM).

COMPOSITAE, the name given to the largest natural order of flowering plants, containing about one-tenth of the whole number and characterized by the crowding of the flowers into heads. The order is cosmopolitan, and the plants show considerable variety in habit. The great majority, including most British representatives, are herbaceous, but in the warmer parts of the world shrubs and arborescent forms also occur; the latter are characteristic of the flora of oceanic islands. In herbaceous plants the leaves are often arranged in a rosette on a much shortened stem, as in dandelion, daisy and others; when the stem is elongated the leaves are generally alternate. The root is generally thickened, sometimes, as in dahlia, tuberous; root and stem contain oil passages, or, as in lettuce and dandelion, a milky white latex. The flowers are crowded in heads (*capitula*) which are surrounded by an involucre of green bracts,—these



FIG. 1.

1. Flower head of Marigold, $\frac{3}{4}$ nat. size. 2. Same in vertical section. 3. Head of fruits, nat. size. 4. A single fruit.

protect the head of flowers in the bud stage, performing the usual function of a calyx. The enlarged top of the axis, the receptacle, is flat, convex or conical, and the flowers open in centripetal succession. In many cases, as in the sunflower or daisy, the outer or ray-florets are larger and more conspicuous than the inner, or disk-florets; in other cases, as in dandelion, the florets are all alike. Ray-florets when present are usually pistillate, but neuter in some genera (as *Centaurea*); the disk-florets are hermaphrodite. The flower is epigynous; the calyx is sometimes absent, or is represented by a rim on the top of the ovary, or takes the form of hairs or bristles which enlarge in the fruiting stage to form the pappus by means of which the seed is dispersed. The corolla, of five united petals, is regular and tubular in shape as in the disk-florets, or irregular when it is either strap-shaped (ligulate), as in the ray-florets of daisy, &c., or all the florets of dandelion, or more rarely two-lipped. The five stamens are attached to the interior of the corolla-tube; the filaments are free; the anthers are joined (syngenesious) to form a tube round the single style, which ends in a pair of stigmas. The inferior ovary contains one ovule (attached to the base of the chamber), and ripens to form a dry one-seeded fruit; the seed is filled with the straight embryo.

The flower-heads are an admirable example of an adaptation for pollination by aid of insects. The crowding of the flowers in heads ensures the pollination of a large number as the result of a single insect visit. Honey is secreted at the base of the style, and is protected from rain or dew and the visits of short-lipped insects by the corolla-tube, the length of which is

correlated with the length of proboscis of the visiting insect. When the flower opens, the two stigmas are pressed together below the tube formed by the anthers, the latter split on the inside, and the pollen fills the tube; the style gradually lengthens and carries the pollen out of the anther tube, and finally the stigmas spread and expose their receptive surface which has hitherto been hidden, the two being pressed together. Thus the life history of the flower falls into two stages, an earlier or male and a later or female. This favours cross-pollination as compared with self-pollination. In many cases there is a third stage, as in dandelion, where the stigmas finally curl back so that they touch any pollen grains which have been left on the style, thus ensuring self-pollination if cross-pollination has not been effected.

The devices for distribution of the fruit are very varied. Frequently there is a hairy or silky pappus forming a tuft of hairs, as in thistle or coltsfoot, or a parachute-like structure as in dandelion; these render the fruit sufficiently light to be carried by the wind. In *Bidens* the pappus consists of two or more stiff-barbed bristles which cause the fruit to cling to the coats of animals. Occasionally, as in sunflower or daisy, the fruits bear no special appendage and remain on the head until jerked off.

Compositae are generally considered to represent the most highly developed order of flowering plants. By the massing of the flowers in heads great economy is effected in the material required for one flower, as conspicuousness is ensured by the association; economy of time on the part of the pollinating insect is also effected, as a large number of flowers are visited at one time. The floral mechanism is both simple and effective,



FIG. 2.—Flowering shoot of Cornflower.
1. Disk-floret in vertical section.

favouring cross-pollination, but ensuring self-pollination should that fail. The means of seed-distribution are also very effective.

A few members of the order are of economic value, e.g. *Lactuca* (lettuce; *q.v.*), *Cichorium* (chicory; *q.v.*), *Cynara* (artichoke and cardoon; *q.v.*), *Helianthus* (Jerusalem artichoke). Many are cultivated as garden or greenhouse plants, such as *Solidago* (golden rod), *Ageratum*, *Aster* (*q.v.*) (Michaelmas daisy), *Helichrysum* (everlasting), *Zinnia*, *Rudbeckia*, *Helianthus* (sunflower), *Coreopsis*, *Dahlia* (*q.v.*), *Tagetes* (French and African

marigold), *Gaillardia*, *Achillea* (yarrow), *Chrysanthemum*, *Pyrethrum* (feverfew; now generally included under *Chrysanthemum*), *Tanacetum* (tansy), *Arnica*, *Doronicum*, *Cineraria*, *Calendula* (common marigold) (fig. 1), *Echinops* (globe thistle), *Centaurea* (cornflower) (fig. 2). Some are of medicinal value, such as *Anthemis* (chamomile), *Artemisia* (wormwood), *Tussilago* (coltsfoot), *Arnica*. Insect powder is prepared from species of *Pyrethrum*.

The order is divided into two suborders:—*Tubuliflorae*, characterized by absence of latex, and the florets of the disk

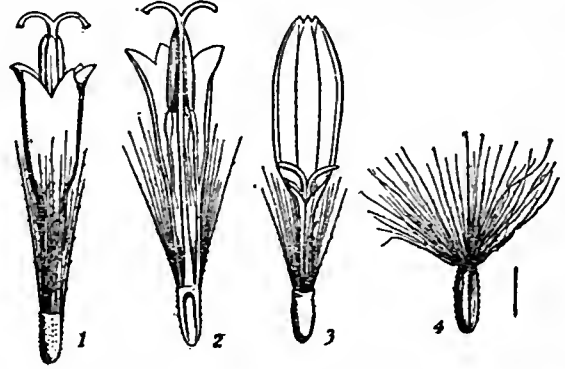

FIG. 3.—Groundsel (*Senecio vulgaris*).
1. Disk-floret. 3. Ray-floret.
2. Same cut vertically. 4. Fruit with pappus.

being not ligulate, and *Liguliflorae*, characterized by presence of latex and all the florets being ligulate. The first suborder contains the majority of the genera, and is divided into a number of tribes, characterized by the form of the anthers and styles, the presence or absence of scales on the receptacle, and the similarity or otherwise of the florets of one and the same head. The order is well represented in Britain, in which forty-two genera are native. These include some of the commonest weeds, such as dandelion (*Taraxacum Dens-leonis*), daisy (*Bellis perennis*), groundsel (fig. 3) (*Senecio vulgaris*) and ragwort (*S. Jacobaea*); coltsfoot (*Tussilago Farsfara*) is one of the earliest plants to flower, and other genera are *Chrysanthemum* (ox-eye daisy and corn-marigold), *Arctium* (burdock), *Centaurea* (knapweed and cornflower), *Carduus* and *Cnicus* (thistles), *Hieracium* (hawkweed), *Sonchus* (sow-thistle), *Achillea* (yarrow, or milfoil, and sneezewort), *Eupatorium* (hemp-agrimony), *Gnaphalium* (cudweed), *Erigeron* (fleabane), *Solidago* (golden-rod), *Anthemis* (may-weed and chamomile), *Cichorium* (chicory), *Lapsana* (nipplewort), *Crepis* (hawk's-beard), *Hypochaeris* (cat's-ear), and *Tragopogon* (goat's-beard).

COMPOSITE ORDER, in architecture, a compound of the Ionic and Corinthian orders (see **ORDER**), the chief characteristic of which is found in the capital (*q.v.*), where a double row of acanthus leaves, similar to those carved round the Corinthian capital, has been added under the Ionic volutes. The richer decoration of the Ionic capital had already been employed in those of the Erechtheum, where the necking was carved with the palmette or honeysuckle. Similar decorated Ionic capitals were found in the forum of Trajan. The earliest example of the Composite capital is found in the arch of Titus at Rome. The entablature was borrowed from that of the Corinthian order.

COMPOSITION (Lat. *compositio*, from *componere*, to put together), the action of putting together and combining, and the product of such action. There are many applications of the word. In philology it is used of the putting together of two distinct words to form a single word; and in grammar, of the combination of words into sentences, and sentences into periods, and then applied to the result of such combination, and to the art of producing a work in prose or verse, or to the work itself. In music "composition" is used both of the art of combining musical sounds in accordance with the rules of musical form, and, more generally, of the whole art of creation or invention. The name "composer" is thus particularly applied to the musical creator in general. In the other fine arts the word is

more strictly used of the balanced arrangement of the parts of a picture, of a piece of sculpture or a building, so that they should form one harmonious whole. The word also means an agreement or an adjustment of differences between two or more parties, and is thus the best general term to describe the agreement, often called by the equivalent German word "Ausgleich," between Austria and Hungary in 1867. A more particular use is the legal one, for an agreement by which a creditor agrees to take from his debtor a sum less than his debt in satisfaction of the whole (see BANKRUPTCY). In logic "composition" is the name given to a fallacy of equivocation, where what is true distributively of each member of a class is inferred to be true of the whole class collectively. The fallacy of "division" is the converse of this, where what is true of a term used collectively is inferred to be true of its several parts. A common source of these errors in reasoning is the confusion between the collective and distributive meanings of the word "all." Composition, often shortened to "compo," is the name given to many materials compounded of more than one substance, and is used in various trades and manufactures, as in building, for a mixture, such as stucco, cement and plaster, for covering walls, &c., often made to represent stone or marble; a similar moulded compound is employed to represent carved wood.

COMPOUND (from Lat. *componere*, to combine or put together), a combination of various elements, substances or ingredients, so as to form one composite whole. A "chemical compound" is a substance which can be resolved into simple constituents, as opposed to an element which cannot be so resolved (see CHEMISTRY); a word is said to be a "compound" when it is made up of different words or parts of different words. The term is also used in an adjectival form with many applications; a "compound engine" is one where the expansion of the steam is effected in two or more stages (see STEAM-ENGINE); in zoology, the "compound eye" possessed by insects and crustacea is one which is made up of several *ocelli* or simple eyes, set together so that the whole has the appearance of being faceted (see EYE); in botany, the "compound leaf" has two or more separate blades on a common leaf-stalk; in surgery, in a "compound fracture" the skin is broken as well as the bone, and there is a communication between the two. There are many mathematical and arithmetical uses of the term, particularly of those forms of addition, multiplication, division and subtraction which deal with quantities of more than one denomination. Compound interest is interest paid upon interest, the accumulation of interest forming, as it were, a secondary principal. The verb "to compound" is used of the arrangement or settlement of differences, and especially of an agreement made to accept or to pay part of a debt in full discharge of the whole, and thus of the arrangement made by an insolvent debtor with his creditors (see BANKRUPTCY); similarly of the substitution of one payment for annual or other periodic payments,—thus subscriptions, university or other dues, &c., may be "compounded"; a particular instance of this is the system of "compounding" for rates, where the occupier of premises pays an increased rent, and the owner makes himself responsible for the payment of the rates. The householder who thus compounds with the owner of the premises he occupies is known as a "compound householder." The payment of poor rate forming part of the qualification necessary for the parliamentary franchise in the United Kingdom, various statutes, leading up to the Compound Householders Act 1851, have enabled such occupiers to claim to be placed on the rate. In law, to compound a felony is to agree with the felon not to prosecute him for his crime, in return for valuable consideration, or, in the case of a theft, on return of the goods stolen. Such an agreement is a misdemeanour and is punishable with fine and imprisonment.

The name "compounders" was given during the reign of William III. of England to the members of a Jacobite faction, who were prepared to restore James II. to the throne, on the condition of an amnesty and an undertaking to preserve the constitution. Until 1853, in the university of Oxford, those possessing private incomes of a certain amount paid special

dues for their degrees, and were known as Grand and Petty Compounders.

The corruption "compound" (from the Malay *kampung* or *kampong*, a quarter of a village) is the name applied to the enclosed ground, whether garden or waste, which surrounds an Anglo-Indian house. In India the European quarter, as a rule, is separate from the native quarter, and consists of a number of single houses, each standing in a compound, sometimes many acres in extent.

COMPOUND PIER, the architectural term given to a clustered column or pier which consists of a centre mass or newel, to which engaged or semi-detached shafts have been attached, in order to perform, or to suggest the performance of, certain definite structural objects, such as to carry arches of additional orders, or to support the transverse or diagonal ribs of a vault, or the tie beam of an important roof. In these cases, though performing different functions, the drums of the pier are often cut out of one stone. There are, however, cases where the shafts are detached from the pier and coupled to it by armulets at regular heights, as in the Early English period.

COMPRADOR (a Portuguese word used in the East, derived from the Lat. *comparare*, to procure), originally a native servant in European households in the East, but now the name given to the native managers in European business houses in China, and also to native contractors supplying ships in the Philippines and elsewhere in the East.

COMPRESSION, in astronomy, the deviation of a heavenly body from the spherical form, called also the "ellipticity." It is numerically expressed by the ratio of the differences of the axes to the major axis of the spheroid. The compression or "flattening" of the earth is about 1/298, which means that the ratio of the equatorial to the polar axis is 298:297 (see EARTH, FIGURE OF THE). In engineering the term is applied to the arrangement by which the exhaust valve of a steam-engine is made to close, shutting a portion of the exhaust steam in the cylinder, before the stroke of the piston is quite complete. This steam being compressed as the stroke is completed, a cushion is formed against which the piston does work while its velocity is being rapidly reduced, and thus the stresses in the mechanism due to the inertia of the reciprocating parts are lessened. This compression, moreover, obviates the shock which would otherwise be caused by the admission of the fresh steam for the return stroke. In internal combustion engines it is a necessary condition of economy to compress the explosive mixture before it is ignited: in the Otto cycle, for instance, the second stroke of the piston effects the compression of the charge which has been drawn into the cylinder by the first forward stroke.

COMPROMISE (pronounced *comprōmize*; through Fr. from Lat. *compromittere*), a term, meaning strictly a joint agreement, which has come to signify such a settlement as involves a mutual adjustment, with a surrender of part of each party's claim. From the element of danger involved has arisen an invidious sense of the word, imputing discredit, so that being "compromised" commonly means injured in reputation.

COMPROMISE MEASURES OF 1850, in American history, a series of measures the object of which was the settlement of five questions in dispute between the pro-slavery and anti-slavery factions in the United States. Three of these questions grew out of the annexation of Texas and the acquisition of western territory as a result of the Mexican War. The settlers who had flocked to California after the discovery of gold in 1848 adopted an anti-slavery state constitution on the 13th of October 1849, and applied for admission into the Union. In the second place it was necessary to form a territorial government for the remainder of the territory acquired from Mexico, including that now occupied by Nevada and Utah, and parts of Wyoming, Colorado, Arizona and New Mexico. The fundamental issue was in regard to the admission of slavery into, or the exclusion of slavery from, this region. Thirdly, there was a dispute over the western boundary of Texas. Should the Rio Grande be the line of division north of Mexico, or should an arbitrary boundary be established farther to the eastward; in other words, should a considerable part of

the new territory be certainly opened to slavery as a part of Texas, or possibly closed to it as a part of the organized territorial section? Underlying all of these issues was of course the great moral and political problem as to whether slavery was to be confined to the south-eastern section of the country or be permitted to spread to the Pacific. The two questions not growing out of the Mexican War were in regard to the abolition of the slave trade in the District of Columbia, and the passage of a new fugitive slave law.

Congress met on the 3rd of December 1849. Neither faction was strong enough in both houses to carry out its own programme, and it seemed for a time that nothing would be done. On the 29th of January 1850 Henry Clay presented the famous resolution which constituted the basis of the ultimate compromise. His idea was to combine the more conservative elements of both sections in favour of a settlement which would concede the Southern view on two questions, the Northern view on two, and balance the fifth. Daniel Webster supported the plan in his great speech of the 7th of March, although in doing so he alienated many of his former admirers. Opposed to the conservatives were the extremists of the North, led by William H. Seward and Salmon P. Chase, and those of the South, led by Jefferson Davis. Most of the measures were rejected and the whole plan seemed likely to fail, when the situation was changed by the death of President Taylor and the accession of Millard Fillmore on the 9th of July 1850. The influence of the administration was now thrown in favour of the compromise. Under a tacit understanding of the moderates to vote together, five separate bills were passed, and were signed by the president between 9th and 20th September 1850. California was admitted as a free state, and the slave trade was abolished in the District of Columbia; these were concessions to the North. New Mexico (then including the present Arizona) and Utah were organized without any prohibition of slavery (each being left free to decide for or against, on admission to statehood), and a rigid fugitive slave law was enacted; these were concessions to the South. Texas (*q.v.*) was compelled to give up much of the western land to which it had a good claim, and received in return \$10,000,000.

This legislation had several important results. It helped to postpone secession and Civil War for a decade, during which time the North-West was growing more wealthy and more populous, and was being brought into closer relations with the North-East. It divided the Whigs into "Cotton Whigs" and "Conscience Whigs," and in time led to the downfall of the party. In the third place, the rejection of the Wilmot Proviso and the acceptance (as regards New Mexico and Utah) of "Squatter Sovereignty" meant the adoption of a new principle in dealing with slavery in the territories, which, although it did not apply to the same territory, was antagonistic to the Missouri Compromise of 1820. The sequel was the repeal of the Missouri Compromise in the Kansas-Nebraska Bill of 1854. Fourthly, the enforcement of the fugitive slave law aroused a feeling of bitterness in the North which helped eventually to bring on the war, and helped to make it, when it came, quite as much an anti-slavery crusade as a struggle for the preservation of the Union. Finally, although Clay for his support of the compromises and Seward and Chase for their opposition have gained in reputation, Webster has been selected as the special target for hostile criticism. The Compromise Measures are sometimes spoken of collectively as the Omnibus Bill, owing to their having been grouped originally—when first reported (May 8) to the Senate—into one bill.

The best account of the above Compromises is to be found in J. F. Rhodes, *History of the United States from the Compromise of 1850*, vol. i. (New York, 1896).

(W. R. S.*)

COMPSA (mod. *Conza*), an ancient city of the Hirpini, near the sources of the Aufidus, on the boundary of Lucania and not far from that of Apulia, on a ridge 1998 ft. above sea-level. It was betrayed to Hannibal in 216 B.C. after the defeat of Cannae, but recaptured two years later. It was probably occupied by Sulla in 89 B.C., and was the scene of the death of T. Annius Milo in 48 B.C. Most authorities (cf. Hülsen in Pauly-Wissowa, *Realencyclopädie*, Stuttgart, 1901, iv. 797) refer Caes. *Bell.*

civ. iii. 22, and Plin. *Hist. Nat.* ii. 147, to this place, supposing the MSS. to be corrupt. The usual identification of the site of Milo's death with Cassano on the Gulf of Taranto must therefore be rejected. In imperial times, as inscriptions show, it was a *municipium*, but it lay far from any of the main high-roads. There are no important ancient remains.

COMPTON, HENRY (1632–1713), English divine, was the sixth and youngest son of the second earl of Northampton. He was educated at Queen's College, Oxford, and then travelled in Europe. After the restoration of Charles II. he became cornet in a regiment of horse, but soon quitted the army for the church. After a further period of study at Cambridge and again at Oxford, he held various livings. He was made bishop of Oxford in 1674, and in the following year was translated to the see of London. He was also appointed a member of the Privy Council, and entrusted with the education of the two princesses—Mary and Anne. He showed a liberality most unusual at the time to Protestant dissenters, whom he wished to reunite with the established church. He held several conferences on the subject with the clergy of his diocese; and in the hope of influencing candid minds by means of the opinions of unbiassed foreigners, he obtained letters treating of the question (since printed at the end of Stillingfleet's *Unreasonableness of Separation*) from Le Moynes, professor of divinity at Leiden, and the famous French Protestant divine, Jean Claude. But to Roman Catholicism he was strongly opposed. On the accession of James II. he consequently lost his seat in the council and his deanery in the Chapel Royal; and for his firmness in refusing to suspend John Sharp, rector of St Giles's-in-the-Fields, whose anti-papal writings had rendered him obnoxious to the king, he was himself suspended. At the Revolution Compton embraced the cause of William and Mary; he performed the ceremony of their coronation; his old position was restored to him; and among other appointments, he was chosen as one of the commissioners for revising the liturgy. During the reign of Anne he remained a member of the privy council, and was one of the commissioners appointed to arrange the terms of the union of England and Scotland; but, to his bitter disappointment, his claims to the primacy were twice passed over. He died at Fulham on the 7th of July 1713. He had conspicuous defects both in spirit and intellect, but was benevolent and philanthropic. He was a successful botanist. He published, besides several theological works, *A Translation from the Italian of the Life of Donna Olympia Maladichini, who governed the Church during the time of Pope Innocent X., which was from the year 1644 to 1655 (1667)*; and *A Translation from the French of the Jesuits' Intrigues (1669)*.

COMPTROLLER, the title of an official whose business primarily was to examine and take charge of accounts, hence to direct or control, e.g. the English comptroller of the household, comptroller and auditor-general (head of the exchequer and audit department), comptroller-general of patents, &c., comptroller-general (head of the national debt office). On the other hand, the word is frequently spelt *controller*, as in controller of the navy, controller or head of the stationery office. The word is used in the same sense in the United States, as comptroller of the treasury, an official who examines accounts and signs drafts, and comptroller of the currency, who administers the law relating to the national banks.

COMPURGATION (from Lat. *compurgare*, to purify completely), a mode of procedure formerly employed in ecclesiastical courts, and derived from the canon law (*compurgatio canonica*), by which a clerk who was accused of crime was required to make answers on the oath of himself and a certain number of other clerks (compurgators) who would swear to his character or innocence. The term is more especially applied to a somewhat similar procedure, the old Teutonic or Anglo-Saxon mode of trial by oath-taking or oath-helping (see **JURY**).

COMTE, AUGUSTE [ISIDORE AUGUSTE MARIE FRANÇOIS XAVIER] (1798–1857), French Positive philosopher, was born on the 19th of January 1798 at Montpellier, where his father was a receiver-general of taxes for the district. He was sent for his earliest instruction to the school of the town, and in 1814

was admitted to the *École Polytechnique*. His youth was marked by a constant willingness to rebel against merely official authority; to genuine excellence, whether moral or intellectual, he was always ready to pay unbounded deference. That strenuous application which was one of his most remarkable gifts in manhood showed itself in his youth, and his application was backed or inspired by superior intelligence and aptness. After he had been two years at the *École Polytechnique* he took a foremost part in a mutinous demonstration against one of the masters; the school was broken up, and Comte like the other scholars was sent home. To the great dissatisfaction of his parents, he resolved to return to Paris (1816), and to earn his living there by giving lessons in mathematics. Benjamin Franklin was the youth's idol at this moment. "I seek to imitate the modern Socrates," he wrote to a school friend, "not in talents, but in way of living. You know that at five-and-twenty he formed the design of becoming perfectly wise and that he fulfilled his design. I have dared to undertake the same thing, though I am not yet twenty." Though Comte's character and aims were as far removed as possible from Franklin's type, neither Franklin nor any man that ever lived could surpass him in the heroic tenacity with which, in the face of a thousand obstacles, he pursued his own ideal of a vocation.

For a moment circumstances led him to think of seeking a career in America, but a friend who preceded him thither warned him of the purely practical spirit that prevailed in the new country. "If Lagrange were to come to the United States, he could only earn his livelihood by turning land surveyor." So Comte remained in Paris, living as he best could on something less than £80 a year, and hoping, when he took the trouble to break his meditations upon greater things by hopes about himself, that he might by and by obtain an appointment as mathematical master in a school. A friend procured him a situation as tutor in the house of Casimir Perier. The salary was good, but the duties were too miscellaneous, and what was still worse, there was an end of the delicious liberty of the garret. After a short experience of three weeks Comte returned to neediness and contentment. He was not altogether without the young man's appetite for pleasure; yet when he was only nineteen we find him wondering, amid the gaieties of the carnival of 1817, how a gavotte or a minuet could make people forget that thirty thousand human beings around them had barely a morsel to eat.

Towards 1818 Comte became associated as friend and disciple with Saint-Simon, who was destined to exercise a very decisive influence upon the turn of his speculation. In after years he so far forgot himself as to write of Saint-Simon as a depraved quack, and to deplore his connexion with him as purely mischievous. While the connexion lasted he thought very differently. Saint-Simon is described as the most estimable and lovable of men, and the most delightful in his relations; he is the worthiest of philosophers. Even at the very moment when Comte was congratulating himself on having thrown off the yoke, he honestly admits that Saint-Simon's influence has been of powerful service in his philosophic education. "I certainly," he writes to his most intimate friend, "am under great personal obligations to Saint-Simon; that is to say, he helped in a powerful degree to launch me in the philosophical direction that I have now definitely marked out for myself, and that I shall follow without looking back for the rest of my life." Even if there were no such unmistakable expressions as these, the most cursory glance into Saint-Simon's writings is enough to reveal the thread of connexion between the ingenious visionary and the systematic thinker. We see the debt, and we also see that when it is stated at the highest possible, nothing has really been taken either from Comte's claims as a powerful original thinker, or from his immeasurable pre-eminence over Saint-Simon in intellectual grasp and vigour and coherence. As high a degree of originality may be shown in transformation as in invention, as Molière and Shakespeare have proved in the region of dramatic art. In philosophy the conditions are not different. *Il faut prendre son bien où on le trouve.*

It is no detriment to Comte's fame that some of the ideas

which he recombined and incorporated in a great philosophic structure had their origin in ideas that were produced almost at random in the incessant fermentation of Saint-Simon's brain. Comte is in no true sense a follower of Saint-Simon, but it was undoubtedly Saint-Simon who launched him, to take Comte's own word, by suggesting the two starting-points of what grew into the Comtist system—first, that political phenomena are as capable of being grouped under laws as other phenomena; and second, that the true destination of philosophy must be social, and the true object of the thinker must be the reorganization of the moral, religious and political systems. We can readily see what an impulse these far-reaching conceptions would give to Comte's meditations. There were conceptions of less importance than these, in which it is impossible not to feel that it was Saint-Simon's wrong or imperfect idea that put his young admirer on the track to a right and perfected idea. The subject is not worthy of further discussion. That Comte would have performed some great intellectual achievement, if Saint-Simon had never been born, is certain. It is hardly less certain that the great achievement which he did actually perform was originally set in motion by Saint-Simon's conversation, though it was afterwards directly filiated with the fertile speculations of A. R. J. Turgot and Condorcet. Comte thought almost as meanly of Plato as he did of Saint-Simon, and he considered Aristotle the prince of all true thinkers; yet their vital difference about Ideas did not prevent Aristotle from calling Plato master.

After six years the differences between the old and the young philosopher grew too marked for friendship. Comte began to fret under Saint-Simon's pretensions to be his director. Saint-Simon, on the other hand, perhaps began to feel uncomfortably conscious of the superiority of his disciple. The occasion of the breach between them (1824) was an attempt on Saint-Simon's part to print a production of Comte's as if it were in some sort connected with Saint-Simon's schemes of social reorganization. Not only was the breach not repaired, but long afterwards Comte, as we have said, with painful ungraciousness took to calling the encourager of his youth by very hard names.

In 1825 Comte married a *Mdlle* Caroline Massin. His marriage was one of those of which "magnanimity owes no account to prudence," and it did not turn out prosperously. *Marriage.* His family were strongly Catholic and royalist, and they were outraged by his refusal to have the marriage performed other than civilly. They consented, however, to receive his wife, and the pair went on a visit to Montpellier. Madame Comte conceived a dislike to the circle she found there, and this was the too early beginning of disputes which lasted for the remainder of their union. In the year of his marriage we find Comte writing to the most intimate of his correspondents:—"I have nothing left but to concentrate my whole moral existence in my intellectual work, a precious but inadequate compensation; and so I must give up, if not the most dazzling, still the sweetest part of my happiness." He tried to find pupils to board with him, but only one pupil came, and he was soon sent away for lack of companions. "I would rather spend an evening," wrote the needy enthusiast, "in solving a difficult question, than in running after some empty-headed and consequential millionaire in search of a pupil." A little money was earned by an occasional article in *Le Producteur*, in which he began to expound the philosophic ideas that were now maturing in his mind. He announced a course of lectures (1826), which it was hoped would bring money as well as fame, and which were to be the first dogmatic exposition of the Positive Philosophy. A friend had said to him, "You talk too freely, your ideas are getting abroad, and other people use them without giving you the credit; put your ownership on record." The lectures attracted hearers so eminent as Humboldt the cosmologist, Poinsoy the geometer and Blainville the physiologist.

Unhappily, after the third lecture of the course, Comte had a severe attack of cerebral derangement, brought on by intense and prolonged meditation, acting on a system that was already irritated by the chagrin of domestic discomfort. He did not recover his health for more than a year, and as soon as

convalescence set in he was seized by so profound a melancholy at the disaster which had thus overtaken him, that he threw himself into the Seine. Fortunately he was rescued, and the shock did not stay his return to mental soundness.

Serious illness.

One incident of this painful episode is worth mentioning. Lamennais, then in the height of his Catholic exaltation, persuaded Comte's mother to insist on her son being married with the religious ceremony, and as the younger Madame Comte apparently did not resist, the rite was duly performed, in spite of the fact that Comte was at the time raving mad. Philosophic assailants of Comtism have not always resisted the temptation to recall the circumstance that its founder was once out of his mind. As has been justly said, if Newton once suffered a cerebral attack without forfeiting our veneration for the *Principia*, Comte may have suffered in the same way, and still not have forfeited our respect for Positive Philosophy and Positive Polity.

In 1828 the lectures were renewed, and in 1830 was published the first volume of the *Course of Positive Philosophy*. The sketch and ground plan of this great undertaking had appeared in 1826. The sixth and last volume was published in 1842. The twelve years covering the

Official work.

publication of the first of Comte's two elaborate works were years of indefatigable toil, and they were the only portion of his life in which he enjoyed a certain measure, and that a very modest measure, of material prosperity. In 1833 he was appointed examiner of the boys who in the various provincial schools aspired to enter the École Polytechnique at Paris. This and two other engagements as a teacher of mathematics secured him an income of some £400 a year. He made M. Guizot, then Louis Philippe's minister, the important proposal to establish a chair of general history of the sciences. If there are four chairs, he argued, devoted to the history of philosophy, that is to say, the minute study of all sorts of dreams and aberrations through the ages, surely there ought to be at least one to explain the formation and progress of our real knowledge? This wise suggestion, still unfulfilled, was at first welcomed, according to Comte's own account, by Guizot's philosophic instinct, and then repulsed by his "metaphysical rancour."

Meanwhile Comte did his official work conscientiously, sorely as he grudged the time which it took from the execution of the great object of his thoughts. "I hardly know if even to you," he writes to his wife, "I dare disclose the sweet and softened feeling that comes over me when I find a young man whose examination is thoroughly satisfactory. Yes, though you may smile, the emotion would easily stir me to tears if I were not carefully on my guard." Such sympathy with youthful hope, in union with industry and intelligence, shows that Comte's dry and austere manner veiled the fires of a generous social emotion. It was this which made him add to his labours the burden of delivering every year from 1831 to 1848 a course of gratuitous lectures on astronomy for a popular audience. The social feeling that inspired this disinterested act showed itself in other ways. He suffered imprisonment rather than serve in the national guard; his position was that though he would not take arms against the new monarchy of July, yet being a republican he would take no oath to defend it. The only amusement that Comte permitted himself was a visit to the opera. In his youth he had been a playgoer, but he shortly came to the conclusion that tragedy is a stilted and bombastic art, and after a time comedy interested him no more than tragedy. For the opera he had a genuine passion, which he gratified as often as he could, until his means became too narrow to afford even that single relaxation.

Of his manner and personal appearance we have the following account from one who was his pupil:—"Daily as the clock struck eight on the horologe of the Luxembourg, while the ringing hammer on the bell was yet audible, the door of my room opened, and there entered a man, short, rather stout, almost what one might call sleek, freshly shaven, without vestige of whisker or moustache. He was invariably dressed in a suit of the most spotless black, as if going to a dinner party;

his white neck-cloth was fresh from the laundress's hands, and his hat shining like a racer's coat. He advanced to the arm-chair prepared for him in the centre of the writing-table, laid his hat on the left-hand corner; his snuff-box was deposited on the same side beside the quire of paper placed in readiness for his use, and dipping the pen twice into the ink-bottle, then bringing it to within an inch of his nose to make sure it was properly filled, he broke silence: 'We have said that the chord AB,' &c. For three-quarters of an hour he continued his demonstration, making short notes as he went on, to guide the listener in repeating the problem alone; then, taking up another cahier which lay beside him, he went over the written repetition of the former lesson. He explained, corrected or commented till the clock struck nine; then, with the little finger of the right hand brushing from his coat and waistcoat the shower of superfluous snuff which had fallen on them, he pocketed his snuff-box, and resuming his hat, he as silently as when he came in made his exit by the door which I rushed to open for him."

In 1842, as we have said, the last volume of the *Positive Philosophy* was given to the public. Instead of that contentment which we like to picture as the reward of twelve years of meritorious toil devoted to the erection of a high philosophic edifice, Comte found himself in the midst of a very sea of small troubles, of that uncompensated kind that harass without elevating, and waste a man's spirit without softening or enlarging it. First, the jar of temperament between Comte and his wife had become so unbearable that they separated (1842). We know too little of the facts to allot blame to either of them. In spite of one or two disadvantageous facts in her career, Madame Comte seems to have uniformly comported herself towards her husband with an honourable solicitude for his well-being. Comte made her an annual allowance, and for some years after the separation they corresponded on friendly terms. Next in the list of the vexations was a lawsuit with his publisher. The publisher had inserted in the sixth volume a protest against a certain footnote, in which Comte had used some hard words about Arago. Comte threw himself into the suit with an energy worthy of Voltaire and won it. Third, and worst of all, he had prefixed a preface to the sixth volume, in which he went out of his way to rouse the enmity of the men on whom depended his annual re-election to the post of examiner for the Polytechnic school. The result was that he lost the appointment, and with it one-half of his very modest income. This was the occasion of an episode, which is of more than merely personal interest.

Before 1842 Comte had been in correspondence with J. S. Mill, who had been greatly impressed by Comte's philosophic ideas; Mill admits that his own *System of Logic* owes many valuable thoughts to Comte, and that, in the portion of that work which treats of the logic of the moral sciences, a radical improvement in the conceptions of logical method was derived from the *Positive Philosophy*. Their correspondence, which was full and copious, turned principally upon the two great questions of the equality between men and women, and of the expediency and constitution of a sacerdotal or spiritual order. When Comte found himself straitened, he confided the entire circumstances to Mill. As might be supposed by those who know the affectionate anxiety with which Mill regarded the welfare of any one whom he believed to be doing good work in the world, he at once took pains to have Comte's loss of income made up to him, until Comte should have had time to repair that loss by his own endeavour. Mill persuaded Grote, Molesworth, and Raikes Currie to advance the sum of £240. At the end of the year (1845) Comte had taken no steps to enable himself to dispense with the aid of the three Englishmen. Mill applied to them again, but with the exception of Grote, who sent a small sum, they gave Comte to understand that they expected him to earn his own living. Mill had suggested to Comte that he should write articles for the English periodicals, and expressed his own willingness to translate any such articles from the French. Comte at first fell in with the plan, but he speedily surprised and disconcerted Mill by boldly taking up the position of "high moral

Completion of "Positive Philosophy."

J. S. Mill.

magistrate," and accusing the three defaulting contributors of a scandalous falling away from righteousness and a high mind. Mill was chilled by these pretensions; and the correspondence came to an end. There is something to be said for both sides. Comte, regarding himself as the promoter of a great scheme for the benefit of humanity, might reasonably look for the support of his friends in the fulfilment of his designs. But Mill and the others were fully justified in not aiding the propagation of a doctrine in which they might not wholly concur. Comte's subsequent attitude of censorious condemnation put him entirely in the wrong.

From 1845 to 1848 Comte lived as best he could, as well as made his wife her allowance, on an income of £200 a year. His little account books of income and outlay, with every item entered down to a few hours before his death, are accurate and neat enough to have satisfied an ancient Roman householder. In 1848, through no fault of his own, his salary was reduced to £80. Littré and others, with Comte's approval, published an appeal for subscriptions, and on the money thus contributed Comte subsisted for the remaining nine years of his life. By 1852 the subsidy produced as much as £200 a year. It is worth noticing that Mill was one of the subscribers, and that Littré continued his assistance after he had been driven from Comte's society by his high pontifical airs. We are sorry not to be able to record any similar trait of magnanimity on Comte's part. His character, admirable as it is for firmness, for intensity, for inexorable will, for iron devotion to what he thought the service of mankind, yet offers few of those softening qualities that make us love good men and pity bad ones.

It is best to think of him only as the intellectual worker, pursuing in uncomfortable obscurity the laborious and absorbing task to which he had given up his whole life. His singularly conscientious fashion of elaborating his ideas made the mental strain more intense than even so exhausting a work as the abstract exposition of the principles of positive science need have been. He did not write down a word until he had first composed the whole matter in his mind. When he had thoroughly meditated every sentence, he sat down to write, and then, such was the grip of his memory, the exact order of his thoughts came back to him as if without an effort, and he wrote down precisely what he had intended to write, without the aid of a note or a memorandum, and without check or pause. For example, he began and completed in about six weeks a chapter in the *Positive Philosophy* (vol. v. ch. 55) which would fill forty pages of this Encyclopaedia. When we reflect that the chapter is not narrative, but an abstract exposition of the guiding principles of the movements of several centuries, with many threads of complex thought running along side by side all through the speculation, then the circumstances under which it was reduced to literary form are really astonishing. It is hardly possible, however, to share the admiration expressed by some of Comte's disciples for his style. We are not so unreasonable as to blame him for failing to make his pages picturesque or thrilling; we do not want sunsets and stars and roses and ecstasy; but there is a certain standard for the most serious and abstract subjects. When compared with such philosophic writing as Hume's, Diderot's, Berkeley's, then Comte's manner is heavy, laboured, monotonous, without relief and without light. There is now and then an energetic phrase, but as a whole the vocabulary is jejune; the sentences are overloaded; the pitch is flat. A scrupulous insistence on making his meaning clear led to an iteration of certain adjectives and adverbs, which at length deadened the effect beyond the endurance of all but the most resolute students. Only the interest of the matter prevents one from thinking of Rivarol's ill-natured remark upon Condorcet, that he wrote with opium on a page of lead. The general effect is impressive, not by any virtues of style, for we do not discern one, but by reason of the magnitude and importance of the undertaking, and the visible conscientiousness and the grasp with which it is executed. It is by sheer strength of thought, by the vigorous perspicacity with which he strikes the lines of cleavage of his subject, that he makes his

way into the mind of the reader; in the presence of gifts of this power we need not quarrel with an ungainly style.

Comte pursued one practice which ought to be mentioned in connexion with his personal history, the practice of what he style *hygiène cérébrale*. After he had acquired what he considered to be a sufficient stock of material, and this happened before he had completed the *Positive Philosophy*, he abstained from reading newspapers, reviews, scientific transactions and everything else, except two or three poets (notably Dante) and the *Imitatio Christi*. It is true that his friends kept him informed of what was going on in the scientific world. Still this partial divorce of himself from the record of the social and scientific activity of his time, though it may save a thinker from the deplorable evils of dispersion, moral and intellectual, accounts in no small measure for the exaggerated egoism, and the absence of all feeling for reality, which marked Comte's later days.

In 1845 Comte made the acquaintance of Madame Clotilde de Vaux, a lady whose husband had been sent to the galleys for life. Very little is known about her qualities. She wrote a little piece which Comte rated so posterously as to talk about George Sand in the same sentence; it is in truth a flimsy performance, though it contains one or two gracious thoughts. There is true beauty in the saying—"It is unworthy of a noble nature to diffuse its pain." Madame de Vaux's letters speak well for her good sense and good feeling, and it would have been better for Comte's later work if she had survived to exert a wholesome restraint on his exaltation. Their friendship had only lasted a year when she died (1846), but the period was long enough to give her memory a supreme ascendancy in Comte's mind. Condillac, Joubert, Mill and other eminent men have shown what the intellectual ascendancy of a woman can be. Comte was as inconsolable after Madame de Vaux's death as D'Alembert after the death of Mademoiselle L'Espinasse. Every Wednesday afternoon he made a reverential pilgrimage to her tomb, and three times every day he invoked her memory in words of passionate expansion. His disciples believe that in time the world will reverence Comte's sentiment about Clotilde de Vaux, as it reveres Dante's adoration of Beatrice—a parallel that Comte himself was the first to hit upon. Yet we cannot help feeling that it is a grotesque and unseemly anachronism to apply in grave prose, addressed to the whole world, those terms of saint and angel which are touching and in their place amid the trouble and passion of the great mystic poet. Whatever other gifts Comte may have had—and he had many of the rarest kind,—poetic imagination was not among them, any more than poetic or emotional expression was among them. His was one of those natures whose faculty of deep feeling is unhappily doomed to be inarticulate, and to pass away without the magic power of transmitting itself.

Comte lost no time, after the completion of his *Course of Positive Philosophy*, in proceeding with the *System of Positive Polity*, for which the earlier work was designed to be a foundation. The first volume was published in 1851, and the fourth and last in 1854. In 1848, when the political air was charged with stimulating elements, he founded the Positive Society, with the expectation that it might grow into a reunion as powerful over the new revolution as the Jacobin Club had been in the revolution of 1789. The hope was not fulfilled, but a certain number of philosophic disciples gathered round Comte, and eventually formed themselves, under the guidance of the new ideas of the latter half of his life, into a kind of church, for whose use was drawn up the *Positivist Calendar* (1849), in which the names of those who had advanced civilization replaced the titles of the saints. Gutenberg and Shakespeare were among the patrons of the thirteen months in this calendar. In the years 1849, 1850 and 1851 Comte gave three courses of lectures at the Palais Royal. They were gratuitous and popular, and in them he boldly advanced the whole of his doctrine, as well as the direct and immediate pretensions of himself and his system. The third course ended

in the following uncompromising terms—"In the name of the Past and of the Future, the servants of Humanity—both its philosophical and its practical servants—come forward to claim as their due the general direction of this world. Their object is to constitute at length a real Providence in all departments,—moral, intellectual and material. Consequently they exclude once for all from political supremacy all the different servants of God—Catholic, Protestant or Deist—as being at once behind-hand and a cause of disturbance." A few weeks after this invitation, a very different person stepped forward to constitute himself a real Providence.

In 1852 Comte published the *Catechism of Positivism*. In the preface to it he took occasion to express his approval of Louis Napoleon's *coup d'état* of the 2nd of December,—“a fortunate crisis which has set aside the parliamentary system and instituted a dictatorial republic.” Whatever we may think of the political sagacity of such a judgment, it is due to Comte to say that he did not expect to see his dictatorial republic transformed into a dynastic empire, and, next, that he did expect from the Man of December freedom of the press and of public meeting. His later hero was the emperor Nicholas, “the only statesman in Christendom,”—as unlucky a judgment as that which placed Dr Francia in the Comtist Calendar.

In 1857 he was attacked by cancer, and died peaceably on the 5th of September of that year. The anniversary is celebrated by ceremonial gatherings of his French and English followers, who then commemorate the name and the services of the founder of their religion. By his will he appointed thirteen executors who were to preserve his rooms at 10 rue Monsieur-le-Prince as the headquarters of the new religion of Humanity.

In proceeding to give an outline of Comte's system, we shall consider the *Positive Polity* as the more or less legitimate sequel of the *Positive Philosophy*, notwithstanding the deep gulf which so eminent a critic as J. S. Mill insisted upon fixing between the earlier and the later work. There may be, as we think there is, the greatest difference in their value, and the temper is not the same, nor the method. But the two are quite capable of being regarded, and for the purposes of an account of Comte's career ought to be regarded, as an integral whole. His letters when he was a young man of one-and-twenty, and before he had published a word, show how strongly present the social motive was in his mind, and in what little account he should hold his scientific works, if he did not perpetually think of their utility for the species. “I feel,” he wrote, “that such scientific reputation as I might acquire would give more value, more weight, more useful influence to my political sermons.” In 1822 he published a *Plan of the Scientific Works necessary to reorganize Society*.

In this he points out that modern society is passing through a great crisis, due to the conflict of two opposing movements,—the first, a disorganizing movement owing to the break-up of old institutions and beliefs; the second, a movement towards a definite social state, in which all means of human prosperity will receive their most complete development and most direct application. How is this crisis to be dealt with? What are the undertakings necessary in order to pass successfully through it towards an organic state? The answer to this is that there are two series of works. The first is theoretic or spiritual, aiming at the development of a new principle of co-ordinating social relations, and the formation of the system of general ideas which are destined to guide society. The second work is practical or temporal; it settles the distribution of power, and the institutions that are most conformable to the spirit of the system which has previously been thought out in the course of the theoretic work. As the practical work depends on the conclusions of the theoretical, the latter must obviously come first in order of execution.

In 1826 this was pushed farther in a most remarkable piece called *Considerations on the Spiritual Power*—the main object of which is to demonstrate the necessity of instituting a spiritual power, distinct from the temporal power and independent of it.

In examining the conditions of a spiritual power proper for modern times, he indicates in so many terms the presence in his mind of a direct analogy between his proposed spiritual power and the functions of the Catholic clergy at the time of its greatest vigour and most complete independence,—that is to say, from about the middle of the 11th century until towards the end of the 13th. He refers to de Maistre's memorable book, *Du Pape*, as the most profound, accurate and methodical account of the old spiritual organization, and starts from that as the model to be adapted to the changed intellectual and social conditions of the modern time. In the *Positive Philosophy*, again (vol. v. p. 344), he distinctly says that Catholicism, reconstituted as a system on new intellectual foundations, would finally preside over the spiritual reorganization of modern society. Much else could be quoted to the same effect. If unity of career, then, means that Comte, from the beginning designed the institution of a spiritual power, and the systematic reorganization of life, it is difficult to deny him whatever credit that unity may be worth, and the credit is perhaps not particularly great. Even the readaptation of the Catholic system to a scientific doctrine was plainly in his mind thirty years before the final execution of the *Positive Polity*, though it is difficult to believe that he foresaw the religious mysticism in which the task was to land him. A great analysis was to precede a great synthesis, but it was the synthesis on which Comte's vision was centred from the first. Let us first sketch the nature of the analysis. Society is to be reorganized on the base of knowledge. What is the sum and significance of knowledge? That is the question which Comte's first master-work professes to answer.

The *Positive Philosophy* opens with the statement of a certain law of which Comte was the discoverer, and which has always been treated both by disciples and dissidents as the key to his system. This is the Law of the Three States. It is as follows. Each of our leading conceptions, each branch of our knowledge, passes successively through three different phases; there are three different ways in which the human mind explains phenomena, each way following the other in order. These three stages are the Theological, the Metaphysical and the Positive. Knowledge, or a branch of knowledge, is in the Theological state, when it supposes the phenomena under consideration to be due to immediate volition, either in the object or in some supernatural being. In the Metaphysical state, for volition is substituted abstract force residing in the object, yet existing independently of the object; the phenomena are viewed as if apart from the bodies manifesting them; and the properties of each substance have attributed to them an existence distinct from that substance. In the Positive state, inherent volition or external volition and inherent force or abstraction personified have both disappeared from men's minds, and the explanation of a phenomenon means a reference of it, by way of succession or resemblance, to some other phenomenon,—means the establishment of a relation between the given fact and some more general fact. In the Theological and Metaphysical state men seek a cause or an essence; in the Positive they are content with a law. To borrow an illustration from an able English disciple of Comte:—“Take the phenomenon of the sleep produced by opium. The Arabs are content to attribute it to the ‘will of God.’ Molière's medical student accounts for it by a *soporific principle* contained in the opium. The modern physiologist knows that he cannot account for it at all. He can simply observe, analyse and experiment upon the phenomena attending the action of the drug, and classify it with other agents analogous in character.”—(*Dr Bridges*.)

The first and greatest aim of the Positive Philosophy is to advance the study of society into the third of the three stages,—to remove social phenomena from the sphere of theological and metaphysical conceptions, and to introduce among them the same scientific observation of their laws which has given us physics, chemistry, physiology. Social physics will consist of the conditions and relations of the facts of society, and will have two departments,—one, statical, containing the laws of order; the other dynamical, containing the laws of progress. While

men's minds were in the theological state, political events, for example, were explained by the will of the gods, and political authority based on divine right. In the metaphysical state of mind, then, to retain our instance, political authority was based on the sovereignty of the people, and social facts were explained by the figment of a falling away from a state of nature. When the positive method has been finally extended to society, as it has been to chemistry and physiology, these social facts will be resolved, as their ultimate analysis, into relations with one another, and instead of seeking causes in the old sense of the word, men will only examine the conditions of social existence. When that stage has been reached, not merely the greater part, but the whole, of our knowledge will be impressed with one character, the character, namely, of positivity or scientificity; and all our conceptions in every part of knowledge will be thoroughly homogeneous. The gains of such a change are enormous. The new philosophical unity will now in its turn regenerate all the elements that went to its own formation. The mind will pursue knowledge without the wasteful jar and friction of conflicting methods and mutually hostile conceptions; education will be regenerated; and society will reorganize itself on the only possible solid base—a homogeneous philosophy.

The *Positive Philosophy* has another object besides the demonstration of the necessity and propriety of a science of society. This object is to show the sciences as branches from a single trunk,—is to give to science the ensemble or spirit or generality hitherto confined to philosophy, and to give to philosophy the rigour and solidity of science. Comte's special object is a study of social physics, a science that before his advent was still to be formed; his second object is a review of the methods and leading generalities of all the positive sciences already formed, so that we may know both what system of inquiry to follow in our new science, and also where the new science will stand in relation to other knowledge.

The first step in this direction is to arrange scientific method and positive knowledge in order, and this brings us to another cardinal element in the Comtist system, the classification of the sciences. In the front of the inquiry lies one main division, that, namely, between speculative and practical knowledge. With the latter we have no concern. Speculative or theoretic knowledge is divided into abstract and concrete. The former is concerned with the laws that regulate phenomena in all conceivable cases: the latter is concerned with the application of these laws. Concrete science relates to objects or beings; abstract science to events. The former is particular or descriptive; the latter is general. Thus, physiology is an abstract science; but zoology is concrete. Chemistry is abstract; mineralogy is concrete. It is the method and knowledge of the abstract sciences that the Positive Philosophy has to reorganize in a great whole.

Comte's principle of classification is that the dependence and order of scientific study follows the dependence of the phenomena. Thus, as has been said, it represents both the objective dependence of the phenomena and the subjective dependence of our means of knowing them. The more particular and complex phenomena depend upon the simpler and more general. The latter are the more easy to study. Therefore science will begin with those attributes of objects which are most general, and pass on gradually to other attributes that are combined in greater complexity. Thus, too, each science rests on the truths of the sciences that precede it, while it adds to them the truths by which it is itself constituted. Comte's series or hierarchy is arranged as follows:—(1) Mathematics (that is, number, geometry, and mechanics), (2) Astronomy, (3) Physics, (4) Chemistry, (5) Biology, (6) Sociology. Each of the members of this series is one degree more special than the member before it, and depends upon the facts of all the members preceding it, and cannot be fully understood without them. It follows that the crowning science of the hierarchy, dealing with the phenomena of human society, will remain longest under the influence of theological dogmas and abstract figments, and will be the last to pass into the positive stage. You cannot discover the relations of the facts of human society

without reference to the conditions of animal life; you cannot understand the conditions of animal life without the laws of chemistry; and so with the rest.

This arrangement of the sciences, and the Law of the Three States, are together explanatory of the course of human thought and knowledge. They are thus the double key of Comte's systematization of the philosophy of all the sciences from mathematics to physiology, and his analysis of social evolution, which is the base of sociology. Each science contributes its philosophy. The co-ordination of all these partial philosophies produces the general Positive Philosophy. "Thousands had cultivated science, and with splendid success; not one had conceived the philosophy which the sciences when organized would naturally evolve. A few had seen the necessity of extending the scientific method to all inquiries, but no one had seen how this was to be effected. . . . The Positive Philosophy is novel as a philosophy, not as a collection of truths never before suspected. Its novelty is the organization of existing elements. Its very principle implies the absorption of all that great thinkers had achieved; while incorporating their results it extended their methods. . . . What tradition brought was the results; what Comte brought was the organization of these results. He always claimed to be the founder of the Positive Philosophy. That he had every right to such a title is demonstrable to all who distinguish between the positive sciences and the philosophy which co-ordinated the truths and methods of these sciences into a doctrine."—G. H. Lewes.

Comte's classification of the sciences has been subjected to a vigorous criticism by Herbert Spencer. Spencer's two chief points are these:—(1) He denies that the principle of the development of the sciences is the principle of decreasing generality; he asserts that there are many examples of the advent of a science being determined by increasing generality as by increasing speciality. (2) He holds that any grouping of the sciences in a succession gives a radically wrong idea of their genesis and their interdependence; no true filiation exists; no science develops itself in isolation; no one is independent, either logically or historically. Littré, by far the most eminent of the scientific followers of Comte, concedes a certain force to Spencer's objections, and makes certain secondary modifications in the hierarchy in consequence, while still cherishing his faith in the Comtist theory of the sciences. J. S. Mill, while admitting the objections as good, if Comte's arrangement pretended to be the only one possible, still holds the arrangement as tenable for the purpose with which it was devised. G. H. Lewes asserts against Spencer that the arrangement in a series is necessary, on grounds similar to those which require that the various truths constituting a science should be systematically co-ordinated although in nature the phenomena are intermingled.

The first three volumes of the *Positive Philosophy* contain an exposition of the partial philosophies of the five sciences that precede sociology in the hierarchy. Their value has usually been placed very low by the special followers of the sciences concerned; they say that the knowledge is second-hand, is not coherent, and is too confidently taken for final. The Comtist replies that the task is philosophic, and is not to be judged by the minute accuracies of science. In these three volumes Comte took the sciences roughly as he found them. His eminence as a man of science must be measured by his only original work in that department,—the construction, namely, of the new science of society. This work is accomplished in the last three volumes of the *Positive Philosophy*, and the second and third volumes of the *Positive Polity*. The Comtist maintains that even if these five volumes together fail in laying down correctly and finally the lines of the new science, still they are the first solution of a great problem hitherto unattempted. "Modern biology has got beyond Aristotle's conception; but in the construction of the biological science, not even the most unphilosophical biologist would fail to recognize the value of Aristotle's attempt. So for sociology. Subsequent sociologists may have conceivably to

remodel the whole science, yet not the less will they recognize the merit of the first work which has facilitated their labours."—*Congress.*

We shall now briefly describe Comte's principal conceptions in sociology, his position in respect to which is held by himself, and by others, to raise him to the level of Descartes or Leibnitz.

Socio-logical concep-tions. Of course the first step was to approach the phenomena of human character and social existence with the expectation of finding them as reducible to general laws as the other phenomena of the universe, and with the hope of exploring these laws by the same instruments of observation and verification as had done such triumphant work in the case of the latter. Comte separates the collective facts of society and history from the individual phenomena of biology; then he withdraws these collective facts from the region of external volition, and places them in the region of law. The facts of history must be explained, not by providential interventions, but by referring them to conditions inherent in the successive stages of social existence. This conception makes a science of society possible.

Method. What is the method? It comprises, besides observation and experiment (which is, in fact, only the observation of abnormal social states), a certain peculiarity of verification. We begin by deducing every well-known historical situation from the series of its antecedents. Thus we acquire a body of empirical generalizations as to social phenomena, and then we connect the generalizations with the positive theory of human nature. A sociological demonstration lies in the establishment of an accordance between the conclusions of historical analysis and the preparatory conceptions of biological theory. As Mill puts it:—"If a sociological theory, collected from historical evidence, contradicts the established general laws of human nature; if (to use M. Comte's instances) it implies, in the mass of mankind, any very decided natural bent, either in a good or in a bad direction; if it supposes that the reason, in average human beings, predominates over the desires, or the disinterested desires over the personal,—we may know that history has been misinterpreted, and that the theory is false. On the other hand, if laws of social phenomena, empirically generalized from history, can, when once suggested, be affiliated to the known laws of human nature; if the direction actually taken by the developments and changes of human society, can be seen to be such as the properties of man and of his dwelling-place made antecedently probable, the empirical generalizations are raised into positive laws, and sociology becomes a science." The result of this method is an exhibition of the events of human experience in co-ordinated series that manifest their own graduated connexion.

Next, as all investigation proceeds from that which is known best to that which is unknown or less well known, and as, in social states, it is the collective phenomenon that is more easy of access to the observer than its parts, therefore we must consider and pursue all the elements of a given social state together and in common. The social organization must be viewed and explored as a whole. There is a nexus between each leading group of social phenomena and other leading groups; if there is a change in one of them, that change is accompanied by a corresponding modification of all the rest. "Not only must political institutions and social manners, on the one hand, and manners and ideas, on the other, be always mutually connected; but further, this consolidated whole must be always connected by its nature with the corresponding state of the integral development of humanity, considered in all its aspects of intellectual, moral and physical activity."—*Comte.*

Is there any one element which communicates the decisive impulse to all the rest,—any predominating agency in the course of social evolution? The answer is that all the other parts of social existence are associated with, and drawn along by, the contemporary condition of intellectual development. The Reason is the superior and preponderant element which settles the direction in which all the other faculties shall expand. "It is only through the more and more marked influence of the reason, over the general conduct of man and of society, that the gradual

march of our race has attained that regularity and persevering continuity which distinguish it so radically from the desultory and barren expansion of even the highest animal orders, which share, and with enhanced strength, the appetites, the passions, and even the primary sentiments of man." The history of intellectual development, therefore, is the key to social evolution, and the key to the history of intellectual development is the Law of the Three States.

Among other central thoughts in Comte's explanation of history are these:—The displacement of theological by positive conceptions has been accompanied by a gradual rise of an industrial régime out of the military régime;—the great permanent contribution of Catholicism was the separation which it set up between the temporal and the spiritual powers;—the progress of the race consists in the increasing preponderance of the distinctively human elements over the animal elements;—the absolute tendency of ordinary social theories will be replaced by an unflinching adherence to the relative point of view, and from this it follows that the social state, regarded as a whole, has been as perfect in each period as the co-existing condition of humanity and its environment would allow.

The elaboration of these ideas in relation to the history of the civilization of the most advanced portion of the human race occupies two of the volumes of the *Positive Philosophy*, and has been accepted by very different schools as a masterpiece of rich, luminous, and far-reaching suggestion. Whatever additions it may receive, and whatever corrections it may require, this analysis of social evolution will continue to be regarded as one of the great achievements of human intellect.

The third volume of the *Positive Polity* treats of social dynamics, and takes us again over the ground of historic evolution. It abounds with remarks of extraordinary fertility and comprehensiveness; but it is often arbitrary; and its views of the past are strained into coherence with the statical views of the preceding volume. As it was composed in rather less than six months, and as the author honestly warns us that he has given all his attention to a more profound co-ordination, instead of working out the special explanations more fully, as he had promised, we need not be surprised if the result is disappointing to those who had mastered the corresponding portion of the *Positive Philosophy*. Comte explains the difference between his two works. In the first his "chief object was to discover and demonstrate the laws of progress, and to exhibit in one unbroken sequence the collective destinies of mankind, till then invariably regarded as a series of events wholly beyond the reach of explanation, and almost depending on arbitrary will. The present work, on the contrary, is addressed to those who are already sufficiently convinced of the certain existence of social laws, and desire only to have them reduced to a true and conclusive system."

The main principles of the Comtian system are derived from the *Positive Polity* and from two other works,—the *Positivist Catechism: a Summary Exposition of the Universal Religion, in Twelve Dialogues between a Woman and a Priest of Humanity*; and, second, *The Subjective Synthesis* (1856), which is the first and only volume of a work upon mathematics announced at the end of the *Positive Philosophy*. The system for which the *Positive Philosophy* is alleged to have been the scientific preparation contains a Polity and a Religion; a complete arrangement of life in all its aspects, giving a wider sphere to Intellect, Energy and Feeling than could be found in any of the previous organic types,—Greek, Roman or Catholic-feudal. Comte's immense superiority over such pre-Revolutionary utopians as the Abbé Saint-Pierre, no less than over the group of post-revolutionary utopians, is especially visible in this firm grasp of the cardinal truth that the improvement of the social organism can only be effected by a moral development, and never by any changes in mere political mechanism, or any violences in the way of an artificial redistribution of wealth. A moral transformation must precede any real advance. The aim, both in public and private life, is to

Social dynamics in the Positive Polity.

The Positivist system.

Decisive importance of Intellectual development.

secure to the utmost possible extent the victory of the social feeling over self-love, or Altruism over Egoism.¹ This is the key to the regeneration of social-existence, as it is the key to that unity of individual life which makes all our energies converge freely and without wasteful friction towards a common end. What are the instruments for securing the preponderance of Altruism? Clearly they must work from the strongest element in human nature, and this element is Feeling or the Heart. Under the Catholic system the supremacy of Feeling was abused, and the Intellect was made its slave. Then followed a revolt of Intellect against Sentiment. The business of the new system will be to bring back the Intellect into a condition, not of slavery, but of willing ministry to the Feelings. The subordination never was, and never will be, effected except by means of a religion, and a

The Religion of humanity.

religion, to be final, must include a harmonious synthesis of all our conceptions of the external order of the universe. The characteristic basis of a religion is the existence of a Power without us, so superior to ourselves as to command the complete submission of our whole life. This basis is to be found in the Positive stage, in Humanity, past, present and to come, conceived as the Great Being.

"A deeper study of the great universal order reveals to us at length the ruling power within it of the true Great Being, whose destiny it is to bring that order continually to perfection by constantly conforming to its laws, and which thus best represents to us that system as a whole. This undeniable Providence, the supreme dispenser of our destinies, becomes in the natural course the common centre of our affections, our thoughts, and our actions. Although this Great Being evidently exceeds the utmost strength of any, even of any collective, human force, its necessary constitution and its peculiar function endow it with the truest sympathy towards all its servants. The least amongst us can and ought constantly to aspire to maintain and even to improve this Being. This natural object of all our activity, both public and private, determines the true general character of the rest of our existence, whether in feeling or in thought; which must be devoted to love, and to know, in order rightly to serve, our Providence, by a wise use of all the means which it furnishes to us. Reciprocally this continued service, whilst strengthening our true unity, renders us at once both happier and better."

The exaltation of Humanity into the throne occupied by the Supreme Being under monotheistic systems made all the rest of Comte's construction easy enough. Utility remains the test of every institution, impulse, act; his fabric becomes substantially an arch of utilitarian propositions, with an artificial Great Being inserted at the top to keep them in their place. The Comtist system is utilitarianism crowned by a fantastic decoration. Translated into the plainest English, the position is as follows: "Society can only be regenerated by the greater subordination of politics to morals, by the moralization of capital, by the renovation of the family, by a higher conception of marriage and so on. These ends can only be reached by a heartier development of the sympathetic instincts. The sympathetic instincts can only be developed by the Religion of Humanity." Looking at the problem in this way, even a moralist who does not expect theology to be the instrument of social revival, might still ask whether the sympathetic instincts will not necessarily be already developed to their highest point, before people will be persuaded to accept the religion, which is at the bottom hardly more than sympathy under a more imposing name. However that may be, the whole battle—into which we shall not enter—as to the legitimacy of Comtism as a religion turns upon this erection of Humanity into a Being. The various hypotheses, dogmas, proposals, as to the family, to capital, &c., are merely propositions measurable by considerations of utility and a balance of expediencies. Many of these proposals are of the highest interest, and many of them are actually available; but there does not seem to be one of them of an available kind, which could not equally well be approached from other sides, and even incorporated in some radically antagonistic system. Adoption, for example, as a practice for improving the happiness of families and the welfare of society, is capable of being weighed, and can in truth only be weighed, by utilitarian considerations, and has been commended

¹ For Comte's place in the history of ethical theory see *ETHICS*.

by men to whom the Comtist religion is naught. The singularity of Comte's construction, and the test by which it must be tried, is the transfer of the worship and discipline of Catholicism to a system in which "the conception of God is superseded" by the abstract idea of Humanity, conceived as a kind of Personality.

And when all is said, the invention does not help us. We have still to settle what is for the good of Humanity, and we can only do that in the old-fashioned way. There is no guidance in the conception. No effective unity can follow from it, because you can only find out the right and wrong of a given course by summing up the advantages and disadvantages, and striking a balance, and there is nothing in the Religion of Humanity to force two men to find the balance on the same side. The Comtists are no better off than other utilitarians in judging policy, events, conduct.

The particularities of the worship, its minute and truly ingenious re-adaptations of sacraments, prayers, reverent signs, down even to the invocation of a New Trinity, need not detain us. They are said, though it is not easy to believe, to have been elaborated by way of Utopia. If so, no Utopia has ever yet been presented in a style so little calculated to stir the imagination, to warm the feelings, to soothe the insurgency of the reason. It is a mistake to present a great body of hypotheses—if Comte meant them for hypotheses—in the most dogmatic and peremptory form to which language can lend itself. And there is no more extraordinary thing in the history of opinion than the perversity with which Comte has succeeded in clothing a philosophic doctrine, so intrinsically conciliatory as his, in a shape that excites so little sympathy and gives so much provocation. An enemy defined Comtism as Catholicism *minus* Christianity, to which an able champion retorted by calling it Catholicism *plus* Science. Comte's Utopia has pleased the followers of the Catholic, just as little as those of the scientific, spirit.

The elaborate and minute systematization of life, proper to the religion of Humanity, is to be directed by a priesthood. The priests are to possess neither wealth nor material power; they are not to command, but to counsel; their authority is to rest on persuasion, not on force. When religion has become positive, and society industrial, then the influence of the church upon the state becomes really free and independent, which was not the case in the middle ages. The power of the priesthood rests upon special knowledge of man and nature; but to this intellectual eminence must also be added moral power and a certain greatness of character, without which force of intellect and completeness of attainment will not receive the confidence they ought to inspire. The functions of the priesthood are of this kind:—To exercise a systematic direction over education; to hold a consultative influence over all the important acts of actual life, public and private; to arbitrate in cases of practical conflict; to preach sermons recalling those principles of generality and universal harmony which our special activities dispose us to ignore; to order the due classification of society; to perform the various ceremonies appointed by the founder of the religion. The authority of the priesthood is to rest wholly on voluntary adhesion, and there is to be perfect freedom of speech and discussion. This provision hardly consists with Comte's congratulations to the tsar Nicholas on the "wise vigilance" with which he kept watch over the importation of Western books.

From his earliest manhood Comte had been powerfully impressed by the necessity of elevating the condition of women. (See remarkable passage in his letters to M. Valat, pp. 84-87.) His friendship with Madame de Vaux had deepened the impression, and in the reconstructed society women are to play a highly important part. They are to be carefully excluded from public action, but they are to do many more important things than things political. To fit them for their functions, they are to be raised above material cares, and they are to be thoroughly educated. The family, which is so important an element of the Comtist scheme of things, exists to carry the influence of woman over man to the highest point of cultivation. Through affection she purifies the activity of

The worship and discipline.

The priesthood.

Women.

man. "Superior in power of affection, more able to keep both the intellectual and the active powers in continual subordination to feeling, women are formed as the natural intermediaries between Humanity and man. The Great Being confides specially to them its moral Providence, maintaining through them the direct and constant cultivation of universal affection, in the midst of all the distractions of thought or action, which are for ever withdrawing men from its influence. . . . Beside the uniform influence of every woman on every man, to attach him to Humanity, such is the importance and the difficulty of this ministry that each of us should be placed under the special guidance of one of these angels, to answer for him, as it were, to the Great Being. This moral guardianship may assume three types,—the mother, the wife and the daughter; each having several modifications, as shown in the concluding volume. Together they form the three simple modes of solidarity, or unity with contemporaries,—obedience, union and protection—as well as the three degrees of continuity between ages, by uniting us with the past, the present and the future. In accordance with my theory of the brain, each corresponds with one of our three altruistic instincts—veneration, attachment and benevolence."

How the positive method of observation and verification of real facts has landed us in this, and much else of the same kind, is extremely hard to guess. Seriously to examine an encyclopaedic system, that touches life, society and knowledge at every point, is evidently beyond the compass of such an article as this. There is in every chapter a whole group of speculative suggestions, each of which would need a long chapter to itself to elaborate or to discuss. There is at least one biological speculation of astounding audacity, that could be examined in nothing less than a treatise. Perhaps we have said enough to show that after performing a great and real service to thought Comte almost sacrificed his claims to gratitude by the invention of a system that, as such, and independently of detached suggestions, is markedly retrograde. But the world will take what is available in Comte, while forgetting that in his work which is as irrational in one way as Hegel is in another.

See also the article **POSITIVISM**.

BIBLIOGRAPHY.—*Works, Editions and Translations: Cours de philosophie positive* (6 vols., Paris, 1830–1842; 2nd ed. with preface by E. Littré, Paris, 1864; 5th ed., 1893–1894; Eng. trans. Harriet Martineau, 2 vols., London, 1853; 3 vols. London and New York, 1896); *Discours sur l'esprit positif* (Paris, 1844; Eng. trans. with explanation E. S. Beesley, 1905); *Ordre et progrès* (ib. 1848); *Discours sur l'ensemble de positivisme* (1848, Eng. trans. J. H. Bridges, London, 1852); *Système de politique positive, ou Traité de sociologie* (4 vols., Paris, 1852–1854; ed. 1898; Eng. trans. with analysis and explanatory summary by Bridges, F. Harrison, E. S. Beesley and others, 1875–1879); *Caléchisme positiviste* (Paris, 1852; 3rd ed., 1890; Eng. trans. R. Congreve, Lond. 1858, 3rd ed., 1891); *Appel aux Conservateurs* (Paris, 1855 and 1898); *Synthèse subjective* (1856 and 1878); *Essai de philos. mathématique* (Paris, 1878); P. Descours and H. Gordon Jones, *Fundamental Principles of Positive Philos.* (trans. 1905), with biog. preface by E. S. Beesley. The Letters of Comte have been published as follows:—the letters to M. Valat and J. S. Mill, in *La Critique philosophique* (1877); correspondence with Mde. de Vaux (ib., 1884); *Correspondance inédite d'Aug. Comte* (1903 foll.); *Lettres inédites de J. S. Mill à Aug. Comte publ. avec les réponses de Comte* (1899).

Criticism.—J. S. Mill, *Auguste Comte and Positivism*; J. H. Bridges' reply to Mill, *The Unity of Comte's Life and Doctrines* (1866); Herbert Spencer's essay on the *Genesis of Science* and pamphlet on *The Classification of the Sciences*; Huxley's "Scientific Aspects of Positivism," in his *Lay Sermons*; R. Congreve, *Essays Political, Social and Religious* (1874); J. Fiske, *Outlines of Cosmic Philosophy* (1874); G. H. Lewes, *History of Philosophy*, vol. ii.; Edward Caird, *The Social Philosophy and Religion of Comte* (Glasgow, 1885); Hermann Gruber, *Aug. Comte der Begründer des Positivismus. Sein Leben und seine Lehre* (Freiburg, 1889) and *Der Positivismus vom Tode Aug. Comtes bis auf unsere Tage, 1857–1891* (Freib. 1891); L. Lévy-Bruhl, *La Philosophie d'Aug. Comte* (Paris, 1900); H. D. Hutton, *Comte's Theory of Man's Future* (1877), *Comte, the Man and the Founder* (1891), *Comte's Life and Work* (1892); E. de Roberty, *Aug. Comte et Herbert Spencer* (Paris, 1894); J. Watson, *Comte, Mill and Spencer. An outline of Philos.* (1895 and 1899); Millet, *La Souveraineté d'après Aug. Comte* (1905); L. de Montesquieu Fezensac, *Le Système politique d'Aug. Comte* (1907); G. Dumas, *Psychologie de deux Messies positivistes* (1905). (J. Mo.; X.)

COMUS (from κῶμος, revel, or a company of revellers), in the later mythology of the Greeks, the god of festive mirth. In classic mythology the personification does not exist; but Comus appears in the *Εἰκόνες*, or *Descriptions of Pictures*, of Philostratus, a writer of the 3rd century A.D. as a winged youth, slumbering in a standing attitude, his legs crossed, his countenance flushed with wine, his head—which is sunk upon his breast—crowned with dewy flowers, his left hand feebly grasping a hunting spear, his right an inverted torch. Ben Jonson introduces Comus, in his masque entitled *Pleasure reconciled to Virtue* (1619), as the portly jovial patron of good cheer, "First father of sauce and deviser of jelly." In the *Comus, sive Phagesiposia Cimmerica; Somnium* (1608, and at Oxford, 1634), a moral allegory by a Dutch author, Hendrik van der Putten, or Erycius Puteanus, the conception is more nearly akin to Milton's, and Comus is a being whose enticements are more disguised and delicate than those of Jonson's deity. But Milton's Comus is a creation of his own. His story is one

"Which never yet was heard in tale or song
From old or modern bard, in hall or bower."

Born from the loves of Bacchus and Circe, he is "much like his father, but his mother more"—a sorcerer, like her, who gives to travellers a magic draught that changes their human face into the "brutal form of some wild beast," and, hiding from them their own foul disfigurement, makes them forget all the pure ties of life, "to roll with pleasure in a sensual sty."

COMYN, JOHN (d. c. 1300), Scottish baron, was a son of John Comyn (d. 1274), justiciar of Galloway, who was a nephew of the constable of Scotland, Alexander Comyn, earl of Buchan (d. 1289), and of the powerful and wealthy Walter Comyn, earl of Mentieth (d. 1258). With his uncle the earl of Buchan, the elder Comyn took a prominent part in the affairs of Scotland during the latter part of the 13th century, and he had interests and estates in England as well as in his native land. He fought for Henry III. at Northampton and at Lewes, and was afterwards imprisoned for a short time in London. The younger Comyn, who had inherited the lordship of Badenoch from his great-uncle the earl of Mentieth, was appointed one of the guardians of Scotland in 1286, and shared in the negotiations between Edward I. and the Scots in 1289 and 1290. When Margaret, the Maid of Norway, died in 1290, Comyn was one of the claimants for the Scottish throne, but he did not press his candidature, and like the other Comyns urged the claim of John de Baliol. After supporting Baliol in his rising against Edward I., Comyn submitted to the English king in 1296; he was sent to reside in England, but returned to Scotland shortly before his death.

Comyn's son, JOHN COMYN (d. 1306), called the "red Comyn," is more famous. Like his father he assisted Baliol in his rising against Edward I., and he was for some time a hostage in England. Having been made guardian of Scotland after the battle of Falkirk in 1298 he led the resistance to the English king for about five years, and then early in 1304 made an honourable surrender. Comyn is chiefly known for his memorable quarrel with Robert the Bruce. The origin of the dispute is uncertain. Doubtless the two regarded each other as rivals; Comyn may have refused to join in the insurrection planned by Bruce. At all events the pair met at Dumfries in January 1306; during a heated altercation charges of treachery were made, and Comyn was stabbed to death either by Bruce or by his followers.

Another member of the Comyn family who took an active part in Scottish affairs during these troubled times is JOHN COMYN, earl of Buchan (d. c. 1313). This earl, a son of Earl Alexander, was constable of Scotland, and was first an ally and then an enemy of Robert the Bruce.

CONACRE (a corruption of corn-acre), in Ireland, a system of letting land, mostly in small patches, and usually for the growth of potatoes as a kind of return instead of wages. It is now practically obsolete.

CONANT, THOMAS JEFFERSON (1802–1891), American Biblical scholar, was born at Brandon, Vermont, on the 13th of December 1802. Graduating at Middlebury College in 1823, he became tutor in the Columbian University (now George

Washington University) from 1825 to 1827, professor of Greek, Latin and German at Waterville College (now Colby College) from 1827 to 1833, professor of biblical literature and criticism in Hamilton (New York) Theological Institute from 1835 to 1851, and professor of Hebrew and of Biblical exegesis in Rochester Theological Seminary from 1851 to 1857. From 1857 to 1875 he was employed by the American Bible Union on the revision of the New Testament (1871). He married in 1830 Hannah O'Brien Chaplin (1809-1865), who was herself the author of *The Earnest Man*, a biography of Adoniram Judson (1855), and of *The History of the English Bible* (1859), besides being her husband's able assistant in his Hebrew studies. He died in Brooklyn, New York, on the 30th of April 1891. Conant was the foremost Hebrew scholar of his time in America. His treatise, *The Meaning and Use of "Baptizein" Philologically and Historically Investigated* (1860), an "appendix to the revised version of the Gospel by Matthew," is a valuable summary of the evidence for Baptist doctrine. He translated and edited Gesenius's *Hebrew Grammar* (1839; 1877), and published revised versions with notes of *Job* (1856), *Genesis* (1868), *Psalms* (1871), *Proverbs* (1872), *Isaiah i.-xiii. 22* (1874), and *Historical Books of the Old Testament, Joshua to II. Kings* (1884).

CONATION (from Lat. *conari*, to attempt, strive), a psychological term, originally chosen by Sir William Hamilton (*Lectures on Metaphysics*, pp. 127 foll.), used generally of an attitude of mind involving a tendency to take *action*, e.g. when one decides to remove an object which is causing a painful sensation, or to try to interrupt an unpleasant train of thought. This use of the word tends to lay emphasis on the mind as self-determined in relation to external objects. Another less common use of the word is to describe the pleasant or painful sensations which accompany muscular activity; the *conative* phenomena, thus regarded, are psychic changes brought about by external causes.

The chief difficulty in connexion with Conation is that of distinguishing it from Feeling, a term of very vague significance both in technical and in common usage. Thus the German psychologist F. Brentano holds that no real distinction can be made. He argues that the mental process from sorrow or dissatisfaction, through hope for a change and courage to act, up to the voluntary determination which issues in action, is a single homogeneous whole (*Psychologie*, pp. 308-309). The mere fact, however, that the series is continuous is no ground for not distinguishing its parts; if it were so, it would be impossible to distinguish by separate names the various colours in the solar spectrum, or indeed perception from conception. A more material objection, moreover, is that, in point of fact, the feeling of pleasure or pain roused by a given stimulus is specifically different from, and indeed may not be followed by, the determination to modify or remove it. Pleasure and pain, *i.e.* hedonic sensation *per se*, are essentially distinct from appetite and aversion; the pleasures of hearing music or enjoying sunshine are not in general accompanied by any volitional activity. It is true that painful sensations are generally accompanied by definite aversion or a tendency to take action, but the cases of positive pleasure are amply sufficient to support a distinction. Therefore, though in ordinary language such phrases as "feeling aversion" are quite legitimate, accurate psychology compels us to confine "feeling" to states of consciousness in which no conative activity is present, *i.e.* to the psychic phenomena of pleasure or pain considered in and by themselves. The study of such phenomena is specifically described as Hedonics (Gr. *ἡδονή*, pleasure) or Algedonics (Gr. *ἀλγηδών*, pain); the latter term was coined by H. R. Marshall (in *Pain, Pleasure and Aesthetics*, 1894), but has not been generally used.

The problem of conation is closely related to that of Attention (*q.v.*), which indeed, regarded as active consciousness, implies conation (G. T. Ladd, *Psychology*, 1894, p. 213). Thus, whenever the mind deliberately focusses itself upon a particular object, there is implied a psychic effort (for the relation between Attention and Conation, see G. F. Stout, *Analytic Psychology*, book i. chap. vi.). All conscious action, and in a less degree even unconscious or reflex action, implies attention; when the mind

"attends" to any given external object, the organ through the medium of which information regarding that object is conveyed to the mind is set in motion. (See **PSYCHOLOGY**.)

CONCA, SEBASTIANO (1679-1764), Italian painter of the Florentine school, was born at Gaeta, and studied at Naples under Francesco Solimena. In 1706, along with his brother Giovanni, who acted as his assistant, he settled at Rome, where for several years he worked in chalk only, to improve his drawing. He was patronized by the Cardinal Ottoboni, who introduced him to Clement XI.; and a Jeremiah painted in the church of St John Lateran was rewarded by the pope with knighthood and by the cardinal with a diamond cross. His fame grew quickly, and he received the patronage of most of the crowned heads of Europe. He painted till near the day of his death, and left behind him an immense number of pictures, mostly of a brilliant and showy kind, which are distributed among the churches of Italy. Of these the Probatice, or Pool of Siloam, in the hospital of Santa Maria della Scala, at Siena, is considered the finest.

CONCARNEAU, a fishing port of western France in the department of Finistère, 14 m. by road S.E. of Quimper. Pop. (1906) 7887. The town occupies a picturesque situation on an inlet opening into the Bay of La Forêt. The old portion stands on an island, and is surrounded by ramparts, parts of which are believed to date from the 14th century. It is an important centre of the sardine, mackerel and lobster fisheries. Sardine-preserving, boat-building and the manufacture of sardine-boxes are carried on.

CONCEPCIÓN, a province of southern Chile, lying between the provinces of Maule and Ñuble on the N. and Bio-Bio on the S., and extending from the Pacific to the Argentine boundary. Its outline is very irregular, the Itata river forming its northern boundary, and the Bio-Bio and one of its tributaries a part of its southern boundary. Area (estimated) 3252 sq. m.; pop. (1895) 188,190. Concepción is the most important province of southern Chile because of its advantageous commercial position, fertility and productive industries. Its coast is indented by two large well-sheltered bays, Talcahuano and Arauco, the former having the ports of Talcahuano, Penco and El Tomé, and the latter Coronel and Lota. Its railway communications are good, and the Bio-Bio, which crosses its S.W. corner, has 100 m. of navigable channel. The province produces wheat and manufactures flour for export; its wines are reputed the best in Chile, cattle are bred in large numbers, wool is produced, and considerable timber is shipped. Near the coast are extensive deposits of coal, which is shipped from Lota and Coronel, the former being the site of the most productive coal-mine in South America. The climate is mild and the rainfall is abundant. Large copper-smelting and glass works have been established at Lota because of its coal resources. The valley of the Itata is largely devoted to vine cultivation, and the port of this district, El Tomé, is noted for its wine vaults and trade. It also possesses a small woollen factory. The principal towns are on the coast and had in 1895 the following populations: Talcahuano, 10,431; Lota, 9797 (largely operatives in the mines and smelting works); Coronel, 4575; and El Tomé, 3977.

CONCEPCIÓN, a city of southern Chile, capital of a province and department of the same name, on the right bank of the Bio-Bio river, 7 m. above its mouth, and 355 m. S. S.W. of Santiago by rail. Pop. (1895) 39,837; (1902, estimated) 49,351. It is the commercial centre of a rich agricultural region, but because of obstructions at the mouth of the Bio-Bio its trade passes in great part through the port of Talcahuano, 8 m. distant by rail. The small port of Penco, situated on the same bay and 10 m. distant by rail, also receives a part of the trade because of official restrictions at Talcahuano. Concepción is one of the southern termini of the Chilean central railway, by which it is connected with Santiago to the N., with Valdivia and Puerto Montt to the S., and with the port of Talcahuano. Another line extends southward through the Chilean coal-producing districts to Curanilhué, crossing the Bio-Bio by a steel viaduct 6000 ft. long on 62 skeleton piers; and a short line of 10 m. runs

northward to Penco. The Bio-Bio is navigable above the city for 100 m. and considerable traffic comes through this channel. The districts tributary to Concepción produce wheat, wine, wool, cattle, coal and timber, and among the industrial establishments of the city are flour mills, furniture and carriage factories, distilleries and breweries. The city is built on a level plain but little above the sea-level, and is laid out in regular squares with broad streets. It is an episcopal see with a cathedral and several fine churches, and is the seat of a court of appeal. The city was founded by Pedro de Valdivia in 1550, and received the singular title of "La Concepción del Nuevo Extremo." It was located on the bay of Talcahuano where the town of Penco now stands, about 9 m. from its present site, but was destroyed by earthquakes in 1570, 1730 and 1751, and was then (1755) removed to the margin of the Bio-Bio. In 1835 it was again laid in ruins, a graphic description of which is given by Charles Darwin in *The Voyage of H.M.S. Beagle*. The city was twice burned by the Araucanians during their long struggle against the Spanish colonists.

CONCEPCIÓN, or **VILLA CONCEPCIÓN**, the principal town and a river port of northern Paraguay, on the Paraguay river, 138 m. (234 m. by river) N. of Asunción, and about 345 ft. above sea-level. Pop. (1895, estimate) 10,000, largely Indians and mestizos. It is an important commercial centre, and a port of call for the river steamers trading with the Brazilian town of Corumbá, Matto Grosso. It is the principal point for the exportation of Paraguay tea, or "yerba maté" (*Ilex paraguayensis*). The town has a street railway and telephone service, a national college, a public school, a market, and some important commercial establishments. The neighbouring country is sparsely settled and produces little except forest products. Across the river, in the Paraguayan Chaco, is an English missionary station, whose territory extends inland among the Indians for many miles.

CONCEPT¹ (Lat. *conceptus*, a thought, from *concipere*, to take together, combine in thought; Ger. *Begriff*), in philosophy, a term applied to a general idea derived from and considered apart from the particulars observed by the senses. The mental process by which this idea is obtained is called abstraction (*q.v.*). By the comparison, for instance, of a number of boats, the mind abstracts a certain common quality or qualities in virtue of which the mind affirms the general idea of "boat." Thus the connotation of the term "boat," being the sum of those qualities in respect of which all boats are regarded as alike, whatever their individual peculiarities may be, is described as a "concept." The psychic process by which a concept is affirmed is called "Conception," a term which is often loosely used in a concrete sense for "Concept" itself. It is also used even more loosely as synonymous in the widest sense with "idea," "notion." Strictly, however, it is contrasted with "perception," and implies the mental reconstruction and combination of sense-given data. Thus when one carries one's thoughts back to a series of events, one constructs a psychic whole made up of parts which take definite shape and character by their mutual interrelations. This process is called *conceptual synthesis*, the possibility of which is a *sine qua non* for the exchange of information by speech and writing. It should be noticed that this (very common) psychological interpretation of "conception" differs from the metaphysical or general philosophical definition given above, in so far as it includes mental presentations in which the universal is not specifically distinguished from the particulars. Some psychologists prefer to restrict the term to the narrower use which excludes all mental states in which particulars are cognized, even though the universal be present also.

In biology conception is the coalescence of the male and female generative elements, producing pregnancy.

¹The word "conceit" in its various senses ("idea," "plan," "fancy," "imagination," and, by modern extension, an overweening sense of one's own value) is likewise derived ultimately from the Latin *concipere*. It appears to have been formed directly from the English derivative "conceive" on the analogy of "deceit" from "deceive." According to the *New English Dictionary* there is no intermediate form in Old French.

CONCEPTUALISM (from "Concept"), in philosophy, a term applied by modern writers to a scholastic theory of the nature of universals, to distinguish it from the two extremes of Nominalism and Realism. The scholastic philosophers took up the old Greek problem as to the nature of true reality—whether the general idea or the particular object is more truly real. Between Realism which asserts that the *genus* is more real than the *species*, and that particulars have no reality, and Nominalism according to which *genus* and *species* are merely names (*nomina*, *flatus vocis*), Conceptualism takes a mean position. The conceptualist holds that universals have a real existence, but only in the mind, as the concepts which unite the individual things: e.g. there is in the mind a general notion or idea of boats, by reference to which the mind can decide whether a given object is, or is not, a boat. On the one hand "boat" is something more than a mere sound with a purely arbitrary conventional significance; on the other it has, apart from particular things to which it applies, no reality; its reality is purely abstract or conceptual. This theory was enunciated by Abelard in opposition to Roscellinus (nominalist) and William of Champeaux (realist). He held that it is only by becoming a predicate that the class-notion or general term acquires reality. Thus similarity (*conformitas*) is observed to exist between a number of objects in respect of a particular quality or qualities. This quality becomes real as a mental concept when it is predicated of all the objects possessing it ("quod de pluribus natum est praedicari"). Hence Abelard's theory is alternatively known as Sermonism (*sermo*, "predicate"). His statement of this position oscillates markedly, inclining sometimes towards the nominalist, sometimes towards the realist statement, using the arguments of the one against the other. Hence he is described by some as a realist, by others as a nominalist. When he comes to explain that objective similarity in things which is represented by the class-concept or general term, he adopts the theological Platonic view that the ideas which are the archetypes of the qualities exist in the mind of God. They are, therefore, *ante rem*, *in re* and *post rem*, or, as Avicenna stated it, *universalia ante multiplicitatem, in multiplicitate, post multiplicitatem*. (See LOGIC, METAPHYSICS.)

CONCERT (through the French from Lat. *con-*, with, and *certare*, to strive), a term meaning, in general, co-operation, agreement or union; the more specific usages being, in music, for a public performance by instrumentalists, vocalists or both combined, and in diplomacy, for an understanding or agreement for common action between two or more states, whether defined by treaty or not. The term "Concert of Europe" has been commonly applied, since the congress of Vienna (1814-1815), to the European powers consulting or acting together in questions of common interest. (See ALLIANCE and EUROPE: *History*.)

CONCERTINA, or **MELODION** (Fr. *concertina*, Ger. *Ziehharmonica* or *Bandoneon*), a wind instrument of the seraphine family with free reeds, forming a link in the evolution of the harmonium from the mouth organ, intermediate links being the cheng and the accordion. The concertina consists of two hexagonal or rectangular keyboards connected by a long expandible bellows of many folds similar to that of the accordion. The keyboards are furnished with rows of knobs, which, on being pressed down by the fingers, open valves admitting the air compressed by the bellows to the free reeds, which are thus set in vibration. These free reeds consist of narrow tongues of brass riveted by one end to the inside surface of the keyboard, and having their free ends slightly bent, some outwards, some inwards, the former actuated by suction when the bellows are expanded, the latter by compression. The pitch of the note depends upon the length and thickness of the reeds, reduction of the length tending to sharpen the pitch of the note, while reduction of the thickness lowers it. The bellows being unprovided with a valve can only draw in and emit the air through the reed valves. In order to produce the sound, the concertina is held horizontally between the hands, the bellows being by turns compressed and expanded. The English concertina, invented and patented by Sir Charles Wheatstone in 1829, the year of the

reputed invention of the accordion (*q.v.*), is constructed with a double action, the same note being produced on compressing and expanding the bellows, whereas in the German concertina or accordion two different notes are given out. Concertinas are made in complete families—treble, tenor, bass and double bass, having a combined total range of nearly seven octaves. The compass is as follows:—

Treble concertina, double action 

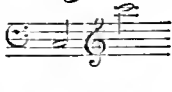
Tenor concertina, single action 

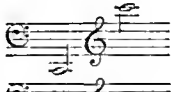
Bass concertina, single action 

Double bass concertina, single action 

The timbre of the concertina is penetrating but soft, and capable of the most delicate gradations of tone. This quality is due to a law of acoustics governing the vibration of free reeds by means of which *fortes* and *pianos* are obtained by varying the pressure of the wind, as is also the case with the double reed or the single or beating reed, while the pressure of the reed with the lips combined with greater pressure of wind produces the harmonic overtones which are not given out by free reeds. The English concertina possesses one peculiarity which renders it unsuitable for playing with instruments tuned according to the law of equal temperament, such as the pianoforte, harmonium or melodian, *i.e.* it has enharmonic intervals between G# and A# and between Db and Eb. The German concertina is not constructed according to this system; its compass extends down to C or even Bb, but it is not provided with double action. It is possible on the English concertina to play diatonic and chromatic passages or arpeggios in legato or staccato style with rapidity, shakes single and double in thirds; it is also possible to play in parts as on the pianoforte or organ and to produce very rich chords. Concertos were written for concertina with orchestra by Molique and Regondi, a sonata with piano by Molique, while Tschaiikowsky scored in his second orchestral suite for four accordions.

The aeola, constructed by the representatives of the original firm of Wheatstone, is a still more artistically developed concertina, having among other improvements steel reeds instead of brass, which increase the purity and delicacy of the timbre.

See also ACCORDION; CHENG; HARMONIUM; FREE-REED VIBRATOR. (K. S.)

CONCERTO (Lat. *concertus*, from *certare*, to strive, also confused with *concentus*), in music, a term which appears as early as the beginning of the 17th century, at first as a title of no very definite meaning, but which early acquired a sense justified by its etymology and became applied chiefly to compositions in which unequal instrumental or vocal forces are brought into opposition.

Although by Bach's time the concerto as a polyphonic instrumental form was thoroughly established, the term frequently appears in the autograph title-pages of his church cantatas, even when the cantata contains no instrumental prelude. Indeed, so entirely does the actual concerto form, as Bach understands it, depend upon the opposition of masses of tone unequal in volume with a compensating inequality in power of commanding attention, that Bach is able to rewrite an instrumental movement as a chorus without the least incongruity of style. A splendid example of this is the first chorus of a university festival cantata, *Vereinigte Zwietracht der wechselnden Saiten*, the very title of which ("united contest of turn-about strings") is a perfect definition of the earlier form of *concerto grosso*, in which the chief mass of the orchestra was opposed, not to a mere solo instrument, but to a small group called the *concertino*, or else

the whole work was for a large orchestral mass in which tutti passages alternate with passages in which the whole orchestra is dispersed in every possible kind of grouping. But the special significance of this particular chorus is that it is arranged from the second movement of the first Brandenburg concerto; and that while the orchestral material is unaltered except for transposition of key, enlargement of force and substitution of trumpets and drums for the original horns, the whole chorus part has been evolved from the solo part for a kit violin (*violino piccolo*). This admirably illustrates Bach's grasp of the true idea of a concerto, namely, that whatever the relations may be between the forces in respect of volume or sound, the whole treatment of the form must depend upon the healthy relation of function between that force which commands more and that which commands less attention. *Ceteris paribus* the individual, suitably placed, will command more attention than the crowd, whether in real life, drama or instrumental music. And in music the human voice, with human words, will thrust any orchestral force into the background, the moment it can make itself heard at all. Hence it is not surprising that the earlier concerto forms should show the closest affinity (not only in general aesthetic principle, but in many technical details) with the form of the vocal aria, as matured by Alessandro Scarlatti. And the treatment of the orchestra is, *mutatis mutandis*, exactly the same in both. The orchestra is entrusted with a highly pregnant and short summary of the main contents of the movement, and the solo, or the groups corresponding thereto, will either take up this material or first introduce new themes to be combined with it, and, in short, enter into relations with the orchestra very like those between the actors and the chorus in Greek drama. If the aria before Mozart may be regarded as a single large melody expanded by the device of the ritornello so as to give full expression to the power of a singer against an instrumental accompaniment, so the polyphonic concerto form may be regarded as an expansion of the aria form to a scale worthy of the larger and purely instrumental forces employed, and so rendered capable of absorbing large polyphonic and other types of structure incompatible with the lyric idea of the aria. The *da capo* form, by which the aria had attained its full dimensions through the addition of a second strain in foreign keys followed by the original strain *da capo*, was absorbed by the polyphonic concerto on an enormous scale, both in first movements and finales (see Bach's Klavier concerto in E, Violin concerto in E, first movement), while for slow movements the *ground bass* (see VARIATIONS), diversified by changes of key (Klavier concerto in D minor), the more melodic types of binary form, sometimes with the repeats ornamentally varied or inverted (Concerto for 3 klaviers in D minor, Concerto for Klavier, flute and violin in A minor), and in finales the *rondo* form (Violin concerto in E major, Klavier concerto in F minor) and the binary form (3rd Brandenburg concerto) may be found.

When conceptions of musical form changed and the modern sonata style arose, the peculiar conditions of the concerto gave rise to problems the difficulty of which only the highest classical intellects could appreciate or solve. The number and contrast of the themes necessary to work out a first movement of a sonata are far too great to be contained within the single musical sentence of Bach's and Handel's ritornello, even when it is as long as the thirty bars of Bach's Italian concerto (a work in which every essential of the polyphonic concerto is reproduced on the harpsichord by means of the contrasts between its full register on the lower of its two keyboards and its solo stops on both). Bach's sons had taken shrewd steps in forming the new style; and Mozart, as a boy, modelled himself closely on Johann Christian Bach, and by the time he was twenty was able to write concerto ritornellos that gave the orchestra admirable opportunity for asserting its character and resource in the statement in charmingly epigrammatic style of some five or six sharply contrasted themes, afterwards to be worked out with additions by the solo with the orchestra's co-operation and intervention. As the scale of the works increases the problem becomes very difficult, because the alternation between solo and

tutti easily produces a sectional type of structure incompatible with the high degree of organization required in first movements; yet frequent alternation is evidently necessary, as the orchestral solo is audible only above a very subdued orchestral accompaniment, and it would be highly inartistic to use the orchestra for no other purpose. Hence in the classical concerto the ritornello is never abandoned, in spite of the enormous dimensions to which the sonata style expanded it. And though from the time of Mendelssohn onwards most composers have seemed to regard it as a conventional impediment easily abandoned, it may be doubted whether any modern concerto, except the four magnificent examples of Brahms, and Dr Joachim's Hungarian concerto, possesses first movements in which the orchestra seems to enjoy breathing space. And certainly in the classical concerto the entry of the solo instrument, after the long opening tutti, is always dramatic in direct proportion to its delay. The great danger in handling so long an orchestral prelude is that the work may for some minutes be indistinguishable from a symphony and thus the entry of the solo may be unexpected without being inevitable. This is especially the case if the composer has treated his opening tutti like the exposition of a sonata movement, and made a deliberate transition from his first group of themes to a second group in a complementary key, even if the transition is only temporary, as in Beethoven's C minor concerto. Mozart keeps his whole tutti in the tonic, relieved only by his mastery of sudden subsidiary modulation; and so perfect is his marshalling of his resources that in his hands a tutti a hundred bars long passes by with the effect of a splendid pageant, of which the meaning is evidently about to be revealed by the solo. After the C minor concerto, Beethoven grasped the true function of the opening tutti and enlarged it to his new purposes. With an interesting experiment of Mozart's before him, he, in his G major concerto, *Op.* 53, allowed the solo player to state the opening theme, making the orchestra enter *pianissimo* in a foreign key, a wonderful incident which has led to the absurd statement that he "abolished the opening tutti," and that Mendelssohn in so doing has "followed his example." In this concerto he also gave considerable variety of key to the opening tutti by the use of an important theme which executes a considerable series of modulations, an entirely different thing from a deliberate modulation from material in one key to material in another. His fifth and last pianoforte concerto, in E flat, commonly called the "Emperor," begins with a rhapsodical introduction of extreme brilliance for the solo player, followed by a tutti of unusual length which is confined to the tonic major and minor with a strictness explained by the gorgeous modulations with which the solo subsequently treats the second subject. In this concerto Beethoven also dispenses with the only really conventional feature of the form, namely, the *cadenza*, a custom elaborated from the operatic aria, in which the singer was allowed to extemporize a flourish on a pause near the end. A similar pause was made in the final ritornello of a concerto, and the soloist was supposed to extemporize what should be equivalent to a symphonic coda, with results which could not but be deplorable unless the player (or *cadenza* writer) were either the composer himself, or capable of entering into his intentions, like Joachim, who has written the finest extant *cadenza* of classical violin concertos.

Brahms's first concerto in D minor, *Op.* 15, was the result of an immense amount of work, and, though on a mass of material originally intended for a symphony, was nevertheless so perfectly assimilated into the true concerto form that in his next essay, the violin concerto, *Op.* 77, he had no more to learn, and was free to make true innovations. He succeeds in presenting the contrasts even of remote keys so immediately that they are serviceable in the opening tutti and give the form a wider range in definitely functional key than any other instrumental music. Thus in the opening tutti of the D minor concerto the second subject is announced in B flat minor. In the B flat pianoforte concerto, *Op.* 83, it appears in D minor, and in the double concerto, *Op.* 102, for violin and violoncello in A minor it appears in F major. In none of these cases is it in the key in which the

solo develops it, and it is reached with a directness sharply contrasted with the symphonic deliberation with which it is approached in the solo. In the violin concerto, *Op.* 77, Brahms develops a counterplot in the opposition between solo and orchestra, inasmuch as after the solo has worked out its second subject the orchestra bursts in, not with the opening ritornello, but with its own version of the material with which the solo originally entered. In other words we have now not only the development by the solo of material stated by the orchestra but also a counter-development by the orchestra of material stated by the solo. This concerto is, on the other hand, remarkable as being the last in which a blank space is left for a *cadenza*, Brahms having in his friend Joachim a kindred spirit worthy of such trust. In the pianoforte concerto in B flat, and in the double concerto,¹ *Op.* 102, the idea of an introductory statement in which the solo takes part before the opening tutti is carried out on a large scale, and in the double concerto both first and second subjects are thus suggested. It is unnecessary to speak of the other movements of concerto form, as the sectional structure that so easily results from the opposition between solo and orchestra is not of great disadvantage to slow movements and finales, which accordingly do not show important differences from the ordinary types of symphonic and chamber music. The scherzo, on the other hand, is normally of too small a range of contrast for successful adaptation to concerto form, and the solitary great example of its use is the second movement of Brahms's B flat pianoforte concerto.

Nothing is more easy to handle with inartistic or pseudo-classic effectiveness than the opposition between a brilliant solo player and an orchestra; and, as the inevitable tendency of even the most artistic concerto has been to exhaust the resources of the solo instrument in the increased difficulty of making a proper contrast between solo and orchestra, so the technical difficulty of concertos has steadily increased until even in classical times it was so great that the orthodox definition of a concerto is that it is "an instrumental composition designed to show the skill of an executant, and one which is almost invariably accompanied by orchestra." This idea is in flat violation of the whole history and aesthetics of the form, which can never be understood by means of a study of averages. In art the average is always false, and the individual organization of the greatest classical works is the only sound basis for generalizations, historic or aesthetic. (D. F. T.)

CONCH (Lat. *concha*, Gr. *κόγχη*), a shell, particularly one of a mollusc; hence the term "conchology," the science which deals with such shells, more used formerly when molluscs were studied and classified according to the shell formation; the word is chiefly now used for the collection of shells (see *MOLLUSCA*, and such articles as *GASTROPODA*, *MALACOSTRACA*, &c.). Large spiral conchs have been from early times used as a form of trumpet, emitting a very loud sound. They are used in the West Indies and the South Sea Islands. The Tritons of ancient mythology are represented as blowing such "wreathed horns." In anatomy, the term *concha* or "conch" is used of the external ear, or of the hollowed central part leading to the meatus; and, in architecture, it is sometimes given to the half dome over the semicircular apse of the basilica. In late Roman work at Raalbek and Palmyra and in Renaissance buildings shells are frequently carved in the heads of circular niches. A low class of the negro or other inhabitants of the Bahamas and the Florida Keys are sometimes called "Conches" or "Conks" from the shell-fish which form their staple food.

CONCHOID (Gr. *κόγχη*, shell, and *εἶδος*, form), a plane curve invented by the Greek mathematician Nicomedes, who devised a mechanical construction for it and applied it to the problem of the duplication of the cube, the construction of two mean proportionals between two given quantities, and possibly to the trisection of an angle as in the 8th lemma of Archimedes. Proclus grants Nicomedes the credit of this last application, but it is disputed by Pappus, who claims that his own discovery was

¹ Double and triple concertos are concertos with two or three solo players. A concerto for several solo players is called a *concertante*.

original. The conchoid has been employed by later mathematicians, notably Sir Isaac Newton, in the construction of various cubic curves.

The conchoid is generated as follows:—Let O be a fixed point and BC a fixed straight line; draw any line through O intersecting BC in P and take on the line PO two points X, X', such that $PX = PX' = a$ constant quantity.

Then the locus of X and X' is the conchoid. The conchoid is also the locus of any point on a rod which is constrained to move so that it always passes through a fixed point, while a fixed point on the rod travels along a straight line. To obtain the equation to the curve, draw AO perpendicular to BC, and let $AO = a$; let the constant quantity $PX = PX' = b$. Then taking O as pole and a line through O parallel to BC as the initial line, the polar equation is $r = a \operatorname{cosec} \theta + b$, the upper sign referring to the branch more distant from O. The cartesian equation with A as origin and BC as axis of x is $x^2y^2 = (a+y)^2(b^2 - y^2)$. Both branches belong to the same curve and are included in this equation. Three forms of the curve have to be distinguished according to the ratio of a to b . If a be less than b , there will be a node at O and a loop below the initial point (curve 1 in the figure); if a equals b there will be a cusp at O (curve 2); if a be greater than b the curve will not pass through O, but from the cartesian equation it is obvious that O is a conjugate point (curve 3). The curve is symmetrical about the axis of y and has the axis of x for its asymptote.

CONCIERGE (a French word of unknown origin; the Latinized form was *concergius* or *concergerius*), originally the guardian of a house or castle, in the middle ages a court official who was the custodian of a royal palace. In Paris, when the *Palais de la Cité* ceased about 1360 to be a royal residence and became the seat of the courts of justice, the *Conciergerie* was turned into a prison. In modern usage a "concierge" is a hall-porter or janitor.

CONCINI, CONCINO (d. 1617), COUNT DELLA PENNA, MARSHAL D'ANCRE, Italian adventurer, minister of King Louis XIII. of France, was a native of Florence. He came to France in the train of Marie de' Medici, and married the queen's lady-in-waiting, Leonora Dori, known as Galigai. The credit which his wife enjoyed with the queen, his wit, cleverness and boldness made his fortune. In 1610 he had purchased the marquise of Ancre and the position of first gentleman-in-waiting. Then he obtained successively the governments of Amiens and of Normandy, and in 1614 the bâton of marshal. From then first minister of the realm, he abandoned the policy of Henry IV., compromised his wise legislation, allowed the treasury to be pillaged, and drew upon himself the hatred of all classes. The nobles were bitterly hostile to him, particularly Condé, with whom he negotiated the treaty of Loudun in 1616, and whom he had arrested in September 1616. This was done on the advice of Richelieu, whose introduction into politics was favoured by Concini. But Louis XIII., incited by his favourite Charles d'Albert, duc de Luynes, was tired of Concini's tutelage. The baron de Vitry received in the king's name the order to imprison him. Apprehended on the bridge of the Louvre, Concini was killed by the guards on the 24th of April 1617. Leonora was accused of sorcery and sent to the stake in the same year.

In 1767 appeared at Brescia a *De Concini vita*, by D. Sandellius. On the rôle of Concini see the *Histoire de France*, published under the direction of E. Lavisse, vol. vi. (1905), by Mariéjol.

CONCLAVE (Lat. *conclave*, from *cum*, together, and *clavis*, a key), strictly a room, or set of rooms, locked with a key; in this sense the word is now obsolete in English, though the *New English Dictionary* gives an example of its use so late as 1753. Its present loose application to any private or close assembly, especially ecclesiastical, is derived from its technical application to the assembly of cardinals met for the election of the pope, with which this article is concerned.

Conclave is the name applied to that system of strict seclusion to which the electors of the pope have been and are submitted, formerly as a matter of necessity, and subsequently as the result of a legislative enactment; hence the word has come to be used of the electoral assembly of the cardinals. This system goes back only as far as the 12th century.

Election of the Popes in Antiquity.—The very earliest episcopal nominations, at Rome as elsewhere, seem without doubt to have been made by the direct choice of the founders of the apostolic Christian communities. But this exceptional method was replaced at an early date by that of election. At Rome the method of election was the same as in other towns: the Roman clergy and people and the neighbouring bishops each took part in it in their several capacities. The people would signify their approbation or disapprobation of the candidates more or less tumultuously, while the clergy were, strictly speaking, the electoral body, met to elect for themselves a new head, and the bishops acted as presidents of the assembly and judges of the election. The choice had to meet with general consent; but we can well imagine that in an assembly of such size, in which the candidates were acclaimed rather than elected by counting votes, the various functions were not very distinct, and that persons of importance, whether clerical or lay, were bound to influence the elections, and sometimes decisively. Moreover, this form of election lent itself to cabals; and these frequently gave rise to quarrels, sometimes involving bloodshed and schisms, i.e. the election of antipopes, as they were later called. Such was the case at the elections of Cornelius (251), Damasus (366), Boniface (418), Symmachus (498), Boniface II. (530) and others. The remedy for this abuse was found in having recourse, more or less freely, to the support of the civil power. The emperor Honorius upheld Boniface against his competitor Eulalius, at the same time laying down that cases of contested election should henceforth be decided by a fresh election; but this would have been a dangerous method and was consequently never applied. Theodoric upheld Symmachus against Laurentius because he had been elected first and by a greater majority. The accepted fact soon became law, and John II. recognized (532) the right of the Ostrogothic court of Ravenna to ratify the pontifical elections. Justinian succeeded to this right together with the kingdom which he had destroyed; he demanded, together with the payment of a tribute of 3000 golden *solidi*, that the candidate elected should not receive the episcopal consecration till he had obtained the confirmation of the emperor. Hence arose long vacancies of the See, indiscreet interference in the elections by the imperial officials, and sometimes cases of simony and venality. This bondage became lighter in the 7th century, owing rather to the weakening of the imperial power than to any resistance on the part of the popes.

9th to 12th Centuries.—From the emperors of the East the power naturally passed to those of the West, and it was exercised after 824 by the descendants of Charlemagne, who claimed that the election should not proceed until the arrival of their envoys. But this did not last long; at the end of the 9th century, Rome, torn by factions, witnessed the scandal of the posthumous condemnation of Formosus. This deplorable state of affairs lasted almost without interruption till the middle of the 11th century. When the emperors were at Rome, they presided over the elections; when they were away, the rival factions of the barons, the Crescentii and the Alberici especially, struggled for the spiritual power as they did for the temporal. During this period were seen cases of popes imposed by a faction rather than elected, and then, at the mercy of sedition, deposed, poisoned and thrown into prison, sometimes to be restored by force of arms.

The influence of the Ottos (962–1002) was a lesser evil; that of the emperor Otto III. was even beneficial, in that it led to the election of Gerbert (Silvester II., in 999). But this was only a temporary check in the process of decadence, and in 1146 Clement II., the successor of the worthless Benedict IX., admitted that henceforth not only the consecration but even the election of the Roman pontiffs could only take place in presence of the

emperor. In fact, after the death of Clement II. the delegates of the Roman clergy did actually go to Polden to ask Henry III. to give them a pope, and similar steps were taken after the death of Damasus II., who reigned only twenty days. Fortunately on this occasion Henry III. appointed, just before his death, a man of high character, his cousin Bruno, bishop of Toul, who presented himself in Rome in company with Hildebrand. From this time began the reform. Hildebrand had the elections of Victor II. (1055), Stephen IX. (1057), and Nicholas II. (1058) carried out according to the canonical form, including the imperial ratification. The celebrated bull *In nomine Domini* of the 13th of April 1059 determined the electoral procedure;

Election reserved to the cardinals. it is curious to observe how, out of respect for tradition, it preserves all the former factors in the election though their scope is modified: "In the first place, the cardinal bishops shall carefully consider the election together, then they shall consult with the cardinal clergy, and afterwards the rest of the clergy and the people shall by giving their assent confirm the new election." The election, then, is reserved to the members of the higher clergy, to the cardinals, among whom the cardinal bishops have the preponderating position. The consent of the rest of the clergy and the people is now only a formality. The same was the case of the imperial intervention, in consequence of the phrase: "Saving the honour and respect due to our dear son Henry (Henry IV.), according to the concession we have made to him, and equally to his successors, who shall receive this right personally from the Apostolic See." Thus the emperor has no rights save those he has received as a concession from the Holy See. Gregory VII., it is true, notified his election to the emperor; but as he set up a series of five antipopes, none of Gregory's successors asked any more for the imperial sanction. Further, by this bull, the emperors would have to deal with the *fait accompli*; for it provided that, in the event of disturbances aroused by mischievous persons at Rome preventing the election from being carried out there freely and without bias, the cardinal bishops, together with a small number of the clergy and of the laity, should be empowered to go and hold the election where they should think fit; that should difficulties of any sort prevent the enthronement of the new pope, the pope elect would be empowered immediately to act as if he were actually pope. This legislation was definitely accepted by the emperor by the concordat of Worms (1119).

A limited electoral body lends itself to more minute legislation than a larger body; the college for electing the pope, thus reduced so as to consist in practice of the cardinals only, was subjected as time went on to laws of increasing severity. Two points of great importance were established by Alexander III. at the Lateran Council of 1179. The constitution *Licet de vitanda discordia* makes all the cardinals equally electors, and no longer mentions the lower clergy or the people; it also requires a majority of two-thirds of the votes to decide an election. This latter provision, which still holds good, made imperial antipopes henceforth impossible.

Abuses nevertheless arose. An electoral college too small in numbers, which no higher power has the right of forcing to haste, can prolong disagreements and draw out the course of the election for a long time. It is this period during which we actually find the Holy See left vacant most frequently for long spaces of time. The longest of these, however, gave an opportunity for reform and the remedy was found in the conclave, *i.e.* in the forced and rigid seclusion of the electors. As a matter of fact, this method had previously been used, but in a mitigated form: in 1216, on the death of Innocent III., the people of Perugia had shut up the cardinals; and in 1241 the Roman magistrates had confined them within the "Septizonium"; they took two months, however, to perform the election. Celestine IV. died after eighteen days, and this time, in spite of the seclusion of the cardinals, there was an interregnum of twenty months. After the death of Clement IV. in 1268, the cardinals, of whom seventeen were gathered together at Viterbo, allowed two years to pass without coming to an

agreement; the magistrates of Viterbo again had recourse to the method of seclusion: they shut up the electors in the episcopal palace, blocking up all outlets; and since the election still delayed, the people removed the roof of the palace and allowed nothing but bread and water to be sent in. Under the pressure of famine and of this strict confinement, the cardinals finally agreed, on the 1st of September 1271, to elect Gregory X., after an interregnum of two years, nine months and two days.

Taught by experience, the new pope considered what steps could be taken to prevent the recurrence of such abuses; in 1274, at the council of Lyons, he promulgated the constitution *Ubi periculum*, the substance of which was as follows: At the death of the pope, the cardinals who were present are to await their absent colleagues for ten days; they are then to meet in one of the papal palaces in a closed conclave; none of them is to have to wait on him more than one servant, or two at most if he were ill; in the conclave they are to lead a life in common, not even having separate cells; they are to have no communication with the outer world, under pain of excommunication for any who should attempt to communicate with them; food is to be supplied to the cardinals through a window which would be under watch; after three days, their meals are to consist of a single dish only; and after five days, of bread and water, with a little wine. During the conclave the cardinals are to receive no ecclesiastical revenue. No account is to be taken of those who are absent or have left the conclave. Finally, the election is to be the sole business of the conclave, and the magistrates of the town where it was held are called upon to see that these provisions be observed. Adrian V. and John XX. were weak enough to suspend the constitution *Ubi periculum*; but the abuses at once reappeared; the Holy See was again vacant for long periods; this further proof was therefore decisive, and Celestine V., who was elected after a vacancy of more than two years, took care, before abdicating the pontificate, to revive the constitution of Gregory X., which was inserted in the Decretals (lib. i. tit. vi., *de election.* cap. 3).

Since then the laws relating to the conclave have been observed, even during the great schism; the only exception was the election of Martin V., which was performed by the cardinals of the three obediences, to which the council of Constance added five prelates of each of the six nations represented in that assembly. The same was the case up to the 16th century. At this period the Italian republics, later Spain, and finally the other powers, took an intimate interest in the choice of the holder of what was a considerable political power; and each brought more or less honest means to bear, sometimes that of simony. It was against simony that Julius II. directed the bull *Cum tam divino* (1503), which directed that simoniacal election of the pope should be declared null; that any one could attack it; that men should withdraw themselves from the obedience of a pope thus elected; that simoniacal agreements should be invalid; that the guilty cardinals should be excommunicate till their death, and that the rest should proceed immediately to a new election. The purpose of this measure was good, but the proposed remedy extremely dangerous; it was fortunately never applied. Similarly, Paul IV. endeavoured by severe punishments to check the intriguing and plotting for the election of a new pope while his predecessor was still living; but the bull *Cum secundum* (1558) was of no effect.

Pius IV. undertook the task of reforming and completing the legislation of the conclave. The bull *In eligendis* (of October 1st, 1562), signed by all the cardinals, is a model of precision and wisdom. In addition to the points already stated, we may add the following: that every day there was to be a scrutiny, *i.e.* a solemn voting by specially prepared voting papers (concealing the name of the voter, and to be opened only in case of an election being made at that scrutiny), and that this was to be followed by the "accessit," *i.e.* a second voting, in which the cardinals might transfer their suffrages to those who had obtained the greatest number of votes in the first. Except in case of urgent matters, the election

Laws
made by
Gregory X.

Julius II.

Pius IV.

was to form the whole business of the conclave. The cells were to be assigned by lot. The functionaries of the conclave were to be elected by the secret vote of the Sacred College. The most stringent measures were to be taken to ensure seclusion. The bull *Aeterni Patris* of Gregory XV. (15th of November 1621) is a collection of minute regulations. In it is the rule compelling each cardinal, before giving his vote, to take the oath that he will elect him whom he shall judge to be the most worthy; it also makes rules for the forms of voting and of the voting papers, for the counting, the scrutiny, and in fact all the processes of the election. A second bull, *Decret Romanum Pontificem*, of the 12th of March 1622, fixed the ceremonial of the conclave with such minuteness that it has not been changed since.

All previous legislation concerning the conclave was codified and renewed by Pius X.'s bull, *Vacante Sede Apostolico* (Dec. 25, 1904), which abrogates the earlier texts, except Leo XIII.'s constitution *Praedecessores Nostri* (May 24, 1882), authorizing occasional derogations in circumstances of difficulty, e.g. the death of a pope away from Rome or an attempt to interfere with the liberty of the Sacred College. The bull of Pius X. is rather a codification than a reform, the principal change being the abolition of the scrutiny of accession and the substitution of a second ordinary scrutiny during the same session.

On some occasions exceptional circumstances have given rise to transitory measures. In 1797 and 1798 Pius VI. authorized the cardinals to act contrary to such of the laws concerning the conclave as a majority of them should decide not to observe, as being impossible in practice. Similarly Pius IX., by means of various acts which remained secret up till 1892, had taken the most minute precautions in order to secure a free and rapid election, and to avoid all interference on the part of the secular powers. We know that the conclaves in which Leo XIII. and Pius X. were elected enjoyed the most complete liberty, and the hypothetical measures foreseen by Pius IX. were not applied.

Until after the Great Schism the conclaves were held in various towns outside of Rome; but since then they have all been held in Rome, with the single exception of the conclave of Venice (1800), and in most cases in the Vatican.

There was no place permanently established for the purpose, but removable wooden cells were installed in the various apartments of the palace, grouped around the Sistine chapel, in which the scrutinies took place. The arrangements prepared in the Quirinal in 1823 did duty only three times, and for the most recent conclaves it was necessary to arrange an inner enclosure within the vast but irregular palace of the Vatican. Each cardinal is accompanied by a clerk or secretary, known for this reason as a conclavist, and by one servant only. With the officials of the conclave, this makes about two hundred and fifty persons who enter the conclave and have no further communication with the outer world save by means of turning-boxes. Since 1870 the solemn ceremonies of earlier times have naturally not been seen; for instance the procession which used to celebrate

the entry into conclave; or the daily arrival in procession of the clergy and the brotherhoods to enquire at the "rota" (turning-box) of the auditors of the Rota: "Habemus Pontificem?" and their return accompanied by the chanting of the "Veni Creator"; or the "Marshal of the Holy Roman Church and perpetual guardian of the conclave" visiting the churches in state. But a crowd still collects morning and evening in the great square of St Peter's; towards the time of the completion of the vote, to look for the smoke which rises from the burning of the voting-papers after each session; when the election has not been effected, a little straw is burnt with the papers, and the column of smoke then apprises the spectators that they have still no pope. Within the conclave, the cardinals, alone in the common hall, usually the Sistine chapel, proceed morning and evening to their double vote, the direct vote and the "accessit." Sometimes these sessions have been very numerous; for example, in 1740, Benedict XIV. was only elected after 255 scrutinies; on other occasions, however, and

notably in the case of the last few popes, a well-defined majority has soon been evident, and there have been but few scrutinies. Each vote is immediately counted by three scrutators, appointed in rotation, the most minute precautions being taken to ensure that the voting shall be secret and sincere. When one cardinal has at last obtained two-thirds of the votes, the dean of the cardinals formally asks him whether he accepts his election, and what name he wishes to assume. As soon as he has accepted, the first "obedience" or "adoration" takes place, and immediately after the first cardinal deacon goes to the *Loggia* of St Peter's and announces the great news to the assembled people. The conclave is dissolved; on the following day take place the two other "obediences," and the election is officially announced to the various governments. If the pope be not a bishop (Gregory XVI. was not), he is then consecrated; and finally, a few days after his election, takes place the coronation, from which the pontificate is officially dated. The pope then receives the tiara with the triple crown, the sign of his supreme spiritual authority. The ceremony of the coronation goes back to the 9th century, and the tiara, in the form of a high conical cap, is equally ancient (see *TIARA*).

In conclusion, a few words should be said with regard to the right of *veto*. In the 16th and 17th centuries the character of the conclaves was determined by the influence of what were then known as the "factions," i.e. the formation of the cardinals into groups according to their nationality or their relations with one of the Catholic courts of Spain, France or the Empire, or again according as they favoured the political policy of the late pope or his predecessor. These groups upheld or opposed certain candidates. The Catholic courts naturally entrusted the cardinals "of the crown," i.e. those of their nation, with the mission of removing, as far as lay in their power, candidates who were distasteful to their party; the various governments could even make public their desire to exclude certain candidates. But they soon claimed an actual right of formal and direct exclusion, which should be notified in the conclave in their name by a cardinal charged with this mission, and should have a decisive effect; this is what has been called the right of *veto*. We cannot say precisely at what time during the 16th century this transformation of the practice into a right, tacitly accepted by the Sacred College, took place; it was doubtless felt to be less dangerous formally to recognize the right of the three sovereigns each to object to one candidate, than to face the inconvenience of objections, such as were formulated on several occasions by Philip II., which, though less legal in form, might apply to an indefinite number of candidates. The fact remains, however, that it was a right based on custom, and was not supported by any text or written concession; but the diplomatic right was straightforward and definite, and was better than the intrigues of former days. During the 19th century Austria exercised, or tried to exercise, the right of *veto* at all the conclaves, except that which elected Leo XIII. (1878); it did so again at the conclave of 1903. On the 2nd of August Cardinal Rampolla had received twenty-nine votes, when Cardinal Kolzielsko Puzina, bishop of Cracow, declared that the Austrian government opposed the election of Cardinal Rampolla; the Sacred College considered that it ought to yield, and on the 4th of August elected Cardinal Sarto, who took the name of Pius X. By the bull *Commissum Nobis* (January 20, 1904), Pius X. suppressed all right of "veto" or "exclusion" on the part of the secular governments, and forbade, under pain of excommunication reserved to the future pope, any cardinal or conclavist to accept from his government the charge of proposing a "veto," or to exhibit it to the conclave under any form.

BIBLIOGRAPHY.—The best and most complete work is Lucius Lector, *Le Conclave, origine, histoire, organisation, législation ancienne et moderne* (Paris, 1894). See also Ferraris, *Prompta Bibliotheca, s. v. Papa*, art. i.; Moroni, *Dizionario di erudizione storico-ecclesiastica, s. v. Conclave, Conclavisti, Cella, Elezione, Esclusiva*; Bouix, *De Curia Romana*, part i. c. x.; *De Papa*, part vii. (Paris, 1859, 1870); Barbier de Montault, *Le Conclave* (Paris, 1878). On the conclave of Leo XIII., R. de Cesare, *Conclave di Leone XIII.* (Rome, 1888). On the conclave of Pius X.: an eye-witness (Card. Mathieu),

The right of veto.

The conclave at Rome.

Modern procedure.

Les Derniers Jours de Léon XIII et le conclave (Paris, 1904). See further, for the right of veto: Phillips, *Kirchenrecht*, t. v. p. 138; Sägmüller, *Die Papstwahlen und die Staate* (Tübingen, 1890); *Die Papstwahlbulen und das staatliche Recht des Exclusive* (Tübingen, 1892); Wahrmund, *Ausschliessungsrecht der katholischen Staaten* (Vienna, 1888). (A. Bo.*)

CONCORD, a township of Middlesex county, Massachusetts, U.S.A., about 20 m. N.W. of Boston. Pop. (1900) 5652; (1910, U.S. census) 6421. Area 25 sq. m. It is traversed by the Boston & Maine railway. Where the Sudbury and Assabet unite to form the beautiful little Concord river, celebrated by Thoreau, is the village of Concord, straggling, placid and beautiful, full of associations with the opening of the War of Independence and with American literature. Of particular interest is the "Old Manse," built in 1765 for Rev. William Emerson, in which his grandson R. W. Emerson wrote *Nature*, and Hawthorne his *Mosses from an Old Manse*, containing a charming description of the building and its associations. At Concord there is a state reformatory, whose inmates, about 800 in number, are employed in manufacturing various articles, but otherwise the town has only minor business and industrial interests. The introduction of the "Concord" grape, first produced here by Ephraim Bull in 1853, is said to have marked the beginning of the profitable commercial cultivation of table grapes in the United States. Concord was settled and incorporated as a township in 1635, and was (with Dedham) the first settlement in Massachusetts back from the sea-coast. A county convention at Concord village in August 1774 recommended the calling of the first Provincial Congress of Massachusetts—one of the first independent legislatures of America—which assembled here on the 11th of October 1774, and again in March and April 1775. The village became thereafter a storehouse of provisions and munitions of war, and hence became the objective of the British expedition that on the 19th of April 1775 opened with the armed conflict at Lexington (*q.v.*) the American War of Independence. As the British proceeded to Concord the whole country was rising, and at Concord about 500 minute-men confronted the British regulars who were holding the village and searching for arms and stores. Volleys were exchanged, the British retreated, the minute-men hung on their flanks and from the hillsides shot them down, driving their columns on Lexington. A granite obelisk, erected in 1837, when Emerson wrote his ode on the battle, marks the spot where the first British soldiers fell; while across the stream a fine bronze "Minute-Man" (1875) by D. C. French (a native of Concord) marks the spot where once "the embattled farmers stood and fired the shot heard round the world" (Emerson). Concord was long one of the shire-townships of Middlesex county, losing this honour in 1867. The village is famous as the home of R. W. Emerson, Nathaniel Hawthorne, Henry D. Thoreau, Louisa M. Alcott and her father, A. Bronson Alcott, who maintained here from 1879 to 1888 (in a building still standing) the Concord school of philosophy, which counted Benjamin Peirce, W. T. Harris, Mrs J. W. Howe, T. W. Higginson, Professor William James and Emerson among its lecturers. Emerson, Hawthorne, Thoreau and the Alcotts are buried here in the beautiful Sleepy Hollow Cemetery. Of the various orations (among others one by Edward Everett in 1825) that have been delivered at Concord anniversaries perhaps the finest is that of George William Curtis, delivered in 1875.

See A. S. Hudson, *The History of Concord*, vol. i. (Concord, 1904); G. B. Bartlett, *Concord: Historic, Literary and Picturesque* (Boston, 1885); and Mrs J. L. Swayne, *Story of Concord* (Boston, 1907).

CONCORD, a city and the county-seat of Cabarrus county, North Carolina, U.S.A., on the Rocky river, about 150 m. W.S.W. of Raleigh. Pop. (1890) 4339; (1900) 7910 (1789 negroes); (1910) 8715. It is served by the Southern railway. Concord is situated in a cotton-growing region, and its chief interest is in the manufacture of cotton goods. The city is the seat of Scotia seminary (for negro girls), founded in 1870 and under the care of the Presbyterian Board of Missions for Freedmen, Pittsburg, Pa. Concord was laid out in 1793 and was first incorporated in 1851.

CONCORD, the capital of New Hampshire, U.S.A., and the county-seat of Merrimack county, on both sides of the Merrimack river, about 75 m. N.W. of Boston, Massachusetts. Pop. (1890) 17,004; (1900) 19,632, of whom 3813 were foreign-born; (1910, census) 21,497. Concord is served by the Boston & Maine railway. The area of the city in 1906 was 45.16 sq. m. Concord has broad streets bordered with shade trees; and has several parks, including Penacook, White, Rollins and the Contoocook river. Among the principal buildings are the state capitol, the state library, the city hall, the county court-house, the post-office, a public library (17,000 vols.), the state hospital, the state prison, the Centennial home for the aged, the Margaret Pillsbury memorial hospital, the Rolfe and Rumford asylum for orphan girls, founded by Count Rumford's daughter, and some fine churches, including the Christian Science church built by Mrs Eddy. There are a soldiers' memorial arch, a statue of Daniel Webster by Thomas Ball, and statues of John P. Hale, John Stark, and Commodore George H. Perkins, the last by Daniel C. French; and at Penacook, 6 m. N.W. of Concord, there is a monument to Hannah Dustin (see HAVERHILL). Among the educational institutions are the well known St Paul's school for boys (Protestant Episcopal, 1853), about 2 m. W. of the city, and St Mary's school for girls (Protestant Episcopal, 1885). From 1847 to 1867 Concord was the seat of the Biblical Institute (Methodist Episcopal), founded in Newbury, Vermont, in 1841, removed to Boston as the Boston Theological Seminary in 1867, and after 1871 a part of Boston University. The city has various manufactures, including flour and grist mill products, silver ware, cotton and woollen goods, carriages, harnesses and leather belting, furniture, wooden ware, pianos and clothing; the Boston & Maine Railroad has a large repair shop in the city, and there are valuable granite quarries in the vicinity. In 1905 Concord ranked third among the cities of the state in the value of its factory products, which was \$6,387,372, being an increase of 51.7% since 1900. When first visited by the English settlers, the site of Concord was occupied by Penacook Indians; a trading post was built here about 1660. In 1725 Massachusetts granted the land in this vicinity to some of her citizens; but this grant was not recognized by New Hampshire, whose legislature issued (1727) a grant (the Township of Bow) overlapping the Massachusetts grant, which was known as Penacook or Penny-Cook. The New Hampshire grantees undertook to establish here a colony of Londonderry Irish; but the Massachusetts settlers were firmly established by the spring of 1727, Massachusetts definitely assumed jurisdiction in 1731, and in 1734 her general court incorporated the settlement under the name of Rumford. The conflicting rights of Rumford and Bow gave rise to one of the most celebrated of colonial land cases, and although the New Hampshire authorities enforced their claims of jurisdiction, the privy council in 1755 confirmed the Rumford settlers in their possession. In 1765 the name was changed to the "parish of Concord," and in 1784 the town of Concord was incorporated. Here, for some years before the War of American Independence, lived Benjamin Thompson, later Count Rumford. In 1778 and again in 1781-1782 a state constitutional convention met here; the first New Hampshire legislature met at Concord in 1782; the convention which ratified for New Hampshire the Federal Constitution met here in 1788; and in 1808 the state capital was definitely established here. The New Hampshire *Patriot*, founded here in 1808 (and for twenty years edited) by Isaac Hill (1788-1851), who was a member of the United States Senate in 1831-1836, and governor of New Hampshire in 1836-1839, became one of the leading exponents of Jacksonian Democracy in New England. In 1814 the Middlesex Canal, connecting Concord with Boston, was completed. A city charter granted by the legislature in 1849 was not accepted by the city until 1853.

See J. O. Lyford, *The History of Concord, New Hampshire* (City History Commission) (2 vols., Concord, 1903); *Concord Town Records, 1732-1820* (Concord, 1894); J. B. Moore, *Annals of Concord, 1726-1823* (Concord, 1824); and Nathaniel Bouton, *The History of Concord* (Concord, 1856).

CONCORD, BOOK OF (*Liber Concordiae*), the collective documents of the Lutheran confession, consisting of the *Articula Augustana*, the *Apologia Confessionis Augustanae*, the *Confessio Smalcaldici*, the *Catechismi Major et Minor* and the *Formula Concordiae*. This last was a formula issued on the 25th of June 1580 (the jubilee of the Augsburg Confession) by the Lutheran Church in an attempt to heal the breach which, since the death of Luther, had been widening between the extreme Lutherans and the Crypto-Calvinists. Previous attempts at concord had been made at the request of different rulers, especially by Jacob Andrea with his Swabian Concordia in 1573, and Abel Scherdinger with the Maulbronn Formula in 1575. In 1576 the elector of Saxony called a conference of theologians at Torgau to discuss these two efforts and from them produce a third. The *Book of Torgau* was evolved, circulated and criticized; a new committee, prominent on which was Martin Chemnitz, sitting at Bergen near Magdeburg, considered the criticisms and finally drew up the *Formula Concordiae*. It consists of (a) the "Epitome," (b) the "Solid Repetition and Declaration," each part comprising twelve articles; and was accepted by Saxony, Württemberg, Baden among other states, but rejected by Hesse, Nassau and Holstein. Even the free cities were divided, Hamburg and Lübeck for, Bremen and Frankfort against. Hungary and Sweden accepted it, and so finally did Denmark, where at first it was rejected, and its publication made a crime punishable by death. In spite of this very limited reception the *Formula Concordiae* has always been reckoned with the five other documents as of confessional authority.

See P. Schaff, *Creeks of Christendom*, i. 258-340, iii. 92-180.

CONCORDANCE (Late Lat. *concordantia*, harmony, from *cum*, with, and *cor*, heart), literally agreement, harmony; hence derivatively a citation of parallel passages, and specifically an alphabetical arrangement of the words contained in a book with citations of the passages in which they occur. Concordances in this last sense were first made for the Bible. Originally the word was only used in this connexion in the plural *concordantiae*, each group of parallel passages being properly a *concordantia*. The Germans distinguish between concordances of things and concordances of words, the former indexing the subject matter of a book ("real" concordance), the latter the words ("verbal" concordance).

The original impetus to the making of concordances was due to the conviction that the several parts of the Bible are consistent with each other, as parts of a divine revelation, and may be combined as harmonious elements in one system of spiritual truth. To Anthony of Padua (1195-1231) ancient tradition ascribes the first concordance, the anonymous *Concordantiae Morales*, of which the basis was the Vulgate. The first authentic work of the kind was due to Cardinal Hugh of St Cher, a Dominican monk (d. 1263), who, in preparing for a commentary on the Scriptures, found the need of a concordance, and is reported to have used for the purpose the services of five hundred of his brother monks. This concordance was the basis of two which succeeded in time and importance, one by Conrad of Halberstadt (fl. c. 1290) and the other by John of Segovia in the next century. This book was published in a greatly improved and amplified form in the middle of the 19th century by David Nutt, of London, edited by T. P. Dutripon. The first Hebrew concordance was compiled in 1437-1445 by Rabbi Isaac Nathan b. Kalonymus of Arles. It was printed at Venice in 1523 by Daniel Bomberg, in Basel in 1556, 1569 and 1581. It was published under the title *Meir Natib*, "The Light of the Way." In 1556 it was translated into Latin by Johann Reuchlin, but many errors appeared in both the Hebrew and the Latin edition. These were corrected by Marius de Calasio, a Franciscan friar, who published a four volume folio *Concordantiae Sacr. Bibl. Hebr. et Latin.* at Rome, 1621, much enlarged, with proper names included. Another concordance based on Nathan's was Johann Buxtorf the elder's *Concordantiae Bibl. Ebraicae nova et artificiosa methodo dispositae*, Basel, 1632. It marks a stage in both the arrangement and the knowledge of the roots of words, but can only be used by those who know the massoretic system, as the references are

made by Hebrew letters and relate to rabbinical divisions of the Old Testament. Calasio's concordance was republished in London under the direction of William Romaine in 1747-1749, in four volumes folio, under the patronage of all the monarchs of Europe and also of the pope. In 1754 John Taylor, D.D., a Presbyterian divine in Norwich, published in two volumes the *Hebrew Concordance adapted to the English Bible*, disposed after the manner of Buxtorf. This was the most complete and convenient concordance up to the date of its publication. In the middle of the 19th century Dr Julius Fürst issued a thoroughly revised edition of Buxtorf's concordance. The *Hebräischen und chaldäischen Concordanz zu den Heiligen Schriften Alten Testaments* (Leipzig, 1840) carried forward the development of the concordance in several directions. It gave (1) a corrected text founded on Hahn's Vanderhoogt's Bible; (2) the Rabbinical meanings; (3) explanations in Latin, and illustrations from the three Greek versions, the Aramaic paraphrase, and the Vulgate; (4) the Greek words employed by the Septuagint as renderings of the Hebrew; (5) notes on philology and archaeology, so that the concordance contained a Hebrew lexicon. An English translation by Dr Samuel Davidson was published in 1867. A revised edition of Buxtorf's work with additions from Fürst's was published by B. Bär (Stettin, 1862). A new concordance embodying the matter of all previous works with lists of proper names and particles was published by Solomon Mandelkern in Leipzig (1896); a smaller edition of the same, without quotations, appeared in 1900. There are also concordances of Biblical proper names by G. Brecher (Frankfort-on-Main, 1876) and Schusslovicz (Wilna, 1878).

A *Concordance to the Septuagint* was published at Frankfort in 1602 by Conrad Kircher of Augsburg; in this the Hebrew words are placed in alphabetical order and the Greek words by which they are translated are placed under them. A Septuagint concordance, giving the Greek words in alphabetical order, was published in 1718 in two volumes by Abraham Tromm, a learned minister at Groningen, then in the eighty-fourth year of his age. It gives the Greek words in alphabetical order; a Latin translation; the Hebrew word or words for which the Greek term is used by the Septuagint; then the places where the words occur in the order of the books and chapters; at the end of the quotations from the Septuagint places are given where the word occurs in Aquila, Symmachus and Theodotion, the other Greek translations of the O. T.; and the words of the Apocrypha follow in each case. Besides an index to the Hebrew and Chaldaic words there is another index which contains a lexicon to the *Hexapla* of Origen. In 1887 (London) appeared the *Handy Concordance of the Septuagint giving various readings from Codices Vaticanus, Alexandrinus, Sinaiticus and Ephraemi, with an appendix of words from Origen's Hexapla, not found in the above manuscripts*, by G. M., without quotations. A work of the best modern scholarship was brought out in 1897 by the Clarendon Press, Oxford, entitled *A Concordance to the Septuagint and the other Greek versions of the Old Testament including the Apocryphal Books*, by Edwin Hatch and H. A. Redpath, assisted by other scholars; this was completed in 1900 by a list of proper names.

The first Greek concordance to the New Testament was published at Basel in 1546 by Sixt Birck or Xystus Betuleius (1500-1554), a philologist and minister of the Lutheran Church. This was followed by Stephens's concordance (1594) planned by Robert Stephens and published by Henry, his son. Then in 1638 came Schmied's *ταμιείον*, which has been the basis of subsequent concordances to the New Testament. Erasmus Schmied or Schmid was a Lutheran divine who was professor of Greek in Wittenberg, where he died in 1637. Revised editions of the *ταμιείον* were published at Gotha in 1717, and at Glasgow in 1819 by the University Press. In the middle of the 19th century Charles Hermann Bruder brought out a beautiful edition (Tauchnitz) with many improvements. The *apparatus criticus* was a triumph of New Testament scholarship. It collates the readings of Erasmus, R. Stephens' third edition, the Elzevirs, Mill, Bengel, Webster, Knapp, Tittman, Scholz, Lachmann. It also

gives a selection from the most ancient patristic MSS. and from various interpreters. No various reading of critical value is omitted. An edition of Bruder with readings of Samuel Prideaux Tregelles was published in 1888 under the editorship of Westcott and Hort. The *Englishman's Greek Concordance of the New Testament*, and the *Englishman's Hebrew and Chaldean Concordance*, are books intended to put the results of the above-mentioned works at the service of those who know little Hebrew or Greek. Every word in the Bible is given in Hebrew or Greek, the word is transliterated, and then every passage in which it occurs is given—the word, however it may be translated, being italicized. They are the work of George V. Wigram assisted by W. Burgh and superintended by S. P. Tregelles, B. Davidson and W. Chalk (1843; 2nd ed. 1860). Another book which deserves mention is, *A Concordance to the Greek Testament with the English version to each word; the principal Hebrew roots corresponding to the Greek words of the Septuagint, with short critical notes and an index*, by John Williams, LL.D., Lond. 1767.

In 1884 Robert Young, author of an analytical concordance mentioned below, brought out a *Concordance to the Greek New Testament with a dictionary of Bible Words and Synonyms*: this contains a concise concordance to eight thousand changes made in the Revised Testament. Another important work of modern scholarship is the *Concordance to the Greek Testament*, edited by the Rev. W. F. Moulton and A. E. Geden, according to the texts adopted by Westcott and Hort, Tischendorf, and the English revisers.

The first concordance to the English version of the New Testament was published in London, 1535, by Thomas Gybson. It is a black-letter volume entitled *The Concordance of the New Testament most necessary to be had in the hands of all soche as delyte in the communicacion of any place contayned in ye New Testament*.

The first English concordance of the entire Bible was John Marbeck's, *A Concordance, that is to saie, a worke wherein by the order of the letters of the A.B.C. ye maie redely find any worde conteyned in the whole Bible, so often as it is there expressed or mentioncd*, Lond. 1550. Although Robert Stephens had divided the Bible into verses in 1545, Marbeck does not seem to have known this and refers to the chapters only. In 1550 also appeared Walter Lynne's translation of the concordance issued by Bullinger, Jude, Pellican and others of the Reformers. Other English concordances were published by Cotton, Newman, and in abbreviated forms by John Downham or Downame (ed. 1652), Vavasor Powell (1617-1670), Jackson and Samuel Clarke (1626-1701). In 1737 Alexander Cruden (*q.v.*), a London bookseller, born and educated in Aberdeen, published his *Complete Concordance to the Holy Scriptures of the Old and New Testament, to which is added a concordance to the books called Apocrypha*. This book embodied, was based upon and superseded all its predecessors. Though the first edition was not remunerative, three editions were published during Cruden's life, and many since his death. Cruden's work is accurate and full, and later concordances only supersede his by combining an English with a Greek and Hebrew concordance. This is done by the *Critical Greek and English Concordance* prepared by C. F. Hudson, H. A. Hastings and Ezra Abbot, LL.D., published in Boston, Mass., and by the *Critical Lexicon and Concordance to the English and Greek New Testament*, by E. L. Bullinger, 1892. The *Interpreting Concordance to the New Testament*, edited by James Gall, shows the Greek original of every word, with a glossary explaining the Greek words of the New Testament, and showing their varied renderings in the Authorized Version. The most convenient of these is *Young's Analytical Concordance*, published in Edinburgh in 1879, and since revised and reissued. It shows (1) the original Hebrew or Greek of any word in the English Bible; (2) the literal and primitive meaning of every such original word; (3) thoroughly reliable parallel passages. There is a *Students' Concordance to the Revised Version of the New Testament* showing the changes embodied in the revision, published under licence of the universities; and a concordance to the Revised Version by J. A. Thoms for the Christian Knowledge Society.

Biblical concordances having familiarized students with the value and use of such books for the systematic study of an author, the practice of making concordances has now become common. There are concordances to the works of Shakespeare, Browning and many other writers. (D. MN.)

CONCORDAT (Lat. *concordatum*, agreed upon, from *con-*, together, and *cor*, heart), a term originally denoting an agreement between ecclesiastical persons or secular persons, but later applied to a pact concluded between the ecclesiastical authority and the secular authority on ecclesiastical matters which concern both, and, more specially, to a pact concluded between the pope, as head of the Catholic Church, and a temporal sovereign for the regulation of ecclesiastical affairs in the territory of such sovereign. It is to concordats in this later sense that this article refers.

No one now questions the profound distinction that exists between the two powers, spiritual and temporal, between the church and the state. Yet these two societies are none the less in inevitable relation. The same men go to compose both; and the church, albeit pursuing a spiritual end, cannot dispense with the aid of temporal property, which in its nature depends on the organization of secular society. It follows of necessity that there are some matters which may be called "mixed," and which are the legitimate concern of the two powers, such as church property, places of worship, the appointment and the emoluments of ecclesiastical dignitaries, the temporal rights and privileges of the secular and regular clergy, the regulation of public worship, and the like. The existence of such mixed matters gives rise to inevitable conflicts of jurisdiction, which may lead, and sometimes have led, to civil war. It is, therefore, to the general interest that all these matters should be settled pacifically, by a common accord; and hence originated those conventions between the two powers which are known by the significant name of concordat, the official name being *pactum concordatum* or *solemnis conventio*. In theory these agreements may result from the spontaneous and pacific initiative of the contracting parties, but in reality their object has almost always been to terminate more or less acute conflicts and remedy more or less disturbed situations. It is for this reason that concordats always present a clearly marked character of mutual concession, each of the two powers renouncing certain of its claims in the interests of peace.

For the purposes of a concordat the state recognizes the official *status* of the church and of its ministers and tribunals; guarantees it certain privileges; and sometimes binds itself to secure for it subsidies representing compensation for past spoliation. The pope on his side grants the temporal sovereign certain rights, such as that of making or controlling the appointment of dignitaries; engages to proceed in harmony with the government in the creation of dioceses or parishes; and regularizes the situation produced by the usurpation of church property &c. The great advantage of concordats—indeed their principal utility—consists in transforming necessarily unequal unilateral claims into contractual obligations analogous to those which result from an international convention. Whatever the obligations of the state towards the ecclesiastical society may be in pure theory, in practice they become more precise and stable when they assume the nature of a bilateral convention by which the state engages itself with regard to a third party. And reciprocally, whatever may be the absolute rights of the ecclesiastical society over the appointment of its dignitaries, the administration of its property, and the government of its adherents, the exercise of these rights is limited and restricted by the stable engagements and concessions of the concordatory pact, which bind the head of the church with regard to the nations.

A concordat may assume divers forms,—historically, three. The most common in modern times is that of a diplomatic convention debated between the authorized mandatories of the high contracting parties and subsequently ratified by the latter; as, for example, the French concordat of 1801. Or, secondly, the concordat may result from two identical separate

acts, one emanating from the pope and the other from the sovereign; this was the form of the first true concordat, that of Worms, in 1122. A third form was employed in the case of the concordat of 1516 between Leo X. and Francis I. of France; a papal bull published the concordat in the form of a concession by the pope, and it was afterwards accepted and published by the king as law of the country. The shades which distinguish these three forms are not without significance, but they in no way detract from the contractual character of concordats.

Since concordats are contracts they give rise to that special mutual obligation which results from every agreement freely entered into; for a contract is binding on both parties to it. Concordats are undoubtedly conventions of a particular nature. They may make certain concessions or privileges once given without any corresponding obligation; they constitute for a given country a special ecclesiastical law; and it is thus that writers have sometimes spoken of concordats as privileges. Again, it is quite certain that the spiritual matters upon which concordats bear do not concern the two powers in the same manner and in the same degree; and in this sense concordats are not perfectly equal agreements. Finally, they do not assume the contracting parties to be totally independent, *i.e.* regard is had to the existence of anterior rights or duties. But with these reservations it must unhesitatingly be said that concordats are bilateral or synallagmatic contracts, from which results an equal mutual obligation for the two parties, who enter into a juridical engagement towards each other. Latterly certain Catholics have questioned this equality of the concordatory obligation, and have aroused keen discussion. According to Maurice de Bonald (*Deux questions sur le concordat de 1801*, Geneva, 1871), who exaggerates the view of Cardinal Tarquini (*Instit. juris publ. ecll.*, 1862 and 1868), concordats would be pure privileges granted by the pope; the pope would not be able to enter into agreements on spiritual matters or impose restraints upon the power of his successors; and consequently he would not bind himself in any juridical sense and would be able freely to revoke concordats, just as the author of a privilege can withdraw it at his pleasure. This exaggerated argument found a certain number of supporters, several of whom nevertheless sensibly weakened it. But the best canonists, from the Roman professor De Angelis (*Prael. juris canon.* i. 106) onwards, and all jurists, have victoriously refuted this theory, either by insisting on the principles common to all agreements or by citing the formal text of several concordats and papal acts, which are as explicit as possible. They have thus upheld the true contractual nature of concordats and the mutual juridical obligation which results from them.

The foregoing statements must not be taken to mean that concordats are in their nature perpetual, and that they cannot be broken or denounced. They have the perpetuity of conventions which contain no time limitation; but, like every human convention, they can be denounced, in the form in use for international treaties, and for good reasons, which are summed up in the exigencies of the general good of the country. Nevertheless, there is no example of a concordat having been denounced or broken by the popes, whereas several have been denounced or broken by the civil powers, sometimes in the least diplomatic manner, as in the case of the French concordat in 1905. The rupture of the concordat at once terminates the obligations which resulted from it on both sides; but it does not break off all relation between the church and the state, since the two societies continue to coexist on the same territory. To the situation defined by concordat, however, succeeds another situation, more or less uncertain and more or less strained, in which the two powers legislate separately on mixed matters, sometimes not without provoking conflicts.

We cannot describe in detail the objects of concordatory conventions. They bear upon very varied matters,¹ and we must confine ourselves here to a brief *résumé*. In the first place is the official recognition by the state of the Catholic religion

¹These are arranged under thirty-five distinct heads in Nussi's *Quinquaginta conventiones de rebus ecclesiasticis* (Rome, 1869).

and its ministers. Sometimes the Catholic religion is declared to be the state religion, and at least the free and public exercise of its worship is guaranteed. Several conventions guarantee the free communication of the bishops, clergy and laity with the Holy See; and this admits of the publication and execution of apostolic letters in matters spiritual. Others define those affairs of major importance which may be or must be referred to the Holy See by appeal, or the decision of which is reserved to the Holy See. On several occasions concordats have established a new division of dioceses, and provided that future erections or divisions should be made by a common accord. Analogous provisions have been made with regard to the territorial divisions within the dioceses; parishes have been recast, and the consent of the two authorities has been required for the establishment of new parishes. As regards candidates for ecclesiastical offices, the concordats concluded with Catholic nations regularly give the sovereign the right to nominate or present to bishoprics, often also to other inferior benefices, such as canonries, important parishes and abbeys; or at least the choice of the ecclesiastical authority is submitted to the approval of the civil power. In all cases canonical institution (which confers ecclesiastical jurisdiction) is reserved to the pope or the bishops. In countries where the head of the state is not a Catholic, the bishops are regularly elected by the chapters, but, the civil power has the right to strike out objectionable names from the list of candidates which is previously submitted to it. Other conventions secure the exercise of the jurisdiction of the bishops in their diocese, and determine precisely their authority over seminaries and other ecclesiastical establishments of instruction and education, as well as over public schools, so far as concerns the teaching of religion. Certain concordats deal with the orders and congregations of monks and nuns with a view to subjecting them to a certain control while securing to them the legal exercise of their activities. Ecclesiastical immunities, such as reservation of the criminal cases of the clergy, exemption from military service and other privileges, are expressly maintained in a certain number of pacts. One of the most important subjects is that of church property. An agreement is come to as to the conditions on which pious foundations are able to be made; the measure in which church property shall contribute to the public expenses is indicated; and, in the 19th century, the position of those who have acquired confiscated church property is regularized. In exchange for this surrender by the church of its ancient property the state engages to contribute to the subsistence of the ministers of public worship, or at least of certain of them.

Scholars agree in associating the earliest concordats with the celebrated contest about investitures (*q.v.*), which so profoundly agitated Christian Europe in the 11th and 12th centuries. The first in date is that which was concluded for England with Henry I. in 1107 by the efforts of St Anselm. The convention of Sutri of 1111 between Pope Paschal II. and the emperor Henry V. having been rejected, negotiations were resumed by Pope Calixtus II. and ended in the concordat of Worms (1122), which was confirmed in 1177 by the convention between Alexander III. and the emperor Frederick I. In this concordat a distinction was made between spiritual investiture, by the ring and pastoral staff, and lay or feudal investiture, by the sceptre. The emperor renounced investiture by ring and staff, and permitted canonical elections; the pope on his part recognized the king's right to perform lay investiture and to assist at elections. Analogous to this convention was the concordat concluded between Nicholas IV. and the king of Portugal in 1280.

The lengthy discussions on ecclesiastical benefices in Germany ended finally in the concordat of Vienna, promulgated by Nicholas V. in 1448. Already at the council of Constance attempts had been made to reduce the excessive papal reservations and taxes in the matter of benefices, privileges which had been established under the Avignon popes and during the Great Schism; for example, Martin V. had had to make with the different nations special arrangements which were valid for five years only, and by which he renounced the revenues of vacant benefices. The council of Basel went further: it suppressed

annates and all the benefice reservations which did not appear in the *Corpus Juris*. Eugenius IV. repudiated the Basel decrees, and the negotiations terminated in what was called the "concordat of the princes," which was accepted by Eugenius IV. on his death-bed (bulls of February 5 and 7, 1447). In February 1448 Nicholas V. concluded the arrangement, which took the name of the concordat of Vienna. This concordat, however, was not received as law of the Empire. In Germany the concessions made to the pope and the reservations maintained by him in the matter of taxes and benefices were deemed excessive, and the prolonged discontent which resulted was one of the causes of the success of the Lutheran Reformation.

In France the opposition to the papal exactions had been still more marked. In 1438 the Pragmatic Sanction of Bourges adopted and put into practice the Basel decrees, and in spite of the incessant protests of the Holy See the Pragmatic was observed throughout the 15th century, even after its nominal abolition by Louis XI. in 1461. The situation was modified by the concordat of Bologna, which was personally negotiated by Leo X. and Francis I. of France at Bologna in December 1515, inserted in the bull *Primitiva* (August 18, 1516), and promulgated as law of the realm in 1517, but not without rousing keen opposition. All bishoprics, abbeys and priories were in the royal nomination, the canonical institution belonging to the pope. The pope preserved the right to nominate to vacant benefices *in curia* and to certain benefices of the chapters, but all the others were in the nomination of the bishops or other inferior collators. However, the exercise of the pope's right of provision still left considerable scope for papal intervention, and the pope retained the annates.

In the 17th century we have only to mention the concordat between Urban VIII. and the emperor Ferdinand II. for Bohemia in 1640. In the 18th century concordats are numerous: there are two for Spain, in 1737 and 1753; two for the duchy of Milan, in 1757 and 1784; one for Poland, in 1736; five for Sardinia and Piedmont, in 1727, 1741, 1742, 1750 and 1770; and one for the kingdom of the Two Sicilies in 1741.

After the political and territorial upheavals which marked the end of the 18th century and the beginning of the 19th, all these concordats either fell to the ground or had to be recast. In the 19th century we find a long series of concordats, of which a good number are still in force. The first in date and importance is that of 1801, concluded for France between Napoleon, First Consul, and Pius VII. after laborious negotiations. Save in the provisions relating to ecclesiastical benefices, all the property of which had been confiscated, it reproduced the concordat of 1516. The pope condoned those who had acquired church property; and by way of compensation the government engaged to give the bishops and curés suitable salaries. The concordat was solemnly promulgated on Easter Day 1802, but the government had added to it unilateral provisions of Gallican tendencies, which were known as the Organic Articles. After having been the law of the Church of France for a century, it was denounced by the French government in 1905. It remains, however, partly in force for Belgium and Alsace-Lorraine, which formed part of French territory in 1801.

We conclude with a brief chronological survey of the concordats during the 19th century, some now abrogated or replaced, others maintained. It must be observed that the denunciation of a concordat by a nation does not necessarily entail the separation of the church and the state in that country or the rupture of diplomatic relations with Rome.

1803. For the Italian republic, between Napoleon and Pius VII., analogous to the French concordat; abrogated.

1813. It is impossible to designate as a concordat the concessions which were wrested by violence from Pius VII. when ill and in seclusion at Fontainebleau, and which he at once retracted.

1817. For Bavaria; still in force.

1817. New French concordat, in which Louis XVIII. endeavoured to revive the concordat of 1516; but it was not put to the vote in the chambers, and never came into force.

1817. For Piedmont, completed in 1836 and 1841; was

suppressed, like all other Italian concordats, by the formation of the kingdom of Italy.

1818. For the Two Sicilies, completed in 1834; lasted until the invasion of the kingdom of Naples by Piedmont.

1821. For Prussia; still in force.

1821. For the Rhine provinces not incorporated in Prussia, with the special object of regulating episcopal elections; concerned Württemberg, Baden, Hesse, Saxony, Nassau, Frankfurt, the Hanseatic towns, Oldenburg and Waldeck. This first concordat was immediately suspended, and was not ratified until 1827; it is partially maintained. It had to be replaced by new concordats concluded with Württemberg in 1857 and the grand-duchy of Baden in 1859; but these conventions, not having been ratified by those countries, never came into force.

1824. For the kingdom of Hanover; maintained.

1827. For Belgium and Holland; abandoned by a common accord.

1828 and 1845. For Switzerland, for the reorganization of the bishoprics of Basel and Soleure; in force.

1847. For Russia, never applied by Russia. It was followed by several partial conventions.

1851. For Tuscany; lasted until the formation of the kingdom of Italy.

1851. For Spain, completed in 1859 and 1888; in force.

A convention on the religious orders was concluded in 1904, but had not received the assent of the Senate in 1908.

1855. For Austria; denounced in 1870. Several of its provisions are maintained by unilateral Austrian laws. The emperor of Austria continues to nominate to bishoprics by virtue of rights anterior to this concordat.

1857. For Portugal, completed in 1886 for the Portuguese possessions in the Indies; in force.

1886. For Montenegro; in force.

The numerous concordats concluded towards the middle of the 19th century with several of the South American republics either have not come into force or have been denounced and replaced by a more or less pacific *modus vivendi*.

For texts see Vincenzo Nussi, *Quinquaginta conventiones de rebus ecclesiasticis* (Rome, 1869; Mainz, 1870); Branden, *Concordata inter S. Sedem et inclyatam nationem Germaniae*, &c. (undated). On the nature and obligation of concordats see Mgr. Giobbio, *I Concordati* (Monza, 1900); *idem*, *Lezioni di diplomazia ecclesiastica* (Rome, 1899-1903); Cardinal Cavagnis, *Institutiones juris publici ecclesiastici* (Rome, 1906). For the French concordats see A. Baudrillard, *Quatre cents ans de concordat* (Paris, 1905); Boulay de la Meurthe, *Documents sur la négociation du concordat et sur les autres rapports de la France avec le Saint-Siège* (Paris, 1891-1905); Cardinal Mathieu, *Le Concordat de 1801* (Paris, 1903); E. Sevestre, *Le Concordat de 1801, l'histoire, le texte, la destinée* (Paris, 1905). On the relations between the church and the state in various countries see Vering, *Kirchenrecht*, §§ 30-53. (A. Bo.*)

CONCORDIA, a Roman goddess, the personification of peace and goodwill. Several temples in her honour were erected at Rome, the most ancient being one on the Capitol, dedicated to her by Camillus (367 B.C.), subsequently restored by Livia, the wife of Augustus, and consecrated by Tiberius (A.D. 10). Other temples were frequently built to commemorate the restoration of civil harmony. Offerings were made to Concordia on the birthdays of emperors, and Concordia Augusta was worshipped as the promoter of harmony in the imperial household. Concordia was represented as a matron holding in her right hand a *patera* or an olive branch, and in her left a *cornu copiae* or a sceptre. Her symbols were two hands joined together, and two serpents entwined about a herald's staff.

CONCORDIA (mod. *Concordia Sagittaria*), an ancient town of Venetia, in Italy, 16 ft. above sea-level, 31 m. W. of Aquileia, at the junction of roads to Altinum and Patavium, to Opitergium (and thence either to Vicetia and Verona, or Feltria and Tridentum), to Noricum by the valley of the Tilaventus (Tagliamento), and to Aquileia. It was a mere village until the time of Augustus, who made it a colony. Under the later empire it was one of the most important towns of Italy; it had a strong garrison and a factory of missiles for the army. The cemetery of the garrison has been excavated since 1873, and a large number of important

inscriptions, the majority belonging to the end of the 4th and the beginning of the 5th centuries, have been discovered. It was taken and destroyed by Attila in A.D. 452. Considerable remains of the ancient town have been found—parts of the city walls, the sites of the forum and the theatre, and probably that of the arms factory. The objects found are preserved at Portogruaro, 1½ m. to the N. The see of Concordia was founded at an early period, and transferred in 1339 to Portogruaro, where it still remains. The baptistry of Concordia was probably erected in 1100.

See Ch. Hülsen in Pauly-Wissowa, *Realencyclopädie*, iv. (Stuttgart, 1901) 830.

CONCRETE (Lat. *concretus*, participle of *concrecere*, to grow together), a term used in various technical senses with the general significance of combination, conjunction, solidity. Thus the building material made up of separate substances combined into one is known as concrete (see below). In mathematics and music, the adjective has been used as synonymous with "continuous" as opposed to "discrete," i.e. "separate," "discontinuous." This antithesis is no doubt influenced by the idea that the two words derive from a common origin, whereas "discrete" is derived from the Latin *discernere*. In logic and also in common language concrete terms are those which signify persons or things as opposed to abstract terms which signify qualities, relations, attributes (so J. S. Mill). Thus the term "man" is concrete, while "manhood" and "humanity" are abstract, the names of the qualities implied. Confusions between abstract and concrete terms are frequent; thus the word "relation," which is strictly an abstract term implying connexion between two things or persons, is often used instead of the correct term "relative" for people related to one another. Concrete terms are further subdivided as Singular, the names of things regarded as individuals, and General or Common, the names which a number of things bear in common in virtue of their possession of common characteristics. These latter terms, though concrete in so far as they denote the persons or things which are known by them (see DENOTATION), have also an abstract sense when viewed connotatively, i.e. as implying the quality or qualities in isolation from the individuals. The ascription of adjectives to the class of concrete terms, upheld by J. S. Mill, has been disputed on the ground that adjectives are applied both to concrete and to abstract terms. Hence some logicians make a separate class for adjectives, as being the names neither of things nor of qualities, and describe them as Attributive terms.

CONCRETE, the name given to a building material consisting generally of a mixture of broken stone, sand and some kind of cement. To these is added water, which combining chemically with the cement conglomerates the whole mixture into a solid mass, and forms a rough but strong artificial stone. It has thus the immense advantage over natural stone that it can be easily moulded while wet to any desired shape or size. Moreover, its constituents can be obtained in almost any part of the world, and its manufacture is extremely simple. On account of these properties, builders have come to give it a distinct preference over stone, brick, timber and other building materials. So popular has it become that besides being used for massive constructions like breakwaters, dock walls, culverts, and for foundations of buildings, lighthouses and bridges, it is also proving its usefulness to the architect and engineer in many other ways. A remarkable extension of the use of concrete has been made possible by the introduction of scientific methods of combining it with steel or iron. The floors and even the walls of important buildings are made of this combination, and long span bridges, tall factory chimneys, and large water-tanks are among the many novel uses to which it has been put. Piles made of steel concrete are driven into the ground with blows that would shatter the best of timber. A fuller description of the combination of steel and concrete will be given later.

The constituents of concrete are sometimes spoken of as the *matrix* and the *aggregate*, and these terms, though somewhat old-fashioned, are convenient. The matrix is the lime or cement,

whose chemical action with the added water causes the concrete to solidify; and the aggregate is the broken stone or hard material which is embedded in the matrix. The matrix most commonly used is Portland cement, by far the best and strongest of them all. The subject of its manufacture and examination is a most important and interesting one, and the special article dealing with it should be studied (see CEMENT). Here it will only be said that before using Portland cement very careful tests should be made to ascertain its quality and condition. Moreover, it should be kept in a damp-proof store for a few weeks; and when taken out for use it should be mixed and placed in position as quickly as possible, because rain, or even moist air, spoils it by causing it to set prematurely. The oldest of all the matrices is lime, and many splendid examples of its use by the Romans still exist. It has been to a great extent superseded by Portland cement, on account of the much greater strength of the latter, though lime concrete is still used in many places for dry foundations and small structures. To be of service the lime should be what is known as "hydraulic," that is, not pure or "fat," but containing some argillaceous matter, and should be carefully slaked with water before being mixed with the aggregate. To ensure this being properly done, the lumps of lime should be broken up small, and enough water to slake them should be added, the lime then being allowed to rest for about forty-eight hours, when the water changes the particles of quicklime to hydrate of lime, and breaks up the hard lumps into a powder. The hydrated lime, after being passed through a fine screen to sort out any lumps unaffected by the water, is ready for concrete making, and if not required at once should be stored in a dry place. Other matrices are slag cement, a comparatively recent invention, and some other natural and artificial cements which find occasional advocates. Materials like tar and pitch are sometimes employed as a matrix; they are used hot and without water, the solidifying action being due to cooling and to evaporation of the mineral oils contained in them. Whatever matrix is used, it is almost invariably "diluted" with sand, the grains of which become coated with the finer particles of the matrix. The sand should be coarse-grained and hard. It should be free from dirt—that is to say, free from clay or soft mud, for instance, which prevents the cement adhering to its particles, or again from sewage matter or any substance which will chemically destroy the matrix. The grains should show no signs of decay, and by preference should be of an angular shape. The sand obtained by crushing granite and hard stones is excellent. When lime is used as a matrix, certain natural earths such as pozzuolana or trass, or, failing these, powdered bricks or tiles, may be used instead of sand with great advantage. They have the property of entering into chemical combination with the lime, forming a hard setting compound, and increasing the hardness of the resulting concrete.

The commonest aggregates are broken stone and natural flint gravel. Broken bricks or tiles and broken furnace slag are sometimes used, the essential points being that the aggregate should be hard, clean and sound. Generally speaking, broken stones will be rough and angular, whereas the stones in flint gravel will be comparatively smooth and round. It might be supposed, therefore, that the broken stone will necessarily be the better aggregate, but this does not always follow. Experience shows that, although spherical pebbles are to be avoided, Portland cement adheres tightly to smooth flint surfaces, and that rough stones often give a less compact concrete than smooth ones on account of the difficulty of bedding them into the matrix when laying the concrete. In mixing concrete there is always a tendency for the stones to separate themselves from the sand and cement, and to form "pockets" of honeycombed concrete which are neither water-tight nor strong. These are much more liable to occur when the stones are flat and angular than when they are round. Modern engineers favour the practice of having the stones of various sizes instead of being uniform, because if these sizes are wisely proportioned the whole mixture can be made more solid, and the rough "pockets" avoided. For first-class work, however, and especially in steel concrete, it is customary to reject very large

stones, and to insist that all shall pass through a ring $\frac{1}{4}$ of an inch in diameter.

The water, like all the other constituents of concrete, should be clean and free from vegetable matter. At one time sea-water was thought to be injurious, but modern investigation finds no objection to it except on the score of appearance, efflorescence being more likely to occur when it is used.

Sometimes in massive concrete structures large and heavy stones as big as a man can lift are buried in the concrete after it is laid in position but while it is still wet. The stones should be hard and clean, and care must be taken that they are completely surrounded. Such concrete is known as *rubble concrete*.

In proportioning the quantities of matrix to aggregate the ideal to be aimed at is to get a concrete in which the voids or air-spaces

shall be as small as possible; and as the lime or cement is usually by far the most expensive item, it is desirable to use as little of it as is consistent with strength.

When natural flint gravel containing both stones and sand is used, it is usual to mix so much gravel with so much lime or cement. The proportions in practice generally run from 3 to 1 for very strong work, down to 12 to 1 for unimportant work. Some engineers have the sand separated from the stones by screens or sieves and then remixed in definite proportions. When stones and sand are obtained from different sources, their relative proportions have to be decided upon. A common way of doing this is first to choose a proportion of sand to cement, which will probably vary from 1 to 1 up to 4 to 1. It then remains to determine what proportion of stones should be added. For this purpose a large can, whose volume is known, is filled loosely with stones, and the volume of the voids between them is determined by measuring how much water the can will hold in addition to the stones. It is then assumed that the quantity of sand and cement should be equal to the voids. Moreover, the volume of sand and cement together is generally assumed to be equal to that of the sand alone, as the cement to a large extent fills up voids in the sand. For example, suppose it is resolved to use 2 parts of sand to 1 of cement, and suppose that experiment shows that in a pailful of stones two-fifths of the volume consists of voids, then 2 parts of sand (or sand with cement) will fill voids in 5 parts of stones, and the proportion of cement, sand, stones becomes 1:2:5. There are several weak points in this reasoning, and a more accurate way of determining the best proportions is to try different mixtures of cement, stones and sand, filling them into different pails of the same size, and then ascertaining, by weighing the pails, which mixture is the densest.

In determining the amount of water to be added, several things must be considered. The amount required to combine chemically with the cement is about 16% by weight, but in practice much more than this is used because of loss by evaporation, and the difficulty of ensuring that the water shall be uniformly distributed. If the situation is cool, the stone hard, and the concrete carefully rammed directly it is laid down and kept moist with damp cloths, only just sufficient to moisten the whole mass is required. On the other hand, water should be given generously in hot weather, also when absorbent stone is used or when the concrete is not rammed. In these cases the concrete should be allowed to take all it can, but an excess of water which would flow away, carrying the cement with it, should be avoided.

The thorough mixing of the constituents is a most important item in the production of good concrete. Its object is to distribute all the materials evenly throughout the mass, and it is performed in many different ways, both by hand and by machine. The relative values of hand and machine work are often discussed. Roughly it may be said that where a large mass of concrete is to be mixed at one or two places a good machine will be of great advantage. On the other hand, where the mixing platform has to be constantly shifted, hand mixing is the more convenient way. In hand mixing it is usual to measure out from gauge boxes the sand, stones and cement or lime in a heap on a wooden platform. Then they are turned once or twice in their dry state by men with shovels. Next water is carefully added, and the mixture again turned, when

it is ready for depositing. For important work and especially for thin structures the number of turnings should be increased. Many types of mixing machines are obtainable; the favourite type is one in which the materials are placed in a large iron box which is made to rotate, thus tumbling the matrix and aggregate over each other again and again. Another simple apparatus is a large vertical pipe or shoot in which sloping baffle plates or shelves are placed at intervals. The materials are fed in at the top of the shoot and fall from shelf to shelf, the mixing being effected by the various shocks thus given. When mixed the concrete is carried at once to the position required, and if the matrix is quick-setting Portland cement this operation must not be delayed.

One of the few drawbacks of concrete is that, unlike brickwork or masonry, it has nearly always to be deposited within moulds or framing which give it the required shape, and which are removed after it is set. Indeed, the trouble and expense of these moulds sometimes prohibit its use. It is essential that they shall be strong and stiff, so as not to yield at all from the pressure of the wet concrete. The moulds for the face of a wall consist generally of wooden shutters, leaning against upright timbers which are secured by horizontal or raking struts to firm ground, or to anything that will bear the weight. If a smooth and neat face is wanted other precautions must be taken. The shutters must be planed, and coated with a mixture of soap and oil, so as to come away easily after the concrete is set. Moreover, when depositing the concrete, a shovel or other tool must be worked between the wet concrete and the shutter. This draws sand and water to the face and prevents the rough stones from showing themselves. Sometimes rough concrete is rendered over with a plaster of cement and sand after the shutters have been removed, but this is liable to peel off and should be avoided.

The method of depositing depends on the situation. If for important walls, or for small scantlings such as steel concrete generally involves, the concrete should be deposited in quite small quantities and very carefully rammed into position. If for massive walls, it is usual to tip it out in large quantities from a barrow or wagon, and simply spread it in layers about a foot thick. Depositing concrete under water for breakwaters and bridge foundations requires special skill and special appliances. It is usually done in one of three ways:—(a) By moulding the concrete ashore into large blocks, which, when sufficiently hard, are lowered through the water into position by a crane or similar machine with the aid of divers. The most notable instance of this type of construction was at the port of Dublin, where Mr B. B. Stoney made blocks no less than 350 tons in weight. Each block formed a piece of the quay wall 12 ft. long and 27 ft. high, being made on shore and then deposited in position by floating sheers of special design. (b) By moulding the concrete into what are called "bag-blocks." In this system the concrete is filled into bags, which are at once lowered through the water like the blocks. But in this case the concrete being still wet can adapt itself more or less to the shape of the adjoining bags, and strong rough walls can be built in this way. Sometimes the bags are made of enormous size, as at Aberdeen breakwater, where the contents of each bag weighed 50 tons. The canvas was laid in a hopper barge and there filled with the concrete and sewn up. The enormous bag was then dropped through a door in the bottom of the barge upon the breakwater foundation. (c) By depositing the wet concrete through the water between temporary upright timber frames which form the two faces of the wall. In this case very great care has to be taken to prevent the cement from being washed away from the other constituents when passing through the water. Indeed, this is bound to happen more or less, but it is guarded against by lowering the concrete slowly in a special box, the bottom of which is opened as it reaches the ground on which the concrete is to be laid. This method can only be carried out in still water, and where strong and tight framing can be built which will prevent the concrete from escaping. For small work the box can be replaced by a

Proper-
tions.

Moulds.

Deposit-
ing.

canvas bag secured by a special tripping noose which can be loosened when the bag has reached the ground. The concrete escapes from the bag, which is then drawn up and refilled.

Concrete may be compared with other building materials like masonry or timber from various points of view, such as **Strength.** strength, durability, convenience of building, fire-resistance, appearance and cost. Its strength varies within very wide limits according to the quality and proportions of the constituents, and the skill shown in mixing and placing them. To give a rough idea, however, it may be said that its safe crushing load would be about $\frac{1}{2}$ cwt. per sq. in. for lime concrete, and 1 to 5 cwt. for Portland cement concrete. The safe tensile strength of Portland cement concrete would be something like one-tenth of its compressive strength, and might be far less. On this account it is usual to neglect the tensile strength of concrete in designing structures, and to arrange the material in such a way that tensile stresses are avoided. Hence slabs or beams of long span should not be built of plain concrete, though when reinforced with steel it is admirably adapted for these purposes.

In regard to durability good Portland cement concrete is one of the most durable materials known. Neither hot, cold, nor wet weather has practically any effect whatever upon it. Frost will not injure it after it has once set, though it is essential to guard it from frost during the operations of mixing and depositing. The same praise cannot, however, be given to lime concrete. Even though the best hydraulic lime be used it is wise to confine it to places where it is not exposed to the air, or to running water, and indeed for important structures the use of lime should be avoided. Good Portland cement is so much stronger than any lime that there are few situations where it is not cheaper as well as better to use the former, because, although cement is the more expensive matrix, a smaller proportion of it will suffice for use. Lime should never be used in work exposed to sea-water, or to water containing chemicals of any kind. Portland cement concrete, on the other hand, may be used without fear in sea-water, provided that certain reasonable precautions are taken. Considerable alarm was created about the year 1837 by the failure of two or three large structures of Portland cement concrete exposed to sea-water, both in England and other countries. The matter was carefully investigated, and it was found that the sulphate of magnesia in the sea-water has a decomposing action on Portland cements, especially those which contain a large proportion of lime or even of alumina. Indeed, no Portland cement is free from the liability to be decomposed by sea-water, and on a moderate scale this action is always going on more or less. But to ensure the permanence of structures in sea-water the great object is to choose a cement containing as little lime and alumina as possible, and free from sulphates such as gypsum; and more important still to proportion the sand and stones in the concrete in such a way that the structure is practically non-porous. If this is done there is really nothing to fear. On the other hand, if the concrete is rough and porous the sea-water will gradually eat into the heart of the structure, especially in a case like a dam, where the water, being higher on one side than the other, constantly forces its way through the rough material, and decomposes the Portland cement it contains.

As regards its convenience for building purposes it may be said roughly that in "mass" work concrete is vastly more convenient than any other material. But concrete is hampered by the fact that the surface always has to be formed by means of wooden or other framing, and in the case of thin walls or floors this framing becomes a serious item, involving expense and delay. In appearance concrete can rarely if ever rival stone or brickwork. It is true that it can be moulded to any desired shape, but mouldings in concrete generally give the appearance of being unsatisfactory imitations of stone. Moreover, its colour is not pleasing. These defects will no doubt be overcome as concrete grows in popularity as a building material and its aesthetic treatment is better understood. Concrete pavings are being used in buildings of

first importance, the aggregate being very carefully selected, and in many cases the whole mixture coloured by the use of pigments. Care must be taken in their selection, however, as certain colouring matters such as red lead are destructive to the cement. One of the great objections to the appearance of concrete is the fact that soon after its erection irregular cracks invariably appear on its surface. These cracks are probably due to shrinkage while setting, aggravated by changes in temperature. They occur no less in structures of masonry and brickwork, but in these cases they generally follow the joints, and are almost imperceptible. In the case of a smooth concrete face there are no joints to follow, and the cracks become an ugly feature. They are sometimes regulated by forming artificial "joints" in the structure by embedding strips of wood or sheet iron at regular intervals, thus forming "lines of weakness," at which the cracks therefore take place. A pleasing "rough" appearance can be given to concrete by brushing it over soon after it has set with a stiff brush dipped in water or dilute acid. Or, if hard, its surface can be picked all over with a bush hammer.

At one time Portland cement concrete was considered to be lacking in fireproof qualities, but now it is regarded as one of the best fire-resisting materials known. Although experiments on this matter are badly needed, there is little doubt that good steel concrete is very nearly indestructible by fire. The matrix should be Portland cement, and the nature of the aggregate is important. Cinders have been and are still much favoured for this purpose. The reason for this preference lies in the fact that being porous and full of air, they are a good non-conductor. But they are weak, and modern experience goes to show that a strong concrete is the best, and that probably materials like broken clamp bricks or burnt clay, which are porous and yet strong, are far better than cinders as a fireproof aggregate. Limestone should be avoided, as it soon splits under heat. The steel reinforcement is of immense importance in fireproof work, because, if properly designed, it enables the concrete to hold together and do its work even when it has been cracked by fire and water. On the other hand, the concrete, being a non-conductor, preserves the steel from being softened and twisted by excessive temperature.

Only very general remarks can be made on the subject of cost, as this item varies greatly in different situations and with the market price of the materials used. But in England it may be said that for massive work such as big walls and foundations concrete is nearly always cheaper than brickwork or masonry. On the other hand, for reasons already given, thin walls, such as house walls, will cost more in concrete. Steel concrete is even more difficult to generalize about, as its use is comparatively new, but even in the matter of first cost it is proving a serious rival to timber and to plate steel work, in floors, bridges and tanks, and to brickwork and plain concrete in structures such as culverts and retaining walls, towers and domes.

Artificial Stones.—There are many varieties of concrete known as "artificial stones" which can now be bought ready moulded into the form of paving slabs, wall blocks and pipes: they are both pleasing in appearance and very durable, being carefully made by skilled workmen. Granolithic, globe granite and synthetic stone are examples of these. Some, such as victoria stone, imperial stone and others, are hardened and rendered non-porous after manufacture by immersion in a solution of silicate of soda. Others, like Ford's silicate of limestone, are practically lime mortars of excellent quality, which can be carved and cut like a sandstone of fine quality.

Steel Concrete.—The introduction of steel concrete (also known as ferroconcrete, armoured concrete, or reinforced concrete) is generally attributed to Joseph Monier, a French gardener, who about the year 1868 was anxious to build some concrete water basins. In order to reduce the thickness of the walls and floor he conceived the idea of strengthening them by building in a network of iron rods. As a matter of fact other inventors were at work before Monier, but he deserves much credit for having pushed his invention with vigour, and for

Resistant to fire.

Cost.

having popularized the use of this invaluable combination. The important point of his idea was that it combined steel and concrete in such a way that the best qualities of each material were brought into play. Concrete is readily procured and

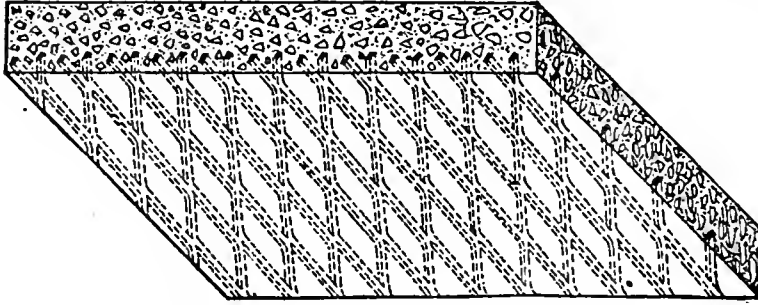
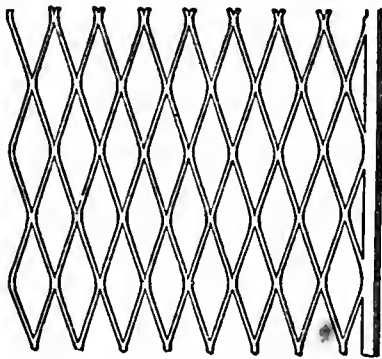

FIG. 1.—Expanded Steel Concrete Slab.

easily moulded into shape. It has considerable compressive or crushing strength, but is somewhat deficient in shearing strength, and distinctly weak in tensile or pulling strength. Steel, on the other hand, is easily procurable in simple forms such as long bars, and is exceedingly strong. But it is difficult and expensive to work up into various forms. Concrete has been avoided for making beams, slabs and thin walls, just because its deficiency in tensile strength doomed it to failure in such structures. But if a concrete slab be "reinforced" with a network of small steel rods on its under surface where the tensile stresses occur (see fig. 1) its strength will be enormously increased. Thus the one point of weakness in the concrete slab is overcome by the addition of steel in its simplest form, and both materials are used to their best advantage. The scientific and practical value of this idea was soon seized upon by various inventors and others, and the number of patented systems of combining steel with concrete is constantly increasing. Many of them are but slight modifications of the older systems, and no attempt will be made here to describe them in full. In England it is customary to allow the patentee of one or other



Expanded Metal.



Section through Intersection.

FIG. 2.

to all others. The aggregate should be the best obtainable and of different sizes, the stones being freshly crushed and screened to pass through a $\frac{3}{8}$ in. ring. Very special care should be taken so to proportion the sand as to make a perfectly impervious mixture. The proportions generally used are 4 to 1 and 5 to 1 in the case of gravel concrete, or 1:2:4 or 1:2½:6 in the case of broken stone concrete. But, generally speaking, in steel concrete the cost of the cement is but a small item of the whole expense, and it is worth while to be generous with it. If it is used in piles or structures where it is likely to be bruised the proportion of cement should be increased. The mixing and

laying should all be done very thoroughly; the concrete should be rammed in position, and any old surface of concrete which has to be covered should be cleaned and coated with fresh cement.

The reinforcement mostly consists of mild steel and sometimes of wrought iron: steel, however, is stronger and generally cheaper, so that in English practice it holds the field. It should be mild and is usually specified to have a breaking (tensile) strength of 28 to 32 tons per sq. in., with an elongation of at least 20% in 8 in. Any bar should be capable of being bent cold to the shape of the letter U without breaking it. The steel is generally used in the form of long bars of circular section. At first it was feared that such bars would have a tendency to slip through the concrete in which they were embedded, but experiments have shown that if the bar is not painted but has a natural rusty surface a very considerable adhesion between the concrete and steel—as much as 2 cwt. per sq. in. of contact surface—may be relied upon. Many devices are used, however,

to ensure the adhesion between concrete and bar being perfect. (1) In the Hennebique system of construction the bars are flattened at the end and split to form a "fish tail." (2) In the Ransome system round bars are rejected in favour of square bars, which have been twisted in a lathe in "barley

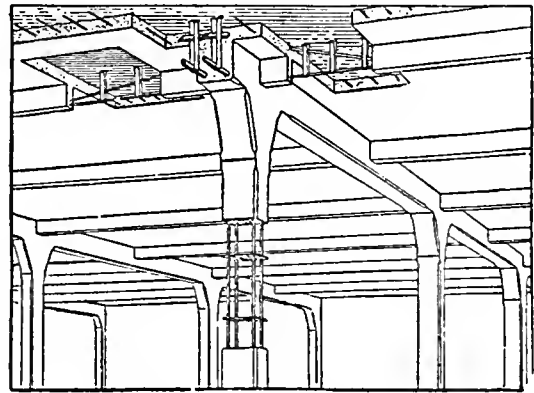

FIG. 3.—Hennebique System.

sugar" fashion. (3) In the Habrick system a flat bar similarly twisted is used. (4) In the Thacher system a flat bar with projections like rivet heads is specially rolled for this purpose. (5) In the Kahn system a square bar with "branches" is used. (6) In the "expanded metal" system no bars are used, but instead a strong steel netting is manufactured in large sheets by special machinery. It is made by cutting a series of long slots at regular intervals in a plain steel plate, which is then forcibly stretched out sideways until the slots become diamond-shaped openings, and a trellis work of steel without any joints is the result (fig. 2).

The structures in which steel concrete is used may be analysed as consisting essentially of (1) walls, (2) columns, (3) piles, (4) beams, (5) slabs, (6) arches. The designs differ considerably according to which of these purposes the structure is to fulfil.

The effect of reinforcing walls with steel is that they can be made much thinner. The steel reinforcement is generally applied in the form of vertical rods built in the wall at intervals, with lighter horizontal rods which cross the vertical ones, and thus form a network of steel which is buried in the concrete. These rods assist in taking the weight, and the whole network binds the concrete together and prevents it from cracking under a heavy load. The vertical rods should not be quite in the middle of the wall but near the inner and outer faces alternately. Care must be taken, however, that all the rods are covered by at least an

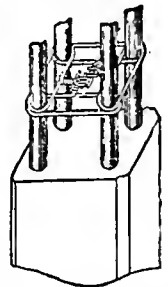

FIG. 4.
Hennebique System.

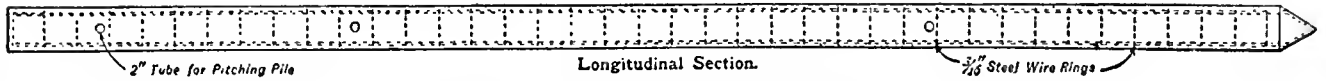

FIG. 5.—Steel and Concrete Pile (Williams System).

inch of concrete to preserve them from damage by rust or fire. In the Cottancin system the concrete is replaced by bricks pierced with holes through which the vertical rods are threaded; the horizontal tie-rods are also used, but these do not merely cross the vertical ones, but are woven in and out of them.

Columns have generally to bear a heavier weight than walls, and have to be correspondingly stronger. They have usually been made square with a vertical steel rod at each corner. To prevent these rods from spreading apart they must be tied together



FIG. 6.

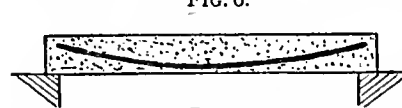

FIG. 7.

at frequent intervals. In some systems this is done by loops of stout wire connecting each rod to its neighbour, and placed one above the other about every 10 in. up the column (figs. 3 and 4). In other systems a stout wire is wound continuously in a spiral form round the four rods. Modern investigation goes to prove that the latter is theoretically the more economical way of using the steel, as the spiral binding wire acts like the binding of a wire gun, and prevents the concrete which it encloses from bursting even under very great loads.

That steel concrete can be used for piles is perhaps the most astonishing feature in this invention. The fact that a comparatively brittle material like concrete can be subjected not only to heavy loads but also



FIG. 8.



FIG. 9.

to the jar and vibration from the blows of a heavy pile ram makes it appear as if its nature and properties had been changed by the steel reinforcement. In a sense this is undoubtedly the case. A. G. Considère's experiments have shown that concrete when reinforced is capable of being stretched, without fracture, about twenty times as much as plain concrete. Most of the piles driven in Great Britain have been made on the Hennebique system with four or six longitudinal steel rods tied together by stirrups or loops at frequent intervals. Piles made on the Williams system have a steel rolled joist of I section buried in the heart of the pile, and round it a series of steel wire hoops at regular intervals (fig. 5).

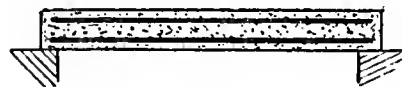

FIG. 10.

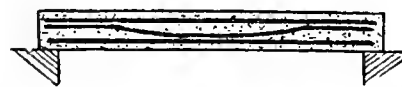

FIG. 11.

Whatever system is used, care must be taken not to batter the head of the pile to pieces with the heavy ram. To prevent this an iron "helmet" containing a lining of sawdust is fitted over the head of the pile. The sawdust adapts itself to the rough shape

of the concrete, and deadens the blow to some extent. But it is in the design of steel concrete beams that the greatest ingenuity has been shown, and almost every patentee of a "system" has some new device for arranging the steel reinforcement to the best advantage. Concrete by itself, though strong in compression, can offer but little resistance to tensile and shearing stresses, and as these stresses always occur in beams the

problem arises how best to arrange the steel so as to assist the concrete in bearing them. To meet tensile stresses the steel is nearly always inserted in the form of bars running along the beam. Figs. 6 to 9 show how they are arranged for different loading. In each case the object is to place the bars as nearly as possible where the tensile stresses occur. In cases where all the stresses are heavy, that portion of the beam which is under compression is similarly reinforced, though with smaller bars (figs. 10 and 11).

But as these tension and compression bars are generally placed near the under and upper surface of the beam they are of little use in helping to resist the shearing stresses which are greatest at its neutral axis. (See BRIDGES.) These



FIG. 12.



FIG. 13.

shearing stresses in a heavily loaded beam would cause it to split horizontally at or near the centre. To prevent this many ingenious devices have been introduced. (1) Perhaps one of the most efficient is a diagonal bracing of steel wire passing to and fro between the upper and lower bars and firmly secured to each by lapping or otherwise (fig. 12); this device is used in the Coignet and other French systems. (2) In the Hennebique system (which has found great favour in England) vertical bands or "stirrups," as they are generally called, of hoop steel are used (fig. 13). They are of U shape, and passing round the tension bars extend to the top of the beam (figs. 14 and 3). They are exceedingly thin, but being buried in concrete no danger of their perishing from rust is to be feared.

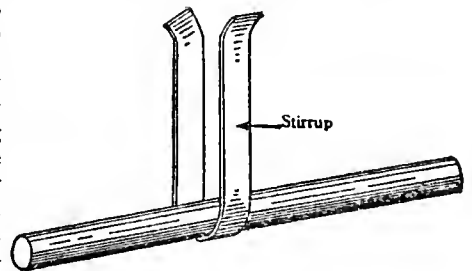

FIG. 14.—Stirrup (Hennebique System).

(3) In the Bous-siron system a similar stirrup is used, but instead of being vertical the two parts are spread so that each is slightly inclined. (4) In the Coularon system, the stirrups are inclined as in fig. 15, and consist of rods, the ends of which are hooked over the tension and compression bars. (5) In the Kahn system the stirrups are similarly arranged, but instead of being merely secured to the tension bar, they form an integral part of it like branches on a stem, the bar being rolled to a special section to admit of this. (6) In many systems such as the "expanded metal" system, the tension and compression rods together with the stirrups are all abandoned in favour of a single rolled steel joist of I section, buried in concrete (see fig. 16). Probably the weight of steel used in this way is excessive, but the joists are cheap, readily procurable and easy to handle.



FIG. 15.

Floor slabs may be regarded as wide and shallow beams, and the remarks made about the stresses in the one apply to the other also; accordingly, the various devices which are used for strengthening beams recur in the slabs. But in a thin slab, with its comparatively small span and light load, the concrete is generally strong enough to bear the shearing stresses unaided, and the reinforcement is devoted to assisting it where the tensile stresses occur. For this purpose many designers simply

use the modification of the Monier system, consisting of a horizontal network of crossed steel rods buried in the concrete. "Expanded metal" too is admirably adapted for the purpose (fig. 1). In the Matrai system thin wires are used instead of rods, and are securely fastened to rolled steel joists, which form the beams on which the slabs rest; moreover, the wires instead of being stretched tight from side to side of the slab are allowed to sag as much as the thickness of the concrete will allow. In

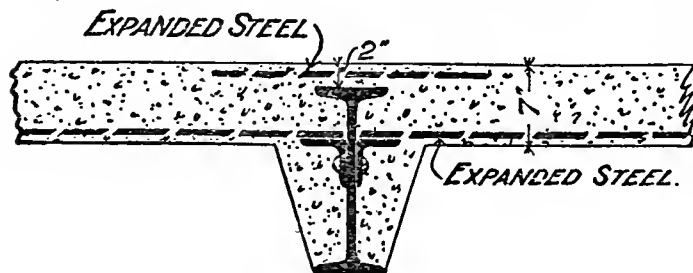

FIG. 16.

the Williams system small flat bars are used, which are not quite horizontal, but pass alternately over and under the rolled joists-which support the slabs.

A concrete *arch* is reinforced in much the same way as a wall, the stresses being somewhat similar. The reinforcing rods are generally laid both longitudinally and circumferentially. In the case of a culvert the circumferential rods are sometimes laid continuously in the form of a spiral as in the Bordenave system.

To those wishing to pursue the subject further, the following books among others may be suggested:—Sabin, *Cement and Concrete* (New York); Taylor and Thompson, *Concrete, Plain and Reinforced* (London); Sutcliffe, *Concrete, Nature and Uses* (London); Marsh and Dunn, *Reinforced Concrete* (London); Twelvetrees, *Concrete Steel* (London); Paul Christophe, *Le Béton armé* (Paris); Buel and Hill, *Reinforced Concrete Construction* (London). (F. E. W.-S.)

CONCRETION, in petrology, a name applied to nodular or irregularly shaped masses of various size occurring in a great variety of sedimentary rocks, differing in composition from the main mass of the rock, and in most cases obviously formed by some chemical process which ensued after the rock was deposited. As these bodies present so many variations in composition and in structure, it will conduce to clearness if some of the commonest be briefly adverted to. In sandstones there are often hard rounded lumps, which separate out when the rock is broken or weathered. They are mostly siliceous, but sometimes calcareous, and may differ very little in general appearance from the bulk of the sandstone. Through them the bedding passes uninterrupted, thus showing that they are not pebbles; often in their centres shells or fragments of plants are found. Argillaceous sandstones and flagstones very frequently contain "clay galls" or concretionary lumps richer in clay than the remainder of the rock. Nodules of pyrites and of marcasite are common in many clays, sandstones and marls. Their outer surfaces are tuberculate; internally they commonly have a radiate fibrous structure. Usually they are covered with a dark brown crust of limonite produced by weathering; occasionally imperfect crystalline faces may bound them. Not infrequently (e.g. in the Gault) these pyritous nodules contain altered fossils. In clays also siliceous and calcareous concretions are often found. They present an extraordinary variety of shapes, often grotesquely resembling figures of men or animals, fruits, &c., and have in many countries excited popular wonder, being regarded as of supernatural origin ("fairy-stones," &c.), and used as charms.

Another type of concretion, very abundant in many clays and shales, is the "septarian nodule." These are usually flattened disk-shaped or ovoid, often lobulate externally like the surface of a kidney. When split open they prove to be traversed by a network of cracks, which are usually filled with calcite and other minerals. These white infillings of the fissures resemble partitions; hence the name from the Latin *septum*, a partition.

Sometimes the cracks are partly empty. They vary up to half an inch in breadth, and are best seen when the nodule is cut through with a saw. These concretions may be calcareous or may consist of carbonate of iron. The former are common in some beds of the London Clay, and were formerly used for making cement. The clay-ironstone nodules or sphaerosiderites are very abundant in some Carboniferous shales, and have served in some places as iron ores. Some of the largest specimens are 3 ft. in diameter. In the centre of these nodules fossils are often found, e.g. coprolites, pieces of plants, fish teeth and scales. Phosphatic concretions are often present in certain limestones, clays, shelly sands and marls. They occur, for example, in the Cambridge Greensand, and at the base of certain of the Pliocene beds in the east of England. In many places they have been worked, under the name of "coprolite-beds," as sources of artificial manures. Bones of animals more or less completely mineralized are frequent in these phosphatic concretions, the commonest being fragments of extinct reptilia. Their presence points to a source for the phosphate of lime.

Another very important series of concretionary structures are the flint nodules which occur in chalk, and the patches and bands of chert which are found in limestones. Flints consist of dark-coloured cryptocrystalline silica. They weather grey or white by the removal of their more soluble portions by percolating water. Their shapes are exceedingly varied, and often they are studded with tubercles and nodosities. Sometimes they have internal cavities, and very frequently they contain shells of echinoderms, molluscs, &c., partly or entirely replaced by silica, but preserving their original forms. Chert occurs in bands and tabular masses rather than in nodules; it often replaces considerable portions of a bed of limestone (as in the Carboniferous Limestones of Ireland). Corals and other fossils frequently occur in chert, and when sliced and microscopically examined both flint and chert often show silicified foraminifera, polyzoa &c., and sponge spicules. Flints in chalk frequently lie along joints which may be vertical or may be nearly horizontal and parallel to the bedding. Hence they increase the stratified appearance of natural exposures of chalk.

It will be seen from the details given above that concretions may be calcareous, siliceous, argillaceous and phosphatic, and they may consist of carbonate or sulphide of iron. In the red clay of the deep sea bottom concretionary masses rich in manganese dioxide are being formed, and are sometimes brought up by the dredge. In clays large crystals of gypsum, having the shape of an arrow-head, are occasionally found in some numbers. They bear a considerable resemblance to some concretions, e.g. crystalline marcasite and pyrite nodules. These examples will indicate the great variety of substances which may give rise to concretionary structures.

Some concretions are amorphous, e.g. phosphatic nodules; others are cryptocrystalline, e.g. flint and chert; others finely crystalline, e.g. pyrites, sphaerosiderite; others consist of large crystals, e.g. gypsum, barytes, pyrites and marcasite. From this it is clear that the formation of concretions is not closely dependent on any single inorganic substance, or on any type of crystalline structure. Concretions seem to arise from the tendency of chemical compounds to be slowly dissolved by interstitial water, either while the deposit is unconsolidated or at a later period. Certain nuclei, present in the rock, then determine precipitation of these solutions, and the deposit once begun goes on till either the supply of material for growth is exhausted, or the physical character of the bed is changed by pressure and consolidation till it is no longer favourable to further accretion. The process resembles the growth of a crystal in a solution by slowly attracting to itself molecules of suitable nature from the surrounding medium. But in the majority of cases it is not the crystalline forces, or not these alone, which attract the particles. The structure of a flint, for example, shows that the material had so little tendency to crystallize that it remained permanently in cryptocrystalline or sub-crystalline state. That the concretions grew in the solid sediment is proved by the manner in which lines of bedding pass through

them and not round them. This is beautifully shown by many siliceous and calcareous nodules out of recent clays. That the sediment was in a soft condition may be inferred from the purity and perfect crystalline form of some of these bodies, e.g. gypsum, pyrites, marcasite. The crystals must have pushed aside the yielding matrix as they gradually enlarged. In deep-sea dredgings concretions of phosphate of lime and manganese dioxide are frequently brought up; this shows that concretionary action operates on the sea floor in muddy sediments, which have only recently been laid down. The phosphatic nodules seem to originate around the dead bodies of fishes, and manganese incrustations frequently enclose teeth of sharks, ear-bones of whales, &c. This recalls the occurrence of fossils in septarian nodules, flints, phosphatic concretions, &c., in the older strata. Probably the decomposing organic matter partly supplied substances for the growth of the nodules (phosphates, carbonates, &c.), partly acted as reducing agents, or otherwise determined mineral precipitation in those places where organic remains were mingled with the sediment. (J. S. F.)

CONCUBINAGE (Lat. *concubina*, a concubine; from *con-*, with, and *cupare*, to lie), the state of a man and woman cohabiting as married persons without the full sanctions of legal marriage. In early historical times, when marriage laws had scarcely advanced beyond the purely customary stage, the concubine was definitely recognized as a sort of inferior wife, differing from those of the first rank mainly by the absence of permanent guarantees. The history of Abraham's family shows us clearly that the concubine might be dismissed at any time, and her children were liable to be cast off equally summarily with gifts, in order to leave the inheritance free for the wife's sons (Genesis xxi. 9 ff., xxv. 5 ff.).

The Roman law recognized two classes of legal marriage: (1) with the definite public ceremonies of *confarratio* or *coemptio*, and (2) without any public form whatever and resting merely on the *affectio maritalis*, i.e. the fixed intention of taking a particular woman as a permanent spouse.¹ Next to these strictly lawful marriages came concubinage as a recognized legal status, so long as the two parties were not married and had no other concubines. It differed from the formless marriage in the absence (1) of *affectio maritalis*, and therefore (2) of full conjugal rights. For instance, the concubine was not raised, like the wife, to her husband's rank, nor were her children legitimate, though they enjoyed legal rights forbidden to mere bastards, e.g. the father was bound to maintain them and to leave them (in the absence of legitimate children) one-sixth of his property; moreover, they might be fully legitimated by the subsequent marriage of their parents.

In the East, the emperor Leo the Philosopher (d. 911) insisted on formal marriage as the only legal status; but in the Western Empire concubinage was still recognized even by the Christian emperors. The early Christians had naturally preferred the formless marriage of the Roman law as being free from all taint of pagan idolatry; and the ecclesiastical authorities recognized concubinage also. The first council of Toledo (398) bids the faithful restrict himself "to a single wife or concubine, as it shall please him";² and there is a similar canon of the Roman synod held by Pope Eugenius II. in 826. Even as late as the Roman councils of 1052 and 1063, the suspension from communion of laymen who had a wife and a concubine *at the same time* implies that mere concubinage was tolerated. It was also recognized by many early civil codes. In Germany "left-handed" or "morganatic" marriages were allowed by the Salic law between nobles and women of lower rank. In different states of Spain the laws of the later middle ages recognized concubinage

¹ The difference between English and Scottish law, which once made "Gretna Green marriages" so frequent, is due to the fact that Scotland adopted the Roman law (which on this particular point was followed by the whole mediæval church).

² Gratian, in the 12th century, tried to explain this away by assuming that concubinage here referred to meant a formless marriage; but in 398 a church council can scarcely so have misused the technical terms of the then current civil law (Gratian, *Decretum*, pars i. dist. xxiv. c. 4).

under the name of *barragania*, the contract being lifelong, the woman obtaining by it a right to maintenance during life, and sometimes also to part of the succession, and the sons ranking as nobles if their father was a noble. In Iceland, the concubine was recognized in addition to the lawful wife, though it was forbidden that they should dwell in the same house. The Norwegian law of the later middle ages provided definitely that in default of legitimate sons, the kingdom should descend to illegitimates. In the Danish code of Valdemar II., which was in force from 1280 to 1683, it was provided that a concubine kept openly for three years shall thereby become a legal wife; this was the custom of *hand vesten*, the "handfasting" of the English and Scottish borders, which appears in Scott's *Monastery*. In Scotland, the laws of William the Lion (d. 1214) speak of concubinage as a recognized institution; and, in the same century, the great English legist Bracton treats the "concubina legitima" as entitled to certain rights.³ There seems to have been at times a pardonable confusion between some quasi-legitimate unions and those marriages by mere word of mouth, without ecclesiastical or other ceremonies, which the church, after some natural hesitation, pronounced to be valid.⁴ Another and more serious confusion between concubinage and marriage was caused by the gradual enforcement of clerical celibacy (see CELIBACY). During the bitter conflict between laws which forbade sacerdotal marriages and long custom which had permitted them, it was natural that the legislators and the ascetic party generally should studiously speak of the priests' wives as concubines, and do all in their power to reduce them to this position. This very naturally resulted in a too frequent substitution of clerical concubinage for marriage; and the resultant evils form one of the commonest themes of complaint in church councils of the later middle ages.⁵ Concubinage in general was struck at by the concordat between the Pope Leo X. and Francis I. of France in 1516; and the council of Trent, while insisting on far more stringent conditions for lawful marriage than those which had prevailed in the middle ages, imposed at last heavy ecclesiastical penalties on concubinage and appealed to the secular arm for help against contumacious offenders (Sessio xxiv. cap. 8).

AUTHORITIES.—Besides those quoted in the notes, the reader may consult with advantage Du Cange's *Glossarium*, s.v. *Concubina*, the article "Concubnat" in Wetzer and Welte's *Kirchenlexikon* (2nd ed., Freiburg i/B., 1884), and Dr H. C. Lea's *History of Sacerdotal Celibacy* (3rd ed., London, 1907). (G. G. Co.)

CONDÉ, PRINCES OF. The French title of prince of Condé, assumed from the ancient town of Condé-sur-l'Escaut, was borne by a branch of the house of Bourbon. The first who assumed it was the famous Huguenot leader, Louis de Bourbon (see below), the fifth son of Charles de Bourbon, duke of Vendôme. His son, Henry, prince of Condé (1552–1588), also belonged to the Huguenot party. Fleeing to Germany he raised a small army with which in 1575 he joined Alençon. He became leader of the Huguenots, but after several years' fighting was taken prisoner of war. Not long after he died of poison, administered, according

³ Bracton, *De Legibus*, lib. iii. tract. ii. c. 28, § 1, and lib. iv. tract. vii. c. 8, § 4.

⁴ F. Pollock and F. W. Maitland, *Hist. of English Law*, 2nd ed. vol. ii. p. 370. In the case of Richard de Anesty, decided by papal rescript in 1143, "a marriage solemnly celebrated in church, a marriage of which a child had been born, was set aside as null in favour of an earlier marriage constituted by a mere exchange of consenting words" (*ibid.* p. 367; cf. the similar decretal of Alexander III. on p. 371). The great mediæval canon lawyer Lyndwood illustrates the difficulty of distinguishing, even as late as the middle of the 15th century, between concubinage and a clandestine, though legal, marriage. He falls back on the definition of an earlier canonist that if the woman eats out of the same dish with the man, and if he takes her to church, she may be presumed to be his wife; if, however, he sends her to draw water and dresses her in vile clothing, she is probably a concubine (*Provinciale*, ed. Oxon. 1679, p. 10, s.v. *concubinarios*).

⁵ It may be gathered from the Dominican C. L. Richard's *Analysis Conciliorum* (vol. ii., 1778) that there were more than 110 such complaints in councils and synods between the years 1009 and 1528. Dr Rashdall (*Universities of Europe in the Middle Ages*, vol. ii. p. 691, note) points out that a master of the university of Prague, in 1499, complained openly to the authorities against a bachelor for assaulting his concubine.

to the belief of his contemporaries, by his wife, Catherine de la Trémouille. This event, among others, awoke strong suspicions as to the legitimacy of his heir and namesake, Henry, prince of Condé (1588-1646). King Henry IV., however, did not take advantage of the scandal. In 1609 he caused the prince of Condé to marry Charlotte de Montmorency, whom shortly after Condé was obliged to save from the king's persistent gallantry by a hasty flight, first to Spain and then to Italy. On the death of Henry, Condé returned to France, and intrigued against the regent, Marie de' Medici; but he was seized, and imprisoned for three years (1616-1619). There was at that time before the court a plea for his divorce from his wife, but she now devoted herself to enliven his captivity at the cost of her own liberty. During the rest of his life Condé was a faithful servant of the king. He strove to blot out the memory of the Huguenot connexions of his house by affecting the greatest zeal against Protestants. His old ambition changed into a desire for the safe aggrandizement of his family, which he magnificently achieved, and with that end he bowed before Richelieu, whose niece he forced his son to marry. His son Louis, the great Condé, is separately noticed below.

The next in succession was Henry Jules, prince of Condé (1643-1709), the son of the great Condé and of Clémence de Maillé, niece of Richelieu. He fought with distinction under his father in Franche-Comté and the Low Countries; but he was heartless, avaricious and undoubtedly insane. The end of his life was marked by singular hypochondriacal fancies. He believed at one time that he was dead, and refused to eat till some of his attendants dressed in sheets set him the example. His grandson, Louis Henry, duke of Bourbon (1692-1740), Louis XV.'s minister, did not assume the title of prince of Condé which properly belonged to him.

The son of the duke of Bourbon, Louis Joseph, prince of Condé (1736-1818), after receiving a good education, distinguished himself in the Seven Years' War, and most of all by his victory at Johannisberg. As governor of Burgundy he did much to improve the industries and means of communication of that province. At the Revolution he took up arms in behalf of the king, became commander of the "army of Condé," and fought in conjunction with the Austrians till the peace of Campo Formio in 1797, being during the last year in the pay of England. He then served the emperor of Russia in Poland, and after that (1800) returned into the pay of England, and fought in Bavaria. In 1800 Condé arrived in England, where he resided for several years. On the restoration of Louis XVIII. he returned to France. He died in Paris in 1818. He wrote *Essai sur la vie du grand Condé* (1798).

LOUIS HENRY JOSEPH, duke of Bourbon (1756-1830), son of the last named, was the last prince of Condé. Several of the earlier events of his life, especially his marriage with the princess Louise of Orleans, and the duel that the comte d'Artois provoked by raising the veil of the princess at a masked ball, caused much scandal. At the Revolution he fought with the army of the *émigrés* in Liège. Between the return of Napoleon from Elba and the battle of Waterloo, he headed with no success a royalist rising in La Vendée. In 1829 he made a will by which he appointed as his heir the duc d'Aumale, and made some considerable bequests to his mistress, the baronne de Feuchères (*q.v.*). On the 27th of August 1830 he was found hanged on the fastening of his window. A crime was generally suspected, and the princes de Rohan, who were relatives of the deceased, disputed the will. Their petition, however, was dismissed by the courts.

Two cadet branches of the house of Condé played an important part: those of Soissons and Conti. The first, sprung from Charles of Bourbon (b. 1566), son of Louis I., prince of Condé, became extinct in the legitimate male line in 1641. The second took its origin from Armand of Bourbon, born in 1629, son of Henry II., prince of Condé, and survived up to 1814.

See Muret, *L'Histoire de l'armée de Condé*; Chamballand, *Vie de Louis Joseph, prince de Condé*; Créteineau-Joly, *Histoire des trois derniers princes de la maison de Condé*; and *Histoire des princes de Condé*, by the duc d'Aumale (translated by R. B. Borthwick, 1872).

CONDÉ, LOUIS DE BOURBON, PRINCE OF (1530-1569), fifth son of Charles de Bourbon, duke of Vendôme, younger brother of Antoine, king of Navarre (1518-1562), was the first of the famous house of Condé (see above). After his father's death in 1537 Louis was educated in the principles of the reformed religion. Brave though deformed, gay but extremely poor for his rank, Condé was led by his ambition to a military career. He fought with distinction in Piedmont under Marshal de Brissac; in 1552 he forced his way with reinforcements into Metz, then besieged by Charles V.; he led several brilliant sorties from that town; and in 1554 commanded the light cavalry on the Meuse against Charles. In 1557 he was present at the battle of St Quentin, and did further good service at the head of the light horse. But the descendants of the constable de Bourbon were still looked upon with suspicion in the French court, and Condé's services were ignored. The court designed to reduce his narrow means still further by despatching him upon a costly mission to Philip II. of Spain. His personal griefs thus combined with his religious views to force upon him a rôle of political opposition. He was concerned in the conspiracy of Amboise, which aimed at forcing from the king the recognition of the reformed religion. He was consequently condemned to death, and was only saved by the decease of Francis II. At the accession of the boy-king Charles IX., the policy of the court was changed, and Condé received from Catherine de' Medici the government of Picardy. But the struggle between the Catholics and the Huguenots soon began once more, and henceforward the career of Condé is the story of the wars of religion (see FRANCE: *History*). He was the military as well as the political chief of the Huguenot party, and displayed the highest generalship on many occasions, and notably at the battle of St Denis. At the battle of Jarnac, with only 400 horsemen, Condé rashly charged the whole Catholic army. Worn out with fighting, he at last gave up his sword, and a Catholic officer named Montesquiou treacherously shot him through the head on the 13th of March 1569.

CONDÉ, LOUIS II. DE BOURBON, PRINCE OF (1621-1686), called the Great Condé, was the son of Henry, prince of Condé, and Charlotte Marguerite de Montmorency, and was born at Paris on the 8th of September 1621. As a boy, under his father's careful supervision, he studied diligently at the Jesuits' College at Bourges, and at seventeen, in the absence of his father, he governed Burgundy. The duc d'Enghien, as he was styled during his father's lifetime, took part with distinction in the campaigns of 1640 and 1641 in northern France while yet under twenty years of age.

During the youth of Enghien all power in France was in the hands of Richelieu; to him even the princes of the blood had to yield; and Henry of Condé sought with the rest to win the cardinal's favour. Enghien was forced to conform. He was already deeply in love with Mlle. Marthe du Vigeon, who in return was passionately devoted to him, yet, to flatter the cardinal, he was compelled by his father, at the age of twenty, to give his hand to Richelieu's niece, Claire Clémence de Maillé-Brézé, a child of thirteen. He was present with Richelieu during the dangerous plot of Cinq Mars, and afterwards fought in the siege of Perpignan (1642).

In 1643 Enghien was appointed to command against the Spaniards in northern France. He was opposed by experienced generals, and the veterans of the Spanish army were accounted the finest soldiers in Europe; on the other hand, the strength of the French army was placed at his command, and under him were the best generals of the service. The great battle of Rocroy (May 18) put an end to the supremacy of the Spanish army and inaugurated the long period of French military predominance. Enghien himself conceived and directed the decisive attack, and at the age of twenty-two won his place amongst the great captains of modern times. After a campaign of uninterrupted success, Enghien returned to Paris in triumph, and in gallantry and intrigues strove to forget his enforced and hateful marriage. In 1644 he was sent with reinforcements into Germany to the assistance of Turenne, who was hard pressed, and took command of the whole army. The battle of Freiburg (Aug.) was

desperately contested, but in the end the French army won a great victory over the Bavarians and Imperialists commanded by Count Mercy. As after Rocroy, numerous fortresses opened their gates to the duke. The next winter Enghien spent, like every other winter during the war, amid the gaieties of Paris. The summer campaign of 1645 opened with the defeat of Turenne by Mercy, but this was retrieved in the brilliant victory of Nördlingen, in which Mercy was killed, and Enghien himself received several serious wounds. The capture of Philipsburg was the most important of his other achievements during this campaign. In 1646 Enghien served under the duke of Orleans in Flanders, and when, after the capture of Mardyck, Orleans returned to Paris, Enghien, left in command, captured Dunkirk (October 11th).

It was in this year that the old prince of Condé died. The enormous power that fell into the hands of his successor was naturally looked upon with serious alarm by the regent and her minister. Condé's birth and military renown placed him at the head of the French nobility; but, added to that, the family of which he was chief was both enormously rich and master of no small portion of France. Condé himself held Burgundy, Berry and the marches of Lorraine, as well as other less important territory; his brother Conti held Champagne, his brother-in-law, Longueville, Normandy. The government, therefore, determined to permit no increase of his already overgrown authority, and Mazarin made an attempt, which for the moment proved successful, at once to find him employment and to tarnish his fame as a general. He was sent to lead the revolted Catalans. Ill-supported, he was unable to achieve anything, and, being forced to raise the siege of Lerida, he returned home in bitter indignation. In 1648, however, he received the command in the important field of the Low Countries; and at Lens (Aug. 19th) a battle took place, which, beginning with a panic in his own regiment, was retrieved by Condé's coolness and bravery, and ended in a victory that fully restored his prestige.

In September of the same year Condé was recalled to court, for the regent Anne of Austria required his support. Influenced by the fact of his royal birth and by his arrogant scorn for the bourgeois, Condé lent himself to the court party, and finally, after much hesitation, he consented to lead the army which was to reduce Paris (Jan. 1649).

On his side, insufficient as were his forces, the war was carried on with vigour, and after several minor combats their substantial losses and a threatening of scarcity of food made the Parisians weary of the war. The political situation inclined both parties to peace, which was made at Rueil on the 20th of March (see FRONDE, THE). It was not long, however, before Condé became estranged from the court. His pride and ambition earned for him universal distrust and dislike, and the personal resentment of Anne in addition to motives of policy caused the sudden arrest of Condé, Conti and Longueville on the 18th of January 1650. But others, including Turenne and his brother the duke of Bouillon, made their escape. Vigorous attempts for the release of the princes began to be made. The women of the family were now its heroes. The dowager princess claimed from the parlement of Paris the fulfilment of the reformed law of arrest, which forbade imprisonment without trial. The duchess of Longueville entered into negotiations with Spain; and the young princess of Condé, having gathered an army around her, obtained entrance into Bordeaux and the support of the parlement of that town. She alone, among the nobles who took part in the folly of the Fronde, gains our respect and sympathy. Faithful to a faithless husband, she came forth from the retirement to which he had condemned her, and gathered an army to fight for him. But the delivery of the princes was brought about in the end by the junction of the old Fronde (the party of the parlement and of Cardinal de Retz) and the new Fronde (the party of the Condés); and Anne was at last, in February 1651, forced to liberate them from their prison at Havre. Soon afterwards, however, another shifting of parties left Condé and the new Fronde isolated. With the court and the old Fronde in alliance against him, Condé found no resource but that of making common cause with the Spaniards, who were at

war with France. The confused civil war which followed this step (Sept. 1651) was memorable chiefly for the battle of the Faubourg St Antoine, in which Condé and Turenne, two of the foremost captains of the age, measured their strength (July 2, 1652), and the army of the prince was only saved by being admitted within the gates of Paris. La Grande Made-moiselle, daughter of the duke of Orleans, persuaded the Parisians to act thus, and turned the cannon of the Bastille on Turenne's army. Thus Condé, who as usual had fought with the most desperate bravery, was saved, and Paris underwent a new investment. This ended in the flight of Condé to the Spanish army (Sept. 1652), and thenceforward, up to the peace, he was in open arms against France, and held high command in the army of Spain. But his now fully developed genius as a commander found little scope in the cumbrous and antiquated system of war practised by the Spaniards, and though he gained a few successes, and manœuvred with the highest possible skill against Turenne, his disastrous defeat at the Dunes near Dunkirk (14th of June 1658), in which an English contingent of Cromwell's veterans took part on the side of Turenne, led Spain to open negotiations for peace. After the peace of the Pyrenees in 1659, Condé obtained his pardon (January 1660) from Louis, who thought him less dangerous as a subject than as possessor of the independent sovereignty of Luxemburg, which had been offered him by Spain as a reward for his services.

Condé now realized that the period of agitation and party warfare was at an end, and he accepted, and loyally maintained henceforward, the position of a chief subordinate to a masterful sovereign. Even so, some years passed before he was recalled to active employment, and these years he spent on his estate at Chantilly. Here he gathered round him a brilliant company, which included many men of genius—Molière, Racine, Boileau, La Fontaine, Nicole, Bourdaloue and Bossuet. About this time negotiations between the Poles, Condé and Louis were carried on with a view to the election, at first of Condé's son Enghien, and afterwards of Condé himself, to the throne of Poland. These, after a long series of curious intrigues, were finally closed in 1674 by the veto of Louis XIV. and the election of John Sobieski. The prince's retirement, which was only broken by the Polish question and by his personal intercession on behalf of Fouquet in 1664, ended in 1668. In that year he proposed to Louvois, the minister of war, a plan for seizing Franche-Comté, the execution of which was entrusted to him and successfully carried out. He was now completely re-established in the favour of Louis, and with Turenne was the principal French commander in the celebrated campaign of 1672 against the Dutch. At the forcing of the Rhine passage at Tollhuis (June 12) he received a severe wound, after which he commanded in Alsace against the Imperialists. In 1673 he was again engaged in the Low Countries, and in 1674 he fought his last great battle at Seneff against the prince of Orange (afterwards William III. of England). This battle, fought on the 11th of August, was one of the hardest of the century, and Condé, who displayed the reckless bravery of his youth, had three horses killed under him. His last campaign was that of 1675 on the Rhine, where the army had been deprived of its general by the death of Turenne; and where by his careful and methodical strategy he repelled the invasion of the Imperial army of Montecucculi. After this campaign, prematurely worn out by the toils and excesses of his life, and tortured by the gout, he returned to Chantilly, where he spent the eleven years that remained to him in quiet retirement. In the end of his life he specially sought the companionship of Bourdaloue, Nicole and Bossuet, and devoted himself to religious exercises. He died on the 11th of November 1686 at the age of sixty-five. Bourdaloue attended him at his death-bed, and Bossuet pronounced his *éloge*.

The earlier political career of Condé was typical of the great French noble of his day. Success in love and war, predominant influence over his sovereign and universal homage to his own exaggerated pride, were the objects of his ambition. Even as an exile he asserted the precedence of the royal house of France over the princes of Spain and Austria, with whom he was allied for the moment. But the Condé of 1668 was no longer a politician

and a marplot; to be first in war and in gallantry was still his aim, but for the rest he was a submissive, even a subservient, minister of the royal will. It is on his military character, however, that his fame rests. This changed but little. Unlike his great rival Turenne, Condé was equally brilliant in his first battle and in his last. The one failure of his generalship was in the Spanish Fronde, and in this everything united to thwart his genius; only on the battlefield itself was his personal leadership as conspicuous as ever. That he was capable of waging a methodical war of positions may be assumed from his campaigns against Turenne and Montecucculi, the greatest generals of the predominant school. But it was in his eagerness for battle, his quick decision in action, and the stern will which sent his regiments to face the heaviest loss, that Condé is distinguished above all the generals of his time. In private life he was harsh and unamiable, seeking only the gratification of his own pleasures and desires. His enforced and loveless marriage embittered his life, and it was only in his last years, when he had done with ambition, that the more humane side of his character appeared in his devotion to literature.

Condé's unhappy wife had some years before been banished to Châteauroux. An accident brought about her ruin. Her contemporaries, greedy as they were of scandal, refused to believe any evil of her, but the prince declared himself convinced of her unfaithfulness, placed her in confinement, and carried his resentment so far that his last letter to the king was to request him never to allow her to be released.

AUTHORITIES.—See, besides the numerous *Mémoires* of the time, Puget de la Serre, *Les Sièges, les batailles, &c., de Mr. le prince de Condé* (Paris, 1651); J. de la Brune, *Histoire de la vie, &c., de Louis de Bourbon, prince de Condé* (Cologne, 1694); P. Coste, *Histoire de Louis de Bourbon, &c.* (Hague, 1748); Desormeaux, *Histoire de Louis de Bourbon, &c.* (Paris, 1768); Turpin, *Vie de Louis de Bourbon, &c.* (Paris and Amsterdam, 1767); *Éloge militaire de Louis de Bourbon* (Dijon, 1772); *Histoire du grand Condé*, by A. Lenoir (Tours, 1862); J. J. E. Roy (Lille, 1859); L. de Voivreuil (Tours, 1846); Fitzpatrick, *The Great Condé*, and Lord Mahon, *Life of Louis, prince of Condé* (London, 1845). Works on the Condé family by the prince de Condé and de Sevilinges (Paris, 1820), the duc d'Aumale, and Guibout (Rouen, 1856), should also be consulted.

CONDÉ, the name of some twenty villages in France and of two towns of some importance. Of the villages, Condé-en-Brie (Lat. *Condetum*) is a place of great antiquity and was in the middle ages the seat of a principality, a sub-fief of that of Montmirail; Condé-sur-Aisne (*Condatus*) was given in 870 by Charles the Bald to the abbey of St Ouen at Rouen, gave its name to a seigniorship during the middle ages, and possessed a priory of which the church and a 12th-century chapel remain; Condé-sur-Marne (*Condale*), once a place of some importance, preserves one of its parish churches, with a fine Romanesque tower. The two towns are:—

1. **CONDÉ-SUR-L'ESCAUT**, in the department of Nord, at the junction of the canals of the Scheldt and of Condé-Mons. Pop. (1906) town, 2701; commune, 5310. It lies 7 m. N. by E. of Valenciennes and 2 m. from the Belgian frontier. It has a church dating from the middle of the 18th century. Trade is in coal and cattle. The industries include brewing, rope-making and boat-building, and there is a communal college. Condé (*Condale*) is of considerable antiquity, dating at least from the later Roman period. Taken in 1676 by Louis XIV., it definitely passed into the possession of France by the treaty of Nijmegen two years later, and was afterwards fortified by Vauban. During the revolutionary war it was besieged and taken by the Austrians (1793); and in 1815 it again fell to the allies. It was from this place that the princes of Condé (*q.v.*) took their title. See Perron-Gelineau, *Condé ancien et moderne* (Nantes, 1887).

2. **CONDÉ-SUR-NOIREAU**, in the department of Calvados, at the confluence of the Noireau and the Drouance, 33 m. S.S.W. of Caen on the Ouest-État railway. Pop. (1906) 5709. The town is the seat of a tribunal of commerce, a board of trade-arbitration and a chamber of arts and manufactures, and has a communal college. It is important for its cotton-spinning and weaving, and carries on dyeing, printing and machine-construction; there are numerous nursery-gardens in the vicinity. Important fairs

are held in the town. The church of St Martin has a choir of the 12th and 15th centuries, and a stained-glass window (15th century) representing the Crucifixion. There is a statue to Dumont d'Urville, the navigator (b. 1790), a native of the town. Throughout the middle ages Condé (*Condatum, Condetum*) was the seat of an important castellany, which was held by a long succession of powerful nobles and kings, including Robert, count of Mortain, Henry II. and John of England, Philip Augustus of France, Charles II. (the Bad) and Charles III. of Navarre. The place was held by the English from 1417 to 1449. Of the castle some ruins of the keep survive. See L. Huet, *Hist. de Condé-sur-Noireau, ses seigneurs, son industrie, &c.* (Caen, 1883).

CONDE, JOSÉ ANTONIO (1766–1820), Spanish Orientalist, was born at Peraleja (Cuenca) on the 28th of October 1766, and was educated at the university of Alcalá. His translation of Anacreon (1791) obtained him a post in the royal library in 1795, and in 1796–1797 he published paraphrases from Theocritus, Bion, Moschus, Sappho and Meleager. These were followed by a mediocre edition of the Arabic text of Edrisi's *Description of Spain* (1799), with notes and a translation. Conde became a member of the Spanish Academy in 1802 and of the Academy of History in 1804, but his appointment as interpreter to Joseph Bonaparte led to his expulsion from both bodies in 1814. He escaped to France in February 1813, and returned to Spain in 1814, but was not allowed to reside at Madrid till 1816. Two years later he was re-elected by both academies; he died in poverty on the 12th of June 1820. His *Historia de la Dominación de los Arabes en España* was published in 1820–1821. Only the first volume was corrected by the author, the other two being compiled from his manuscript by Juan Tinco. This work was translated into German (1824–1825), French (1825) and English (1854). Conde's pretensions to scholarship have been severely criticized by Dozy, and his history is now discredited. It had, however, the merit of stimulating abler workers in the same field.

CONDENSATION OF GASES. If the volume of a gas continually decreases at a constant temperature, for which an increasing pressure is required, two cases may occur:—

(1) The volume may continue to be homogeneously filled. (2) If the substance is contained in a certain volume, and if the pressure has a certain value, the substance may divide into two different phases, each of which is again homogeneous. The value of the temperature T decides which case will occur. The temperature which is the limit above which the space will always be homogeneously filled, and below which the substance divides into two phases, is called the *critical temperature* of the substance. It differs greatly for different substances, and if we represent it by T_c , the condition for the condensation of a gas is that T must be below T_c . If the substance is divided into two phases, two different cases may occur. The denser phase may be either a liquid or a solid. The limiting temperature for these two cases, at which the division into three phases may occur, is called the *triple point*. Let us represent it by T_3 ; if the term "condensation of gases" is taken in the sense of "liquefaction of gases"—which is usually done—the condition for condensation is $T_c > T > T_3$. The opinion sometimes held that for all substances T_3 is the same fraction of T_c (the value being about $\frac{1}{2}$) has decidedly not been rigorously confirmed. Nor is this to be expected on account of the very different form of crystallization which the solid state presents. Thus for carbon dioxide, CO_2 , for which $T_c = 304^\circ$ on the absolute scale, and for which we may put $T_3 = 216^\circ$, this fraction is about 0.7; for water it descends down to 0.42, and for other substances it may be still lower.

If we confine ourselves to temperatures between T_c and T_3 , the gas will pass into a liquid if the pressure is sufficiently increased. When the formation of liquid sets in we call the gas a *saturated vapour*. If the decrease of volume is continued, the gas pressure remains constant till all the vapour has passed into liquid. The invariability of the properties of the phases is in close connexion with the invariability of the pressure (called *maximum tension*). Throughout the course of the process of condensation these properties remain unchanged, provided the temperature remain

constant; only the relative quantity of the two phases changes. Until all the gas has passed into liquid a further decrease of volume will not require increase of pressure. But as soon as the liquefaction is complete a slight decrease of volume will require a great increase of pressure, liquids being but slightly compressible.

The pressure required to condense a gas varies with the temperature, becoming higher as the temperature rises. The highest pressure will therefore be found at T_c and the lowest at T_3 . We shall represent the pressure at T_c by p_c . It is called the *critical pressure*. The pressure at T_3 we shall represent by p_3 . It is called the *pressure of the triple point*. The values of T_c and p_c for different substances will be found at the end of this article. The values of T_3 and p_3 are accurately known only for a few substances. As a rule p_3 is small, though occasionally it is greater than 1 atmosphere. This is the case with CO_2 , and we may in general expect it if the value of T_3/T_c is large. In this case there can only be a question of a real boiling-point (under the normal pressure) if the liquid can be supercooled.

We may find the value of the pressure of the saturated vapour for each T in a geometrical way by drawing in the theoretical isothermal a straight line parallel to the v -axis in such a way that $\int_{v_1}^{v_2} p dv$ will have the same value whether the straight line or the theoretical isothermal is followed. This construction, given by James Clerk Maxwell, may be considered as a result of the application of the general rules for coexisting equilibrium, which we owe to J. Willard Gibbs. The construction derived from the rules of Gibbs is as follows:—Construe the free energy at a constant temperature, *i.e.* the quantity $-fpdv$ as ordinate, if the abscissa represents v , and determine the inclination of the double tangent. Another construction derived from the rules of Gibbs might be expressed as follows:—Construe the value of $pv-fpdv$ as ordinate, the abscissa representing p , and determine the point of intersection of two of the three branches of this curve.

As an approximate half-empirical formula for the calculation of the pressure, $-\log_{10} \frac{p}{p_c} = f \left(\frac{T_c - T}{T} \right)$ may be used. It would follow from the law of corresponding states that in this formula the value of f is the same for all substances, the molecules of which do not associate to form larger molecule-complexes. In fact, for a great many substances, we find a value for f , which differs but little from 3, *e.g.* ether, carbon dioxide, benzene, benzene derivatives, ethyl chloride, ethane, &c. As the chemical structure of these substances differs greatly, and association, if it takes place, must largely depend upon the structure of the molecule, we conclude from this approximate equality that the fact of this value of f being equal to about 3 is characteristic for normal substances in which, consequently, association is excluded. Substances known to associate, such as organic acids and alcohols, have a sensibly higher value of f . Thus T. Estreicher (Cracow, 1896) calculates that for fluor-benzene f varies between 3.07 and 2.94; for ether between 3.0 and 3.1; but for water between 3.2 and 3.33, and for methyl alcohol between 3.65 and 3.84, &c. For isobutyl alcohol f even rises above 4. It is, however, remarkable that for oxygen f has been found almost invariably equal to 2.47 from K. Olszewski's observations, a value which is appreciably smaller than 3. This fact makes us again seriously doubt the correctness of the supposition that $f=3$ is a characteristic for non-association.

It is a general rule that the volume of saturated vapour decreases when the temperature is raised, while that of the coexisting liquid increases. We know only one exception to this rule, and that is the volume of water below $4^\circ C$. If we call the liquid volume v_l , and the vapour v_v , $v_v - v_l$ decreases if the temperature rises, and becomes zero at T_c . The limiting value, to which v_l and v_v converge at T_c , is called the *critical volume*, and we shall represent it by v_c . According to the law of corresponding states the values both of v_l/v_c and v_v/v_c must be the same for all substances, if T/T_c has been taken equal for them all. According to the investigations of

Sydney Young, this holds good with a high degree of approximation for a long series of substances. Important deviations from this rule for the values of v_l/v_c are only found for those substances in which the existence of association has already been discovered by other methods. Since the lowest value of T , for which investigations on v_l and v_v may be made, is the value of T_3 ; and since T_3/T_c , as has been observed above, is not the same for all substances, we cannot expect the smallest value of v_l/v_c to be the same for all substances. But for low values of T , *viz.* such as are near T_3 , the influence of the temperature on the volume is but slight, and therefore we are not far from the truth if we assume the minimum value of the ratio v_l/v_c as being identical for all normal substances, and put it at about $\frac{1}{3}$. Moreover, the influence of the polymerization (association) on the liquid volume appears to be small, so that we may even attribute the value $\frac{1}{3}$ to substances which are not normal. The value of v_v/v_c at $T=T_3$ differs widely for different substances. If we take p_3 so low that the law of Boyle-Gay Lussac may be applied, we can calculate v_v/v_c by means of the formula $\frac{p_3 v_3}{T_3} = k \frac{p_c v_c}{T_c}$, provided k be known. According to the observations of Sydney Young, this factor has proved to be 3.77 for normal substances. In consequence $\frac{v_3}{v_c} = 3.77 \frac{p_c}{p_3} \frac{T_3}{T_c}$. A similar formula, but with another value of k , may be given for associating substances, provided the saturated vapour does not contain any complex molecules. But if it does, as is the case with acetic acid, we must also know the degree of association. It can, however, only be found by measuring the volume itself.

E. Mathias has remarked that the following relation exists between the densities of the saturated vapour and of the coexisting liquid:—

$$\rho_l + \rho_v = 2\rho_c \left\{ 1 + a \left(1 - \frac{T}{T_c} \right) \right\}, \quad \text{Rule of the rectilinear diameter.}$$

and that, accordingly, the curve which represents the densities at different temperatures possesses a rectilinear diameter. According to the law of corresponding states, a would be the same for all substances. Many substances, indeed, actually appear to have a rectilinear diameter, and the value of a appears approximately to be the same. In a *Mémoire présenté à la société royale à Liège*, 15th June 1899, E. Mathias gives a list of some twenty substances for which a has a value lying between 0.95 and 1.05. It had been already observed by Sydney Young that a is not perfectly constant even for normal substances. For associating substances the diameter is not rectilinear. Whether the value of a , near 1, may serve as a characteristic for normal substances is rendered doubtful by the fact that for nitrogen a is found equal to 0.6813 and for oxygen to 0.8. At $T=T_c/2$, the formula of E. Mathias, if ρ_v be neglected with respect to ρ_l , gives the value $2+a$ for ρ_l/ρ_c .

The heat required to convert a molecular quantity of liquid coexisting with vapour into saturated vapour at the same temperature is called *molecular latent heat*. It decreases with the rise of the temperature, because at a higher temperature the liquid has already expanded, and because the vapour into which it has to be converted is denser. At the critical temperature it is equal to zero on account of the identity of the liquid and the gaseous states. If we call the molecular weight m and the latent heat per unit of weight r , then, according to the law of corresponding states, mr/T is the same for all normal substances, provided the temperatures are corresponding. According to F. T. Trouton, the value of mr/T is the same for all substances if we take for T the boiling-point. As the boiling-points under the pressure of one atmosphere are generally not equal fractions of T_c , the two theorems are not identical; but as the values of p_c for many substances do not differ so much as to make the ratios of the boiling-points under the pressure of one atmosphere differ greatly from the ratios of T_c , an approximate confirmation of the law of Trouton may be compatible with an approximate confirmation of the consequence of the law of corresponding states. If we take the term boiling-point in a more general sense, and put T in the law of

Trouton to represent the boiling-point under an arbitrary equal pressure, we may take the pressure equal to p_c for a certain substance. For this substance mr/T would be equal to zero, and the values of mr/T would no longer show a trace of equality. At present direct trustworthy investigations about the value of r for different substances are wanting; hence the question whether as to the quantity mr/T the substances are to be divided into normal and associating ones cannot be answered. Let us divide the latent heat into heat necessary for internal work and heat necessary for external work. Let r' represent the former of these two quantities, then:—

$$r = r' + p(v_c - v_l).$$

Then the same remark holds good for mr'/T as has been made for mr/T . The ratio between r and that part that is necessary for external work is given in the formula,

$$\frac{r}{p(v_c - v_l)} = \frac{T}{p} \frac{dp}{dT}.$$

By making use of the approximate formula for the vapour tension: $-\log_e \frac{p}{p_c} = f' \left(\frac{T_c - T}{T} \right)$, we find—

$$\frac{r}{p(v_c - v_l)} = f' \frac{T_c}{T}.$$

At $T = T_c$ we find for this ratio f' , a value which, for normal substances is equal to $3/0.4343 = 7$. At the critical temperature the quantities r and $v_c - v_l$ are both equal to 0, but they have a finite ratio. As we may equate $p(v_c - v_l)$ with $p v_c = RT$ at very low temperatures, we get, if we take into consideration that R expressed in calories is nearly equal to $2/m$, the value $2f'T_c = 1.4T_c$ as limiting value for mr for normal substances. This value for mr has, however, merely the character of a rough approximation—especially since the factor f is not perfectly constant.

All the phenomena which accompany the condensation of gases into liquids may be explained by the supposition, that the condition of aggregation which we call liquid differs

Nature of a liquid.

only in quantity, and not in quality, from that which we call gas. We imagine a gas to consist of separate molecules of a certain mass μ , having a certain velocity depending on the temperature. This velocity is distributed according to the law of probabilities, and furnishes a quantity of *vis viva* proportional to the temperatures. We must attribute extension to the molecules, and they will attract one another with a force which quickly decreases with the distance. Even those suppositions which reduce molecules to centres of forces, like that of Maxwell, lead us to the result that the molecules behave in mutual collisions as if they had extension—an extension which in this case is not constant, but determined by the law of repulsion in the collision, the law of the distribution, and the value of the velocities. In order to explain capillary phenomena it was assumed so early as Laplace, that between the molecules of the same substance an attraction exists which quickly decreases with the distance. That this attraction is found in gases too is proved by the fall which occurs in the temperature of a gas that is expanded without performing external work. We are still perfectly in the dark as to the cause of this attraction, and opinion differs greatly as to its dependence on the distance. Nor is this knowledge necessary in order to find the influence of the attraction, for a homogeneous state, on the value of the external pressure which is required to keep the moving molecules at a certain volume (T being given). We may, viz., assume either in the strict sense, or as a first approximation, that the influence of the attraction is quite equal to a pressure which is proportional to the square of the density. Though this molecular pressure is small for gases, yet it will be considerable for the great densities of liquids, and calculation shows that we may estimate it at more than 1000 atmos., possibly increasing up to 10,000. We may now make the same supposition for a liquid as for a gas, and imagine it to consist of molecules, which for non-associating substances are the same as those of the rarefied vapour; these, if T is the same, have the same mean *vis viva* as the vapour molecules, but are more closely massed together. Starting from this supposition and all its consequences,

van der Waals derived the following formula, which would hold both for the liquid state and for the gaseous state:—

$$\left(p + \frac{a}{v^2} \right) (v - b) = RT.$$

It follows from this deduction that for the rarefied gaseous state b would be four times the volume of the molecules, but that for greater densities the factor 4 would decrease. If we represent the volume of the molecules by β , the quantity b will be found to have the following form:—

$$b = 4\beta \left\{ 1 - \gamma_1 \left(\frac{\beta}{v} \right) + \gamma_2 \left(\frac{\beta}{v} \right)^2 \&c. \right\}$$

Only two of the successive coefficients γ_1 , γ_2 , &c., have been worked out, for the determination requires very lengthy calculations, and has not even led to definitive results (L. Boltzmann, *Proc. Royal Acad. Amsterdam*, March 1899). The latter formula supposes the molecules to be rigid spheres of invariable size. If the molecules are things which are compressible, another formula for b is found, which is different according to the number of atoms in the molecule (*Proc. Royal Acad. Amsterdam*, 1900-1901). If we keep the value of a and b constant, the given equation will not completely represent the net of isothermals of a substance. Yet even in this form it is sufficient as to the principal features. From it we may argue to the existence of a critical temperature, to a minimum value of the product $p v$, to the law of corresponding states, &c. Some of the numerical results to which it leads, however, have not been confirmed by experience. Thus it would follow from the given equation that $\frac{p_c v_c}{T_c} = \frac{3}{8} \frac{p v}{T}$ if the value of v is taken so great that the gaseous laws may be applied, whereas Sydney Young has found $1/3.77$ for a number of substances instead of the factor $3/8$. Again it follows from the given equation, that if a is thought to be independent of the temperature, $\frac{T_c}{p_c} \left(\frac{dp}{dT} \right)_c = 4$, whereas for a number

of substances a value is found for it which is near 7. If we assume with Clausius that a depends on the temperature, and has a value $a = \frac{273}{T}$, we find $\frac{T_c}{p_c} \left(\frac{dp}{dT} \right)_c = 7$.

That the accurate knowledge of the equation of state is of the highest importance is universally acknowledged, because, in connexion with the results of thermodynamics, it will enable us to explain all phenomena relating to ponderable matter. This general conviction is shown by the numerous efforts made to complete or modify the given equation, or to replace it by another, for instance, by R. Clausius, P. G. Tait, E. H. Amagat, L. Boltzmann, T. G. Jager, C. Dieterici, B. Galitzine. T. Rose Innes and M. Reinganum.

If we hold to the supposition that the molecules in the gaseous and the liquid state are the same—which we may call the supposition of the identity of the two conditions of aggregation—then the heat which is given out by the condensation at constant T is due to the potential energy lost in consequence of the coming closer of the molecules which attract each other, and then it is

equal to $a \left(\frac{1}{v_1} - \frac{1}{v_2} \right)$. If a should be a function of the temperature, it follows from thermodynamics that it would be equal to $\left(a - T \frac{da}{dT} \right) \left(\frac{1}{v_1} - \frac{1}{v_2} \right)$. Not only in the case of liquid and gas, but always when the volume is diminished, a quantity of heat is given out equal to $a \left(\frac{1}{v_1} - \frac{1}{v_2} \right)$ or $\left(a - T \frac{da}{dT} \right) \left(\frac{1}{v_1} - \frac{1}{v_2} \right)$.

If, however, when the volume is diminished at a given temperature, and also during the transition from the gaseous to the liquid state, combination into larger molecule-complexes takes place, the total internal heat may be considered as the sum of that which is caused by the combination of the molecules into greater molecule-complexes and by their approach towards each other. We have the simplest case of possible greater complexity when two molecules combine to one. From the course of the changes in the density of the vapour we assume that this occurs, e.g. with nitrogen peroxide, NO_2 , and acetic acid, and the somewhat close agreement of the

Associating substances.

observed density of the vapour with that which is calculated from the hypothesis of such an association to double-molecules, makes this supposition almost a certainty. In such cases the molecules in the much denser liquid state must therefore be considered as double-molecules, either completely so or in a variable degree depending on the temperature. The given equation of state cannot hold for such substances. Even though we assume that a and b are not modified by the formation of double-molecules, yet RT is modified, and, since it is proportional to the number of the molecules, is diminished by the combination. The laws found for normal substances will, therefore, not hold for such associating substances. Accordingly for substances for which we have already found an anomalous density of the vapour, we cannot expect the general laws for the liquid state, which have been treated above, to hold good without modification, and in many respects such substances will therefore not follow the law of corresponding states. There are, however, also substances of which the anomalous density of vapour has not been stated, and which yet cannot be ranged under this law, e.g. water and alcohols. The most natural thing, of course, is to ascribe the deviation of these substances, as of the others, to the fact that the molecules of the liquid are polymerized. In this case we have to account for the following circumstance, that whereas for NO_2 and acetic acid in the state of saturated vapour the degree of association increases if the temperature falls, the reverse must take place for water and alcohols. Such a difference may be accounted for by the difference in the quantity of heat released by the polymerization to double-molecules or larger molecule-complexes. The quantity of heat given out when two molecules fall together may be calculated for NO_2 and acetic acid from the formula of Gibbs for the density of vapour, and it proves to be very considerable. With this the following fact is closely connected. If in the p v diagram, starting from a point indicating the state of saturated vapour, a geometrical locus is drawn of the points which have the same degree of association, this curve, which passes towards isothermals of higher T if the volume diminishes, requires for the same change in T a greater diminution of volume than is indicated by the border-curve. For water and alcohols this geometrical locus will be found on the other side of the border-curve, and the polymerization heat will be small, i.e. smaller than the latent heat. For substances with a small polymerization heat the degree of association will continually decrease if we move along the border-curve on the side of the saturated vapour in the direction towards lower T . With this, it is perfectly compatible that for such substances the saturated vapour, e.g. under the pressure of one atmosphere, should show an almost normal density. Saturated vapour of water at 100° has a density which seems nearly 4% greater than the theoretical one, an amount which is greater than can be ascribed to the deviation from the gas-laws. For the relation between v , T , and x , if x represents the fraction of the number of double-molecules, the following formula has been found ("Moleculartheorie," *Zeits. Phys. Chem.*, 1890, vol. v):

$$\log \frac{x(v-b)}{(1-x)^2} = 2 \frac{E_1 - E_2}{R_1 T} + C,$$

from which

$$\frac{T}{v-b} \left(\frac{dv}{dT} \right)_x = -2 \frac{E_1 - E_2}{R_1 T^2},$$

which may elucidate what precedes.

By far the majority of substances have a value of T_c above the ordinary temperature, and diminution of volume (increase of pressure) is sufficient to condense such gaseous substances into liquids. If T_c is but little above the ordinary temperature, a great increase of pressure is in general required to effect condensation. Substances for which T_c is much higher than the ordinary temperature T_0 , e.g. $T_c > \frac{3}{2} T_0$, occur as liquids, even without increase of pressure; that is, at the pressure of one atmosphere. The value $\frac{3}{2}$ is to be considered as only a mean value, because of the inequality of p_c . The substances for which T_c is smaller than the ordinary temperature are but few in number. Taking the

temperature of melting ice as a limit, these gases are in successive order: CH_4 , NO , O_2 , CO , N_2 and H_2 (the recently discovered gases argon, helium, &c., are left out of account). If these gases are compressed at 0° centigrade they do not show a trace of liquefaction, and therefore they were long known under the name of "permanent gases." The discovery, however, of the critical temperature carried the conviction that these substances would not be "permanent gases" if they were compressed at much lower T . Hence the problem arose how "low temperatures" were to be brought about. Considered from a general point of view the means to attain this end may be described as follows: we must make use of the above-mentioned circumstance that heat disappears when a substance expands, either with or without performing external work. According as this heat is derived from the substance itself which is to be condensed, or from the substance which is used as a means of cooling, we may divide the methods for condensing the so-called permanent gases into two principal groups.

In order to use a liquid as a cooling bath it must be placed in a vacuum, and it must be possible to keep the pressure of the vapour in that space at a small value. According to the boiling-law, the temperature of the liquid must descend to that at which the maximum tension of the vapour is equal to the pressure which reigns on the surface of the liquid. If the vapour, either by means of absorption or by an air-pump, is exhausted from the space, the temperature of the liquid and that of the space itself depend upon the value of the pressure which finally prevails in the space. From a practical point of view the value of T_3 may be regarded as the limit to which the temperature falls. It is true that if the air is exhausted to the utmost possible extent, the temperature may fall still lower, but when the substance has become solid, a further diminution of the pressure in the space is of little advantage. At any rate, as a solid body evaporates only on the surface, and solid gases are bad conductors of heat, further cooling will only take place very slowly, and will scarcely neutralize the influx of heat. If the pressure p_3 is very small, it is perhaps practically impossible to reach T_3 ; if so, T_3 in the following lines will represent the temperature practically attainable. There is thus for every gas a limit below which it is not to be cooled further, at least not in this way. If, however, we can find another gas for which the critical temperature is sufficiently above T_3 of the first chosen gas, and if it is converted into a liquid by cooling with the first gas, and then treated in the same way as the first gas, it may in its turn be cooled down to $(T_3)_2$. Going on in this way, continually lower temperatures may be attained, and it would be possible to condense all gases, provided the difference of the successive critical temperatures of two gases fulfils certain conditions. If the ratio of the absolute critical temperatures for two gases, which succeed one another in the series, should be sensibly greater than 2, the value of T_3 for the first gas is not, or not sufficiently, below the T_c of the second gas. This is the case when one of the gases is nitrogen, on which hydrogen would follow as second gas. Generally, however, we shall take atmospheric air instead of nitrogen. Though this mixture of N_2 and O_2 will show other critical phenomena than a simple substance, yet we shall continue to speak of a T_c for air, which is given at -140°C ., and for which, therefore, T_c amounts to 133° absolute. The lowest T which may be expected for air in a highly rarefied space may be evaluated at 60° absolute—a value which is higher than the T_c for hydrogen. Without new contrivances it would, accordingly, not be possible to reach the critical temperature of H_2 . The method by which we try to obtain successively lower temperatures by making use of successive gases is called the "cascade method." It is not self-evident that by sufficiently diminishing the pressure on a liquid it may be cooled to such a degree that the temperature will be lowered to T_3 , if the initial temperature was equal to T_c , or but little below it, and we can even predict with certainty that this will not be the case for all substances. It is possible, too, that long before the triple point is reached the whole liquid will have evaporated. The most favourable conditions will, of

Liquids as means of cooling.

course, be attained when the influx of heat is reduced to a minimum. As a limiting case we imagine the process to be isentropic. Now the question has become, Will an isentropic line, which starts from a point of the border-curve on the side of the liquid not far from the critical-point, remain throughout its descending course in the heterogeneous region, or will it leave the region on the side of the vapour? As early as 1878 van der Waals (*Verslagen Kon. Akad. Amsterdam*) pointed out that the former may be expected to be the case only for substances for which c_p/c_v is large, and the latter for those for which it is small; in other words, the former will take place for substances the molecules of which contain few atoms, and the latter for substances the molecules of which contain many atoms. Ether is an example of the latter class, and if we say that the quantity h (specific heat of the saturated vapour) for ether is found to be positive, we state the same thing in other words. It is not necessary to prove this theorem further here, as the molecules of the gases under consideration contain only two atoms and the total evaporation of the liquid is not to be feared.

In the practical application of this cascade-method some variation is found in the gases chosen for the successive stages. Thus methyl chloride, ethylene and oxygen are used in the cryogenic laboratory of Leiden, while Sir James Dewar has used air as the last term. Carbonic acid is not to be recommended on account of the comparatively high value of T_3 . In order to prevent loss of gas a system of "circulation" is employed. This method of obtaining low temperatures is decidedly laborious, and requires very intricate apparatus, but it has the great advantage that very constant low temperatures may be obtained, and can be regulated arbitrarily within pretty wide limits.

In order to lower the temperature of a substance down to T_3 , it is not always necessary to convert it first into the liquid state by means of another substance, as was assumed in the last method for obtaining low temperatures.

Its own expansion is sufficient, provided the initial condition be properly chosen, and provided we take care, even more than in the former method, that there is no influx of heat. Those conditions being fulfilled, we may, simply by adiabatic expansion, not only lower the temperature of some substances down to T_3 , but also convert them into the liquid state. This is especially the case with substances the molecules of which contain few atoms.

Let us imagine the whole net of isothermals for homogeneous phases drawn in a $p\theta$ diagram, and in it the border-curve. Within this border-curve, as in the heterogeneous region, the theoretical part of every isothermal must be replaced by a straight line. The isothermals may therefore be divided into two groups, viz. those which keep outside the heterogeneous region, and those which cross this region. Hence an isothermal, belonging to the latter group, enters the heterogeneous region on the liquid side, and leaves it at the same level on the vapour side. Let us imagine in the same way all the isentropic curves drawn for homogeneous states. Their form resembles that of isothermals in so far as they show a maximum and a minimum, if the entropy-constant is below a certain value, while if it is above this value, both the maximum and the minimum disappear, the isentropic line in a certain point having at the same time $\frac{dp}{dv} = 0$ and $\frac{d^2p}{dv^2} = 0$ for this particular value of the constant. This point, which we might call the critical point of the isentropic lines, lies in the heterogeneous region, and therefore cannot be realized, since as soon as an isentropic curve enters this region its theoretical part will be replaced by an empiric part. If an isentropic curve crosses the heterogeneous region, the point where it enters this region must, just as for the isothermals, be connected with the point where it leaves the region by another curve. When $c_p/c_v = k$ (the limiting value of c_p/c_v for infinite rarefaction is meant) approaches unity, the isentropic curves approach the isothermals and vice versa. In the same way the critical point of the isentropic curves comes nearer to that of the isothermals. And if k is not much greater than 1, e.g. $k < 1.08$, the following property of the isothermals is also preserved, viz. that an

isentropic curve, which enters the heterogeneous region on the side of the liquid, leaves it again on the side of the vapour, not of course at the same level, but at a lower point. If, however, k is greater, and particularly if it is so great as it is with molecules of one or two atoms, an isentropic curve, which enters on the side of the liquid, however far prolonged, always remains within the heterogeneous region. But in this case all isentropic curves, if sufficiently prolonged, will enter the heterogeneous region. Every isentropic curve has one point of intersection with the border-curve, but only a small group intersect the border-curve in three points, two of which are to be found not far from the top of the border-curve and on the side of the vapour. Whether the sign of h (specific heat of the saturated vapour) is negative or positive, is closely connected with the preceding facts. For substances having h great, h will be negative if T is low, positive if T rises, while it will change its sign again before T_c is reached. The values of T , at which change of sign takes place, depend on k . The law of corresponding states holds good for this value of T for all substances which have the same value of k .

Now the gases which were considered as permanent are exactly those for which k has a high value. From this it would follow that every adiabatic expansion, provided it be sufficiently continued, will bring such substances into the heterogeneous region, i.e. they can be condensed by adiabatic expansion. But since the final pressure must not fall below a certain limit, determined by experimental convenience, and since the quantity which passes into the liquid state must remain a fraction as large as possible, and since the expansion never can take place in such a manner that no heat is given out by the walls or the surroundings, it is best to choose the initial condition in such a way that the isentropic curve of this point cuts the border-curve in a point on the side of the liquid, lying as low as possible. The border-curve being rather broad at the top, there are many isentropic curves which penetrate the heterogeneous region under a pressure which differs but little from p_c . Availing himself of this property, K. Olszewski has determined p_c for hydrogen at 15 atmospheres. Isentropic curves, which lie on the right and on the left of this group, will show a point of condensation at a lower pressure. Olszewski has investigated this for those lying on the right, but not for those on the left.

From the equation of state $(p + \frac{a}{v^2})(v - b) = RT$, the equation of the isentropic curve follows as $(p + \frac{a}{v^2})(v - b)^k = C$, and from this we may deduce $T(v - b)^{k-1} = C'$. This latter relation shows in how high a degree the cooling depends on the amount by which k surpasses unity, the change in $v - b$ being the same.

What has been said concerning the relative position of the border-curve and the isentropic curve may be easily tested for points of the border-curve which represent rarefied gaseous states, in the following way. Following the border-curve we found before $f \frac{T_c}{T}$ for the value of $\frac{T dp}{p dT}$. Following the isentropic curve the value of $\frac{T dp}{p dT}$ is equal to $\frac{k}{k-1}$. If $\frac{k}{k-1} < f \frac{T_c}{T}$, the isentropic curve rises more steeply than the border-curve. If we take $f = 7$ and choose the value of $T_c/2$ for T —a temperature at which the saturated vapour may be considered to follow the gas-laws—then $k/(k-1) = 14$, or $k = 1.07$ would be the limiting value for the two cases. At any rate $k = 1.41$ is great enough to fulfil the condition, even for other values of T . Cailletet and Pictet have availed themselves of this adiabatic expansion for condensing some permanent gases, and it must also be used when, in the cascade method, T_3 of one of the gases lies above T_c of the next.

A third method of condensing the permanent gases is applied in C. P. G. Linde's apparatus for liquefying air. Under a high pressure p_1 a current of gas is conducted through a narrow spiral, returning through another spiral which surrounds the first. Between the end of the first spiral and the beginning of the second the current of gas is reduced to a much lower pressure p_2 by passing through a tap with a fine

Linde's
apparatus.

orifice. On account of the expansion resulting from this sudden decrease of pressure, the temperature of the gas, and consequently of the two spirals, falls sensibly. If this process is repeated with another current of gas, this current, having been cooled in the inner spiral, will be cooled still further, and the temperature of the two spirals will become still lower. If the pressures p_1 and p_2 remain constant the cooling will increase with the lowering of the temperature. In Linde's apparatus this cycle is repeated over and over again, and after some time (about two or three hours) it becomes possible to draw off liquid air.

The cooling which is the consequence of such a decrease of pressure was experimentally determined in 1854 by Lord Kelvin (then Professor W. Thomson) and Joule, who represent the result of their experiments in the formula

$$T_1 - T_2 = \gamma \frac{p_1 - p_2}{T_2}$$

In their experiments p_2 was always 1 atmosphere, and the amount of p_1 was not large. It would, therefore, be certainly wrong, even though for a small difference in pressure the empiric formula might be approximately correct, without closer investigation to make use of it for the differences of pressure used in Linde's apparatus, where $p_1 = 200$ and $p_2 = 18$ atmospheres. For the existence of a most favourable value of p_1 is in contradiction with the formula, since it would follow from it that $T_1 - T_2$ would always increase with the increase of p_1 . Nor would it be right to regard as the cause for the existence of this most favourable value of p_1 the fact that the heat produced in the compression of the expanded gas, and therefore p_1/p_2 , must be kept as small as possible, for the simple reason that the heat is produced in quite another part of the apparatus, and might be neutralized in different ways.

Closer examination of the process shows that if p_2 is given, a most favourable value of p_1 must exist for the cooling itself. If p_1 is taken still higher, the cooling decreases again, and we might take a value for p_1 for which the cooling would be zero, or even negative.

If we call the energy per unit of weight ϵ and the specific volume v , the following equation holds:—

$$\epsilon_1 + p_1 v_1 - p_2 v_2 = \epsilon_2, \\ \epsilon_1 + p_1 v_1 = \epsilon_2 + p_2 v_2.$$

According to the symbols chosen by Gibbs, $\chi_1 = \chi_2$. As χ_1 is determined by T_1 and p_1 , and χ_2 by T_2 and p_2 , we obtain, if we take T_1 and p_2 as being constant,

$$\left(\frac{\delta \chi_1}{\delta p_1}\right)_{T_1} dp_1 = \left(\frac{\delta \chi_2}{\delta T_2}\right)_{p_2} dT_2.$$

If T_2 is to have a minimum value, we have

$$\left(\frac{\delta \chi_1}{\delta p_1}\right)_{T_1} = 0, \text{ or } \left(\frac{\delta \chi_1}{\delta v_1}\right)_{T_1} = 0.$$

From this follows

$$\left(\frac{\delta \epsilon_1}{\delta v_1}\right)_{T_1} + \left[\frac{\delta(p_1 v_1)}{\delta v_1}\right]_{T_1} = 0.$$

As $\left(\frac{\delta \epsilon_1}{\delta v_1}\right)_{T_1}$ is positive, we shall have to take for the maximum cooling such a pressure that the product $p v$ decreases with v , viz. a pressure larger than that at which $p v$ has the minimum value. By means of the equation of state mentioned already, we find for the value of the specific volume that gives the greatest cooling the formula

$$\frac{RT_1 b}{(v_1 - b)^2} = \frac{2a}{v_1^2}$$

and for the value of the pressure

$$p_1 = 27 p_c \left[1 - \sqrt{\frac{4 T_1}{27 T_c}} \right] \left[3 \sqrt{\frac{4 T_1}{27 T_c}} - 1 \right]$$

If we take the value $2T_c$ for T_1 , as we may approximately for air when we begin to work with the apparatus, we find for p_1 about $8p_c$, or more than 300 atmospheres. If we take $T_1 = T_c$, as we may at the end of the process, we find $p_1 = 2.5p_c$, or 100 atmospheres. The constant pressure which has been found the most favourable in Linde's apparatus is a mean of the two calculated pressures. In a theoretically perfect apparatus we ought, therefore, to be able to regulate p_1 according to the temperature in the inner spiral.

The critical temperatures and pressures of the permanent

gases are given in the following table, the former being expressed on the absolute scale and the latter in atmospheres:—

	T_c	p_c		T_c	p_c
CH ₄	191.2°	55	CO	133.5°	35.5
NO	179.5°	71.2	N ₂	127°	35
O ₂	155°	50	Air	133°	39
Argon	152°	50.6	H ₂	32°	15

The values of T_c and p_c for hydrogen are those of Dewar. They are in approximate accordance with those given by K. Olszewski. Liquid hydrogen was first collected by J. Dewar in 1898. Apparatus for obtaining moderate and small quantities have been described by M. W. Travers and K. Olszewski. H. Kammerlingh Onnes at Leiden has brought about a circulation yielding more than 3 litres per hour, and has made use of it to keep baths of 1.5 litre capacity at all temperatures between 20.2° and 13.7° absolute, the temperatures remaining constant within 0.01°. (See also LIQUID GASES.) (J. D. v. D. W.)

CONDENSER, the name given to many forms of apparatus which have for their object the concentration of matter, or bringing it into a smaller volume, or the intensification of energy. In chemistry the word is applied to an apparatus which cools down, or condenses, a vapour to a liquid; reference should be made to the article DISTILLATION for the various types in use, and also to GAS (*Gas Manufacture*) and COAL TAR; the device for the condensation of the exhaust steam of a steam-engine is treated in the article STEAM-ENGINE. In woollen manufactures, "condensation" of the wool is an important operation and is accomplished by means of a "condenser." The term is also given—generally as a qualification, e.g. condensing-syringe, condensing-pump,—to apparatus by which air or a vapour may be compressed. In optics a "condenser" is a lens, or system of lenses, which serves to concentrate or bring the luminous rays to a focus; it is specially an adjunct to the optical lantern and microscope. In electrostatics a condenser is a device for concentrating an electrostatic charge (see ELECTROSTATICS; LEYDEN JAR; ELECTROPHORUS).

CONDOR, CHARLES (1868–1909), English artist, son of a civil engineer, was born in London, and spent his early years in India. After an English education he went into the government service in Australia, but in 1890 determined to devote himself to art, and studied for several years in Paris, where in 1893 he became an associate of the Société Nationale des Beaux-Arts. About 1895 his reputation as an original painter, particularly of Watteau-like designs for fans, spread among a limited circle of artists in London, mainly connected first with the New English Art Club, and later the International Society; and his unique and charming decorative style, in dainty pastoral scenes, gradually gave him a peculiar vogue among connoisseurs. Examples of his work were bought for the Luxembourg and other art galleries. Conder suffered much in later years from ill-health, and died on the 9th of February 1909.

CONDILLAC, ÉTIENNE BONNOT DE (1715–1780), French philosopher, was born at Grenoble of a legal family on the 30th of September 1715, and, like his elder brother, the well-known political writer, abbé de Mably, took holy orders and became abbé de Mureau.¹ In both cases the profession was hardly more than nominal, and Condillac's whole life, with the exception of an interval as tutor at the court of Parma, was devoted to speculation. His works are *Essai sur l'origine des connaissances humaines* (1746), *Traité des systèmes* (1749), *Traité des sensations* (1754), *Traité des animaux* (1755), a comprehensive *Cours d'études* (1767–1773) in 13 vols., written for the young Duke Ferdinand of Parma, a grandson of Louis XV., *Le Commerce et le gouvernement, considérés relativement l'un à l'autre* (1776), and two posthumous works, *Logique* (1781) and the unfinished *Langue des calculs* (1798). In his earlier days in Paris he came much into contact with the circle of Diderot. A friendship with Rousseau, which lasted in some measure to the end, may have been due in the first instance to the fact that Rousseau had been domestic tutor in the family of Condillac's uncle, M. de Mably,

¹ i.e. abbot in commendam of the Premonstratensian abbey of Mureau in the Vesgcs. (Ed.)

at Lyons. Thanks to his natural caution and reserve, Condillac's relations with unorthodox philosophers did not injure his career; and he justified abundantly the choice of the French court in sending him to Parma to educate the orphan duke, then a child of seven years. In 1768, on his return from Italy, he was elected to the French Academy, but attended no meeting after his reception. He spent his later years in retirement at Flux, a small property which he had purchased near Beaugency, and died there on the 3rd of August 1780.

Though Condillac's genius was not of the highest order, he is important both as a psychologist and as having established systematically in France the principles of Locke, whom Voltaire had lately made fashionable. In setting forth his empirical sensationism, Condillac shows many of the best qualities of his age and nation, lucidity, brevity, moderation and an earnest striving after logical method. Unfortunately it must be said of him as of so many of his contemporaries, "er hat die Theile in seiner Hand, fehlt leider nur der geistiger Band"; in the analysis of the human mind on which his fame chiefly rests, he has missed out the active and spiritual side of human experience. His first book, the *Essai sur l'origine des connaissances humaines*, keeps close to his English master. He accepts with some indecision Locke's deduction of our knowledge from two sources, sensation and reflection, and uses as his main principle of explanation the association of ideas. His next book, the *Traité des systèmes*, is a vigorous criticism of those modern systems which are based upon abstract principles or upon unsound hypotheses. His polemic, which is inspired throughout with the spirit of Locke, is directed against the innate ideas of the Cartesians, Malebranche's faculty—psychology, Leibnitz's monadism and pre-established harmony, and, above all, against the conception of substance set forth in the first part of the *Ethics* of Spinoza. By far the most important of his works is the *Traité des sensations*, in which he emancipates himself from the tutelage of Locke and treats psychology in his own characteristic way. He had been led, he tells us, partly by the criticism of a talented lady, Mademoiselle Ferrand, to question Locke's doctrine that the senses give us intuitive knowledge of objects, that the eye, for example, judges naturally of shapes, sizes, positions and distances. His discussions with the lady had convinced him that to clear up such questions it was necessary to study our senses separately, to distinguish precisely what ideas we owe to each sense, to observe how the senses are trained, and how one sense aids another. The result, he was confident, would show that all human faculty and knowledge are transformed sensation only, to the exclusion of any other principle, such as reflection. The plan of the book is that the author imagines a statue organized inwardly like a man, animated by a soul which has never received an idea, into which no sense-impression has ever penetrated. He then unlocks its senses one by one, beginning with smell, as the sense that contributes least to human knowledge. At its first experience of smell, the consciousness of the statue is entirely occupied by it; and this occupancy of consciousness is attention. The statue's smell-experience will produce pleasure or pain; and pleasure and pain will thenceforward be the master-principle which, determining all the operations of its mind, will raise it by degrees to all the knowledge of which it is capable. The next stage is memory, which is the lingering impression of the smell-experience upon the attention: "memory is nothing more than a mode of feeling." From memory springs comparison: the statue experiences the smell, say, of a rose, while remembering that of a carnation; and "comparison is nothing more than giving one's attention to two things simultaneously." And "as soon as the statue has comparison it has judgment." Comparisons and judgments become habitual, are stored in the mind and formed into series, and thus arises the powerful principle of the association of ideas. From comparison of past and present experiences in respect of their pleasure-giving quality arises desire; it is desire that determines the operation of our faculties, stimulates the memory and imagination, and gives rise to the passions. The passions, also, are nothing but sensation transformed. These indications will suffice to show the general course

of the argument in the first section of the *Traité des sensations*. To show the thoroughness of the treatment it will be enough to quote the headings of the chief remaining chapters: "Of the Ideas of a Man limited to the Sense of Smell," "Of a Man limited to the Sense of Hearing," "Of Smell and Hearing combined," "Of Taste by itself, and of Taste combined with Smell and Hearing," "Of a Man limited to the Sense of Sight." In the second section of the treatise Condillac invests his statue with the sense of touch, which first informs it of the existence of external objects. In a very careful and elaborate analysis, he distinguishes the various elements in our tactile experiences—the touching of one's own body, the touching of objects other than one's own body, the experience of movement, the exploration of surfaces by the hands: he traces the growth of the statue's perceptions of extension, distance and shape. The third section deals with the combination of touch with the other senses. The fourth section deals with the desires, activities and ideas of an isolated man who enjoys possession of all the senses; and ends with observations on a "wild boy" who was found living among bears in the forests of Lithuania. The conclusion of the whole work is that in the natural order of things everything has its source in sensation, and yet that this source is not equally abundant in all men; men differ greatly in the degree of vividness with which they feel; and, finally, that man is nothing but what he has acquired; all innate faculties and ideas are to be swept away. The last dictum suggests the difference that has been made to this manner of psychologizing by modern theories of evolution and heredity.

Condillac's work on politics and history, contained, for the most part, in his *Cours d'études*, offers few features of interest, except so far as it illustrates his close affinity to English thought: he had not the warmth and imagination to make a good historian. In logic, on which he wrote extensively, he is far less successful than in psychology. He enlarges with much iteration, but with few concrete examples, upon the supremacy of the analytic method; argues that reasoning consists in the substitution of one proposition for another which is identical with it; and lays it down that science is the same thing as a well-constructed language, a proposition which in his *Langue des calculs* he tries to prove by the example of arithmetic. His logic has in fact the good and bad points that we might expect to find in a sensationist who knows no science but mathematics. He rejects the medieval apparatus of the syllogism; but is precluded by his standpoint from understanding the active, spiritual character of thought; nor had he that interest in natural science and appreciation of inductive reasoning which form the chief merit of J. S. Mill. It is obvious enough that Condillac's anti-spiritual psychology, with its explanation of personality as an aggregate of sensations, leads straight to atheism and determinism. There is, however, no reason to question the sincerity with which he repudiates both these consequences. What he says upon religion is always in harmony with his profession; and he vindicated the freedom of the will in a dissertation that has very little in common with the *Traité des sensations* to which it is appended. The common reproach of materialism should certainly not be made against him. He always asserts the substantive reality of the soul; and in the opening words of his *Essai*, "Whether we rise to heaven, or descend to the abyss, we never get outside ourselves—it is always our own thoughts that we perceive," we have the subjectivist principle that forms the starting-point of Berkeley.

As was fitting to a disciple of Locke, Condillac's ideas have had most importance in their effect upon English thought. In matters connected with the association of ideas, the supremacy of pleasure and pain, and the general explanation of all mental contents as sensations or transformed sensations, his influence can be traced upon the Mills and upon Bain and Herbert Spencer. And, apart from any definite propositions, Condillac did a notable work in the direction of making psychology a science; it is a great step from the desultory, genial observation of Locke to the rigorous analysis of Condillac, short-sighted and defective as that analysis may seem to us in the light of fuller knowledge.

His method, however, of imaginative reconstruction was by no means suited to English ways of thinking. In spite of his protests against abstraction, hypothesis and synthesis, his allegory of the statue is in the highest degree abstract, hypothetical and synthetic. James Mill, who stood more by the study of concrete realities, put Condillac into the hands of his youthful son with the warning that here was an example of what to avoid in the method of psychology. In France Condillac's doctrine, so congenial to the tone of 18th century philosophy, reigned in the schools for over fifty years, challenged only by a few who, like Maine de Biran, saw that it gave no sufficient account of volitional experience. Early in the 19th century, the romantic awakening of Germany had spread to France, and sensationism was displaced by the eclectic spiritualism of Victor Cousin.

Condillac's collected works were published in 1798 (23 vols.) and two or three times subsequently; the last edition (1822) has an introductory dissertation by A. F. Théry. The *Encyclopédie méthodique* has a very long article on Condillac (Naigeon). Biographical details and criticism of the *Traité des systèmes* in J. P. Damiron's *Mémoires pour servir à l'histoire de la philosophie au dix-huitième siècle*, tome iii.; a full criticism in V. Cousin's *Cours de l'histoire de la philosophie moderne*, ser. i. tome iii. Consult also F. Rethore, *Condillac ou l'empirisme et le rationalisme* (1864); L. Dewaule, *Condillac et la psychologie anglaise contemporaine* (1891); histories of philosophy. (H. St.)

CONDITION (Lat. *condicio*, from *condicere*, to agree upon, arrange; not connected with *conditio*, from *condere*, *conditum*, to put together), a stipulation, agreement. The term is applied technically to any circumstance, action or event which is regarded as the indispensable prerequisite of some other circumstance, action or event. It is also applied generally to the sum of the circumstances in which a person is situated, and more specifically to favourable or prosperous circumstances; thus a person of wealth or birth is described as a person "of condition," or an athlete as being "in condition," i.e. physically fit, having gone through the necessary course of preliminary training. In all these senses there is implicit the idea of limitation or restraint imposed with a view to the attainment of a particular end.

(1) In *Logic*, the term "condition" is closely related to "cause" in so far as it is applied to prior events, &c., in the absence of which another event would not take place. It is, however, different from "cause" inasmuch as it has a predominantly negative or passive significance. Hence the adjective "conditional" is applied to propositions in which the truth of the main statement is made to depend on the truth of another; these propositions are distinguished from categorical propositions, which simply state a fact, as being "composed of two categorical propositions united by a conjunction," e.g. if A is B, C is D. The second statement (the "consequent") is restricted or qualified by the first (the "antecedent"). By some logicians these propositions are classified as (1) Hypothetical, and (2) Disjunctive, and their function in syllogistic reasoning gives rise to the following classification of conditional arguments:—(a) Constructive hypothetical syllogism (*modus ponens*, "affirmative mood"): If A is B, C is D; but A is B; therefore C is D. (b) Destructive hypothetical syllogism (*modus tollens*, mood which "removes," i.e. the consequent): if A is B, C is D; but C is not D; therefore A is not B. In (a) the antecedent must be affirmed, in (b) the consequent must be denied; otherwise the arguments become fallacious. A second class of conditional arguments are disjunctive syllogisms consisting of (c) the *modus ponendo tollens*: A is either B or C; but A is B; therefore C is not D; and (d) *modus tollendo ponens*: A is either B or C; A is not B; therefore A is C. A more complicated conditional argument is the dilemma (*q.v.*).¹

The limiting or restrictive significance of "condition" has led to its use in metaphysical theory in contradistinction to the conception of absolute being, the *aseitas* of the Schoolmen.

¹The terminology used above has not been adopted by all logicians. "Conditional" has been used as equivalent to "hypothetical" in the widest sense (including "disjunctive"); or narrowed down to be synonymous with "conjunctive" (the condition being there more explicit), as a subdivision of "hypothetical."

Thus all finite things exist in certain relations not only to all other things but also to thought; in other words, all finite existence is "conditioned." Hence Sir Wm. Hamilton speaks of the "philosophy of the unconditioned," i.e. of thought in distinction to things which are determined by thought in relation to other things. An analogous distinction is made (cf. H. W. B. Joseph, *Introduction to Logic*, pp. 380 foll.) between the so-called universal laws of nature and conditional principles, which, though they are regarded as having the force of law, are yet dependent or derivative, i.e. cannot be treated as universal truths. Such principles hold good under present conditions, but other conditions might be imagined under which they would be invalid; they hold good only as corollaries from the laws of nature under existing conditions.

(2) In *Law*, condition in its general sense is a restraint annexed to a thing, so that by the non-performance the party to it shall receive prejudice and loss, and by the performance commodity or advantage. Conditions may be either: (1) condition in a deed or *express condition*, i.e. the condition being expressed in actual words; or (2) condition in law or *implied condition*, i.e. where, although no condition is actually expressed, the law implies a condition. The word is also used indifferently to mean either the event upon the happening of which some estate or obligation is to begin or end, or the provision or stipulation that the estate or obligation will depend upon the happening of the event. A condition may be of several kinds: (1) a condition *precedent*, where, for example, an estate is granted to one for life upon condition that, if the grantee pay the grantor a certain sum on such a day, he shall have the fee simple; (2) a condition *subsequent*, where, for example, an estate is granted in fee upon condition that the grantee shall pay a certain sum on a certain day, or that his estate shall cease. Thus a condition precedent gets or gains, while a condition subsequent keeps and continues. A condition may also be *affirmative*, that is, the doing of an act; *negative*, the not doing of an act; *restrictive*, *compulsory*, &c. The word is also used adjectivally in the sense set out above, as in the phrases "conditional legacy," "conditional limitation," "conditional promise," &c.; that is, the legacy, the limitation, the promise is to take effect only upon the happening of a certain event.

CONDITIONAL FEE, at English common law, a fee or estate restrained in its form of donation to some particular heirs, as, to the heirs of a man's body, or to the heirs male of his body. It was called a conditional fee by reason of the condition expressed or implied in the donation of it, that if the donee died without such particular heirs, the land should revert to the donor. In other words, it was a fee simple on condition that the donee had issue, and as soon as such issue was born, the estate was supposed to become absolute by the performance of the condition. A conditional fee was converted by the statute *De Donis Conditionalibus* into an estate tail (see **REAL PROPERTY**).

CONDITIONAL LIMITATION, in law, a phrase used in two senses. (1) The qualification annexed to the grant of an estate or interest in land, providing for the determination of that grant or interest upon a particular contingency happening. An estate with such a limitation can endure only until the particular contingency happens; it is a present interest, to be divested on a future contingency. The grant of an estate to a man so long as he is parson of Dale, or while he continues unmarried, are instances of conditional limitations of estates for life. (2) A future use or interest in land limited to take effect upon a given contingency. For instance, a grant to X. and his heirs to the use of A., provided that when C. returns from Rome the land shall go to the use of B. in fee simple. B. is said to take under a conditional limitation, operating by executory devise or springing or shifting use (see **REMAINDER**, **REVERSION**).

CONDOM, a town of south-western France, capital of an arrondissement in the department of Gers, on the right bank of the Baïse, at its junction with the Gèle, 27 m. by road N.N.W. of Auch. Pop. (1906) town, 40,46; commune, 6,435. Two stone bridges unite Condom with its suburb on the left bank of the river. The streets are small and narrow and several old

houses still remain, but to the east the town is bordered by pleasant promenades. The Gothic church of St Pierre, its chief building, was erected from 1506 to 1521, and was till 1790 a cathedral. The interior, which is without aisles or transept, is surrounded by lateral chapels. On the south is a beautifully sculptured portal. An adjoining cloister of the 16th century is occupied by the hôtel de ville. The former episcopal palace with its graceful Gothic chapel is used as a law-court. The sub-prefecture, a tribunal of first instance, and a communal college, are among the public institutions. Brandy-distilling, wood-sawing, iron-founding and the manufacture of stills are among the industries. The town is a centre for the sale of Armagnac brandy and has commerce in grain and flour, much of which is river-borne.

Condom (*Condomus*) was founded in the 8th century, but in 840 was sacked and burnt by the Normans. A monastery built here c. 900 by the wife of Sancho of Gascony was soon destroyed by fire, but in 1011 was rebuilt by Hugh, bishop of Agen. Round this abbey the town grew up, and in 1317 was made into an episcopal see by Pope John XXII. The line of bishops, which included Bossuet (1668-1671), came to an end in 1790 when the see was suppressed. Condom was, during the middle ages, a fortress of considerable strength. During the Hundred Years' War, after several unsuccessful attempts, it was finally captured and held by the English. In 1569 it was sacked by the Huguenots under Gabriel, count of Montgomery.

A list of monographs, &c., on the abbey, see and town of Condom is given *s.v.* in U. Chevalier, *Répertoire des sources. Topobibliogr.* (Montbéliard, 1894-1899).

CONDOR (*Sarcorhamphus gryphus*), an American vulture, and almost the largest of existing birds of flight, although by no means attaining the dimensions attributed to it by early writers. It usually measures about 4 ft. from the point of the beak to the extremity of the tail, and 9 ft. between the tips of its wings, while it is probable that the expanse of wing never exceeds 12 ft. The head and neck are destitute of feathers, and the former, which is much flattened above, is in the male crowned with a caruncle or comb, while the skin of the latter in the same sex lies in folds, forming a wattle. The adult plumage is of a uniform black, with the exception of a fringe of white feathers nearly surrounding the base of the neck, and certain wing feathers which, especially in the male, have large patches of white. The middle toe is greatly elongated, and the hinder one but slightly developed, while the talons of all the toes are comparatively straight and blunt, and are thus of little use as organs of prehension. The female, contrary to the usual rule among birds of prey, is smaller than the male.

The condor is a native of South America, where it is confined to the region of the Andes, from the Straits of Magellan to 4° north latitude,—the largest examples, it is said, being found about the volcano of Cayambí, situated on the equator. It is often seen on the shores of the Pacific, especially during the rainy season, but its favourite haunts for roosting and breeding are at elevations of 10,000 to 16,000 ft. There, during the months of February and March, on inaccessible ledges of rock, it deposits two white eggs, from 3 to 4 in. in length, its nest consisting merely of a few sticks placed around the eggs. The period of incubation lasts for seven weeks, and the young are covered with a whitish down until almost as large as their parents. They are unable to fly till nearly two years old, and continue for a considerable time after taking wing to roost and hunt with their parents. The white ruff on the neck, and the similarly coloured feathers of the wing, do not appear until the completion of the first moulting. By preference the condor feeds on carrion, but it does not hesitate to attack sheep, goats and deer, and for this reason it is hunted down by the shepherds, who, it is said, train their dogs to look up and bark at the condors as they fly overhead. They are exceedingly voracious, a single condor of moderate size having been known, according to Orton, to devour a calf, a sheep and a dog in a single week. When thus gorged with food, they are exceedingly stupid, and may then be readily caught. For this purpose a horse or mule

is killed, and the carcase surrounded with palisades to which the condors are soon attracted by the prospect of food, for the weight of evidence seems to favour the opinion that those vultures owe their knowledge of the presence of carrion more to sight than to scent. Having feasted themselves to excess, they are set upon by the hunters with sticks, and being unable, owing to the want of space within the pen, to take the run without which they are unable to rise on wing, they are readily killed or captured. They sleep during the greater part of the day, searching for food in the clearer light of morning and evening. They are remarkably heavy sleepers, and are readily captured by the inhabitants ascending the trees on which they roost, and noosing them before they awaken. Great numbers of condors are thus taken alive, and these, in certain districts, are employed in a variety of bull-fighting. They are exceedingly tenacious of life, and can exist, it is said, without food for over forty days. Although the favourite haunts of the condor are at the level of perpetual snow, yet it rises to a much greater height, Humboldt having observed it flying over Chimborazo at a height of over 23,000 ft. On wing the movements of the condor, as it wheels in majestic circles, are remarkably graceful. The birds flap their wings on rising from the ground, but after attaining a moderate elevation they seem to sail on the air, Charles Darwin having watched them for half an hour without once observing a flap of their wings.

CONDORCET, MARIE JEAN ANTOINE NICOLAS CARITAT, MARQUIS DE (1743-1794), French mathematician, philosopher and Revolutionist, was born at Ribemont, in Picardy, on the 17th of September 1743. He descended from the ancient family of Caritat, who took their title from Condorcet, near Nyons in Dauphiné, where they were long settled. His father dying while he was very young, his mother, a very devout woman, had him educated at the Jesuit College in Reims and at the College of Navarre in Paris, where he displayed the most varied mental activity. His first public distinctions were gained in mathematics. At the age of sixteen his performances in analysis gained the praise of D'Alembert and A. C. Clairaut, and at the age of twenty-two he wrote a treatise on the integral calculus which obtained warm approbation from competent judges. With his many-sided intellect and richly-endowed emotional nature, however, it was impossible for him to be a specialist, and least of all a specialist in mathematics. Philosophy and literature attracted him, and social work was dearer to him than any form of intellectual exercise. In 1769 he became a member of the Academy of Sciences. His contributions to its memoirs are numerous, and many of them are on the most abstruse and difficult mathematical problems.

Being of a very genial, susceptible and enthusiastic disposition, he was the friend of almost all the distinguished men of his time, and a zealous propagator of the religious and political views then current among the literati of France. D'Alembert, Turgot and Voltaire, for whom he had great affection and veneration, and by whom he was highly respected and esteemed, contributed largely to the formation of his opinions. His *Lettre d'un labourcur de Picardie à M. N.* . . . (Necker) was written under the inspiration of Turgot, in defence of free internal trade in corn. Condorcet also wrote on the same subject the *Réflexions sur le commerce des blés* (1776). His *Lettre d'un théologien*, &c., was attributed to Voltaire, being inspired throughout by the Voltairian anti-clerical spirit. He was induced by D'Alembert to take an active part in the preparation of the *Encyclopédie*. His *Éloges des Académiciens de l'Académie Royale des Sciences morts depuis 1666 jusqu'en 1699* (1773) gained him the reputation of being an eloquent and graceful writer. He was elected to the perpetual secretaryship of the Academy of Sciences in 1777, and to the French Academy in 1782. He was also member of the academies of Turin, St Petersburg, Bologna and Philadelphia. In 1785 he published his *Essai sur l'application de l'analyse aux probabilités des décisions prises à la pluralité des voix*,—a remarkable work which has a distinguished place in the history of the doctrine of probability; a second edition, greatly enlarged and completely recast, appeared in 1804 under the title of *Éléments du calcul*

des probabilités et son application aux jeux de hazard, à la loterie, et aux jugements des hommes, &c. In 1786 he married Sophie de Grouchy, a sister of Marshal Grouchy, said to have been one of the most beautiful women of her time. Her *salon* at the Hôtel des Monnaies, where Condorcet lived in his capacity as inspector-general of the mint, was one of the most famous of the time. In 1786 Condorcet published his *Vie de Turgot*, and in 1787 his *Vie de Voltaire*. Both works were widely and eagerly read, and are perhaps, from a merely literary point of view, the best of Condorcet's writings.

The political tempest which had been long gathering over France now began to break and to carry everything before it. Condorcet was, of course, at once hurried along by it into the midst of the conflicts and confusion of the Revolution. He greeted with enthusiasm the advent of democracy, and laboured hard to secure and hasten its triumph. He was indefatigable in writing pamphlets, suggesting reforms, and planning constitutions. He was not a member of the States-General of 1789, but he had expressed his ideas in the electoral assembly of the noblesse of Mantes. The first political functions which he exercised were those of a member of the municipality of Paris (1790). He was next chosen by the Parisians to represent them in the Legislative Assembly, and then appointed by that body one of its secretaries. In this capacity he drew up most of its addresses, but seldom spoke, his pen being more effective than his tongue. He was the chief author of the address to the European powers when they threatened France with war. He was keenly interested in education, and, as a member of the committee of public instruction, presented to the Assembly (April 21 and 22, 1792) a bold and comprehensive scheme for the organization of a system of state education which, though more urgent questions compelled its postponement, became the basis of that adopted by the Convention, and thus laid the foundations on which the modern system of national education in France is built up. After the attempted flight of the king, in June 1791, Condorcet was one of the first to declare in favour of a republic, and it was he who drew up the memorandum which led the Assembly, on the 4th of September 1792, to decree the suspension of the king and the summoning of the National Convention. He had, meanwhile, resigned his offices and left the Hôtel des Monnaies; his declaration in favour of republicanism had alienated him from his former friends of the constitutional party, and he did not join the Jacobin Club, which had not yet declared against the monarchy. Though attached to no powerful political group, however, his reputation gave him great influence. At the elections for the Convention he was chosen for five departments, and took his seat for that of Aisne. He now became the most influential member of the committee on the constitution, and as "reporter" he drafted and presented to the Convention (February 15, 1793) a constitution, which was, however, after stormy debates, rejected in favour of that presented by Héroult de Séchelles. The work of constitution-making had been interrupted by the trial of Louis XVI. Condorcet objected to the assumption of judicial functions by the Convention, objected also on principle to the infliction of the death penalty; but he voted the king guilty of conspiring against liberty and worthy of any penalty short of death, and against the appeal to the people advocated by the Girondists. In the atmosphere of universal suspicion that inspired the Terror his independent attitude could not, however, be maintained with impunity. His severe and public criticism of the constitution adopted by the Convention, his denunciation of the arrest of the Girondists, and his opposition to the violent conduct of the Mountain, led to his being accused of conspiring against the Republic. He was condemned and declared to be *hors la loi*. Friends, sought for him an asylum in the house of Madame Vernet, widow of the sculptor and a near connexion of the painters of the same name. Without even asking his name, this heroic woman, as soon as she was assured that he was an honest man, said, "Let him come, and lose not a moment, for while we talk he may be seized." When the execution of the Girondists showed him that his presence exposed his protectress to a terrible danger, he resolved

to seek a refuge elsewhere. "I am outlawed," he said, "and if I am discovered you will meet the same sad end as myself. I must not stay." Madame Vernet's reply deserves to be immortal, and should be given in her own words: "La Convention, Monsieur, a le droit de mettre hors la loi: elle n'a pas le pouvoir de mettre hors de l'humanité; vous resterez." From that time she had his movements strictly watched lest he should attempt to quit her house. It was partly to turn his mind from the idea of attempting this, by occupying it otherwise, that his wife and some of his friends, with the co-operation of Madame Vernet, prevailed on him to engage in the composition of the work by which he is best known—the *Esquisse d'un tableau historique des progrès de l'esprit humain*. In his retirement Condorcet wrote also his justification, and several small works, such as the *Moyen d'apprendre à compter sûrement et avec facilité*, which he intended for the schools of the republic. Several of these works were published at the time, thanks to his friends; the rest appeared after his death. Among the latter was the admirable *Avis d'un proscrit à sa fille*. While in hiding he also continued to take an active interest in public affairs. Thus, he wrote several important memoranda on the conduct of the war against the Coalition, which were laid before the Committee of Public Safety anonymously by a member of the Mountain named Marcoz, who lived in the same house as Condorcet without thinking it his duty to denounce him. In the same way he forwarded to Arbogast, president of the committee for public instruction, the solutions of several problems in higher mathematics.

Certain circumstances having led him to believe that the house of Madame Vernet, 21 rue Servandoni, was suspected and watched by his enemies, Condorcet, by a fatally successful artifice, at last baffled the vigilance of his generous friend and escaped. Disappointed in finding even a night's shelter at the château of one whom he had befriended, he had to hide for three days and nights in the thickets and stone-quarries of Clamart. On the evening of the 7th of April 1794—not, as Carlyle says, on a "bleared May morning,"—with garments torn, with wounded leg, with famished looks, he entered a tavern in the village named, and called for an omelette. "How many eggs in your omelette?" "A dozen." "What is your trade?" "A carpenter." "Carpenters have not hands like these, and do not ask for a dozen eggs in an omelette." When his papers were demanded he had none to show; when his person was searched a Horace was found on him. The villagers seized him, bound him, haled him forthwith on bleeding feet towards Bourg-la-Reine; he fainted by the way, was set on a horse offered in pity by a passing peasant, and, at the journey's end, was cast into a cold damp cell. Next morning he was found dead on the floor. Whether he had died from suffering and exhaustion, from apoplexy or from poison, is an undetermined question.

Condorcet was undoubtedly a most sincere, generous and noble-minded man. He was eager in the pursuit of truth, ardent in his love of human good, and ever ready to undertake labour or encounter danger on behalf of the philanthropic plans which his fertile mind contrived and his benevolent heart inspired. It was thus that he worked for the suppression of slavery, for the rehabilitation of the chevalier de La Barre, and in defence of Lally-Tollendal. He lived at a time when calumny was rife, and various slanders were circulated regarding him, but fortunately the slightest examination proves them to have been inexcusable fabrications. That while openly opposing royalty he was secretly soliciting the office of tutor to the Dauphin; that he was accessory to the murder of the duc de la Rochefoucauld; or that he sanctioned the burning of the literary treasures of the learned congregations, are stories which can be shown to be utterly untrue.

His philosophical fame is chiefly associated with the *Esquisse . . . des progrès* mentioned above. With the vision of the guillotine before him, with confusion and violence around him, he comforted himself by trying to demonstrate that the evils of life had arisen from a conspiracy of priests and rulers against their fellows, and from the bad laws and institutions which they had succeeded in creating, but that the human race would finally conquer its

enemies and free itself of its evils. His fundamental idea is that of a human perfectibility which has manifested itself in continuous progress in the past, and must lead to indefinite progress in the future. He represents man as starting from the lowest stage of barbarism, with no superiority over the other animals save that of bodily organization, and as advancing uninterruptedly, at a more or less rapid rate, in the path of enlightenment, virtue and happiness. The stages which the human race has already gone through, or, in other words, the great epochs of history, are regarded as nine in number. The first three can confessedly be described only conjecturally from general observations as to the development of the human faculties, and the analogies of savage life. In the first epoch, men are united into hordes of hunters and fishers, who acknowledge in some degree public authority and the claims of family relationship, and who make use of an articulate language. In the second epoch—the pastoral state—property is introduced, and along with it inequality of conditions, and even slavery, but also leisure to cultivate intelligence, to invent some of the simpler arts, and to acquire some of the more elementary truths of science. In the third epoch—the agricultural state—as leisure and wealth are greater, labour better distributed and applied, and the means of communication increased and extended, progress is still more rapid. With the invention of alphabetic writing the conjectural part of history closes and the more or less authenticated part commences. The fourth and fifth epochs are represented as corresponding to Greece and Rome. The middle ages are divided into two epochs, the former of which terminates with the Crusades, and the latter with the invention of printing. The eighth epoch extends from the invention of printing to the revolution in the method of philosophic thinking accomplished by Descartes. And the ninth epoch begins with that great intellectual revolution, and ends with the great political and moral revolution of 1789, and is illustrious, according to Condorcet, through the discovery of the true system of the physical universe by Newton, of human nature by Locke and Condillac, and of society by Turgot, Richard Price and Rousseau. There is an epoch of the future—a tenth epoch,—and the most original part of Condorcet's treatise is that which is devoted to it. After insisting that general laws regulative of the past warrant general inferences as to the future, he argues that the three tendencies which the entire history of the past shows will be characteristic features of the future are:—(1) the destruction of inequality between nations; (2) the destruction of inequality between classes; and (3) the improvement of individuals, the indefinite perfectibility of human nature itself—intellectually, morally and physically. These propositions have been much misunderstood. The equality to which he represents nations and individuals as tending is not absolute equality, but equality of freedom and of rights. It is that equality which would make the inequality of the natural advantages and faculties of each community and person beneficial to all. Nations and men, he thinks, are equal, if equally free, and are all tending to equality because all tending to freedom. As to indefinite perfectibility, he nowhere denies that progress is conditioned both by the constitution of humanity and the character of its surroundings. But he affirms that these conditions are compatible with endless progress, and that the human mind can assign no fixed limits to its own advancement in knowledge and virtue, or even to the prolongation of bodily life. This theory explains the importance he attached to popular education, to which he looked for all sure progress.

The book is pervaded by a spirit of excessive hopefulness, and contains numerous errors of detail, which are fully accounted for by the circumstances in which it was written. Its value lies entirely in its general ideas. Its chief defects spring from its author's narrow and fanatical aversion to all philosophy which did not attempt to explain the world exclusively on mechanical and sensational principles, to all religion whatever, and especially to Christianity and Christian institutions, and to monarchy. His ethical position, however, gives emphasis to the sympathetic impulses and social feelings, and had considerable influence upon Auguste Comte.

Madame de Condorcet (b. 1764), who was some twenty years younger than her husband, was rendered penniless by his proscription, and compelled to support not only herself and her four years old daughter but her younger sister, Charlotte de Grouchy. After the end of the Jacobin Terror she published an excellent translation of Adam Smith's *Theory of Moral Sentiments*; in 1798 a work of her own, *Lettres sur la sympathie*; and in 1799 her husband's *Éloges des académiciens*. Later she co-operated with Cabanis, who had married her sister, and with Garat in publishing the complete works of Condorcet (1801-1804). She adhered to the last to the political views of her husband, and under the Consulate and Empire her *salon* became a meeting-place of those opposed to the autocratic régime. She died at Paris on the 8th of September 1822. Her daughter was married, in 1807, to General O'Connor.

A *Biographie de Condorcet*, by M. F. Arago, is prefixed to A. Condorcet-O'Connor's edition of Condorcet's works, in 12 volumes (1847-1849). There is an able essay on Condorcet in Lord Morley of Blackburn's *Critical Miscellanies*. On Condorcet as an historical philosopher see Comte's *Cours de philosophie positive*, iv. 252-253, and *Système de politique positive*, iv. Appendice Général, 109-111; F. Laurent, *Études*, xii. 121-126, 89-110; and R. Flint, *Philosophy of History in France and Germany*, i. 125-138. The *Mémoires de Condorcet sur la Révolution française, extraits de sa correspondance et de celles de ses amis* (2 vols., Paris, Ponthieu, 1824), which were in fact edited by F. G. de la Rochefoucauld-Liancourt, are spurious. See also Dr J. F. E. Robinet, *Condorcet, sa vie et son œuvre*, and more especially L. Cahen, *Condorcet et la Révolution française* (Paris, 1904). On Madame de Condorcet see Antoine Guillois, *La Marquise de Condorcet, sa famille, son salon et ses œuvres* (Paris, 1897).

CONDOTTIERE (plural, *condottieri*), an Italian term, derived ultimately from Latin *conducere*, meaning either "to conduct" or "to hire," for the leader of the mercenary military companies, often several thousand strong, which used to be hired out to carry on the wars of the Italian states. The word is often extended so as to include the soldiers as well as the leader of a company. The condottieri played a very important part in Italian history from the middle of the 13th to the middle of the 15th century. The special political and military circumstances of medieval Italy, and in particular the wars of the Guelphs and Ghibellines, brought it about that the condottieri and their leaders played a more conspicuous and important part in history than the "Free Companies" elsewhere. Amongst these circumstances the absence of a numerous feudal cavalry, the relative luxury of city life, and the incapacity of city militia for wars of aggression were the most prominent. From this it resulted that war was not merely the trade of the condottiere, but also his monopoly, and he was thus able to obtain whatever terms he asked, whether money payments or political concessions. These companies were recruited from wandering mercenary bands and individuals of all nations, and from the ranks of the many armies of middle Europe which from time to time overran Italy.

Montreal d'Albarno, a gentleman of Provence, was the first to give them a definite form. A severe discipline and an elaborate organization were introduced within the company itself, while in their relations to the people the most barbaric licence was permitted. Montreal himself was put to death at Rome by Rienzi, and Conrad Lando succeeded to the command. The Grand Company, as it was called, soon numbered about 7000 cavalry and 1500 select infantry, and was for some years the terror of Italy. They seem to have been Germans chiefly. On the conclusion (1360) of the peace of Bretigny between England and France, Sir John Hawkwood (*q.v.*) led an army of English mercenaries, called the White Company, into Italy; which took a prominent part in the confused wars of the next thirty years. Towards the end of the century the Italians began to organize armies of the same description. This ended the reign of the purely mercenary company, and began that of the semi-national mercenary army which endured in Europe till replaced by the national standing army system. The first company of importance raised on the new basis was that of St George, originated by Alberigo, count of Barbiano, many of whose subordinates and pupils conquered principalities for themselves. Shortly after,

the organization of these mercenary armies was carried to the highest perfection by Sforza Attendolo, condottiere in the service of Naples, who had been a peasant of the Romagna, and by his rival Brancaccio di Montone in the service of Florence. The army and the renown of Sforza were inherited by his son Francesco Sforza, who eventually became duke of Milan (1450). Less fortunate was another great condottiere, Carmagnola, who first served one of the Visconti, and then conducted the wars of Venice against his former masters, but at last awoke the suspicion of the Venetian oligarchy, and was put to death before the palace of St Mark (1432). Towards the end of the 15th century, when the large cities had gradually swallowed up the small states, and Italy itself was drawn into the general current of European politics, and became the battlefield of powerful armies—French, Spanish and German—the condottieri, who in the end proved quite unequal to the gendarmerie of France and the improved troops of the Italian states, disappeared.

The soldiers of the condottieri were almost entirely heavy armoured cavalry (men-at-arms). They had, at any rate before 1400, nothing in common with the people among whom they fought, and their disorderly conduct and rapacity seem often to have exceeded that of other medieval armies. They were always ready to change sides at the prospect of higher pay. They were connected with each other by the interest of a common profession, and by the possibility that the enemy of to-day might be the friend and fellow-soldier of to-morrow. Further, a prisoner was always more valuable than a dead enemy. In consequence of all this their battles were often as bloodless as they were theatrical. Splendidly equipped armies were known to fight for hours with hardly the loss of a man (Zagonara, 1423; Molinella, 1467).

CONDUCTION, ELECTRIC. The electric conductivity of a substance is that property in virtue of which all its parts come spontaneously to the same electric potential if the substance is kept free from the operation of electric force. Accordingly, the reciprocal quality, electric resistivity, may be defined as a quality of a substance in virtue of which a difference of potential can exist between different portions of the body when these are in contact with some constant source of electromotive force, in such a manner as to form part of an electric circuit.

All material substances possess in some degree, large or small, electric conductivity, and may for the sake of convenience be broadly divided into five classes in this respect. Between these, however, there is no sharply-marked dividing line, and the classification must therefore be accepted as a more or less arbitrary one. These divisions are: (1) metallic conductors, (2) non-metallic conductors, (3) dielectric conductors, (4) electrolytic conductors, (5) gaseous conductors. The first class comprises all metallic substances, and those mixtures or combinations of metallic substances known as alloys. The second includes such non-metallic bodies as carbon, silicon, many of the oxides and peroxides of the metals, and probably also some oxides of the non-metals, sulphides and selenides. Many of these substances, for instance carbon and silicon, are well-known to have the property of existing in several allotropic forms, and in some of these conditions, so far from being fairly good conductors, they may be almost perfect non-conductors. An example of this is seen in the case of carbon in its three allotropic conditions—charcoal, graphite and diamond. As charcoal it possesses a fairly well-marked but not very high conductivity in comparison with metals; as graphite, a conductivity about one-fourth-hundredth of that of iron; but as diamond so little conductivity that the substance is included amongst insulators or non-conductors. The third class includes those substances which are generally called insulators or non-conductors, but which are better denominated dielectric conductors; it comprises such solid substances as mica, ebonite, shellac, india-rubber, gutta-percha, paraffin, and a large number of liquids, chiefly hydrocarbons. These substances differ greatly in insulating power, and according as the conductivity is more or less marked, they are spoken of as bad or good insulators. Amongst the latter many of the liquid gases hold a high position. Thus, liquid

oxygen and liquid air have been shown by Sir James Dewar to be almost perfect non-conductors of electricity.

The behaviour of substances which fall into these three classes is discussed below in section I., dealing with metallic conduction.

The fourth class, namely the electrolytic conductors comprises all those substances which undergo chemical decomposition when they form part of an electric circuit traversed by an electric current. They are discussed in section II., dealing with electrolytic conduction.

The fifth and last class of conductors includes the gases. The conditions under which this class of substance becomes possessed of electric conductivity are considered in section III., on conduction in gases.

In connexion with metallic conductors, it is a fact of great interest and considerable practical importance, that, although the majority of metals when in a finely divided or powdered condition are practically non-conductors, a mass of metallic powder or filings may be made to pass suddenly into a conductive condition by being exposed to the influence of an electric wave. The same is true of the loose contact of two metallic conductors. Thus if a steel point, such as a needle, presses very lightly against a metallic plate, say of aluminium, it is found that this metallic contact, if carefully adjusted, is non-conductive, but that if an electric wave is created anywhere in the neighbourhood, this non-conducting contact passes into a conductive state. This fact, investigated and discovered independently by D. E. Hughes, C. Onesti, E. Branly, O. J. Lodge and others, is applied in the construction of the "coherer," or sensitive tube employed as a detector or receiver in that form of "wireless telegraphy" chiefly developed by Marconi. Further references to it are made in the articles **ELECTRIC WAVES** and **TELEGRAPHY: Wireless**.

International Ohm.—The practical unit of electrical resistance was legally defined in Great Britain by the authority of the queen in council in 1894, as the "resistance offered to an invariable electric current by a column of mercury at the temperature of melting ice, 14.4521 grammes in mass, of a constant cross-sectional area, and a length 106.3 centimetres." The same unit has been also legalized as a standard in France, Germany and the United States, and is denominated the "International or Standard Ohm." It is intended to represent as nearly as possible a resistance equal to 10^9 absolute C.G.S. units of electric resistance. Convenient multiples and subdivisions of the ohm are the microhm and the megohm, the former being a millionth part of an ohm, and the latter a million ohms. The resistivity of substances is then numerically expressed by stating the resistance of one cubic centimetre of the substance taken between opposed faces, and expressed in ohms, microhms or megohms, as may be most convenient. The reciprocal of the ohm is called the mho, which is the unit of conductivity, and is defined as the conductivity of a substance whose resistance is one ohm. The absolute unit of conductivity is the conductivity of a substance whose resistivity is one absolute C.G.S. unit, or one-thousandth-millionth part of an ohm. Resistivity is a quality in which material substances differ very widely. The metals and alloys, broadly speaking, are good conductors, and their resistivity is conveniently expressed in microhms per cubic centimetre, or in absolute C.G.S. units. Very small differences in density and in chemical purity make, however, immense differences in electric resistivity; hence the values given by different experimentalists for the resistivity of known metals differ to a considerable extent.

I. CONDUCTION IN SOLIDS

It is found convenient to express the resistivity of metals in two different ways: (1) We may state the resistivity of one cubic centimetre of the material in microhms or absolute units taken between opposed faces. This is called the *volume-resistivity*; (2) we may express the resistivity by stating the resistance in ohms offered by a wire of the material in question of uniform cross-section one metre in length, and one gramme in weight. This numerical measure of the resistivity is called the *mass-resistivity*. The mass-resistivity of a body is connected with its volume-resistivity and the density of the material in the following manner:—The mass-resistivity, expressed in microhms per metre-gramme, divided by 10 times the density is numerically equal to the volume-resistivity per centimetre-cube in absolute C.G.S. units. The mass-resistivity per metre-gramme can always be obtained by measuring the resistance and the mass of any wire of

uniform cross-section of which the length is known, and if the density of the substance is then measured, the volume-resistivity can be immediately calculated.

If R is the resistance in ohms of a wire of length l , uniform cross-section s , and density d , then taking ρ for the volume-resistivity we have $10^9 R = \rho l/s$; but $l s d = M$, where M is the mass of the wire. Hence $10^9 R = \rho d l^2 / M$. If $l = 100$ and $M = 1$, then $R = \rho' =$ resistivity in ohms per metre-gramme, and $10^9 \rho' = 10,000 d \rho$, or $\rho = 10^5 \rho' / d$, and $\rho' = 10,000 M R / l^2$.

The following rules, therefore, are useful in connexion with these measurements. To obtain the mass-resistivity per metre-gramme of a substance in the form of a uniform metallic wire:—Multiply together 10,000 times the mass in grammes and the total resistance in ohms, and then divide by the square of the length in centimetres. Again, to obtain the volume-resistivity in C.G.S. units per centimetre-cube, the rule is to multiply the mass-resistivity in ohms by 100,000 and divide by the density. These rules, of course, apply only to wires of uniform cross-section. In the following Tables I., II., and III. are given the mass and volume resistivity of ordinary metals and certain alloys expressed in terms of the international ohm or the absolute C.G.S. unit of resistance, the values being calculated from the experiments of A. Matthiessen (1831–1870) between 1860 and 1865, and from later results obtained by J. A. Fleming and Sir James Dewar in 1893.

TABLE I.—*Electric Mass-Resistivity of Various Metals at 0° C., or Resistance per Metre-gramme in International Ohms at 0° C. (Matthiessen.)*

Metal.	Resistance at 0° C. in International Ohms of a Wire 1 Metre long and Weighing 1 Gramme.	Approximate Temperature Co-efficient near 20° C.
Silver (annealed) . .	.1523	0.00377
Silver (hard-drawn) . .	.1657	..
Copper (annealed) . .	.1421	0.00388
Copper (hard-drawn) . .	1.449 (Matthiessen's Standard)	0.00365
Gold (annealed) . .	.4025	..
Gold (hard-drawn) . .	.4094	..
Aluminium (annealed) . .	.0757	..
Zinc (pressed) . .	.4013	..
Platinum (annealed) . .	1.9337	..
Iron (annealed) . .	.765	..
Nickel (annealed) . .	1.0581	..
Tin (pressed) . .	.9618	0.00365
Lead (pressed) . .	2.2268	0.00387
Antimony (pressed) . .	2.3787	0.00389
Bismuth (pressed) . .	12.8554 ¹	0.00354
Mercury (liquid) . .	12.885 ²	0.00072

The data commonly used for calculating metallic resistivities were obtained by A. Matthiessen, and his results are set out in the Table II. which is taken from Cantor lectures given by Fleming Jenkin in 1866 or about the date when the researches were made. The figures given by Jenkin have, however, been reduced to international ohms and C.G.S. units by multiplying by $(\pi/4) \times 0.9866 \times 10^5 = 77.485$.

Subsequently numerous determinations of the resistivity of various pure metals were made by Fleming and Dewar, whose results are set out in Table III.

Resistivity of Mercury.—The volume-resistivity of pure mercury is a very important electric constant, and since 1880 many of the most competent experimentalists have directed their attention to the determination of its value. The experimental process has usually been to fill a glass tube of known dimensions, having large cup-like extensions at the ends, with pure mercury, and determine the absolute resistance of this column of metal. For the practical details of this method the following references may be consulted:—“The Specific Resistance of Mercury,” Lord Rayleigh and Mrs Sidgwick, *Phil. Trans.*, 1883, part i. p. 173, and R. T. Glazebrook, *Phil. Mag.*, 1885, p. 20; “On the Specific Resistance of Mercury,” R. T. Glazebrook and T. C. Fitzpatrick, *Phil. Trans.*, 1888, p. 179, or *Proc. Roy. Soc.*, 1888, p. 44, or *Electrician*, 1888, 21, p. 538; “Recent Determinations of the Absolute Resistance of Mercury,” R. T. Glazebrook, *Electrician*, 1890, 25, pp. 543 and 588. Also see J. V. Jones, “On the Determination of the Specific Resistance of Mercury in Absolute Measure,” *Phil. Trans.*, 1891, A, p. 2. Table IV. gives the values of the volume-resistivity of mercury as determined by

¹ The values for nickel and bismuth given in the table are much higher than later values obtained with pure electrolytic nickel and bismuth.

² The value here given, namely 12.885, for the electric mass-resistivity of liquid mercury as determined by Matthiessen is now known to be too high by nearly 1%. The value at present accepted is 12.789 ohms per metre-gramme at 0° C.

TABLE II.—*Electric Volume-Resistivity of Various Metals at 0° C., or Resistance per Centimetre-cube in C.G.S. Units at 0° C.*

Metal.	Volume-Resistivity at 0° C. in C.G.S. Units.
Silver (annealed)	1,502
Silver (hard-drawn)	1,629
Copper (annealed)	1,594
Copper (hard-drawn)	1,630 ¹
Gold (annealed)	2,052
Gold (hard-drawn)	2,090
Aluminium (annealed)	3,006
Zinc (pressed)	5,621
Platinum (annealed)	9,035
Iron (annealed)	10,568
Nickel (annealed)	12,429 ²
Tin (pressed)	13,178
Lead (pressed)	19,580
Antimony (pressed)	35,418
Bismuth (pressed)	130,872
Mercury (liquid)	94,896 ³

various observers, the constant being expressed (a) in terms of the resistance in ohms of a column of mercury one millimetre in cross-section and 100 centimetres in length, taken at 0° C.; and (b) in terms of the length in centimetres of a column of mercury one square millimetre in cross-section taken at 0° C. The result of all the most careful determinations has been to show that the resistivity of pure mercury at 0° C. is about 94,070 C.G.S. electromagnetic units of resistance, and that a column of mercury 106.3 centimetres in length having a cross-sectional area of one square millimetre would have a

TABLE III.—*Electric Volume-Resistivity of Various Metals at 0° C., or Resistance per Centimetre-cube at 0° C. in C.G.S. Units. (Fleming and Dewar, Phil. Mag., September 1893.)*

Metal.	Resistance at 0° C. per Centimetre-cube in C.G.S. Units.	Mean Temperature Coefficient between 0° C. and 100° C.
Silver (electrolytic and well annealed) ⁴	1,468	0.00400
Copper (electrolytic and well annealed) ⁴	1,561	0.00428
Gold (annealed)	2,197	0.00377
Aluminium (annealed)	2,665	0.00435
Magnesium (pressed)	4,355	0.00381
Zinc	5,751	0.00406
Nickel (electrolytic) ⁴	6,935	0.00618
Iron (annealed)	9,065	0.00625
Cadmium	10,023	0.00419
Palladium	10,219	0.00354
Platinum (annealed)	10,917	0.003669
Tin (pressed)	13,048	0.00440
Thallium (pressed)	17,633	0.00398
Lead (pressed)	20,380	0.00411
Bismuth (electrolytic) ⁵	110,000	0.00433

resistance at 0° C. of one international ohm. These values have accordingly been accepted as the official and recognized values for the specific resistance of mercury, and the definition of the ohm. The table also states the methods which have been adopted by the different observers for obtaining the absolute value of the resistance of a known column of mercury, or of a resistance coil afterwards

¹ The value (1630) here given for hard-drawn copper is about $\frac{1}{4}$ % higher than the value now adopted, namely, 1626. The difference is due to the fact that either Jenkin or Matthiessen did not employ precisely the value at present employed for the density of hard-drawn and annealed copper in calculating the volume-resistivities from the mass-resistivities.

² Matthiessen's value for nickel is much greater than that obtained in more recent researches. (See Matthiessen and Vogt, *Phil. Trans.*, 1863, and J. A. Fleming, *Proc. Roy. Soc.*, December 1899.)

³ Matthiessen's value for mercury is nearly 1% greater than the value adopted at present as the mean of the best results, namely 94,070.

⁴ The samples of silver, copper and nickel employed for these tests were prepared electrolytically by Sir J. W. Swan, and were exceedingly pure and soft. The value for volume-resistivity of nickel as given in the above table (from experiments by J. A. Fleming, *Proc. Roy. Soc.*, December 1899) is much less (nearly 40%) than the value given by Matthiessen's researches.

⁵ The electrolytic bismuth here used was prepared by Hartmann and Braun, and the resistivity taken by J. A. Fleming. The value is nearly 20% less than that given by Matthiessen.

TABLE IV.—Determinations of the Absolute Value of the Volume-Resistivity of Mercury and the Mercury Equivalent of the Ohm.

Observer.	Date	Method.	Value of B.A.U. in Ohms.	Value of 100 Centimetres of Mercury in Ohms.	Value of Ohm in Centimetres of Mercury.
Lord Rayleigh	1882	Rotating coil	·98651	·94133	106·31
Lord Rayleigh	1883	Lorenz method	98677	..	106·27
G. Wiedemann	1884	Rotation through 180°			106·19
E. E. N. Mascart	1884	Induced current	·98611	·94096	106·33
H. A. Rowland	1887	Mean of several methods	·98644	·94071	106·32
F. Kohlrausch	1887	Damping of magnets	·98660	·94061	106·32
R. T. Glazebrook	{ 1882 1888	Induced currents	98665	·94074	106·29
Wuilleumeier	1890		·98686	·94077	106·31
Duncan and Wilkes	1890	Lorenz	·98634	·94067	106·34
J. V. Jones	1891	Lorenz	..	·94067	106·31
		Mean value	98653		
Streker	1885	An absolute determination of resistance was not made. The value 98656 has been used		·94056	106·32
Hutchinson	1888			·94074	106·30
E. Salvioni	1890			·94054	106·33
E. Salvioni	..			·94076	106·30
		Mean value		·94076	106·31
H. F. Weber	1884	Induced current			105·37
H. F. Weber	..	Rotating coil	Absolute measurements compared with German silver wire coils issued by Siemens and Streker		106·16
A. Roiti	1884	Mean effect of induced current			105·89
F. Himstedt	1885				105·98
F. E. Dorn	1889	Damping of a magnet			106·24
Wild	1883	Damping of a magnet			106·03
L. V. Lorenz	1885	Lorenz method			105·93

metre long, weighing one gramme which at 60° F. is 0·153858 international ohms." Matthiessen also measured the mass-resistivity of annealed copper, and found that its conductivity is greater than that of hard-drawn copper by about 2·25% to 2·5%. As annealed copper may vary considerably in its state of annealing, and is always somewhat hardened by bending and winding, it is found in practice that the resistivity of commercial annealed copper is about 1½% less than that of hard-drawn copper. The standard now accepted for such copper, on the recommendation of the 1899 Committee, is a wire of pure annealed copper one metre long, weighing one gramme, whose resistance at 0° C. is 1·421 international ohms, or at 60° F., 0·150822 international ohms. The specific gravity of copper varies from about 8·89 to 8·95, and the standard value accepted for high conductivity commercial copper is 8·912, corresponding to a weight of 555 lb per cubic foot at 60° F. Hence the volume-resistivity of pure annealed copper at 0° C. is 1·594 microhms per c.c., or 1594 C.G.S. units, and that of pure hard-drawn copper at 0° C. is 1·626 microhms per c.c., or 1626 C.G.S. units. Since Matthiessen's researches, the most careful scientific investigation on the conductivity of copper is that of T. C. Fitzpatrick, carried out in 1890. (*Brit. Assoc. Report*, 1890, Appendix 3, p. 120.) Fitzpatrick confirmed Matthiessen's chief result, and obtained values for the resistivity of hard-drawn copper which, when corrected for temperature variation, are in entire agreement with those of Matthiessen at the same temperature.

The volume resistivity of alloys is, generally speaking, much higher than that of pure metals. Table V. shows the volume resistivity at 0° C. of a number of well-known alloys, with their chemical composition.

compared with a known column of mercury. A column of figures is added showing the value in fractions of an international ohm of the British Association Unit (B.A.U.), formerly supposed to represent the true ohm. The real value of the B.A.U. is now taken as ·9866 of an international ohm.

For a critical discussion of the methods which have been adopted in the absolute determination of the resistivity of mercury, and the value of the British Association unit of resistance, the reader may be referred to the *British Association Reports* for 1890 and 1892 (*Report of Electrical Standards Committee*), and to the *Electrician*, 25 p. 456, and 29, p. 462. A discussion of the relative value of the results obtained between 1882 and 1890 was given by R. T. Glazebrook in a paper presented to the British Association at Leeds, 1890.

Resistivity of Copper.—In connexion with electro-technical work the determination of the conductivity or resistivity values of annealed and hard-drawn copper wire at standard temperatures is a very important matter. Matthiessen devoted considerable attention to this subject between the years 1860 and 1864 (see *Phil. Trans.*, 1860, p. 150), and since that time much additional work has been carried out. Matthiessen's value, known as *Matthiessen's Standard*, for the mass-resistivity of pure hard-drawn copper wire, is the resistance of a wire of pure hard-drawn copper one metre long and weighing one gramme, and this is equal to 0·14493 international ohms at 0° C. For many purposes it is more convenient to express temperature in Fahrenheit degrees, and the recommendation of the 1899 committee on copper conductors¹ is as follows:—"Matthiessen's standard for hard-drawn conductivity commercial copper shall be considered to be the resistance of a wire of pure hard-drawn copper one

Generally speaking, an alloy having high resistivity has poor mechanical qualities, that is to say, its tensile strength and ductility are small. It is possible to form alloys having a resistivity as high as 100 microhms per cubic centimetre; but, on the other hand, the value of an alloy for electro-technical purposes is judged not merely

TABLE V.—Volume-Resistivity of Alloys of known Composition at 0° C. in C.G.S. Units per Centimetre-cube. Mean Temperature Coefficients taken at 15° C. (Fleming and Dewar.)

Alloys.	Resistivity at 0° C.	Temperature Coefficient at 15° C.	Composition in per cents.
Platinum-silver	31,582	·000243	Pt 33%, Ag 66%
Platinum-iridium	30,896	·000822	Pt 80%, Ir 20%
Platinum-rhodium	21,142	·00143	Pt 90%, Rd 10%
Gold-silver	6,280	·00124	Au 90%, Ag 10%
Manganese-steel	67,148	·00127	Mn 12%, Fe 78%
Nickel-steel	29,452	·00201	Ni 4·35%, remaining percentage chiefly iron, but uncertain
German silver	29,982	·000273	Cu ₈ Zn ₃ Ni ₂
Platinoid ²	41,731	·00031	
Manganin	46,678	·0000	Cu 84%, Mn 12%, Ni 4%
Aluminium-silver	4,641	·00238	Al 94%, Ag 6%
Aluminium-copper	2,904	·00381	Al 94%, Cu 6%
Copper-aluminium	8,847	·000897	Cu 97%, Al 3%
Copper-nickel-aluminium .	14,912	·000645	Cu 87%, Ni 6·5%, Al 6·5%
Titanium-aluminium . . .	3,887	·00290	

¹ In 1899 a committee was formed of representatives from eight of the leading manufacturers of insulated copper cables with delegates from the Post Office and Institution of Electrical Engineers, to consider the question of the values to be assigned to the resistivity of hard-drawn and annealed copper. The sittings of the committee were held in London, the secretary being A. H. Howard. The values given in the above paragraphs are in accordance with the decision of this committee, and its recommendations have been accepted by the General Post Office and the leading manufacturers of insulated copper wire and cables.

by its resistivity, but also by the degree to which its resistivity varies with temperature, and by its capability of being easily drawn into fine wire of not very small tensile strength. Some pure metals when alloyed with a small proportion of another metal do not suffer much

² Platinoid is an alloy introduced by Martino, said to be similar in composition to German silver, but with a little tungsten added. It varies a good deal in composition according to manufacture, and the resistivity of different specimens is not identical. Its electric properties were first made known by J. T. Bottomley, in a paper read at the Royal Society, May 5, 1885.

change in resistivity, but in other cases the resultant alloy has a much higher resistivity. Thus an alloy of pure copper with 3% of aluminium has a resistivity about 5½ times that of copper; but if pure aluminium is alloyed with 6% of copper, the resistivity of the product is not more than 20% greater than that of pure aluminium. The presence of a very small proportion of a non-metallic element in a metallic mass, such as oxygen, sulphur or phosphorus, has a very great effect in increasing the resistivity. Certain metallic elements also have the same power; thus platinumoid has a resistivity 30% greater than German silver, though it differs from it merely in containing a trace of tungsten.

The resistivity of non-metallic conductors is in all cases higher than that of any pure metal. The resistivity of carbon, for instance, in the forms of charcoal or carbonized organic material and graphite, varies from 600 to 6000 microhms per cubic centimetre, as shown in Table VI.:-

TABLE VI.—Electric Volume-Resistivity in Microhms per Centimetre-cube of Various Forms of Carbon at 15° C.

Substance.	Resistivity.
Arc lamp carbon rod	8000
Jablochkoff candle carbon	4000
Carré carbon	3400
Carbonized bamboo	6000
Carbonized parchmentized thread	4000 to 5000
Ordinary carbon filament from glow-lamp "treated" or flashed	2400 to 2500
Deposited or secondary carbon	600 to 900
Graphite	400 to 500

The resistivity of liquids is, generally speaking, much higher than that of any metals, metallic alloys or non-metallic conductors. Thus fused lead chloride, one of the best conducting liquids, has a resistivity in its fused condition of 0.376 ohm per centimetre-cube, or 376,000 microhms per centimetre-cube, whereas that of metallic alloys only in few cases exceeds 100 microhms per centimetre-cube. The resistivity of solutions of metallic salts also varies very largely with the proportion of the diluent or solvent, and in some instances, as in the aqueous solutions of mineral acids, there is a maximum conductivity corresponding to a certain dilution. The resistivity of many liquids, such as alcohol, ether, benzene and pure water, is so high, in other words, their conductivity is so small, that they are practically insulators, and the resistivity can only be appropriately expressed in megohms per centimetre-cube.

In Table VII. are given the names of a few of these badly-conducting liquids, with the values of their volume-resistivity in megohms per centimetre-cube.:-

TABLE VII.—Electric Volume-Resistivity of Various Badly-Conducting Liquids in Megohms per Centimetre-cube.

Substance.	Resistivity in Megohms per c.c.	Observer.
Ethyl alcohol	0.5	Pfeiffer.
Ethyl ether	1.175 to 3.760	W. Kohlrausch.
Benzene	4.700	
Absolutely pure water approximates probably to	25.0 at 18° C.	Value estimated by F. Kohlrausch and A. Heydweiler.
All very dilute aqueous salt solutions having a concentration of about 0.00001 of an equivalent gramme molecule ¹ per litre approximate to	1.00 at 18° C.	From results by F. Kohlrausch and others.

The resistivity of all those substances which are generally called dielectrics or insulators is also so high that it can only be appropriately expressed in millions of megohms per centimetre-cube, or in megohms per quadrant-cube, the quadrant being a cube the side of which is 10³ cms. (see Table VIII.).

Effects of Heat.—Temperature affects the resistivity of these different classes of conductors in different ways. In all cases, so

¹ An equivalent gramme molecule is a weight in grammes equal numerically to the chemical equivalent of the salt. For instance, one equivalent gramme molecule of sodium chloride is a mass of 58.5 grammes. NaCl = 58.5.

far as is yet known, the resistivity of a pure metal is increased if its temperature is raised, and decreased if the temperature is lowered, so that if it could be brought to the absolute zero of temperature (-273° C.) its resistivity would be reduced to a very small fraction of its resistance at ordinary temperatures. With metallic alloys, however, rise of temperature does not always increase resistivity; it sometimes diminishes it, so that many alloys are known which have a maximum resistivity corresponding to a certain temperature, and at or near this point they vary very little in resistance with temperature. Such alloys have, therefore, a negative temperature-variation of resistance at and above fixed temperatures. Prominent amongst these metallic compounds are alloys of iron, manganese, nickel and copper, some of which were discovered by Edward Weston, in the United States. One well-known alloy of copper, manganese and nickel, now called manganin, which was brought to the notice of electricians by the careful investigations made at the Berlin Physikalisch-Technische Reichsanstalt, is characterized by having a zero temperature coefficient at or about a certain temperature in the neighbourhood of 15° C. Hence within a certain range of temperature on either side of this critical value the resistivity of manganin is hardly affected at all by temperature. Similar alloys can be produced from copper and ferro-

TABLE VIII.—Electric Volume-Resistivity of Dielectrics reckoned in Millions of Megohms (Mega-megohms) per Centimetre-cube, and in Megohms per Quadrant-cube, i.e. a Cube whose Side is 10³ cms.

Substance.	Resistivity.		Temperature Cent.
	Mega-megohms per c.c.	Megohms per Quadrant-cube.	
Bohemian glass	61	.061	60°
Mica	84	.084	20°
Gutta-percha	450	.45	24°
Flint glass	1,020	1.02	60°
Glover's vulcanized india-rubber	1,630	1.63	15°
Siemens' ordinary pure vulcanized indiarubber	2,280	2.28	15°
Shellac	9,000	9.0	28°
Indiarubber	10,900	10.9	24°
Siemens' high-insulating fibrous material	11,900	11.9	15°
Siemens' special high-insulating indiarubber	16,170	16.17	15°
Flint glass	20,000	20.0	20°
Ebonite	28,000	28.	46°
Paraffin	34,000	34.	46°

manganese. An alloy formed of 80% copper and 20% manganese in an annealed condition has a nearly zero temperature-variation of resistance between 20° C. and 100° C. In the case of non-metals the action of temperature is generally to diminish the resistivity as temperature rises, though this is not universally so. The interesting observation has been recorded by J. W. Howell, that "treated" carbon filaments and graphite are substances which have a minimum resistance corresponding to a certain temperature approaching red heat (*Electrician*, vol. xxxviii. p. 835). At and beyond this temperature increased heating appears to increase their resistivity; this phenomenon may, however, be accompanied by a molecular change and not be a true temperature variation. In the case of dielectric conductors and of electrolytes, the action of rising temperature is to reduce resistivity. Many of the so-called insulators, such as mica, ebonite, indiarubber, and the insulating oils, paraffin, &c., decrease in resistivity with great rapidity as the temperature rises. With guttapercha a rise in temperature from 0° C. to 24° C. is sufficient to reduce the resistivity of one-twentieth part of its value at 0° C., and the resistivity of flint glass at 140° C. is only one-hundredth of what it is at 60° C.

A definition may here be given of the meaning of the term *Temperature Coefficient*. If, in the first place, we suppose that the resistivity (ρ_1) at any temperature (t) is a simple linear function of the resistivity (ρ_0) at 0° C., then we can write $\rho_1 = \rho_0(1 + at)$, or $a = (\rho_1 - \rho_0)/\rho_0 t$. The quantity a is then called the temperature-coefficient, and its reciprocal is the temperature at which the resistivity would become

zero. By an extension of this notion we can call the quantity $\frac{d\rho}{\rho dt}$ the temperature coefficient corresponding to any temperature t at which the resistivity is ρ . In all cases the relation between the resistivity of a substance and the temperature is best set out in the form of a curve called a temperature-resistance curve. If a series of such curves are drawn for various pure metals, temperature being taken as abscissa and resistance as ordinate, and if the temperature range extends from the absolute zero of temperature upwards, then it is found that these temperature-resistance lines are curved lines having their convexity either upwards or downwards. In other words, the second differential coefficient of resistance with respect to temperature is either a positive or negative quantity. An extensive series of observations concerning the form of the resistivity curves for various pure metals over a range of temperature extending from -200° C. to $+200^{\circ}$ C. was carried out in 1892 and 1893 by Fleming and Dewar (*Phil. Mag.* Oct. 1892 and Sept. 1893). The resistance observations were taken with resistance coils constructed with wires of various metals obtained in a state of great chemical purity. The lengths and mean diameters of the wires were carefully measured, and their resistance was then taken at certain known temperatures obtained by immersing the coils in boiling aniline, boiling water, melting ice, melting carbonic acid in ether, and boiling liquid oxygen, the temperatures thus given being $+184^{\circ}.5$ C., $+100^{\circ}$ C., 0° C., $-78^{\circ}.2$ C. and $-182^{\circ}.5$ C. The resistivities of the various metals were then calculated and set out in terms of the temperature. From these data a chart was prepared showing the temperature-resistance curves of these metals throughout a range of 400 degrees. The exact form of these curves through the region of temperature lying between -200° C. and -273° C. is not yet known. As shown on the chart, the curves evidently do not converge to precisely the same point. It is, however, much less probable that the resistance of any metal should vanish at a temperature above the absolute zero than at the absolute zero itself, and the precise path of these curves at their lower ends cannot be delineated until means are found for fixing independently the temperature of some regions in which the resistance of metallic wires can be measured. Sir J. Dewar subsequently showed that for certain pure metals it is clear that the resistance would not vanish at the absolute zero but would be reduced to a finite but small value (see "Electric Resistance Thermometry at the Temperature of Boiling Hydrogen," *Proc. Roy. Soc.* 1904, 73, p. 244).

The resistivity curves of the magnetic metals are also remarkable for the change of curvature they exhibit at the magnetic critical temperature. Thus J. Hopkinson and D. K. Morris (*Phil. Mag.* September 1897, p. 213) observed the remarkable alteration that takes place in the iron resistance temperature curve in the neighbourhood of 780° C. At that temperature the direction of the curvature of the curve changes so that it becomes convex upwards instead of convex downwards, and in addition the value of the temperature coefficient undergoes a great reduction. The mean temperature coefficient of iron in the neighbourhood of 0° C. is 0.0057; at 765° C. it rises to a maximum value 0.0204; but at 1000° C. it falls again to a lower value, 0.00244. A similar rise to a maximum value and subsequent fall are also noted in the case of the specific heat of iron. The changes in the curvature of the resistivity curves are undoubtedly connected with the molecular changes that occur in the magnetic metals at their critical temperatures.

A fact of considerable interest in connexion with resistivity is the influence exerted by a strong magnetic field in the case of some metals, notably bismuth. It was discovered by A. Righi and confirmed by S. A. Leduc (*Journ. de Phys.* 1886, 5, p. 116, and 1887, 6, p. 189) that if a pure bismuth wire is placed in a magnetic field transversely to the direction of the magnetic field, its resistance is considerably increased. This increase is greatly affected by the temperature of the metal (Dewar and Fleming, *Proc. Roy. Soc.* 1897, 60, p. 427). The temperature coefficient of pure copper is an important constant, and its value as determined by Messrs Clark, Forde and Taylor in terms of Fahrenheit temperature is

$$\rho_t = \rho_{32} \{1 + 0.0023708(t - 32) + 0.0000034548(t - 32)^2\}.$$

Time Effects.—In the case of dielectric conductors, commonly called insulators, such as indiarubber, guttapercha, glass and mica, the electric resistivity is not only a function of the temperature but also of the time during which the electromotive force employed to measure it is imposed. Thus if an indiarubber-covered cable is immersed in water and the resistance of the dielectric between the copper conductor and the water measured by ascertaining the current which can be caused to flow through it by an electromotive force, this current is found to vary very rapidly with the time during which the electromotive force is applied. Apart from the small initial effect due to the electrostatic capacity of the cable, the application of an electromotive force to the dielectric produces a current through it which rapidly falls in value, as if the electric resistance of the dielectric were increasing. The current, however, does not fall continuously but tends to a limiting value, and it appears that if the

electromotive force is kept applied to the cable for a prolonged time, a small and nearly constant current will ultimately be found flowing through it. It is customary in electro-technical work to consider the resistivity of the dielectric as the value it has after the electromotive force has been applied for one minute, the standard temperature being 75° F. This, however, is a purely conventional proceeding, and the number so obtained does not necessarily represent the true or ohmic resistance of the dielectric. If the electromotive force is increased, in the case of a large number of ordinary dielectrics the apparent resistance at the end of one minute's electrification decreases as the electromotive force increases.

Practical Standards.—The practical measurement of resistivity involves many processes and instruments (see WHEATSTONE'S BRIDGE and OHMMETER). Broadly speaking, the processes are divided into *Comparison Methods* and *Absolute Methods*. In the former a comparison is effected between the resistance of a material in a known form and some standard resistance. In the *Absolute Methods* the resistivity is determined without reference to any other substance, but with reference only to the fundamental standards of length, mass and time. Immense labour has been expended in investigations concerned with the production of a standard of resistance and its evaluation in absolute measure. In some cases the absolute standard is constructed by filling a carefully-calibrated tube of glass with mercury, in order to realize in a material form the official definition of the ohm; in this manner most of the principal national physical laboratories have been provided with standard mercury ohms. (For a full description of the standard mercury ohm of the Berlin Physikalisch-Technische Reichsanstalt, see the *Electrician*, xxxvii. 569.) For practical purposes it is more convenient to employ a standard of resistance made of wire.

Opinion is not yet perfectly settled on the question whether a wire made of any alloy can be considered to be a perfectly unalterable standard of resistance, but experience has shown that a platinum-silver alloy (66% silver, 33% platinum), and also the alloy called manganin, seem to possess the qualities of permanence essential for a wire-resistance standard. A comparison made in 1892 and 1894 of all the manganin wire copies of the ohm made at the Reichsanstalt in Berlin, showed that these standards had remained constant for two years to within one or two parts in 100,000. It appears, however, that in order that manganin may remain constant in resistivity when used in the manufacture of a resistance coil, it is necessary that the alloy should be aged by heating it to a temperature of 140° C. for ten hours; and to prevent subsequent changes in resistivity, solders containing zinc must be avoided, and a silver solder containing 75% of silver employed in soldering the manganin wire to its connexions.

The authorities of the Berlin Reichsanstalt have devoted considerable attention to the question of the best form for a wire standard of electric resistance. In that now adopted the resistance wire is carefully insulated and wound on a brass cylinder, being doubled on itself to annul inductance as much as possible. In the coil two wires are wound on in parallel, one being much finer than the other, and the final adjustment of the coil to an exact value is made by shortening the finer of the two. A standard of resistance for use in a laboratory now generally consists of a wire of manganin or platinum-silver carefully insulated and enclosed in a brass case. Thick copper rods are connected to the terminals of the wire in the interior of the case, and brought to the outside, being carefully insulated at the same time from one another and from the case. The coil so constructed can be placed under water or paraffin oil, the temperature of which can be exactly observed during the process of taking a resistance measurement. Equalization of the temperature of the surrounding medium is effected by the employment of a stirrer, worked by hand or by a small electric motor. The construction of a standard of electrical resistance consisting of mercury in a glass tube is an operation requiring considerable precautions, and only to be undertaken by those experienced in the matter. Opinions are divided on the question whether greater permanence in resistance can be secured by mercury-in-glass standards of resistance or by wire standards, but the latter are at least more portable and less fragile.

A full description of the construction of a standard wire-resistance coil on the plan adopted by the Berlin Physikalisch-Technische

Reichsanstalt is given in the Report of the British Association Committee on Electrical Standards, presented at the Edinburgh Meeting in 1892. For the design and construction of standards of electric resistances adapted for employment in the comparison and measurement of very low or very high resistances, the reader may be referred to standard treatises on electric measurements.

BIBLIOGRAPHY.—See also J. A. Fleming, *A Handbook for the Electrical Laboratory and Testing Room*, vol. i. (London, 1901); *Reports of the British Association Committee on Electrical Standards*, edited by Fleeming Jenkin (London, 1873); A. Matthiessen and C. Vogt, "On the Influence of Temperature on the Conducting Power of Alloys," *Phil. Trans.*, 1864, 154, p. 167, and *Phil. Mag.*, 1865, 29, p. 363; A. Matthiessen and M. Holtzmann, "On the Effect of the Presence of Metals and Metalloids upon the Electric Conducting Power of Pure Copper," *Phil. Trans.*, 1860, 150, p. 85; T. C. Fitzpatrick, "On the Specific Resistance of Copper," *Brit. Assoc. Report*, 1890, p. 120, or *Electrician*, 1890, 25, p. 608; R. Appleyard, *The Conductometer and Electrical Conductivity*; Clark, Forde and Taylor, *Temperature Coefficients of Copper* (London, 1901). (J. A. F.)

II. CONDUCTION IN LIQUIDS

Through liquid metals, such as mercury at ordinary temperatures and other metals at temperatures above their melting points, the electric current flows as in solid metals without changing the state of the conductor, except in so far as heat is developed by the electric resistance. But another class of liquid conductors exists, and in them the phenomena are quite different. The conductivity of fused salts, and of solutions of salts and acids, although less than that of metals, is very great compared with the traces of conductivity found in so-called non-conductors. In fused salts and conducting solutions the passage of the current is always accompanied by definite chemical changes; the substance of the conductor or electrolyte is decomposed, and the products of the decomposition appear at the electrodes, *i.e.* the metallic plates by means of which the current is led into and out of the solution. The chemical phenomena are considered in the article **ELECTROLYSIS**; we are here concerned solely with the mechanism of this *electrolytic* conduction of the current.

To explain the appearance of the products of decomposition at the electrodes only, while the intervening solution is unaltered, we suppose that, under the action of the electric forces, the opposite parts of the electrolyte move in opposite directions through the liquid. These opposite parts, named ions by Faraday, must therefore be associated with electric charges, and it is the convective movement of the opposite streams of ions carrying their charges with them that, on this view, constitutes the electric current.

In metallic conduction it is found that the current is proportional to the applied electromotive force—a relation known by the name of Ohm's law. If we place in a circuit with a small electromotive force an electrolytic cell consisting of two platinum electrodes and a solution, the initial current soon dies away, and we shall find that a certain minimum electromotive force must be applied to the circuit before any considerable permanent current passes. The chemical changes which are initiated on the surfaces of the electrodes set up a reverse electromotive force of polarization, and, until this is overcome, only a minute current, probably due to the slow but steady removal of the products of decomposition from the electrodes by a process of diffusion, will pass through the cell. Thus it is evident that, considering the electrolytic cell as a whole, the passage of the current through it cannot conform to Ohm's law. But the polarization is due to chemical changes, which are confined to the surfaces of the electrodes; and it is necessary to inquire whether, if the polarization at the electrodes be eliminated, the passage of the current through the bulk of the solution itself is proportional to the electromotive force actually applied to that solution. Rough experiment shows that the current is proportional to the excess of the electromotive force over a constant value, and thus verifies the law approximately, the constant electromotive force to be overcome being a measure of the polarization. A more satisfactory examination of the question was made by F. Kohlrausch in the years 1873 to 1876. Ohm's law states that the current C is proportional to the electromotive force E , or $C = kE$, where k is a constant called the conductivity of the circuit. The equation

may also be written as $C = E/R$, where R is a constant, the reciprocal of k , known as the resistance of the circuit. The essence of the law is the proportionality between C and E , which means that the ratio E/C is a constant. But $E/C = R$, and thus the law may be tested by examining the constancy of the measured resistance of a conductor when different currents are passing through it. In this way Ohm's law has been confirmed in the case of metallic conduction to a very high degree of accuracy. A similar principle was applied by Kohlrausch to the case of electrolytes, and he was the first to show that an electrolyte possesses a definite resistance which has a constant value when measured with different currents and by different experimental methods.

Measurement of the Resistance of Electrolytes.—There are two effects of the passage of an electric current which prevent the possibility of measuring electrolytic resistance by the ordinary methods with the direct currents which are used in the case of metals. The products of the chemical decomposition of the electrolyte appear at the electrodes and set up the opposing electromotive force of polarization, and unequal dilution of the solution may occur in the neighbourhood of the two electrodes. The chemical and electrolytic aspects of these phenomena are treated in the article **ELECTROLYSIS**, but from our present point of view also it is evident that they are again of fundamental importance. The polarization at the surface of the electrodes will set up an opposing electromotive force, and the unequal dilution of the solution will turn the electrolyte into a concentration cell and produce a subsidiary electromotive force either in the same direction as that applied or in the reverse according as the anode or the cathode solution becomes the more dilute. Both effects thus involve internal electromotive forces, and prevent the application of Ohm's law to the electrolytic cell as a whole. But the existence of a definite measurable resistance as a characteristic property of the system depends on the conformity of the system to Ohm's law, and it is therefore necessary to eliminate both these effects before attempting to measure the resistance.

The usual and most satisfactory method of measuring the resistance of electrolytes consists in eliminating the effects of polarization by the use of alternating currents, that is, currents that are reversed in direction many times a second.¹ The chemical action produced by the first current is thus reversed by the second current in the opposite direction, and the polarization caused by the first current on the surface of the electrodes is destroyed before it rises to an appreciable value. The polarization is also diminished in another way. The electromotive force of polarization is due to the deposition of films of the products of chemical decomposition on the surface of the electrodes, and only reaches its full value when a continuous film is formed. If the current be stopped before such a film is completed, the reverse electromotive force is less than its full value. A given current flowing for a given time deposits a definite amount of substance on the electrodes, and therefore the amount per unit area is inversely proportional to the area of the electrodes—to the area of contact, that is, between the electrode and the liquid. Thus, by increasing the area of the electrodes, the polarization due to a given current is decreased. Now the area of free surface of a platinum plate can be increased enormously by coating the plate with platinum black, which is metallic platinum in a spongy state, and with such a plate as electrode the effects of polarization are diminished to a very marked extent. The coating is effected by passing an electric current first one way and then the other between two platinum plates immersed in a 3% solution of platinum chloride to which a trace of lead acetate is sometimes added. The platinized plates thus obtained are quite satisfactory for the investigation of strong solutions. They have the power, however, of absorbing a certain amount of salt from the solutions and of giving it up again when water or more dilute solution is placed in contact with them. The measurement of very dilute solutions is thus made difficult, but, if the plates be heated to

¹ F. Kohlrausch and L. Holborn, *Das Leitvermögen der Elektrolyte* (Leipzig, 1898).

redness after being platinized, a grey surface is obtained which possesses sufficient area for use with dilute solutions and yet does not absorb an appreciable quantity of salt.

Any convenient source of alternating current may be used. The currents from the secondary circuit of a small induction coil are satisfactory, or the currents of an alternating electric light supply may be transformed down to an electromotive force of one or two volts. With such currents it is necessary to consider the effects of self-induction in the circuit and of electrostatic capacity. In balancing the resistance of the electrolyte, resistance coils may be used in which self-induction and the capacity are reduced to a minimum by winding the wire of the coil backwards and forwards in alternate layers.

With these arrangements the usual method of measuring resistance by means of Wheatstone's bridge may be adapted to the case of electrolytes. With alternating currents, however, it is impossible to use a galvanometer in the usual way. The galvanometer was therefore replaced by Kohlrausch by a

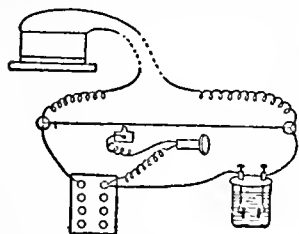

FIG. 1.

telephone, which gives a sound when an alternating current passes through it. The most common plan of the apparatus is shown diagrammatically in fig. 1. The electrolytic cell and a resistance box form two arms of the bridge, and the sliding contact is moved along the metre wire which forms the other two arms till no sound is heard in the telephone.

The resistance of the electrolyte is to that of the box as that of the right-hand end of the wire is to that of the left-hand end. A more accurate method of using alternating currents, and one more pleasant to use, gets rid of the telephone (*Phil. Trans.*, 1900, 194, p. 321). The current from one or two voltaic cells is led to an ebonite drum turned by a motor or a hand-wheel and cord. On the drum are fixed brass strips with wire brushes touching them in such a manner that the current from the brushes is reversed several times in each revolution of the drum. The wires from the brushes are connected with the Wheatstone's bridge. A moving coil galvanometer is used as indicator, its connexions being reversed in time with those of the battery by a slightly narrower set of brass strips fixed on the other end of the ebonite commutator. Thus any residual current through the galvanometer is direct and not alternating. The high moment of inertia of the coil makes the period of swing slow compared with the period of alternation of the current, and the slight periodic disturbances are thus prevented from affecting the galvanometer. When the measured resistance is not altered by increasing the speed of the commutator or changing the ratio of the arms of the bridge, the disturbing effects may be considered to be eliminated.

The form of vessel chosen to contain the electrolyte depends on the order of resistance to be measured. For dilute solutions

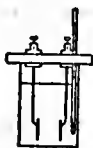

FIG. 2.

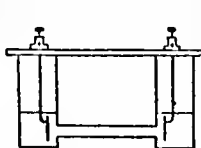

FIG. 3.

the shape of cell shown in fig. 2 will be found convenient, while for more concentrated solutions, that indicated in fig. 3 is suitable. The absolute resistances of certain solutions have been determined by Kohlrausch by comparison

with mercury, and, by using one of these solutions in any cell, the constant of that cell may be found once for all. From the observed resistance of any given solution in the cell the resistance of a centimetre cube—the so-called specific resistance—may be calculated. The reciprocal of this, or the conductivity, is a more generally useful constant; it is conveniently expressed in terms of a unit equal to the reciprocal of an ohm. Thus Kohlrausch found that a solution of potassium chloride, containing one-tenth of a gram equivalent (7.46 grams) per litre, has at 18° C. a specific resistance of 89.37 ohms per centimetre cube, or a conductivity of 1.119×10^{-2}

ohms or 1.119×10^{-11} C.G.S. units. As the temperature variation of conductivity is large, usually about 2% per degree, it is necessary to place the resistance cell in a paraffin or water bath, and to observe its temperature with some accuracy.

Another way of eliminating the effects of polarization and of dilution has been used by W. Stroud and J. B. Henderson (*Phil. Mag.*, 1897 [5], 43, p. 19). Two of the arms of a Wheatstone's bridge are composed of narrow tubes filled with the solution, the tubes being of equal diameter but of different length. The other two arms are made of coils of wire of equal resistance, and metallic resistance is added to the shorter tube till the bridge is balanced. Direct currents of somewhat high electromotive force are used to work the bridge. Equal currents then flow through the two tubes; the effects of polarization and dilution must be the same in each, and the resistance added to the shorter tube must be equal to the resistance of a column of liquid the length of which is equal to the difference in length of the two tubes.

A somewhat different principle was adopted by E. Bouty in 1884. If a current be passed through two resistances in series by means of an applied electromotive force, the electric potential falls from one end of the resistances to the other, and, if we apply Ohm's law to each resistance in succession, we see that, since for each of them $E = CR$, and C the current is the same through both, E the electromotive force or fall of potential between the ends of each resistance must be proportional to the resistance between them. Thus by measuring the potential difference between the ends of the two resistances successively, we may compare their resistances. If, on the other hand, we can measure the potential difference in some known units, and similarly measure the current flowing, we can determine the resistance of a single electrolyte. The details of the apparatus may vary, but its principle is illustrated in the following description. A narrow glass tube is fixed horizontally into side openings in two glass vessels, and an electric current passed through it by means of platinum electrodes and a battery of considerable electromotive force. In this way a steady fall of electric potential is set up along the length of the tube. To measure the potential difference between the ends of the tube, tapping electrodes are constructed, e.g. by placing zinc rods in vessels with zinc sulphate solution and connecting these vessels (by means of thin siphon tubes also filled with solution) with the vessels at the ends of the long tube which contains the electrolyte to be examined. Whatever be the contact potential difference between zinc and its solution, it is the same at both ends, and thus the potential difference between the zinc rods is equal to that between the liquid at the two ends of the tube. This potential difference may be measured without passing any appreciable current through the tapping electrodes, and thus the resistance of the liquid deduced.

Equivalent Conductivity of Solutions.—As is the case in the other properties of solutions, the phenomena are much more simple when the concentration is small than when it is great, and a study of dilute solutions is therefore the best way of getting an insight into the essential principles of the subject. The foundation of our knowledge was laid by Kohlrausch when he had developed the method of measuring electrolyte resistance described above. He expressed his results in terms of "equivalent conductivity," that is, the conductivity (k) of the solution divided by the number (m) of gram-equivalents of electrolyte per litre. He finds that, as the concentration diminishes, the value of k/m approaches a limit, and eventually becomes constant, that is to say, at great dilution the conductivity is proportional to the concentration. Kohlrausch first prepared very pure water by repeated distillation and found that its resistance continually increased as the process of purification proceeded. The conductivity of the water, and of the slight impurities which must always remain, was subtracted from that of the solution made with it, and the result, divided by m , gave the equivalent conductivity of the substance dissolved. This procedure appears justifiable, for as long as conductivity is proportional to concentration it is evident that each part of the dissolved matter produces its own independent effect, so that the total conductivity is the sum of the conductivities of the parts;

when this ceases to hold, the concentration of the solution has in general become so great that the conductivity of the solvent may be neglected. The general result of these experiments can be represented graphically by plotting k/m as ordinates and $\sqrt[3]{m}$ as abscissae, $\sqrt[3]{m}$ being a number proportional to the reciprocal of the average distance between the molecules, to which it seems likely that the molecular conductivity may be related. The general types of curve for a simple neutral salt like potassium or sodium chloride and for a caustic alkali or acid are shown in fig. 4. The curve for the neutral salt comes to a limiting value; that for the acid attains a maximum at a certain very small concentration,

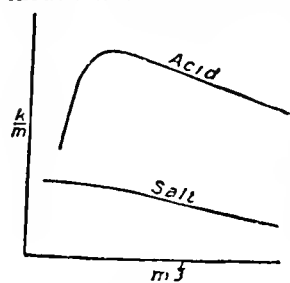

FIG. 4.

and falls again when the dilution is carried farther. It has usually been considered that this destruction of conductivity is due to chemical action between the acid and the residual impurities in the water. At such great dilution these impurities are present in quantities comparable with the amount of acid which they convert into a less highly conducting neutral salt. In the case of acids, then, the maximum must be taken as the limiting

value. The decrease in equivalent conductivity at great dilution is, however, so constant that this explanation seems insufficient. The true cause of the phenomenon may perhaps be connected with the fact that the bodies in which it occurs, acids and alkalis, contain the ions, hydrogen in the one case, hydroxyl in the other, which are present in the solvent, water, and have, perhaps because of this relation, velocities higher than those of any other ions. The values of the molecular conductivities of all neutral salts are, at great dilution, of the same order of magnitude, while those of acids at their maxima are about three times as large. The influence of increasing concentration is greater in the case of salts containing divalent ions, and greatest of all in such cases as solutions of ammonia and acetic acid, which are substances of very low conductivity.

Theory of Moving Ions.—Kohlrausch found that, when the polarization at the electrodes was eliminated, the resistance of a solution was constant however determined, and thus established Ohm's Law for electrolytes. The law was confirmed in the case of strong currents by G. F. Fitzgerald and F. T. Trouton (*B.A. Report*, 1886, p. 312). Now, Ohm's Law implies that no work is done by the current in overcoming reversible electromotive forces such as those of polarization. Thus the molecular interchange of ions, which must occur in order that the products may be able to work their way through the liquid and appear at the electrodes, continues throughout the solution whether a current is flowing or not. The influence of the current on the ions is merely directive, and, when it flows, streams of electrified ions travel in opposite directions, and, if the applied electromotive force is enough to overcome the local polarization, give up their charges to the electrodes. We may therefore represent the facts by considering the process of electrolysis to be a kind of convection. Faraday's classical experiments proved that when a current flows through an electrolyte the quantity of substance liberated at each electrode is proportional to its chemical equivalent weight, and to the total amount of electricity passed. Accurate determinations have since shown that the mass of an ion deposited by one electromagnetic unit of electricity, *i.e.* its electrochemical equivalent, is 1.036×10^{-4} times its chemical equivalent weight. Thus the amount of electricity associated with one gram-equivalent of any ion is $10^4/1.036 = 9653$ units. Each monovalent ion must therefore be associated with a certain definite charge, which we may take to be a natural unit of electricity; a divalent ion carries two such units, and so on. A cation, *i.e.* an ion giving up its charge at the cathode, as the electrode at which the current leaves the solution is called, carries a positive charge of electricity; an anion, travelling in the opposite direction, carries a negative charge. It will now be seen that the quantity of electricity flowing per second, *i.e.* the current

through the solution, depends on (1) the number of the ions concerned, (2) the charge on each ion, and (3) the velocity with which the ions travel past each other. Now, the number of ions is given by the concentration of the solution, for even if all the ions are not actively engaged in carrying the current at the same instant, they must, on any dynamical idea of chemical equilibrium, be all active in turn. The charge on each, as we have seen, can be expressed in absolute units, and therefore the velocity with which they move past each other can be calculated. This was first done by Kohlrausch (*Göttingen Nachrichten*, 1876, p. 213, and *Das Leitvermögen der Elektrolyte*, Leipzig, 1898) about 1879.

In order to develop Kohlrausch's theory, let us take, as an example, the case of an aqueous solution of potassium chloride, of concentration n gram-equivalents per cubic centimetre. There will then be n gram-equivalents of potassium ions and the same number of chlorine ions in this volume. Let us suppose that on each gram-equivalent of potassium there reside $+e$ units of electricity, and on each gram-equivalent of chlorine ions $-e$ units. If u denotes the average velocity of the potassium ions, the positive charge carried per second across unit area normal to the flow is $ne u$. Similarly, if v be the average velocity of the chlorine ions, the negative charge carried in the opposite direction is $ne v$. But positive electricity moving in one direction is equivalent to negative electricity moving in the other, so that, before changes in concentration sensibly supervene, the total current, C , is $ne(u+v)$. Now let us consider the amounts of potassium and chlorine liberated at the electrodes by this current. At the cathode, if the chlorine ions were at rest, the excess of potassium ions would be simply those arriving in one second, namely, nu . But since the chlorine ions move also, a further separation occurs, and nv potassium ions are left without partners. The total number of gram-equivalents liberated is therefore $n(u+v)$. By Faraday's law, the number of grams liberated is equal to the product of the current and the electrochemical equivalent of the ion; the number of gram-equivalents therefore must be equal to ηC , where η denotes the electrochemical equivalent of hydrogen in C.G.S. units. Thus we get

$$n(u+v) = \eta C = \eta ne(u+v),$$

and it follows that the charge, e , on 1 gram-equivalent of each kind of ion is equal to $1/\eta$. We know that Ohm's Law holds good for electrolytes, so that the current C is also given by $k dP/dx$, where k denotes the conductivity of the solution, and dP/dx the potential gradient, *i.e.* the change in potential per unit length along the lines of current flow. Thus

$$\frac{n}{\eta}(u+v) = k dP/dx;$$

therefore

$$u+v = \eta \frac{k dP}{n dx}$$

Now η is 1.036×10^{-4} , and the concentration of a solution is usually expressed in terms of the number, m , of gram-equivalents per litre instead of per cubic centimetre. Therefore

$$u+v = 1.036 \times 10^{-4} \frac{k dP}{m dx}.$$

When the potential gradient is one volt (10^8 C.G.S. units) per centimetre this becomes

$$u+v = 1.036 \times 10^{-7} \times k/m.$$

Thus by measuring the value of k/m , which is known as the equivalent conductivity of the solution, we can find $u+v$, the velocity of the ions relative to each other. For instance, the equivalent conductivity of a solution of potassium chloride containing one-tenth of a gram-equivalent per litre is 1119×10^{-13} C.G.S. units at 18° C. Therefore

$$u+v = 1.036 \times 10^7 \times 1119 \times 10^{-13} \\ = 1.159 \times 10^{-3} = 0.001159 \text{ cm. per sec.}$$

In order to obtain the absolute velocities u and v , we must find some other relation between them. Let us resolve u into $\frac{1}{2}(u+v)$ in one direction, say to the right, and $\frac{1}{2}(u-v)$ to the left. Similarly v can be resolved into $\frac{1}{2}(v+u)$ to the left and $\frac{1}{2}(v-u)$ to the right. On pairing these velocities we have a combined movement of the ions to the right, with a speed of $\frac{1}{2}(u-v)$ and a drift right and left, past each other, each ion travelling with a speed of $\frac{1}{2}(u+v)$, constituting the electrolytic separation. If u is greater than v , the combined movement involves a concentration of salt at the cathode, and a corresponding dilution at the anode, and *vice versa*. The rate at which salt is electrolysed; and thus removed from the solution at each electrode, is $\frac{1}{2}(u+v)$. Thus the total loss of salt at the cathode is $\frac{1}{2}(u+v) - \frac{1}{2}(u-v)$ or v , and at the anode, $\frac{1}{2}(v+u) - \frac{1}{2}(v-u)$, or u . Therefore, as is explained in the article ELECTROLYSIS, by measuring the dilution of the liquid round the electrodes when a current passed, W. Hittorf (*Pogg. Ann.*, 1853-1859, 89, p. 177; 98, p. 1; 103, p. 1; 106, pp. 337 and 513) was able to deduce the ratio of the two velocities for simple salts when no complex ions are present, and many further

experiments have been made on the subject (see *Das Leitvermögen der Elektrolyte*).

By combining the results thus obtained with the sum of the velocities, as determined from the conductivities, Kohlrausch calculated the absolute velocities of different ions under stated conditions. Thus, in the case of the solution of potassium chloride considered above, Hittorf's experiments show us that the ratio of the velocity of the anion to that of the cation in this solution is .51 : .49. The absolute velocity of the potassium ion under unit potential gradient is therefore 0.000567 cm. per sec., and that of the chlorine ion 0.000592 cm. per sec. Similar calculations can be made for solutions of other concentrations, and of different substances.

Table IX. shows Kohlrausch's values for the ionic velocities of three chlorides of alkali metals at 18° C., calculated for a potential gradient of 1 volt per cm.; the numbers are in terms of a unit equal to 10⁻⁶ cm. per sec.:-

TABLE IX.

m	KCl			NaCl			LiCl		
	u+v	u	v	u+v	u	v	u+v	u'	v
0	1350	660	690	1140	450	690	1050	360	690
0.0001	1335	654	681	1129	448	681	1037	356	681
.001	1313	643	670	1110	440	670	1013	343	670
.01	1263	619	644	1059	415	644	962	318	644
.03	1218	597	621	1013	390	623	917	298	619
.1	1153	564	589	952	360	592	853	259	594
.3	1088	531	557	876	324	552	774	217	557
1.0	1011	491	520	765	278	487	651	169	482
3.0	911	442	469	582	206	376	463	115	348
5.0				438	153	285	334	80	254
10.0							117	25	92

These numbers show clearly that there is an increase in ionic velocity as the dilution proceeds. Moreover, if we compare the values for the chlorine ion obtained from observations on these three different salts, we see that as the concentrations diminish the velocity of the chlorine ion becomes the same in all of them. A similar relation appears in other cases, and, in general, we may say that at great dilution the velocity of an ion is independent of the nature of the other ion present. This introduces the conception of specific ionic velocities, for which some values at 18° C. are given by Kohlrausch in Table X.:-

TABLE X.

K	. 66 × 10 ⁻⁵ cms. per sec.	Cl	. 69 × 10 ⁻⁵ cms. per sec.
Na	. 45 " "	I	. 69 " "
Li	. 36 " "	NO ₃	. 64 " "
NH ₄	. 66 " "	OH	. 162 " "
H	. 320 " "	C ₂ H ₃ O ₂	. 36 " "
Ag	. 57 " "	C ₃ H ₃ O ₂	. 33 " "

Having obtained these numbers we can deduce the conductivity of the dilute solution of any salt, and the comparison of the calculated with the observed values furnished the first confirmation of Kohlrausch's theory. Some exceptions, however, are known. Thus acetic acid and ammonia give solutions of much lower conductivity than is indicated by the sum of the specific ionic velocities of their ions as determined from other compounds. An attempt to find in Kohlrausch's theory some explanation of this discrepancy shows that it could be due to one of two causes. Either the velocities of the ions must be much less in these solutions than in others, or else only a fractional part of the number of molecules present can be actively concerned in conveying the current. We shall return to this point later.

Friction on the Ions.-It is interesting to calculate the magnitude of the forces required to drive the ions with a certain velocity. If we have a potential gradient of 1 volt per centimetre the electric force is 10⁸ in C.G.S. units. The charge of electricity on 1 gram-equivalent of any ion is 1/0001036 = 9653 units, hence the mechanical force acting on this mass is 9653 × 10⁸ dynes. This, let us say, produces a velocity *u*; then the force required to produce unit velocity is $P_A = \frac{9.653 \times 10^{11}}{u}$ dynes = $\frac{9.84 \times 10^6}{u}$ kilograms-weight. If the ion have an equivalent weight *A*, the force producing unit velocity when acting on 1 gram is $P_1 = 9.84 \times \frac{10^6}{Au}$ kilograms-weight. Thus the aggregate force required to drive 1 gram of potassium ions with

a velocity of 1 centimetre per second through a very dilute solution must be equal to the weight of 38 million kilograms.

TABLE XI.

	Kilograms-weight.		Kilograms-weight.	
	P _A	P ₁	P _A	P ₁
K	15 × 10 ⁸	38 × 10 ⁶	Cl	14 × 10 ⁸ 40 × 10 ⁶
Na	22 " 95 "	I	14 " 11 "	
Li	27 " 390 "	NO ₃	15 " 25 "	
NH ₄	15 " 83 "	OH	5.4 " 32 "	
H	3.1 " 310 "	C ₂ H ₃ O ₂	27 " 46 "	
Ag	17 " 16 "	C ₃ H ₃ O ₂	30 " 41 "	

Since the ions move with uniform velocity, the frictional resistances brought into play must be equal and opposite to the driving forces, and therefore these numbers also represent the ionic friction coefficients in very dilute solutions at 18° C.

Direct Measurement of Ionic Velocities.-Sir Oliver Lodge was the first to directly measure the velocity of an ion (*B.A. Report*, 1886, p. 389). In a horizontal glass tube connecting two vessels filled with dilute sulphuric acid he placed a solution of sodium chloride in solid agar-agar jelly. This solid solution was made alkaline with a trace of caustic soda in order to bring out the red colour of a little phenol-phthalein added as indicator. An electric current was then passed from one vessel to the other. The hydrogen ions from the anode vessel of acid were thus carried along the tube, and, as they travelled, decolourized the phenol-phthalein. By this method the velocity of the hydrogen ion through a jelly solution under a known potential gradient was observed to about 0.0026 cm. per sec., a number of the same order as that required by Kohlrausch's theory. Direct determinations of the velocities of a few other ions have been made by W. C. D. Whetham (*Phil. Trans.* vol. 184, A, p. 337; vol. 186, A, p. 507; *Phil. Mag.*, October 1894). Two solutions having one ion in common, of equivalent concentrations, different densities, different colours, and nearly equal specific resistances, were placed one over the other in a vertical glass tube. In one case, for example, decinormal solutions of potassium carbonate and potassium bichromate were used. The colour of the latter is due to the presence of the bichromate group, Cr₂O₇. When a current was passed across the junction, the anions CO₃ and Cr₂O₇ travelled in the direction opposite to that of the current, and their velocity could be determined by measuring the rate at which the colour boundary moved. Similar experiments were made with alcoholic solutions of cobalt salts, in which the velocities of the ions were found to be much less than in water. The behaviour of agar jelly was then investigated, and the velocity of an ion through a solid jelly was shown to be very little less than in an ordinary liquid solution. The velocities could therefore be measured by tracing the change in colour of an indicator or the formation of a precipitate. Thus decinormal jelly solutions of barium chloride and sodium chloride, the latter containing a trace of sodium sulphate, were placed in contact. Under the influence of an electromotive force the barium ions moved up the tube, disclosing their presence by the trace of insoluble barium sulphate formed. Again, a measurement of the velocity of the hydrogen ion, when travelling through the solution of an acetate, showed that its velocity was then only about the one-fortieth part of that found during its passage through chlorides. From this, as from the measurements on alcohol solutions, it is clear that where the equivalent conductivities are very low the effective velocities of the ions are reduced in the same proportion.

Another series of direct measurements has been made by Orme Masson (*Phil. Trans.* vol. 192, A, p. 331). He placed the gelatine solution of a salt, potassium chloride, for example, in a horizontal glass tube, and found the rate of migration of the potassium and chlorine ions by observing the speed at which they were replaced when a coloured anion, say, the Cr₂O₇ from a solution of potassium bichromate, entered the tube at one end, and a coloured cation, say, the Cu from copper sulphate, at the other. The coloured ions are specifically slower than the colourless ions which they follow, and in this case it follows that the coloured solution has a

higher resistance than the colourless. For the same current, therefore, the potential gradient is higher in the coloured solution and lower in the colourless one. Thus a coloured ion which gets in front of the advancing boundary finds itself acted on by a smaller force and falls back into line, while a straggling colourless ion is pushed forward again. Hence a sharp boundary is preserved. B. D. Steele has shown that with these sharp boundaries the use of coloured ions is unnecessary, the junction line being visible owing to the difference in the optical refractive indices of two colourless solutions. Once the boundary is formed, too, no gelatine is necessary, and the motion can be watched through liquid aqueous solutions (see R. B. Denison and B. D. Steele, *Phil. Trans.*, 1906).

All the direct measurements which have been made on simple binary electrolytes agree with Kohlrausch's results within the limits of experimental error. His theory, therefore, probably holds good in such cases, whatever be the solvent, if the proper values are given to the ionic velocities, *i.e.* the values expressing the velocities with which the ions actually move in the solution of the strength taken, and under the conditions of the experiment. If we know the specific velocity of any one ion, we can deduce, from the conductivity of very dilute solutions, the velocity of any other ion with which it may be associated, a proceeding which does not involve the difficult task of determining the migration constant of the compound. Thus, taking the specific ionic velocity of hydrogen as 0.00032 cm. per second, we can find, by determining the conductivity of dilute solutions of any acid, the specific velocity of the acid radicle involved. Or again, since we know the specific velocity of silver, we can find the velocities of a series of acid radicles at great dilution by measuring the conductivity of their silver salts.

By such methods W. Ostwald, G. Bredig and other observers have found the specific velocities of many ions both of inorganic and organic compounds, and examined the relation between constitution and ionic velocity. The velocity of elementary ions is found to be a periodic function of the atomic weight, similar elements lying on corresponding portions of a curve drawn to express the relation between these two properties. Such a curve much resembles that giving the relation between atomic weight and viscosity in solution. For complex ions the velocity is largely an additive property; to a continuous additive change in the composition of the ion corresponds a continuous but decreasing change in the velocity. The following table gives Ostwald's results for the formic acid series:—

TABLE XII.

	Velocity.	Difference for CH ₂ .
Formic acid . . . HCO ₂	51.2	..
Acetic " . . . H ₂ C ₂ O ₂	38.3	-12.9
Propionic " . . . H ₃ C ₃ O ₂	34.3	-4.0
Butyric " . . . H ₄ C ₄ O ₂	30.8	-3.5
Valeric " . . . H ₅ C ₅ O ₂	28.8	-2.0
Capronic " . . . H ₁₁ C ₆ O ₂	27.4	-1.4

Nature of Electrolytes.—We have as yet said nothing about the fundamental cause of electrolytic activity, nor considered why, for example, a solution of potassium chloride is a good conductor, while a solution of sugar allows practically no current to pass.

All the preceding account of the subject is, then, independent of any view we may take of the nature of electrolytes, and stands on the basis of direct experiment. Nevertheless, the facts considered point to a very definite conclusion. The specific velocity of an ion is independent of the nature of the opposite ion present, and this suggests that the ions themselves, while travelling through the liquid, are dissociated from each other. Further evidence, pointing in the same direction, is furnished by the fact that since the conductivity is proportional to the concentration at great dilution, the equivalent-conductivity, and therefore the ionic velocity, is independent of it. The importance of this relation will be seen by considering the alternative to the dissociation hypothesis. If the ions are not permanently free from each other their mobility as parts of the dissolved molecules must be secured by continual interchanges. The velocity with which they work their way through the liquid must then increase as such molecular rearrangements become more frequent, and will therefore depend on the number of solute molecules, *i.e.* on the

concentration. On this supposition the observed constancy of velocity would be impossible. We shall therefore adopt as a working hypothesis the theory, confirmed by other phenomena (see ELECTROLYSIS), that an electrolyte consists of dissociated ions.

It will be noticed that neither the evidence in favour of the dissociation theory which is here considered, nor that described in the article ELECTROLYSIS, requires more than the effective dissociation of the ions from each other. They may well be connected in some way with solvent molecules, and there are several indications that an ion consists of an electrified part of the molecule of the dissolved salt with an attendant atmosphere of solvent round it. The conductivity of a salt solution depends on two factors—(1) the fraction of the salt ionized; (2) the velocity with which the ions, when free from each other, move under the electric forces.¹ When a solution is heated, both these factors may change. The coefficient of ionization usually, though not always, decreases; the specific ionic velocities increase. Now the rate of increase with temperature of these ionic velocities is very nearly identical with the rate of decrease of the viscosity of the liquid. If the curves obtained by observations at ordinary temperatures be carried on they indicate a zero of fluidity and a zero of ionic velocity about the same point, 38.5° C. below the freezing point of water (Kohlrausch, *Sitz. preuss. Akad. Wiss.*, 1901, 42, p. 1026). Such relations suggest that the frictional resistance to the motion of an ion is due to the ordinary viscosity of the liquid, and that the ion is analogous to a body of some size urged through a viscous medium rather than to a particle of molecular dimensions finding its way through a crowd of molecules of similar magnitude. From this point of view W. K. Bousfield has calculated the sizes of ions on the assumption that Stokes's theory of the motion of a small sphere through a viscous medium might be applied (*Zeits. phys. Chem.*, 1905, 53, p. 257; *Phil. Trans. A*, 1906, 206, p. 101). The radius of the potassium or chlorine ion with its envelope of water appears to be about 1.2×10^{-8} centimetres.

For the bibliography of electrolytic conduction see ELECTROLYSIS. The books which deal more especially with the particular subject of the present article are *Das Leitvermögen der Elektrolyte*, by F. Kohlrausch and L. Holborn (Leipzig, 1898), and *The Theory of Solution and Electrolysis*, by W. C. D. Whetham (Cambridge, 1902). (W. C. D. W.)

III. ELECTRIC CONDUCTION THROUGH GASES

A gas such as air when it is under normal conditions conducts electricity to a small but only to a very small extent, however small the electric force acting on the gas may be. The electrical conductivity of gases not exposed to special conditions is so small that it was only definitely established in the early years of the 20th century, although it had engaged the attention of physicists for more than a hundred years. It had been known for a long time that a body charged with electricity slowly lost its charge even when insulated with the greatest care, and though long ago some physicists believed that part of the leak of electricity took place through the air, the general view seems to have been that it was due to almost unavoidable defects in the insulation or to dust in the air, which after striking the charged body was repelled from it and went off with some of the charge. C. A. Coulomb, who made some very careful experiments which were published in 1785 (*Mem. de l'Acad. des Sciences*, 1785, p. 612), came to the conclusion that after allowing for the leakage along the threads which supported the charged body there was a balance over, which he attributed to leakage through the air. His view was that when the molecules of air come into contact with a charged body some of the electricity goes on to the molecules, which are then repelled from the body carrying their charge with them. We shall see later that this explanation is not tenable. C. Matteucci (*Ann. chim. phys.*, 1850, 28, p. 390) in 1850 also came to the conclusion that the electricity from a charged body passes through the air; he was the first to prove

¹ It should be noticed that the velocities calculated in Kohlrausch's theory and observed experimentally are the average velocities, and involve both the factors mentioned above; they include the time wasted by the ions in combination with each other, and, except at great dilution, are less than the velocity with which the ions move when free from each other.

that the rate at which electricity escapes is less when the pressure of the gas is low than when it is high. He found that the rate was the same whether the charged body was surrounded by air, carbonic acid or hydrogen. Subsequent investigations have shown that the rate in hydrogen is in general much less than in air. Thus in 1872 E. G. Warburg (*Pogg. Ann.*, 1872, 145, p. 578) found that the leak through hydrogen was only about one-half of that through air: he confirmed Matteucci's observations on the effect of pressure on the rate of leak, and also found that it was the same whether the gas was dry or damp. He was inclined to attribute the leak to dust in the air, a view which was strengthened by an experiment of J. W. Hittorf's (*Wied. Ann.*, 1879, 7, p. 595), in which a small carefully insulated electroscope, placed in a small vessel filled with carefully filtered gas, retained its charge for several days; we know now that this was due to the smallness of the vessel and not to the absence of dust, as it has been proved that the rate of leak in small vessels is less than in large ones.

Great light was thrown on this subject by some experiments on the rates of leak from charged bodies in closed vessels made almost simultaneously by H. Geitel (*Phys. Zeit.*, 1900, 2, p. 116) and C. T. R. Wilson (*Proc. Camb. Phil. Soc.*, 1900, 11, p. 32). These observers established that (1) the rate of escape of electricity in a closed vessel is much smaller than in the open, and the larger the vessel the greater is the rate of leak; and (2) the rate of leak does not increase in proportion to the differences of potential between the charged body and the walls of the vessel: the rate soon reaches a limit beyond which it does not increase, however much the potential difference may be increased, provided, of course, that this is not great enough to cause sparks to pass from the charged body. On the assumption that the maximum leak is proportional to the volume, Wilson's experiments, which were made in vessels less than 1 litre in volume, showed that in dust-free air at atmospheric pressure the maximum quantity of electricity which can escape in one second from a charged body in a closed volume of V cubic centimetres is about $10^{-8}V$ electrostatic units. E. Rutherford and S. T. Allan (*Phys. Zeit.*, 1902, 3, p. 225), working in Montreal, obtained results in close agreement with this. Working between pressures of from 43 to 743 millimetres of mercury, Wilson showed that the maximum rate of leak is very approximately proportional to the pressure; it is thus exceedingly small when the pressure is low—a result illustrated in a striking way by an experiment of Sir W. Crookes (*Proc. Roy. Soc.*, 1879, 28, p. 347) in which a pair of gold leaves retained an electric charge for several months in a very high vacuum. Subsequent experiments have shown that it is only in very small vessels that the rate of leak is proportional to the volume and to the pressure; in large vessels the rate of leak per unit volume is considerably smaller than in small ones. In small vessels the maximum rate of leak in different gases, is, with the exception of hydrogen, approximately proportional to the density of the gas. Wilson's results on this point are shown in the following table (*Proc. Roy. Soc.*, 1901, 60, p. 277):—

Gas.	Relative Rate of Leak.	Rate of Leak. Sp. Gr.
Air . . .	1.00	1
H ₂184	2.7
CO ₂ . . .	1.69	1.10
SO ₂ . . .	2.64	1.21
CH ₂ Cl . . .	4.7	1.09
Ni(CO) ₄ . . .	5.1	.867

The rate of leak of electricity through gas contained in a closed vessel depends to some extent on the material of which the walls of the vessel are made; thus it is greater, other circumstances being the same, when the vessel is made of lead than when it is made of aluminium. It also varies, as Campbell and Wood (*Phil. Mag.* [6], 13, p. 265) have shown, with the time of the day, having a well-marked minimum at about 3 o'clock in the morning: it also varies from month to month. Rutherford (*Phys. Rev.*, 1903, 16, p. 183), Cooke (*Phil. Mag.*, 1903 [6], 6, p. 403) and McClelland and Burton (*Phys. Rev.*, 1903, 16, p. 184) have shown

that the leak in a closed vessel can be reduced by about 30% by surrounding the vessel with sheets of thick lead, but that the reduction is not increased beyond this amount, however thick the lead sheets may be. This result indicates that part of the leak is due to a very penetrating kind of radiation, which can get through the thin walls of the vessel but is stopped by the thick lead. A large part of the leak we are describing is due to the presence of radioactive substances such as radium and thorium in the earth's crust and in the walls of the vessel, and to the gaseous radioactive emanations which diffuse from them into the atmosphere. This explains the very interesting effect discovered by J. Elster and H. Geitel (*Phys. Zeit.*, 1901, 2, p. 560), that the rate of leak in caves and cellars when the air is stagnant and only renewed slowly is much greater than in the open air. In some cases the difference is very marked; thus they found that in the cave called the Baumannshöhle in the Harz mountains the electricity escaped at seven times the rate it did in the air outside. In caves and cellars the radioactive emanations from the walls can accumulate and are not blown away as in the open air.

The electrical conductivity of gases in the normal state is, as we have seen, exceedingly small, so small that the investigation of its properties is a matter of considerable difficulty; there are, however, many ways by which the electrical conductivity of a gas can be increased so greatly that the investigation becomes comparatively easy. Among such methods are raising the temperature of the gas above a certain point. Gases drawn from the neighbourhood of flames, electric arcs and sparks, or glowing pieces of metal or carbon are conductors, as are also gases through which Röntgen or cathode rays or rays of positive electricity are passing; the rays from the radioactive metals, radium, thorium, polonium and actinium, produce the same effect, as does also ultra-violet light of exceedingly short wavelength. The gas, after being made a conductor of electricity by any of these means, is found to possess certain properties; thus it retains its conductivity for some little time after the agent which made it a conductor has ceased to act, though the conductivity diminishes very rapidly and finally gets too small to be appreciable.

This and several other properties of conducting gas may readily be proved by the aid of the apparatus represented in fig. 5.

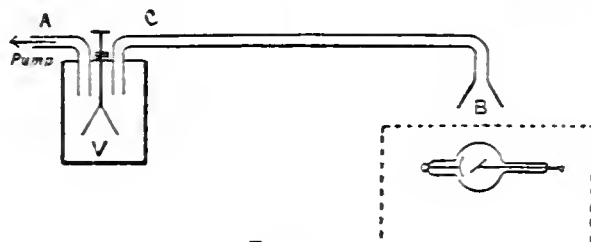

FIG. 5.

V is a testing vessel in which an electroscope is placed. Two tubes A and C are fitted into the vessel, A being connected with a water pump, while the far end of C is in the region where the gas is exposed to the agent which makes it a conductor of electricity. Let us suppose that the gas is made conducting by Röntgen rays produced by a vacuum tube which is placed in a box, covered except for a window at B with lead so as to protect the electroscope from the direct action of the rays. If a slow current of air is drawn by the water pump through the testing vessel, the charge on the electroscope will gradually leak away. The leak, however, ceases when the current of air is stopped. This result shows that the gas retains its conductivity during the time taken by it to pass from one end to the other of the tube C.

The gas loses its conductivity when filtered through a plug of glass-wool, or when it is made to bubble through water. This can readily be proved by inserting in the tube C a plug of glass-wool or a water trap; then if by working the pump a little harder the same current of air is produced as before, it will be found that the electroscope will now retain its charge, showing that the conductivity can, as it were, be filtered out of the gas.

The conductivity can also be removed from the gas by making the gas traverse a strong electric field. We can show this by replacing the tube C by a metal tube with an insulated wire passing down the axis of the tube. If there is no potential difference between the wire and the tube then the electroscope will leak when a current of air is drawn through the vessel, but the leak will stop if a considerable difference of potential is maintained between the wire and the tube: this shows that a strong electric field removes the conductivity from the gas.

The fact that the conductivity of the gas is removed by filtering shows that it is due to something mixed with the gas which is removed from it by filtration, and since the conductivity is also removed by an electric field, the cause of the conductivity must be charged with electricity so as to be driven to the sides of the tube by the electric force. Since the gas as a whole is not electrified either positively or negatively, there must be both negative and positive charges in the gas, the amount of electricity of one sign being equal to that of the other. We are thus led to the conclusion that the conductivity of the gas is due to electrified particles being mixed up with the gas, some of these particles having charges of positive electricity, others of negative. These electrified particles are called *ions*, and the process by which the gas is made a conductor is called the ionization of the gas. We shall show later that the charges and masses of the ions can be determined, and that the gaseous ions are not identical with those met with in the electrolysis of solutions.

One very characteristic property of conduction of electricity through a gas is the relation between the current through the gas and the electric force which gave rise to it. This relation is not in general that expressed by Ohm's law, which always, as far as our present knowledge extends, expresses the relation for conduction through metals and electrolytes. With gases, on the other hand, it is only when the current is very small that Ohm's law is true. If we represent graphically by means of a curve the relation between the current passing between two parallel metal plates separated by ionized gas and the difference of potential between the plates, the curve is of the character shown in fig. 6 when the ordinates represent the current and the abscissae the difference of potential between the plates. We see that when the potential difference is very small, *i.e.* close to the origin, the curve is approximately straight, but that

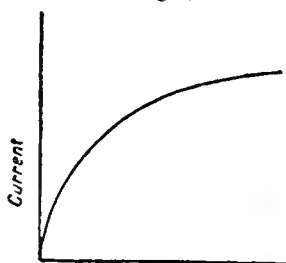

E.M.F.
FIG. 6.

soon the current increases much less rapidly than the potential difference, and that a stage is reached when no appreciable increase of current is produced when the potential difference is increased; when this stage is reached the current is constant, and this value of the current is called the "saturation" value. When the potential difference approaches the value at which sparks would pass through the

gas, the current again increases with the potential difference; thus the curve representing the relation between the current and potential difference over very wide ranges of potential difference has the shape shown in fig. 7; curves of this kind have been obtained by von Schweidler (*Wien. Ber.*, 1899, 108, p. 273), and J. E. S. Townsend (*Phil. Mag.*, 1901 [6], 1, p. 198). We shall discuss later the causes of the rise in the current with large potential differences, when we consider ionization by collision.

The general features of the earlier part of the curve are readily explained on the ionization hypothesis. On this view the Röntgen rays or other ionizing agent acting on the gas between the plates, produces positive and negative ions at a definite rate. Let us suppose that q positive and q negative ions are by this means produced per second between the plates; these under the electric force will tend to move, the positive ones to the negative plate, the negative ones to the positive. Some of these ions will reach the plate, others before reaching the plate will get so near one of the opposite sign that the attraction between them will cause them to unite and form an electrically neutral system; when they do this they end their

existence as ions. The current between the plates is proportional to the number of ions which reach the plates per second. Now it is evident that we cannot go on taking more ions out of the gas than are produced; thus we cannot, when the current is steady, have more than q positive ions driven to the negative plate per second, and the same number of negative ions to the positive. If each of the positive ions carries a charge of e units of positive electricity, and if there is an equal and opposite charge on each negative ion, then the maximum amount of electricity which can be given to the plates per second is qe , and this is equal to the saturation current. Thus if we measure the saturation current, we get a direct measure of the

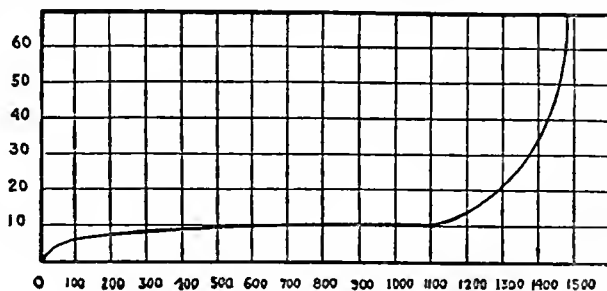

FIG. 7.

ionization, and this does not require us to know the value of any quantity except the constant charge on the ion. If we attempted to deduce the amount of ionization by measurements of the current before it was saturated, we should require to know in addition the velocity with which the ions move under a given electric force, the time that elapses between the liberation of an ion and its combination with one of the opposite sign, and the potential difference between the plates. Thus if we wish to measure the amount of ionization in a gas we should be careful to see that the current is saturated.

The difference between conduction through gases and through metals is shown in a striking way when we use potential differences large enough to produce the saturation current. Suppose we have got a potential difference between the plates more than sufficient to produce the saturation current, and let us increase the distance between the plates. If the gas were to act like a metallic conductor this would diminish the current, because the greater length would involve a greater resistance in the circuit. In the case we are considering the separation of the plates will *increase* the current, because now there is a larger volume of gas exposed to the rays; there are therefore more ions produced, and as the saturation current is proportional to the number of ions the saturation current is increased. If the potential difference between the plates were much less than that required to saturate the current, then increasing the distance would diminish the current; the gas for such potential differences obeys Ohm's law and the behaviour of the gaseous resistance is therefore similar to that of a metallic one.

In order to produce the saturation current the electric field must be strong enough to drive each ion to the electrode before it has time to enter into combination with one of the opposite sign. Thus when the plates in the preceding example are far apart, it will take a larger potential difference to produce this current than when the plates are close together. The potential difference required to saturate the current will increase as the square of the distance between the plates, for if the ions are to be delivered in a given time to the plates their speed must be proportional to the distance between the plates. But the speed is proportional to the electric force acting on the ion; hence the electric force must be proportional to the distance between the plates, and as in a uniform field the potential difference is equal to the electric force multiplied by the distance between the plates, the potential difference will vary as the square of this distance.

The potential difference required to produce saturation will, other circumstances being the same, increase with the amount of ionization, for when the number of ions is large and they are crowded together, the time which will elapse before a positive one combines with a negative will be smaller than when the number of ions is small. The ions have therefore to be removed more quickly from the gas when the ionization is great than when it is small; thus they must move at a higher speed and must therefore be acted upon by a larger force.

When the ions are not removed from the gas, they will increase until the number of ions of one sign which combine with ions of the opposite sign in any time is equal to the number produced by the ionizing agent in that time. We can easily calculate the number of free ions at any time after the ionizing agent has commenced to act.

Let q be the number of ions (positive or negative) produced in one cubic centimetre of the gas per second by the ionizing agent, n_1, n_2 , the number of free positive and negative ions respectively per cubic centimetre of the gas. The number of collisions between positive and negative ions per second in one cubic centimetre of the gas is proportional to $n_1 n_2$. If a certain fraction of the collisions between the positive and negative ions result in the formation of an electrically neutral system, the number of ions which disappear per second on a cubic centimetre will be equal to $an_1 n_2$, where a is a quantity which is independent of n_1, n_2 ; hence if t is the time since the ionizing agent was applied to the gas, we have

$$dn_1/dt = q - an_1 n_2, \quad dn_2/dt = q - an_1 n_2.$$

Thus $n_1 - n_2$ is constant, so if the gas is uncharged to begin with, n_1 will always equal n_2 . Putting $n_1 = n_2 = n$ we have

$$dn/dt = q - an^2 \dots \dots \dots (1),$$

the solution of which is, since $n = 0$ when $t = 0$,

$$n = \frac{k(e^{2kat} - 1)}{e^{2ka} + 1} \dots \dots \dots (2),$$

if $k^2 = q/a$. Now the number of ions when the gas has reached a steady state is got by putting t equal to infinity in the preceding equation, and is therefore given by the equation

$$n_0 = k = \sqrt{q/a}.$$

We see from equation (1) that the gas will not approximate to its steady state until $2kat$ is large, that is until t is large compared with $1/2ka$ or with $1/2\sqrt{q/a}$. We may thus take $1/2\sqrt{q/a}$ as a measure of the time taken by the gas to reach a steady state when exposed to an ionizing agent; as this time varies inversely as \sqrt{q} we see that when the ionization is feeble it may take a very considerable time for the gas to reach a steady state. Thus in the case of our atmosphere where the production of ions is only at the rate of about 30 per cubic centimetre per second, and where, as we shall see, a is about 10^{-6} , it would take some minutes for the ionization in the air to get into a steady state if the ionizing agent were suddenly applied.

We may use equation (1) to determine the rate at which the ions disappear when the ionizing agent is removed. Putting $q = 0$ in that equation we get $dn/dt = -an^2$.

Hence
$$n = n_0 / (1 + n_0 a t) \dots \dots \dots (3),$$

where n_0 is the number of ions when $t = 0$. Thus the number of ions falls to one-half its initial value in the time $1/n_0 a$. The quantity a is called the *coefficient of recombination*, and its value for different gases has been determined by Rutherford (*Phil. Mag.* 1897 [5], 44, p. 422), Townsend (*Phil. Trans.*, 1900, 193, p. 129), McClung (*Phil. Mag.*, 1902 [6], 3, p. 283), Langevin (*Ann. chim. phys.* [7], 28, p. 289), Retschinsky (*Ann. d. Phys.*, 1905, 17, p. 518), Hendred (*Phys. Rev.*, 1905, 21, p. 314). The values of ae , e being the charge on an ion in electrostatic measure as determined by these observers for different gases, is given in the following table—

	Townsend.	McClung.	Langevin.	Retschinsky.	Hendred.
Air .	3420	3380	3200	4140	3500
O ₂ .	3380				
CO ₂ .	3500	3490	3400		
H ₂ .	3020	2940			

The gases in these experiments were carefully dried and free from dust; the apparent value of a is much increased when dust or small drops of water are present in the gas, for then the ions get caught by the dust particles, the mass of a particle is so great compared with that of an ion that they are practically immovable under the action of the electric field, and so the ions clinging to them escape detection when electrical methods are used. Taking e as 3.5×10^{-10} , we see that a is about 1.2×10^{-6} , so that the number of recombinations in unit time between n positive and n negative ions in unit volume is $1.2 \times 10^{-6} n^2$. The kinetic theory of gases shows that if we have n molecules of air per cubic centimetre, the number of collisions per second is $1.2 \times 10^{-10} n^2$ at a temperature of 0°C . Thus we see that the number of recombinations between oppositely charged ions is enormously greater than the number of collisions between the same number of neutral molecules. We shall see that the difference in size between the ion and the molecule is not nearly sufficient to account for the difference between the collisions in the two cases; the difference is due to the force between the oppositely charged ions, which drags ions into collisions which but for this force would have missed each other.

Several methods have been used to measure a . In one method air, exposed to some ionizing agent at one end of a long tube, is

slowly sucked through the tube and the saturation current measured at different points along the tube. These currents are proportional to the values of n at the place of observation: if we know the distance of this place from the end of the tube when the gas was ionized and the velocity of the stream of gas, we can find t in equation (3), and knowing the value of n we can deduce the value of a from the equation

$$1/n_1 - 1/n_2 = a(t_1 - t_2),$$

where n_1, n_2 are the values of n at the times t_1, t_2 respectively. In this method the tubes ought to be so wide that the loss of ions by diffusion to the sides of the tube is negligible. There are other methods which involve the knowledge of the speed with which the ions move under the action of known electric forces; we shall defer the consideration of these methods until we have discussed the question of these speeds.

In measuring the value of a it should be remembered that the theory of the methods supposes that the ionization is uniform throughout the gas. If the total ionization throughout a gas remains constant, but instead of being uniformly distributed is concentrated in patches, it is evident that the ions will recombine more quickly in the second case than in the first, and that the value of a will be different in the two cases. This probably explains the large values of a obtained by Retschinsky, who ionized the gas by the α rays from radium, a method which produces very patchy ionization.

Variation of a with the Pressure of the Gas.—All observers agree that there is little variation in a with the pressures for pressures of between 5 and 1 atmospheres; at lower pressures, however, the value of a seems to diminish with the pressure: thus Langevin (*Ann. chim. phys.*, 1903, 28, p. 287) found that at a pressure of $\frac{1}{2}$ of an atmosphere the value of a was about $\frac{1}{2}$ of its value at atmospheric pressure.

Variation of a with the Temperature.—Erikson (*Phil. Mag.*, Aug. 1909) has shown that the value of a for air increases as the temperature diminishes, and that at the temperature of liquid air -180°C , it is more than twice as great as at $+12^\circ\text{C}$.

Since, as we have seen, the recombination is due to the coming together of the positive and negative ions under the influence of the electrical attraction between them, it follows that a large electric force sufficient to overcome this attraction would keep the ions apart and hence diminish the coefficient of recombination. Simple considerations, however, will show that it would require exceedingly strong electric fields to produce an appreciable effect. The value of a indicates that for two oppositely charged ions to unite they must come within a distance of about 1.5×10^{-6} centimetres; at this distance the attraction between them is $e^2 \times 10^{12} / 2.25$, and if X is the external electric force, the force tending to pull them apart cannot be greater than Xe ; if this is to be comparable with the attraction, X must be comparable with $e \times 10^{12} / 2.25$, or putting $e = 4 \times 10^{-10}$, with 1.8×10^2 ; this is 54,000 volts per centimetre, a force which could not be applied to gas at atmospheric pressure without producing a spark.

Diffusion of the Ions.—The ionized gas acts like a mixture of gases, the ions corresponding to two different gases, the non-ionized gas to a third. If the concentration of the ions is not uniform, they will diffuse through the non-ionized gas in such a way as to produce a more uniform distribution. A very valuable series of determinations of the coefficient of diffusion of ions through various gases has been made by Townsend (*Phil. Trans.*, 1900, A, 193, p. 129). The method used was to suck the ionized gas through narrow tubes; by measuring the loss of both the positive and negative ions after the gases had passed through a known length of tube, and allowing for the loss by recombination, the loss by diffusion and hence the coefficient of diffusion could be determined. The following tables give the values of the coefficients of diffusion D on the C.G.S. system of units as determined by Townsend:—

TABLE I.—Coefficients of Diffusion (D) in Dry Gases.

Gas.	D for +ions.	D for -ions.	Mean Value of D.	Ratio of D for - to D for + ions.
Air	.028	.043	.0347	1.54
O ₂	.025	.0396	.0323	1.58
CO ₂	.023	.026	.0245	1.13
H ₂	.123	.190	.156	1.54

TABLE II.—Coefficients of Diffusion in Moist Gases.

Gas.	D for +ions.	D for -ions.	Mean Value of D.	Ratio of D for - to D for + ions.
Air	.032	.037	.0335	1.09
O ₂	.0288	.0358	.0323	1.24
CO ₂	.0245	.0255	.025	1.04
H ₂	.128	.142	.135	1.11

It is interesting to compare with these coefficients the values of D when various gases diffuse through each other. D for hydrogen through air is .634, for oxygen through air .177, for the vapour of

isobutyl amide through air 0.42. We thus see that the velocity of diffusion of ions through air is much less than that of the simple gas, but that it is quite comparable with that of the vapours of some complex organic compounds.

The preceding tables show that the negative ions diffuse more rapidly than the positive, especially in dry gases. The superior mobility of the negative ions was observed first by Zeleny (*Phil. Mag.*, 1898 [5], 46, p. 120), who showed that the velocity of the negative ions under an electric force is greater than that of the positive. It will be noticed that the difference between the mobility of the negative and the positive ions is much more pronounced in dry gases than in moist. The difference in the rates of diffusion of the positive and negative ions is the reason why ionized gas, in which, to begin with, the positive and negative charges were of equal amounts, sometimes becomes electrified even although the gas is not acted upon by electric forces. Thus, for example, if such gas be blown through narrow tubes, it will be positively electrified when it comes out, for since the negative ions diffuse more rapidly than the positive, the gas in its passage through the tubes will lose by diffusion more negative than positive ions and hence will emerge positively electrified. Zeleny showed that this effect does not occur when, as in carbonic acid gas, the positive and negative ions diffuse at the same rates. Townsend (*loc. cit.*) showed that the coefficient of diffusion of the ions is the same whether the ionization is produced by Röntgen rays, radioactive substances, ultra-violet light, or electric sparks. The ions produced by chemical reactions and in flames are much less mobile; thus, for example, Bloch (*Ann. chim. phys.*, 1905 [8], 4, p. 25) found that for the ions produced by drawing air over phosphorus the value of a/e was between 1 and 6 instead of over 3000, the value when the air was ionized by Röntgen rays.

Velocity of Ions in an Electric Field.—The velocity of ions in an electric field, which is of fundamental importance in conduction, is very closely related to the coefficient of diffusion. Measurements of this velocity for ions produced by Röntgen rays have been made by Rutherford (*Phil. Mag.* [5], 44, p. 422), Zeleny (*Phil. Mag.* [5], 46, p. 120), Langevin (*Ann. Chim. Phys.*, 1903, 28, p. 289), Phillips (*Proc. Roy. Soc.* 78, A, p. 167), and Wellisch (*Phil. Trans.*, 1909, 209, p. 249). The ions produced by radioactive substance have been investigated by Rutherford (*Phil. Mag.* [5], 47, p. 109) and by Franck and Pohl (*Verh. deutsch. phys. Gesell.*, 1907, 9, p. 69), and the negative ions produced when ultra-violet light falls on a metal plate by Rutherford (*Proc. Camb. Phil. Soc.* 9, p. 401). H. A. Wilson (*Phil. Trans.* 192, p. 409), Marx (*Ann. de Phys.* 11, p. 765), Moreau (*Journ. de Phys.* 4, 11, p. 558; *Ann. Chim. Phys.* 7, 30, p. 5) and Gold (*Proc. Roy. Soc.* 79, p. 43) have investigated the velocities of ions produced by putting various salts into flames; McClelland (*Phil. Mag.* 46, p. 29) the velocity of the ions in gases sucked from the neighbourhood of flames and arcs; Townsend (*Proc. Camb. Phil. Soc.* 9, p. 345) and Bloch (*loc. cit.*) the velocity of ions produced by chemical reaction; and Chattock (*Phil. Mag.* [5], 48, p. 401) the velocity of the ions produced when electricity escapes from a sharp needle point into a gas.

Several methods have been employed to determine these velocities. The one most frequently employed is to find the electromotive intensity required to force an ion against the stream of gas moving with a known velocity parallel to the lines of electric force. Thus, of two perforated plane electrodes vertically over each other, suppose the lower to be positively, the upper negatively electrified, and suppose that the gas is streaming vertically downwards with the velocity V ; then unless the upward velocity of the positive ion is greater than V , no positive electricity will reach the upper plate. If we increase the strength of the field between the plates, and hence the upward velocity of the positive ion, until the positive ions just begin to reach the upper plate, we know that with this strength of field the velocity of the positive ion is equal to V . By this method, which has been used by Rutherford, Zeleny and H. A. Wilson, the velocity of ions in fields of various strengths has been determined.

The arrangement used by Zeleny is represented in fig. 8. P and Q are square brass plates. They are bored through their centres, and to the openings the tubes R and S are attached, the space between the plates being covered in so as to form a closed box. K is a piece of wire gauze completely covering the opening in Q; T is an insulated piece of wire gauze nearly but not quite filling the opening in the plate P, and connected with one pair of quadrants of an electrometer E. A plug of glass wool G filters out the dust from a stream of gas which enters the vessel by the tube D and leaves it by F; this plug also makes the velocity of the flow of the gas uniform across the section of the tube. The Röntgen rays to ionize the gas

were produced by a bulb at O, the bulb and coil being in a lead-covered box, with an aluminium window through which the rays passed. Q is connected with one pole of a battery of cells, P and the other pole of the battery are put to earth. The changes in the potential of T are due to ions giving up their charges to it. With a given velocity of air-blast the potential of T was found not to change unless the difference of potential between P and Q exceeded a critical value. The field corresponding to this critical value thus made the ions move with the known velocity of the blast.

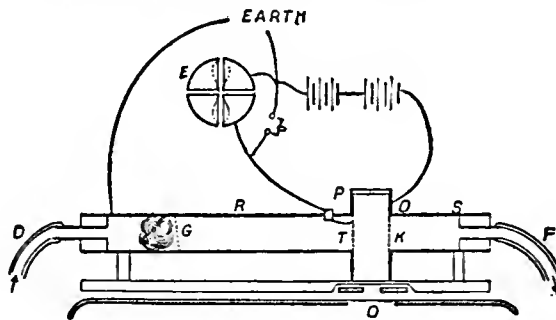

FIG. 8.

Another method which has been employed by Rutherford and McClelland is based on the action of an electric field in destroying the conductivity of gas streaming through it. Suppose that BAB, DCD (fig. 9) are a system of parallel plates boxed in so that a stream of gas, after flowing between BB, passes between DD without any loss of gas in the interval. Suppose the plates DD are insulated, and connected with one pair of quadrants of an electrometer, by charging up C to a sufficiently high potential we can drive all the positive ions which enter the system DCD against the plates D; this will cause a deflexion of the electrometer, which in one second will be proportional to the number of positive ions which have entered the system in that time. If we charge A up to a high potential, B being put to earth, we shall find

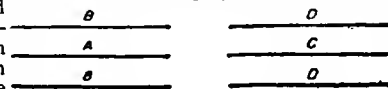

FIG. 9.

that the deflexion of the electrometer connected with DD is less than it was when A and B were at the same potential, because some of the positive ions in their passage through BAB are driven against the plates B. If u is the velocity along the lines of force in the uniform electric field between A and B, and t the time it takes for the gas to pass through BAB, then all the positive ions within a distance ut of the plates B will be driven up against these plates, and thus if the positive ions are equally distributed through the gas, the number of positive ions which emerge from the system when the electric field is on will bear to the number which emerge when the field is off the ratio of $1 - ut/l$ to unity, where l is the distance between A and B. This ratio is equal to the ratio of the deflexions in one second of the electrometer attached to D, hence the observations of this instrument give $1 - ut/l$. If we know the velocity of the gas and the length of the plates A and B, we can determine l , and since l can be easily measured, we can find u , the velocity of the positive ion in a field of given strength. By charging A and C negatively instead of positively we can arrive at the velocity of the negative ion. In practice it is more convenient to use cylindrical tubes with coaxial wires instead of the systems of parallel plates, though in this case the calculation of the velocity of the ions from the observations is a little more complicated, inasmuch as the electric field is not uniform between the tubes.

A method which gives very accurate results, though it is only applicable in certain cases, is the one used by Rutherford to measure the velocity of the negative ions produced close to a metal plate by the incidence on the plate of ultra-violet light. The principle of the method is as follows:—AB (fig. 10) is an insulated horizontal plate of well-polished zinc, which can be moved vertically up and down by means of a screw; it is connected with one pair of quadrants of an electrometer, the other pair of quadrants being put to earth. CD is a base-plate with a hole EF in it; this hole is covered with fine wire gauze, through which ultra-violet light passes and falls on the plate AB. The plate CD is connected with an alternating current dynamo, which produces a simply-periodic potential difference between AB and CD, the other pole being put to earth. Suppose that at any instant the plate CD is at a higher potential than AB, then the negative ions from AB will move towards CD, and will continue to do so as long as the potential of CD is higher than that of AB. If, however, the potential difference changes sign before the negative ions reach CD, these ions will go back to AB. Thus AB will not

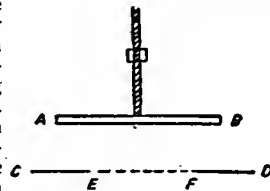

FIG. 10.

lose any negative charge unless the distance between the plates AB and CD is less than the distance traversed by the negative ion during the time the potential of CD is higher than that of AB. By altering the distance between the plates until CD just begins to lose a negative charge, we find the velocity of the negative ion under unit electromotive intensity. For suppose the difference of potential between AB and CD is equal to $a \sin pt$, then if d is the distance between the plates, the electric intensity is equal to $a \sin pt/d$; if we suppose the velocity of the ion is proportional to the electric intensity, and if u is the velocity for unit electric intensity, the velocity of the negative ion will be $ua \sin pt/d$. Hence if x represent the distance of the ion from AB

$$\frac{dx}{dt} = \frac{ua}{d} \sin pt$$

$$x = \frac{ua}{pd}(1 - \cos pt), \text{ if } x=0 \text{ when } t=0.$$

Thus the greatest distance the ion can get from the plate is equal to $2au/pd$, and if the distance between the plates is gradually reduced to this value, the plate AB will begin to lose a negative charge; hence when this happens

$$d = 2au/pd, \text{ or } u = pd^2/2a,$$

an equation by means of which we can find u .

In this form the method is not applicable when ions of both signs are present. Franck and Pohl (*Verh. deutsch. physik. Gesell.* 1907, 9, p. 69) have by a slight modification removed this restriction. The modification consists in confining the ionization to a layer of gas below the gauze EF. If the velocity of the positive ions is to be determined, these ions are forced through the gauze by applying to the ionized gas a small constant electric force acting upwards; if negative ions are required, the constant force is reversed. After passing through the gauze the ions are acted upon by alternating forces as in Rutherford's method.

Langevin (*Ann. chim. phys.*, 1903, 28, p. 289) devised a method of measuring the velocity of the ions which has been extensively used; it has the advantage of not requiring the rate of ionization to remain uniform. The general idea is as follows. Suppose that we expose the gas between two parallel plates A, B to Röntgen rays or some other ionizing agent, then stop the rays and apply a uniform electric field to the region between the plates. If the force on the positive ion is from A to B, the plate B will receive a positive charge of electricity. After the electric force has acted for a time T reverse it. B will now begin to receive negative electricity and will go on doing so until the supply of negative ions is exhausted. Let us consider how the quantity of positive electricity received by B will vary with T . To fix our ideas, suppose the positive ions move more slowly than the negative, let T_2 and T_1 be respectively the times taken by the positive and negative ions to move under the electric field through a distance equal to AB, the distance between the plates. Then if T is greater than T_2 all the ions will have been driven from between the plates before the field is reversed, and therefore the positive charge received by B will not depend upon T . Next let T be less than T_2 but greater than T_1 ; then at the time when the field is reversed all the negative ions will have been driven from between the plates, so that the positive charge received by B will not be neutralized by the arrival of fresh ions coming to it after the reversal of the field. The number of positive ions driven against the plate B will be proportional to T . Thus if we measure the value of the positive charge on B for a series of values of T , each value being less than the preceding, we shall find that until T reaches a certain value the charge remains constant, but as soon as we reduce the time below this value the charge diminishes. The value of T when the diminution in the field begins is T_2 , the time taken for a positive ion to cross from A to B under the electric field; thus from T_2 we can calculate the velocity of the positive ion in this field. If we still further diminish T , we shall find that we reach a value when the diminution of the positive charge on B with the time suddenly becomes much more rapid; this change occurs when T falls below T_1 , the time taken for the negative ions to go from one plate to the other, for now when the field is reversed there are still some negative ions left between the plates, and these will be driven against B and rob it of some of the positive charge it had acquired before the field was reversed. By observing the time when the increase in the rate of diminution of the positive charge with the time suddenly sets in we can determine T_1 , and hence the velocity of the negative ions.

The velocity of the ions produced by the discharge of electricity from a fine point was determined by Chattock by an entirely different method. In this case the electric field is so strong and the velocity of the ion so great that the preceding methods are not applicable. Suppose P represents a vertical needle discharging electricity into air, consider the force acting on the ions included between two horizontal planes A, B. If P is the density of the electrification, and Z the vertical component of the electric intensity, F the resultant force on the ions between A and B is vertical and equal to

$$\iiint Z \rho dx dy dz.$$

Let us suppose that the velocity of the ion is proportional to the electric intensity, so that if w is the vertical velocity of the ions, which are supposed all to be of one sign, $w = RZ$.

Substituting this value of Z , the vertical force on the ions between A and B is equal to

$$\frac{1}{R} \iiint w \rho dx dy dz.$$

But $\iiint w \rho dx dy dz = i$, where i is the current streaming from the point. This current, which can be easily measured by putting a galvanometer in series with the discharging point, is independent of z , the vertical distance of a plane between A and B below the charging point. Hence we have

$$F = \frac{i}{R} \int dz = \frac{i}{R} \cdot z.$$

This force must be counterbalanced by the difference of gaseous pressures over the planes A and B; hence if p_B and p_A denote respectively the pressures over B and A, we have

$$p_B - p_A = \frac{i}{R} z.$$

Hence by the measurement of these pressures we can determine R , and hence the velocity with which an ion moves under a given electric intensity.

There are other methods of determining the velocities of the ions, but as these depend on the theory of the conduction of electricity through a gas containing charged ions, we shall consider them in our discussion of that theory.

By the use of these methods it has been shown that the velocities of the ions in a given gas are the same whether the ionization is produced by Röntgen rays, radioactive substances, ultra-violet light, or by the discharge of electricity from points. When the ionization is produced by chemical action the ions are very much less mobile, moving in the same electric field with a velocity less than one-thousandth part of the velocity of the first kind of ions. On the other hand, as we shall see later, the velocity of the negative ions in flames is enormously greater than that of even the first kind of ion under similar electric fields and at the same pressure. But when these negative ions get into the cold part of the flame, they move sluggishly with velocities of the order of those possessed by the second kind. The results of the various determinations of the velocities of the ions are given in the following table. The velocities are in centimetres per second under an electric force of one volt per centimetre, the pressure of the gas being 1 atmosphere. $V+$ denotes the velocity of the positive ion, $V-$ that of the negative. V is the mean velocity of the positive and negative ions.

Velocities of Ions.—Ions produced by Röntgen Rays.

Gas.	V+.	V-.	V.	Observer.
Air			1.6	Rutherford
Air (dry)	1.36	1.87	..	Zeleny
"	1.60	1.70	..	Langevin
"	1.39	1.78	..	Phillips
"	1.54	1.78	..	Wellisch
Air (moist)	1.37	1.81	..	Zeleny
Oxygen (dry)	1.36	1.80	..	"
Oxygen (moist)	1.29	1.52	..	"
Carbonic acid (dry)	0.76	0.81	..	"
"	0.86	0.90	..	Langevin
"	0.81	0.85	..	Wellisch
Carbonic acid (moist)	0.82	0.75	..	Zeleny
Hydrogen (dry)	6.70	7.95	..	"
Hydrogen (moist)	5.30	5.60	..	"
Nitrogen	1.6	Rutherford
Sulphur dioxide	0.44	0.41	..	Wellisch
Hydrochloric acid	1.27	Rutherford
Chlorine	1.0	"
Helium (dry)	5.09	6.31	..	Franck and Pohl
Carbon monoxide	1.10	1.14	..	Wellisch
Nitrous oxide	0.82	0.90	..	"
Ammonia	0.74	0.80	..	"
Aldehyde	0.31	0.30	..	"
Ethyl alcohol	0.34	0.27	..	"
Acetone	0.31	0.29	..	"
Ethyl chloride	0.33	0.31	..	"
Pentane	0.36	0.35	..	"
Methyl acetate	0.33	0.36	..	"
Ethyl formate	0.30	0.31	..	"
Ethyl ether	0.29	0.31	..	"
Ethyl acetate	0.31	0.28	..	"
Methyl bromide	0.29	0.28	..	"
Methyl iodide	0.21	0.22	..	"
Carbon tetrachloride	0.30	0.31	..	"
Ethyl iodide	0.17	0.16	..	"

Ions produced by Ultra-Violet Light.

Air	1.4	Rutherford
Hydrogen	3.9	Rutherford
Carbonic acid	0.78	Rutherford

Ions in Gases sucked from Flames.

Velocities varying from .04 to .23 McClelland

Ions in Flames containing Salts.

Negative ions	12.9 cm./sec.	Gold
+ions for salts of Li, Na,		
K, Rb, Cs	62	H. A. Wilson
"	200	Marx
"	80	Moreau

Ions liberated by Chemical Action.

Velocities of the order of 0.0005 cm./sec. Bloch

Ions from Point Discharge.

Hydrogen	5.4	7.43	6.41	Chattock
Carbonic acid	0.83	0.925	0.88	Chattock
Air	1.32	1.80	1.55	Chattock
Oxygen	1.30	1.85	1.57	Chattock

It will be seen from this table that the greater mobility of the negative ions is very much more marked in the case of the lighter and simpler gases than in that of the heavier and more complicated ones; with the vapours of organic substances there seems but little difference between the mobilities of the positive and negative ions, indeed in one or two cases the positive one seems slightly but very slightly the more mobile of the two. In the case of the simple gases the difference is much greater when the gases are dry than when they are moist. It has been shown by direct experiment that the velocities are directly proportional to the electric force.

Variation of Velocities with Pressure.—Until the pressure gets low the velocities of the ions, negative as well as positive, vary inversely as the pressure. Langevin (*loc. cit.*) was the first to show that at very low pressures the velocity of the negative ions increases more rapidly as the pressure is diminished than this law indicates. If the nature of the ion did not change with the pressure, the kinetic theory of gases indicates that the velocity would vary inversely as the pressure, so that Langevin's results indicate a change in the nature of the negative ion when the pressure is diminished below a certain value. Langevin's results are given in the following table, where p represents the pressure measured in centimetres of mercury, $V+$ and $V-$ the velocities of the positive and negative ions in air under unit electrostatic force, *i.e.* 300 volts per centimetre:—

Negative Ions.			Positive Ions.		
p .	$V-$.	$pV-/76$.	p .	$V+$.	$pV+/76$.
7.5	6560	647	7.5	4430	437
20.0	2204	580	20.0	1634	430
41.5	994	530	41.5	782	427
76.0	510	510	76.0	480	420
142.0	270	505	142.0	225	425

The increase in the case of $pV-$ indicates that the structure of the negative ion gets simpler as the pressure is reduced. Wallisch in some experiments made at the Cavendish Laboratory found that the diminution in the value of $pV-$ at low pressures is much more marked in some gases than in others, and in some gases he failed to detect it; but it must be remembered that it is difficult to get measurements at pressures of only a few millimetres, as the amount of ionization is so exceedingly small at such pressures that the quantities to be observed are hardly large enough to admit of accurate measurements by the methods available at higher pressures.

Effect of Temperature on the Velocity of the Ions.—Phillips (*Proc. Roy. Soc.*, 1906, 78, p. 167) investigated, using Langevin's method, the velocities of the + and - ions through air at atmospheric pressure at temperatures ranging from that of boiling liquid air to 411° C.; R_1 and R_2 are the velocities of the + and - ions respectively when the force is a volt per centimetre.

R_1 .	R_2 .	Temperature Absolute.
2.00	2.495	411°
1.95	2.40	399°
1.85	2.30	383°
1.81	2.21	373°
1.67	2.125	348°
1.60	2.00	333°
1.39	1.785	285°
0.945	1.23	209°
0.235	0.235	94°

We see that except in the case of the lowest temperature, that of liquid air, where there is a great drop in the velocity, the velocities of the ions are proportional to the absolute temperature. On the hypothesis of an ion of constant size we should, from the kinetic theory of gases, expect the velocity to be proportional to the square root of the absolute temperature, if the charge on the ion did not affect the number of collisions between the ion and the molecules of

the gas through which it is moving. If the collisions were brought about by the electrical attraction between the ions and the molecules, the velocity would be proportional to the absolute temperature. H. A. Wilson (*Phil. Trans.* 192, p. 499), in his experiments on the conduction of flames and hot gases into which salts had been put, found that the velocity of the positive ions in flames at a temperature of 2000° C. containing the salts of the alkali metals was 62 cm./sec. under an electric force of one volt per centimetre, while the velocity of the positive ions in a stream of hot air at 1000° C. containing the same salts was only 7 cm./sec. under the same force. The great effect of temperature is also shown in some experiments of McClelland (*Phil. Mag.* [5], 46, p. 29) on the velocities of the ions in gases drawn from Bunsen flames and arcs; he found that these depended upon the distance the gas had travelled from the flame. Thus, the velocity of the ions at a distance of 5.5 cm. from the Bunsen flame when the temperature was 230° C. was .23 cm./sec. for a volt per centimetre; at a distance of 10 cm. from the flame when the temperature was 160° C. the velocity was .21 cm./sec.; while at a distance of 14.5 cm. from the flame when the temperature was 105° C. the velocity was only .04 cm./sec. If the temperature of the gas at this distance from the flame was raised by external means, the velocity of the ions increased.

We can derive some information as to the constitution of the ions by calculating the velocity with which a molecule of the gas would move in the electric field if it carried the same charge as the ion. From the theory of the diffusion of gases, as developed by Maxwell, we know that if the particles of a gas A are surrounded by a gas B, then, if the partial pressure of A is small, the velocity u with which its particles will move when acted upon by a force X is given by the equation

$$u = \frac{Xe}{(p_1/N_1)} D,$$

where D represents the coefficient of inter-diffusion of A into B, and N_1 the number of particles of A per cubic centimetre when the pressure due to A is p_1 . Let us calculate by this equation the velocity with which a molecule of hydrogen would move through hydrogen if it carried the charge carried by an ion, which we shall prove shortly to be equal to the charge carried by an atom of hydrogen in the electrolysis of solutions. Since p_1/N_1 is independent of the pressure, it is equal to H/N , where H is the atmospheric pressure and N the number of molecules in a cubic centimetre of gas at atmospheric pressure. Now $Ne = 1.22 \times 10^{10}$, if e is measured in electrostatic units; $H = 10^6$ and D in this case is the coefficient of diffusion of hydrogen into itself, and is equal to 1.7. Substituting these values we find

$$u = 1.97 \times 10^4 X.$$

If the potential gradient is 1 volt per centimetre, $X = 1/300$. Substituting this value for X, we find $u = 66$ cm./sec., for the velocity of a hydrogen molecule. We have seen that the velocity of the ion in hydrogen is only about 5 cm./sec., so that the ion moves more slowly than it would if it were a single molecule. One way of explaining this is to suppose that the ion is bigger than the molecule, and is in fact an aggregation of molecules, the charged ion acting as a nucleus around which molecules collect like dust round a charged body. This view is supported by the effect produced by moisture in diminishing the velocity of the negative ion, for, as C. T. R. Wilson (*Phil. Trans.* 193, p. 289) has shown, moisture tends to collect round the ions, and condenses more easily on the negative than on the positive ion. In connexion with the velocities of ions in the gases drawn from flames, we find other instances which suggest that condensation takes place round the ions. An increase in the size of the system is not, however, the only way by which the velocity might fall below that calculated for the hydrogen molecule, for we must remember that the hydrogen molecule, whose coefficient of diffusion is 1.7, is not charged, while the ion is. The forces exerted by the ion on the other molecules of hydrogen are not the same as those which would be exerted by a molecule of hydrogen, and as the coefficient of diffusion depends on the forces between the molecules, the coefficient of diffusion of a charged molecule into hydrogen might be very different from that of an uncharged one.

Wallisch (*loc. cit.*) has shown that the effect of the charge on the ion is sufficient in many cases to explain the small velocity of the ions, even if there were no aggregation.

Mixture of Gases.—The ionization of a mixture of gases raises some very interesting questions. If we ionize a mixture of two very different gases, say hydrogen and carbonic acid, and investigate the nature of the ions by measuring their velocities, the question arises, shall we find two kinds of positive and two kinds of negative ions moving with different velocities, as we should do if some of the positive ions were positively charged hydrogen molecules, while others were positively charged molecules of carbonic acid; or shall we find only one velocity for the positive ions and one for the negative? Many experiments have been made on the velocity of ions in mixtures of two gases, but as yet no evidence has been found of the existence of two different kinds of either positive or negative ions in such mixtures, although some of the methods for determining the velocities of the ions, especially Langevin's, ought to give evidence of this effect, if it existed. The experiments seem to show

that the positive (and the same is true for the negative) ions in a mixture of gases are all of the same kind. This conclusion is one of considerable importance, as it would not be true if the ions consisted of single molecules of the gas from which they are produced.

Recombination.—Several methods enable us to deduce the coefficient of recombination of the ions when we know their velocities. Perhaps the simplest of these consists in determining the relation between the current passing between two parallel plates immersed in ionized gas and the potential difference between the plates. For let q be the amount of ionization, i.e. the number of ions produced per second per unit volume of the gas, A the area of one of the plates, and d the distance between them; then if the ionization is constant through the volume, the number of ions of one sign produced per second in the gas is qAd . Now if i is the current per unit area of the plate, e the charge on an ion, iA/e ions of each sign are driven out of the gas by the current per second. In addition to this source of loss of ions there is the loss due to the recombination; if n is the number of positive or negative ions per unit volume, then the number which recombine per second is an^2 per cubic centimetre, and if n is constant through the volume of the gas, as will approximately be the case if the current through the gas is only a small fraction of the saturation current, the number of ions which disappear per second through recombination is an^2Ad . Hence, since when the gas is in a steady state the number of ions produced must be equal to the number which disappear, we have

$$qAd = iA/e + an^2Ad, \\ q = i/e + an^2.$$

If u_1 and u_2 are the velocities with which the positive and negative ions move, nu_1e and nu_2e are respectively the quantities of positive electricity passing in one direction through unit area of the gas per second, and of negative in the opposite direction, hence

$$i = nu_1e + nu_2e.$$

If X is the electric force acting on the gas, k_1 and k_2 the velocities of the positive and negative ions under unit force, $u_1 = k_1X$, $u_2 = k_2X$; hence

$$n = i / (k_1 + k_2)Xe,$$

and we have

$$q = \frac{i}{ed} + \frac{ai^2}{(k_1 + k_2)^2 e^2 X^2}.$$

But qed is the saturation current per unit area of the plate; calling this I , we have

$$I - i = \frac{dai^2}{e(k_1 + k_2)^2 X^2}$$

or

$$X^2 = \frac{i^2 da}{e(1-i)(k_1 + k_2)^2}$$

Hence if we determine corresponding values of X and i we can deduce the value of a/e if we also know $(k_1 + k_2)$. The value of I is easily determined, as it is the current when X is very large. The preceding result only applies when i is small compared with I , as it is only in this case that the values of n and X are uniform throughout the volume of the gas. Another method which answers the same purpose is due to Langevin (*Ann. Chim. Phys.*, 1903, 28, p. 289); it is as follows. Let A and B be two parallel planes immersed in a gas, and let a slab of the gas bounded by the planes a, b parallel to A and B be ionized by an instantaneous flash of Röntgen rays. If A and B are at different electric potentials, then all the positive ions produced by the rays will be attracted by the negative plate and all the negative ions by the positive, if the electric field were exceedingly large they would reach these plates before they had time to recombine, so that each plate would receive N_0 ions if the flash of Röntgen rays produced N_0 positive and N_0 negative ions. With weaker fields the number of ions received by the plates will be less as some of them will recombine before they can reach the plates. We can find the number of ions which reach the plates in this case in the following way:—In consequence of the movement of the ions the slab of ionized gas will broaden out and will consist of three portions, one in which there are nothing but positive ions,—this is on the side of the negative plate,—another on the side of the positive plate in which there are nothing but negative ions, and a portion between these in which there are both positive and negative ions; it is in this layer that recombination takes place, and here if n is the number of positive or negative ions at the time t after the flash of Röntgen rays,

$$n = n_0 / (1 + an_0 t).$$

With the same notation as before, the breadth of either of the outer layers will in time dt increase by $X(k_1 + k_2)dt$, and the number of ions in it by $X(k_1 + k_2)ndt$; these ions will reach the plate, the outer layers will receive fresh ions until the middle one disappears, which it will do after a time $l/X(k_1 + k_2)$, where l is the thickness of the slab ab of ionized gas; hence N , the number of ions reaching either plate, is given by the equation

$$N = \int_0^{l/X(k_1+k_2)} n_0 X(k_1+k_2) dt = \frac{X(k_1+k_2)}{a} \log \left(1 + \frac{n_0 a l}{X(k_1+k_2)} \right)$$

If Q is the charge received by the plate,

$$Q = Ne = \frac{X}{4\pi e} \log \left(1 + \frac{Q_0 e}{4\pi X} \right),$$

where $Q_0 = n_0 d e$ is the charge received by the plate when the electric force is large enough to prevent recombination, and $e = a 4\pi e(R_1 + R_2)$. We can from this result deduce the value of e and hence the value of a when $R_1 + R_2$ is known.

Distribution of Electric Force when a Current is passing through an Ionized Gas.—Let the two plates be at right angles to the axis of x ; then we may suppose that between the plates the electric intensity X is everywhere parallel to the axis of x . The velocities of both the positive and negative ions are assumed to be proportional to X . Let $k_1 X, k_2 X$ represent these velocities respectively; let n_1, n_2 be respectively the number of positive and negative ions per unit volume at a point fixed by the co-ordinate x ; let q be the number of positive or negative ions produced in unit time per unit volume at this point; and let the number of ions which recombine in unit volume in unit time be $an_1 n_2$; then if e is the charge on the ion, the volume density of the electrification is $(n_1 - n_2)e$, hence

$$\frac{dX}{dx} = 4\pi(n_1 - n_2)e \dots \dots \dots (1).$$

If I is the current through unit area of the gas and if we neglect any diffusion except that caused by the electric field,

$$n_1 e k_1 X + n_2 e k_2 X = I \dots \dots \dots (2).$$

From equations (1) and (2) we have

$$n_1 e = \frac{I}{k_1 + k_2} \left(\frac{1}{X} + \frac{k_2}{4\pi} \frac{dX}{dx} \right) \dots \dots \dots (3),$$

$$n_2 e = \frac{I}{k_1 + k_2} \left(\frac{1}{X} - \frac{k_1}{4\pi} \frac{dX}{dx} \right) \dots \dots \dots (4),$$

and from these equations we can, if we know the distribution of electric intensity between the plates, calculate the number of positive and negative ions.

In a steady state the number of positive and negative ions in unit volume at a given place remains constant, hence neglecting the loss by diffusion, we have

$$\frac{d}{dx}(k_1 n_1 X) = q - an_1 n_2 \dots \dots \dots (5)$$

$$-\frac{d}{dx}(k_2 n_2 X) = q - an_1 n_2 \dots \dots \dots (6).$$

If k_1 and k_2 are constant, we have from (1), (5) and (6)

$$\frac{d^2 X^2}{dx^2} = 8\pi e(q - an_1 n_2) \left(\frac{1}{k_1} + \frac{1}{k_2} \right) \dots \dots \dots (7),$$

an equation which is very useful, because it enables us, if we know the distribution of X^2 , to find whether at any point in the gas the ionization is greater or less than the recombination of the ions. We see that $q - an_1 n_2$, which is the excess of ionization over recombination, is proportional to $d^2 X^2 / dx^2$. Thus when the ionization exceeds the recombination, i.e. when $q - an_1 n_2$ is positive, the curve for X^2 is convex to the axis of x , while when the recombination exceeds the ionization the curve for X^2 will be concave to the axis of x . Thus, for example, fig. 11 represents the curve for X^2 observed by

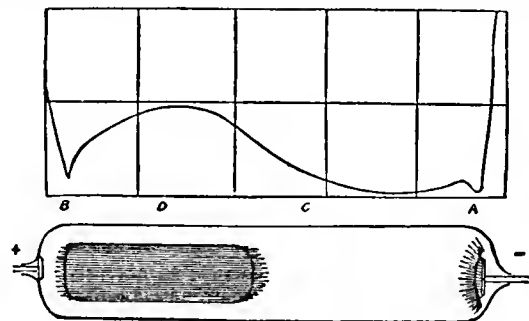

FIG. 11.

Graham (*Wied. Ann.* 64, p. 49) in a tube through which a steady current is passing. Interpreting it by equation (7), we infer that ionization was much in excess of recombination at A and B, slightly so along C, while along D the recombination exceeded the ionization. Substituting in equation (7) the values of n_1, n_2 given in (3), (4), we get

$$\frac{d^2 X^2}{dx^2} = 8\pi e \left[q - \frac{a}{e^2 X^2 (k_1 + k_2)^2} \left(I + \frac{k_2}{8\pi} \frac{dX^2}{dx} \right) \left(I - \frac{k_1}{8\pi} \frac{dX^2}{dx} \right) \right] \left(\frac{1}{k_1} + \frac{1}{k_2} \right) \dots \dots \dots (8).$$

This equation can be solved (see Thomson, *Phil. Mag.* xlvii. p. 253), when q is constant and $k_1 = k_2$. From the solution it appears that if X_1 be the value of x close to one of the plates, and X_0 the value midway between them,

$$X_1 / X_0 = \frac{1}{\beta^2 - 2 / \beta}$$

where $\beta = 8\pi e k_1 / a$.

Since $\epsilon = 4 \times 10^{-10}$, $a = 2 \times 10^{-4}$, and k_1 for air at atmospheric pressure = 450, β is about 2.3 for air at atmospheric pressure and it becomes much greater at lower pressures.

Thus X_1/X_0 is always greater than unity, and the value of the ratio increases from unity to infinity as β increases from zero to infinity. As β does not involve either q or l , the ratio of X_1 to X_0 is independent of the strength of the current and of the intensity of the ionization.

No general solution of equation (8) has been found when k_1 is not equal to k_2 , but we can get an approximation to the solution when q is constant. The equations (1), (2), (3), (4) are satisfied by the values—

$$\begin{aligned} n_1 &= n_2 = (q/a)^{\frac{1}{2}} \\ k_1 n_1 X e &= \frac{k_1}{k_1 + k_2} I, \\ k_2 n_2 X e &= \frac{k_2}{k_1 + k_2} I, \\ X &= \left(\frac{a}{q}\right)^{\frac{1}{2}} \frac{I}{e(k_1 + k_2)}. \end{aligned}$$

These solutions cannot, however, hold right up to the surface of the plates, for across each unit of area, at a point P, $k_1 l / (k_1 + k_2) e$ positive ions pass in unit time, and these must all come from the region between P and the positive plate. If λ is the distance of P from this plate, this region cannot furnish more than $q\lambda$ positive ions, and only this number if there are no recombinations. Hence the solution cannot hold when $q\lambda$ is less than $k_1 l / (k_1 + k_2) e$, or where λ is less than $k_1 l / (k_1 + k_2) q e$.

Similarly the solution cannot hold nearer to the negative plate than the distance $k_2 l / (k_1 + k_2) q e$.

The force in these layers will be greater than that in the middle of the gas, and so the loss of ions by recombination will be smaller in comparison with the loss due to the removal of the ions by the current. If we assume that in these layers the loss of ions by recombination can be neglected, we can by the method of the next article find an expression for the value of the electric force at any point in the layer. This, in conjunction with the value

$X_0 = \left(\frac{a}{q}\right)^{\frac{1}{2}} \frac{I}{e(k_1 + k_2)}$ for the gas outside the layer, will give the value of X at any point between the plates. It follows from this investigation that if X_1 and X_2 are the values of X at the positive and negative plates respectively, and X_0 the value of X outside the layer,

$$X_1 = X_0 \left(1 + \frac{k_1}{k_2} \frac{1}{\epsilon}\right)^{\frac{1}{2}}, \quad X_2 = X_0 \left(1 + \frac{k_2}{k_1} \frac{1}{\epsilon}\right)^{\frac{1}{2}},$$

where $\epsilon = a/4\pi e(k_1 + k_2)$. Langevin found that for air at a pressure of 152 mm. $\epsilon = 0.01$, at 375 mm. $\epsilon = 0.06$, and at 760 mm. $\epsilon = 0.27$. Thus at fairly low pressures $1/\epsilon$ is large, and we have approximately

$$X_1 = X_0 \left(\frac{k_1}{k_2}\right)^{\frac{1}{2}} \frac{1}{\sqrt{\epsilon}}, \quad X_2 = X_0 \left(\frac{k_2}{k_1}\right)^{\frac{1}{2}} \frac{1}{\sqrt{\epsilon}}.$$

Therefore $X_1/X_2 = k_1/k_2$, or the force at the positive plate is to that at the negative plate as the velocity of the positive ion is to that of the negative ion. Thus the force at the negative plate is greater than that at the positive. The falls of potential V_1, V_2 at the two layers when $1/\epsilon$ is large can be shown to be given by the equations

$$\begin{aligned} V_1 &= 8\pi^2 \left(\frac{\epsilon}{qa}\right)^{\frac{3}{2}} k_1 \left(\frac{k_1}{k_2}\right)^{\frac{1}{2}} i^2, \\ V_2 &= 8\pi^2 \left(\frac{\epsilon}{qa}\right)^{\frac{3}{2}} k_2 \left(\frac{k_2}{k_1}\right)^{\frac{1}{2}} i^2, \end{aligned}$$

hence $V_1/V_2 = k_1^2/k_2^2$,

so that the potential falls at the electrodes are proportional to the squares of the velocities of the ions. The change in potential across the layers is proportional to the square of the current, while the potential change between the layers is proportional to the current, the total potential difference between the plates is the sum of these changes, hence the relation between V and i will be of the form

$$V = Ai + Bi^2.$$

Mie (*Ann. der. Phys.*, 1904, 13, p. 857) has by the method

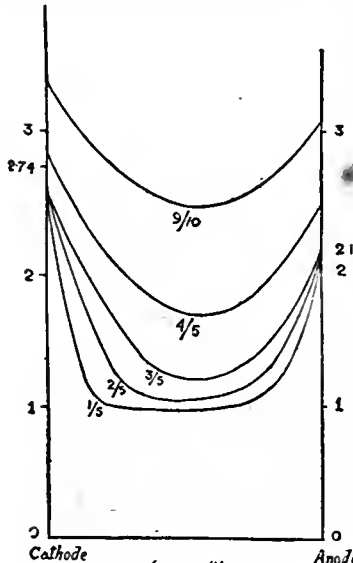

FIG. 12.

of successive approximations obtained solutions of equation (8) (i.) when the current is only a small fraction of the saturation current, (ii.) when the current is nearly saturated. The results of his investigations are represented in fig. 12, which represents the distribution of

electric force along the path of the current for various values of the current expressed as fractions of the saturation current. It will be seen that until the current amounts to about one-fifth of the maximum current, the type of solution is the one just indicated, i.e. the electric force is constant except in the neighbourhood of the electrodes when it increases rapidly.

Though we are unable to obtain a general solution of the equation (8), there are some very important special cases in which that equation can be solved without difficulty. We shall consider two of these, the first being that when the current is saturated. In this case there is no loss of ions by recombination, so that using the same notation as before we have

$$\frac{d}{dx}(n_1 k_1 X) = q,$$

$$\frac{d}{dx}(n_2 k_2 X) = -q.$$

The solutions of which if q is constant are

$$n_1 k_1 X = qx,$$

$$n_2 k_2 X = l/e - qx = q(l-x),$$

if l is the distance between the plates, and $x=0$ at the positive electrode. Since

$$dX/dx = 4\pi(n_1 - n_2)e,$$

we get

$$\frac{1}{8\pi} \frac{dX^2}{dx} = qx \left\{ \frac{1}{k_1} + \frac{1}{k_2} \right\} - q \frac{l}{k_2},$$

or

$$\frac{X^2}{8\pi} = q \frac{x^2}{2} \left(\frac{1}{k_1} + \frac{1}{k_2} \right) - q \frac{lx}{k_2} + C,$$

where C is a quantity to be determined by the condition that $\int_0^l X dx = V$, where V is the given potential difference between the plates. When the force is a minimum $dX/dx = 0$, hence at this point

$$x = \frac{lk_1}{k_1 + k_2}, \quad l-x = \frac{lk_2}{k_1 + k_2}.$$

Hence the ratio of the distances of this point from the positive and negative plates respectively is equal to the ratio of the velocities of the positive and negative ions.

The other case we shall consider is the very important one in which the velocity of the negative ion is exceedingly large compared with the positive; this is the case in flames where, as Gold (*Proc. Roy. Soc.* 97, p. 43) has shown, the velocity of the negative ion is many thousand times the velocity of the positive; it is also very probably the case in all gases when the pressure is low. We may get the solution of this case either by putting $k_1/k_2 = 0$ in equation (8), or independently as follows:—Using the same notation as before, we have

$$i = n_1 k_1 X e + n_2 k_2 X e,$$

$$\frac{d}{dx}(n_2 k_2 X) = q - an_1 n_2,$$

$$\frac{dX}{dx} = 4\pi(n_1 - n_2)e.$$

In this case practically all the current is carried by the negative ions so that $i = n_2 k_2 X e$, and therefore $q = an_1 n_2$.

Thus

$$n_2 = i/k_2 X e, \quad n_1 = qk_2 X e/ai.$$

Thus

$$\frac{dX}{dx} = \frac{4\pi e^2 k_2 q X}{ai} - \frac{4\pi i}{k_2 X},$$

or

$$\frac{dX^2}{dx} - \frac{8\pi e^2 k_2 q X^2}{ai} = -\frac{8\pi i}{k_2}$$

The solution of this equation is

$$X^2 = \frac{a}{q} \frac{i^2}{k_2^2 e^2} + C e^{\frac{8\pi e^2 k_2 q x}{ai}}$$

Here x is measured from the positive electrode; it is more convenient in this case, however, to measure it from the negative electrode. If x be the distance from the negative electrode at which the electric force is X, we have from equation (7)

$$X^2 = \frac{a}{q} \frac{i^2}{k_2^2 e^2} + C e^{\frac{8\pi e^2 k_2 q x}{ai}}$$

To find the value of C we see by equation (7) that

$$\frac{d^2 X^2}{dx^2} \frac{k_1 k_2}{k_1 + k_2} \frac{1}{8\pi e} = q - an_1 n_2;$$

hence

$$\left[\frac{dX^2}{dx} \frac{k_1 k_2}{k_1 + k_2} \frac{1}{8\pi e} \right]_{x_1}^{x_2} = \int_{x_1}^{x_2} (q - an_1 n_2) dx.$$

The right hand side of this equation is the excess of ionization over recombination in the region extending from the cathode to x_1 ; it must therefore, when things are in a steady state, equal the excess of the number of negative ions which leave this region over those which enter it. The number which leave is i/e and the number which enter is i_0/e , if i_0 is the current of negative ions coming from unit area

of the cathode, as hot metal cathodes emit large quantities of negative electricity i_0 may in some cases be considerable, thus the right hand side of equation is $(i-i_0)/e$. When x_1 is large $dX/dx = 0$; hence we have from equation

$$C^1 = \frac{ai(i-i_0)k_1+k_2}{qk_1k_2e^2} \frac{k_1+k_2}{k_2}$$

and since k_1 is small compared with k_2 , we have

$$X^2 = \frac{a^2}{qk_2^2e^2} \left(1 + \frac{k_2}{k_1} \frac{i-i_0e^{-8\pi e^2k_1qx/a}}{i} \right)$$

From the values which have been found for k_2 and a , we know that $8\pi ek_1/a$ is a large quantity, hence the second term inside the bracket will be very small when eqx is equal to or greater than i ; thus this term will be very small outside a layer of gas next the cathode of such thickness that the number of ions produced on it would be sufficient, if they were all utilized for the purpose, to carry the current; in the case of flames this layer is exceedingly thin unless the current is very large. The value of the electric force in the uniform part of the field is equal to $\frac{i}{k_2e} \sqrt{\frac{a}{q}}$ while when $i_0 = 0$

the force at the cathode itself bears to the uniform force the ratio of $(k_1+k_2)^{1/2}$ to $k_1^{1/2}$. As k_1 is many thousand times k_2 the force increases with great rapidity as we approach the cathode; this is a very characteristic feature of the passage of electricity through flames and hot gases. Thus in an experiment made by H. A. Wilson with a flame 18 cm. long, the drop of potential within 1 centimetre of the cathode was about five times the drop in the other 17 cm. of the tube. The relation between the current and the potential difference when the velocity of the negative ion is much greater than the positive is very easily obtained. Since the force is uniform and equal to $\frac{i}{k_2e} \sqrt{\frac{a}{q}}$, until we get close to the cathode the fall of potential in this part of the discharge will be very approximately equal to $\frac{i}{k_2e} \sqrt{\frac{a}{q}} l$, where l is the distance between the electrodes. Close to the cathode, the electric force when i_0 is not nearly equal to i is approximately given by the equation

$$X = \frac{i}{e(k_1k_2)^{1/2}} \left(\frac{a}{q} \right)^{1/2} e^{-4\pi e^2k_2qx/a}$$

and the fall of potential at the cathode is equal approximately to $\int_0^\infty X dx$, that is to

$$\frac{i}{e(k_1k_2)^{1/2}} \left(\frac{a}{q} \right)^{1/2} \frac{ai}{4\pi e^2k_2q}$$

The potential difference between the plates is the sum of the fall of potential in the uniform part of the discharge plus the fall at the cathode, hence

$$V = \left(\frac{a}{q} \right)^{1/2} \frac{i}{ek_2} \left(il + \frac{ia^2}{4\pi e^2q} \frac{1}{\sqrt{(k_1k_2)}} \right)$$

The fall of potential at the cathode is proportional to the square of the current, while the fall in the rest of the circuit is directly proportional to the current. In the case of flames or hot gases, the fall of potential at the cathode is much greater than that in the rest of the circuit, so that in such cases the current through the gas varies nearly as the square root of the potential difference. The equation we have just obtained is of the form

$$V = Ai + B^2,$$

and H. A. Wilson has shown that a relation of this form represents the results of his experiments on the conduction of electricity through flames.

The expression for the fall of potential at the cathode is inversely proportional to $q^{3/2}$, q being the number of ions produced per cubic centimetre per second close to the cathode; thus any increase in the ionization at the cathode will diminish the potential fall at the cathode, and as practically the whole potential difference between the electrodes occurs at the cathode, a diminution in the potential fall there will be much more important than a diminution in the electric force in the uniform part of the discharge, when the force is comparatively insignificant. This consideration explains a very striking phenomenon discovered many years ago by Hittorf, who found that if he put a wire carrying a bead of a volatile salt into the flame, it produced little effect upon the current, unless it were placed close to the cathode where it gave rise to an enormous increase in the current, sometimes increasing the current more than a hundred-fold. The introduction of the salt increases very largely the number of ions produced, so that q is much greater for a salted flame than for a plain one. Thus Hittorf's result coincides with the conclusions we have drawn from the theory of this class of conduction.

The fall of potential at the cathode is proportional to $i-i_0$, where i_0 is the stream of negative electricity which comes from the cathode itself, thus as i_0 increases the fall of potential at the cathode diminishes and the current sent by a given potential difference through the gas increases. Now all metals give out negative particles when heated, at a rate which increases very rapidly with the temperature, but at the same temperature some metals give out more than others. If the cathode is made of a metal which emits large quantities of negative particles, $(i-i_0)$ will for a given value of i be smaller

than if the metal only emitted a small number of particles; thus the cathode fall will be smaller for the metal with the greater emissivity, and the relation between the potential difference and the current will be different in the two cases. These considerations are confirmed by experience, for it has been found that the current between electrodes immersed in a flame depends to a great extent upon the metal of which the electrodes are made. Thus Pettinelli (*Acc. dei Lincei* [5], v. p. 118) found that, *ceteris paribus*, the current between two carbon electrodes was about 500 times that between two iron, ones. If one electrode was carbon and the other iron, the current when the carbon was cathode and the iron anode was more than 100 times the current when the electrodes were reversed. The emission of negative particles by some metallic oxides, notably those of calcium and barium, has been shown by Wehnelt (*Ann. der Phys.* 11, p. 425) to be far greater than that of any known metal, and the increase of current produced by coating the cathodes with these oxides is exceedingly large; in some cases investigated by Tufts and Stark (*Physik. Zeits.*, 1908, 5, p. 248) the current was increased many thousand times by coating the cathode with lime. No appreciable effect is produced by putting lime on the anode.

Conduction when all the ions are of one Sign.—There are many important cases in which the ions producing the current come from one electrode or from a thin layer of gas close to the electrode, no ionization occurring in the body of the gas or at the other electrode. Among such cases may be mentioned those where one of the electrodes is raised to incandescence while the other is cold, or when the negative electrode is exposed to ultra-violet light. In such cases if the electrode at which the ionization occurs is the positive electrode, all the ions will be positively charged, while if it is the negative electrode the ions will all be charged negatively. The theory of this case is exceedingly simple. Suppose the electrodes are parallel planes at right angles to the axis of x ; let X be the electric force at a distance x from the electrode where the ionization occurs, n the number of ions (all of which are of one sign) at this place per cubic centimetre, k the velocity of the ion under unit electric force, e the charge on an ion, and i the current per unit area of the electrode. Then we have $dX/dx = 4\pi ne$, and if u is the velocity of the ion

$neu = i$. But $u = kX$, hence we have $\frac{kX}{4\pi} \frac{dX}{dx} = i$, and since the right hand side of this equation does not depend upon x , we get $kX^2/8\pi = ix + C$, where C is a constant to be determined. If l is the distance between the plates, and V the potential difference between them,

$$V = \int_0^l X dx = \frac{1}{k} \sqrt{\frac{8\pi}{k}} \left[(il + C)^{3/2} - C^{3/2} \right]$$

We shall show that when the current is far below the saturation value, C is very small compared with il , so that the preceding equation becomes

$$V^2 = 8\pi^2 i^2 / k \dots \dots \dots (1)$$

To show that for small currents C is small compared with il , consider the case when the ionization is confined to a thin layer, thickness d close to the electrode, in that layer let n_0 be the value of n , then we have $q = an_0^2 + i/d$. If X_0 be the value of X when $x=0$, $kX_0n_0e = i$, and

$$C = \frac{kX_0^2}{8\pi} = \frac{i^2}{n_0^2ke.8\pi} = \frac{a}{8\pi ke^2} \frac{i^2}{q+i/d} \dots \dots (2)$$

Since $a/8\pi ke$ is, as we have seen, less than unity, C will be small compared with il , if $i/(eq+i/d)$ is small compared with l . If i_0 is the saturation current, $q = i_0/d$, so that the former expression $= id/(i_0+i)$, if i is small compared with i_0 , this expression is small compared with d , and therefore *a fortiori* compared with l , so that we are justified in this case in using equation (1).

From equation (2) we see that the current increases as the square of the potential difference. Here an increase in the potential difference produces a much greater percentage increase than in conduction through metals, where the current is proportional to the potential difference. When the ionization is distributed through the gas, we have seen that the current is approximately proportional to the square root of the potential, and so increases more slowly with the potential difference than currents through metals. From equation (1) the current is inversely proportional to the cube of the distance between the electrodes, so that it falls off with great rapidity as this distance is increased. We may note that for a given potential difference the expression for the current does not involve q , the rate of production of the ions at the electrode, in other words, if we vary the ionization the current will not begin to be affected by the strength of the ionization until this falls so low that the current is a considerable fraction of the saturation current. For the same potential difference the current is proportional to k , the velocity under unit electric force of the ion which carries the current. As the velocity of the negative ion is greater than that of the positive, the current when the ionization is confined to the neighbourhood of one of the electrodes will be greater when that electrode is made cathode than when it is anode. Thus the current will appear to pass more easily in one direction than in the opposite.

Since the ions which carry the current have to travel all the way from one electrode to the other, any obstacle which is impervious to these ions will, if placed between the electrodes, stop the current

to the electrode where there is no ionization. A plate of metal will be as effectual as one made of a non-conductor, and thus we get the remarkable result that by interposing a plate of an excellent conductor like copper or silver between the electrode, we can entirely stop the current. This experiment can easily be tried by using a hot plate as the electrode at which the ionization takes place: then if the other electrode is cold the current which passes when the hot plate is cathode can be entirely stopped by interposing a cold metal plate between the electrodes.

Methods of counting the Number of Ions.—The detection of the ions and the estimation of their number in a given volume is much facilitated by the property they possess of promoting the condensation of water-drops in dust-free air supersaturated with water vapour. If such air contains no ions, then it requires about an eightfold supersaturation before any water-drops are formed; if, however, ions are present C. T. R. Wilson (*Phil. Trans.* 189, p. 265) has shown that a sixfold supersaturation is sufficient to cause the water vapour to condense round the ions and to fall down as raindrops. The absence of the drops when no ions are present is due to the curvature of the drop combined with the surface tension causing, as Lord Kelvin showed, the evaporation from a small drop to be exceeding rapid, so that even if a drop of water were formed the evaporation would be so great in its early stages that it would rapidly evaporate and disappear. It has been shown, however (J. J. Thomson, *Application of Dynamics to Physics and Chemistry*, p. 164; *Conduction of Electricity through Gases*, 2nd ed. p. 179), that if a drop of water is charged with electricity the effect of the charge is to diminish the evaporation; if the drop is below a certain size the effect the charge has in promoting condensation more than counterbalances the effect of the surface tension in promoting evaporation. Thus the electric charge protects the drop in the most critical period of its growth. The effect is easily shown experimentally by taking a bulb connected with a piston arranged so as to move with great rapidity. When the piston moves so as to increase the volume of the air contained in the bulb the air is cooled by expansion, and if it was saturated with water vapour before it is supersaturated after the expansion. By altering the throw of the piston the amount of supersaturation can be adjusted within very wide limits. Let it be adjusted so that the expansion produces about a sixfold supersaturation; then if the gas is not exposed to any ionizing agents very few drops (and these probably due to the small amount of ionization which we have seen is always present in gases) are formed. If, however, the bulb is exposed to strong Röntgen rays expansion produces a dense cloud which gradually falls down and disappears. If the gas in the bulb at the time of its exposure to the Röntgen rays is subject to a strong electric field hardly any cloud is formed when the gas is suddenly expanded. The electric field removes the charged ions from the gas as soon as they are formed so that the number of ions present is greatly reduced. This experiment furnishes a very direct proof that the drops of water which form the cloud are only formed round the ions.

This method gives us an exceedingly delicate test for the presence of ions, for there is no difficulty in detecting ten or so raindrops per cubic centimetre; we are thus able to detect the presence of this number of ions. This result illustrates the enormous difference between the delicacy of the methods of detecting ions and those for detecting uncharged molecules; we have seen that we can easily detect ten ions per cubic centimetre, but there is no known method, spectroscopic or chemical, which would enable us to detect a billion (10^{12}) times this number of uncharged molecules. The formation of the water-drops round the charged ions gives us a means of counting the number of ions present in a cubic centimetre of gas; we cool the gas by sudden expansion until the supersaturation produced by the cooling is sufficient to cause a cloud to be formed round the ions, and the problem of finding the number of ions per cubic centimetre of gas is thus reduced to that of finding the number of drops per cubic centimetre in the cloud. Unless the drops are very few and far between we cannot do this by direct counting; we can, however, arrive at the result in the following way. From the amount of expansion of the gas we can calculate the lowering produced in its

temperature and hence the total quantity of water precipitated. The water is precipitated as drops, and if all the drops are the same size the number per cubic centimetre will be equal to the volume of water deposited per cubic centimetre, divided by the volume of one of the drops. Hence we can calculate the number of drops if we know their size, and this can be determined by measuring the velocity with which they fall under gravity through the air.

The theory of the fall of a heavy drop of water through a viscous fluid shows that $v = \frac{2}{3}ga^2/\mu$, where a is the radius of the drop, g the acceleration due to gravity, and μ the coefficient of viscosity of the gas through which the drop falls. Hence if we know v we can deduce the value of a and hence the volume of each drop and the number of drops.

Charge on Ion.—By this method we can determine the number of ions per unit volume of an ionized gas. Knowing this number we can proceed to determine the charge on an ion. To do this let us apply an electric force so as to send a current of electricity through the gas, taking care that the current is only a small fraction of the saturating current. Then if u is the sum of the velocities of the positive and negative ions produced in the electric field applied to the gas, the current through unit area of the gas is neu , where n is the number of positive or negative ions per cubic centimetre, and e the charge on an ion. We can easily measure the current through the gas and thus determine neu ; we can determine n by the method just described, and u , the velocity of the ions under the given electric field, is known from the experiments of Zeleny and others. Thus since the product neu , and two of the factors n , u are known, we can determine the other factor e , the charge on the ion. This method was used by J. J. Thomson, and details of the method will be found in *Phil. Mag.* [5], 46, p. 528; [5], 48, p. 547; [6], 5, p. 346). The result of these measurements shows that the charge on the ion is the same whether the ionization is by Röntgen rays or by the influence of ultra-violet light on a metal plate. It is the same whether the gas ionized is hydrogen, air or carbonic acid, and thus is presumably independent of the nature of the gas. The value of e formed by this method was 3.4×10^{-10} electrostatic units.

H. A. Wilson (*Phil. Mag.* [6], 5, p. 429) used another method. Drops of water, as we have seen, condense more easily on negative than on positive ions. It is possible, therefore, to adjust the expansion so that a cloud is formed on the negative but not on the positive ions. Wilson arranged the experiments so that such a cloud was formed between two horizontal plates which could be maintained at different potentials. The charged drops between the plates were acted upon by a uniform vertical force which affected their rate of fall. Let X be the vertical electric force, e the charge on the drop, v_1 the rate of fall of the drop when this force acts, and v the rate of fall due to gravity alone. Then since the rate of fall is proportionate to the force on the drop, if a is the radius of the drop, and ρ its density, then

$$\frac{Xe + \frac{4}{3}\pi\rho ga^3}{\frac{4}{3}\pi\rho ga^3} = \frac{v_1}{v},$$

or
But

$$Xe = \frac{4}{3}\pi\rho ga^3(v_1 - v)/v,$$

$$v = \frac{2}{3}ga^2\rho/\mu,$$

so that

$$Xe = \sqrt{2.9\pi} \sqrt{\frac{\mu^2}{g\rho} \cdot \frac{v_1^2(v_1 - v)}{v}}$$

Thus if X , v , v_1 are known e can be determined. Wilson by this method found that e was 3.1×10^{-10} electrostatic units. A few of the ions carried charges $2e$ or $3e$.

Townsend has used the following method to compare the charge carried by a gaseous ion with that carried by an atom of hydrogen in the electrolysis of solution. We have

$$u/D = Ne/II,$$

where D is the coefficient of diffusion of the ions through the gas, u the velocity of the ion in the same gas when acted on by unit electric force, N the number of molecules in a cubic centimetre of the gas when the pressure is Π dynes per square centimetre, and e the charge in electrostatic units. This relation is obtained on the hypothesis that N ions in a cubic centimetre produce the same pressure as N uncharged molecules.

We know the value of D from Townsend's experiments and the values of u from those of Zeleny. We get the following values for $Ne \times 10^{-10}$:—

Gas.	Moist Gas.		Dry Gas.	
	Positive Ions.	Negative Ions.	Positive Ions.	Negative Ions.
Air	1.28	1.29	1.46	1.31
Oxygen	1.34	1.27	1.63	1.36
Carbonic acid	1.01	.87	.99	.93
Hydrogen	1.24	1.18	1.63	1.25
Mean	1.22	1.15	1.43	1.21

Since 1.22 cubic centimetres of hydrogen at the temperature 15°C . and pressure 760 mm. of mercury are liberated by the passage through acidulated water of one electromagnetic unit of electricity or 3×10^{10} electrostatic units, and since in one cubic centimetre of the gas there are 2.46 N atoms of hydrogen, we have, if E is the charge in electrostatic units, on the atom of hydrogen in the electrolysis of solutions

$$2.46NE = 3 \times 10^{10},$$

or

$$NE = 1.22 \times 10^{10}.$$

The mean of the values of Ne in the preceding table is 1.24×10^{10} . Hence we may conclude that the charge of electricity carried by a gaseous ion is equal to the charge carried by the hydrogen atom in the electrolysis of solutions. The values of Ne for the different gases differ more than we should have expected from the probable accuracy of the determination of D and the velocity of the ions: Townsend (*Proc. Roy. Soc.* 80, p. 207) has shown that when the ionization is produced by Röntgen rays some of the positive ions carry a double charge and that this accounts for the values of Ne being greater for the positive than for the negative ions. Since we know the value of e, viz. 3.5×10^{-10} , and, also Ne, $= 1.24 \times 10^{10}$, we find N the number of molecules in a cubic centimetre of gas at standard temperature and pressure to be equal to 3.5×10^{19} . This method of obtaining N is the only one which does not involve any assumption as to the shape of the molecules and the forces acting between them.

Another method of determining the charge carried by an ion has been employed by Rutherford (*Proc. Roy. Soc.* 81, pp. 141, 162), in which the positively electrified particles emitted by radium are made use of. The method consists of: (1) Counting the number of α particles emitted by a given quantity of radium in a known time. (2) Measuring the electric charge emitted by this quantity in the same time. To count the number of the α particles the radium was so arranged that it shot into an ionization chamber a small number of α particles per minute; the interval between the emission of individual particles was several seconds. When an α particle passed into the vessel it ionized the gas inside and so greatly increased its conductivity; thus, if the gas were kept exposed to an electric field, the current through the gas would suddenly increase when an α particle passed into the vessel. Although each α particle produces about thirty thousand ions, this is hardly large enough to produce the conductivity appreciable without the use of very delicate apparatus; to increase the conductivity Rutherford took advantage of the fact that ions, especially negative ones, when exposed to a strong electric field, produce other ions by collision against the molecules of the gas through which they are moving. By suitably choosing the electric field and the pressure in the ionization chamber, the 30,000 ions produced by each α particle can be multiplied to such an extent that an appreciable current passes through the ionization chamber on the arrival of each α particle. An electrometer placed in series with this vessel will show by its deflection when an α particle enters the chamber, and by counting the number of deflections per minute we can determine the number of α particles given out by the radium in that time. Another method of counting this number is to let the particles fall on a phosphorescent screen, and count the number of scintillations on the screen in a certain time. Rutherford has shown that these two methods give concordant results.

The charge of positive electricity given out by the radium was measured by catching the α particles in a Faraday cylinder placed in a very highly exhausted vessel, and measuring the charge per minute received by this cylinder. In this way Rutherford showed that the charge on the α particle was 9.4×10^{-10} electrostatic units. Now e/m for the α particle $= 5 \times 10^3$, and there is evidence that the α particle is a charged atom of helium; since the atomic weight of helium is 4 and e/m for hydrogen is 10^4 , it follows that the charge on the helium atom is twice that on the hydrogen, so that the charge on the hydrogen atom is 4.7×10^{-10} electrostatic units.

Calculation of the Mass of the Ions at Low Pressures.—Although at ordinary pressures the ion seems to have a very complex structure and to be the aggregate of many molecules, yet we have evidence that at very low pressures the structure of the ion, and especially of the negative one, becomes very much simpler. This evidence is afforded by determination of the mass of the atom. We can measure the ratio of the mass of an ion to the charge on the ion by observing the deflections produced by magnetic and electric forces on a moving ion. If an ion carrying a charge e is moving with a velocity v, at a point where the magnetic force is H, a mechanical force acts on the ion, whose direction is at right angles both to the direction of motion of the ion and to the magnetic force, and whose magnitude is $eH \sin \theta$, where θ is the angle between v and H. Suppose then that we have an ion moving through a gas whose pressure is so low that the free path of the ion is long compared with the distance through which it moves whilst we are experimenting upon it; in this case the

motion of the ion will be free, and will not be affected by the presence of the gas.

Since the force is always at right angles to the direction of motion of the ion, the speed of the ion will not be altered by the action of this force; and if the ion is projected with a velocity v in a direction at right angles to the magnetic force, and if the magnetic force is constant in magnitude and direction, the ion will describe a curve in a plane at right angles to the magnetic force. If ρ is the radius of curvature of this curve, m the mass of the ion, $m v^2 / \rho$ must equal the normal force acting on the ion, i.e. it must be equal to Hev, or $\rho = mv/He$. Thus the radius of curvature is constant; the path is therefore a circle, and if we can measure the radius of this circle we know the value of mv/He. In the case of the rapidly moving negative ions projected from the cathode in a highly exhausted tube, which are known as *cathode rays*, the path of the ions can be readily determined since they make many substances luminous when they impinge against them. Thus by putting a screen of such a substance in the path of the rays the shape of the path will be determined. Let us now suppose that the ion is acted upon by a vertical electric force X and is free from magnetic force, if it be projected with a horizontal velocity v, the vertical deflection y after a time t is $\frac{1}{2} X e t^2 / m$, or if l is the horizontal distance travelled over by the ion in this time we have since $l = vt$,

$$y = \frac{1}{2} \frac{X e l^2}{m v^2}.$$

Thus if we measure y and l we can deduce e/mv^2 . From the effect of the magnetic force we know e/mv. Combining these results we can find both e/m and v.

The method by which this determination is carried out in practice is illustrated in fig. 13. The cathode rays start from the electrode C in a highly exhausted tube, pass through two small holes in the plugs A and B, the holes being in the same horizontal line. Thus a pencil of rays emerging from B is horizontal and produces a bright spot at the far end of the tube.

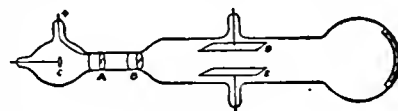

FIG. 13.

In the course of their journey to the end of the tube they pass between the horizontal plates E and D, by connecting these plates with an electric battery a vertical electric field is produced between E and D and the phosphorescent spot is deflected. By measuring this deflection we determine e/mv^2 . The tube is now placed in a uniform magnetic field, the lines of magnetic force being horizontal and at right angles to the plane of the paper. The magnetic force makes the rays describe a circle in the plane of the paper, and by measuring the vertical deflection of the phosphorescent patch at the end of the tube we can determine the radius of this circle, and hence the value of e/mv . From the two observations the value of e/m and v can be calculated.

Another method of finding e/m for the negative ion which is applicable in many cases to which the preceding one is not suitable, is as follows: Let us suppose that the ion starts from rest and moves in a field where the electric and magnetic forces are both uniform, the electric force X being parallel to the axis of x, and the magnetic force Z parallel to the axis of z; then if x, y, are the co-ordinates of the ion at the time t, the equations of motion of the ion are—

$$m \frac{d^2 x}{dt^2} = X e - H e \frac{dy}{dt},$$

$$m \frac{d^2 y}{dt^2} = H e \frac{dx}{dt}.$$

The solution of these equations, if x, y, dx/dt, dy/dt all vanish when t=0, is

$$x = \frac{X m}{c H^2} \left\{ 1 - \cos \left(\frac{e H t}{m} \right) \right\}$$

$$y = \frac{X m}{c H^2} \left\{ \frac{e H t}{m} - \sin \left(\frac{e H t}{m} \right) \right\}.$$

These equations show that the path of the ion is a cycloid, the generating circle of which has a diameter equal to $2 X m / c H^2$, and rolls on the line $x=0$.

Suppose now that we have a number of ions starting from the plane $x=0$, and moving towards the plane $x=a$. The particles starting from $x=0$ describe cycloids, and the greatest distance they can get from the plane is equal to the diameter of the generating circle of the cycloid, i.e. to $2 X m / c H^2$. (After reaching this distance they begin to approach the plane.) Hence if a is less than the diameter of the generating circle, all the particles starting from $x=0$ will reach the plane $x=a$, if this is unlimited in extent; while if a is greater than the diameter of the generating circle none of the particles which start from $x=0$ will reach the plane $x=a$. Thus, if $x=0$ is a plane illuminated by ultra-violet light, and consequently the seat of a supply of negative ions, and $x=a$ a plane connected with an electrometer, then if a definite electric intensity is established between the planes, i.e. if X be fixed, so that the rate of emission of negative ions from the illuminated plate is given, and if a is less than $2 X m / c H^2$, all the ions which start from $x=0$ will reach $x=a$. That

is, the rate at which this plane receives an electric charge will be the same whether there is a magnetic field between the plate or not, but if a is greater than $2Xm/eH^2$, then no particle which starts from the plate $x=0$ will reach the plate $x=a$, and this plate will receive no charge. Thus the supply of electricity to the plate has been entirely stopped by the magnetic field. Thus, on this theory, if the distance between the plates is less than a certain value, the magnetic force should produce no effect on the rate at which the electrometer plate receives a charge, while if the distance is greater than this value the magnetic force would completely stop the supply of electricity to the plate. The actual phenomena are not so abrupt as this theory indicates. We find that when the plates are very near together the magnetic force produces a very slight effect, and this an increase in the rate of charging of the plate. On increasing the distance we come to a stage where the magnetic force produces a great diminution in the rate of charging. It does not, however, stop it abruptly, there being a considerable range of distance, in which the magnetic force diminishes but does not destroy the current. At still greater distances the current to the plate under the magnetic force is quite inappreciable compared with that when there is no magnetic force. We should get this gradual instead of abrupt decay of the current if some of the particles, instead of all starting from rest, started with a finite velocity; in that case the first particles stopped would be those which started from rest. This would be when $a=2Xm/eH^2$. Thus if we measure the value of a when the magnetic force first begins to affect the leak to the electrometer we determine $2Xm/eH^2$, and as we can easily measure X and H , we can deduce the value of m/e .

By these methods Thomson determined the value of e/m for the negative ions produced when ultra-violet light falls on a metal plate, as well as for the negative ions produced by an incandescent carbon filament in an atmosphere of hydrogen (*Phil. Mag.* [5], 48, p. 547) as well as for the cathode rays. It was found that the value of e/m for the negative ions was the same in all these cases, and that it was a constant quantity independent of the nature of the gas from which the ions are produced and the means used to produce them. It was found, too, that this value was more than a thousand times the value of e/M , where e is the charge carried by an atom of hydrogen in the electrolysis of solutions, and M the mass of an atom of hydrogen. We have seen that this charge is the same as that carried by the negative ion in gases; thus since e/m is more than a thousand times e/M , it follows that M must be more than a thousand times m . Thus the mass of the negative ion is exceedingly small compared with the mass of the atom of hydrogen, the smallest mass recognized in chemistry. The production of negative ions thus involves the splitting up of the atom, as from a collection of atoms something is detached whose mass is less than that of a single atom. It is important to notice in connexion with this subject that an entirely different line of argument, based on the Zeeman effect (see MAGNETO-OPTICS), leads to the recognition of negatively electrified particles for which e/m is of the same order as that deduced from the consideration of purely electrical phenomena. These small negatively electrified particles are called corpuscles. The latest determinations of e/m for corpuscles available are the following:—

Observer.	e/m .
Classen (<i>Ber. deut. phys. Ges.</i> 6, p. 700).	1.7728×10^7
Bucherer (<i>Ann. der Phys.</i> , 28, p. 513).	1.763×10^7

It follows from electrical theory that when the corpuscles are moving with a velocity comparable with that of light their masses increase rapidly with their velocity. This effect has been detected by Kauffmann (*Gött. Nach.*, Nov. 8, 1901), who used the corpuscles shot out from radium, some of which move with velocities only a few per cent less than that of light. Other experiments on this point have been made by Bucherer (*Ann. der Phys.* 28, p. 513).

Conductivity Produced by Ultra-Violet Light.—So much use has been made in recent times of ultra-violet light for producing ions that it is desirable to give some account of the electrical effects produced by light. The discovery by Hertz (*Wied. Ann.* 31, p. 983) in 1887, that the incidence of ultra-violet light on a spark gap facilitates the passage of a spark, led to a series of investigations by Hallwachs, Hoor, Righi and Stoletow, on the effect of ultra-violet light on electrified bodies. These researches have shown that a freshly cleaned metal surface, charged with negative electricity, rapidly loses its charge, however small, when exposed to ultra-violet light, and that if the surface is insulated and without charge initially, it acquires a positive charge under

the influence of the light. The magnitude of this positive charge may be very much increased by directing a blast of air on the plate. This, as Zelený (*Phil. Mag.* [5], 45, p. 272) showed, has the effect of blowing from the neighbourhood of the plate negatively electrified gas, which has similar properties to the charged gas obtained by the separation of ions from a gas exposed to Röntgen rays or uranium radiation. If the metal plate is positively electrified, there is no loss of electrification caused by ultra-violet light. This has been questioned, but a very careful examination of the question by Elster and Geitel (*Wied. Ann.* 57, p. 24) has shown that the apparent exceptions are due to the accidental exposure to reflected ultra-violet light of metal surfaces in the neighbourhood of the plate negatively electrified by induction, so that the apparent loss of charge is due to negative electricity coming up to the plate, and not to positive electricity going away from it. The ultra-violet light may be obtained from an arc-lamp, the effectiveness of which is increased if one of the terminals is made of zinc or aluminium, the light from these substances being very rich in ultra-violet rays; it may also be got very conveniently by sparking with an induction coil between zinc or cadmium terminals. Sunlight is not rich in ultra-violet light, and does not produce anything like so great an effect as the arc light. Elster and Geitel, who have investigated with great success the effects of light on electrified bodies, have shown that the more electro-positive metals lose negative charges when exposed to ordinary light, and do not need the presence of the ultra-violet rays. Thus they found that amalgams of sodium or potassium enclosed in a glass vessel lose a negative charge when exposed to daylight, though the glass stops the small amount of ultra-violet light left in sunlight after its passage through the atmosphere. If sodium or potassium be employed, or, what is more convenient, the mercury-like liquid obtained by mixing sodium and potassium in the proportion of their combining weights, they found that negative electricity was discharged by an ordinary petroleum lamp. If the still more electro-positive metal rubidium is used, the discharge can be produced by the light from a glass rod just heated to redness; but there is no discharge till the glass is luminous. Elster and Geitel arrange the metals in the following order for the facility with which negative electrification is discharged by light: rubidium, potassium, alloy of sodium and potassium, sodium, lithium, magnesium, thallium, zinc. With copper, platinum, lead, iron, cadmium, carbon and mercury the effects with ordinary light are too small to be appreciable. The order is the same as that in Volta's electro-chemical series. With ultra-violet light the different metals show much smaller differences in their power of discharging negative electricity than they do with ordinary light. Elster and Geitel found that the ratio of the photo-electric effects of two metals exposed to approximately monochromatic light depended upon the wave-length of the light, different metals showing a maximum sensitiveness in different parts of the spectrum. This is shown by the following table for the alkaline metals. The numbers in the table are the rates of emission of negative electricity under similar circumstances. The rate of emission under the light from a petroleum lamp was taken as unity:—

	Blue.	Yellow.	Orange.	Red.
Rb16	.64	.33	.039
Na37	.36	.14	.009
K57	.07	.04	.002

The table shows that the absorption of light by the metal has great influence on the photo-electric effect, for while potassium is more sensitive in blue light than sodium, the strong absorption of yellow light by sodium makes it more than five times more sensitive to this light than potassium. Stoletow, at an early period, called attention to the connexion between strong absorption and photo-electric effects. He showed that water, which does not absorb to any great extent either the ultra-violet or visible rays, does not show any photo-electric effect, while strongly coloured solutions, and especially solutions of fluorescent substances such as methyl green or methyl violet, do so to a very considerable extent; indeed, a solution of methyl green is more sensitive than zinc. Hallwachs (*Wied. Ann.* 37, p. 666) proved

that in liquids showing photo-electric effects there is always strong absorption; we may, however, have absorption without these effects. Phosphorescent substances, such as calcium sulphide show this effect, as also do various specimens of fluor-spar. As phosphorescence and fluorescence are probably accompanied by a very intense absorption by the surface layers, the evidence is strong that to get the photo-electric effects we must have strong absorption of some kind of light, either visible or ultra-violet.

If a conductor A is placed near a conductor B exposed to ultra-violet light, and if B is made the negative electrode and a difference of potential established between A and B, a current of electricity will flow between the conductors. The relation between the magnitude of the current and the difference of potential

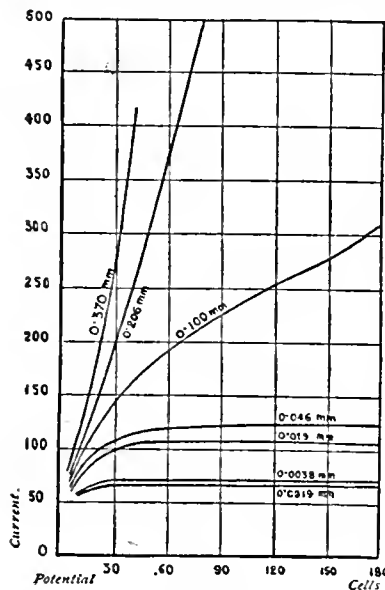

FIG. 14.

when A and B are parallel plates has been investigated by Stoletow (*Journal de physique*, 1890, 11, p. 469), von Schweidler (*Wien., Ber.*, 1899, 108, p. 273) and Varley (*Phil. Trans. A.*, 1904, 202, p. 439). The results of some of Varley's experiments are represented in the curves shown in fig. 14, in which the ordinates are the currents and the abscissae the potentials. It will be seen that when the pressure is exceedingly low the current is independent of the potential difference and is equal to the negative charge carried off in unit time by the corpuscles emitted from the surface exposed to the light. At higher pressures the current rises far above these values and increases rapidly with the potential difference. This is due to the corpuscles emitted by the illuminated surface acquiring under the electric field such high velocities that when they strike against the molecules of the gas through which they are passing they ionize them, producing fresh ions which can carry on additional current. The relation between the current and the potential difference in this case is in accordance with the results of the theory of ionization by collision. The corpuscles emitted from a body under the action of ultra-violet light start from the surface with a finite velocity. The velocity is not the same for all the corpuscles, nor indeed could we expect that it should be: for as Ladenburg has shown (*Ann. der Phys.*, 1903, 12, p. 558) the seat of their emission is not confined to the surface layer of the illuminated metal but extends to a layer of finite, though small, thickness. Thus the particles which start deep down will have to force their way through a layer of metal before they reach the surface, and in doing so will have their velocities retarded by an amount depending on the thickness of this layer. The variation in the velocity of the corpuscles is shown in the following table, due to Lenard (*Ann. der Phys.*, 1902, 8, p. 149).

	Carbon.	Platinum.	Aluminium.
Corpuscles emitted with velocities between 12 and 8×10^7 cm sec.	0.000	0.000	0.004
with velocities between 8 and 4×10^7 cm sec.	0.049	0.155	0.151
with velocities between 4 and 0×10^7 cm sec.	0.67	0.65	0.49
Corpuscles only emitted with the help of an external electric field	0.28	0.21	0.35
	1.00	1.00	1.00

If the illuminated surface is completely surrounded by an envelope of the same metal insulated from and completely shielded from the light, the emission of the negative corpuscles from the illuminated surface would go on until the potential difference V between this surface and the envelope became so great that the corpuscles with the greatest velocity lost their energy before reaching the envelope, i.e. if m is the mass, e the charge on a corpuscle, v the greatest velocity of projection, until $Ve = \frac{1}{2}mv^2$. The values found for V by different observers are not very consistent. Lenard found that V for aluminium was about 3 volts and for platinum 2. Millikan and Winchester (*Phil. Mag.*, July 1907) found for aluminium $V = .738$. The apparatus used by them was so complex that the interpretation of their results is difficult.

An extremely interesting fact discovered by Lenard is that the velocity with which the corpuscles are emitted from the metal is independent of the intensity of the incident light. The quantity of corpuscles increases with the intensity, but the velocity of the individual corpuscles does not. It is worthy of notice that in other cases when negative corpuscles are emitted from metals, as for example when the metals are exposed to cathode rays, Canal-strahlen, or Röntgen rays, the velocity of the emitted corpuscles is independent of the intensity of the primary radiation which excites them. The velocity is not, however, independent of the nature of the primary rays. Thus when light is used to produce the emission of corpuscles the velocity, as Ladenburg has shown, depends on the wave length of the light, increasing as the wave length diminishes. The velocity of corpuscles emitted under the action of cathode rays is greater than that of those ejected by light, while the incidence of Röntgen rays produces the emission of corpuscles moving much more rapidly than those in the cases already mentioned, and the harder the primary rays the greater is the velocity of the corpuscles.

The importance of the fact that the velocity and therefore the energy of the corpuscles emitted from the metal is independent of the intensity of the incident light can hardly be overestimated. It raises the most fundamental questions as to the nature of light and the constitution of the molecules. What is the source of the energy possessed by these corpuscles? Is it the light, or in the stores of internal energy possessed by the molecule? Let us follow the consequences of supposing that the energy comes from the light. Then, since the energy is independent of the intensity of the light, the electric forces which liberate the corpuscles must also be independent of that intensity. But this cannot be the case if, as is usually assumed in the electromagnetic theory, the wave front consists of a uniform distribution of electric force without structure, for in this case the magnitude of the electric force is proportional to the square root of the intensity. On the emission theory of light a difficulty of this kind would not arise, for on that theory the energy in a luminiferous particle remains constant as the particle pursues its flight through space. Thus any process which a single particle is able to effect by virtue of its energy will be done just as well a thousand miles away from the source of light as at the source itself, though of course in a given space there will not be nearly so many particles to do this process far from the source as there are close in. Thus, if one of the particles when it struck against a piece of metal caused the ejection of a corpuscle with a given velocity, the velocity of emission would not depend on the intensity of the light. There does not seem any reason for believing that the electromagnetic theory is inconsistent with the idea that on this theory, as on the emission theory, the energy in the light wave may instead of being uniformly distributed through space be concentrated in bundles which occupy only a small fraction of the volume traversed by the light, and that as the wave travels out the bundles get farther apart, the energy in each remaining undiminished. Some such view of the structure of light seems to be required to account for the fact that when a plate of metal is struck by a wave of ultra-violet light, it would take years before the corpuscles emitted from the metal would equal in number the molecules on the surface of the metal plate, and yet on the ordinary theory of light each one of these is without interruption exposed to the action of

the light. The fact discovered by E. Ladenburg (*Verh. d. deutsch. physik. Ges.* 9, p. 504) that the velocity with which the corpuscles are emitted depends on the wave length of the light suggests that the energy in each bundle depends upon the wave length and increases as the wave length diminishes.

These considerations illustrate the evidence afforded by photo-electric effects on the nature of light; these effects may also have a deep significance with regard to the structure of matter. The fact that the energy of the individual corpuscles is independent of the intensity of the light might be explained by the hypothesis that the energy of the corpuscles does not come from the light but from the energy stored up in the molecules of the metal exposed to the light. We may suppose that under the action of the light some of the molecules are thrown into an unstable state and explode, ejecting corpuscles; the light in this case acts only as a trigger to liberate the energy in the atom, and it is this energy and not that of the light which goes into the corpuscles. In this way the velocity of the corpuscles would be independent of the intensity of the light. But it may be asked, is this view consistent with the result obtained by Ladenburg that the velocity of the corpuscles depends upon the nature of the light? If light of a definite wave length expelled corpuscles with a definite and uniform velocity, it would be very improbable that the emission of the corpuscles is due to an explosion of the atoms. The experimental facts as far as they are known at present do not allow us to say that the connexion between the velocity of the corpuscles and the wave length of the light is of this definite character, and a connexion such as a gradual increase of average velocity as the wave length of the light diminishes, would be quite consistent with the view that the corpuscles are ejected by the explosion of the atom. For in a complex thing like an atom there may be more than one system which becomes unstable when exposed to light. Let us suppose that there are two such systems, A and B, of which B ejects the corpuscles with the greater velocity. If B is more sensitive to the short waves, and A to the long ones, then as the wave length of the light diminishes the proportion of the corpuscles which come from B will increase, and as these are the faster, the average velocity of the corpuscles emitted will also increase. And although the potential acquired by a perfectly insulated piece of metal when exposed to ultra-violet light would depend only on the velocity of the fastest corpuscles and not upon their number, in practice perfect insulation is unattainable, and the potential actually acquired is determined by the condition that the gain of negative electricity by the metal through lack of insulation, is equal to the loss by the emission of negatively electrified corpuscles. The potential acquired will fall below that corresponding to perfect insulation by an amount depending on the number of the faster corpuscles emitted, and the potential will rise if the proportion of the rapidly moving corpuscles is increased, even though there is no increase in their velocity. It is interesting to compare other cases in which corpuscles are emitted with the case of ultra-violet light. When a metal or gas is bombarded by cathode rays it emits corpuscles and the velocity of these is found to be independent of the velocity of the cathode rays which excite them; the velocity is greater than for corpuscles emitted under ultra-violet light. Again, when bodies are exposed to Röntgen rays they emit corpuscles moving with a much greater velocity than those excited by cathode rays, but again the velocity does not depend upon the intensity of the rays although it does to some extent on their hardness. In the case of cathode and Röntgen rays, the velocity with which the corpuscles are emitted seems, as far as we know at present, to vary slightly, but only slightly, with the nature of the substance on which the rays fall. May not this indicate that the first effect of the primary rays is to detach a neutral doublet, consisting of a positive and negative charge, this doublet being the same from whatever system it is detached? And that the doublet is unstable and explodes, expelling the negative charge with a high velocity, and the positive one, having a much larger charge, with a much smaller velocity, the momentum of the negative charge being equal to that of the positive.

Up to now we have been considering the effects produced when light is incident on metals. Lenard found (and the result has been confirmed by the experiments of J. J. Thomson and Lyman) that certain kinds of ultra-violet light ionize a gas when they pass through. The type of ultra-violet light which produces this effect is so easily absorbed that it is stopped by a layer a few millimetres thick of air at atmospheric pressure.

Ionization by Collision.—When the ionization of the gas is produced by external agents such as Röntgen rays or ultra-violet light, the electric field produces a current by setting the positive ions moving in one direction, and the negative ones in the opposite; it makes use of ions already made and does not itself give rise to ionization. In many cases, however, such as in electric sparks, there are no external agents to produce ionization and the electric field has to produce the ions as well as set them in motion. When the ionization is produced by external means the smallest electric field is able to produce a current through the gas; when, however, these external means are absent no current is produced unless the strength of the electric field exceeds a certain critical value, which depends not merely upon the nature of the gas but also upon the pressure and the dimensions of the vessel in which it is contained. The variation of the electric field required to produce discharge can be completely explained if we suppose that the ionization of the gas is produced by the impact with its molecules of corpuscles, and in certain cases of positive ions, which under the influence of the electric field have acquired considerable kinetic energy. We have direct evidence that rapidly moving corpuscles are able to ionize molecules against which they strike, for the cathode rays consist of such corpuscles, and these when they pass through a gas produce large amounts of ionization. Suppose then that we have in a gas exposed to an electric field a few corpuscles. These will be set in motion by the field and will acquire an amount of energy in proportion to the product of the electric force, their charge, and the distance travelled in the direction of the electric field between two collisions with the molecules of the gas. If this energy is sufficient to give them the ionizing property possessed by cathode rays, then when a corpuscle strikes against a molecule it will detach another corpuscle; this under the action of the electric field will acquire enough energy to produce corpuscles on its own account, and so as the corpuscles move through the gas their number will increase in geometrical progression. Thus, though there were but few corpuscles to begin with, there may be great ionization after these have been driven some distance through the gas by the electric field.

The number of ions produced by collisions can be calculated by the following method. Let the electric force be parallel to the axis of x , and let n be the number of corpuscles per unit volume at a place fixed by the co-ordinate x ; then in unit time these corpuscles will make nu/λ collisions with the molecules, if u is the velocity of a corpuscle and λ the mean free path of a corpuscle. When the corpuscles are moving fast enough to produce ions by collision their velocities are very much greater than those they would possess at the same temperature if they were not acted on by electrical force, and so we may regard the velocities as being parallel to the axis of x and determined by the electric force and the mean free path of the corpuscles. We have to consider how many of the nu/λ collisions which take place per second will produce ions. We should expect that the ionization of a molecule would require a certain amount of energy, so that if the energy of the corpuscle fell below this amount no ionization would take place, while if the energy of the corpuscle were exceedingly large, every collision would result in ionization. We shall suppose that a certain fraction of the number of collisions result in ionization and that this fraction is a function of the energy possessed by the corpuscle when it collides against the molecules. This energy is proportional to $Xe\lambda$ when X is the electric force, e the charge on the corpuscle, and λ the mean free path. If the fraction of collisions which produce ionization is $f(Xe\lambda)$, then the number of ions produced per cubic centimetre per second is $f(Xe\lambda)nu/\lambda$. If the collisions follow each other with great rapidity so that a molecule has not had time to recover from one collision, before it is struck again, the effect of collisions might be cumulative, so that a succession of collisions might give rise to ionization, though none of the collisions would produce an ion by itself. In this case f would involve the frequency of the collisions as well as the energy of the corpuscle; in other words, it might depend on the current through the gas as well as upon the intensity of the electric field.

We shall, however, to begin with, assume that the current is so small that this cumulative effect may be neglected.

Let us now consider the rate of increase, dn/dt , in the number of corpuscles per unit volume. In consequence of the collisions, $f(Xe\lambda)nu/\lambda$ corpuscles are produced per second; in consequence of the motion of the corpuscles, the number which leave unit volume per second is greater than those which enter it by $\frac{d}{dx}(nu)$; while in a certain number of collisions a corpuscle will stick to the molecule and will thus cease to be a free corpuscle. Let the fraction of the number of collisions in which this occurs be β . Thus the gain in the number of corpuscles is $f(Xe\lambda)nu/\lambda$, while the loss is $\frac{d}{dx}(nu) + \beta\frac{nu}{\lambda}$; hence

$$\frac{dn}{dt} = f(Xe\lambda)\frac{nu}{\lambda} - \frac{d}{dx}(nu) - \frac{\beta nu}{\lambda}$$

When things are in a steady state $dn/dt = 0$, and we have

$$\frac{d}{dx}(nu) = \frac{1}{\lambda}(f(Xe\lambda) - \beta)nu$$

If the current is so small that the electrical charges in the gas are not able to produce any appreciable variations in the field, X will be constant and we get $nu = Ce^{ax}$, where $a = \{f(Xe\lambda) - \beta\}/\lambda$. If we take the origin from which we measure x at the cathode, C is the value of nu at the cathode, i.e. it is the number of corpuscles emitted per unit area of the cathode per unit time; this is equal to i_0/e if i_0 is the quantity of negative electricity coming from unit area of the cathode per second, and e the electric charge carried by a corpuscle. Hence we have $nu = i_0 e^{ax}$. If l is the distance between the anode and the cathode, the value of nu , when $x = l$, is the current passing through unit area of the gas, if we neglect the electricity carried by negatively electrified carriers other than corpuscles. Hence $i = i_0 e^{al}$. Thus the current between the plates increases in geometrical progression with the distance between the plates.

By measuring the variation of the current as the distance between the plates is increased, Townsend, to whom we owe much of our knowledge on this subject, determined the values of a for different values of X and for different pressures for air, hydrogen and carbonic acid gas (*Phil. Mag.* [6], 1, p. 198). Since λ varies inversely as the pressure, we see that a may be written in the form $p\phi(X/p)$ or $a/X = F(X/p)$. The following are some of the values of a found by Townsend for air.

X Volts per cm.	Pressure .17 mm.	Pressure .38 mm.	Pressure 1.10 mm.	Pressure 2.1 mm.	Pressure 4.1 mm.
20	.24				
40	.65				
80	1.35	.34			
120	1.8	2.0	.45	.13	
160	2.1	2.8	2.0	.9	.42
200		3.4	2.8	1.6	.5
240	2.45	3.8	4.0	2.35	.99
320	2.7	4.5	5.5	4.0	2.1
400		5.0	6.8	6.0	3.6
480	3.15	5.4	8.0	7.8	5.3
560		5.8	9.3	9.4	7.1
640	3.25	6.2	10.6	10.8	8.9

We see from this table that for a given value of X , a for small pressures increases as the pressure increases; it attains a maximum at a particular pressure, and then diminishes as the pressure increases. The increase in the pressure increases the number of collisions, but diminishes the energy acquired by the corpuscle in the electric field, and thus diminishes the change of any one collision resulting in ionization. If we suppose the field is so strong that at some particular pressure the energy acquired by the corpuscle is well above the value required to ionize at each collision, then it is evident that increasing the number of collisions will increase the amount of ionization, and therefore a , and a cannot begin to diminish until the pressure has increased to such an extent that the mean free path of a corpuscle is so small that the energy acquired by the corpuscle from the electric field falls below the value when each collision results in ionization.

The value of p , when X is given, for which a is a maximum, is proportional to X ; this follows at once from the fact that a is of the form $X \cdot F(X/p)$. The value of X/p for which $F(X/p)$ is a maximum is seen from the preceding table to be about 420, when X is expressed in volts per centimetre and p in millimetres of mercury. The maximum value of $F(X/p)$ is about 1/60. Since the current passing between two planes at a distance l apart is $i_0 e^{al}$ or $i_0 e^{XlF(X/p)}$, and since the force between the plates is supposed to be uniform, Xl is equal to V , the potential between the plates; hence the current between the plates is $i_0 e^{VF(X/p)}$, and the greatest value it can have is $i_0 e^{V/60}$. Thus the ratio between the current between the plates when there is ionization and when there is none cannot be greater than $e^{V/60}$, when V is measured in volts. This result is based on Townsend's experiments with very weak currents; we must remember, however, that when the collisions are so frequent

that the effects of collisions can accumulate, a may have much larger values than when the current is small. In some experiments made by J. J. Thomson with intense currents from cathodes covered with hot lime, the increase in the current when the potential difference was 60 volts, instead of being e times the current when there was no ionization, as the preceding theory indicates, was several hundred times that value, thus indicating a great increase in a with the strength of the current.

Townsend has shown that we can deduce from the values of a the mean free path of a corpuscle. For if the ionization is due to the collisions with the corpuscles, then unless one collision detaches more than one corpuscle the maximum number of corpuscles produced will be equal to the number of collisions. When each collision results in the production of a corpuscle, $a = 1/\lambda$ and is independent of the strength of the electric field. Hence we see that the value of a , when it is independent of the electric field, is equal to the reciprocal of the free path. Thus from the table we infer that at a pressure of 17 mm. the mean free path is 1/325 cm.; hence at 1 mm. the mean free path of a corpuscle is 1/19 cm. Townsend has shown that this value of the mean free path agrees well with the value 1/21 cm. deduced from the kinetic theory of gases for a corpuscle moving through air. By measuring the values of a for hydrogen and carbonic acid gas Townsend and Kirby (*Phil. Mag.* [6], 1, p. 630) showed that the mean free paths for corpuscles in these gases are respectively 1/11.5 and 1/29 cm. at a pressure of 1 mm. These results again agree well with the values given by the kinetic theory of gases.

If the number of positive ions per unit volume is m and v is the velocity, we have $nue + mve = i$, where i is the current through unit area of the gas. Since $nu = i_0 e^{ax}$ and $i = i_0 e^{al}$, when l is the distance between the plates, we see that

$$\begin{aligned} nu/mv &= e^{ax}/(e^{al} - e^{-ax}), \\ \frac{n}{m} &= \frac{v}{u} \cdot \frac{e^{ax}}{e^{al} - e^{-ax}}. \end{aligned}$$

Since v/u is a very small quantity we see that n will be less than m except when $e^{al} - e^{-ax}$ is small, i.e. except close to the anode. Thus there will be an excess of positive electricity from the cathode almost up to the anode, while close to the anode there will be an excess of negative. This distribution of electricity will make the electric force diminish from the cathode to the place where there is as much positive as negative electricity, where it will have its minimum value, and then increase up to the anode.

The expression $i = i_0 e^{ax}$ applies to the case when there is no source of ionization in the gas other than the collisions; if in addition to this there is a source of uniform ionization producing q ions per cubic centimetre, we can easily show that

$$i = i_0 e^{al} + \frac{qe}{a}(e^{al} - 1).$$

With regard to the minimum energy which must be possessed by a corpuscle to enable it to produce ions by collision, Townsend (*loc. cit.*) came to the conclusion that to ionize air the corpuscle must possess an amount of energy equal to that acquired by the fall of its charge through a potential difference of about 2 volts. This is also the value arrived at by H. A. Wilson by entirely different considerations. Stark, however, gives 17 volts as the minimum for ionization. The energy depends upon the nature of the gas; recent experiments by Dawes and Gill and Pedduck (*Phil. Mag.*, Aug. 1908) have shown that it is smaller for helium than for air, hydrogen, or carbonic acid gas.

If there is no external source of ionization and no emission of corpuscles from the cathode, then it is evident that even if some corpuscles happened to be present in the gas when the electric field were applied, we could not get a permanent current by the aid of collisions made by these corpuscles. For under the electric field, the corpuscles would be driven from the cathode to the anode, and in a short time all the corpuscles originally present in the gas and those produced by them would be driven from the gas against the anode, and if there was no source from which fresh corpuscles could be introduced into the gas the current would cease. The current, however, could be maintained indefinitely if the positive ions in their journey back to the cathode also produced ions by collisions, for then we should have a kind of regenerative process by which the supply of corpuscles could be continually renewed. To maintain the current it is not necessary that the ionization resulting from the positive ions should be anything like as great as that from the negative, as the investigation given below shows a very small amount of ionization by the positive ions will suffice to maintain the current. The existence of ionization by collision with positive ions has been proved by Townsend. Another method by which the current could be and is maintained is by the anode emitting corpuscles under the impact of the positive ions driven against it by the electric field. J. J. Thomson has shown by direct experiment that positively

electrified particles when they strike against a metal plate cause the metal to emit corpuscles (J. J. Thomson, *Proc. Camb. Phil. Soc.* 13, p. 212; Austin, *Phys. Rev.* 22, p. 312). If we assume that the number of corpuscles emitted by the plate in one second is proportional to the energy in the positive ions which strike the plate in that second, we can readily find an expression for the difference of potential which will maintain without any external ionization a current of electricity through the gas. As this investigation brings into prominence many of the most important features of the electric discharge, we shall consider it in some detail.

Let us suppose that the electrodes are parallel plates of metal at right angles to the axis of x , and that at the cathode $x=0$ and at the anode $x=d$, d being thus the distance between the plates. Let us also suppose that the current of electricity flowing between the plates is so small that the electrification between the plates due to the accumulation of ions is not sufficient to disturb appreciably the electric field, which we regard as uniform between the plates, the electric force being equal to V/d , where V is the potential difference between the plates. The number of positive ions produced per second in a layer of gas between the planes x and $x+dx$ is $anu \cdot dx$. Here n is the number of corpuscles per unit volume, a the coefficient of ionization (for strong electric field $a = 1/\lambda'$, where λ' is the mean free path of a corpuscle), and u the velocity of a corpuscle parallel to x . We have seen that $nu = i_0 e^{ax}$, where i_0 is the number of corpuscles emitted per second by unit area of the cathode. Thus the number of positive ions produced in the layer is $ai_0 e^{ax} dx$. If these went straight to the cathode without a collision, each of them would have received an amount of kinetic energy Vex/d when they struck the cathode, and the energy of the group of ions would be $Vex/d \cdot ai_0 e^{ax} dx$. The positive ions will, however, collide with the molecules of the gas through which they are passing, and this will diminish the energy they possess when they reach the cathode.

The diminution in the energy will increase in geometrical proportion with the length of path travelled by the ion and will thus be proportional to $e^{-\beta x}$, β will be proportional to the number of collisions and will thus be proportional to the pressure of the gas. Thus the kinetic energy possessed by the ions when they reach the cathode will be

$$e^{-\beta x} \cdot V(ex/d) \cdot ai_0 e^{ax} dx,$$

and E , the total amount of energy in the positive ions which reach the cathode in unit time, will be given by the equation

$$E = \int_0^d e^{-\beta x} \cdot V(ex/d) \cdot ai_0 e^{ax} dx \\ = \frac{V e a i_0}{d} \int_0^d e^{-(\beta-a)x} x dx \\ = \frac{V e a i_0}{d} \left\{ \frac{1}{(\beta-a)^2} - e^{-(\beta-a)d} \left\{ \frac{1}{(\beta-a)^2} + \frac{d}{(\beta-a)} \right\} \right\} \quad (1).$$

If the number of corpuscles emitted by the cathode in unit time is proportional to this energy we have $i_0 = kE$, where k is a constant; hence by equation (1) we have

$$V = \frac{(\beta-a)^2 d}{k e a} \cdot i,$$

where

$$I = I - e^{-(\beta-a)d} (1 + d(\beta-a)).$$

Since both β and a are proportional to the pressure, I and $(\beta-a)^2 d/a$ are both functions of pd , the product of the pressure and the spark length, hence we see that V is expressed by an equation of the form

$$V = \frac{1}{k e} f(pd) \quad (2),$$

where $f(pd)$ denotes a function of pd , and neither p nor d enter into the expression for V except in this product. Thus the potential difference required to produce discharge is constant as long as the product of the pressure and spark length remains constant; in other words, the spark potential is constant as long as the mass of the gas between the electrodes is constant. Thus, for example, if we halve the pressure the same potential difference will produce a spark of twice the length. This law, which was discovered by Paschen for fairly long sparks (*Annalen*, 37, p. 79), and has been shown by Carr (*Phil. Trans.*, 1903) to hold for short ones, is one of the most important properties of the electric discharge.

We see from the expression for V that when $(\beta-a)d$ is very large

$$V = (\beta-a)^2 d / k e a.$$

Thus V becomes infinite when d is infinite. Again when $(\beta-a)d$ is very small we find

$$V = 1 / k e a d;$$

thus V is again infinite when d is nothing. There must therefore be some value of d intermediate between zero and infinity for which V is a minimum. This value is got by finding in the usual way the

value of d , which makes the expression for V given in equation (1) a minimum. We find that d must satisfy the equation

$$1 = e^{-(\beta-a)d} [1 + (\beta-a)d + (\beta-a)^2 d^2].$$

We find by a process of trial and error that $(\beta-a)d = 1.8$ is approximately a solution of this equation; hence the distance for minimum potential is $1.8/(\beta-a)$. Since β and a are both proportional to the pressure, we see that the critical spark length varies inversely as the pressure. If we substitute this value in the expression for V , we find that \bar{V} , the minimum spark potential, is given by

$$\bar{V} = \frac{\beta-a}{a} \cdot \frac{2 \cdot 2}{k e}.$$

Since β and a are each proportional to the pressure, the minimum potential is independent of the pressure of the gas. On this view the minimum potential depends upon the metal of which the cathode is made, since k measures the number of corpuscles emitted per unit time by the cathode when struck by positive ions carrying unit energy, and unless β bears the same ratio to a for all gases the minimum potential will also vary with the gas. The measurements which have been made of the "cathode fall of potential," which as we shall see is equal to the minimum potential required to produce a spark, show that this quantity varies with the material of which the cathode is made and also with the nature of the gas. Since a metal plate, when bombarded by positive ions, emits corpuscles, the effect we have been considering must play a part in the discharge; it is not, however, the only effect which has to be considered, for as Townsend has shown, positive ions when moving above a certain speed ionize the gas, and cause it to emit corpuscles. It is thus necessary to take into account the ionization of the positive ions.

Let m be the number of positive ions per unit volume, and w their velocity, the number of collisions which occur in one second in one cubic centimetre of the gas will be proportional to $m w \rho$, where ρ is the pressure of the gas. Let the number of ions which result from these collisions be $\gamma m w$; γ will be a function of ρ and of the strength of the electric field. Let as before n be the number of corpuscles per cubic centimetre, u their velocity, and anu the number of ions which result in one second from the collisions between the corpuscles and the gas. The number of ions produced per second per cubic centimetre is equal to $anu + \gamma m w$; hence when things are in a steady state

$$\frac{d}{dx}(nu) = anu + \gamma m w,$$

and

$$e(nu + mw) = i,$$

where e is the charge on the ion and i the current through the gas. The solution of these equations when the field is uniform between the plates, is

$$nu = C e^{(a-\gamma)x} - \gamma i / (a-\gamma), \quad emw = -C e^{(a-\gamma)x} + ai / (a-\gamma),$$

where C is a constant of integration. If there is no emission of positive ions from the anode $enu = i$, when $x=d$. Determining C from this condition we find

$$enu = \frac{i}{a-\gamma} \left\{ u e^{(a-\gamma)(x-d)} - \gamma \right\}, \quad emw = \frac{ai}{a-\gamma} \left\{ 1 - e^{(a-\gamma)(x-d)} \right\}.$$

If the cathode did not emit any corpuscles owing to the bombardment by positive ions, the condition that the charge should be maintained is that there should be enough positive ions at the cathode to carry the current *i.e.* that $emw = i$; when $x=0$, the condition gives

$$\frac{i}{a-\gamma} \left\{ a e^{-(a-\gamma)d} - \gamma \right\} = 0,$$

or

$$e^{ad} / a = e^{\gamma d} / \gamma.$$

Since a and γ are both of the form $p f(X/p)$ and $X = V/d$, we see that V will be a function of pd , in agreement with Paschen's law. If we take into account both the ionization of the gas and the emission of corpuscles by the metal we can easily show that

$$\frac{a-\gamma e^{(a-\gamma)d}}{a-\gamma} = \frac{k a V e}{d} \left[\frac{1}{(\beta+\gamma-a)^2} - e^{-(\beta+\gamma-a)d} \left\{ \frac{1}{(\beta+\gamma-a)^2} + \frac{d}{\beta+\gamma-a} \right\} \right],$$

where k and β have the same meaning as in the previous investigation. When d is large, $e^{(a-\gamma)d}$ is also large; hence in order that the left-hand side of this equation should not be negative γ must be less than $a/e^{(a-\gamma)d}$; as this diminishes as d increases we see that when the sparks are very long discharge will take place, practically as soon as γ has a finite value, *i.e.* as soon as the positive ions begin to produce fresh ions by their collisions.

In the preceding investigation we have supposed that the electric field between the plates was uniform; if it were not uniform we could get discharges produced by very much smaller differences of potential than are necessary in a uniform field. For to maintain the discharge it is not necessary that the positive ions should act as ionizers all along their path; it is sufficient that they should do so in the neighbourhood of cathode. Thus if we have a strong field close to the cathode we might still get

the discharge though the rest of the field were comparatively weak. Such a distribution of electric force requires, however, a great accumulation of charged ions near the cathode; until these ions accumulate the field will be uniform. If the uniform field existing in the gas before the discharge begins were strong enough to make the corpuscles produce ions by collision, but not strong enough to make the positive ions act as ionizers, there would be some accumulation of ions, and the amount of this accumulation would depend upon the number of free corpuscles originally present in the gas, and upon the strength of the electric field. If the accumulation were sufficient to make the field near the cathode so strong that the positive ions could produce fresh ions either by collision with the cathode or with the gas, the discharge would pass through the gas; if not, there will be no continuous discharge. As the amount of the accumulation depends on the number of corpuscles present in the gas, we can understand how it is that after a spark has passed, leaving for a time a supply of corpuscles behind it, it is easier to get a discharge to pass through the gas than it was before.

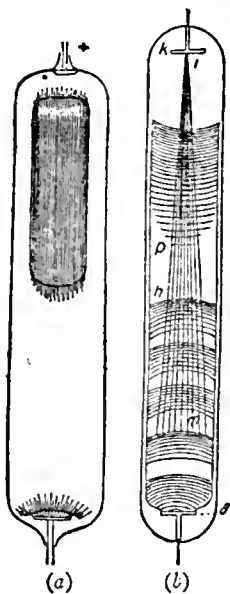

FIG. 15.

Starting from the cathode we have a thin velvety luminous glow in contact with the surface; this glow is often called the "first cathode layer." Next this we have a comparatively dark space whose thickness increases as the pressure diminishes; this is called the "Crookes's dark space," or the "second cathode layer." Next this we have a luminous position called the "negative glow" or the "third cathode layer." The boundary between the second and third layers is often very sharply defined. Next to the third layer we have another dark space called the "Faraday dark space." Next to this and reaching up to the anode is another region of luminosity, called the "positive column," sometimes (as in fig. 15, a) continuous, sometimes (as in fig. 15, b) broken up into light or dark patches called "striations." The dimensions of the Faraday dark space and the positive column vary greatly with the current passing through the gas and with its pressure; sometimes one or other of them is absent. These differences in appearances are accompanied by great difference in the strength of the electric field. The magnitude of the electric force at different parts of the discharge is represented in fig. 16, where the ordinates represent the electric force at different parts of the tube, the cathode being on the right.

We see that the electric force is very large indeed between the negative glow and the cathode, much larger than in any other part of the tube. It is not constant in this region, but increases as we approach the cathode. The force reaches a minimum either in the negative glow itself or in the part of the Faraday dark space just outside, after which it increases towards the positive column. In the case of a uniform positive column the electric force along it is constant until we get quite close to the anode, when a sudden change, called the "anode fall," takes place in the potential.

The difference of potential between the cathode and the

negative glow is called the "cathode potential fall" and is found to be constant for wide variations in the pressure of the gas and the current passing through. It increases, however, considerably when the current through the gas exceeds a certain critical value, depending among other things on the size of the cathode. This cathode fall of potential is shown by experiment to be very approximately equal to the minimum potential difference. The following table contains a comparison of the measurements of the cathode fall of potentials in various gases made by Warburg (*Wied. Ann.*, 1887, 31, p. 545, and 1890, 40,

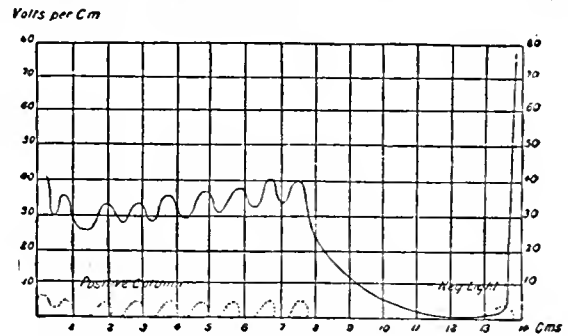

Pressure 2.25 m.m. Discharge in Hydrogen Current 0.568'10^-3 amperes

FIG. 16.

p. 1), Capstick (*Proc. Roy. Society*, 1898, 63, p. 356), and Strutt (*Phil. Trans.*, 1900, 193, p. 377), and the measurements by Strutt of the smallest difference of potential which will maintain a spark through these gases.

Gas.	Cathode fall in Volts.				Least potential difference required to maintain a Spark.
	Platinum Electrodes.			Aluminium Electrodes.	
	Warburg.	Capstick.	Strutt.	Warburg.	Strutt.
Air	340-350	341
H ₂	about 300	.298	..	168	302-308
O ₂	369
N ₂	230 if free from oxygen	232	..	207	251
Hg vapour	340
Helium	226	..	261-326
H ₂ O	469
NH ₃	582

Thus in the cases in which the measurements could be made with the greatest accuracy the agreement between the cathode fall and the minimum potential difference is very close. The cathode fall depends on the material of which the terminals are made, as is shown by the following table due to Mey (*Verh. deutsch. physik. Gesell.*, 1903, 5, p. 72).

Gas.	Electrode.										
	Pt	Hg	Ag	Cu	Fe	Zn	Al	Mg	Na	Na-K	K
O ₂	369
H ₂	300	..	295	280	230	213	190	168	185	169	172
N ₂	232	226	207	178	125	170
He	226	80	78.5	69
Argon	167	100

The dependence of the minimum potential required to produce a spark upon the metal of which the cathode is made has not been clearly established, some observers being unable to detect any difference between the potential required to spark between electrodes of aluminium and those of brass, while others thought they had detected such a difference. It is only with sparks not much longer than the critical spark length that we could hope to detect this difference. When the current through the gas exceeds a certain critical value depending among other things on the size of the cathode, the cathode fall of potential increases rapidly and at the same time the thickness of the dark

spaces diminishes. We may regard the part of the discharge between the cathode and the negative glow as a discharge taking place under minimum potential difference through a distance equal to the critical spark length. An inspection of fig. 16 will show that we cannot regard the electric field as constant even for this small distance; it thus becomes a matter of interest to know what would be the effect on the minimum potential difference required to produce a spark if there were sufficient ions present to produce variations in the electric field analogous to those represented in fig. 16. If the electric force at a distance x from the cathode were proportional to e^{-px} we should have a state of things much resembling the distribution of electric force near the cathode. If we apply to this distribution the methods used above for the case when the force was uniform, we shall find that the minimum potential is less and the critical spark length greater than when the electric force is uniform.

Potential Difference required to produce a Spark of given Length.

—We may regard the region between the cathode and the negative glow as a place for the production of corpuscles, these corpuscles finding their way from this region through the negative glow. The parts of this glow towards the anode we may regard as a cathode, from which, as from a hot lime cathode, corpuscles are emitted. Let us now consider what will happen to these corpuscles shot out from the negative glow with a velocity depending on the cathode fall of potential and independent of the pressure. These corpuscles will collide with the molecules of the gas, and unless there is an external electric field to maintain their velocity they will soon come to rest and accumulate in front of the negative glow. The electric force exerted by this cloud of corpuscles will diminish the strength of the electric field in the region between the cathode and the negative glow, and thus tend to stop the discharge. To keep up the discharge we must have a sufficiently strong electric field between the negative glow and the anode to remove the corpuscles from this region as fast as they are sent into it from the cathode. If, however, there is no production of ions in the region between the negative glow and the anode, all the ions in this region will have come from near the cathode and will be negatively charged; this negative electrification will diminish the electric force on the cathode side of it and thus tend to stop the discharge. This back electric field could, however, be prevented by a little ionization in the region between the anode and glow, for this would afford a supply of positive ions, and thus afford an opportunity for the gas in this region to have in it as many positive as negative ions; in this case it would not give rise to any back electromotive force. The ionization which produces these positive ions may, if the field is intense, be due to the collisions of corpuscles, or it may be due to radiation analogous to ultra-violet, or soft Röntgen rays, which have been shown by experiment to accompany the discharge. Thus in the most simple conditions for discharge we should have sufficient ionization to keep up the supply of positive ions, and an electric field strong enough to keep the velocity of the negative corpuscle equal to the value it has when it emerges from the negative glow. Thus the force must be such as to give a constant velocity to the corpuscle, and since the force required to move an ion with a given velocity is proportional to the pressure, this force will be proportional to the pressure of the gas. Let us call this force ap ; then if l is the distance of the anode from the negative glow the potential difference between these points will be alp . The potential difference between the negative glow and the cathode is constant and equals c ; hence if V is the potential difference between the anode and cathode, then $V=c+alp$, a relation which expresses the connexion between the potential difference and spark length for spark lengths greater than the critical distance. It is to be remembered that the result we have obtained applies only to such a case as that indicated above, where the electric force is constant along the positive column. Experiments with the discharge through gases at low pressure show the discharge may take other forms. Thus the positive column may be striated when the force along it is no longer uniform,

or the positive column may be absent; the discharge may be changed from one of these forms to another by altering the current. The relation between the potential and the distance between the electrodes varies greatly, as we might expect, with the current passing through the gas.

The connexion between the potential difference and the spark length has been made the subject of a large number of experiments. The first measurements were made by Lord Kelvin in 1860 (*Collected Papers on Electrostatics and Magnetism*, p. 247); subsequent experiments have been made by Baille (*Ann. de chimie et de physique*, 5, 25, p. 486), Liebig (*Phil. Mag.* [5], 24, p. 106), Paschen (*Wied. Ann.* 37, p. 79), Peace (*Proc. Roy. Soc.*, 1892, 52, p. 99), Orgler (*Ann. der Phys.* 1, p. 159), Strutt (*Phil. Trans.* 193, p. 377), Bouty (*Comptes rendus*, 131, pp. 469, 503), Earhart (*Phil. Mag.* [6], 1, p. 147), Carr (*Phil. Trans.*, 1903), Russell (*Phil. Mag.* [5], 64, p. 237), Hobbs (*Phil. Mag.* [6], 10, p. 617), Kinsley (*Phil. Mag.* [6], 9, 692), Ritter (*Ann. der Phys.* 14, p. 118). The results of their experiments show that for sparks considerably longer than the critical spark length, the relation between the potential difference V and the spark length l may be expressed when the electrodes are large with great accuracy by the linear relation $V=c+blp$, where p is the pressure and c and b are constants depending on the nature of the gas. When the sparks are long the term blp is the most important and the sparking potential is proportional to the spark length. Though there are considerable discrepancies between the results obtained by different observers, these indicate that the production of a long spark between large electrodes in air at atmospheric pressure requires a potential difference of 30,000 volts for each centimetre of spark length. In hydrogen only about half this potential difference is required, in carbonic acid gas the potential difference is about the same as in air, while Ritter's experiments show that in helium only about one-tenth of this potential difference is required.

In the case when the electric field is not uniform, as for example when the discharge takes place between spherical electrodes, Russell's experiments show that the discharge takes place as soon as the maximum electric force in the field between the electrodes reaches a definite value, which he found was for air at atmospheric pressure about 38,000 volts per centimetre.

Very Short Sparks.—Some very interesting experiments on the potential difference required to produce exceedingly short sparks have been made by Earhart, Hobbs and Kinsley; the length of these sparks was comparable with the wave length of sodium light. With sparks of these lengths it was found that it was possible to get a discharge with less than 330 volts, the minimum potential difference in air. The results of these observers show that there is no diminution in the minimum potential difference required to produce discharge until the spark length gets so small that the average electric force between the electrodes amounts to about one million volts per centimetre. When the force rises to this value a discharge takes place even though the potential difference is much less than 330 volts; in some of Earhart's experiments it was only about 2 volts. This kind of discharge is determined not by the condition that the potential difference should have a given value, but that the electric force should have a given value. Another point in which this discharge differs from the ordinary one is that it is influenced entirely by the nature of the electrodes and not by the nature or pressure of the gas between them, whereas the ordinary discharge is in many cases not affected appreciably by changes in the metal of the electrodes, but is always affected by changes in the pressure and character of the gas between them. Kinsley found that when one of these small sparks passed between the electrodes a kind of metallic bridge was formed between them, so that they were in metallic connexion, and that the distance between them had to be considerably increased before the bridge was broken. Almy (*Phil. Mag.*, Sept. 1908), who used very small electrodes, was unable to get a discharge with less than the minimum spark potential even when the spark length was reduced to one-third of the wave length of sodium light. He suggests that the discharges obtained with larger electrodes for smaller voltages are

due to the electrodes being dragged together by the electrostatic attraction between them.

Constitution of the Electric Spark.—Schuster and Hemsalech (*Phil. Trans.* 193, p. 189), Hemsalech (*Comptes Rendus*, 130, p. 898; 132, p. 917; *Jour. de Phys.* 3, 9, p. 43, and Schenck, *Astrophys. Jour.* 14, p. 116) have by spectroscopic methods obtained very interesting results about the constitution of the spark. The method employed by Schuster and Hemsalech was as follows: Suppose we photograph the spectrum of a horizontal spark on a film which is on the rim of a wheel rotating about a horizontal axis with great velocity. If the luminosity travelled with infinite speed from one electrode to the other, the image on the film would be a horizontal line. If, however, the speed with which the luminosity travelled between the electrodes was comparable with the speed of the film, the line would be inclined to the horizontal, and by measuring the inclinations we could find the speed at which the luminosity travelled. In this way Schuster and Hemsalech showed that when an oscillating discharge passed between metallic terminals in air, the first spark passes through the air alone, no lines of the metal appearing in its spectrum. This first spark vaporizes some of the metal and the subsequent sparks passing mainly through the metallic vapour; the appearance of the lines in the film shows that the velocity of the luminous part of the vapour was finite. The velocity of the vapour of metals of low atomic weight was in general greater than that of the vapour of heavier metals. Thus the velocity of aluminium vapour was 1890 metres per second, that of zinc and cadmium only about 545. Perhaps the most interesting point in the investigation was the discovery that the velocities corresponding to different lines in the spectrum of the same metal were in some cases different. Thus with bismuth some of the lines indicated a velocity of 1420 metres per second, others a velocity of only 550, while one ($\lambda=3793$) showed a still smaller velocity. These results are in accordance with a view suggested by other phenomena that many of the lines in a spectrum produced by an electrical discharge originate from systems formed during the discharge and not from the normal atom or molecule. Schuster and Hemsalech found that by inserting a coil with large self induction in the primary circuit they could obliterate the air lines in the discharge.

Schenck, by observing the appearance presented when an alternating current, produced by discharging Leyden jars, was examined in a rapidly rotating mirror, found it showed the following stages: (1) a thin bright line, followed in some cases at intervals of half the period of the discharge by fainter lines; (2) bright curved streamers starting from the negative terminal, and diminishing rapidly in speed as they receded from the cathode; (3) a diffused glow lasting for a much longer period than either of the preceding. These constituents gave out quite different spectra.

The structure of the discharge is much more easily studied when the pressure of the gas is low, as the various parts which make up the discharge are more widely separated from each other. We have already described the general appearance of the discharge through gases at low pressures (see p. 657). There is, however, one form of discharge which is so striking and beautiful that it deserves more detailed consideration. In this type of discharge, known as the striated discharge, the positive column is made up of alternate bright and dark patches known as *striations*. Some of these are represented in fig. 17, which is taken from a paper by De la Rue and Müller (*Phil. Trans.*, 1878, Pt. 1). This type of discharge only occurs when the current and the pressure of the gas are between certain limits. It is most beautifully shown when a Wehnelt cathode is used and the current is produced by storage cells, as this allows us to use large currents and to maintain a steady potential difference between the electrodes. The striations are in consequence very bright and steady. The facts which have been established about these striations are as follows: The distance between the bright parts of the striations is greater at low pressures than at high; it depends also upon the diameter of the tube, increasing as the diameter of the tube increases. If the discharge tube is wide at

one place and narrow in another the striations will be closer together in the narrow parts than in the wide. The distance between the striations depends on the current through the tube. The relation is not a very simple one, as an increase of current sometimes increases while under other circumstances it decreases the distance between the striations (see Willows, *Proc. Camb. Phil. Soc.* 10, p. 302). The electric force is not uniform along the striated discharge, but is greater in the bright than in the dark parts of the striation. An example is shown in fig. 16, due to H. A. Wilson, which shows the distribution of electric force at every place in a striated discharge. In experiments made by J. J. Thomson (*Phil. Mag.*, Oct. 1909), using a Wehnelt cathode, the variations in the electric force were more pronounced than those

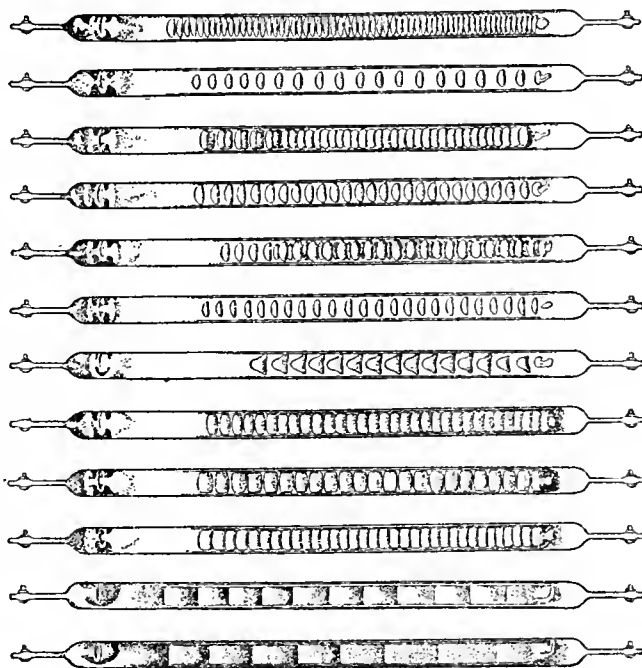

FIG. 17.

shown in fig. 16. The electric force in this case changed so greatly that it actually became negative just on the cathode side of the bright part of the striation. Just inside the striation on the anode side it rose to a very high value, then continually diminished towards the bright side of the next striation when it again increased. This distribution of electric force implies that there is great excess of negative electricity at the bright head of the striation, and a small excess of positive everywhere else. The temperature of the gas is higher in the bright than in the dark parts of the striations. Wood (*Wied. Ann.* 49, p. 238), who has made a very careful study of the distribution of temperature in a discharge tube, finds that in those tubes the temperature varies in the same way as the electric force, but that this temperature (which it must be remembered is the average temperature of all the molecules and not merely of those which are taking part in the discharge) is by no means high; in no part of the discharge did the temperature in his experiments exceed 100° C.

Theory of the Striations.—We may regard the heaping up of the negative charges at intervals along the discharge as the fundamental feature in the striations, and this heaping up may be explained as follows. Imagine a corpuscle projected with considerable velocity from a place where the electric field is strong, such as the neighbourhood of the cathode; as it moves towards the anode through the gas it will collide with the molecules, ionize them and lose energy and velocity. Thus unless the corpuscle is acted on by a field strong enough to supply it with the energy it loses by collision, its speed will gradually diminish. Further, when its energy falls below a certain value it will unite with a molecule and become part of a negative ion, instead of a corpuscle; at this stage there will be a sudden and

very large diminution in its velocity. Let us now follow the course of a stream of corpuscles starting from the cathode and approaching the anode. If the speed falls off as the stream proceeds, the corpuscles in the rear will gain on those in front and the density of the stream in the front will be increased. If at a certain place the velocity receives a sudden check by the corpuscles becoming loaded with a molecule, the density of the negative electricity will increase at this place with great rapidity, and here there will be a great accumulation of negative electricity, as at the bright head on the cathode side of a striation. Now this accumulation of negative electricity will produce a large electric force on the anode side; this will drive corpuscles forward with great velocity and ionize the gas. These corpuscles will behave like those shot from the cathode and will accumulate again at some distance from their origin, forming the bright head of the next striation, when the process will be repeated. On this view the bright heads of the striations act like electrodes, and the discharge passes from one bright head to the next as by a number of stepping stones, and not directly from cathode to anode. The luminosity at the head of the striations is due to the recombination of the ions. These ions have acquired considerable energy from the electric field, and this energy will be available for supplying the energy radiated away as light. The recombination of ions which do not possess considerable amounts of energy does not seem to give rise to luminosity. Thus, in an ionized gas not exposed to an electric field, although we have recombination between the ions, we need not have luminosity. We have at present no exact data as to the amount of energy which must be given to an ion to make it luminous on recombination; it also certainly varies with the nature of the ion; thus even with hot Wehnelt cathodes J. J. Thomson has never been able to make the discharge through air luminous with a potential less than from 16 to 17 volts. The mercury lamps, however, in which the discharge passes through mercury vapour are luminous with a potential difference of about 12 volts. It follows that if the preceding theory be right the potential difference between two bright striations must be great enough to make the corpuscles ionize by collision and also to give enough energy to the ions to make them luminous when they recombine. The difference of potential between the bright parts of successive striations has been measured by Hohn (*Phys. Zeit.* 9, p. 558); it varies with the pressure and with the gas. The smallest value given by Hohn is about 15 volts. In some experiments made by J. J. Thomson, when the pressure of the gas was very low, the difference of potential between two adjacent dark spaces was as low as 3.75 volts.

The Arc Discharge.—The discharges we have hitherto considered have been characterized by large potential differences and small currents. In the arc discharge we get very large currents with comparatively small potential differences. We may get the arc discharge by taking a battery of cells large enough to give a potential difference of 60 to 80 volts, and connecting the cells with two carbon terminals, which are put in contact, so that a current of electricity flows round the circuit. If the terminals, while the current is on, are drawn apart, a bright discharge, which may carry a current of many amperes, passes from one to the other. This arc discharge, as it is called, is characterized by intense heat and by the brilliant luminosity of the terminals. This makes it a powerful source of light. The temperature of the positive terminal is much higher than that of the negative. According to Violle (*Comptes Rendus*, 115, p. 1273) the temperature of the tip of the former is about 3500° C., and that of the latter 2700° C. The temperature of the arc itself he found to be higher than that of either of its terminals. As the arc passes, the positive terminal gets hollowed out into a crater-like shape, but the negative terminal remains pointed. Both terminals lose weight.

The appearance of the terminals is shown in fig. 18, given by Mrs Ayrton (*Proc. Inst. Elec. Eng.* 28, p. 400), *a*, *b* represent the terminals when the arc is quiet, and *c* when it is accompanied by a hissing sound. The intrinsic brightness of the positive crater does not increase with an increase in the current; an increased current produces an increase in the area of the luminous crater, but the amount of light given

out by each unit of area of luminous surface is unaltered. This indicates that the temperature of the crater is constant; it is probably that at which carbon volatilizes. W. E. Wilson (*Proc. Roy. Soc.* 58, p. 174; 60, p. 377) has shown that at pressures of several atmospheres the intrinsic brightness of the crater is considerably diminished.

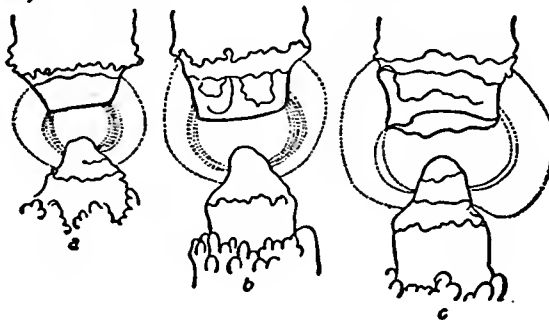

FIG. 18.

The connexion between V , the potential difference between the terminals, and l , the length of the arc, is somewhat analogous to that which holds for the spark discharge. Fröhlich (*Electrotech. Zeit.* 4, p. 150) gives for this connexion the relation $V = m + nl$, where m and n are constants. Mrs Ayrton (*The Electric Arc*, chap. iv.) finds that both m and n depend upon the current passing between the terminals, and gives as the relation between V and l , $V = a + \frac{\beta}{I} + (\gamma + \frac{\delta}{I})l$, where a , β , γ , δ are constants and I the current.

The relation between current and potential difference was made the subject of a series of experiments by Ayrton (*Electrician*, 1, p. 319; xi, p. 418), some of whose results are represented in fig. 19. For a quiet arc an increase in current is accompanied by a fall in potential difference, while for the hissing arc the potential difference is independent of the current. The quantities m and n which occur in

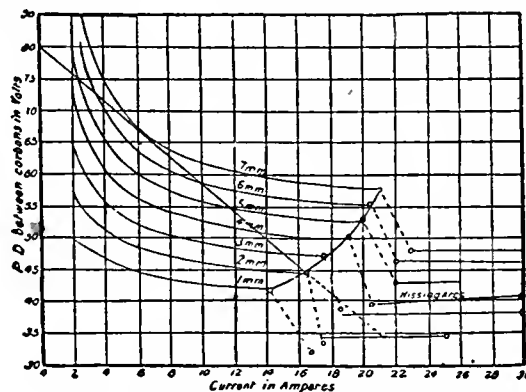

FIG. 19.

Fröhlich's equation have been determined by several experimenters. For carbon electrodes in air at atmospheric pressure m is about 39 volts, varying somewhat with the size and purity of the carbons; it is diminished by soaking the terminals in salt solution. The value of n given by different observers varies considerably, ranging from .76 to 2 volts when l is measured in millimetres; it depends upon the current, diminishing as the current increases. When metallic terminals are used instead of carbons, the value of m depends upon the nature of the metal, m in general being larger the higher the temperature at which the metal volatilizes. Thus v. Lang (*Wied. Ann.* 31, p. 384) found the following values for m in air at atmospheric pressure:—C = 35; Pt = 27.4; Fe = 25; Ni = 26.18; Cu = 23.86; Ag = 15.23; Zn = 19.86; Cd = 10.28. Lecher (*Wied. Ann.* 33, p. 609) gives Pt = 28, Fe = 20, Ag = 8, while Arons (*Wied. Ann.* 31, p. 384) found for Hg the value 12.8; in this case the fall of potential along the arc itself was abnormally small. In comparing these values it is important to remember that Lecher (*loc. cit.*) has shown that with Fe or Pt terminals the arc discharge is intermittent. Arons has shown that this is also the case with Hg terminals, but no intermittence has been detected with terminals of C, Ag or Cu. The preceding measurements refer to mean potentials, and no conclusions as to the actual potential differences at any time can be drawn when the discharge is discontinuous, unless we know the law of discontinuity. The ease with which an arc is sustained depends greatly on the nature of the electrodes; when they are brass, zinc, cadmium, or magnesium it is exceedingly difficult to get the arc.

The potential difference between the terminals is affected by the pressure of the gas. The most extensive series of experiments on this point is that made by Duncan, Rowland, and Tod (*Electrician*,

31, p. 60), whose results are represented in fig. 20. We see from these curves that for very short arcs the potential difference increases continuously with the pressure, but for longer ones there is a critical pressure at which the potential difference is a minimum, and that this critical pressure seems to increase with the length of arc.

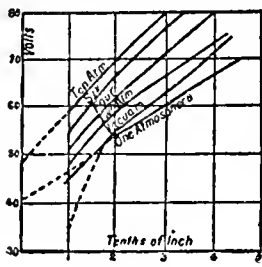

FIG. 20.

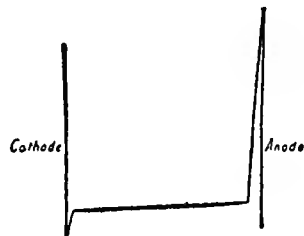

FIG. 21.

The nature of the gas also affects the potential difference. The magnitude of this effect may be gathered from the following values given by Arons (*Ann. der Phys.* 1, p. 700) for the potential difference required to produce an arc 1.5 mm. long, carrying a current of 4.5 amperes, between terminals of different metals in air and pure nitrogen.

Terminal.	Air.	Nitrogen.	Terminal.	Air.	Nitrogen.
Ag . .	21	?	Pt . .	36	30
Zn . .	23	21	Al . .	39	27
Cd . .	25	21	Pb	18
Cu . .	27	30	Mg	22
Fe . .	29	20			

Thus, with the discharge for an arc of given length and current, the nature of the terminals is the most important factor in determining the potential difference. The effects produced by the pressure and nature of the surrounding gas, although quite appreciable, are not of so much importance, while in the spark discharge the nature of the terminals is of no importance, everything depending upon the nature and pressure of the gas.

The potential gradient in the arc is very far from being uniform. With carbon terminals Luggin (*Wien. Ber.* 98, p. 1192) found that, with a current of 15 amperes, there was a fall of potential of 33.7 close to the anode, and one 8.7 close to the cathode, so that the curve representing the distribution of potential between the terminals would be somewhat like that shown in fig. 21. We have seen that a somewhat analogous distribution of potential holds in the case of conduction through flames, though in that case the greatest drop of potential is in general at the cathode and not at the anode. The difference between the changes of potential at the anode and cathode is not so large with Fe and Cu terminals as with carbon ones; with mercury terminals, Arons (*Wied. Ann.* 58, p. 73) found the anode fall to be 7.4 volts, the cathode fall 5.4 volts.

The case of the arc when the cathode is a pool of mercury and the anode a metal wire placed in a vessel from which the air has been exhausted is one which has attracted much attention, and important investigations on this point have been made by Hewitt (*Electrician*, 52, p. 447), Wills (*Electrician*, 54, p. 26), Stark, Retschinsky and Schnaposnikoff (*Ann. der Phys.* 18, p. 213) and Pollak (*Ann. der Phys.* 19, p. 217). In this arrangement the mercury is vaporized by the heat, and the discharge which passes through the mercury vapour gives an exceedingly bright light, which has been largely used for lighting factories, &c. The arrangement can also be used as a rectifier, for a current will only pass through it when the mercury pool is the cathode. Thus if such a lamp is connected with an alternating current circuit, it lets through the current in one direction and stops that in the other, thus furnishing a current which is always in one direction.

Theory of the Arc Discharge.—An incandescent body such as a piece of carbon even when at a temperature far below that of the terminals in an arc, emits corpuscles at a rate corresponding to a current of the order of 1 ampere per square centimetre of incandescent surface, and as the rate of increase of emission with the temperature is very rapid, it is probably at the rate of many amperes per square centimetre at the temperature of the negative carbon in the arc. If then a piece of carbon were maintained at this temperature by some external means, and used as a cathode, a current could be sent from it to another electrode whether the second electrode were cold or hot. If,

however, these negatively electrified corpuscles did not produce other ions either by collision with the gas through which they move or with the anode, the spaces between cathode and anode would have a negative charge, which would tend to stop the corpuscles leaving the cathode and would require a large potential difference between anode and cathode to produce any considerable current. If, however, there is ionization either in the gas or at the anode, the positive ions will diffuse into the region of the discharge until they are sensibly equal in number to the negative ions. When this is the case the back electromotive force is destroyed and the same potential difference will carry a much larger current. The arc discharge may be regarded as analogous to the discharge between incandescent terminals, the only difference being that in the arc the terminals are maintained in the state of incandescence by the current and not by external means. On this view the cathode is bombarded by positive ions which heat it to such a temperature that negative corpuscles sufficient to carry the current are emitted by it. These corpuscles bombard the anode and keep it incandescent. They ionize also, either directly by collision or indirectly by heating the anode, the gas and vapour of the metal of which the anode is made, and produce in this way the supply of positive ions which keep the cathode hot.

Discharge from a Point.—A very interesting case of electric discharge is that between a sharply pointed electrode, such as a needle, and a metal surface of considerable area. At atmospheric pressures the luminosity is confined to the immediate neighbourhood of the point. If the sign of the potential of the point does not change, the discharge is carried by ions of one sign—that of the charge on the pointed electrode. The velocity of these ions under a given potential gradient has been measured by Chattock (*Phil. Mag.* 32, p. 285), and found to agree with that of the ions produced by Röntgen or uranium radiation, while Townsend (*Phil. Trans.* 195, p. 259) has shown that the charge on these ions is the same as that on the ions streaming from the point. If the pointed electrode be placed at right angles to a metal plane serving as the other electrode, the discharge takes place when, for a given distance of the point from the plane, the potential difference between the electrodes exceeds a definite value depending upon the pressure and nature of the gas through which the discharge passes; its value also depends upon whether, beginning with a small potential difference, we gradually increase it until discharge commences, or, beginning with a large potential difference, we decrease it until the discharge stops. The value found by the latter method is less than that by the former. According to Chattock's measurements the potential difference V for discharge between the point and the plate is given by the linear relation $V = a + bl$, where l is the distance of the point from the plate and a and b are constants. From v. Obermayer's (*Wien. Ber.* 100, 2, p. 127) experiments, in which the distance l was greater than in Chattock's, it would seem that the potential for larger distances does not increase quite so rapidly with l as is indicated by Chattock's relation. The potential required to produce this discharge is much less than that required to produce a spark of length l between parallel plates; thus from Chattock's experiments to produce the point discharge when $l = .5$ cm. in air at atmospheric pressure requires a potential difference of about 3800 volts when the pointed electrode is positive, while to produce a spark at the same distance between plane electrodes would require a potential difference of about 15,000 volts. Chattock showed that with the same pointed electrode the value of the electric intensity at the point was the same whatever the distance of the point from the plane. The value of the electric intensity depended upon the sharpness of the point. When the end of the pointed electrode is a hemisphere of radius a , Chattock showed that for the same gas at the same pressure the electric intensity f when discharge takes place is roughly proportioned to $a^{-0.8}$. The value of the electric intensity at the pointed electrode is much greater than its value at a plane electrode for long sparks; but we must remember that at a distance from a pointed electrode equal to a small multiple of the radius of curvature of its extremity the electric intensity falls very far

below that required to produce discharge in a uniform field, so that the discharge from a pointed electrode ought to be compared with a spark whose length is comparable with the radius of curvature of the point. For such short sparks the electric intensity is very high. The electric intensity required to produce the discharge from a gas diminishes as the pressure of the gas diminishes, but not nearly so rapidly as the electric intensity for long sparks. Here again the discharge from a point is comparable with short sparks, which, as we have seen, are much less sensitive to pressure changes than longer ones. The minimum potential at which the electricity streams from the point does not depend upon the material of which the point is made; it varies, however, considerably with the nature of the gas. The following are the results of some experiments on this point. Those in the first two columns are due to Röntgen, those in the third and fourth to Precht:—

Gas.	Discharge Potential. Point +.		Pressure 760.	
	Pressure 205.	Pressure 110.	Point +.	Point -.
	Volts.	Volts.	Volts.	Volts.
H ₂ . . .	1296	1174	2125	1550
O ₂ . . .	2402	1975	2800	2350
CO . . .	2634	2100
CH ₄ . . .	2777	2317
NO . . .	3188	2543
CO ₂ . . .	3287	2655	3475	2100
N ₂	2600	2000
Air	2750	2050

We see from this table that in the case of the discharge from a positively electrified point the greater the molecular weight of the gas the greater the potential required for discharge. Röntgen concluded from his experiments that the discharging potential from a positive point in different gases at the same pressure varies inversely as the mean free path of the molecules of the gas. In the same gas, however, at different pressures the discharging potential does not vary so quickly with the pressure as does the mean free path. In Precht's experiments, in which different gases were used, the variations in the discharging potential are not so great as the variations in the mean free path of the gases.

The current of electrified air flowing from the point when the electricity is escaping—the well-known "electrical wind"—is accompanied by a reaction on the point which tends to drive it backwards. This reaction has been measured by Arrhenius (*Wied. Ann.* 63, p. 305), who finds that when positive electricity is escaping from a point in air the reaction on the point for a given current varies inversely as the pressure of the gas, and for different gases (air, hydrogen and carbonic acid) inversely as the square root of the molecular weight of the gas. The reaction when negative electricity is escaping is much less. The proportion between the reactions for positive and negative currents depends on the pressure of the gas. Thus for equal positive and negative currents in air at a pressure of 70 cm. the reaction for a positive point was 1.9 times that of a negative one, at 40 cm. pressure 2.6 times, at 20 cm. pressure 3.2 times, at 10.3 cm. pressure 7 times, and at 5.1 cm. pressure 15 times the reaction for the negative point. Investigation shows that the reaction should be proportional to the quotient of the current by the velocity acquired by an ion under unit potential gradient. Now this velocity is inversely proportional to the pressure, so that the reaction should on this view be directly proportional to the pressure. This agrees with Arrhenius' results when the point is positive. Again, the velocities of an ion in hydrogen, air and carbonic acid at the same pressure are approximately inversely proportional to the square roots of their molecular weights, so that the reaction should be directly proportional to this quantity. This also agrees with Arrhenius' results for the discharge from a positive point. The velocity of the negative ion is greater than that of a positive one under the same potential gradient, so that the reaction for the negative point should be less than that for a positive one, but the excess of the positive reaction over the negative is much greater than that of the velocity of the negative

ion over the velocity of the positive. There is, however, reason to believe that a considerable condensation takes place around the negative ion as a nucleus after it is formed, so that the velocity of the negative ion under a given potential gradient will be greater immediately after the ion is formed than when it has existed for some time. The measurements which have been made of the velocities of the ions relate to those which have been some time in existence, but a large part of the reaction will be due to the newly-formed ions moving with a greater velocity, and thus giving a smaller reaction than that calculated from the observed velocity.

With a given potential difference between the point and the neighbouring conductor the current issuing from the point is greater when the point is negative than when it is positive, except in oxygen, when it is less. Warburg (*Sitz. Akad. d. Wissensch. zu Berlin*, 1899, 50, p. 770) has shown that the addition of a small quantity of oxygen to nitrogen produces a great diminution in the current from a negative point, but has very little effect on the discharge from a positive point. Thus the removal of a trace of oxygen made a leak from a negative point 50 times what it was before. Experiments with hydrogen and helium showed that impurities in these gases had a great effect on the current when the point was negative, and but little when it was positive. This suggests that the impurities, by condensing round the negative ions as nuclei, seriously diminish their velocity. If a point is charged up to a high and rapidly alternating potential, such as can be produced by the electric oscillations started when a Leyden jar is discharged, then in hydrogen, nitrogen, ammonia and carbonic acid gas a conductor placed in the neighbourhood of the point gets a negative charge, while in air and oxygen it gets a positive one. There are two considerations which are of importance in connexion with this effect. The first is the velocity of the ions in the electric field, and the second the ease with which the ions can give up their charges to the metal point. The greater velocity of the negative ions would, if the potential were rapidly alternating, cause an excess of negative ions to be left in the surrounding gas. This is the case in hydrogen. If, however, the metal had a much greater tendency to unite with negative than with positive ions, such as we should expect to be the case in oxygen, this would act in the opposite direction, and tend to leave an excess of positive ions in the gas.

The Characteristic Curve for Discharge through Gases.—When a current of electricity passes through a metallic conductor the relation between the current and the potential difference is the exceedingly simple one expressed by Ohm's law; the current is proportional to the potential difference. When the current passes through a gas there is no such simple relation. Thus we have already mentioned cases where the current increased as the potential increased although not in the same proportion, while as we have seen in certain stages of the arc discharge the potential difference diminishes as the current increases. Thus the problem of finding the current which a given battery will produce when part of the circuit consists of a gas discharge is much more complicated than when the circuit consists entirely of metallic conductors. If, however, we measure the potential difference between the electrodes in the gas when different currents are sent through it, we can plot a curve, called the "characteristic curve," whose ordinates are the potential differences between the electrodes in the gas and the abscissae the corresponding currents. By the aid of this curve we can calculate the current produced when a given battery is connected up to the gas by leads of known resistance.

For let E_0 be the electromotive force of the battery, R the resistance of the leads, i the current, the potential difference between the terminals in the gas will be $E_0 - Ri$. Let ABC (fig. 22) be the "characteristic curve," the ordinates being the potential difference between the terminals in the gas, and the abscissae the current. Draw the line LM whose equation is $E = E_0 - Ri$, then the points where this line cuts the characteristic curves will give possible values of i and E , the current through the discharge tube and the potential difference between the terminals. Some of these points may, however, correspond to an unstable position and be impossible to realize. The following method gives us a criterion by which we can distinguish the stable from the unstable positions. If the current

is increased by δi , the electromotive force which has to be overcome by the battery is $R\delta i + \frac{dE}{di}\delta i$. If $R + dE/di$ is positive there will be an unbalanced electromotive force round the circuit tending to stop the current. Thus the increase in the current will be stopped and the condition will be a stable one. If, however, $R + dE/di$ is

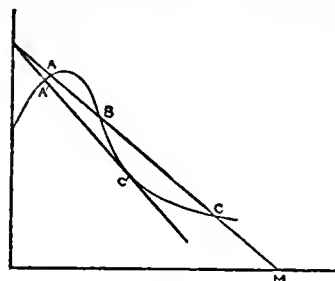

FIG. 22.

negative there will be an unbalanced electromotive force tending to increase the current still further; thus the current will go on increasing and the condition will be unstable. Thus for stability $R + dE/di$ must be positive, a condition first given by Kaufmann (*Ann. der Phys.* 11, p. 158). The geometrical interpretation of this condition is that the straight line LM must, at the point where it cuts the characteristic curve, be steeper than the tangent to characteristic curve. Thus of the points

ABC where the line cuts the curve in fig. 22, A and C correspond to stable states and B to an unstable one. The state of things represented by a point P on the characteristic curve when the slope is downward cannot be stable unless there is in the external circuit a resistance greater than that represented by the tangent of the inclination of the curve at P to the horizontal axis. If we keep the external electromotive force the same and gradually increase the resistance in the leads, the line LM will become steeper and steeper. C will move to the left so that the current will diminish; when the line gets so steep that it touches the curve at C', any further increase in the resistance will produce an abrupt change in the current; for now the state of things represented by a point near A' is the only stable state. Thus if the BC part of the curve corresponded to a luminous discharge and the A part to a dark discharge, we see that if the electromotive force is kept constant there is a minimum value of the current for the luminous discharge. If the current is reduced below this value, the discharge ceases to be luminous, and there is an abrupt diminution in the current.

Cathode Rays.—When the gas in the discharge tube is at a very low pressure some remarkable phenomena occur in the neighbourhood of the cathode. These seem to have been first observed by Plücker (*Pogg. Ann.* 107, p. 77; 116, p. 45) who noticed on the walls of the glass tube near the cathode a greenish phosphorescence, which he regarded as due to rays proceeding from the cathode, striking against the sides of the tube, and then travelling back to the cathode. He found that the action of a magnet on these rays was not the same as the action on the part of the discharge near the positive electrode. Hittorf (*Pogg. Ann.* 136, p. 8) showed that the agent producing the phosphorescence was intercepted by a solid, whether conductor or insulator, placed between the cathode and the sides of the tube. He regarded the phosphorescence as caused by a motion starting from the cathode and travelling in straight lines through the gas. Goldstein (*Monat. der Berl. Akad.*, 1876, p. 24) confirmed this discovery of Hittorf's, and further showed that a distinct, though not very sharp, shadow is cast by a small object placed near a large plane cathode. This is a proof that the rays producing the phosphorescence must be emitted almost normally from the cathode, and not, like the rays of light from a luminous surface, in all directions, for such rays would not produce a perceptible shadow if a small body were placed near the plane. Goldstein regarded the phosphorescence as due to waves in the ether, for whose propagation the gas was not necessary. Crookes (*Phil. Trans.*, 1879, pt. i. p. 135; pt. ii. pp. 587, 661), who made many remarkable researches in this subject, took a different view. He regarded the rays as streams of negatively electrified particles projected normally from the cathode with great velocity, and, when the pressure is sufficiently low, reaching the sides of the tube, and by their impact producing phosphorescence and heat. The rays on this view are deflected by a magnet, because a magnet exerts a force on a charged moving body.

These rays striking against glass make it phosphorescent. The colour of the phosphorescence depends on the kind of glass; thus the light from soda glass is a yellowish green, and that from lead glass blue. Many other bodies phosphoresce when exposed to these rays, and in particular the phosphorescence of some

gems, such as rubies and diamonds, is exceedingly vivid. The spectrum of the phosphorescent light is generally continuous, but Crookes showed that the phosphorescence of some of the rare earths, such as yttrium, gives a spectrum of bright bands, and he founded on this fact a spectroscopic method of great importance. Goldstein (*Wied. Ann.* 54, p. 371) discovered that the haloid salts of the alkali metals change colour under the rays, sodium chloride, for example, becoming violet. The coloration is a surface one, and has been traced by E. Wiedemann and Schmidt (*Wied. Ann.* 54, p. 618) to the formation of a sub-chloride. Chlorides of tin, mercury and lead also change colour in the same way. E. Wiedemann (*Wied. Ann.* 56, p. 201) discovered another remarkable effect, which he called thermo-luminescence; he found that many bodies after being exposed to the cathode rays possess for some time the power of becoming luminous when their temperature is raised to a point far below that at which they become luminous in the normal state. Substances belonging to the class called by van't Hoff solid solutions exhibit this property of thermo-luminescence to a remarkable extent. They are formed when two salts, one greatly in excess of the other, are simultaneously precipitated from a solution. A trace of $MnSO_4$ in $CaSO_4$ shows very brilliant thermo-luminescence. The impact of cathode rays produces after a time perceptible changes in the glass. Crookes (*Phil. Trans.* pt. ii. 1879, p. 645) found that after glass has been phosphorescing for some time under the cathode rays it seems to get tired, and the phosphorescence is not so bright as it was initially. Thus, for example, when the shadow of a Maltese cross is thrown on the walls of the tube as in fig. 23, if after the discharge has been going on for some time the cross is shaken down or a new cathode used

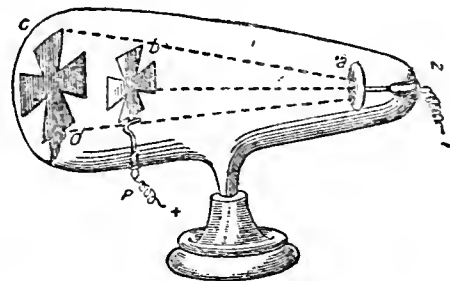

FIG. 23.

whose line of fire does not cut the cross, the pattern of the cross will still be seen on the glass, but it will now be brighter instead of darker than the surrounding portion. The portions shielded by the cross, not being tired by being made to phosphoresce for a long time, respond more vigorously to the stimulus than those portions which have not been protected. Skinner (*Proc. Camb. Phil. Soc.* ix. p. 371) and Thomson found on the glass which had been exposed to the rays gelatinous filaments, apparently silica, resulting from the reduction of the glass. A reducing action was also noticed by Villard (*Journ. de phys.* 3, viii. p. 140) and Wehnelt (*Wied. Ann.* 67, p. 421). It can be well shown by letting the rays fall on a plate of oxidized copper, when the part struck by the rays will become bright. The rays heat bodies on which they fall, and if they are concentrated by using as a cathode a portion of a spherical surface, the heat at the centre becomes so great that a piece of platinum wire can be melted or a diamond charred. Measurements of the heating effects of the rays have been made by Thomson (*Phil. Mag.* [5], 44, p. 293) and Cady (*Ann. der Phys.* 1, p. 678). Crookes (*Phil. Trans.*, 1879, pt. i. p. 152) showed that a vane mounted as in a radiometer is set in rotation by the rays, the direction of the rotation being the same as would be produced by a stream of particles proceeding from the cathode. The movement is not due to the momentum imparted to the vanes by the rays, but to the difference in temperature between the sides of the vanes, the rays making the side against which they strike hotter than the other.

Effect of a Magnet.—The rays are deflected by a magnet, so that the distribution of phosphorescence over the glass and the shape and position of the shadows cast by bodies in the tube are altered by the proximity of a magnet. The laws of magnetic deflection of these rays have been investigated by Plücker (*Pogg.*

Ann. 103, p. 88), Hittorf (*Pogg. Ann.* 136, p. 213), Crookes (*Phil. Trans.*, 1879, pt. 1, p. 557), and Schuster (*Proc. Roy. Soc.* 47, p. 526). The deflection is the same as that of negatively electrified particles travelling along the path of the rays. Such particles would in a magnetic field be acted on by a force at right angles to the direction of motion of the particle and also to the magnetic force, the magnitude of the force being proportional to the product of the velocity of the particle, the magnetic force, and the sine of the angle between these vectors. In this case we have seen that if the particle is not acted on by an electrostatic field, the path in a uniform magnetic field is a spiral, which, if the magnetic force is at right angles to the direction of projection of the particle, becomes a circle in the plane at right angles to the magnetic force, the radius being mv/He , where m , v , e are respectively the mass, velocity and charge on the particle, and H is the magnetic force. The smaller the difference of potential between the electrodes of the discharge tube the greater the deflection produced by a magnetic field of given strength, and as the difference of potential rapidly increases with diminution of pressure, after a certain pressure has been passed, the higher the exhaustion of the tube the less the magnetic deflection of the rays. Birkeland (*Comptes rendus*, 1896, p. 492) has shown that when the discharge is from an induction coil the cathode rays produced in the tube at any one time are not equally deflected by a magnet, but that a narrow patch of phosphorescence when deflected by a magnet is split up into several distinct patches, giving rise to what Birkeland calls the "magnetic spectrum." Strutt (*Phil. Mag.* 48, p. 478) has shown that this magnetic spectrum does not occur if the discharge of a large number of cells is employed instead of the coil. Thomson (*Proc. Camb. Phil. Soc.* 9, p. 243) has shown that if the potential difference between the electrodes is kept the same the magnetic deflection is independent of the nature of the gas filling the discharge tube; this was tested with gases so different as air, hydrogen, carbonic acid and methyl iodide.

Charge of Negative Electricity carried by the Rays.—We have seen that the rays are deflected by a magnet, as if they were particles charged with negative electricity. Perrin (*Comptes rendus*, 121, p. 1130) showed by direct experiment that a stream of negative electricity is associated with the rays. A modification made by Thomson of Perrin's experiment is sketched in fig. 24 (*Phil. Mag.* 48, p. 478).

The rays start from the cathode A, and pass through a slit in a solid brass rod B fitting tightly into the neck of the tube. This rod is connected with earth and used as the anode. The rays after passing through the slit travel through the vessel C. D and E are

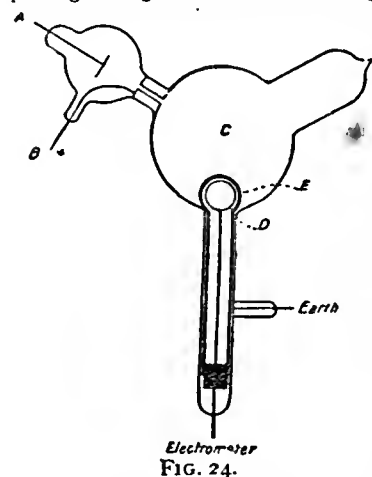

Electrometer
FIG. 24.

two insulated metal cylinders insulated from each other, and each having a slit cut in its face so as to enable the rays to pass into the inside of the inner cylinder, which is connected with an electrometer, the outer cylinder being connected with the earth. The two cylinders are placed on the far side of the vessel, but out of the direct line of fire of the rays. When the rays go straight through the slit there is only a very small negative charge communicated to the inner cylinder, but when they are deflected by a magnet so that the phosphorescent patch falls on the slit in the outer cylinder the inner cylinder receives a very large negative charge, the increase coinciding

very sharply with the appearance of the phosphorescent patch on the slit. When the patch is so much deflected by the magnet that it falls below the slit, the negative charge in the cylinder again disappears. This experiment shows that the cathode rays are accompanied by a stream of negative electrification. The same apparatus can be used to show that the passage of cathode rays through a gas makes it a conductor of electricity. For if the induction coil is kept running and a stream of the rays kept steadily going into the

inner cylinder, the potential of the inner cylinder reaches a definite negative value below which it does not fall, however long the rays may be kept going. The cylinder reaches a steady state in which the gain of negative electricity from the cathode rays is equal to the loss by leakage through the conducting gas, the conductivity being produced by the passage of the rays through it. If the inner cylinder is charged up initially with a greater negative charge than corresponds to the steady state, on turning the rays on to the cylinder the negative charge will decrease and not increase until it reaches the steady state. The conductivity produced by the passage of cathode rays through a gas diminishes rapidly with the pressure. When rays pass through a gas at a low pressure, they are deflected by an electric field; when the pressure of the gas is higher the conductivity it acquires when the cathode rays pass through it is so large that the potential gradient cannot reach a sufficiently high value to produce an appreciable deflection.

Thus the cathode rays carry a charge of negative electricity; the experiment described on page 875 (fig. 13) shows that they are deflected by an electric field as if they were negatively electrified, and are acted on by a magnetic force in just the way this force would act on a negatively electrified body moving along the path of the rays. There is therefore every reason for believing that they are charges of negative electricity in rapid motion. By measuring the deflection produced by magnetic and electric fields we can determine the velocity with which these particles moved and the ratio of the mass of the particle to the charge carried by it.

We may conclude from the experiments that the value of m/e for the particles constituting the cathode rays is of the order $1/1.7 \times 10^7$, and we have seen that m/e has the same value in all the other cases of negative ions in a gas at low pressure for which it has been measured—viz. for the ions produced when ultra-violet light falls on a metal plate, or when an incandescent carbon filament is surrounded by a gas at a low pressure, and for the β particles given out by radio-active bodies. We have also seen that the value of the charge on the gaseous ion, in all cases in which it has been measured—viz. the ions produced by Röntgen and uranium radiation, by ultra-violet light, and by the discharge of electrification from a point—is the same in magnitude as the charge carried by the hydrogen atom in the electrolysis of solutions. The mass of the hydrogen alone is, however, 10^{-4} times this charge, while the mass of the carriers of negative electrification is only $1/1.7 \times 10^7$ times the charge; hence the mass of the carriers of the negative electrification is only $1/1700$ of the mass of the hydrogen atom. We are thus, by the study of the electric discharge, forced to recognize the existence of masses very much smaller than the smallest mass hitherto recognized.

Direct determinations of the velocity of the cathode rays have been made by J. J. Thomson (*Phil. Mag.* 38, p. 358), who measured the interval between the appearance of phosphorescence on two pieces of glass placed at a known distance apart, and by Maiorana (*Nuovo Cimento*, 4, 6, p. 336) and Battelli and Stefanini (*Phys. Zeit.* 1, p. 51), who measured the interval between the arrival of the negative charge carried by the rays at two places separated by a known distance. The values of the velocity got in this way are much smaller than the values got by the indirect methods previously described: thus J. J. Thomson at a fairly high pressure found the velocity to be 2×10^7 cm./sec. Maiorana found values ranging between 10^7 and 6×10^7 cm./sec., and Battelli and Stefanini values ranging from 6×10^6 to 1.2×10^7 . In these methods it is very difficult to eliminate the effect of the interval which elapses between the arrival of the rays and the attainment by the means of detection, such as the phosphorescence of the glass or the deflection of the electrometer, of sufficient intensity to affect the senses.

Transmission of Cathode Rays through Solids—Lenard Rays.—

It was for a long time believed that all solids were absolutely opaque to these rays, as Crookes and Goldstein had proved that very thin glass, and even a film of collodion, cast intensely black shadows. Hertz (*Wied. Ann.* 45, p. 28), however, showed that behind a piece of gold-leaf or aluminium foil an appreciable amount of phosphorescence occurred on the glass, and that the phosphorescence moved when a magnet was brought near. A most important advance was next made by Lenard (*Wied. Ann.* 51, p. 225), who got the cathode rays to pass from the inside of a discharge tube to the air outside. For this purpose he used a tube like that shown in fig. 25. The cathode K is an aluminium disc 1.2 cm. in diameter fastened to a stiff wire, which is surrounded by a glass tube. The anode A is a brass strip partly

surrounding the cathode. The end of the tube in front of the cathode is closed by a strong metal cap, fastened in with marine glue, in the middle of which a hole 1.7 mm. in diameter is bored, and covered with a piece of very thin aluminium foil about .0026 mm. in thickness. The aluminium window is in metallic contact with the cap, and this and the anode are connected with the earth. The tube is then exhausted until the cathode rays strike against the window. Diffuse light spreads from the window into the air outside the tube, and can be traced in a dark room for a distance of several centimetres. From the window, too, proceed rays which, like the cathode rays, can produce phosphorescence, for certain bodies phosphoresce when placed in the neighbourhood of the window. This effect is conveniently observed by the platino-cyanide screens used to detect Röntgen radiation. The properties of the rays outside the tube resemble

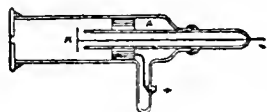

FIG. 25.

in all respects those of cathode rays; they are deflected by a magnet and by an electric field, they ionize the gas through which they pass and make it a conductor of electricity, and they affect a photographic plate and change the colour of the haloid salts of

the alkali metals. As, however, it is convenient to distinguish between cathode rays outside and inside the tube, we shall call the former Lenard rays. In air at atmospheric pressure the Lenard rays spread out very diffusely. If the aluminium window, instead of opening into the air, opens into another tube which can be exhausted, it is found that the lower the pressure of the gas in this tube the farther the rays travel and the less diffuse they are. By filling the tube with different gases Lenard showed that the greater the density of the gas the greater is the absorption of these rays. Thus they travel farther in hydrogen than in any other gas at the same pressure. Lenard showed, too, that if he adjusted the pressure so that the density of the gas in this tube was the same—if, for example, the pressure when the tube was filled with oxygen was $\frac{1}{5}$ of the pressure when it was filled with hydrogen—the absorption was constant whatever the nature of the gas. Becker (*Ann. der Phys.* 17, p. 381) has shown that this law is only approximately true, the absorption by hydrogen being abnormally large, and by the inert monatomic gases, such as helium and argon, abnormally small. The distance to which the Lenard rays penetrate into this tube depends upon the pressure in the discharge tube; if the exhaustion in the latter is very high, so that there is a large potential difference between the cathode and the anode, and therefore a high velocity for the cathode rays, the Lenard rays will penetrate farther than when the pressure in the discharge tube is higher and the velocity of the cathode rays smaller. Lenard showed that the greater the penetrating power of his rays the smaller was their magnetic deflection, and therefore the greater their velocity; thus the greater the velocity of the cathode rays the greater is the velocity of the Lenard rays to which they give rise. For very slow cathode rays the absorption by different gases departs altogether from the density law, so much so that the absorption of these rays by hydrogen is greater than that by air (Lenard, *Ann. der Phys.* 12, p. 732). Lenard (*Wied. Ann.* 56, p. 255) studied the passage of his rays through solids as well as through gases, and arrived at the very interesting result that the absorption of a substance depends only upon its density, and not upon its chemical composition or physical state; in other words, the amount of absorption of the rays when they traverse a given distance depends only on the quantity of matter they cut through in the distance. McClelland (*Proc. Roy. Soc.* 61, p. 227) showed that the rays carry a charge of negative electricity, and McLennan measured the amount of ionization rays of given intensity produced in different gases, finding that if the pressure is adjusted so that the density of the different gases is the same the number of ions per cubic centimetre is also the same. In this case, as Lenard has shown, the absorption is the same, so that with the Lenard rays, as with uranium and probably with Röntgen rays, equal absorption corresponds to equal ionization. A convenient method for producing Lenard rays of great

intensity has been described by Des Coudres (*Wied. Ann.* 62, p. 134).

Diffuse Reflection of Cathode Rays.—When cathode rays fall upon a surface, whether of an insulator or a conductor, cathode rays start from the surface in all directions. This phenomenon, which was discovered by Goldstein (*Wied. Ann.* 62, p. 134), has been investigated by Starke (*Wied. Ann.* 66, p. 49; *Ann. der Phys.* 111, p. 75), Austin and Starke (*Ann. der Phys.* 9, p. 271), Campbell-Swinton (*Proc. Roy. Soc.* 64, p. 377), Merritt (*Phys. Rev.* 7, p. 217) and Gehrcke (*Ann. der Phys.* 8, p. 81); it is often regarded as analogous to the diffuse reflection of light from such a surface as gypsum, and is spoken of as the diffuse reflection of the cathode rays. According to Merritt and Austin and Starke the deviation in a magnetic field of these reflected rays is the same as that of the incident rays. The experiments, however, were confined to rays reflected so that the angle of reflection was nearly equal to that of incidence. Gehrcke showed that among the reflected rays there were a large number which had a much smaller velocity than the incident ones. According to Campbell-Swinton the “diffuse” reflection is accompanied by a certain amount of “specular” reflection. Lenard, who used slower cathode rays than Austin and Starke, could not detect in the scattered rays any with velocities comparable with that of the incident rays; he obtained copious supplies of slow rays whose speed did not depend on the angle of incidence of the primary rays (*Ann. der Phys.* 15, p. 485). When the angle of incidence is very oblique the surface struck by the rays gets positively charged, showing that the secondary rays are more numerous than the primary.

Repulsion of two Cathode Streams.—Goldstein discovered that if in a tube there are two cathodes connected together, the cathodic rays from one cathode are deflected when they pass near the other. Experiments bearing on this subject have been made by Crookes and Wiedemann and Ebert. The phenomena may be described by saying that the repulsion of the rays from a cathode A by a cathode B is only appreciable when the rays from A pass through the Crookes dark space round B. This is what we should expect if we remember that the electric field in the dark space is far stronger than in the rest of the discharge, and that the gas in the other parts of the tube is rendered a conductor by the passage through it of the cathode rays, and therefore incapable of transmitting electrostatic repulsion.

Scattering of the Negative Electrodes.—In addition to the cathode rays, portions of metal start normally from the cathode and form a metallic deposit on the walls of the tube. The amount of this deposit varies very much with the metal. Crookes (*Proc. Roy. Soc.* 50, p. 88) found that the quantities of metal torn from electrodes of the same size, in equal times, by the same current, are in the order Pd, Au, Ag, Pb, Sn, Pt, Cu, Cd, Ni, In, Fe. . . . In air there is very little deposit from an Al cathode, but it is abundant in tubes filled with the monatomic gases, mercury vapour, argon or helium. The scattering increases as the density of the gas diminishes. The particles of metal are at low pressures deflected by a magnet, though not nearly to the same extent as the cathode rays. According to Grandquist, the loss of weight of the cathode in a given time is proportional to the square of the current; it is therefore not, like the loss of the cathode in ordinary electrolysis, proportional to the quantity of current which passes through it.

Positive Rays or “Canalstrahlen.”—Goldstein (*Berl. Sitzungsber.* 39, p. 691) found that with a perforated cathode certain rays occurred behind the cathode which were not appreciably deflected by a magnet; these he called *Canalstrahlen*, but we shall, for reasons which will appear later, call them “positive rays.”

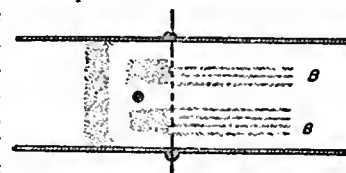

FIG. 26.

Their appearance is well shown in fig. 26, taken from a paper by Wehnelt (*Wied. Ann.* 67, p. 421) in which they are represented at B. Goldstein found

that their colour depends on the gas in which they are formed, being gold-colour in air and nitrogen, rose-colour in hydrogen, yellowish rose in oxygen, and greenish gray in carbonic acid.

The colour of the luminosity due to positive rays is not in general the same as that due to anode rays, the difference is exceptionally well marked in helium, where the cathode ray luminosity is blue while that due to the positive rays is red. The luminosity produced when the rays strike against solids is also quite distinct. The cathode rays make the body emit a continuous spectrum, while the spectrum produced by the positive rays often shows bright lines. Thus lithium chloride under cathode rays gives out a steely blue light and the spectrum is continuous, while under the positive rays the salt gives out a brilliant red light and the spectrum shows the red helium line. It is remarkable that the lines on the spectra of the alkali metals are much more easily produced when the positive rays fall on the oxide of the metal than when they fall on the metal itself. Thus when the positive rays fall on a pool of the liquid alloy of sodium and potassium the specks of oxide on the surface shine with a bright yellow light while the untarnished part of the surface is quite dark.

W. Wien (*Wied. Ann.* 65, p. 445) measured the values of e/m for the particles forming the positive rays. Other measurements have been made by Ewers (*Wied. Ann.* 69, p. 167) and J. J. Thomson (*Phil. Mag.* 13, p. 561). The differences between the values of e/m for the cathode and positive rays are very remarkable. For cathode rays whose velocity does not approach that of light, e/m is always equal to 1.7×10^8 , while for the positive rays the greatest value of this quantity yet observed is 10^4 , which is also the value of e/m for the hydrogen ions in the electrolysis of dilute solutions. In some experiments made by J. J. Thomson (*Phil. Mag.*, 14, p. 359) it was found that when the pressure of the gas was not too low the bright spot produced by the impact of a pencil of these rays on a phosphorescent screen is deflected by electric and magnetic forces into a continuous band extending on both sides of the undeflected position. The portion on one side is in general much fainter than that on the other. The direction of this deflection shows that it is produced by particles charged with negative electricity, while the brighter band is due to particles charged with positive electricity. The negatively electrified particles which produce the band c.c. are not corpuscles, for from the electric and magnetic deflections we can find the value of e/m . As this proves to be equal to 10^4 , we see that the mass of the carrier of the negative charge is comparable with that of an atom, and so very much greater than that of a corpuscle. At very low pressures part of the phosphorescence disappears, while the upper portion breaks up into two patches (fig. 27). For one of these the maximum value of e/m is 10^4 and for the other 5×10^3 . At low pressures the appearance of the patches and the values of e/m are the same whether the tube is filled originally with air, hydrogen or helium. In some of the experiments the tube was exhausted until the pressure was too low to allow the discharge to pass. A very small quantity of the gas under investigation was then admitted into the tube, just sufficient to allow the discharge to pass, and the deflection of the phosphorescent patch measured. The following gases were admitted into the tube, air, carbonic oxide, oxygen, hydrogen, helium, argon and neon, but whatever the gas the appearance of the phosphorescence was the same; in every case there were two patches, for one of which $e/m = 10^4$ and for the other $e/m = 5 \times 10^3$. In helium at higher pressures another patch was observed, for which $e/m = 2.5 \times 10^3$. The continuous band into which the phosphorescent spot is drawn out when the pressure is not exceedingly low, which involves the existence of particles for which the mean value of e/m varies from zero to 10^4 , can be explained as follows. The rays on their way to the phosphorescent screen have to pass through gas which is ionized by the passage through it of the positive rays; this gas will therefore contain free corpuscles. The particles which constitute the rays start with a charge of positive electricity. Some of these particles in their journey through the

gas attract a corpuscle whose negative charge neutralizes the positive charge on the particle. The particles when in this neutral state may be ionized by collision and reacquire a positive charge, or by attracting another particle may become negatively charged, and this process may be repeated several times on their journey to the phosphorescent screen. Thus some of the particles, instead of being positively charged for the whole of the time they are exposed to the electric and magnetic forces, may be for a part of that time without a charge or even have a negative charge. The deflection of a particle is proportional to the average value of its charge whilst under the influence of the deflecting forces. Thus if a particle is without a charge for a part of the time, its deflection will be less than that of a particle which has retained its positive charge for the whole of its journey, while the few particles which have a negative charge for a longer time than they have a positive will be deflected in the opposite direction to the main portion and will produce the tail (fig. 27).



FIG. 27.

A similar explanation will apply to the positive rays discovered by Villard (*Comptes rendus*, 143, p. 674) and J. J. Thomson (*Phil. Mag.* 13, p. 359), which travel in the opposite direction to the rays we have been considering, i.e. they travel away from the cathode and in the direction of the cathode's rays; these rays are sometimes called "retrograde" rays. These as far as has been observed have always the same maximum value of e/m , i.e. 10^4 , and there are a considerable number of negative ones always mixed with them. The maximum velocity of both the positive and retrograde rays is about 2×10^8 cm./sec. and varies very little with the potential difference between the electrodes in the tube in which they are produced (J. J. Thomson, *Phil. Mag.*, Dec. 1909).

The positive rays show, when the pressure is not very low, the line spectrum of the gas through which they pass. An exceedingly valuable set of observations on this point have been made by Stark and his pupils (*Physik. Zeit.* 6, p. 892; *Ann. der Phys.* 21, pp. 40, 457). Stark has shown that in many gases, notably hydrogen, the spectrum shows the Doppler effect, and he has been able to calculate in this way the velocity of the positive rays.

Anode Rays.—Gehrcke and Reichenhein (*Ann. der Phys.* 25, p. 861) have found that when the anode consists of a mixture of sodium and lithium chloride raised to a high temperature either by the discharge itself or by an independent heating circuit, very conspicuous rays come from the anode when the pressure of the gas in the discharge tube is very low, and a large coil is used to produce the discharge. The determination of e/m for these rays showed that they are positively charged atoms of sodium or lithium, moving with very considerable velocity; in some of Gehrcke's experiments the maximum velocity was as great as 1.8×10^7 cm./sec. though the average was about 10^7 cm./sec. These velocities are less than those of the positive rays whose maximum velocity is about 2×10^8 cm./sec. (J. J. T.)

CONDUCTION OF HEAT. The mathematical theory of conduction of heat was developed early in the 19th century by Fourier and other workers, and was brought to so high a pitch of excellence that little has remained for later writers to add to this department of the subject. In fact, for a considerable period, the term "theory of heat" was practically synonymous with the mathematical treatment of a conduction. But later experimental researches have shown that the simple assumption of constant coefficients of conductivity and emissivity, on which the mathematical theory is based, is in many respects inadequate, and the special mathematical methods developed by J. B. J. Fourier need not be considered in detail here, as they are in many cases of mathematical rather than physical interest. The main object of

the present article is to describe more recent work, and to discuss experimental difficulties and methods of measurement.

1. *Mechanism of Conduction.*—Conduction of heat implies transmission by contact from one body to another or between contiguous particles of the same body, but does not include transference of heat by the motion of masses or streams of matter from one place to another. This is termed *convection*, and is most important in the case of liquids and gases owing to their mobility. Conduction, however, is generally understood to include diffusion of heat in fluids due to the agitation of the ultimate molecules, which is really molecular convection. It also includes diffusion of heat by internal radiation, which must occur in transparent substances. In measuring conduction of heat in fluids, it is possible to some extent to eliminate the effects of molar convection or mixing, but it would not be possible to distinguish between diffusion, or internal radiation, and conduction. Some writers have supposed that the ultimate atoms are conductors, and that heat is transferred through them when they are in contact. This, however, is merely transferring the properties of matter in bulk to its molecules. It is much more probable that heat is really the kinetic energy of motion of the molecules, and is passed on from one to another by collisions. Further, if we adopt W. Weber's hypothesis of electric atoms, capable of diffusing through metallic bodies and conductors of electricity, but capable of vibration only in non-conductors, it is possible that the ultimate mechanism of conduction may be reduced in all cases to that of diffusion in metallic bodies or internal radiation in dielectrics. The high conductivity of metals is then explained by the small mass and high velocity of diffusion of these electric atoms. Assuming the kinetic energy of an electric atom at any temperature to be equal to that of a gaseous molecule, its velocity, on Sir J. J. Thomson's estimate of the mass, must be upwards of forty times that of the hydrogen molecule.

2. *Law of Conduction.*—The experimental law of conduction, which forms the basis of the mathematical theory, was established in a qualitative manner by Fourier and the early experimentalists. Although it is seldom explicitly stated as an experimental law, it should really be regarded in this light, and may be briefly worded as follows: "The rate of transmission of heat by conduction is proportional to the temperature gradient."

The "rate of transmission of heat" is here understood to mean the quantity of heat transferred in unit time through unit area of cross-section of the substance, the unit area being taken perpendicular to the lines of flow. It is clear that the quantity transferred in any case must be jointly proportional to the area and the time. The "gradient of temperature" is the fall of temperature in degrees per unit length along the lines of flow. The *thermal conductivity* of the substance is the constant ratio of the rate of transmission to the temperature gradient. To take the simple case of the "wall" or flat plate considered by Fourier for the definition of thermal conductivity, suppose that a quantity of heat Q passes in the time T through an area A of a plate of conductivity k and thickness x , the sides of which are constantly maintained at temperatures θ' and θ'' . The rate of transmission of heat is Q/AT , and the temperature gradient, supposed uniform, is $(\theta' - \theta'')/x$, so that the law of conduction leads at once to the equation

$$Q/AT = k(\theta' - \theta'')/x = kd\theta/dx. \quad (1)$$

This relation applies accurately to the case of the steady flow of heat in parallel straight lines through a homogeneous and isotropic solid, the isothermal surfaces, or surfaces of equal temperature, being planes perpendicular to the lines of flow. If the flow is steady, and the temperature of each point of the body invariable, the rate of transmission must be everywhere the same. If the gradient is not uniform, its value may be denoted by $d\theta/dx$. In the steady state, the product $kd\theta/dx$ must be constant, or the gradient must vary inversely as the conductivity, if the latter is a function of θ or x . One of the simplest illustrations of the rectilinear flow of heat is the steady outflow through the upper strata of the earth's crust, which may be considered practically plane in this connexion. This outflow of heat necessitates a rise of temperature with increase of depth. The corresponding

gradient is of the order of 1°C. in 100 ft., but varies inversely with the conductivity of the strata at different depths.

3. *Variable State.*—A different type of problem is presented in those cases in which the temperature at each point varies with the time, as is the case near the surface of the soil with variations in the external conditions between day and night or summer and winter. The flow of heat may still be linear if the horizontal layers of the soil are of uniform composition, but the quantity flowing through each layer is no longer the same. Part of the heat is used up in changing the temperature of the successive layers. In this case it is generally more convenient to consider as unit of heat the thermal capacity c of unit volume, or that quantity which would produce a rise of one degree of temperature in unit volume of the soil or substance considered. If Q is expressed in terms of this unit in equation (1), it is necessary to divide by c , or to replace k on the right-hand side by the ratio k/c . This ratio determines the rate of diffusion of temperature, and is called the *thermometric conductivity* or, more shortly, the *diffusivity*. The velocity of propagation of temperature waves will be the same under similar conditions in two substances which possess the same diffusivity, although they may differ in conductivity.

4. *Emissivity.*—Fourier defined another constant expressing the rate of loss of heat at a bounding surface per degree of difference of temperature between the surface of the body and its surroundings. This he called the *external conductivity*, but the term *emissivity* is more convenient. Taking Newton's law of cooling that the rate of loss of heat is simply proportional to the excess of temperature, the emissivity would be independent of the temperature. This is generally assumed to be the case in mathematical problems, but the assumption is admissible only in rough work, or if the temperature difference is small. The emissivity really depends on every variety of condition, such as the size, shape and position of the surface, as well as on its nature; it varies with the rate of cooling, as well as with the temperature excess, and it is generally so difficult to calculate, or to treat in any simple manner, that it forms the greatest source of uncertainty in all experimental investigations in which it occurs.

5. *Experimental Methods.*—Measurements of thermal conductivity present peculiar difficulties on account of the variety of quantities to be observed, the slowness of the process of conduction, the impossibility of isolating a quantity of heat, and the difficulty of exactly realizing the theoretical conditions of the problem. The most important methods may be classified roughly under three heads—(1) Steady Flow, (2) Variable Flow, (3) Electrical. The methods of the first class may be further subdivided according to the form of apparatus employed. The following are some of the special cases which have been utilized experimentally:—

6. *The "Wall" or Plate Method.*—This method endeavours to realize the conditions of equation (1), namely, uniform rectilinear flow. Theoretically this requires an infinite plate, or a perfect heat insulator, so that the lateral flow can be prevented or rendered negligible. This condition can generally be satisfied with sufficient approximation with plates of reasonable dimensions. To find the conductivity, it is necessary to measure all the quantities which occur in equation (1) to a similar order of accuracy. The area A from which the heat is collected need not be the whole surface of the plate, but a measured central area where the flow is most nearly uniform. This variety is known as the "Guard-Ring" method, but it is generally rather difficult to determine the effective area of the ring. There is little difficulty in measuring the time of flow, provided that it is not too short. The measurement of the temperature gradient in the plate generally presents the greatest difficulties. If the plate is thin, it is necessary to measure the thickness with great care, and it is necessary to assume that the temperatures of the surfaces are the same as those of the media with which they are in contact, since there is no room to insert thermometers in the plate itself. This assumption does not present serious errors in the case of bad conductors, such as glass or wood, but has given rise to large mistakes in the case of metals. The conductivities of thin slices of crystals have been measured by C. H. Lees (*Phil. Trans.*, 1892) by pressing them between plane amalgamated surfaces of metal. This gives very good contact, and the conductivity of the metal being more than 100 times that of the crystal, the temperature of the surface is determinate.

In applying the plate method to the determination of the conductivity of iron, E. H. Hall proposed to overcome this difficulty by coating the plate thickly with copper on both sides, and deducing the difference of temperature between the two surfaces of junction of the iron and the copper from the thermo-electric force observed by means of a number of fine copper wires attached to the copper coatings at different points of the disk. The advantage of the thermo-junction for this purpose is that the distance between the surfaces of which the temperature-difference is measured, is very exactly defined. The disadvantage is that the thermo-electric force is very small, about ten-millionths of a volt per degree, so that a small accidental disturbance may produce a serious error with a difference of temperature of only 1° between the junctions. The chief uncertainty in applying this method appears to have arisen from variations of temperature at different parts of the surface, due to inequalities in the heating or cooling effect of the stream of water flowing over the surfaces. Uniformity of temperature could only be secured by using a high velocity of flow, or violent stirring. Neither of these methods could be applied in this experiment. The temperatures indicated by the different pairs of wires differed by as much as 10%, but the mean of the whole would probably give a fair average. The heat transmitted was measured by observing the flow of water (about 20 gm./sec.) and the rise of temperature (about 0.5°C.) in one of the streams. The results appear to be entitled to considerable weight on account of the directness of the method and the full consideration of possible errors. They were as follows:—

Cast-iron, $k=0.1490$ C.G.S. at 30° C., temp. coef.—0.00075.
 Pure iron, $k=0.1530$ at 30° C., temp. coef.—0.0003.

The disks were 10 cms. in diam., and nearly 2 cms. thick, plated with copper to a thickness of 2 mm. The cast-iron contained about 3.5% of carbon, 1.4% of silicon, and 0.5% of manganese. It should be observed, however, that he obtained a much lower value for cast-iron, namely .105, by J. D. Forbes's method, which agrees better with the results given in § 10 below.

7. *Tube Method.*—If the inside of a glass tube is exposed to steam, and the outside to a rapid current of water, or *vice versa*, the temperatures of the surfaces of the glass may be taken to be very approximately equal to those of the water and steam, which may be easily observed. If the thickness of the glass is small compared with the diameter of the tube, say one-tenth, equation (1) may be applied with sufficient approximation, the area A being taken as the mean between the internal and external surfaces. It is necessary that the thickness x should be approximately uniform. Its mean value may be determined most satisfactorily from the weight and the density. The heat Q transmitted in a given time T may be deduced from an observation of the rise of temperature of the water, and the amount which passes in the interval. This is one of the simplest of all methods in practice, but it involves the measurement of several different quantities, some of which are difficult to observe accurately. The employment of the tube form evades one of the chief difficulties of the plate method, namely, the

uncertainty of the flow at the boundary of the area considered. Unfortunately the method cannot be applied to good conductors, like the metals, because the difference of temperature between the surfaces may be five or ten times less than that between the water and steam in contact with them, even if the water is energetically stirred.

8. *Cylinder Method.*

—A variation of the tube method, which can be applied to metals and good conductors, depends on the employment of a thick cylinder with a small axial hole in place of a thin tube. The actual temperature of the metal itself can then be observed by inserting thermometers or thermo-couples at measured distances from the centre. This method has been applied by H. L. Callendar and J. T. Nicolson (*Brit. Assoc. Report*, 1897) to cylinders of cast-iron and mild steel, 5 in. in diam. and 2 ft. long, with 1 in. axial holes. The surface of the central hole was heated by steam under pressure, and the total flow of heat was determined by observing the

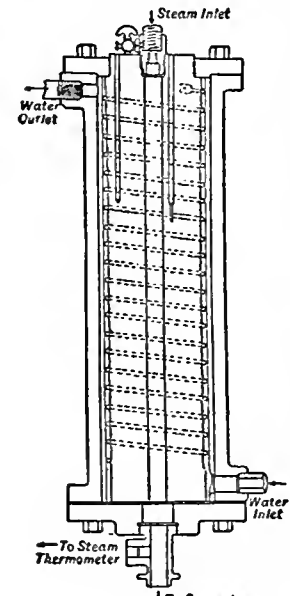

FIG. 1.

amount of steam condensed in a given time. The outside of the cylinder was cooled by water circulating round a spiral screw thread in a narrow space with high velocity driven by a pressure of 120 lb per sq. in. A very uniform surface temperature was thus obtained. The lines of

flow in this method are radial. The isothermal surfaces are coaxial cylinders. The areas of successive surfaces vary as their radii, hence the rate of transmission Q/AT varies inversely as the radius r , and is $Q/2\pi r l T$, if l is the length of the cylinder, and Q the total heat, calculated from the condensation of steam observed in a time T . The outward gradient is $d\theta/dr$, and is negative if the central hole is heated. We have therefore the simple equation

$$-k d\theta/dr = Q/2\pi r l T. \tag{2}$$

If k is constant the solution is evidently $\theta = a \log r + b$, where $a = -Q/2\pi k l T$, and b and k are determined from the known values of the temperatures observed at any two distances from the axis. This gives an average value of the conductivity over the range, but it is better to observe the temperatures at three distances, and to assume k to be a linear function of the temperature, in which case the solution of the equation is still very simple, namely,

$$\theta + \frac{1}{2}e\theta^2 = a \log r + b, \tag{3}$$

where e is the temperature-coefficient of the conductivity. The chief difficulty in this method lay in determining the effective distances of the bulbs of the thermometers from the axis of the cylinder, and in ensuring uniformity of flow of heat along different radii. For these reasons the temperature-coefficient of the conductivity could not be determined satisfactorily on this particular form of apparatus, but the mean results were probably trustworthy to 1 or 2%. They refer to a temperature of about 60° C., and were—

Cast-iron, 0.109; mild steel, 0.119, C.G.S.

These are much smaller than Hall's results. The cast-iron contained nearly 3% each of silicon and graphite, and 1% each of phosphorus and manganese. The steel contained less than 1% of foreign materials. The low value for the cast-iron was confirmed by two entirely different methods given below.

9. *Forbes's Bar Method.*—Observation of the steady distribution of temperature along a bar heated at one end was very early employed by Fourier, Despretz and others for the comparison of conductivities. It is the most convenient method, in the case of good conductors, on account of the great facilities which it permits for the measurement of the temperature gradient at different points; but it has the disadvantage that the results depend almost entirely on a knowledge of the external heat loss or emissivity, or, in comparative experiments, on the assumption that it is the same in different cases. The method of Forbes (in which the conductivity is deduced from the steady distribution of temperature on the assumption that the rate of loss of heat at each point of the bar is the same as that observed in an auxiliary experiment in which a short bar of the same kind is set to cool under conditions which are supposed to be identical) is well known, but a consideration of its weak points is very instructive, and the results have been most remarkably misunderstood and misquoted. The method gives directly, not k , but k/c . P. G. Tait repeated Forbes's experiments, using one of the same iron bars, and endeavoured to correct his results for the variation of the specific heat c . J. C. Mitchell, under Tait's direction, repeated the experiments with the same bar nickel-plated, correcting the thermometers for stem-exposure, and also varying the conditions by cooling one end, so as to obtain a steeper gradient. The results of Forbes, Tait and Mitchell, on the same bar, and Mitchell's two results with the end of the bar "free" and "cooled," have been quoted as if they referred to different metals. This is not very surprising, if the values in the following table are compared:—

TABLE I.—*Thermal Conductivity of Forbes's Iron Bar D (1.25 inches square), C.G.S. Units.*

Temp. Cent.	Uncorrected for Variation of c .				Corrected for Variation of c .			
	Forbes.	Tait.	Mitchell.		Forbes.	Tait.	Mitchell.	
			Free.	Cooled.			Free.	Cooled.
0°	.207	.231	.197	.178	.213	.238	.203	.184
100°	.157	.198	.178	.190	.168	.212	.190	.197
200°	.136	.176	.160	.181	.152	.196	.178	.210

The variation of c is uncertain. The values credited to Forbes are those given by J. D. Everett on Balfour Stewart's authority. Tait gives different figures. The values given in the column headed "cooled" are those found by Mitchell with one end of the bar cooled. The discrepancies are chiefly due to the error of the fundamental assumption that the rate of cooling is the same at the same temperature under the very different conditions existing in the two parts of the experiment. They are also partly caused by the large uncertainties of the corrections, especially those of the mercury thermometers under the peculiar conditions of the experiment. The results of Forbes are interesting historically as having been the first approximately correct determinations of conductivity in absolute value. The same method was applied by R. W. Stewart (*Phil. Trans.*, 1892), with the substitution of thermo-couples (following Wiedemann) for mercury thermometers. This avoids the very uncertain correction for stem-exposure, but it is doubtful how far

an insulated couple, inserted in a hole in the bar, may be trusted to attain the true temperature. The other uncertainties of the method remain. R. W. Stewart found for pure iron, $k = .175$ (1 - .0015 t) C.G.S. E. H. Hall using a similar method found for cast-iron at 50° C. the value .105, but considers the method very uncertain as ordinarily practised.

10. *Calorimetric Bar Method.*—To avoid the uncertainties of surface loss of heat, it is necessary to reduce it to the rank of a small correction by employing a large bar and protecting it from loss of heat. The heat transmitted should be measured calorimetrically, and not in terms of the uncertain emissivity. The apparatus shown in fig. 2 was constructed by Callendar and Nicolson with this object. The bar was a special sample of cast-iron, the conductivity of which was required for some experiments on the condensation of steam (*Proc. Inst. C.E.*, 1898). It had a diameter of 4 in., and a length of 4 ft. between the heater and the calorimeter. The emissivity was reduced to one-quarter by lagging the bar like a steam-pipe to a thickness of 1 in. The heating vessel could be maintained at a steady temperature by high-pressure steam. The other end was maintained at a temperature near that of the air by a steady stream of water flowing through a well-lagged vessel surrounding the bar. The heat transmitted was measured by observing the difference of temperature between the inflow and the outflow, and the weight of water which passed in a given time. The gradient near the entrance to the calorimeter was deduced from observations with five thermometers at suitable intervals along the bar. The

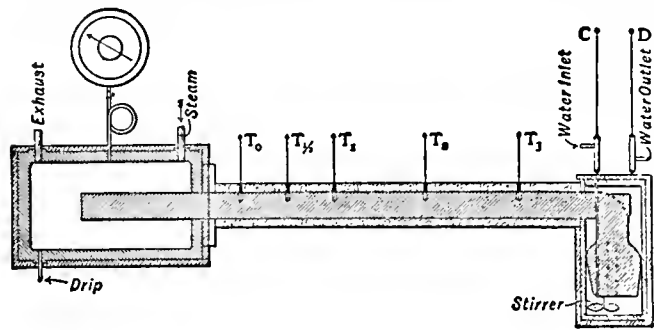

FIG. 2.

results obtained by this method at a temperature of 40° C. varied from .116 to .118 C.G.S. from observations on different days, and were probably more accurate than those obtained by the cylinder method. The same apparatus was employed in another series of experiments by A. J. Ångström's method described below.

11. *Guard-Ring Method.*—This may be regarded as a variety of the plate method, but is more particularly applicable to good conductors, which require the use of a thick plate, so that the temperature of the metal may be observed at different points inside it. A. Berget (*Journ. Phys.* vii. p. 503, 1888) applied this method directly to mercury, and determined the conductivity of some other metals by comparison with mercury. In the case of mercury he employed a column in a glass tube 13 mm. in diam. surrounded by a guard cylinder of the same height, but 6 to 12 cm. in diam. The mean section of the inner column was carefully determined by weighing, and found to be 1.403 sq. cm. The top of the mercury was heated by steam, the lower end rested on an iron plate cooled by ice. The temperature at different heights was measured by iron wires forming thermo-junctions with the mercury in the inner tube. The heat-flow through the central column amounted to about 7.5 calories in 54 seconds, and was measured by continuing the tube through the iron plate into the bulb of a Bunsen ice calorimeter, and observing with a chronometer to a fifth of a second the time taken by the mercury to contract through a given number of divisions. The calorimeter tube was calibrated by a thread of mercury weighing 19 milligrams, which occupied eighty-five divisions. The contraction corresponding to the melting of 1 gramme of ice was assumed to be .0906 c.c., and was taken as being equivalent to 79 calories (1 calorie = 15.59 mgrm. mercury). The chief uncertainty of this method is the area from which the heat is collected, which probably exceeds that of the central column, owing to the disturbance of the linear flow by the projecting bulb of the calorimeter. This would tend to make the value too high, as may be inferred from the following results:—

- Mercury, $k = 0.02015$ C.G.S. Berget.
- „ $k = 0.01479$ „ Weber.
- „ $k = 0.0177$ „ Ångström.

12. *Variable-Flow Methods.*—In these methods the flow of heat is deduced from observations of the rate of change of temperature with time in a body exposed to known external or boundary conditions. No calorimetric observations are required, but the results are obtained in terms of the thermal capacity of unit volume c , and the measurements give the diffusivity

k/c , instead of the calorimetric conductivity k . Since both k and c are generally variable with the temperature, and the mode of variation of either is often unknown, the results of these methods are generally less certain with regard to the actual

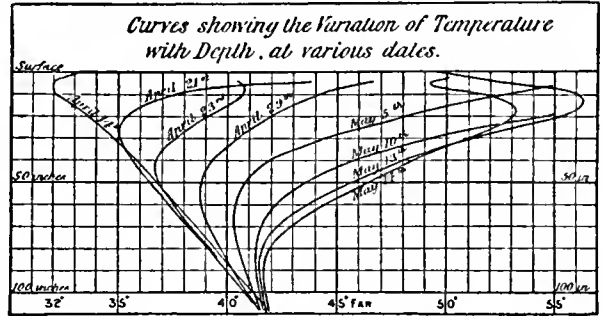

FIG. 3.

flow of heat. As in the case of steady-flow methods, by far the simplest example to consider is that of the linear flow of heat in an infinite solid, which is most nearly realized in nature in the propagation of temperature waves in the surface of the soil. One of the best methods of studying the flow of heat in this case is to draw a series of curves showing the variations of temperature with depth in the soil for a series of consecutive days. The curves given in fig. 3 were obtained from the readings of a number of platinum thermometers buried in undisturbed soil in horizontal positions at McGill College, Montreal.

The method of deducing the diffusivity from these curves is as follows:—The total quantity of heat absorbed by the soil per unit area of surface between any two dates, and any two depths, x' and x'' , is equal to c times the area included between the corresponding curves. This can be measured graphically without any knowledge of the law of variation of the surface temperature, or of the laws of propagation of heat waves. The quantity of heat absorbed by the stratum ($x' x''$) in the interval considered can also be expressed in terms of the calorimetric conductivity k . The heat transmitted through the plane x is equal per unit area of surface to the product of k by the mean temperature gradient (db/dx) and the interval of time, $T - T'$. The mean temperature gradient is found by plotting the curves for each day from the daily observations. The heat absorbed is the difference of the quantities transmitted through the bounding planes of the stratum. We thus obtain the simple equation—

$$k'(db'/dx') - k''(db''/dx'') = c (\text{area between curves}) / (T - T'), \quad (4)$$

by means of which the average value of the diffusivity k/c can be found for any convenient interval of time, at different seasons of the year, in different states of the soil.

For the particular soil in question it was found that the diffusivity varied enormously with the degree of moisture, falling as low as .0010 C.G.S. in the winter for the surface layers, which became extremely dry under the protection of the frozen ice and snow from December to March, but rising to an average of .0060 to .0070 in the spring and autumn. The greater part of the diffusion of heat was certainly due to the percolation of water. On some occasions, owing to the sudden melting of a surface layer of ice and snow, a large quantity of cold water, percolating rapidly, gave for a short time values of the diffusivity as high as .0300. Excluding these exceptional cases, however, the variations of the diffusivity appeared to follow the variations of the seasons with considerable regularity in successive years. The presence of water in the soil always increased the value of k/c , and as it necessarily increased c , the increase of k must have been greater than that of k/c .

13. *Periodic Flow of Heat.*—The above method is perfectly general, and can be applied in any case in which the requisite observations can be taken. A case of special interest and importance is that in which the flow is *periodic*. The general characteristics of such a flow are illustrated in fig. 4, showing the propagation of temperature waves due to diurnal variations in the temperature of the surface. The daily range of temperature of the air and of the surface of the soil was about 20° F. On a sunny day, the temperature reached a maximum about 2 P.M. and a minimum about 5 A.M. As the waves were propagated downwards through the soil the amplitude rapidly

diminished, so that at a depth of only 4 in. it was already reduced to about 6° F., and to less than 2° at 10 in. At the same time, the epoch of maximum or minimum was retarded, about 4 hours at 4 in., and nearly 12 hours at 10 in., where the maximum temperature was reached between 1 and 2 A.M. The form of the wave was also changed. At 4 in. the rise was steeper than

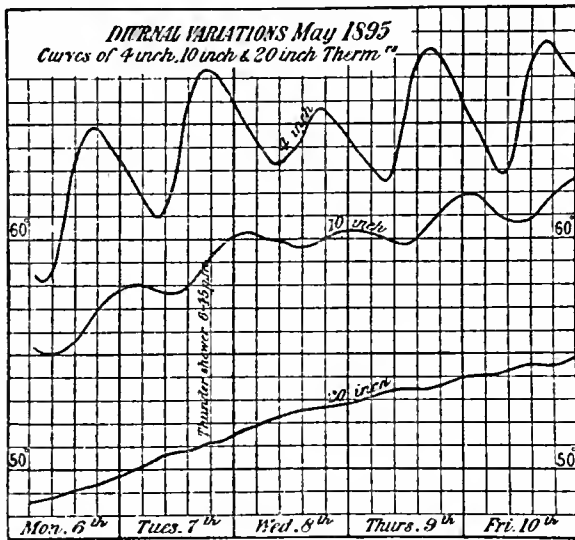

FIG. 4.

the fall, at 10 in. the reverse was the case. This is due to the fact that the components of shorter period are more rapidly propagated. For instance, the velocity of propagation of a wave having a period of a day is nearly twenty times as great as that of a wave with a period of one year; but on the other hand the penetration of the diurnal wave is nearly twenty times less, and the shorter waves die out more rapidly.

14. A Simple-Harmonic or Sine Wave is the only kind which is propagated without change of form. In treating mathematically the propagation of other kinds of waves, it is necessary to analyse them into their simple-harmonic components, which may be treated as being propagated independently. To illustrate the main features of the calculation, we may suppose that the surface is subject to a simple-harmonic cycle of temperature variation, so that the temperature at any time t is given by an equation of the form—

$$\theta - \theta_0 = A \sin 2\pi nt = A \sin 2\pi t/T, \quad (5)$$

where θ_0 is the mean temperature of the surface, A the amplitude of the cycle, n the frequency, and T the period. In this simple case the temperature cycle at a depth x is a precisely similar curve of the same period, but with the amplitude reduced in the proportion e^{-mx} , and the phase retarded by the fraction $mx/2\pi$ of a cycle. The index-coefficient m is $\sqrt{(anc/k)}$. The wave at a depth x is represented analytically by the equation

$$\theta - \theta_0 = Ae^{-mx} \sin (2\pi nt - mx). \quad (6)$$

A strictly periodic oscillation of this kind occurs in the working of a steam engine, in which the walls of the cylinder are exposed to regular fluctuations of temperature with the admission and release of steam. The curves in fig. 5 are drawn for a particular case, but they apply equally to the propagation of a simple-harmonic wave of any period in any substance changing only the scale on which they are drawn. The dotted boundary curves have the equation $\theta = \pm e^{-mx}$, and show the rate of diminution of the amplitude of the temperature oscillation with depth in the metal. The wave-length in fig. 4 is 0.60 in., at which depth the amplitude of the variation is reduced to less than one five-hundredth part ($e^{-2\pi}$) of that at the surface, so that for all practical purposes the oscillation may be neglected beyond one wave-length. At half a wave-length the amplitude is only $\frac{1}{2}$ rd of that at the surface. The wave-length in any case is $2\pi/m$.

The diffusivity can be deduced from observations at different depths x' and x'' , by observing the ratio of the amplitudes, which is $e^{m(x''-x')}$ for a simple-harmonic wave. The values obtained in this way for waves having a period of one second and a wave-length of half an inch agreed very well with those obtained in the same cast-iron by Ångström's method (see below), with waves having a period of 1 hour and a length of 30 in. This agreement was a very satisfactory test of the accuracy of the fundamental law of conduction, as the gradients and periods varied so widely in the two cases.

15. Annual Variation.—A similar method has frequently been

applied to the study of variations of soil-temperatures by harmonic analysis of the annual waves. But the theory is not strictly applicable, as the phenomena are not accurately periodic, and the state of the soil is continually varying, and differs at different depths, particularly in regard to its degree of wetness. An additional difficulty arises in the case of observations made with long mercury thermometers buried in vertical holes, that the correction for the expansion of the liquid in the long stems is uncertain, and that the holes may serve as channels for percolation, and thus lead to exceptionally high values. The last error

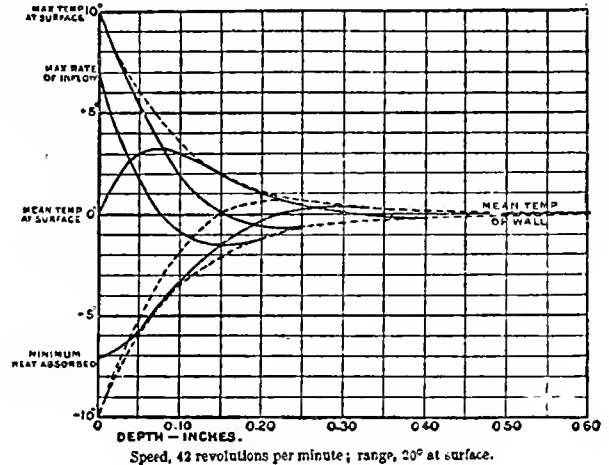

FIG. 5.

is best avoided by employing platinum thermometers buried horizontally. In any case results deduced from the annual wave must be expected to vary in different years according to the distribution of the rainfall, as the values represent averages depending chiefly on the diffusion of heat by percolating water. For this reason observations at different depths in the same locality often give very concordant results for the same period, as the total percolation and the average rate are necessarily nearly the same for the various strata, although the actual degree of wetness of each may vary considerably. The following are a few typical values for sand or gravel deduced from the annual wave in different localities:—

TABLE II.—Diffusivity of Sandy Soils. C.G.S. Units.

Observer.	Soil.	Locality.	Thermo-meter.	Diffusivity.
Kelvin, 1860	Garden sand	Edinburgh	Mercury	.0087
Neumann, 1863	Sandy loam		"	.0136
Everett, 1860	Gravel	Greenwich	"	.0125
Ångström, 1861	Sandy clay	Upsala	"	.0057
Ångström .	" sand	"	"	.0045
Rudberg .	Coarse sand	"	"	.0094
Quetelet .	The same soil, place and instruments reduced for different years			.0061
Callendar, 1895	Garden sand	Montreal	Platinum	.0074
Rambaut, 1900	Gravel	Oxford	"	.0036
				.0074

The low value at Montreal is chiefly due to the absence of percolation during the winter. A. A. Rambaut's results were obtained with similar instruments similarly located, but he did not investigate the seasonal variations of diffusivity, or the effect of percolation. It is probable that the coarser soils, permitting more rapid percolation, would generally give higher results. In any case, it is evident that the transmission of heat by percolation would be much greater in porous soils and in the upper layers of the earth's crust than in the lower strata or in solid rocks. It is probable for this reason that the average conductivity of the earth's crust, as deduced from surface observations, is too large; and that estimates of the age of the earth based on such measurements are too low, and require to be raised; they would thereby be brought into better agreement with the conclusions of geologists derived from other lines of argument.

16. Ångström's Method consists in observing the propagation of heat waves in a bar, and is probably the most accurate method for

measuring the diffusivity of a metal, since the conditions may be widely varied and the correction for external loss of heat can be made comparatively small. Owing, however, to the laborious nature of the observations and reductions, the method does not appear to have been seriously applied since its first invention, except in one solitary instance by the writer to the case of cast-iron (fig. 2). The equation of the method is the same as that for the linear flow with the addition of a small term representing the radiation loss.

The heat per second gained by conduction by an element dx of the bar, of conductivity k and cross section q , at a point where the gradient is $d\theta/dx$, may be written $qk(d\theta/dx)dx$. This is equal to the product of the thermal capacity of the element, $cqdx$, by the rate of rise of temperature $d\theta/dt$, together with the heat lost per second at the external surface, which may be written $h\phi\theta dx$, if ϕ is the perimeter of the bar, and h the heat loss per second per degree excess of temperature θ above the surrounding medium. We thus obtain the differential equation

$$qk(d^2\theta/dx^2) = cq d\theta/dt + h\phi\theta,$$

which is satisfied by terms of the type

$$\theta = e^{-ax} \sin(2\pi nlt - bx),$$

where $a^2 - b^2 = h\phi/qk$, and $ab = \pi nc/k$.

The rate of diminution of amplitude expressed by the coefficient a in the index of the exponential is here greater than the coefficient b expressing the retardation of phase by a small term depending on the emissivity h . If $h=0$, $a=b=\sqrt{(\pi nc/k)}$, as in the case of propagation of waves in the soil.

The apparatus of fig. 2 was designed for this method, and may serve to illustrate it. The steam pressure in the heater may be periodically varied by the gauge in such a manner as to produce an approximately simple harmonic oscillation of temperature at the hot end, while the cool end is kept at a steady temperature. The amplitudes and phases of the temperature waves at different points are observed by taking readings of the thermometers at regular intervals. In using mercury thermometers, it is best, as in the apparatus figured, to work on a large scale (4-in. bar) with waves of slow period, about 1 to 2 hours. Ångström endeavoured to find the variation of conductivity by this method, but he assumed c to be the same for two different bars, and made no allowance for its variation with temperature. He thus found nearly the same rate of variation for the thermal as for the electric conductivity. His final results for copper and iron were as follows:—

Copper, $k=0.982$ ($1-0.00152\theta$) assuming $c=.84476$.

Iron, $k=0.1988$ ($1-0.00287\theta$) " $c=.88620$.

Ångström's value for iron, when corrected for obvious numerical errors, and for the probable variation of c , becomes—

$$\text{Iron, } k=0.164 \text{ (} 1-0.0013\theta \text{),}$$

but this is very doubtful as c was not measured.

The experiments on cast-iron with the apparatus of fig. 2 were varied by taking three different periods, 60, 90 and 120 minutes, and two distances, 6 in. and 12 in., between the thermometers compared. In some experiments the bar was lagged with 1 in. of asbestos, but in others it was bare, the heat-loss being thus increased fourfold. In no case did this correction exceed 7%. The extreme divergence of the resulting values of the diffusivity, including eight independent series of measurements on different days, was less than 1%. Observations were taken at mean temperatures of 102°C . and 54°C ., with the following results:—

Cast iron at 102°C ., $k/c=.1296$, $c=.858$, $k=.1113$.

" " 54°C ., $k/c=.1392$, $c=.823$, $k=.1144$.

The variation of c was determined by a special series of experiments. No allowance was made for the variation of density with temperature, or for the variation of the distance between the thermometers, owing to the expansion of the bar. Although this correction should be made if the definition were strictly followed, it is more convenient in practice to include the small effect of linear expansion in the temperature-coefficient in the case of solid bodies.

17. Lorenz's Method.—F. Neumann, H. Weber, L. Lorenz and others have employed similar methods, depending on the observation of the rate of change of temperature at certain points of bars, rings, cylinders, cubes or spheres. Some of these results have been widely quoted, but they are far from consistent, and it may be doubted whether the difficulties of observing rapidly varying temperatures have been duly appreciated in many cases. From an experimental point of view the most ingenious and complete method was that of Lorenz (*Wied. Ann.* xiii. p. 422, 1881). He deduced the variations of the mean temperature of a section of a bar from the sum S of the E.M.F.'s of a number of couples, inserted at suitable equal intervals l and connected in series. The difference of the temperature gradients D/l at the ends of the section was simultaneously obtained from the difference D of the readings of a pair of couples at either end connected in opposition. The external heat-loss was eliminated by comparing observations taken at the same mean temperatures during heating and during cooling, assuming that the rate of loss of heat $f(S)$ would be the same in the two cases. Lorenz thus obtained the equations:—

$$\text{Heating, } qk D/l = cql dS/dt + f(S).$$

$$\text{Cooling, } qk D'/l = cql dS'/dt' + f(S').$$

$$\text{Whence } k = c^2 l (dS/dt - dS'/dt') / (D - D').$$

It may be questioned whether this assumption was justifiable, since the rate of change and the distribution of temperature were quite different in the two cases, in addition to the sign of the change itself. The chief difficulty, as usual, was the determination of the gradient, which depended on a difference of potential of the order of 20 microvolts between two junctions inserted in small holes 2 cms. apart in a bar 1.5 cms. in diameter. It was also tacitly assumed that the thermo-electric power of the couples for the gradient was the same as that of the couples for the mean temperature, although the temperatures were different. This might give rise to constant errors in the results. Owing to the difficulty of measuring the gradient, the order of divergence of individual observations averaged 2 or 3%, but occasionally reached 5 or 10%. The thermal conductivity was determined in the neighbourhood of 20°C . with a water jacket, and near 110°C . by the use of a steam jacket. The conductivity of the same bars was independently determined by the method of Forbes, employing an ingenious formula for the heat-loss in place of Newton's law. The results of this method differ 2 or 3% (in one case nearly 15%) from the preceding, but it is probably less accurate. The thermal capacity and electrical conductivity were measured at various temperatures on the same specimens of metal. Owing to the completeness of the recorded data, and the great experimental skill with which the research was conducted, the results are probably among the most valuable hitherto available. One important result, which might be regarded as established by this work, was that the ratio k/k' of the thermal to the electrical conductivity, though nearly constant for the good conductors at any one temperature such as 0°C ., increased with rise of temperature nearly in proportion to the absolute temperature. The value found for this ratio at 0°C . approximated to 1500 C.G.S. for the best conductors, but increased to 1800 or 2000 for bad conductors like German-silver and antimony. It is clear, however, that this relation cannot be generally true, for the cast-iron mentioned in the last section had a specific resistance of 112,000 C.G.S. at 100°C ., which would make the ratio $k/k' = 12,500$. The increase of resistance with temperature was also very small, so that the ratio varied very little with temperature.

18. Electrical Methods.—There are two electrical methods which have been recently applied to the measurement of the conductivity of metals, (a) the resistance method, devised by Callendar, and applied by him, and also by R. O. King and J. D. Duncan, (b) the thermo-electric method, devised by Kohlrausch, and applied by W. Jaeger and H. Dieselhorst. Both methods depend on the observation of the steady distribution of temperature in a bar or wire heated by an electric current. The advantage is that the quantities of heat are measured directly in absolute measure, in terms of the current, and that the results are independent of a knowledge of the specific heat. Incidentally it is possible to regulate the heat supply more perfectly than in other methods.

(a) In the practice of the resistance method, both ends of a short bar are kept at a steady temperature by means of solid copper blocks provided with a water circulation, and the whole is surrounded by a jacket at the same temperature, which is taken as the zero of reference. The bar is heated by a steady electric current, which may be adjusted so that the external loss of heat from the surface of the bar is compensated by the increase of resistance of the bar with rise of temperature. In this case the curve representing the distribution of temperature is a parabola, and the conductivity k is deduced from the mean rise of temperature $(R-R^0)/aR^0$ by observing the increase of resistance $R-R^0$ of the bar, and the current C . It is also necessary to measure the cross-section q , the length l , and the temperature-coefficient a for the range of the experiment.

In the general case the distribution of temperature is observed by means of a number of potential leads. The differential equation for the distribution of temperature in this case includes the majority of the methods already considered, and may be stated as follows. The heat generated by the current C at a point x where the temperature-excess is θ is equal per unit length and time (l) to that lost by conduction $-d(qk d\theta/dx)/dx$, and by radiation $h\phi\theta$ (emissivity h , perimeter ϕ), together with that employed in raising the temperature $cq d\theta/dt$, and absorbed by the Thomson effect $sCd\theta/dx$. We thus obtain the equation—

$$C^2 R_0(1+a\theta)/l = -d(qk d\theta/dx)/dx + h\phi\theta + cq d\theta/dt + sCd\theta/dx. \quad (8)$$

If $C=0$, this is the equation of Ångström's method. If h also is zero, it becomes the equation of variable flow in the soil. If $d\theta/dt=0$, the equation represents the corresponding cases of steady flow. In the electrical method, observations of the variable flow are useful for finding the value of c for the specimen, but are not otherwise required. The last term, representing the Thomson effect, is eliminated in the case of a bar cooled at both ends, since it is opposite in the two halves, but may be determined by observing the resistance of each half separately. If the current C is chosen so that $C^2 R_0 a = h\phi l$, the external heat-loss is compensated by the variation of resistance

with temperature. In this case the solution of the equation reduces to the form

$$t = x(l-x)C^2R_0/2lqk. \quad (9)$$

By a property of the parabola, the mean temperature is $\frac{1}{2}$ of the maximum temperature, we have therefore

$$(R-R_0)/R_0 = 2C^2R_0/12qk, \quad (10)$$

which gives the conductivity directly in terms of the quantities actually observed. If the dimensions of the bar are suitably chosen, the distribution of temperature is always very nearly parabolic, so that it is not necessary to determine the value of the critical current $C = hpl/aR_0$ very accurately, as the correction for external loss is a small percentage in any case. The chief difficulty is that of measuring the small change of resistance accurately, and of avoiding errors from accidental thermo-electric effects. In addition to the simple measurements of the conductivity (McGill College, 1895-1896), some very elaborate experiments were made by King (*Proc. Amer. Acad.*, June 1898) on the temperature distribution in the case of long bars with a view to measuring the Thomson effect. Duncan (*McGill College Reports*, 1899), using the simple method under King's supervision, found the conductivity of very pure copper to be 1.007 for a temperature of 55° C.

(b) The method of Kohlrausch, as carried out by Jaeger and Dieselhorst (*Berlin Acad.*, July 1899), consists in observing the difference of temperature between the centre and the ends of the bar by means of insulated thermo-couples. Neglecting the external heat-loss, and the variation of the thermal and electric conductivities k and k' , we obtain, as before, for the difference of temperature between the centre and ends, the equation

$$t_{max} - t_1 = C^2R/5qk = EC/5qk = E^2k'/5k, \quad (11)$$

where E is the difference of electric potential between the ends. Lorenz, assuming that the ratio $k/k' = ak$, had previously given

$$t_{max} - t_1 = E^2/4a, \quad (12)$$

which is practically identical with the preceding for small differences of temperature. The last expression in terms of k/k' is very simple, but the first is more useful in practice, as the quantities actually measured are E , C , l , q , and the difference of temperature. The current C was measured in the usual way by the difference of potential on a standard resistance. The external heat-loss was estimated by varying the temperature of the jacket surrounding the bar, and applying a suitable correction to the observed difference of temperature. But the method (a) previously described appears to be preferable in this respect, since it is better to keep the jacket at the same temperature as the end-blocks. Moreover, the variation of thermal conductivity with temperature is small and uncertain, whereas the variation of electrical conductivity is large and can be accurately determined, and may therefore be legitimately utilized for eliminating the external heat-loss.

From a comparison of this work with that of Lorenz, it is evident that the values of the conductivity vary widely with the purity of the material, and cannot be safely applied to other specimens than those for which they were found.

19. *Conduction in Gases and Liquids.*—The theory of conduction of heat by diffusion in gases has a particular interest, since it is possible to predict the value on certain assumptions, if the viscosity is known. On the kinetic theory the molecules of a gas are relatively far apart and there is nothing analogous to friction between two adjacent layers A and B moving with different velocities. There is, however, a continual interchange of molecules between A and B, which produces the same effect as viscosity in a liquid. Faster-moving particles diffusing from A to B carry their momentum with them, and tend to accelerate B; an equal number of slower particles diffusing from B to A act as a drag on A. This action and reaction between layers in relative motion is equivalent to a frictional stress tending to equalize the velocities of adjacent layers. The magnitude of the stress per unit area parallel to the direction of flow is evidently proportional to the velocity gradient, or the rate of change of velocity per cm. in passing from one layer to the next. It must also depend on the rate of interchange of molecules, that is to say, (1) on the number passing through each square centimetre per second in either direction, (2) on the average distance to which each can travel before collision (i.e. on the "mean free path"), and (3) on the average velocity of translation of the molecules, which varies as the square root of the temperature. Similarly if A is hotter than B, or if there is a gradient of temperature between adjacent layers, the diffusion of molecules from A to B tends to equalize the temperatures, or to conduct heat through the gas at a rate proportional to the temperature gradient, and depending also on the rate of interchange of molecules in the same way as the viscosity effect. Conductivity and viscosity in a gas should vary

in a similar manner since each depends on diffusion in a similar way. The mechanism is the same, but in one case we have diffusion of momentum, in the other case diffusion of heat. Viscosity in a gas was first studied theoretically from this point of view by J. Clerk Maxwell, who predicted that the effect should be independent of the density within wide limits. This, at first sight, paradoxical result is explained by the fact that the mean free path of each molecule increases in the same proportion as the density is diminished, so that as the number of molecules crossing each square centimetre decreases, the distance to which each carries its momentum increases, and the total transfer of momentum is unaffected by variation of density. Maxwell himself verified this prediction experimentally for viscosity over a wide range of pressure. By similar reasoning the thermal conductivity of a gas should be independent of the density. This was verified by A. Kundt and E. Warburg (*Jour. Phys.* v. 118), who found that the rate of cooling of a thermometer in air between 150 mm. and 1 mm. pressure remained constant as the pressure was varied. At higher pressures the effect of conduction was masked by convection currents. The question of the variation of conductivity with temperature is more difficult. If the effects depended merely on the velocity of translation of the molecules, both conductivity and viscosity should increase directly as the square root of the absolute temperature; but the mean free path also varies in a manner which cannot be predicted by theory and which appears to be different for different gases (Rayleigh, *Proc. R.S.*, January 1896). Experiments by the capillary tube method have shown that the viscosity varies more nearly as θ^2 , but indicate that the rate of increase diminishes at high temperatures. The conductivity probably changes with temperature in the same way, being proportional to the product of the viscosity and the specific heat; but the experimental investigation presents difficulties on account of the necessity of eliminating the effects of radiation and convection, and the results of different observers often differ considerably from theory and from each other. The values found for the conductivity of air at 0° C. range from .000048 to .000057, and the temperature-coefficient from .0015 to .0028. The results are consistent with theory within the limits of experimental error, but the experimental methods certainly appear to admit of improvement.

The conductivity of liquids has been investigated by similar methods, generally variations of the thin plate or guard-ring method. A critical account of the subject is contained in a paper by C. Chree (*Phil. Mag.*, July 1887). Many of the experiments were made by comparative methods, taking a standard liquid such as water for reference. A determination of the conductivity of water by S. R. Milner and A. P. Chattock, employing an electrical method, deserves mention on account of the careful elimination of various errors (*Phil. Mag.*, July 1899). Their final result was $k = .001433$ at 20° C., which may be compared with the results of other observers, G. Lundquist (1869), .00155 at 40° C.; A. Winkelmann (1874), .00104 at 15° C.; H. F. Weber (corrected by H. Lorberg), .00138 at 4° C., and .00152 at 23.6° C.; C. H. Lees (*Phil. Trans.*, 1898), .00136 at 25° C., and .00120 at 47° C.; C. Chree, .00124 at 18° C., and .00136 at 19.5° C. The variations of these results illustrate the experimental difficulties. It appears probable that the conductivity of a liquid increases considerably with rise of temperature, although the contrary would appear from the work of Lees. A large mass of material has been collected, but the relations are obscured by experimental errors.

See also Fourier, *Theory of Heat*; T. Preston, *Theory of Heat*, chap. vii.; Kelvin, *Collected Papers*; O. E. Meyer, *Die kinetische Theorie der Gase*; A. Winkelmann, *Handbuch der Physik*.

(H. L. C.)

CONE (Gr. *κωνος*), in geometry, a surface generated by a line (the generator) which always passes through a fixed point (the vertex) and through the circumference of a fixed curve (the directrix). The two sheets of the surface, on opposite sides of the vertex, are called the "nappés" of the cone. The solid formed between the vertex and a plane cutting the surface is also called a "cone"; this is contained by a conical surface and the plane of section. Euclid defines a "right cone" as the

solid figure formed by the revolution of a right-angled triangle about one of the sides containing the right angle. The axis of the cone is the side about which the triangle revolves; the circle traced by the other side containing the right angle is the "base"; the hypotenuse in any one of its positions is a generator or generating line; and the intersection of the axis and a generator is termed the vertex. The Euclidean definition may be modified, so as to avoid the limits thereby placed on the figure, viz. the notion that the solid is between the vertex and the base. A general definition is as follows:—If two intersecting straight lines be given, and one of the lines is made to revolve about the other, which is fixed in such a manner that the angle between the lines is everywhere the same, then the surface (or solid) traced out by the moving line (or generator) is a cone, having the fixed line for axis, the point of intersection of the lines for vertex, and the angle between the lines for the semi-vertical angle of the cone.

An "oblique cone" is the solid or surface traced out by a line which passes through a fixed point and through the circumference of a circle, the fixed point not being on the line through the centre of the circle perpendicular to its plane. A "quadric cone" is a cone having any conic for its base. The plane containing the vertex, centre of the base, and perpendicular to the base is called the principal section; and the section of a cone by a plane containing the vertex is a triangle if the solid be considered, and two intersecting lines if the surface be considered. The "subcontrary section" of an oblique cone is made by a plane not parallel to the base, but perpendicular to the principal section, and inclined to the generating lines in that section at the same angles as the base; this section is a circle. The planes parallel to the base or subcontrary section are called "cyclic planes."

The Greeks distinguished three types of right cones, named "acute," "right-angled" and "obtuse," according to the magnitude of the vertical angle; and Menaechmus showed that the sections of these cones by planes perpendicular to a generator were the ellipse, parabola and hyperbola respectively. Apollonius went further when he derived these curves by varying the inclination of the section of any right or oblique cone (see CONIC SECTION). It is to be noted that the Greeks investigated these curves *in solido*, and consequently the geometry of the cone received much attention. The mensuration of the cone was established by Archimedes. He showed that the volume of the cone was one-third of that of the circumscribing cylinder, and that this was true for any type of cone. Therefore the volume is one-third of the product area of base X vertical height. The surface of a right circular cone is equal to one-half of the circumference of the base multiplied by the slant height of the cone.

Analytically, the equation to a right cone formed by the revolution of the line $y=mx$ about the axis of x is $z=m(x^2+y^2)$. Obviously every tangent plane passes through the vertex: this is the characteristic property of conical surfaces. Conical surfaces are also "developable" surfaces, i.e. the surface can be applied to a plane without wrinkling or bending. Connected with quadric cones is the interesting curve termed the "sphero-conic," which is the curve of intersection of any quadric cone and a sphere having its centre at the vertex of the cone.

References should be made to the articles GEOMETRY and SURFACE for further discussion; and to the bibliographies of these articles for sources where the subject can be further studied. The geometrical construction of the curves of intersection of the cone with other solids is given in treatises on descriptive solid geometry, e.g. T. H. Eagles, *Constructive Geometry*.

CONECTE, THOMAS (d. 1434), French Carmelite monk and preacher, was born at Rennes. He travelled through Flanders and Picardy, denouncing the vices of the clergy and the extravagant dress of the women, especially their lofty head-dresses, or *houettes*. He ventured to teach that he who is a true servant of God need fear no papal curse, that the Roman hierarchy is corrupt, and that marriage is permissible to the clergy, of whom only some have the gift of continence. He was listened to by immense congregations, and in Italy, despite the opposition

of Nicolas Kerton (d. 1268), provincial of the English Carmelites, he introduced several changes into the rules of that order. He was finally apprehended by order of Pope Eugenius IV., condemned and burnt for heresy.

An account of Friar Thomas's preaching and its effect is given by Enguerrand de Monstrelet, provost of Cambrai (d. 1453), in his continuation of Froissart's chronicles.

CONEGLIANO, a town and episcopal see of Venetia, Italy, in the province of Treviso, 17 m. N. by rail from the town of Treviso, 290 ft. above sea-level. Pop. (1901) town, 5880; commune, 10,072. It is commanded by a large castle. It was the birthplace of the painter Cima da Conegliano, a fine sharp-peace by whom is in the cathedral (1490). The place is noted for its wine, chiefly sweet champagne.

CONESTOGA (said to mean "people of the immersed or forked poles"), a tribe of North American Indians of Iroquoian stock. Their country was Pennsylvania and Maryland on the lower Susquehanna river and at the head of Chesapeake bay. They were sometimes known as Susquehannas. They were formerly a powerful people, able to resist the attacks of the Iroquois. In 1675, however, the latter overwhelmed and scattered them. After nearly a century of wandering, the tribe suffered final extinction in the Indian wars of 1763.

CONY ISLAND, an island about 9 m. S.E. of the S. end of Manhattan Island, U.S.A., on the S. shore of Long Island, from which it is separated by Gravesend Bay, Sheepshead Bay, Coney Island Cove, a tidal inlet, and a broad stretch of low salt marshes. It lies within the limits of the Borough of Brooklyn, New York city. The island is the westernmost of a chain of outlying sandbars that extends along the southern shore of Long Island for almost 100 m.; it is about 5 m. long and varies from ½ m. to 1 m. in width. It is served by the Long Island railway, by several lines of electric railway, and (in summer) by steamboat lines. The island is the most popular seashore resort of the United States. There are four quite distinctly marked districts. At the extreme western extremity, Norton's Point, is the district known as Sea Gate, lying between Gravesend Bay and Lower New York Bay. It is an exclusively residential section, has a fine light-house, a large number of summer homes and the handsome club-house of the Atlantic Yacht Club. A broad shore drive connects it on the E. with West Brighton, the most popular amusement centre, to which the name Coney Island has come to be more especially applied. Its great scenic and spectacular features, "side-shows," booths, cafés and dancing halls, have made "Coney Island" a well-known resort. There are bathing beaches, two immense iron pier, observation towers, scenic railways, "Ferris" wheels, and the two amusement reservations known as "Luna Park" and "Dreamland." From West Brighton a broad parkway known as "the Boardwalk" connects with Brighton Beach, ¼ m. to the E., passing the large bathing establishments maintained by the city of New York. At Brighton Beach there are a large hotel, a theatre and the Brighton Race Track. Still further to the E., and extending to the eastern extremity of the island, lies Manhattan Beach, with hotels, a theatre and baths, and patronized more largely by a wealthier class of visitors. Adjacent to Manhattan Beach on the mainland, and separated from it by a narrow neck of Sheepshead Bay, lies the village of Sheepshead Bay, in which is the famous race track of the Coney Island Jockey Club.

CONFALONIERI, FEDERICO, Count (1785-1846), Italian revolutionist, was born at Milan, descended from a noble Lombard family. In 1806 he married Teresa Casati. During the Napoleonic period Confalonieri was among the opponents of the French régime, and was regarded as one of the leaders of the *Italiani puri* or Italian national party. At the time of the Milan riots of 1812, when the minister Prina was assassinated, Confalonieri was unjustly accused of complicity in the deed. After the fall of Napoleon he went to Paris with the other Lombard delegates to plead his country's cause, advocating the formation of a separate Lombard state under an independent prince. But he received no encouragement, for Lombardy was destined for Austria, and Lord Castlereagh crossed him by

saying that "the Austrian government was the most beneficent in the world." Confalonieri went on to London, in the hope of winning the favour of the British government, but failed in his object. He then joined the freemasons and some of the various other secret societies with which all Europe was swarming, being initiated by Filippo Buonarroti (1761-1837), an old Tuscan Jacobin living in Paris. On returning to Milan, where he found the Austrians in possession, he at first devoted himself to promoting the material progress of his country, but he was ever watching for an opportunity to liberate it from the foreigner.

Early in 1821, when the atmosphere was thick with rumours of revolt, he visited various parts of Italy to sound the liberal leaders, and also corresponded with the Piedmontese officers who, believing that they had the approval of Prince Charles Albert of Carignano, the heir to the throne, were planning a military revolt. There was talk of a rising at Milan combined with a Piedmontese invasion to expel the Austrians, but the plans were very vague and unpractical, for the military conspirators could count only on a few hundred men, and Confalonieri warned them that Lombardy was not ready. On the outbreak of the Piedmontese revolt (March-April 1821) the Austrian authorities made some arrests, and, through the treachery of one conspirator and the foolishness of others, discovered the plot, if it could so be called, and arrested Silvio Pellico and Maroncelli and afterwards Confalonieri. A long trial now began, conducted with all the rigour and secrecy of the Austrian procedure, and Confalonieri, outwitted by the astute examining magistrate, A. Salvotti (d. 1866), contradicted himself, made fatal admissions, even compromised others, and together with several companions was condemned to death for high treason, but through the intercession of his wife and father, who went to Vienna to plead his cause in person, the emperor Francis commuted the penalty to perpetual imprisonment in the fortress of Spielberg (January 1824). Confalonieri was taken to Vienna and had a long interview with Prince Metternich, who tried to extract further confessions incriminating other persons, especially Charles Albert, but although Confalonieri seemed at one time inclined to prepare a report on the revolutionary movement for the emperor, he did not do so, and once he was in prison he refused to say or write another word, and was treated with exceptional severity in consequence. His wife died in 1830, and in 1836, on the death of the emperor Francis, he was pardoned and exiled to America. He came back to Europe after a year's absence, and in 1840 obtained permission to return to Milan to see his dying father. He himself, broken in health and spirits, died on the 10th of December 1846, too soon to see the accomplishment of Italian freedom. He had undoubtedly played a considerable rôle in the conspiracy of 1821, being the most influential and richest of the Milanese Liberals; when first arrested his conduct may have been open to criticism, but he more than expiated any temporary weakness due to ill-health and to the barbarous methods of examination by his heroic attitude during his long imprisonment, and his persistent refusal to accept offers of pardon accompanied by dishonouring conditions.

His *Memoire e Lettere* have been edited by Gabrio Casati (2 vols., Milan, 1890). A. D'Ancona's *Federico Confalonieri* (Milan, 1898) is based on the memoirs and on a large number of secret documents from the archives of Vienna and Milan. A. Luzio's *Antonio Salvotti e i processi del Ventuno* (Rome, 1901) contains many fresh documents which to some extent exonerate Salvotti from the charge of cruelty; among other papers Metternich's account of his interview with Confalonieri is given in full. See also A. Luzio, *Nuovi documenti sul processo Confalonieri* (Rome, 1908). (L. V. *)

CONFARREATIO, the ancient patrician form of marriage among the Romans, especially necessary at the nuptials of those whose children were intended to be vestal virgins or flames of Jupiter. The name originated in the bride and bridegroom sharing a cake of spelt (*far* or *panis farreus*), in the presence of the *pontifex maximus*, *flamen dialis*, and ten witnesses. This form of marriage could only be dissolved by another equally solemn ceremony, which was called *diffarreatio*. In later republican times, *confarreatio* became obsolete except in the

case of the most sacred priesthods—the *flamines* and the *rex sacrorum*. *Confarreatio* was the most solemn of the three forms of marriage (*q.v.*), but in later times the ceremony fell into disuse, and Cicero mentions but two, *cœmptio* and *usus*. (See ROMAN LAW.)

CONFECTIONERY (from Lat. *confectio*, *conficere*, compound), a term of rather vague application, embracing all food preparations of the nature of sweetmeats, pastry, &c., which have sugar (*q.v.*) for their basis or principal ingredient. In this way the industry may be said to include the preservation of fruits by means of sugar, the manufacture of jams and jellies, the art of preparing fruit-syrups and pastes, ices, and sweetened beverages, in addition to the various manufactures in which sugar is the more prominent and principal ingredient. In former days the making of sweetmeats was part of a druggist's business, but in the earlier half of the 19th century it developed into a separate industry in England, and the International Exhibition of 1851 resulted in its spreading to other countries. At the present day France and Germany are prominent in all sorts of confectionery and *bon-bons*; and the "candy" industry in America has developed enormously.

The simplest form in which sugar is prepared as a sweet for eating is that of *lozenges*, which consist of finely ground sugar mixed with dissolved gum to form a stiff dough. This is rolled into sheets of the desired thickness from which the lozenges are stamped out by appropriate cutters and then allowed to dry and harden in a heated apartment. They are coloured and flavoured with a great variety of ingredients, which are added in suitable proportions with the dissolved gum. Many kinds of medicated lozenges are also in extensive use, the medicinal ingredients being similarly incorporated with the gum. Hard sweetmeats, *comfits* or *dragées*, constitute another important variety of confectionery. To make these a core or centre of some kind is taken, consisting of a small lozenge, or of some seed or fruit, such as an almond, coriander, caraway, pistachio, &c., and successive layers of sugar are deposited around it till the desired size is attained. The cores are placed in large copper pans or vessels which are heated by a steam coil or jacket, or by hot air, and which are geared to rotate at an inclined angle so that their contents are kept constantly in motion, tumbling over each other. From time to time sugar syrup is added as they appear to get dry, and after receiving a certain coating they are removed to dry and harden. After a sufficient number of alternate coatings in the pan and dryings, the comfits are finished with a coating of thin syrup, which may be coloured if desired. Another extensive class of confectionery is made with sugar boiled at different temperatures, the various degrees of heating being known as thread, blow or feather, ball, crack, caramel, &c. In some cases a little cream of tartar, or glucose to the extent of 30% or even more, is used with the sugar. By treatment of this kind the sugar is obtained in a wide range of consistencies, from soft and creamy, as in *fondants*, to clear and hard, as in *barley sugar*. By vigorous and continued drawing out or "pulling" of boiled sugar while it is in a plastic condition, the molecular structure of the material is changed, and from being glassy and transparent it becomes opaque, porous and granular in appearance. In this way the preparation known as *rock* is manufactured. For *liqueurs*, a flavoured syrup is dropped into moulds impressed in dry starch, when a crust of sugar forms on the outside, the interior remaining liquid. The thickness of this crust is then increased by immersing it in syrup from which more sugar-crystals are deposited upon it, and the sweets may be finished in the comfit-pan already mentioned. *Sugar-candy* is prepared from solutions of either brown or refined sugar, to the latter of which cochineal or other colouring ingredient is frequently added. The solutions, when boiled to a proper degree, are poured into moulds across which pieces of string are stretched at sufficient intervals. Kept in a chamber heated from 90° to 100° F., the sugar gradually crystallizes on the strings and the sides of the mould, and when sufficient has been deposited the remaining liquor is drained off, and the crystals are removed and dried by heat. Machinery, often of

elaborate character, is now extensively employed in almost all branches of the confectionery trade. For *chocolate* see that article, also *Cocoa*.

CONFEDERATE STATES OF AMERICA, the title of the independent government, formed by the seceding Southern States at the opening of the American Civil War, in the winter of 1860-1861. These States contained roughly half the population of the Northern States which remained in the Union. In proportion to their population they had played a more important part in the previous political history of the United States than was their share. The formation of the new Confederacy was in the hands of experienced statesmen, well schooled in the politics of their respective states and in the halls of the Federal Congress to undertake such a task. Jefferson Davis of Mississippi was almost naturally chosen president, his rival candidates being Alexander H. Stephens, subsequently chosen to fill the vice-presidency of the Confederacy, an important exponent of states' rights, and during the war a strong antagonist of President Davis's policy, and Robert Toombs of Georgia, a strong secessionist. The latter became a prominent member of the Confederate Congress, and, like Stephens, opposed the despotic powers of the Richmond government. President Davis had been trained in the Federal army, as well as in the Congress and in the National administration. His administration of the Confederate presidency cannot be called brilliant. The difficulties he contended with, however, were insurmountable; but his official acts were always the result of an unselfish desire to do what seemed best for the cause he espoused. The president's cabinet contained, among others, Judah P. Benjamin, secretary of state; C. G. Memminger (1803-1888), and later George A. Trenholm (1806-1876), secretaries of the treasury; G. W. Randolph (1818-1878) and James A. Seddor (1815-1880), secretaries of war; S. R. Mallory (1813-1873), secretary of the navy, and John H. Reagan, postmaster-general. Of these Benjamin was distinctly the most powerful intellectually. Memminger, with little training or aptitude for his difficult position, did not distinguish himself as a financier, and was succeeded in the summer of 1864 by Trenholm, a Charleston banker, of high intelligence and good training, who, however, found it impossible to save the Confederacy from financial ruin. Of other Confederates prominent in official positions the following may be mentioned: Howell Cobb, a former member of the Federal Congress and of President Buchanan's cabinet, serving as speaker of the provisional Confederate congress and later in the field; Robert W. Barnwell (1801-1882) and William L. Yancey; Benjamin H. Hill (1823-1882) and A. H. Keenan of Georgia; John A. Campbell (1811-1889), before the war a judge of the U. S. Supreme Court; Judge A. G. Magrath (1813-1893), a prominent judge of the Confederate court in South Carolina; Governors Z. B. Vance of North Carolina, and J. E. Brown of Georgia (1821-1894).

In framing their provisional and permanent constitutions in 1861 the Confederate statesmen emphasized the points of view which had characterized them in the great constitutional discussions of the previous half-century. They also aimed to correct certain defects in the United States Constitution by amending that document in various directions. The Southern "States' Rights" view of the sovereign and independent position of the individual states was emphasized in the Confederate constitutions, which even went so far as to allow a state legislature to impeach a Confederate official acting within that state. Moreover, in the provisional Confederate constitution state officials were not bound by oath to support the central government. The powers of the executive were increased as against the prerogatives of the congress. The president was allowed to veto particular appropriations and approve others in the same bill. His term of office was lengthened to seven years, and he was declared ineligible for a second term of office. The cabinet officers were allowed seats in either house of congress, in imitation of the practice in Great Britain, which Alexander H. Stephens especially was anxious to transplant to the American continent. The congress could appropriate money for particular

purposes only by a two-thirds majority, unless the appropriation were asked for by the head of that department. Every bill was to refer to one subject, and that subject was to be expressed in the title, a provision aimed at preventing "omnibus" and confused legislation, in which it signally failed.

The Southern attitude toward a protective tariff was emphasized by the constitutional provision that no bounty should be paid and no taxes levied for the benefit of any branches of industry. Similarly the central government could not authorize internal improvements except for aids to navigation. Also the expenses of the post office were not allowed to exceed its receipts. The old Constitution had carefully avoided the use of the word "slave," but the Confederate constitutions had no such scruples, and, moreover, recognized the legitimate existence of slavery, and forbade all legislation which might impair the right of property in negro slaves.

These changes all had reference to times of peace. The war powers of the government were left unchanged from those provided for by the Federal Constitution. Provisions of that document as to suspending the writ of habeas corpus and the provisions regarding conscription were left equally vague in the new Confederate Constitution. These led to acrimonious discussion and much bitter feeling against the centralized war powers of the government at Richmond. As the war progressed, the Richmond authorities became necessarily more and more oppressive and aroused the "States' Rights" feeling prevalent in the South. It became evident that a confederated form of government, such as was planned by the Southerners, was unsuited to the stringent requirements of war times and contributed doubtless somewhat to the final cataclysm.

The provisions of the new constitution regarding the issue of legal tender paper money remained the same as of old. In the North such legal tender paper began to be issued in the spring of 1862, and later opened the question of the constitutionality of such a practice. No Confederate legal tender act was ever passed, though the agitation in that direction was often strong. The objections which prevented the passage of such an act were the same as those offered by the minority in later years against the constitutionality of the Federal legal tender act. The Southerners were too true to their strict constructionist views of the constitution to admit the constitutionality of a legal tender act.

The personnel of the Confederate congress and administration was materially weakened by the military field's drawing off the most brilliant Southern leaders. It was largely owing to the strategical skill of these generals that the Southern armies, smaller and more poorly equipped than their opponents, maintained the unequal contest for four years. In the naval operations the North had an overwhelming advantage, which was promptly and effectively used. The blockade of the Southern ports, beginning in the spring of 1861, was much less spectacular than the operations of the army, but was quite as effective in breaking down the Confederacy. It cut off the South from obtaining foreign war supplies, and reduced it to dependence upon its own products, which were almost exclusively agricultural. Manufacturing industries hardly existed in the South. A few iron works attempted with little success to meet the demand for ordnance. This and small-arms were obtained from the Federal arsenals in 1861, by capture and to some extent by eluding the blockade. Powder factories were established and vigorously operated. The scarcity and high price of clothing put a large premium on the establishment of textile factories, but their product was far below the demand.

The South was unfortunate in having a poorly developed railway system. As compared with those of the North, its railways were inadequately equipped and did not form connected systems. During the war, the inroads of the Federal troops, and the natural deterioration of the lines and their rolling stock, greatly reduced the value of the railroads as a military factor. They continued to be active in distributing the relatively small amount of imports through the blockaded ports of Charleston, Savannah and Wilmington. Their usefulness to the army and

the city population in collecting food material from the country districts was much impaired.

The harvests in the South during the war were fairly abundant, as far as they were not destroyed by the advancing Northern armies. Maize was raised in large quantities, and, in general, the raising of food products instead of tobacco and cotton was encouraged by legislation and otherwise. The scarcity of food in the armies and cities was chiefly due to the breaking down of the means of transportation, and to the paper money policy and its attendant repressive measures.

The specie holdings of the Southern banks largely found their way into the Confederate treasury in payment for the \$15,000,000 loan effected early in 1861. In addition, the government secured the specie in the various Federal offices which fell into its power. These sums were soon sent to Europe in payment of foreign war supplies. The gold and silver in general circulation also soon left the country almost entirely, driven out by the rising flood of paper money. Aside from the payment of the above loan the government never secured any specie revenue, and was driven headlong into the wholesale issue of paper money. The first notes were issued in March 1861, and bore interest. They were soon followed by others, bearing no interest and payable in two years, others payable six months after peace. New issues were continually provided, so that from an initial \$1,000,000 in circulation in July 1861, the amount rose to 30 millions before December 1861; to 100 millions by March 1862; to 200 millions by August 1862; to perhaps 450 millions by December 1862; to 700 millions by the autumn of 1863; and to a much larger figure before the end of the war.

This policy of issuing irredeemable paper money was copied by the individual states and other political bodies. Alabama began by issuing \$1,000,000 in notes in February 1861, and added to this amount during each subsequent session of the state legislature. The other states followed suit. Cities also sought to replenish their treasuries in the same way. Corporations and other business concerns tried to meet the rising tide of prices with the issue of their individual promissory notes intended to circulate from hand to hand. As a result of this redundancy of the currency the price of gold rose to great heights. It was quoted at a premium in Confederate notes in April 1861. By the end of that year a paper dollar was quoted at 90 cents in gold; during 1862 that figure fell to 40 cents; during 1863, to 6 cents; and still lower during the last two years of the war. The downward course of this figure, with occasional recoveries, reflects the popular estimate of the Confederacy's chance of maintaining itself against the Northern invasion. The fluctuations of the gold premium in the North during the same years are a complementary movement, and correspondingly reflect the periods of popular elation and depression as to the final outcome of the war.

The redundant currency drove the price of commodities to exorbitant heights, and deranged all business. It affected different classes of commodities differently. Those the supply of which was entirely from abroad, like coffee, rose to the greatest height owing to their scarcity produced by the blockade. Ingenious substitutes were found for such articles, and enormous profits were secured by the merchants who successfully ran the blockade and imported such much-needed articles of foreign origin. These speculators were continually abused for making such importations instead of confining themselves to supplying the government with foreign war supplies. Articles that were produced in the South and marketed abroad or in the North during normal times rose least in value. Tobacco and cotton, for instance, which found no buyers owing to the blockade, actually fell in value as quoted in gold. The great divergence of the price of these two commodities in the South and abroad—the Northern price of cotton increased more than tenfold during the war—offered the strongest inducement to evade the blockade and export them. A small amount of cotton reached the world's market by way of the Atlantic ports or Mexico, and netted those concerned in the venture handsome profits.

The same motive operated to encourage trade with the enemy. Tobacco and cotton were smuggled through the military lines in exchange for hospital stores, coffee and similar articles. The military authorities tried to suppress this illicit trade, but at times even they were carried away by the desire to secure the much-desired foreign supplies. The civil government also vacillated between the policy of encouraging exports, especially to Europe in exchange for foreign goods, and the policy of forbidding such trade in view of the supposed advantage accruing to foreigners, who it was hoped would be compelled to acknowledge the independence of the Confederacy in order to secure Southern cotton.

The derangement of prices, their local differences and fluctuations, produced wild speculation in the South. Normal business was almost impossible, and the gambling element was forced into every transaction. Speculation in gold was especially pronounced. Legislation and popular feeling were aimed at it, but without avail. Even the government itself was compelled to speculate in gold. Speculation in food and other articles was equally inevitable and was much decried. Laws were formed to curb the speculators, but had no effect.

The policy of the Southern banks during the war encouraged speculation. The New Orleans banks had been well managed, and remained solvent until September 1861. The banks of the other states suspended specie payments at the end of 1860, and thereafter enlarged their note issue and their loans, thereby adding to the general redundancy of the currency and stimulating the prevalent speculative craze. They did a large business by speculating in cotton, making advances to the planters on the basis of their crops. The state governments also used their note issues for this purpose, the planters urgently demanding relief as their cotton could not reach a market. The Confederate government also made advances on cotton and secured large quantities by purchase, to serve as the basis of cotton bonds. The rise of prices reflecting the redundancy of the currency was no advantage to the producer. Frequent efforts were made by legislation and otherwise to reduce the prices demanded especially by the agriculturists. As a result, the production of food products fell off, at least the agriculturists did not bring their products to market for fear of being forced to sell them at a loss. Supplies for the army were obtained by impressment, the price to be paid for them being arbitrarily fixed at a low figure. As a result, the army administration found it almost impossible to induce producers of food willingly to turn over their products, and the army suffered from want. Under these confused industrial circumstances the sufferings of the debtor class were loudly asserted, and laws were passed to relieve them of their burdens, making the collection of debts difficult or impossible. The debts of Southerners to Northerners contracted before the war were confiscated by the Confederate government, but did not amount to a large figure.

The effectiveness of the Federal blockade and the peculiar industrial development of the South removed the possibility of an ample government revenue. Though import duties were levied, the proceeds amounted to almost nothing. A small export duty on cotton was expected to produce a large revenue sufficient to base a loan upon, but the small amount of cotton exports reduced this source of revenue to an insignificant figure. There being, moreover, no manufactures to tax under an internal revenue system such as the North adopted, the Confederacy was cut off from deriving any considerable revenue from indirect taxation. The first Confederate tax law levied a direct tax of twenty millions of dollars, which was apportioned among the states. These, with the exception of Texas, contributed their apportioned share to the central government by issuing bonds or notes, so that the tax was in reality but a disguised form of loan. Real taxation was postponed until the spring of 1863, when a stringent measure was adopted taxing property and earnings. It was slowly and with difficulty put into effect, and was re-enacted in February 1864. In the states and cities there was a strong tendency to relax or postpone taxation in view of the other demands upon the people.

With no revenue from taxation, and with the disastrous effects of the wholesale issue of paper money before it, the Confederate government made every effort to borrow money by the issue of bonds. The initial 15-million loan was soon followed by an issue of one hundred millions in bonds, which it was, however, difficult to place. This was followed by even larger loans. The bonds rapidly fell in value, and were quoted during the war at approximately the value of the paper money, in which medium they were paid for by subscribers. To avoid this circumstance a system of produce loans was devised by which the bonds were subscribed for in cotton, tobacco and food products. This policy was subsequently enlarged, and enabled the government to secure at least a part of the armies' food supplies. But the bulk of the subscriptions for these bonds was made in cotton, for which the planters were thus enabled to find a market.

It was hoped to keep the currency within bounds by holders of paper money exchanging it for bonds, which the law allowed and encouraged, but as notes and bonds fell in value simultaneously, there was no inducement for holders to make that exchange. On the contrary, a note-holder had an advantage over a bond-holder, in that he could use his currency for speculation or for purchases in general. In the autumn of 1862 the Confederate law attempted to compel note-holders to fund their notes in bonds, in order thereby to reduce the redundancy of the currency and lower prices. Disappointed in the result of this legislation, the Congress, in February 1864, went much farther in the same direction by passing a law requiring note-holders to fund their notes before a certain date, after which notes were taxed a third or more of their face value. This drastic measure was accepted as meaning a partial repudiation of the Confederate debt, and though it for the time reduced the currency outstanding and lowered prices, it wrecked the government's credit, and made it impossible for the Treasury to float any more loans. During the last months of the war the Treasury led a most precarious existence, and its actual operations can only be surmised.

During the entire war the notion that the South possessed a most efficient engine of war in its monopoly of cotton buoyed up the hopes of the Southerners. The government strained every effort to secure recognition of the Confederacy as a nation by the great powers of Europe. It also more successfully secured foreigners' financial recognition of the South by effecting a foreign loan based on cotton. This favourite notion was put into practice in the spring of 1863. The French banking house of Erlanger & Company undertook to float a loan of £3,000,000, redeemable after the war in cotton at the rate of sixpence a pound. As cotton at the time was selling at nearly four times that figure and would presumably be quoted far above sixpence long after the establishment of peace, the bonds offered strong attractions to those speculatively inclined and in sympathy with the Southern cause. The placing of the bonds in Europe was mismanaged by the Confederate agents, but notwithstanding a considerable sum was secured from the public and used for the purchase of naval and military stores. At the close of the war these foreign bonds were ignored by the re-established Federal authorities like all the other bonds of the Confederate government. Compared with the partial success of this financial recognition by Europe, the South conspicuously failed in securing the political recognition of the Confederate government. Early in 1861 W. L. Yancey and others went to Europe to enlist the sympathy of foreign governments in the Southern cause. J. M. Mason and John Slidell followed early in 1862, after a short detention by the Federal government, which had removed them from a British vessel *en route* to Europe. Though these Confederate commissioners made every effort to induce foreign governments, especially those of Great Britain and France, to recognize the Confederacy, they were foiled in their efforts, largely by the skill and persistence of the Federal minister in London, Charles Francis Adams.

The political history of the Confederate States is the culmination of an inevitable conflict, the beginnings of which are found

in the earlier history of the Union. The financial and industrial history of the South during 1861 to 1865 is the story of a struggle with overwhelming odds. The mistakes of the Confederate government's policy are overshadowed by its desperate efforts to maintain itself against the irresistible attacks of the North. In making that effort the South sacrificed everything, and emerged from the war a financial and industrial wreck.

BIBLIOGRAPHY.—*Confederate Archives in the War Department* (Washington, unpublished documents and letters); *Journal of the Congress of the C.S.A., 1861-1865* (reprinted by the U.S. Government, 1904); J. C. Schwab, *The Confederate States of America* (New York, 1901; a financial and industrial history of the South, 1861-1865; contains a full bibliography); Southern newspaper files; John Bigelow, *France and the Confederate Navy* (New York, 1888); J. D. Bulloch, *Secret Service of the Confederate States in Europe* (London, 1883; New York, 1884); H. D. Capers, *Life of C. G. Memminger* (Richmond, 1893); Jefferson Davis, *Rise and Fall of the Confederate Government* (New York, 1881); *De Bow's Review* (New Orleans, 1860-1864); J. L. M. Curry, *Civil History of the Government of the Confederate States* (Richmond, 1901); Herbert Fielder, *Life of Joseph E. Brown* (Springfield, Mass., 1883); J. B. Jones, *Rebel War Clerk's Diary* (Philadelphia, 1866); E. McPherson, *Political History of the United States* (4th ed., Washington, 1882; contains many important documents); *Official Records: Compilation of the War of the Rebellion* (Washington, 3rd series, 1880-1900; contains a great mass of Southern official correspondence); E. A. Pollard, various books on the Civil War; J. F. Rhodes, *History of the United States*, especially volumes iii.-v. (New York, 1898-1904); *Statutes of the Provisional Government of the C.S.A.* (Richmond, 1864); *Statutes at Large of the C.S.A., First Congress* (Richmond, 1862); *Public Laws of the C.S.A., 1863-1864* (Richmond, 1864); *Statutes at Large of the C.S.A., Second Congress* (Richmond, 1864); Documents of the various state governments. (J. C. Sc.)

CONFEDERATION (Fr. *confédération*, Lat. *confoederatio*, from *foedus*, a league, *foederare*, to form a league), primarily any league, or union of people, or bodies of people. The term in modern political use is generally confined to a permanent union of sovereign states, for certain common purposes, e.g. the German Confederation (*Bund*), established by the congress of Vienna in 1815, and the Confederation of the Rhine (*Rheinbund*), a league of certain German states under the protection of Napoleon (1806-1813). The alliance of the Great Powers by which Europe was governed after 1815 was sometimes, especially by the emperor Alexander I., called the "Confederation of Europe"; but this expressed rather a pious aspiration than the actual state of affairs. The distinction between Confederation and Federation (see FEDERAL GOVERNMENT), synonymous in their origin, has been developed in the political terminology of the United States. Up to 1789 these were a Confederation; then the word Federation, or Federal Republic, was introduced as implying closer union. This distinction was emphasized during the Civil War between North and South, the seceding states forming a Confederation (Confederate States of America) in opposition to the Federal Union. Confederation thus comes to mean a union of sovereign states in which the stress is laid on the sovereign independence of each constituent body (cf. the German *Staatenbund*); Federation implies a union of states in which the stress is laid on the supremacy of the common government (Ger. *Bundesstaat*). The distinction is, however, by no means universally observed.

The variant "Confederacy," derived through the Anglo-French *confederacie*, and meaning generally a league or union, whether of states or individuals, was applied in America in the sense of Confederation to the seceding southern states (see above). In its political sense, however, confederacy has generally come to mean rather a temporary league of independent states for certain purposes. As applied to individuals, while "confederation" is used of certain open unions of people for political or other purposes (e.g. the Miners' Confederation), "confederacy"—from its obsolete legal sense of conspiracy—has come frequently to imply a secret bond, a combination for illicit purposes, or of persons whose identity is not disclosed.

CONFERENCE, a bringing together (Lat. *conferre*) for the purpose of discussion, particularly a meeting of members of one or more societies, of representatives of legislative or other bodies, or of different states. Such are the meetings between members of the upper and lower chambers of the British parliament, or

of the United States congress, to adjust matters of difference, and the assemblies of the prime ministers of the various British colonies, held at stated intervals to consult with the imperial government. The title of Colonial Conference was changed to that of Imperial Conference in 1907, but the proposal to change Conference to Council was dropped; it was felt that the administrative functions usually connoted by the word "council" made that title less suitable to an assembly with purely deliberative and consultative powers, which were more fitly expressed by "conference." In diplomacy the word "conference" is used of a meeting of the representatives of states of greater or less importance for the purpose of settling particular points, as distinguished from a "congress," which is properly a meeting of the great powers for the settlement of questions of general interest. In practice, however, the distinction is not consistently maintained. The meetings preliminary to a congress and the sessions of the congress itself are also styled "conferences" (see CONGRESS). The word is also applied to the annual assemblies for transacting church business in the Wesleyan Methodist Church of Great Britain and to various similar assemblies in the Methodist Episcopal Church of America (see METHODISM).

CONFESSION (Lat. *confessio*, from *confiteor*, acknowledge, confess), a term meaning in general the admission and acknowledgment that one has done something which otherwise might remain undisclosed, especially the acknowledgment of guilt or wrong-doing, either in public or to somebody specially entitled to such knowledge. The term has a special importance (1) in religion, (2) in law.

1. *Religion*.—Among the Jews it was ordered that on the Day of Atonement the high priest should make confession of sins in the name of the whole people, and the day is still kept by the Jews with fasting and confession of sins. The Jews were also enjoined to confess their sins individually to God, and in certain cases to man.

In the Gospels confession is scarcely mentioned. But much is said about forgiveness, and the church is empowered to administer God's pardon (John xx. 23 and Matt. xviii. 18). But it should be noted that the primary reference of "binding and loosing" is, according to rabbinical usage, rather to the laying down of rules than to condoning breaches of them; and nothing is said to confine the words "Whose soever sins ye forgive" to the offences of Christians already baptized, and they should be held to include preaching the Gospel and baptizing converts as well as the administration of internal discipline.

The rest of the New Testament is scarcely more explicit on the subject, which did not become so urgent in the days of early enthusiasm, and when the second coming of the Lord was expected immediately. Baptism conveys the forgiveness of sins, and therefore ought to result in freedom from all wilful sin. But what was to be done with the baptized Christian who fell into grievous sin? On the one hand the Epistle to the Hebrews (vi. 4-6) declared that renewals of the lapsed are impossible. On the other, the confession of sins was ordered in James v. 15, 16 and 1 John i. 9, and the exercise of discipline is referred to in 1 Cor. v. and 2 Cor. ii. 5-11 (the identification of the two cases is precarious), Gal. vi. 1 and other passages. Though nothing was as yet systematized, the governing principle is laid down that the sin of the member affects the whole body, and therefore the society is bound to deal with it both from pity for the sinner, and for the sake of its own purity.

It soon became necessary to face the various questions involved more systematically. The definite discussion of the problems dates from *The Shepherd of Hermas* (published at Rome about A.D. 145). Hermas rejects both the extreme opinions, viz. that to the baptized Christian there is either no such thing as sin, or no such thing as further forgiveness. He represents the church as a woman who offers sinful Christians a unique opportunity for conversion and restoration, which must be seized at once or lost for ever. But while he insists on repentance and mortification, he says nothing about public confession or discipline. Soon bitter controversies arose, especially in the West, where questions

of discipline have always been to the fore (see MONTANISM; NOVATIANUS; DONATISTS). Speaking broadly the development was from rigour to indulgence, and the three schisms referred to voiced the protests of the puritan minority.

At the beginning of the 3rd century something like a definite system had been established at Carthage and elsewhere. Three groups of sins, classified as (1) idolatry, which included apostasy, (2) adultery or fornication, and (3) murder, were held to exclude the guilty person from sharing in the eucharist until death, that is to say, if he had committed the sin after baptism. Not that it was asserted that he, therefore, could not be forgiven by God; indeed he was urged to pray and fast and undergo church discipline; but the church refused to venture on any anticipation of the divine decision. For other grave sins the baptized person was allowed to undergo discipline once, but only once in his life; if he relapsed again, he must remain excommunicate like the adulterer. Baptism was the first plank thrown out to save the drowning man, "confession" the second, and there was no third chance. It was largely due to the rigour of this rule that men so frequently deferred baptism till late in life. Less serious sins, again, were held to be adequately dealt with by ordinary prayers, such as the Lord's Prayer, or by the public prayers of the church. Public but general confession of sins and intercession for penitent sinners have from early times formed a normal part of public worship in the Christian church.

The process of public confession or penance (*exomologesis*, Greek for public confession) was as follows (see Tertullian, *De paenitentia* IX., and other writers). The sinner was admitted to it as to a privilege by laying on of hands. He wore sackcloth, made his bed in ashes, and fasted or used only the very plainest fare. In secret he gave himself up to ceaseless prayer; in public he threw himself at the brethren's feet to entreat their intercessions. This went on for a time proportionate to the gravity of the offence, perhaps for years; then, if his sin allowed it, he was readmitted by the bishop and clergy with further laying on of hands. He must still (at least according to later rules) live in strict abstinence, forgoing, e.g., the use of marriage. And if he fell away, he could never be restored again. One can hardly be surprised that Tertullian says that few faced such an ordeal. In this account nothing is said of confession; but it would appear that in early days the sins were made known to the congregation, and in notorious cases they would take the initiative and expel the offender. It was also common for a penitent to take advice as to the necessity in his case of undergoing *exomologesis*, and this, of course, involved confession. Origen implies that in his days the penitent might choose his own spiritual physician. It is to be noticed that the clergy were never admitted to this public discipline; but a cleric might be deposed and then admitted as a layman. Ordinarily the sinful cleric prayed and fasted at his own discretion, and nothing is said of his confessing his sins. In fact far more importance was attached to the discipline than to confession.

Church practice was not the same everywhere at the same time; just because Scripture only gave the ruling principles, therefore the different churches worked out their application in different ways. It is, therefore, natural that we should trace the stages of development through the friction they caused. Thus Calixtus, bishop of Rome 219-223, decided to admit adulterers to *exomologesis* and so to communion; and Tertullian, now become a Montanist, pours out his scorn on him. Thirty years later, first at Carthage, then at Rome, the same step has been taken with regard to penitent apostates, at least the less guilty of them. But the church was thereby involved in a double conflict; for while on the one hand the Novatianist schism represents the puritan outcry against such laxity, on the other the martyrs (not indeed for the first time) claimed a position above church law, and gave trouble by issuing *libelli pacis*, i.e. requests or even orders that so-and-so, and sometimes the name was not inserted, should be readmitted to communion forthwith without undergoing the discipline of *exomologesis*. It was out of this practice that later on Indulgences grew up.

A further relaxation appears about the same time. Those

under discipline were allowed to receive the eucharist when *in articulo mortis*. As this was sometimes effected by means of the reserved sacrament without any formal reconciliation, even without the presence of bishop or priest, it affords further evidence of the emphasis being laid on contrition and submission to discipline rather than on absolution. Cyprian, *Epist. xviii.*, sanctions a dying man's making confession (*exomologesis*) of his sin before a deacon in case of necessity, and being reconciled by laying on of hands.

At the beginning of the 4th century a system came into use by which penitents undergoing discipline were divided into four grades, the lowest being the mourners, then the hearers, the kneelers and the *consistentes* (standing). Thus by the 11th canon of Nicaea certain who had been guilty of apostasy were to be three years among the hearers, seven among the kneelers, and two among the *consistentes*. These grades were distinguished by their admission to or exclusion from parts of the church and of divine service; none of them were allowed to communicate until their penance was complete, except *in articulo mortis*.

In the same century at Rome and at Constantinople we hear of "penitentiaries," that is priests appointed to act for the bishop in hearing the confession of sins, and deciding whether public discipline was necessary and, if it was, on its duration; in other words they prepared the penitents for solemn reconciliation by the bishop. A scandal at Constantinople in 391 led to the suppression in that city not only of the office of penitentiary, but practically of public *exomologesis* also, and that seemingly in Eastern Christendom generally, so that the individual was left to assess his own penance, and to present himself for communion at his own discretion. This inevitably led on to the reiteration of confession after repeated lapses, and Chrysostom (bishop of Constantinople, 398-407) was attacked for allowing such a departure from ancient rule.

But in the West public discipline continued, though under less and less rigorous conditions. Persecution having ceased, the question of apostasy had lost its chief significance, and as church life became public and influential the evils of scandal were intensified. Penitents, therefore (as a rule), were excused the painful ordeal of public humiliation, but performed their penances in secret; only at the end they were publicly reconciled by the bishop. This was at Rome and Milan appointed to be done on the Thursday before Easter, and gradually became a regular practice, the same penitent year after year doing penance during Lent, and being publicly restored to communion in Holy Week. Towards the end of the 4th century priests began to be allowed to take the bishop's place in the re-admission of penitents and to do it privately. And with this step the evolution of the system was completed. The abandonment of plenary penitence (*i.e.* the full rigour of *exomologesis*), the extension of the system in which there was nothing public about the penitence except the solemn reconciliation on Maundy Thursday, the allowing of repeated recourse to this reconciliation, the delegation to priests of the power to reconcile penitents in private; such were the successive stages in the development.

The irruptions of the barbarians revolutionized the whole system of daily life. The various tribes were indeed converted to the faith one after another; but it took centuries to break them in to anything like obedience to Christian principles of morality. In consequence the Christian world tended to be divided into two classes. The first, the religious, including women and laymen as well as clergy, still maintained the old ideals of purity and mutual responsibility. Thus in the chapter-house of a monastery there constantly took place acts of discipline that depended on the theory that the sin of the individual is the concern of the society; open confession was made, open penance exacted. On the other hand, the still half-heathen world outside broke every moral law with indifference; and in the effort to restrain men's vices church discipline became mechanical instead of sympathetic, penal rather than paternal. The penance was regarded (not without precedent in earlier times) as the discharge of a liability due to God or the Church; and so much sin was reckoned to involve so much debt. Thus we reach what has been

called *la pénitence tarifée*. Penitentials or codes defined (even invented) different degrees of guilt, and assessed the liability involved much as if a sin gave rise to an action to recover damages. The Greek penitentials date from about 600; the Latin are a little later; the most influential was that of Theodore of Tarsus, who was archbishop of Canterbury from 668 to 690. Two disastrous results not infrequently arose: a money payment was often allowed in lieu of acts of penance, and the prayers and merits of others were held to supply the inadequacy of the sinner's own repentance (see *INDULGENCE*). Meanwhile the constant repetition of confession and reconciliation, together with the fact that the most tender consciences would be the most anxious for the assurance of forgiveness, led to the practice being considered a normal part of the Christian life. It came to be allowed to be used by priests as well as by laymen. Absolution was reckoned one of the sacraments, one of the seven when that mystic number was generally adopted; but there was no agreement as to what constituted the essential parts of the sacrament, whether the confession, the laying on of hands, the penance, or the words of dismissal. It was more and more regarded as the special function of the priest to administer absolution, though as late as the 16th century we hear of laymen confessing to and absolving one another on the battlefield because no priest was at hand. Moreover, the idea of corporate responsibility and discipline was overshadowed by that of medicine for the individual soul, though public penance was still often exacted, especially in cases of notorious crime, as when Henry II. submitted to the scourge after the murder of Becket.

At last in 1215 the council of the Lateran decreed that every one of either sex must make confession at least once a year before his parish priest, or some other priest with the consent of the parish priest. Treating this rule as axiomatic the Schoolmen elaborated their analyses of the sacrament of penance, distinguishing form and matter, attrition and contrition, mortal and venial sins. The Council of Trent in 1551 repudiated the worst corruptions and repelled as slanders certain charges which were made against the medieval system; but it retained the obligation of annual confession, and laid it down that the form of the sacrament consisted in the priest's words of absolution. (See *ABSOLUTION*.)

As confession is now administered in the Roman Church, the disciplinary penance is often little more than nominal, the recitation of a psalm or the like—stress being laid rather on the fulness of the confession and on the words of authoritative absolution. No one is allowed to receive holy communion, if guilty of "mortal" sin, without resorting to confession; only if a priest has to celebrate mass, and there is no other priest to hear his confession, may he receive "unabsolved" after mortal sin. The faithful are bound to confess all "mortal" sins; they need not confess "venial" sins. It is common to go to confession, even though there are only venial sins to be confessed; and in order to excite contrition people are sometimes advised to confess over again some mortal sin from which they have been previously absolved. No priest may hear confessions without licence from the bishop. Certain special sins are "reserved," that is, the ordinary priest cannot give absolution for them; the matter must be referred to the bishop, or even the pope. Children begin to go to confession at about the age of seven.

In the Greek Church confession has become obligatory and habitual. Among the Lutherans auricular confession survived the Reformation, but the general confession and absolution before communion were soon allowed by authority to serve as a substitute; in Württemberg as early as the 16th century, in Saxony after 1657, and in Brandenburg by decree of the elector in 1698. Private confession and absolution were, however, still permitted; though as may be seen from Goethe's experience, related in his *Dichtung und Wahrheit*, it tended to become a mere form, a process encouraged by the fact that the fees payable for absolution formed part of the pastor's regular stipend. Since the beginning of the 19th century the practice of auricular confession has been to a certain extent revived

among orthodox Lutherans (see Herzog-Hauck, *Realencyklopädie* s. "Beichte").

To come to England, Wesley provided for spiritual discipline (1) through the class-meeting, whose leader has to advise, comfort or exhort as occasion may arise; and (2) through the ministers, who have to bear the chief responsibility in the reproof, suspension or expulsion from communion of erring brethren. In the Salvation Army people are continually invited to come forward to the "penitent form," and admissions of past evil living are publicly made. Among the Calvinistic bodies in the British Isles and abroad kirk-discipline has been a stern reality; but in none of them is there private confession or priestly absolution.

The Church of England holds in this matter as in others a central position. The method of confession adopted in the public services of the Church of England, with which the Book of Common Prayer is primarily concerned, may be described as one of general confession to God in the face of the church, to be in secret used by each member of the congregation for the confession of his own particular sins, and to be followed by public absolution. But three other methods of confession for private use are mentioned in the exhortations in the communion service, which constitute the principal directory for private devotions among the authoritative documents of the English Church. First, all men are urged to practise secret confession to God alone, and in it the sins are to be acknowledged in detail. Secondly, where the nature of the offence admits of it, the sinner is to acknowledge his wrongdoing to the neighbour he has aggrieved. And, thirdly, the sinner who cannot satisfy his conscience by these other methods is invited to open his grief to a minister of God's word. Similarly, the sick man is to be moved to make a special confession of his sins if he feels his conscience troubled with any weighty matter. The priest is bound, under the most stringent penalties, never to divulge what he has thus learnt. See the 113th canon of 1604, which, however, excepts crimes "such as by the laws of this realm the priest's own life may be called into question for concealing the same." It is, however, maintained by some that, except in the case of the sick, the only legitimate method of receiving absolution in the Church of England is in the public services of the congregation; and the Church of Ireland has recently made important alterations even in the passages that concern the sick, while the Protestant Episcopal Church of the United States has omitted that part of the visitation service altogether.

It is probable that auricular confession never altogether died out in the Church of England, but it is obvious that evidence on the subject must always be hard to find. Certainly there has been a great increase and development of the practice since the Oxford movement in the early part of the 19th century. Two chief difficulties have attended this revival. In the first place, owing to the general disuse of such ministrations, there were none among the English clergy who had experience in delicate questions of conscience; and there had been no treatment of casuistry since Sanderson and Jeremy Taylor (see CASUISTRY). Those, then, who had to hear penitents unburden their souls were driven to the use of Roman writers on the subject. A book called *The Priest in Absolution* was compiled, and at first privately circulated among the clergy; but in 1877 a copy was produced in parliament, and gave rise to much scandal and heated debate, especially in the House of Lords and in the newspapers. In the following year Dr Pusey published a translation of the Abbé J. J. Gaume's *Manual for Confessors*, abridged and "adapted to the use of the English Church." The other chief difficulty arose from the absence of any authoritative restraint on the hearing of confessions by young and unqualified priests, the Church of England merely directing the penitent who wishes for special help to resort to any "discreet and learned minister." In 1873 a petition signed by four hundred and eighty-three clergy was presented to Convocation asking for the "education, selection and licensing of duly qualified confessors." The bishops declined so to act, but drew up a report on the subject of confession. The question excites the keenest feeling, and

extreme views are held on either side. On the one hand, it is opposed as the citadel of sacerdotal authority and as a peril to morals. On the other hand, there are those who speak as if auricular confession were a necessary element in every Christian life, and hold that post-baptismal sin of a grave sort can receive forgiveness in no other way. Such a view cannot be found within the covers of the English Prayer-Book.

BIBLIOGRAPHY.—Hooker, *Ecclesiastical Polity*, book vi.; Morinus, *Commentarius historicus de sacramento paenitentiae*; Marshal, *Penitential Discipline* (1717); F. W. Robertson, *Sermons, third series—Absolution* (London, 1857); Mead, "Exomologesis" and "Penitence" in *Dictionary of Christian Antiquities* (London, 1875); E. B. Pusey, *Advice, &c., being the Abbé Gaume's Manual for Confessors, &c.* (Oxford, 1878); Carter, *The Doctrine of Confession in the Church of England* (London, 1885); H. C. Lea, *A History of Auricular Confession and Indulgences in the Latin Church* (Philadelphia, 1896); Boudinhon in *Revue d'histoire et de littérature religieuses* (1897 and 1898); H. Wace, *Confession and Absolution. Report of Fulham Conference* (London, 1902); H. B. Swete, in *Journal of Theological Studies* (April 1903); P. Batiffol, *Études d'histoire et de théologie positive, première série* (4th ed., Paris, 1906). (W. O. B.)

2. *Law.*—In criminal procedure confession has always, of course, played an important part, and the attempt to obtain such a confession from the incriminated person, whether by physical torture or by less violent means, was formerly, and in certain countries still remains, a recognized expedient for securing the conviction of the guilty. This method was carried to ruthless extremes by the Inquisition (*q.v.*), but was by no means unknown in countries in which this institution never gained a foothold; as in England, where torture was practised, though never legalized, for this purpose. In spite of a general tendency to relinquish the inquisitorial method, it is still prevalent in certain countries, notably in France, where the efforts of the prosecution, especially during the preliminary investigations, are directed to extracting a confession from the accused. In English law, on the other hand, the confession of an incriminated person can be received in evidence against him only if it has been free and voluntary. Any threat or inducement held out to a person to make a confession renders the confession inadmissible, even if afterwards made to another person, it having been held that the second confession is likely to be induced by the promise held out by the person to whom the first confession was made. Any inducement to a person to make a confession must refer to some temporal benefit to be gained from it. In conformity with the principle of English law that a person ought not to be made to incriminate himself, it is usual, when a person in custody wishes to make a statement or confession, to caution him that what he says will be used in evidence against him. Particular facts may have an important bearing on the admissibility or otherwise of a confession—innumerable decisions will be found in Archbold's *Criminal Pleading* (23rd ed.). In divorce law, the confession of a wife charged with adultery is always treated with circumspection and caution, for fear of collusion between the parties to a suit. Where, however, such a confession is clear and distinct, the court will usually receive it as evidence against the wife, but not against a co-respondent. In a case where a wife's confession was obtained by falsely stating to her that the suspected co-respondent had confessed, such confession was held admissible. (T. A. I.)

CONFESSIONAL (Late Lat. *confessionale*, neut. adj. from *confessionalis*, "pertaining to confession," Fr. *confessional*, Ital. *confessionale*), a box, cabinet or stall, in which the priest in Roman Catholic churches sits to hear the confessions of penitents. The confessional is usually a wooden structure, with a centre compartment—entered through a door or curtain—in which the priest sits, and on each side a latticed opening for the penitents to speak through, and a step on which they kneel. By this arrangement the priest is hidden, but the penitent is visible to the public. Confessionals sometimes form part of the architectural scheme of the church; many finely decorated specimens, dating from the late 16th and the 17th centuries, are to be found in churches on the continent of Europe. A notable example, in Renaissance style, is in the church of St

Michel at Louvain. But, more usually, confessionals are movable pieces of furniture.

The confessional in its modern form dates no farther back than the 16th century, and Du Cange cites the year 1563 for an early use of the word *confessionale* for the *sacrum poenitentiae tribunal*. Originally the term was applied to the place where a martyr or "confessor" (in the sense of one who confesses Christ) had been buried. There are, however, instances (e.g. the confessional of St Trophimus at Arles) where the name was attached to the spot, whether cell or seat, where noted saints were wont to hear confessions. In the popular Protestant view confessional boxes are associated with the scandals, real or supposed, of the practice of auricular confession. They were, however, devised to guard against such scandals by securing at once essential publicity and a reasonable privacy, and by separating priest and penitent. In the middle ages stringent rules were laid down, in this latter respect, by the canon law in the case of confessions by women and especially nuns.

In England, before the Reformation, publicity was reckoned the best safeguard. Thus Archbishop Walter Reynolds, in 1322, says in his Constitutions. "Let the priest choose for himself a common place for hearing confessions, where he may be seen generally by all in the church; and do not let him hear any one, and especially any woman, in a private place, except in great necessity." It would seem that the priest usually heard confessions at the chancel opening or at a bench end in the nave near the chancel. There is, however, in some churchwardens' accounts mention of a special seat: "the shriving stool," "shriving pew" or "shriving place" (Gasquet, *Parish Life in Mediaeval England*, p. 199). At Lenham in Kent there is an ancient armchair in stone, with a stone bench and steps on one side, which appears to be a confessional.

With the revival of the practice of auricular confession in the English Church, confessionals were introduced into some of the more "extreme" Anglican churches. Since, however, they certainly formed no part of "the furniture of the church" in the "second year of King Edward VI." they can hardly be considered as covered by the "Ornaments Rubric" in the Prayer-Book. The question of their legality was raised in 1900 in the case of *Davey v. Hinde* (vicar of the church of the Annunciation at Brighton) tried before Dr Tristram in the consistory court of Chichester. They were condemned "on the ground that they are not articles of church furniture requisite for or conducive to conformity with the doctrine or practice of the Church of England in relation to the reception of confession" (C. Y. Sturge, *Points of Church Law*, London, 1907, p. 137).

"Confessional," in the sense of a due payable for the right to hear confession, is now obsolete. As an adjective confessional is used in two senses: (1) of the nature of, or belonging to confession, e.g. "confessional prayers"; (2) connected with confessions of faith, or creeds, e.g. "confessional differences." (W. A. P.)

CONFESSION AND AVOIDANCE, in pleading, the plea admitting that facts alleged in a declaration are true, but showing new facts by which it is hoped to destroy the effect of the allegations admitted. A plea in confession and avoidance neither simply admits nor merely denies; it admits that the facts alleged by the opposite party make out a good prima facie case or defence, but it proceeds to destroy the effect of these allegations either by showing some justification or excuse of the matter charged, or some discharge or release from it. All matter in confession and avoidance must be stated clearly and distinctly, and must be specific. If intended to apply to part only of a statement of claim, it must be so stated.

CONFESSOR, in the Christian Church, a word used in the two senses of (1) a person the holy character of whose life and death entitle him or her, in the judgment of the Church, to a peculiar reputation for sanctity, (2) a priest empowered to hear confessions.

(1) In the first sense the word confessor was in the early Church sometimes applied loosely to all martyrs, but more properly to those who, having suffered persecution and torture

for the faith, were afterwards allowed to die in peace. The present sense of the word, as defined above, developed after the ages of persecution had passed. It came to be applied by custom, as did the predicate "Saint," to the holy men of the past; e.g. Ecgerht, archbishop of York (*Excerpt. cap. xxviii*), speaks of "the holy fathers whom we have styled confessors, i.e. bishops and priests who have served God in chastity." But, as in the case of "saint," the right of declaring the holy dead to be "confessors" was ultimately reserved to the Holy See. The most celebrated instance of the formal bestowal of the style is that of King Edward of England, who was made a "Confessor" on his canonization by Pope Alexander III. in 1161, and has since been commonly known as Edward the Confessor.

(2) The confessor in the second sense is now termed in ecclesiastical Latin *confessarius* (med. Lat. *confessare*, to confess), to distinguish him from the "confessor" described above. The functions of the confessor are dealt with in the article CONFESSION (*q.v.*). Here it need only be pointed out that though, in the Roman Catholic Church, the *potestas ordinis* of every priest includes the power of granting absolution, according to the established discipline of the Church, no priest can be a confessor, i.e. hear confessions, without a special faculty from his bishop.

CONFIRMATION (Lat. *confirmatio*, from *confirmare*, to establish, make firm), in the Christian sense, the initiatory rite of laying on of hands, supplementary to and completing baptism, and especially connected with the gift of the Holy Ghost to the candidate. The words "confirm" and "confirmation" are not used in the Bible in this technical sense, which has only grown up since the 5th century, and only in the Western churches of Christendom and in their offshoots, but the rite itself has been practised in the Church from the beginning. The history of confirmation has passed through three stages. In the first ages of the Church, when it was recruited chiefly by converts who were admitted in full age, confirmation, or the laying on of hands (Heb. vi. 2), followed close upon baptism, and in the majority of cases the two were combined in a single service. But only the highest order of ministers could confirm (see Acts viii. 14-17); whereas priests and deacons, and in an emergency laymen and even women, could baptize. There was therefore no absolute certainty that a believer who had been baptized had also received confirmation (Acts xix. 2). But two circumstances tended to prevent the occurrence of such irregularities. In the first place, there were in early days far more bishops in proportion to the number of believers than is the custom now; and, secondly, it was the rule (except in cases of emergency) to baptize only in the season from Easter to Pentecost, and the bishop was always present and laid his hands on the newly baptized. Moreover, in the third and fourth centuries the infants of Christian parents were frequently left unbaptized for years, e.g. Augustine of Hippo. Later, when the Church had come to be tolerated and patronized by the state, her numbers increased, the rule that fixed certain days for baptism broke down, and it was impossible for bishops to attend every baptismal service. Thereupon East and West adopted different methods of meeting the difficulty. In the East greater emphasis was laid on the anointing with oil, which had long been an adjunct of the laying on of hands: the oil was consecrated by the bishop, and the child anointed or "sealed" with it by the parish priest, and this was reckoned as its confirmation. With its baptism thus completed, the infant was held to be capable of receiving holy communion. And to this day in the Eastern Church the infant is baptized, anointed and communicated by the parish priest in the course of a single service; and thus the bishop and the laying on of hands have disappeared from the ordinary service of confirmation. The West, on the other hand, deferred confirmation, not at first till the child had reached years of discretion, though that afterwards became the theory, but from the necessities of the case. The child was baptized at once, that it might be admitted to the Church, while the completion of its baptism was put off till it could be brought to a bishop. Western canons insist on both points at once; baptism is not to be deferred beyond a week,

nor confirmation beyond seven years. And to give an historical example, Henry VIII. had his daughter, afterwards Queen Elizabeth, both baptized and confirmed when she was only a few days old. And still the rubrics of the English Prayer-Book direct that the person who is baptized as an adult is to "be confirmed by the bishop so soon after his baptism as conveniently may be."

But theologians in the West had elaborated a theory of the grace of confirmation, which made its severance from baptism seem natural; and at the time of the Reformation, while neither side favoured the Eastern practice, the reformers, with their strong sense of the crucial importance of faith, emphasized the action of the individual in the service, and therefore laid it down as a rule that confirmation should be deferred till the child could learn a catechism on the fundamentals of the Christian faith, which Calvin thought he might do by the time he was ten. Many of the Protestant bodies have abandoned the rite, but it remains among the Lutherans (who, whether episcopal or not, attach great importance to it) and in the group of Churches in communion with the Church of England. In the Catholic Apostolic Church ("Irvingites") confirmation is called "sealing," and is administered by the "angels." Among the Roman Catholics it is reckoned one of the seven sacraments, and administered at about the age of eight: in many cases less emphasis is laid on the confirmation than on the first communion, which follows it.

At the last revision of the Book of Common Prayer an addition was made to the service by prefixing to it a solemn renewal of their baptismal vows by the candidates; and, in the teeth of history and the wording of the service, this has often been taken to be the essential feature of confirmation. Practically, the preparation of candidates for confirmation is the most important and exacting duty of the Anglican parish priest, as the administration of the rite is the most arduous of a bishop's tasks; and after a long period of slovenly neglect these duties are now generally discharged with great care: classes are formed and instruction is given for several weeks before the coming of the bishop to lay on hands "after the example of the Holy Apostles" (prayer in the Confirmation Service). Of late years there has been a controversy among Anglican theologians as to the exact nature of the gift conveyed through confirmation, or, in other words, whether the Holy Spirit can be said to have come to dwell in those who have been baptized but not confirmed. The view that identifies confirmation rather than baptism with the Pentecostal outpouring of the Spirit on the Church has had to contend against a long-established tradition, but appeals to Scripture (Acts viii. 16) and to patristic teaching.

AUTHORITIES.—Hooker, *Ecclesiastical Polity*, book v. ch. lxxvi; Jeremy Taylor, *A Discourse of Confirmation*; A. J. Mason, *The Relation of Confirmation to Baptism* (London, 1891), where see list of other writers; L. Duchesne, *Origines du culte chrétien*, chap. ix. (Paris, 1898). (W. O. B.)

CONFIRMATION OF BISHOPS. In canon law confirmation is the act by which the election of a new bishop receives the assent of the proper ecclesiastical authority. In the early centuries of the history of the Church the election or appointment of a suffragan bishop was confirmed and approved by the metropolitan and his suffragans assembled in synod. By the 4th canon of the first council of Nicaea (A.D. 325), however, it was decreed that the right of confirmation should belong to the metropolitan bishop of each province, a rule confirmed by the 12th canon of the council of Laodicea. For the appointment of a metropolitan no papal confirmation was required either in the West or East; but the practice which grew up, from the 6th century onwards, of the popes presenting the pallium (*q.v.*), at first *honoris causa*, to newly appointed metropolitans gradually came to symbolize the licence to exercise metropolitan jurisdiction. By the 8th and 9th centuries the papal right of confirmation by this means was strenuously asserted; yet as late as the 13th century there were instances of metropolitans exercising their functions without receiving the pallium, and it was not till after this date that the present rule and practice of the Roman

Catholic Church was definitively established (see Hinschius, *Kirchenrecht*, ii. p. 28 and notes). The canonical right of the metropolitan to confirm the election of his suffragans was still affirmed by Gratian; but from the time of Pope Alexander III. (1159–1181) the canon lawyers, under the influence of the False Decretals, began to claim this right for the pope (Febronius, *De statu ecclesiae*, 2nd ed., 1765, cap. iv. § 3, 2). From the 13th century onwards it was effectively exercised, though the all but universal practice of the popes of reserving and providing to vacant bishoprics, initiated by Clement V., obscured the issue, since in the case of papal nominations no confirmation was required. The question, however, was raised, in connexion with that of the papal reservations and provisions, at the councils of Constance and Basel. The former shelved it in the interests of peace; but the latter once more formulated the principle that elections in the churches were to be free and their result confirmed according to the provisions of the common law (*juxta juris communis dispositionem*), i.e. by "the immediate superior" to whom the right of confirmation belonged (Febronius, *op. cit.* Appendix, p. 784).

In England, where the abuse of provisors had been most acutely felt, the matter was dealt with during the vacancy of the Holy See between the deposition of John XXIII. at Constance (May 1415) and the election of Martin V. (November 1417). During the interval the only possible way of appointing a bishop was by the ancient method of canonical election and confirmation. Shortly after the deposition of John XXIII., Henry V. assented to an ordinance that during the voidance of the Holy See bishops-elect should be confirmed by their metropolitans (*Rotuli Parliamentorum*, iv. p. 71); but the ordinance was not recorded on the Statute Roll. Three bishops only, namely, John Chaundeler of Salisbury, Edmund de Lacey of Hereford and John Wakering of Norwich, were confirmed by the archbishop of Canterbury during the papal vacancy. When Martin V. was elected pope in 1417 he resumed the practice of providing bishops, and from this time until the Reformation the canonical election and confirmation of a bishop in England was a rare exception.

In Roman Catholic countries the complete control of the papacy over the election and appointment of bishops has since the Reformation become firmly established, in spite of the efforts of Gallicans and "Febronians" to reassert what they held to be the more Catholic usage (see GALLICANISM; FEBRONIANISM; BISHOP).

In England at the Reformation the share of the papacy in appointing bishops was abolished, but the confirmation became almost formal in character. By 25 Hen. VIII. c. 20, s. 4, it is provided that after an episcopal election a royal mandate shall issue to the archbishop of the province "requiring him to confirm the said election," or, in case of an archbishop-elect, to one archbishop and two bishops, or to four bishops, "requiring and commanding" them "with all speed and celerity to confirm" it. This practice still prevails in the case of dioceses which have chapters to elect. The confirmation has usually been performed by the archbishop's vicar-general, and, in the southern province, at the church of St Mary-le-Bow, London; but since 1901 it has been performed, in part, at the Church House, Westminster, in consequence of the disorder in the proceedings at Bow church on the confirmation there of Dr Winnington Ingram as bishop of London. All objectors are cited to appear on pain of contumacy after the old form; but although the knowledge that opposition might be offered has been a safeguard against improper nominations, e.g. in the case of Dr Clarke the Arian, confirmation has never been refused since the Reformation. In 1628 Dr Rives, acting for the vicar-general, declined to receive objections made to Richard Montague's election to the see of Chichester on the ground that they were not made in legal form. An informal protest against the confirmation of Dr Prince Lee of Manchester in 1848 was almost immediately followed by another in due form against that of Dr Hampden, elect of Hereford. The vicar-general refused to receive the objections, and an application to the queen's bench for a *mandamus* was unsuccessful, the judges being divided, two against two. In 1869, at the

confirmation of Dr Temple's election as bishop of Exeter, the vicar-general heard counsel on the question whether he could receive objections, and decided that he could not. When the same prelate was elected to Canterbury, the course here laid down was followed, as also at the confirmation of Dr Mandell Creighton's election to the see of London. Objections were again raised, in 1902, against Dr Charles Gore, elect of Worcester; and an application was made to the king's bench for a *mandamus* against the archbishop and his vicar-general when the latter declined to entertain them. By a unanimous judgment (February 10) the court, consisting of the lord chief justice (Lord Alverstone) and Justices Wright and Ridley, refused the *mandamus*. Without deciding that objections (e.g. to the identity of the elect, or the genuineness of documents) could never be investigated by the vicar-general or the archbishop, it held that they could not even entertain objections of the kind alleged. At the confirmation of Dr Cosmo Gordon Lang's election as archbishop of York, held in the Church House on the 20th of January 1909, objections were raised on behalf of the Protestant Truth Society to the confirmation, on the ground that the archbishop-elect had, while bishop suffragan of Stepney, connived at and encouraged flagrant breaches of the law as to church ritual, taken part in illegal ceremonies, and the like. The objectors were heard by the archbishop of Canterbury and the other commissioners in chambers, the decision being that, in accordance with the judgment of the court of king's bench above cited, the objections could not lawfully be received since they did not fall within the province of the commissioners. The archbishop also pointed out that the form of citation (to objectors) had been modified since 1902, but suggested that it was "a matter for consideration whether the terminology of the citation could be altered so as to bring everything into complete accordance with the law of the Church and realm" (see *The Times*, January 21, 1909). Formerly the archbishop had the right of *option*, i.e. of choosing any one piece of preferment in the gift of a bishop confirmed by him, and bestowing it upon whom he would, but this has been held to be abolished by a clause in the Cathedral Act of 1840 (3 & 4 Vict. c. 113, s. 42). And the election of a dean by a cathedral chapter used to receive the bishop's confirmation (Oughton, *Ordo Judiciorum*, No. cxxvii.).

AUTHORITIES.—L. Thomassin, *Vetus et nova disciplina*, pars. ii. lib. ii. tit. 1-4 (1705-1706); E. Gibson, *Codex juris ecclesiastici anglicani*, tit. v. cap. i. (1761); W. H. Bliss, *Calendar of Entries in the Papal Registers relating to Great Britain and Ireland*, vols. i.-vii. (London, 1893-1906); John Le Neve, *Fasti Ecclesie Anglicanae* (Oxford, 1854); R. Jebb, *Report of the Hampden Case* (London, 1849); Sir R. J. Phillimore, *Ecclesiastical Law*, pp. 36-47 (London, 1895); art. "The Confirmation of Archbishops and Bishops" in the *Guardian* for January 20, 1897, pp. 106-107; "Judgment in the Gore Case," in the *Guardian* for February 12, 1902, pp. 234 ff.

CONFISCATION (from Lat. *confiscare*, to consign to the *fiscus*, or imperial treasury), in Roman law the seizure and transfer of private property to the *fiscus* by the emperor; hence the appropriation, under legal authority, of private property to the state; in English law the term embraces forfeiture (*q.v.*) in the case of goods, and escheat (*q.v.*) in the case of lands, for crime or in default of heirs (see also **EMINENT DOMAIN**). Goods may also be confiscated by the state for breaches of statutes relating to customs, excise or explosives. In the United States among the "war measures" during the Civil War, acts were passed in 1861 and 1862 confiscating, respectively, property used for "insurrectionary purposes" and the property generally of those engaged in rebellion. The word is used, popularly, of spoliation under legal forms, or of any seizure of property without adequate compensation.

CONFOLENS, a town of south-western France, capital of an arrondissement in the department of Charente, 44 m. N.E. of Angoulême by rail. Pop. (1906) 2546. Confolens is situated on the banks of the Vienne at its confluence with the Goire. It is an ancient town, with steep narrow streets bordered by old houses. It possesses two bridges of the 15th century, remains of a castle of the 12th century, and two churches, one of the 11th, another of the 14th and 15th centuries. The subprefecture,

a tribunal of first instance, and a communal college are among the public institutions. Flour, leather, laces and paper are its industrial products, and there is trade in timber and cattle.

CONFUCIUS [*K'ung tse*] (550 or 551-478 B.C.), the famous sage of China. In order to understand the events of his life and the influence of his opinions, we must endeavour to get some impression of the China that existed in his time, in the 5th and 6th centuries B.C. The dynasty of Chow, the third which within historic time had ruled the country, lasting from 1122 to 256 B.C., had passed its zenith, and its kings no longer held the sceptre with a firm grasp. The territory under their sway was not a sixth part of the present empire. For thirteen years of his life Confucius wandered about from state to state, seeking rest and patrons; but his journeyings were confined within the modern provinces of Ho-nan and Shantung, and the borders of Chih-li and Hu-pch.

Within the China of the Chow dynasty there might be a population, in Confucius's time, of from 10,000,000 to 15,000,000. We read frequently, in the classical books, of the "ten thousand states" in which the people were distributed, but that is merely a grand exaggeration. In what has been called, though erroneously, as we shall see, *Confucius's History of his own Times*, we find only 13 states of note, and the number of all the states, large and small, which can be brought together from it, and the much more extensive supplement to it by Tso K'iu-ming, not much posterior to the sage, is under 150. Chow was a feudal kingdom. The lords of the different territories belonged to five orders of nobility, corresponding closely to the dukes, marquises, earls, counts and barons of feudal Europe. The theory of the constitution required that the princes, on every fresh succession, should receive investiture from the king, and thereafter appear at his court at stated times. They paid to him annually certain specified tributes, and might be called out with their military levies at any time in his service. A feudal kingdom was sure to be a prey to disorder unless there were energy and ability in the character and administration of the sovereign; and Confucius has sketched, in the work referred to above, the *Annals of Lu*, his native state, for 242 years, from 722 to 481 B.C., which might almost be summed up in the words: "In those days there was no king in China, and every prince did what was right in his own eyes." In 1770 B.C. a northern horde had plundered the capital, which was then in the present department of Si-gan, Shen-si, and killed the king, whose son withdrew across the Ho and established himself in a new centre, near the present city of Lo-yang in Ho-nan; but from that time the prestige of Chow was gone. Its representatives continued for four centuries and a half with the title of king, but they were less powerful than several of their feudatories. The *Annals of Lu*, enlarged by Tso K'iu-ming so as to embrace the history of the kingdom generally, are as full of life and interest as the pages of Froissart. Feats of arms, great battles, heroic virtues, devoted friendships and atrocious crimes make the chronicles of China in the 5th, 6th and 7th centuries before the birth of Christ as attractive as those of France and England in the 14th and some other centuries after it. There was in China in the former period more of literary culture and of many arts of civilization than there was in Europe in the latter. Not only the royal court, but every feudal court had its historiographers and musicians. Institutions of an educational character abounded. There were ancient histories and poems, and codes of laws, and books of ceremonies. Yet the period was one of widespread suffering and degeneracy. While the general government was feeble, disorganization was at work in each particular state.

Three things must be kept in mind when we compare feudal China with feudal Europe. First, we must take into account the long duration of the time through which the central authority was devoid of vigour. For about five centuries state was left to contend with state, and clan with clan in the several states. The result was chronic misrule, and misery to the masses of the people, with frequent famines. Secondly, we must take into account the institution of polygamy, with the low status assigned to woman and the many restraints put upon her. In the ancient

*Condition
of China
in time of
Confucius.*

poems, indeed, there are a few pieces which are true love songs, and express a high appreciation of the virtue of their subjects; but there are many more which tell a different tale. The intrigues, quarrels, murders and grossnesses that grew out of this social condition it is difficult to conceive, and would be impossible to detail. Thirdly, we must take into account the absence of strong and definite religious beliefs, properly so called, which has always been a characteristic of the Chinese people. We are little troubled, of course, with heresies, and are not shocked by the outbreaks of theological zeal; but where thought as well as action does not reach beyond the limits of earth and time, we do not find man in his best estate. We miss the graces and consolations of faith; we have human efforts and ambitions, but they are unimpregnated with divine impulses and heavenly aspirations.

Confucius appeared, according to Mencius, one of his most distinguished followers (371-288 B.C.), at a crisis in the nation's history. "The world," he says, "had fallen into decay, and right principles had disappeared. Perverse discourses and oppressive deeds were waxen rife. Ministers murdered their rulers and sons their fathers. Confucius was frightened by what he saw,—and he undertook the work of reformation." The sage was born, according to the historian Sze-ma Ch'ien, in the year 550 B.C.; according to Kung-yang and Kuh-liang, two earlier commentators on his *Annals of Lu*, in 551; but all three agree in the month and day assigned to his birth, which took place in winter. His clan name was K'ung, and Confucius is merely the latinized form of K'ung Fu-tze, meaning "the philosopher or master K'ung." He was a native of the state of Lu, a part of the modern Shan-tung, embracing the present department of Yen-chow and other portions of the province. Lu had a great name among the other states of Chow, its marquises being descended from the duke of Chow, the legislator and consolidator of the dynasty which had been founded by his father and brother, the famous kings Wän and Wu. Confucius's own ancestry is traced up, through the sovereigns of the previous dynasty of Shang, to Hwang-ti, whose figure looms out through the mists of fable in prehistoric times. A scion of the house of Shang, the surname of which was Tze, was invested by King Wu-Wang with the dukedom of Sung in the present province of Ho-nan. There, in the Tze line, towards the end of the 8th century B.C., we find a K'ung Kia, whose posterity, according to the rules for the dropping of surnames, became the K'ung clan. He was a high officer of loyalty and probity, and unfortunately for himself had a wife of extraordinary beauty. Hwa Tuh, another high officer of the duchy, that he might get this lady into his possession, brought about the death of K'ung Kia, and was carrying his prize in a carriage to his own palace, when she strangled herself on the way. The K'ung family, however, became reduced, and by-and-by its chief representative moved from Sung to Lu, where in the early part of the 6th century we meet with Shuh-liang Heih, the father of Confucius, as commandant of the district of Tsow, and an officer renowned for his feats of strength and daring.

There was thus no grander lineage in China than that of Confucius; and on all his progenitors, since the throne of Shang passed from their line, with perhaps one exception, he could look back with complacency. He was the son of Heih's old age. That officer, when over seventy years, and having already nine daughters and one son, because that son was a cripple, sought an alliance with a gentleman of the Yen clan, who had three daughters. The father submitted to them Heih's application, saying that, though he was old and austere, he was of most illustrious descent, and they need have no misgivings about him. Ching-tsai, the youngest of the three, observed that it was for their father to decide in the case. "You shall marry him then," said the father, and accordingly she became the bride of the old man, and in the next year the mother of the sage. It is one of the undesigned coincidences which confirm the credibility of Confucius's history, that his favourite disciple was a scion of the Yen clan.

Heih died in the child's third year, leaving his family in

strained circumstances. Long afterwards, when Confucius was complimented on his acquaintance with many arts, he accounted for it on the ground of the poverty of his youth, which obliged him to acquire a knowledge of matters belonging to a mean condition. When he was five or six, people took notice of his fondness for playing with his companions at setting out sacrifices, and at postures of ceremony. He tells us himself that at fifteen his mind was set on learning; and at nineteen, according to the ancient and modern practice in China in regard to early unions, he was married,—his wife being from his ancestral state of Sung. A son, the only one, so far as we know, that he ever had, was born in the following year; but he had subsequently two daughters. Immediately after his marriage we find him employed under the chief of the Ki clan to whose jurisdiction the district of Tsow belonged, first as keeper of stores, and then as superintendent of parks and herds. Mencius says that he undertook such mean offices because of his poverty, and distinguished himself by the efficiency with which he discharged them, without any attempt to become rich.

In his twenty-second year Confucius commenced his labours as a teacher. He did so at first, probably, in a humble way; but a school, not of boys to be taught the elements of learning, but of young and inquiring spirits who wished to be instructed in the principles of right conduct and government, gradually gathered round him. He accepted the substantial aid of his disciples; but he rejected none who could give him even the smallest fee, and he would retain none who did not show earnestness and capacity. "When I have presented," he said, "one corner of a subject, and the pupil cannot of himself make out the other three, I do not repeat my lesson."

Two years after, his mother died, and he buried her in the same grave with his father. Some idea of what his future life was likely to be was already present to his mind. It was not the custom of antiquity to raise any tumulus over graves, but Confucius resolved to innovate in the matter. He would be travelling, he said, to all quarters of the kingdom, and must therefore have a mound by which to recognize his parents' resting-place. He returned home from the interment alone, having left his disciples to complete this work. They were long in rejoicing him, and had then to tell him that they had been detained by a heavy fall of rain, which threw down the first product of their labour. He burst into tears, and exclaimed, "Ah! they did not raise mounds over their graves in antiquity." His affection for the memory of his mother and dissatisfaction with his own innovation on ancient customs thus blended together; and we can sympathize with his tears. For the regular period of 27 months, commonly spoken of as three years, he observed all the rules of mourning. When they were over he allowed five more days to elapse before he would take his lute, of which he had been devotedly fond, in his hands. He played, but when he tried to sing to the accompaniment of the instrument, his feelings overcame him.

For some years after this our information about Confucius is scanty. Hints, indeed, occur of his devotion to the study of music and of ancient history; and we can perceive that his character was more and more appreciated by the principal men of Lu. He had passed his thirtieth year when, as he tells us, "he stood firm" in his convictions on all the subjects to the learning of which he had bent his mind fifteen years before. In 517 B.C. two scions of one of the principal houses in Lu joined the company of his disciples in consequence of the dying command of its chief; and being furnished with the means by the marquis of the state, he made a visit with them to the capital of the kingdom. There he examined the treasures of the royal library, and studied the music which was found in its highest style at the court. There, too, according to Sze-ma Ch'ien, he had several interviews with Lao-tsze, the father of Taoism. It is characteristic of the two men that the latter, a transcendental dreamer, appears to have thought little of his visitor, while Confucius, an inquiring thinker, was profoundly impressed with him.

On his return to Lu, in the same year, that state fell into great

disorder. The marquis was worsted in a struggle with his ministers, and fled to the neighbouring state of Ts'i. Thither also went Confucius, for he would not countenance by his presence the men who had driven their ruler away. He was accompanied by many of his disciples; and as they passed by the T'ai Mountain, an incident occurred which may be narrated as a specimen of the way in which he communicated to them his lessons. The attention of the travellers was arrested by a woman weeping and wailing at a grave. The sage stopped, and sent one of his followers to ask the reason of her grief. "My husband's father," said she, "was killed here by a tiger, and my husband also, and now my son has met the same fate." Being asked why she did not leave so fatal a spot, she replied that there was there no oppressive government. "Remember this," said Confucius to his disciples, "remember this, my children, oppressive government is fiercer and more feared than a tiger."

He did not find in Ts'i a home to his liking. The marquis of the state was puzzled how to treat him. The teacher was not a man of rank, and yet the prince felt that he ought to give him more honour than rank could claim. Some counsellors of the court spoke of him as "impracticable and conceited, with a thousand peculiarities." It was proposed to assign to him a considerable revenue, but he would not accept it while his counsels were not followed. Dissatisfactions ensued, and he went back to Lu.

There for fifteen more years he continued in private life, prosecuting his studies, and receiving many accessions to his disciples. He had a difficult part to play with the different parties in the state, but he adroitly kept himself aloof from them all; and at last, in his fifty-second year, he was made chief magistrate of the city of Chung-tu. A marvellous reformation, we are told, forthwith ensued in the manners of the people; and the marquis, a younger brother of the one that fled to Ts'i and died there, called him to higher office. He was finally appointed minister of crime,—and there was an end of crime. Two of his disciples at the same time obtained influential positions in the two most powerful clans of the state, and co-operated with him. He signalized his vigour by the punishment of a great officer and in negotiations with the state of Ts'i. He laboured to restore to the marquis his proper authority, and as an important step to that end, to dismantle the fortified cities where the great chiefs of clans maintained themselves like the barons of feudal Europe. For a couple of years he seemed to be master of the situation. "He strengthened the ruler," it is said, "and repressed the barons. A transforming government went abroad. Dishonesty and dissoluteness hid their heads. Loyalty and good faith became the characteristics of the men, and chastity and docility those of the women. He was the idol of the people, and flew in songs through their mouths."

The sky of bright promise was soon overcast. The marquis of Ts'i and his advisers saw that if Confucius were allowed to prosecute his course, the influence of Lu would become supreme throughout the kingdom, and Ts'i would be the first to suffer. A large company of beautiful women, trained in music and dancing, and a troop of fine horses, were sent to Lu. The bait took; the women were welcomed, and the sage was neglected. The marquis forgot the lessons of the master, and yielded supinely to the fascinations of the harem. Confucius felt that he must leave the state. The neglect of the marquis to send round, according to rule, among the ministers portions of the flesh after a great sacrifice, furnished a plausible reason for leaving the court. He withdrew, though very unwillingly and slowly, hoping that a change would come over the marquis and his counsellors, and a message of recall be sent to him. But no such message came; and he went forth in his fifty-sixth year to a weary period of wandering among various states.

A disciple once asked Confucius what he would consider the first thing to be done, if intrusted with the government of a state. His reply was, "The rectification of names." When told that such a thing was wide of the mark, he held to it, and indeed his whole social and political system was wrapped up in the saying. He had told the marquis of Ts'i that good govern-

ment obtained when the ruler was ruler, and the minister minister; when the father was father, and the son son. Society, he considered, was an ordinance of heaven, and was made up of five relationships—ruler and subject, husband and wife, father and son, elder brothers and younger, and friends. There was rule on the one side of the first four, and submission on the other. The rule should be in righteousness and benevolence; the submission in righteousness and sincerity. Between friends the mutual promotion of virtue should be the guiding principle. It was true that the duties of the several relations were being continually violated by the passions of men, and the social state had become an anarchy. But Confucius had confidence in the preponderating goodness of human nature, and in the power of example in superiors. "Not more surely," he said, "does the grass bend before the wind than the masses yield to the will of those above them." Given the model ruler, and the model people would forthwith appear. And he himself could make the model ruler. He could tell the princes of the states what they ought to be; and he could point them to examples of perfect virtue in former times,—to the sage founders of their own dynasty; to the sage T'ang, who had founded the previous dynasty of Shang; to the sage Yu, who first established a hereditary kingdom in China; and to the greater sages still who lived in a more distant golden age. With his own lessons and those patterns, any ruler of his day, *who would listen to him*, might reform and renovate his own state, and his influence would break forth beyond its limits till the face of the whole kingdom should be filled with a multitudinous relation-keeping, well-fed, happy people. "If any ruler," he once said, "would submit to me as his director for twelve months, I should accomplish something considerable, and in three years I should attain the realization of my hopes." Such were the ideas, the dreams of Confucius. But he had not been able to get the ruler of his native state to listen to him. His sage counsels had melted away before the glance of beauty and the pomps of life.

His professed disciples amounted to 3000, and among them were between 70 and 80 whom he described as "scholars of extraordinary ability." The most attached of them were seldom long away from him. They stood or sat reverently by his side, watched the minutest particulars of his conduct, studied under his direction the ancient history, poetry and rites of their country, and treasured up every syllable which dropped from his lips. They have told us how he never shot at a bird perching nor fished with a net, the creatures not having in such a case a fair chance for their lives; how he conducted himself in court and among villagers; how he ate his food, and lay in his bed, and sat in his carriage; how he rose up before the old man and the mourner; how he changed countenance when it thundered, and when he saw a grand display of viands at a feast. He was free and unreserved in his intercourse with them, and was hurt once when they seemed to think that he kept back some of his doctrines from them. Several of them were men of mark among the statesmen of the time, and it is the highest testimony to the character of Confucius that he inspired them with feelings of admiration and reverence. It was they who set the example of speaking of him as the greatest of mortal men; it was they who struck the first notes of that paean which has gone on resounding to the present day.

Confucius was in his fifty-sixth year when he left Lu; and thirteen years elapsed ere he returned to it. In this period were comprised his travels among the different states, when he hoped, and ever hoped in vain, to meet with some prince who would accept him as his counsellor, and initiate a government that should become the centre of a universal reformation. Several of the princes were willing to entertain and support him; but for all that he could say, they would not change their ways.

His first refuge was in Wei, a part of the present Ho-nan, the marquis of which received him kindly; but he was a weak man, ruled by his wife, a woman notorious for her accomplishments and wickedness. In attempting to pass from Wei to another state, Confucius was set upon by a mob, which mistook

His ideas of government.

His disciples.

him for an officer who had made himself hated by his oppressive deeds. He himself was perfectly calm amid the danger, though his followers were filled with alarm. They were obliged, however, to retrace their way to Wei, and he had there to appear before the marchioness, who wished to see how a sage looked. There was a screen between them at the interview, such as the present regent-empresses of China use in giving audience to their ministers; but Tze-lu, one of his principal disciples, was indignant that the master should have demeaned himself to be near such a woman, and to pacify him Confucius swore an oath appealing to Heaven to reject him if he had acted improperly. Soon afterwards he left the state.

Twice again, during his protracted wanderings, he was placed in imminent peril, but he manifested the same fearlessness, and expressed his confidence in the protection of Heaven till his course should be run. On one of the occasions he and his company were in danger of perishing from want, and the courage of even Tze-lu gave way. "Has the superior man, indeed, to endure in this way?" he asked. "The superior man may have to endure want," was the reply, "but he is still the superior man. The small man in the same circumstances loses his self-command."

While travelling about, Confucius repeatedly came across recluses,—a class of men who had retired from the world in disgust. That there was such a class gives us a striking glimpse into the character of the age. Scholarly, and of good principles, they had given up the conflict with the vices and disorder that prevailed. But they did not understand the sage, and felt a contempt for him struggling on against the tide, and always hoping against hope. We get a fine idea of him from his encounters with them. Once he was looking about for a ford, and sent Tze-lu to ask a man who was at work in a neighbouring field where it was. The man was a recluse, and having found that his questioner was a disciple of Confucius, he said to him: "Disorder in a swelling flood spreads over the kingdom, and no one is able to repress it. Than follow a master who withdraws from one ruler and another that will not take his advice, had you not better follow those who withdraw from the world altogether?" With these words he resumed his hoe, and would give no information about the ford. Tze-lu went back, and reported what the man had said to the master, who observed: "It is impossible to withdraw from the world, and associate with birds and beasts that have no affinity with us. With whom should I associate but with suffering men? The disorder that prevails is what requires my efforts. If right principles ruled through the kingdom, there would be no necessity for me to change its state." We must recognize in those words a brave heart and a noble sympathy. Confucius would not abandon the cause of the people. He would hold on his way to the end. Defeated he might be, but he would be true to his humane and righteous mission.

It was in his sixty-ninth year, 483 B.C., that Confucius returned to Lu. One of his disciples, who had remained in the state, had been successful in the command of a military expedition, and told the prime minister that he had learned his skill in war from the master,—urging his recall, and that thereafter mean persons should not be allowed to come between the ruler and him. The state was now in the hands of the son of the marquis whose neglect had driven the sage away; but Confucius would not again take office. Only a few years remained to him, and he devoted them to the completion of his literary tasks, and the delivery of his lessons to his disciples.

The next year was marked by the death of his son, which he bore with equanimity. His wife had died many years before, and it jars upon us to read how he then commanded the young man to hush his lamentations of sorrow. We like him better when he mourned, as has been related, for his own mother. It is not true, however, as has often been said, that he had divorced his wife before her death. The death of his favourite disciple, Yen Hwui, in 481 B.C., was more trying to him. Then he wept and mourned beyond what seemed to his other followers the bounds of propriety, exclaiming that Heaven was destroying

him. His own last year, 478 B.C., dawned on him with the tragic end of his next beloved disciple, Tze-lu. Early one morning, we are told, in the fourth month, he got up, and with his hands behind his back, dragging his staff, he moved about his door, crooning over—

"The great mountain must crumble,
The strong beam must break,
The wise man must wither away like a plant."

Tze-kung heard the words, and hastened to him. The master told him a dream of the previous night, which, he thought, presaged his death. "No intelligent ruler," he said, "arises to take me as his master. My time has come to die." He took to his bed, and after seven days expired. Such is the account we have of the last days of the sage of China. His end was not unimpressive, but it was melancholy. Disappointed hopes made his soul bitter. No wife nor child was by to do the offices of affection, nor was the expectation of another life with him, when he passed away from among men. He uttered no prayer, and he betrayed no apprehension. Years before, when he was very ill, and Tze-lu asked leave to pray for him, he expressed a doubt whether such a thing might be done, and added, "I have prayed for a long time." Deep-treasured now in his heart may have been the thought that he had served his generation by the will of God; but he gave no sign.

When their master thus died, his disciples buried him with great pomp. A multitude of them built huts near his grave, and remained there, mourning as for a father, for nearly three years; and when all the rest were gone, Tze-kung, the last of his favourite three, continued alone by the grave for another period of the same duration. The news of his death went through the states as with an electric thrill. The man who had been neglected when alive seemed to become all at once an object of unbounded admiration. The tide began to flow which has hardly ever ebbed during three-and-twenty centuries.

The grave of Confucius is in a large rectangle separated from the rest of the K'ung cemetery, outside the city of K'iu-h-fow. A magnificent gate gives admission to a fine avenue, lined with cypress trees and conducting to the tomb, a large and lofty mound, with a marble statue in front, bearing the inscription of the title given to Confucius under the Sung dynasty:—"The most sagely ancient Teacher; the all-accomplished, all-informed King." A little in front of the tomb, on the left and right, are smaller mounds over the graves of his son and grandson, from the latter of whom we have the remarkable treatise called *The Doctrine of the Mean*. All over the place are imperial tablets of different dynasties, with glowing tributes to the one man whom China delights to honour; and on the right of the grandson's mound is a small house said to mark the place of the hut where Tze-kung passed his nearly five years of loving vigil. On the mound grow cypresses, acacias, what is called "the crystal tree," said not to be elsewhere found, and the *Achillea*, the plant whose stalks were employed in ancient times for purposes of divination.

The adjoining city is still the home of the K'ung family; and there are said to be in it some 40,000 or 50,000 of the descendants of the sage. The chief of the family has large estates by imperial gift, with the title of "Duke by imperial appointment and hereditary right, continuator of the sage."

The dynasty of Chow finally perished two centuries and a quarter after the death of the sage at the hands of the first historic emperor of the nation,—the first of the dynasty of Ts'in, who swept away the foundations of the feudal system. State after state went down before his blows, but the name and followers of Confucius were the chief obstacles in his way. He made an effort to destroy the memory of the sage from off the earth, consigning to the flames all the ancient books from which he drew his rules and examples (save one), and burying alive hundreds of scholars who were ready to swear by his name. But Confucius could not be so extinguished. The tyranny of Ts'in was of short duration, and the next dynasty, that of Han, while entering into the new China, found its surest strength in doing honour to his name, and trying to gather up the wreck of the ancient books. It is

His
wander-
ings.

His death.

Influence
on China.

difficult to determine what there was about Confucius to secure for him the influence which he has wielded. Reference has been made to his literary tasks; but the study of them only renders the undertaking more difficult. He left no writings in which he detailed the principles of his moral and social system. *The Doctrine of the Mean*, by his grandson Tze-sze, and *The Great Learning*, by Tsang Sin, the most profound, perhaps, of his disciples, give us the fullest information on that subject, and contain many of his sayings. The *Lun-Yii*, or Analects, "Discourses and Dialogues," is a compilation in which many of his disciples must have taken part, and has great value as a record of his ways and utterances; but its chapters are mostly *disjecta membra*, affording faint traces of any guiding method or mind. Mencius, Hsiin K'ing and writers of the Han dynasty, whose works, however, are more or less apocryphal, tell us much about him and his opinions, but all in a loose and unconnected way. No Chinese writer has ever seriously undertaken to compare him with the philosophers and sages of other nations.

The sage, probably, did not think it necessary to put down many of his own thoughts in writing, for he said of himself that he was "a transmitter, and not a maker." Nor did he lay claim to have any divine revelations. He was not born, he declared, with knowledge, but was fond of antiquity, and earnest in seeking knowledge there.

The rule of life for men in all their relations, he held, was to be found within themselves. The right development of that rule, in the ordering not of the individual only, but of society, was to be found in the words and institutions of the ancient sages.

China had a literature before Confucius. All the monuments of it, however, were in danger of perishing through the disorder into which the kingdom had fallen. The feudal system that had subsisted for more than 1500 years had become old. Confucius did not see this, and it was impossible that he should.

China was in his eyes drifting from its ancient moorings, drifting on a sea of storms "to hideous ruin and combustion"; and the expedient that occurred to him to arrest the evil was to gather up and preserve the records of antiquity, illustrating and commending them by his own teachings. For this purpose he lectured to his disciples on the histories, poems and constitutional works of the nation. What he thus did was of inestimable value to his own countrymen, and all other men are indebted to him for what they know of China before his time, though all the contents of the ancient works have not come down to us.

He wrote, we are told, a preface to the *Shu King*, or Book of Historical Documents. The preface is, in fact, only a schedule, without any remark by Confucius himself, giving the names of 100 books, of which it consisted. Of these we now possess 59, the oldest going back to the 23rd century, and the latest dating in the 8th century B.C. The credibility of the earlier portions, and the genuineness of several of the documents, have been questioned, but the collection as a whole is exceedingly valuable.

The *Shih king*, or Ancient Poems, as existing in his time, or compiled by him (as generally stated, contrary to the evidence in the case), consisted of 311 pieces, of which we possess 305. The latest of them dates 585 years B.C., and the oldest of them ascends perhaps twelve centuries higher. It is the most interesting book of ancient poetry in the world, and many of the pieces are really fine ballads. Confucius was wont to say that he who was not acquainted with the *Shih* was not fit to be conversed with, and that the study of it would produce a mind without a single depraved thought. This is nearly all we have from him about the poems.

The *Li ki*, or Books of Rites and Ancient Ceremonies and of Institutions, chiefly of the Chow dynasty, have come down to us in a sadly mutilated condition. They are still more than sufficiently voluminous, but they were edited, when recovered under the Han dynasty, with so many additions, that it is hardly worth while to speak of them in connexion with Confucius; though much of what was added to them is occupied with his history and sayings.

Of all the ancient books not one was more prized by him than the *Yi-king*, or "The Book of Changes," the rudiments

of which are assigned to Fuh-hi about the 30th century B.C. Those rudiments, however, are merely the 8 trigrams and 64 hexagrams, composed of a whole and a broken line (—, — —), without any text or explanation of them earlier than the rise of the Chow dynasty. The leather thongs, by which the tablets of Confucius's copy were tied together, were thrice worn out by his constant handling. He said that if his life were lengthened he would give fifty years to the study of the *Yi*, and might then be without great faults. This has come down to us entire. If not intended from the first for purposes of divination, it was so used both before and after Confucius, and on that account it was exempted, through the superstition of the emperor of the Ts'in dynasty, from the flames. It is supposed to give a theory of the phenomena of the physical universe, and of moral and political principles by the trigrams and the different lines and numbers of the hexagrams of Fuh-hi. Almost every sentence in it is enigmatic. As now published, there are always subjoined to it certain appendixes, which are ascribed to Confucius himself. Pythagoras and he were contemporaries, and in the fragments of the Samian philosopher about the "elements of numbers as the elements of realities" there is a remarkable analogy with much of the *Yi*. No Chinese critic or foreign student of Chinese literature has yet been able to give a satisfactory account of the book.

But a greater and more serious difficulty is presented by his last literary labour, the work claimed by him as his own, and which has already been referred to more than once as the *Annals of Lu*. Its title is the *Ch'un Ch'iu*, or "Spring and Autumn," the events of every year being digested under the heads of the four seasons, two of which are used by synecdoche for the whole. Mencius held that the composition of the *Ch'un Ch'iu* was as great a work as Yu's regulation of the waters of the deluge with which the *Shu King* commences, and did for the face of society what the earlier labour did for the face of nature. This work also has been preserved nearly entire, but it is excessively meagre. The events of 242 years barely furnish an hour or two's reading. Confucius's annals do not bear a greater proportion to the events which they indicate than the headings in our Bibles bear to the contents of the chapters to which they are prefixed. Happily Tso K'iu-ming took it in hand to supply those events, incorporating also others with them, and continuing his narratives over some additional years, so that through him the history of China in all its states, from year to year, for more than two centuries and a half, lies bare before us. Tso never challenges the text of the master as being incorrect, yet he does not warp or modify his own narratives to make them square with it; and the astounding fact is, that when we compare the events with the summary of them, we must pronounce the latter misleading in the extreme. Men are charged with murder who were not guilty of it, and base murders are related as if they had been natural deaths. Villains, over whose fate the reader rejoices, are put down as victims of vile treason, and those who dealt with them as he would have been glad to do are subjected to horrible executions without one word of sympathy. Ignoring, concealing and misrepresenting are the characteristics of the *Spring and Autumn*.

And yet this work is the model for all historical summaries in China. The want of harmony between the facts and the statements about them is patent to all scholars, and it is the knowledge of this, unacknowledged to themselves, which has made the literati labour with an astonishing amount of fruitless ingenuity and learning to find in individual words, and the turn of every sentence, some mysterious indication of praise or blame. But the majority of them will admit no flaw in the sage or in his annals. His example in the book has been very injurious to his country. One almost wishes that critical reasons could be found for denying its authenticity. Confucius said that "by the *Spring and Autumn* men would know him and men would condemn him." It certainly obliges us to make a large deduction from our estimate of his character and of the beneficial influence which he has exerted. The examination of his literary labours does not on the whole increase our appreciation of him. We get a higher idea of the man from the accounts which his disciples have given us

of his intercourse and conversations with them, and the attempts which they made to present his teachings in some systematic form. If he could not arrest the progress of disorder in his country, nor throw out principles which should be helpful in guiding it to a better state under some new constitutional system, he gave important lessons for the formation of individual character, and the manner in which the duties in the relations of society should be discharged.

Foremost among these we must rank his distinct enunciation of "the golden rule," deduced by him from his study of man's mental constitution. Several times he gave that rule in express words:—"What you do not like when done to yourself do not do to others." The peculiar nature of the Chinese language enabled him to express this rule by one character, which for want of a better term we may translate in English by "reciprocity." When the ideagram is looked at, it tells its meaning to the eye. It is composed of two other characters, one denoting "heart," and the other—itself composite—denoting "as." Tze-kung once asked if there were any one word which would serve as a rule of practice for all one's life, and the master replied, yes, naming this character (恕, *shu*), the "as heart," *i.e.* my heart in sympathy with yours; and then he added his usual explanation of it, which has been given above. It has been said that he only gave the rule in a negative form, but he understood it also in its positive and most comprehensive force, and deplored, on one occasion at least, that he had not himself always attained to taking the initiative in doing to others as he would have them do to him.

Another valuable contribution to ethical and social science was the way in which he inculcated the power of example, and the necessity of benevolence and righteousness in all who were in authority. Many years before he was born, an ancient hero and king had proclaimed in China: "The great God has conferred on the people a moral sense, compliance with which would show their nature invariably right. To cause them tranquilly to pursue the course which it indicates is the task of the sovereign." Confucius knew the utterance well; and he carried out the principle of it, and insisted on its application in all the relations of society. He taught emphatically that a bad man was not fit to rule. As a father or a magistrate, he might wield the instruments of authority and punish the transgressors of his laws, but no forthputting of force would countervail the influence of his example. On the other hand, it only needed virtue in the higher position to secure it in the lower. This latter side of his teaching is far from being complete and correct, but the former has, no doubt, been a check on the "powers that be," both in the family and the state, ever since Confucius became the acknowledged sage of his country. It has operated both as a restraint upon evil and a stimulus to good.

A few of his more characteristic sayings may here be given, the pith and point of which attest his discrimination of character, and show the tendencies of his views:—

Wise sayings.

"What the superior man seeks is in himself; what the small man seeks is in others."

"The superior man is dignified, but does not wrangle; social, but not a partisan. He does not promote a man simply because of his words, nor does he put good words aside because of the man."

"A poor man who does not flatter, and a rich man who is not proud, are passable characters; but they are not equal to the poor who yet are cheerful, and the rich who yet love the rules of propriety."

"Learning, undigested by thought, is labour lost; thought unassisted by learning, is perilous."

"In style all that is required is that it convey the meaning."

"Extravagance leads to insubordination, and parsimony to meanness. It is better to be mean than insubordinate."

"A man can enlarge his principles; principles do not enlarge the man." That is, man is greater than any system of thought.

"The cautious seldom err."

Sententious sayings like these have gone far to form the ordinary Chinese character. Hundreds of thousands of the literati can repeat every sentence in the classical books; the masses of the people have scores of the Confucian maxims, and little else of an ethical nature, in their memories,—and with a beneficial result.

Confucius laid no claim, it has been seen, to divine revelations. Twice or thrice he did vaguely intimate that he had a mission from heaven, and that until it was accomplished he was safe against all attempts to injure him; but his teachings were singularly devoid of reference to anything but what was seen and temporal. Man as he is, and the duties belonging to him in society, were all that he concerned himself about. Man's nature was from God; the harmonious acting out of it was obedience to the will of God; and the violation of it was disobedience. But in affirming this, there was a striking difference between his language and that of his own ancient models. In the *King* the references to the Supreme Being are abundant; there is an exulting awful recognition of Him as the almighty personal Ruler, who orders the course of nature and providence. With Confucius the vague, impersonal term, Heaven, took the place of the divine name. There is no glow of piety in any of his sentiments. He thought that it was better that men should not occupy themselves with anything but themselves.

There were, we are told in the *Analects*, four things of which he seldom spoke—extraordinary things, feats of strength, rebellious disorder and spiritual beings. Whatever the institutions of Chow prescribed about the services to be paid to the spirits of the departed, and to other spirits, he performed reverently, up to the letter; but at the same time, when one of the ministers of Lu asked him what constituted wisdom, he replied: "To give one's self earnestly to the duties due to men, and while respecting spiritual beings, to keep aloof from them,—that may be called wisdom."

But what belief underlay the practice, as ancient as the first footprints of history in China, of sacrificing to the spirits of the departed, Confucius would not say. There was no need, in his opinion, to trouble the mind about it. "While you cannot serve men," he replied to the inquiry of Tze-lu, "how can you serve spirits?" And what becomes of a man's own self, when he has passed from the stage of life? The oracle of Confucius was equally dumb on this question. "While you do not know life," he said to the same inquirer, "what can you know about death?" Doubts as to the continued existence of the departed were manifested by many leading men in China before the era of Confucius. In the pages of Tso K'iu-ming, when men are swearing in the heat of passion, they sometimes pause and rest the validity of their oaths on the proviso that the dead to whom they appeal really exist. The "expressive silence" of Confucius has gone to confirm this scepticism.

His teaching was thus hardly more than a pure secularism. He had faith in man, man made for society, but he did not care to follow him out of society, nor to present to him motives of conduct derived from the consideration of a future state. Good and evil would be recompensed by the natural issues of conduct within the sphere of time,—if not in the person of the actor, yet in the persons of his descendants. If there were any joys of heaven to reward virtue, or terrors of future retribution to punish vice, the sage took no heed of the one or the other. Confucius never appeared to give the evils of polygamy a thought. He mourned deeply the death of his mother; but no generous word ever passed his lips about woman as woman. Nor had he the idea of any progress or regeneration of society. The stars all shone to him in the heavens behind; none beckoned brightly before. It was no doubt the moral element of his teaching, springing out of his view of human nature, which attracted many of his disciples, and still holds the best part of the Chinese men of learning bound to him; but the conservative tendency of his lessons—nowhere so apparent as in the *Ch'un Ch'iu*—is the chief reason why successive dynasties have delighted to do him honour. (J. LE.)

CONGÉ D'ÉLIRE (in Norman French, *congé d'estlire*, leave to elect), a licence from the crown in England issued under the great seal to the dean and chapter of the cathedral church of the diocese, authorizing them to elect a bishop or archbishop, as the case may be, upon the vacancy of any episcopal or archiepiscopal see in England or in Wales. According to the *Chronicle*

of Ingulphus, abbot of Crowland, who wrote in the reign of William the Conqueror, the bishoprics in England had been, for many years prior to the Norman Conquest, royal donatives conferred by delivery of the ring and of the pastoral staff. Disputes arose for the first time between the crown of England and the see of Rome in the reign of William Rufus, the pope claiming to dispose of the English bishoprics; and ultimately King John, by his charter *Ut liberæ sunt electiones totius Angliæ* (1214), granted that the bishops should be elected freely by the deans and chapters of the cathedral churches, provided the royal permission was first asked, and the royal assent was required after the election. This arrangement was confirmed by subsequent statutes passed in the reigns of Edward I. and Edward III. respectively, and the practice was ultimately settled in its present form by the statute Payment of Annates, &c., 1534. According to the provisions of this statute, upon the avoidance of any episcopal see, the dean and chapter of the cathedral church are to certify the vacancy of the see to the crown, and to pray that they may be allowed to proceed to a new election. The crown thereupon grants to the dean and chapter its licence under the great seal to elect a new bishop, accompanied by a letter missive containing the name of the person whom the dean and chapter are to elect. The dean and chapter are thereupon bound to elect the person so named by the crown within twelve days, in default of which the crown is empowered by the statute to nominate by letters patent such person as it may think fit, to the vacant bishopric. Upon the return of the election of the new bishop, the metropolitan is required by the crown to examine and to confirm the election, and the metropolitan's confirmation gives to the election its canonical completeness. In case of a vacancy in a metropolitanical see, an episcopal commission is appointed by the guardians of the spiritualities of the vacant see to confirm the election of the new metropolitan. At one time deans of the "old foundation"—in contradistinction to those of the "new foundation," founded by Henry VIII. out of the spoils of the dissolved monasteries—were elected by the chapter on a *congé d'élire* from the crown, but now all deans are installed by letters-patent from the crown. (See CONFIRMATION OF BISHOPS.)

CONGLETON, HENRY BROOKE PARNELL, 1ST BARON (1776–1842), was the second son of Sir John Parnell, bart. (1744–1801), chancellor of the Irish exchequer, and was educated at Eton and Cambridge. In 1801 he succeeded to the family estates in Queen's county, and married a daughter of the earl of Portarlington; and in 1802, by his father-in-law's interest, he was returned for Portarlington to parliament, but he speedily resigned the seat. In 1806 he was returned for Queen's county, for which he sat till 1832, when he withdrew from the representation. In 1833, however, he was returned for Dundee; and after being twice re-elected for the same city (1835 and 1837), he was raised to the peerage in 1841 with the title of Baron Congleton of Congleton. In 1842, having suffered for some time from ill-health and melancholy, he committed suicide. He was a Liberal Whig, and took a prominent part in the struggle of his party. In 1806 he was a commissioner of the treasury for Ireland; it was on his motion on the civil list that the duke of Wellington was defeated in 1830; in that year and in 1831 he was secretary at war; and from 1835 till 1841 he was paymaster of the forces and treasurer of the ordnance and navy. He was the author of several volumes and pamphlets on matters connected with financial and penal questions, the most important being that *On Financial Reform*, 1830.

He was succeeded as 2nd baron by his eldest son John Vesey (1805–1883), who in 1829 joined the Plymouth Brethren, and spent his life in enthusiastic religious work. He left no son, and his brother Henry William (d. 1896) became 3rd baron, being succeeded by his second son Henry (1839–1906), a soldier who rose to be major-general.

CONGLETON, a market town and municipal borough in the Macclesfield parliamentary division of Cheshire, England, on the North Staffordshire railway, 157½ m. N.W. by N. of London. Pop. (1901) 10,707. It is finely situated in a deep valley, on

the banks of the Dane, a tributary of the Weaver. To the east Cloud Hill, and to the south Mow Cop, rise sharply to heights exceeding 1000 ft. Congleton has no buildings noteworthy for age or beauty, save a few old timbered houses. The grammar school was in existence as early as 1553. In the 16th and 17th centuries the leather laces known as "Congleton points" were in high repute; but the principal industry of the town is now the manufacture of silk, which was introduced in 1752 by a Mr Pattison of London. Coal and salt are raised, and the other industries include fustian, towel, couch, chair and nail factories, iron and brass foundries, stone quarries and corn mills. At Biddulph, 3 m. S., in a narrow valley, across the border in Staffordshire, are several coal-mines and iron-foundries. The gardens of the Grange here are celebrated for their beauty. Congleton is served by the Macclesfield canal. The borough is under a mayor, 6 aldermen and 18 councillors. Area, 2572 acres.

Congleton (*Congulton*) is not mentioned in any historical record before the Domesday Survey, when it was held by Hugh, earl of Chester, and rendered geld for one hide. In the 13th century, as part of the barony of Halton, the manor passed to Henry, earl of Lincoln, who by a charter dated 1282 declared the town a free borough, with a gild merchant and numerous privileges, including power to elect a mayor, a catchpole and an ale-taster. This charter was confirmed by successive sovereigns, with some additional privileges. In 1524 the burgesses were exempted from appearing at the shire and hundred courts, and in 1583 the body corporate was reconstructed under the title of mayor and commonalty, and power was granted to make by-laws and to punish offenders. The governing charter, which held force until the Municipal Corporation Act of 1835, was granted by James I. in 1624, and instituted a mayor, 8 aldermen, 16 capital burgesses, a high steward, common-clerk and other officers. Charters were also granted by Charles II. and George IV. In 1282 Henry, earl of Lincoln, obtained a Saturday market and an eight days' fair at the feast of St Peter ad Vincula, and the market is still held under this grant. In 1311 a Tuesday market is mentioned, and a fair at the feast of St Martin. Henry VI. in 1430 granted to the burgesses a fair at the feast of SS. Philip and James. James I. confirmed the three existing fairs and granted an additional fair on the Thursday before Quinquagesima Sunday. Congleton suffered severely from the plagues of 1603 and 1641, and by the latter was almost entirely depopulated. On the whole, however, the town has steadily grown in population and commercial prosperity from the granting of its first charter.

See *Victoria County History, Cheshire*; Robert Head, *Congleton Past and Present* (Congleton, 1887); Samuel Yates, *An History of the Ancient Town and Borough of Congleton* (Congleton, 1820).

CONGLOMERATE (from the Lat. *conglomerare*, to form into a ball, *glomus, glomeris*; so also the general term "glomeration" for a miscellaneous collection of things, gathered together in a mass), in petrology, the term used for a coarsely fragmental rock consisting of rounded pebbles set in a finer grained matrix. The pebbles must be rounded, otherwise the rocks are breccias, and these have a distinctly different geological significance. They have attained their present shapes by weathering and by attrition during transport by streams and the waves and currents of the sea. The pebbles consist mainly of hard rocks, such as granite, gneiss, sandstone, greywacke, or sometimes limestone. Quartzites, cherts and flints, and vein-quartz are among the hardest and most durable of all rocks, and hence are specially abundant in conglomerates. Fragments of vein-quartz form a large part of the "banket-rock" of the auriferous Transvaal reefs, one of the most important conglomerates economically. In this case the matrix consists mainly of quartz and chlorite, and gold occurs both in the matrix and in the pebbles. Igneous rocks on account of their toughness are also very abundant in many conglomerates; those at the base of the Old Red Sandstone of Scotland, which are thousands of feet in thickness, consist largely of andesite, porphyrite, granite, diorite and porphyry, along with vein-quartz, quartzite and various kinds of gneiss. Soft and friable rocks, on the other hand, such as shale, mica-schist and coal, are rarely found in any quantity

as pebbles in conglomerate-beds. They are ground to pieces by friction against harder masses and help to form the matrix. The size of the pebbles varies greatly; occasionally they are 10 or 20 ft. in diameter, more frequently they are a foot or less. The cementing matrix in which the pebbles are embedded usually bears some resemblance in composition to the nature of the pebbles, but contains a larger proportion of the softer ingredients, such as clay, mica, weathered felspar, calcite and dolomite. Often it resembles a felspathic or calcareous sandstone; if limestone fragments are common it may be highly calcareous, or may be in large measure dolomitic. Often the matrix is stained red by compounds of iron. The "brockram" of the north of England is a well-known Permian limestone-conglomerate. The Dolomitic Conglomerate is a similar rock, but of Triassic age. Both of these are often extensively dolomitized and pass into breccias, where their fragments are angular and unworn. The pebble beds of the Bunter (Triassic period) are also familiar to geologists. They cover extensive areas in the midlands of England, and are well seen at Budleigh Salterton on the south coast. The pebbles are mostly quartzite with granite, chert, sandstone and igneous rocks.

Conglomerates are rarely well bedded, showing at most a rude stratification, but they may contain intercalations of finer materials such as sandstone and shale, which indicate the bedding clearly. In these fossils may be found, but they do not often occur in the conglomerates themselves, as the conditions are generally unsuitable for the preservation of organic remains. The pebbles, however, may be highly fossiliferous, and sometimes important evidence is provided by this means as to the age of the conglomerate. On account of the imperfect stratification it is often very hard to estimate the thickness of conglomerates, and this difficulty is increased by the fact that many of them must have been laid down as sloping banks of pebbles and not as flat layers of deposit. Conglomerates are merely consolidated gravels, and have originated mostly on seashores or in shallow waters near land. They are typical shore formations, and are especially frequent where one series of stratified rocks rest upon an older group unconformably. Other conglomerates occur along with fine-grained red sandstones, salt beds and such rocks as accompany desert deposits. We may compare them with the accumulations of pebbles which cover extensive areas of existing deserts. A quite distinct group of conglomerates characterizes regions where the rocks are much broken and sheared; these may very closely resemble true conglomerates, but have really been produced by the mashing together of rock masses along zones of fracture and movement. They are known as "crush-conglomerates" or "auto-clastic rocks." Conglomerates may undergo metamorphism, and are then converted into "conglomerate-gneiss" or "conglomerate-schist." Their pebbles are flattened and dragged out of shape by interstitial movement, while the matrix becomes highly crystalline. One of the best-known examples of this is the Obermittweida gneiss (Saxony). (J. S. F.)

CONGO, formerly known as Zaire, the largest of the rivers of Africa, exceeded in size among the rivers in the world by the Amazon only. The Congo, though it has a shorter course than the Nile, has a length of fully 3000 m. and a drainage area estimated at 1,425,000 sq. m., with a diameter of some 1400 m. either way. This vast area includes the equatorial basin of Central Africa and much of the surrounding plateaus. West and north the Congo basin is bounded by comparatively narrow bands of higher ground, while east and south the drainage area of the river includes considerable portions of the high plateaus of east and south Central Africa. The main drainage of the Congo system is thus north and west, and these two directions dominate the great bow-like sweep of the main stream before it is deflected south on approaching the western highlands, through which it finally forces a way to the Atlantic Ocean. From the high lands of the south and east in which the head-streams of the Congo have their origin, the land falls in a succession of steps, generally marked by gorges or rapids in the upper courses of the streams. Besides the main stream most of the

affluents of the river are navigable for considerable distances; in all there are over 6000 m. of navigable water in the Congo basin and 20,000 m. of overhanging wooded banks. On the Congo alone are over 4000 islands, many of considerable length—some fifty of them are over ten miles long. The volume of water poured into the Atlantic is at least 1,200,000 cubic ft. per second.¹

Head-Streams.—The most distant head-streams of the Congo are far to the north and east of those most to the south, and it is difficult to determine which stream is the "parent" river. The easterly head-streams are, however, regarded generally as marking the true course of the Congo. The most remote of these rivers is the Chambezi, which, with its tributaries, rises (in British territory) on the southern slope of the plateau between lakes Nyasa and Tanganyika at an elevation of about 6000 ft. The watershed is formed by the crest of the plateau, and is perfectly distinguishable, save at a spot called Ikomba, about half-way between the lakes, where is a swamp which drains to both the Atlantic and the Indian oceans. The Chambezi source is in 9° 6' S., 31° 20' E. Its chief tributary, the Karungu, rises in 9° 50' S., 33° 2' E. The Chozi, an affluent of the Karungu, rises in the same latitude as the Chambezi, about half a degree to the east of that stream. After the junction of the Karungu and Chambezi the river flows in a south-westerly direction through a fairly fertile country, and receiving many tributaries becomes a large river with steep wooded banks and many islands. Its width varies greatly, from 30 yds. to 2 m. in a comparatively short distance; its depth is rarely less than 14 ft. In its lower course the Chambezi passes through papyrus marshes, and dividing into several channels, enters the vast swamp which forms the southern part of Lake Bangweulu (*q.v.*). The large river, known as the Luapula (Great River), which issues from Bangweulu in 11° 31' S and runs south through this swamp, may be regarded as a continuation of the Chambezi, there being a channel from the one stream to the other. The Luapula on leaving the swamp bends west and then south—reaching 12° 25' S.—and approaches the watershed of the Zambezi, receiving several southern tributaries. The source of its most southern affluent, and therefore the most southern point in the Congo basin, is approximately in 13° 30' S. Turning north the Luapula precipitates itself down the Mumbatuta (or Mambirima) Falls (12° 17' S., 29° 15' E.), the thunder of which can be heard on a still night for 8 or 9 m. The river, the width of which varies from 250 to 1200 yds., is almost unnavigable until below the Johnston Falls (Mambirima of the natives), a series of rapids extending from 11° 10' to 10° 30' S. Below the falls the river is navigable by steamer all the way to Lake Mweru—a distance of 100 m. Before entering Mweru (*q.v.*) the Luapula again, passes through a swampy region of deltaic character, a great part of the water escaping eastwards by various channels, and after spreading over a wide area finally passing into Mweru by lagoon-like channels east of the main Luapula mouth. From Bangweulu to Mweru the fall of the river in a total distance of 350 m. is about 700 ft. The river (known now as the Luvua) makes its exit at the N.W. corner of the lake, and bending westwards in a winding course, passes, with many rapids, across the zone of the Kebara and Mugila mountains, falling during this interval nearly 1000 ft. In about 6° 45' S., 26° 50' E. it joins the Kamolondo (otherwise Lualaba), the western main branch of the Congo, which, as it flows in a broad level valley at a lower level than the eastern branch, is held by some to be the true head-stream. The Kamolondo is formed by the junction of several streams having their source on the northern slope of the south-central plateau as it dips towards the equatorial basin. This escarpment contains many heights exceeding 6000 ft. The streams flowing south from it belong to the Zambezi basin, but the watershed is not everywhere clearly defined. Thus the Lumpemba (an affluent of the Lokuleshe, one of the main tributaries of the Lubudi) rises in 11° 24' S., 24° 28' E., 3 m. S.

¹ Sir John Murray estimated the mean annual discharge of the Congo at 419,291 cub. m., making it in this respect only second to the Amazon (*Scot. Geog. Mag.*, 1887). The annual rainfall of the basin he put at 1213.344 cub. m.

and 6 m. E. of the source of the Zambezi, both streams running a parallel course northward for some 15 m. There is, however, no connexion between the Zambezi and Congo systems. The Lualaba, also known as Nzilo, which is the main stream of the Kamolondo, rises at an altitude of 4700 ft., in 26° 40' E., just north of 12° S.—the watershed of the western head-streams of the Congo being everywhere north of that parallel. East of the Lualaba—between it and the Luapula—rises the river Lufira. With many windings the Lualaba and Lufira pursue a generally northerly direction, passing through the Mitumba range in deep gorges, their course being broken by rapids for 40 or 50 m. Below Konde Rapids in 9° 20' S. the Lualaba is, however, free from obstructions. (Just above the last of the series of rapids it is joined by the Lubudi, a considerable river and the westernmost of the Kamolondo affluents.) Between the rapids named and 7° 40' S. its valley is studded with a chain of small lakes and backwaters. The largest—Upemba—has channels communicating both with the Lualaba and the Lufira. In the rainy season the whole region becomes a marsh; various grasses, especially papyrus, form floating islands, and the conditions generally recall the sudd region of the Nile. In about 8° 20' S. the Lualaba and Lufira unite in one of these marshy lakes—Kisale—through which there is a navigable channel. The river issuing from Lake Kisale is called Kamolondo; it has a width varying from 300 to 1000 ft. and an average depth of 10 ft. From Konde Rapids to those of Dia in 5° 20'—a distance of 300 m.—there is no interruption to navigation saving the floating masses of vegetation on Kisale at high water. The region watered by these western head-streams of the Congo includes Katanga and other districts, which are among the most fertile and densely populated in Belgian Congo.

The Upper Congo or Lualaba.—After the junction of the Luapula (Luvua) and the Lualaba (Kamolondo) the united stream, known as the Lualaba or Lualaba-Congo, and here over half a mile wide, pursues a N.N.W. course towards the equator. The Dia Rapids, already mentioned, are the first obstruction to navigation encountered. A mile or two lower down the Lualaba passes through a narrow gorge called the Porte d'Enfer. From this point as far north as 3° 10' S. the course of the river is interrupted by falls and rapids, the chief being the rapids (in 3° 55' S.) below the Arab settlement of Nyangwe and those at Sendwe in 3° 15' S. In this part of its course the Congo becomes a majestic river, often over a mile wide, with flat wooded banks, the only real impediments to navigation between the Dia Rapids and Stanley Falls being those named. Between the junction of the two main upper branches, about 1700 ft. above the sea, and the first of the Stanley Falls (1520 ft.), the fall of the river is less than 200 ft., in a distance of 500 m. During the whole of this section the Lualaba receives the most of its tributaries from the east. Of these, the Lukuga connects Lake Tanganyika with the Congo system. The Lukuga (see TANGANYIKA) drains the mountainous country through which it passes, and also, intermittently, receives the overflow waters of Tanganyika. The outlet from the lake is sometimes clear, sometimes silted up. The Lukuga is much broken by rapids, falling 1000 ft. during its course of some 300 m. Farther north are a number of streams which drain the forest region between 4° S. and the equator, the Lubamba, the Eilila or Lira, the Luindi and the Lova being the most important. Their sources lie on an upland region west of the Albertine rift-valley. The Luindi in its middle course has a general width of 60 to 100 yds., but the Lova is larger, receiving two important affluents, the Luvuto from the north and the Ozo which rises in the mountains at the N.W. end of Lake Kivu. The lower course of the Luindi is very tortuous.

Stanley Falls.—Stanley Falls, which mark the termination of the upper Congo, begin a few miles south of the equator. At this point the river forsakes the northerly course it has been pursuing and sweeps westward through the great equatorial basin. The falls consist of seven cataracts extending along a curve of the river for nearly 60 m. They are not of great height—the total fall is about 200 ft.—but they effectually prevent

navigation between the waters above and those below except by canoes. The first five cataracts are near together; only 9 m. separate the first from the fifth. The sixth cataract is 22 m. lower down, and the seventh, the most formidable of all the cataracts, is 26 m. below the sixth. The fall, divided into two portions by an islet, is 800 yds. wide. The channel is narrowed at the foot of the fall to some 450 yds. by an island close to the left bank; on the right bank of the river is the island of Wane Rusari (2 m. long by ½ m. broad), separated from the mainland by a channel 30 yds. wide. The fall is only about 10 ft.; but the enormous mass of water, and the narrow limits to which it is suddenly contracted, make it much more imposing than many a far loftier cataract. Small rapids mark the course of the river for another 2 m.

The Middle Congo.—Below Stanley Falls the Congo is unbroken by rapids for 980 m., and is navigable throughout this distance all the year round. The river here makes a bold north-westerly

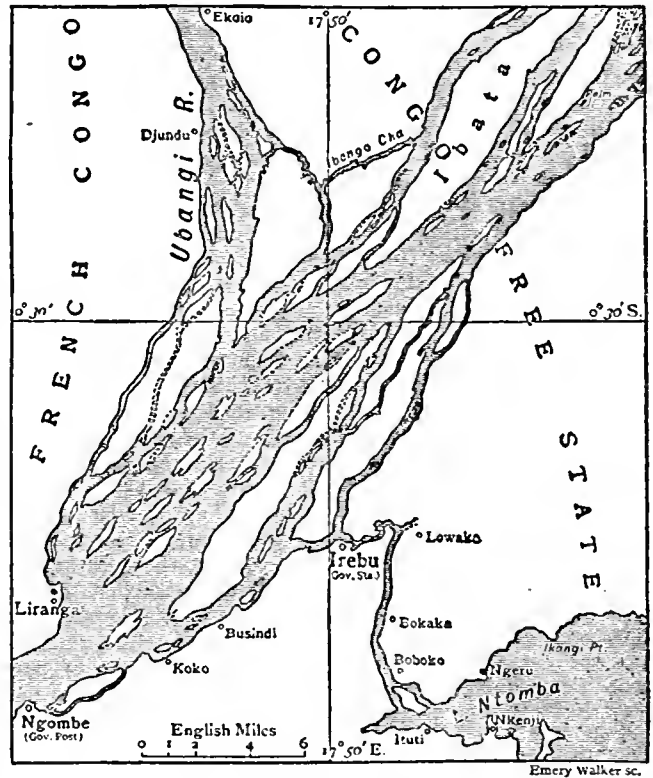

curve, attaining its most northerly point (2° 13' 50" N.) at 22° 13' E., and reaches the equator again after a course of 630 m. from the falls—the distance in a direct line being 472 m. For another 250 m. the river flows south-westerly, until at Stanley Pool the limit of inland navigation is reached. For the greater part of this section the Congo presents a lacustrine character. Immediately below the falls the river, from ½ to 1 m. broad, flows between low hills, which on the south give place to a swampy region, the river-bank marked by a ridge of clay and gravel. After receiving the waters of the Aruwimi—130 m. below the falls—the Congo broadens out to 4 or 5 m.; its banks, densely wooded, are uniformly low, and the surface of the water is studded with alluvial islands and innumerable sandbanks, rendering it impossible save at rare intervals to see from bank to bank. The velocity of the current decreases as the waters spread out, though there is always a channel from 4½ to 5 ft. deep. About 100 m. below the Aruwimi confluence the Loika or Itimbiri joins the main stream from the north, the Congo narrowing considerably here owing, it is supposed, to the matter deposited by the Loika. At two or three other places lower down, the river is contracted to 2½ or 2 m. as a result of a slight elevation in the ground, but for a distance of 500 m. no real hill is met with. On the southern curve of the horseshoe bend are

found the largest islands of the Congo—Esumba, 30 m. long, and Nsumba, 50 m. long, and over 5 across at its broadest part. At this point the river from bank to bank is 9 m. wide. Opposite Nsumba, the Mongala, a northern affluent, enters the main stream, whilst lower down (just north of the equator) the Lulunga, Ikelemba and Ruki rivers, southern tributaries, mingle their black waters with the dark current of the Congo. Thirty miles south of the equator the river is joined by the Ubangi (*q.v.*), its greatest northern affluent. Here the Congo is fully 8 m. wide. Opposite the Ubangi confluence is the mouth of a narrow channel, some 10 m. long, which connects the Congo with Lake Ntomba, a sheet of water about 23 m. long by 8 to 12 broad. In flood time the water flows from the Congo into the lake. Immediately below ferruginous conglomerate hills of slight eminence reduce the river to a width of less than 2 m., and in comparatively close succession are two or three other narrows. With these exceptions the Congo continues at a width of 5 to 6 m. until at $2^{\circ} 36' S.$ it abruptly contracts, being confined between steep-faced hills rising to 800 ft. This stretch of the river, known as the "Chenal," is 125 m. long and is free from islands, though long reefs jut into the stream. Its width here varies from 2 m. to less than 1 m. About 40 m. after the Chenal is entered the Kasai (*q.v.*) coming from the south empties its brick-coloured waters at right angles into the Congo through a chasm in the hills 700 yds. wide. The confluence is known as the Kwa mouth. The Chenal ends in the lake-like expansion of Stanley Pool, 20 m. long by 14 broad. The middle of the pool is occupied by an island (Bamu) and numerous sandbanks. Its rim is "formed by sierras of peaked and picturesque mountains, ranging on the southern side from 1000 ft. to 3000 ft. in height." The banks offer considerable variety in character. On the north bank are the Dover Cliffs, so named by H. M. Stanley from their white and glistening appearance, produced, however, not by chalk but by silver sand, the subsidence of which into the water renders approach to the bank sometimes dangerous. The banks of the lower end of the pool are comparatively flat. On the south side, however, stands the great red cliff of Kallina Point (about 50 ft. high), named after an Austrian lieutenant drowned there in 1882. Round the point rushes a strong current $7\frac{1}{2}$ knots an hour, difficult to stem even for a steamer. On the northern bank of the river at the western end of the pool is the French port of Brazzaville. South of the pool hills, low but steep, reappear, and 4 m. lower down begin the cataracts which cut off the middle Congo from the sea. Some 300 yds. above the first of these cataracts is the Belgian port of Leopoldville, connected with the navigable waters of the lower river by railway. At Stanley Pool the elevation of the river above the sea is about 800 ft., a fall of over 500 ft. in the 980 m. from Stanley Falls. The banks of the river throughout this long stretch of country are very sparsely populated. The number of inhabitants in 1902 did not exceed 125,000.

The velocity of the stream in the middle Congo varies considerably. At the Aruwimi confluence the rate is from 300 to 350 ft. a minute; in the broader stretches lower down the current is not more than 200 ft. a minute. Through the Chenal the pace is greatly accelerated, and as it flows out of Stanley Pool the current is not less than 600 ft. a minute.

The Lower Congo.—The cataracts below Stanley Pool are caused by the river forcing its way through the mountains which run parallel to the western coast of the continent. The highlands (known as the *Serro do Crystal*) consist of two principal mountain zones with an intermediate zone of lower elevation. The passage of this intermediate zone is marked by a fairly navigable stretch of river extending from Manyanga to Isangila, a distance of 70 m., during which the only serious rapids are those of Chumbo and Itunzima, the latter in $13^{\circ} 54' E.$; while above and below, rapids succeed each other at short intervals. Some eighteen main rapids or falls occur during the upper section (87 m.), in the course of which the level drops about 500 ft.; and about ten in the lower section (56 m.), during which the fall is about 300 ft. The last rapid is a little above the port of Matadi, beyond which the river is navigable for large vessels to the sea, a distance of about 85 m. At Matadi the tall cliffs on either side sink away

and the river widens out into an estuary with many mangrove-bordered creeks and forest-clad islands of a deltaic character. This estuary is traversed by a deep cañon, in which soundings of 900 ft. have been obtained. The mouth of the river is in $6^{\circ} S.$ and $12^{\circ} 20' E.$ The cañon or gully is continued into the open sea for over 100 m., with depths as much as 4000 ft. below the general level of the sea floor. Just below Matadi, where the width of the river is about half a mile, depths of 276 and 360 ft. have been found, the current here running at from 4 to 8 knots, according to the season; while the difference in level between high and low water is 20-25 ft. The difference in level is not due to tidal action but is caused by the rainy or dry seasons, of which there are two each during the year. In the middle Congo May and November are the times of greatest flood; in the lower river the floods are somewhat later. At Stanley Pool the maximum rise of water is about 15 ft. The tides are felt as far as Boma, 49 m. from the mouth of the river, but the rise is there less than a foot; while at the mouth it is 6 ft. The cañon above mentioned is occupied by salt water, which is nearly motionless. Above it the fresh water runs with increasing velocity, but decreasing depth, so that just within the mouth of the river it is only a few feet deep.

The river at its mouth between Banana Point on the north and Sharks Point on the south is over 7 m. across. Banana Point (which grows no bananas) is the end of a long sandy peninsula, its highest spot not more than 6 ft. above high water; Sharks Point is bolder and shaped somewhat like a reaping-hook with the point turned inward, thus enfolding Diegos Bay. The current of the river is perceptible fully 30 m. out to sea, the brown waters of the Congo being distinguishable from the blue of the ocean.

Northern Tributary Rivers.—The various head-streams and affluents of the upper Congo have been already described. Below Stanley Pool numerous streams with courses of 100 or more miles drain the Crystal Mountains and join the Congo. They are unnavigable and comparatively unimportant. There remain to consider the affluents of the middle river. Of these the most important, the Ubangi on the north and the Kasai on the south, with their tributary streams, are noticed separately. In dealing with the other affluents of the Congo those entering the river on the right bank will be considered first.

The Lindi enters the Congo about 15 m. below Stanley Falls in $25^{\circ} 4' E.$ It rises in $1^{\circ} N., 28^{\circ} 30' E.,$ and flows W. in a tortuous course. Below the Lindi Falls in $1^{\circ} 20' N., 26^{\circ} E.$ it is navigable, a distance of over 100 m. A mile or two above its confluence with the Congo it is joined by the Chopo, a more southerly and less important stream. The basins of these two rivers do not extend to the outer Congo watershed, but the next feeder, the great Aruwimi, rises, as the Ituri, in close proximity to Albert Nyanza, flowing generally from east to west. It is formed of many branches, including the Nepoko from the north, and its upper basin extends over $2\frac{1}{2}^{\circ}$ of latitude. The upper river, to about $27^{\circ} E.,$ is much broken by rapids, but apart from those of Yambuya in $24^{\circ} 47'$ the lower river is nearly free from obstructions. To Yambuya, the limit of navigation from the mouth of the Aruwimi, is a distance of over 90 m. The Aruwimi flows almost entirely through the great equatorial forest, which here seems to reach its maximum density. Its confluence with the Congo is in $1^{\circ} 12' N., 23^{\circ} 38' E.$ On its north bank just above the mouth is the station of Basoko. The next tributary, known as the Loika, Itimbiri or Lubi river, rises in about $26^{\circ} E.,$ and, flowing generally west, joins the Congo by two mouths, $22^{\circ} 35'-46' E.$ The Loika is navigable by steamers as far as the Lubi Falls, a distance of 150 m. The Mongala, the next great tributary to join the Congo, drains the country between the Loika to the east and the Ubangi to the west. It rises in about $3^{\circ} N., 23^{\circ} 20' E.,$ and flows in a somewhat similar curve (on a smaller scale) to that of the Ubangi. The Mongala is navigable for over 300 m., and gives access to a fertile rubber-producing region. The Moogala confluence is in $1^{\circ} 53' N., 19^{\circ} 49' E.$ Below the Ubangi confluence the Sanga, in $1^{\circ} 12' S., 16^{\circ} 53' E.,$ joins the Congo. The Sanga rises in the north-west verge of the Congo

basin and flows in a general north to south direction. Its lower course is tortuous, as it flows across level, often swampy, plains. The main northern branch rises in southern Adamawa in about 7° N., 15° E. An almost equally large western branch, the Dscha (or Ngoko), rises in about 3° N., 13½° E., and after flowing W. for 100 m. makes a sudden bend S.E., joining the main stream in 1° 40' N., 16° E. In its course it traverses a vast tract of uninhabited forest. The Sanga is navigable by steamers as far as the south-east corner of the German colony of Cameroon, a distance of 350 m. The Likuala and Alima, which join the Congo within 30 m. of the mouth of the Sanga, are much smaller streams. The Léfini (mouth in 2° 57' S., 16° 14' E.) is the last stream of any size to join the Congo above Stanley Pool.

Southern Tributaries.—The first of the southern tributaries of the middle Congo, the Lomami, enters the main stream in 0° 46' N., 24° 16' E. It has a length of over 700 m., rising in nearly 9° S. It flows S. to N., the greater part of its course being parallel to and from 40 to 150 m. west of the upper Congo. It is comparatively narrow and tortuous, but deep, with a strong current, and is hardly broken by rapids north of 4½° S. About 3° S. it traverses a region of swamps, which may have given rise to the reports once current of a great lake in this locality. For the last 200 m. it is navigable by steamers. Below the mouth of the Lomami there is a long stretch with no southern tributary, as the great plain within the Congo bend is drained by streams flowing in the same direction as the middle Congo—east to west. The Lulanga (or Lulongo), about 400 m. long, enters in 0° 40' N., 18° 16' E. Its northern branch approaches within 20 m. of the Congo in its upper course. The main branch of the Ruki or Juapa, which enters a little north of the equator in 18° 21' E., has its rise between 24° and 25° E. and about 3° S., in the swampy region traversed by the Lomami. On account of the colour of its water it was named by H. M. Stanley the Black river. It is about 600 m. long and has two large southern tributaries. A few miles above the Ruki confluence the Ikelemba (some 150 m. in length) joins the Congo. The three rivers, Lulanga, Ikelemba and Ruki, and their sub-streams, have between them over 1000 m. of navigable waters. No rapids intercept their course.

Exploration.—Unlike the Nile there are no classic associations with the Congo. A single mention made of the Zaire by Camoens in the *Lusiads* exhausts its connexion with literature (up to the beginning of the 19th century), other than in little known and semi-fabulous accounts of the ancient kingdom of Congo. The mouth of the river was discovered by the Portuguese naval officer Diogo Cão or Cam either in 1482 or 1483. To mark the discovery and to claim the land for the Portuguese crown he erected a marble pillar on what is now called Sharks Point. Hence the river was first called Rio de Padrão (Pillar river). It soon, however, became known as Zaire (*q.v.*), a corruption of a native word meaning "river," and subsequently as the Congo. In the three centuries succeeding Diogo Cão's discovery strangely little was done to explore the river. At length the British Admiralty took action, and in 1816 despatched Captain J. K. Tuckey, R.N., at the head of a well-equipped mission. The expedition was prompted by the suggestion that the Congo was identical with the Niger. So slight was the knowledge of the river at that time that the only chart with any pretension to accuracy did not mark it farther than 130 m. from the mouth, a state of affairs, in the opinion of the admiralty, "little creditable to those Europeans who for nearly three centuries have occupied various parts of the coast" near the river's mouth. Captain Tuckey's expedition reached the mouth of the Congo on the 6th of July 1816, and managed to push up stream as far as Isangila, beyond the lowest series of rapids; but sickness broke out, the commander and sixteen other Europeans died, and the expedition had to return. Captain Tuckey and several of his companions are buried on Prince's Island, just above Boma, the point where the Congo widens into an estuary. A detailed survey of the first 25 m. of the river was effected in 1826 by the "Levin" and the "Barracouta" belonging to Captain (subsequently Vice-Admiral) W. F. W. Owen's expedition; in 1857 Commander J. Hunt, of the "Alecto," made an attempt to ascend the river, but only

reached the cataracts. Captain, afterwards Sir Richard, Burton attained the same limit in 1863, and also proceeded inland as far as Banza Noki (São Salvador). In November 1872 an expedition under Lieutenant W. Grandy, R.N., was despatched from England for the purpose of advancing from the west coast to the relief of David Livingstone. So little was the Congo known, however, that Ambriz was chosen as the starting-point, and the expedition marched overland. After many vicissitudes Lieutenant Grandy had to retrace his steps. He reached, late in 1873, a point on the Congo below the cataracts and intended thence to push his way up stream. The death of Livingstone was soon afterwards reported; and in April 1874, just as Grandy was prepared to ascend the river, letters of recall brought the expedition to a close.

It was by working down from its source that the riddle of the Congo was finally solved. In 1868 David Livingstone traced the course of the Chambezi to Lake Bangweulu. In March 1871 he reached the town of Nyangwe on the Lualaba, and died (1873) whilst endeavouring to trace the head-streams of that river, which he believed to be the Nile. "I have no fancy," he once said, "to be made into 'black man's pot' for the sake of the Congo." Livingstone's views were not shared by the scientific world, and as early as 1872 geographers were able to affirm from Livingstone's own reports that the great river system he had explored in the region north of the Zambezi must belong to the Congo and not to the Nile. Actual proof was lacking, and of the course of the main river there was absolute ignorance. But in October 1876, H. M. Stanley arrived at Nyangwe from Zanzibar and from that point navigated the river over 1600 m. to Isangila—"Tuckey's Furthest"—reached in July 1877, thus demonstrating the identity of the Lualaba with the Zaire of the Portuguese. Stanley's great journey marked an epoch in the history of Africa, politically and commercially as well as geographically. Of the many travellers who followed Stanley in the Congo basin none did more to add to the exact knowledge of the main river and its greatest tributaries—the Ubangi, the Kasai and the Lomami—than the Rev. George Grenfell (1849–1906) of the Baptist Missionary Society. The Aruwimi was partly explored by Stanley in 1887 in his last expedition in Africa, and was further examined by Grenfell in 1894 and 1902. The western head-streams were largely made known by the Belgians, Capt. C. Lemaire and A. Delacommune, the last-named also mapping the upper Lomami and the Lukuga. (See also UBANGI; KASAI; LIVINGSTONE and STANLEY).

See H. M. Stanley, *Through the Dark Continent*, &c. (London, 1878); George Grenfell, *Map of the River Congo, with Memorandum* (London, 1902); Sir H. H. Johnston, *George Grenfell and the Congo* (2 vols., London, 1908); C. Lemaire, *Mission scientifique du K-Tanga* (Brussels, 1901–1908); 17 memoirs, No. 16 being the *Journal de route*; J. K. Tuckey, *Narrative of an Expedition to explore the river Zaire*, &c. (London, 1818); E. Behm, "Proofs of the Identity of the Lualaba with the Congo" (*Proc. Roy. Geo. Soc.* vol. xvii., London, 1873); *Le Mouvement géographique* (Brussels, weekly since 1884), and the geographical works mentioned in the bibliography of the Congo Free State. Grenfell's map, scale 1:250,000, is of the river between Stanley Pool and Stanley Falls. For the lower river see H. Droogmans, *Carte du Bas Congo*, scale 1:100,000, and *Notices sur le Bas Congo* (Brussels, 1900–1902). (F. R. C.)

CONGO FREE STATE, the name formerly given by British writers to the *État Indépendant du Congo*, a state of equatorial Africa which occupied the greater part of the basin of the Congo river. In 1908 the state was annexed to Belgium. The present article gives (1) the history of the state, (2) an account of the topography, ethnology, &c., of the country and of its economic condition at the date of its becoming a Belgian colony.

I. HISTORY

The Congo Free State owed its existence to the ambition and force of character of a single individual. It dated its formal inclusion among the independent states of the world from 1885, when its founder, Leopold II., king of the Belgians, became its head. But to understand how it came into existence a brief account is needed of its sovereign's connexion with the African continent. In 1876 King Leopold summoned a conference at Brussels of the leading

Inception and formation.

geographical experts in Europe, which resulted in the creation of "The International Association for the Exploration and Civilization of Africa." To carry out its objects an international commission was founded, with committees in the principal countries of Europe. The Belgian committee at Brussels, where also were the headquarters of the International commission, displayed from the first greater activity than did any of the other committees. It turned its attention in the first place to East Africa, and several expeditions were sent out, which resulted in the founding of a Belgian station at Karema on Lake Tanganyika. But the return of Mr (afterwards Sir) H. M. Stanley from his great journey of exploration down the Congo forcibly directed the attention of King Leopold to the possibilities for exploration and civilization offered by the Congo region. On the invitation of the king, Mr Stanley visited Brussels, and on the 25th of November 1878 a separate committee of the International Association was organized at Brussels, under the name "Comité d'études du Haut Congo." Shortly afterwards this committee became the "International Association of the Congo," which in its turn was the forerunner of the Congo Free State. The Association was provided with a nominal capital of £40,000, but from the first its funds were largely supplemented from the private purse of King Leopold; and by a gradual process of evolution the work, which was originally, in name at least, international in character, became a purely Belgian enterprise. Mr Stanley, as agent of the Association, spent four years in the country, founding stations and making treaties with various chiefs. The first station was founded in February 1880 at Vivi, and before returning to Europe in August 1884 Mr Stanley had established twenty-two stations on the Congo and its tributaries. Numerous expeditions were organized by King Leopold in the Congo basin, and the activity of the International Association and its agents began seriously to engage the attention of the European powers interested in Africa. On behalf of Portugal, claims were advanced to the Congo, based on the discovery of its mouth by Portuguese navigators centuries before. In the interests of France, M. de Brazza was actively exploring on the northern banks of the Congo, and had established various posts, including one where the important station of Brazzaville is now situated. The fact that the International Association of the Congo had no admitted status as a sovereign power rendered the tenure of its acquisition somewhat precarious, and induced King Leopold to make determined efforts to secure for his enterprise a recognized position. Early in 1884 a series of diplomatic events brought the question to a head. The 2nd Earl Granville, then British foreign secretary, in February of that year concluded a convention with Portugal, recognizing both banks of the mouth of the Congo as Portuguese territory. This convention was never ratified, but it led directly to the summoning of the Berlin Congress of 1884-1885, and to the recognition of the International Association as a sovereign state.

The United States of America was the first great power, in a convention signed on the 22nd of April 1884, to recognize the Association as a properly constituted state. Simultaneously, King Leopold had been negotiating with the French government, the Association's most serious rival, not only to obtain recognition but on various boundary questions, and on the 23rd of April 1884 Colonel M. Strauch, the president of the Association, addressed to the French minister for foreign affairs a note in which he formally declared that the Association would not cede its possessions to any power, "except in virtue of special conventions, which may be concluded between France and the Association, for fixing the limits and conditions of their respective action." The note further declared that, as a fresh proof of its friendly feeling towards France, the Association engaged to give France the right of preference if, through unforeseen circumstances, it were compelled to sell its possessions. Mention may here be made of the fact that in a note dated the 22nd of April 1887, M. van Eetvelde, administrator-general of the foreign affairs of the Congo State, informed the French minister at Brussels that the International Association had not intended in 1884 that the right

of preference accorded to France could be opposed to that of Belgium; and on the 29th of April the French minister took note, in the name of the French government, of this interpretation of the right of preference, in so far as such interpretation was not contrary to pre-existing international engagements. Germany was the next great power after the United States to recognize the flag of the International Association as that of a friendly state, doing so on the 8th of November 1884, and the same recognition was subsequently accorded by Great Britain on the 16th of December; Italy, 19th of December; Austria-Hungary, 24th of December; Holland, 27th of December; Spain, 7th of January 1885; France and Russia, 5th of February; Sweden and Norway, 10th of February; Portugal, 14th of February; and Denmark and Belgium, 23rd of February. While negotiations with Germany for the recognition of the status of the Congo Free State were in progress, Prince Bismarck issued invitations to the powers to an international conference at Berlin. The conference assembled on the 15th of November 1884, and its deliberations ended on the 26th of February of the following year by the signature of a General Act, which dealt with the relations of the European powers to other regions of Africa as well as the Congo basin. The provisions affecting the Congo may be briefly stated. A conventional basin of the Congo was defined, which comprised all the regions watered by the Congo and its affluents, including Lake Tanganyika, with its eastern tributaries, and in this conventional basin it was declared that "the trade of all nations shall enjoy complete freedom." Freedom of navigation of the Congo and all its affluents was also secured, and differential dues on vessels and merchandise were forbidden. Trade monopolies were prohibited, and provision made for civilizing the natives, the suppression of the slave trade, and the protection of missionaries, scientists and explorers. Provision was made for the powers owning territory in the conventional basin to proclaim their neutrality. As regards navigation, only such taxes or duties were to be levied as had "the character of an equivalent for services rendered to navigation itself"; and it was further provided that (Article 16) "The roads, railways or lateral canals which may be constructed with the special object of obviating the innavigability or correcting the imperfection of the river route on certain sections of the course of the Congo, its affluents, and other waterways, placed under a similar system as laid down in Article 15, shall be considered, in their quality of means of communication, as dependencies of this river and as equally open to the traffic of all nations. And as on the river itself, so there shall be collected on these roads, railways, and canals only tolls calculated on the cost of construction, maintenance, and management, and on the profits due to the promoters"; while as regards the tariff of these tolls, strangers and natives of the respective territories were to be treated "on a footing of perfect equality." The International Association not having possessed, at the date of the assembling of the Conference, any recognized status, was not formally represented at Berlin, but the flag of the Association having, before the close of the conference, been recognized as that of a sovereign state by all the powers, with the exception of Turkey, the Association formally adhered to the General Act.

Thus early in 1885 King Leopold had secured the recognition of the Association as an independent state, but its limits were as yet not clearly defined. On the 5th of February, as the result of prolonged negotiations, France conceded the right of the Association to the course of the lower Congo below Manyanga, and accepted the Chiloango river and the water-parting of the waters of the Niadi Kwilu and the Congo, as far as beyond the meridian of Manyanga, as the boundary between her possessions and those of the Association on the lower river. From Manyanga the frontier was to follow the Congo up to Stanley Pool, the median line of Stanley Pool, and the Congo again "up to a point to be settled above the river Licon-Nkundja," from which point a line was to be drawn to the 17th degree of longitude east of Greenwich, following as closely as possible the water-parting of the Licon-Nkundja basin. The identity of the Licon-Nkundja

Recognition by the powers.

Agreements as to limits.

subsequently gave rise to considerable discussions with France, and eventually a protocol, signed at Brussels on the 29th of April 1887, continued the boundary along the Congo to its confluence with the Ubangi (Mobangi), whence it followed the *thalweg* of that river to its intersection with the 4th parallel of north latitude, below which parallel it was agreed that the northern boundary of the Congo Free State should in no case descend. In accepting this frontier King Leopold had to sacrifice all claims to the valley of the Niadi Kwilu, in which he had founded fourteen stations, and to the right bank of the Ubangi. With Portugal the Association concluded an agreement on the 14th of February 1885, by which the northern bank of the Congo was recognized as belonging to the Association, while Portugal retained the southern bank of the river as far as Noki. North of the Congo Portugal retained the small *enclave* of Kabinda, while south of the river the frontier left the Congo at Noki and followed the parallel of that place to the Kwango river.

In April 1885 the Belgian chamber authorized King Leopold "to be the chief of the state founded in Africa by the International Association of the Congo," and declared that "the union between Belgium and the new State of the Congo shall be exclusively personal." This act of the Belgian legislature regularized the position of King Leopold, who at once began the work of organizing an administration for the new state.¹ In a circular letter addressed to the powers on the 1st of August 1885 His Majesty declared the neutrality of the "Independent State of the Congo," and set out the boundaries which were then claimed for the new state. At the date of the issue of the circular the agreements with France and Portugal had partially defined the boundaries of the Free State on the lower river, and the 30th degree of longitude east of Greenwich was recognized as the limit of its extension eastwards.

The following is a list of the agreements subsequently made with reference to the boundaries of the state (see also AFRICA, §5):—

1. 22nd of November 1885, with France.—Protocol for delimitation of the Manyanga region.
2. 29th of April 1887, with France.—Protocol for delimitation of the Ubangi region.
3. 25th of May 1891, with Portugal.—Treaty for delimitation of the Lunda region, and convention of even date for the settlement of frontiers on lower Congo.
4. 24th of March 1894, with Portugal.—Declaration approving delimitation of Lunda region.
5. 12th of May 1894, with Great Britain.—Agreement as to Nile valley and boundaries with British Central Africa.
6. 14th of August 1894, with France.—Agreement as to Mbomu river, and Congo and Nile basins.
7. 5th of February 1895, with France.—Agreement as to Stanley Pool.
8. 9th of May 1906, with Great Britain.—Agreement as to territories leased in 1894 in the Nile valley.

The net result of the above agreements was to leave the Congo Free State with France, Portugal and Great Britain as her neighbours on the north, with Great Britain and Germany as her neighbours on the east, and with Great Britain and Portugal on her southern frontier. The main object of King Leopold's ambition was to obtain an outlet on the Nile, and for the history of the incidents connected with the two important agreements made in 1894 with Great Britain and France, and their sequel in the agreement made with Great Britain in 1906, reference must be made to the article AFRICA, §5. The expenditure necessitated by the efforts of the king to attain his object involved a heavy strain on the finances of the state, reacting on its internal policy. The avowed object of the Free State was to develop the resources of the territory with the aid of the natives, but it early became apparent that the Arab slave-traders, who had established themselves in the country between Lake Tanganyika and Stanley Falls and on the upper river, opposed a serious obstacle to the realization of this programme. The scanty resources at the disposal of the state imposed a policy of restraint on the officers who were brought into relations with

¹ The formal proclamation of sovereignty was made at Boma on the 1st of July 1885.

the Arabs on the upper river, of whom Tippoo-Tib was the chief. In 1886 the Arabs had destroyed the state station at Stanley Falls, and it was apparent that a struggle for supremacy was inevitable. But the Free State was at that time ill prepared for a trial of strength, and at Mr Stanley's suggestion the bold course was taken of appointing Tippoo-Tib governor of Stanley Falls, as the representative of King Leopold. This was in 1887, and for five years the *modus vivendi* thus established continued in operation. During those years fortified camps were established by the Belgians on the Sankuru, the Lomami, and the Arumiwi, and the Arabs were quick to see that each year's delay increased the strength of the forces against which they would have to contend. In 1891 the imposition of an export duty on ivory excited much ill-will, and when it became known that, in his march towards the Nile, van Kerckhoven had defeated an Arab force, the Arabs on the upper Congo determined to precipitate the conflict. In May 1892 the murder of M. Hodister, the representative of a Belgian trading company, and of ten other Belgians on the upper Lomami, marked the beginning of the Arab war. When the news reached the lower river a Belgian expedition under the command of Commandant (afterwards Baron) Dhanis was making its way towards Katanga. This expedition was diverted to the east, and, after a campaign extending over several months, during which several battles were fought and the Arab strongholds of Nyangwe and Kasongo were captured, the Arab power was broken and many of the leading Arabs were killed. The political and commercial results of the victory of the Free State troops were thus described by Captain S. L. Hinde, who was Baron Dhanis's second in command:—

The War against the Arabs.

"The political geography of the upper Congo basin has been completely changed, as a result of the Belgian campaign against the Arabs. It used to be a common saying in this part of Africa that all roads lead to Nyangwe. This town, visited by Livingstone, Stanley and Cameron, until lately one of the greatest markets in Africa, has ceased to exist, and its site, when I last saw it, was occupied by a single house. Kasongo, a more recent though still larger centre, with perhaps 60,000 inhabitants, has also been swept away, and is now represented by a station of the Free State 9 m. away on the river-bank. In harmony with this political change the trade routes have been completely altered, and the traffic which used to follow the well-beaten track from Nyangwe and the Lualaba across Tanganyika to Ujiji, or round the lake to Zanzibar, now goes down the Congo to Stanley Pool and the Atlantic."²

These results had been attained largely by the aid of native levies and allies, and a number of the men who had taken part in the Arab campaign were enlisted as permanent soldiers by the Belgians. Among these were some Batetelas, who in 1895 revolted in the Lulua and Lomami districts. The mutineers were eventually defeated; but in 1897, while Baron Dhanis was making his way with a large expedition towards the Nile, the Batetelas again revolted, murdered several of their white officers, and took possession of a large area of the eastern portions of the state. Although defeated on several occasions by the Free State forces, the mutineers were not finally dispersed until near the end of 1900, when the last remnants were reported to have crossed into German territory and surrendered their arms. In other parts of the country the state had difficulties with native chiefs, several of whom preserved their autonomy. In the central Kasai region the state had been unable to make its authority good up to the time it ceased to exist.

The international position of the Free State was from the first a somewhat anomalous one. It has already been noted that the right of preference accorded to France in 1884, as interpreted in 1887, was not intended to be opposed to that of Belgium. By his will dated the 2nd of August 1889 King Leopold bequeathed to Belgium

International position.

"all our sovereign rights over the Independent State of the Congo, as they are recognized by the declarations, conventions and treaties concluded since 1884 between the foreign powers on the one side, the International Association of the Congo and

² After 1900 Nyangwe and Kasongo again became towns of some importance, and traffic along the route to Tanganyika revived with the advent of railways, though the main traffic continued down the Congo river.

the Independent State of the Congo on the other, as well as all the benefits, rights and advantages attached to that sovereignty." In July 1890 Belgium acquired, by the terms of a loan to the Congo State which was granted free of interest, the option of annexing the state on the expiry of a period of ten years and six months. Notwithstanding this loan the state became involved in further financial difficulties,¹ and on the 9th of January 1895 the Belgian government entered into a treaty with King Leopold to take over the Free State with all its possessions, claims and obligations, as from the 1st of January of that year. In anticipation of the consent of the Belgian parliament to this treaty, a Franco-Belgian convention was signed on the 5th of February 1895, by which the Belgian government recognized "the right of preference possessed by France over its Congolese possessions in case of their compulsory alienation, wholly or in part." But after long delays and a violent press campaign the ministry fell, the bill providing for annexation was withdrawn, and the chambers voted a further loan to the Free State to enable it to tide over its immediate difficulties. In 1901, on the expiry of the term of years fixed in the loan convention of 1890, the question of the annexation of the Congo State by Belgium again formed the subject of prolonged discussion. A bill was brought forward in favour of annexation, but this time it was opposed by the Belgian government, which proposed simply to let the loan run on without interest. King Leopold likewise declared himself to be opposed to immediate annexation, and the bill was withdrawn. Under the terms of the government measure, which finally passed through the Belgian parliament in August 1901, Belgium retained her right of option, though not the right to exercise it at a fixed date. Moreover, in anticipation of the time when the Congo State would become a Belgian colony, there was issued under date of 7th of August 1901 the terms of a proposed *loi organique*, regulating the government of any colonial possessions which Belgium might acquire.

The discussions which from time to time took place in the Belgian parliament on the affairs of the Congo State were greatly embittered by the charges brought against the state administration. The administration of the state had indeed undergone a complete change since the early years of its existence. A decree of the 1st of July 1885 had, it is true, declared all "vacant lands" the property of the state (*Domaine privé de l'état*), but it was not for some time that this decree was so interpreted as to confine the lands of the natives to those they lived upon or "effectively" cultivated. Their rights in the forest were not at first disputed, and the trade of the natives and of Europeans was not interfered with. But in 1891—when the wealth in rubber and ivory of vast regions had been demonstrated—a secret decree was issued (Sept. 21) reserving to the state the monopoly of ivory and rubber in the "vacant lands" constituted by the decree of 1885, and circulars were issued making the monopoly effective in the Aruwimi-Welle, Equator and Ubangi districts. The agents of the state were enjoined to supervise their collection, and in future natives were to be obliged to sell their produce to the state. By other decrees and circulars (October 30 and December 5, 1892, and August 9, 1893) the rights of the natives and of white traders were further restricted. No definition had been given by the decree of 1885 as to what constituted the "vacant lands" which became the property of the state, but the effect of the later decrees was to assign to the government an absolute proprietary right over nearly the whole country; a native could not even leave his village without a special permit.² The oppressive nature of these

The state becomes a monopolist trading concern. measures drew forth a weighty remonstrance from the leading officials, and Monsieur C. Janssen, the governor, resigned. Vigorous protests by the private trading companies were also made against this violation of the freedom of trade secured by the Berlin Act, and eventually

¹ For an account of the loans and liabilities of the state see II. The Belgian Congo, § Finance.

² The British parliamentary paper *Africa No. 1*, 1909, contains a memorandum on the land laws in the Congo State, showing the extent to which trade was monopolized throughout its territories by the government.

an arrangement was made by which certain areas were reserved to the state and certain areas to private traders, but the restrictions imposed on the natives were maintained. Large areas of the state domain were leased to companies invested with very extensive powers, including the exclusive right to exploit the produce of the soil.³ In other cases, e.g. in the district of Katanga the state entered into partnership with private companies for the exploitation of the resources of the regions concerned. The "concession" companies were first formed in 1891 under Belgian law; in 1898 some of them were reconstituted under Congo law. In all of them the state had a financial interest either as shareholder or as entitled to part profits.⁴

This system of exploitation of the country was fruitful of evil, and was mainly responsible for the bad treatment of the natives. Only in the lower Congo and a narrow strip of land on either side of the river above Stanley Pool was there any freedom of trade. The situation was aggravated by the creation in 1896, by a secret decree, of the *Domaine de la couronne*, a vast territory between the Kasai and Ruki rivers, covering about 112,000 sq. m. To administer this domain, carved out of the state lands and treated as the private property of Leopold II., a *Fondation* was organized and given a civil personality. It was not until 1902 that the existence of the *Domaine de la couronne* was officially acknowledged. The *Fondation* controlled the most valuable rubber region in the Congo, and in that region the natives appeared to be treated with the utmost severity. In the closing years of the 19th century and the early years of the 20th the charges brought against the state assumed a more and more definite character. As indicated, they fell under two main heads. In the first place the native policy of the Congo government was denounced as at variance with the humanitarian spirit which had been regarded by the powers as one of the chief motives inspiring the foundation of the Congo State. In the second place it was contended that the method of exploitation of the state lands and the concessions system nullified the free trade provisions of the Berlin Act. Reports which gave colour to these charges steadily accumulated, and gave rise to a strong agitation against the Congo State system of government. This agitation was particularly vigorous in Great Britain, and the movement entered on a new era when on the 20th of May 1903 the House of Commons agreed without a division to the following motion:—

"That the government of the Congo Free State having, at its inception, guaranteed to the powers that its native subjects should be governed with humanity, and that no trading monopoly or privilege should be permitted within its dominions, this House request His Majesty's Government to confer with the other powers, signatories of the Berlin General Act, by virtue of which the Congo Free State exists, in order that measures may be adopted to abate the evils prevalent in that state."

In accordance with this request the 5th marquis of Lansdowne, then secretary of state for foreign affairs, issued a despatch on the 8th of August 1903 to the British representatives at the courts of the powers which signed the Berlin Act, drawing attention to the alleged cases of ill-treatment of natives and to the existence of trade monopolies in the Congo Free State, and in conclusion stating that His Majesty's government would

³ This concession was asserted by traders who had previously dealt direct with the natives, and by traders who hoped so to do, to contravene the provision of the Act of Berlin prohibiting any commercial monopoly in the Congo basin. The state maintained, however, that the proprietor who exploits and sells the produce of his land is not engaging in commerce.

⁴ The best known of these companies are the *Abir* (Anglo-Belgian India-rubber and Exploration Co.) and the *Société anversoise du commerce au Congo*. In Katanga the companies holding concessions and the state are jointly represented by the *Comité spécial du Katanga*. In 1906 four new companies were formed in which British, American and French capital was largely invested. Of these companies the *Union minière du Haut Katanga* had for object the development of the mineral wealth of the district named, while the *Chemins de fer du Bas Congo* undertook to build a railway from Leopoldville to Katanga. The American Congo Company was granted a rubber concession in the Kasai basin. The fourth company, the *Société internationale forestière et minière du Congo*, combined mining operations with the exploitation of forest produce.

"be glad to receive any suggestions which the governments of the signatory powers might be disposed to make in reference to this important question, which might perhaps constitute, wholly or in part, the subject of a reference to the tribunal at the Hague." This despatch failed to evoke any response from the powers, with the single exception of Turkey, but the public agitation against the Congo State régime continued to grow in force, being greatly strengthened by the publication in February 1904 of a report by Mr Roger Casement, then British consul at Boma, on a journey which he had made through the middle Congo region in 1903 (described as the "Upper" Congo in the report). The action on the part of the British government resulted in considerable correspondence with the Congo government, which denied the charges of systematic ill-treatment of the natives and controverted the contention that its policy constituted an infringement of the Berlin Act. In July 1904, however, King Leopold issued a decree appointing a commission of inquiry to visit the Congo State, investigate the condition of the natives, and if necessary recommend reforms. The commission was composed of M. Edmond Janssens, advocate-general of the Belgian Cour de Cassation, who was appointed president; Baron Giacomo Nisco, president *ad interim* of the court of appeal at Boma; and Dr E. de Schumacher, a Swiss councillor of state and chief of the department of justice in the canton of Lucerne. Its stay in the Congo State lasted from the 5th of October 1904 to the 21st of February 1905, and during that time the commissioners ascended the Congo as far as Stanleyville.

Report of the Commission of Inquiry.

The report of the commission of inquiry was published, minus the minutes of the evidence submitted to the commissioners, in November 1905. While expressing admiration for the signs which had come under its notice of the advance of civilization in the Congo State, the commission confirmed the reports of the existence of grave abuses in the upper Congo, and recommended a series of measures which would in its opinion suffice to ameliorate the evil. It approved the concessions system in principle and regarded forced labour as the only possible means of turning to account the natural riches of the country, but recognized that though freedom of trade was formally guaranteed there was virtually no trade, properly so called, among the natives in the greater portion of the Congo State, and particularly emphasized the need for a liberal interpretation of the land laws, effective application of the law limiting the amount of labour exacted from the natives to forty hours per month, the suppression of the "sentry" system, the withdrawal from the concession companies of the right to employ compulsory measures, the regulation of military expeditions, and the freedom of the courts from administrative tutelage. Simultaneously with the report of the commission of inquiry there was published a decree appointing a commission to study the recommendations contained in the report, and to formulate detailed proposals.

Naturally the development of the charges against the Congo State system of administration was followed with close interest

Renewed movement for annexation in Belgium.

in Belgium. Little or nothing was done, however, to advance the bill brought forward in August 1901, providing for the government of the Congo State in the event of its becoming a Belgian colony. The existence of this measure was recalled in a five days' debate which took place in the Belgian parliament in the spring of 1906, when the report of the commission of inquiry and the question of the position in which Belgium stood in relation to the Congo State formed the subject of an animated and important discussion. In the resolution which was adopted on the 2nd of March the chamber, "imbued with the ideas which presided over the foundation of the Congo State and inspired the Act of Berlin," expressed its confidence in the proposals which the commission of reforms was elaborating, and decided "to proceed without delay to the examination of the projected law of the 7th of August 1901, on the government of Belgium's colonial possessions." The report of the reforms commission was not made public, but as the fruit of its deliberations King Leopold signed on the 3rd of June 1906 a number of decrees embodying various

changes in the administration of the Congo State. By the advocates of radical reforms these measures were regarded as utterly inadequate, and even in Belgium, among those friendly to the Congo State system of administration, some uneasiness was excited by a letter which was published along with the decrees, wherein King Leopold intimated that certain conditions would attach to the inheritance he had designed for Belgium. Among the obligations which he enumerated as necessarily and justly resting on his legatee was the duty of respecting the arrangements by which he had provided for the establishment of the *Domaine de la couronne* and the *Domaine privé de l'état*. It was further declared that the territories bequeathed would be inalienable.

The fears excited by this letter that King Leopold desired to restrict Belgium's liberty of action in the Congo State when the latter should become a Belgian colony were not diminished by the announcement in November 1906 of four new concessions, conferring very extensive rights on railway, mining and rubber companies in which foreign capital was largely interested. This was immediately before the opening in the Belgian chamber of a fresh debate in which the history of the Congo question entered on a new stage of critical importance not only from the national but the international point of view. It had become evident, indeed, that things could not continue as they were. In reply to an influential deputation which waited upon him on the 20th of November, Sir Edward Grey, speaking as the representative of the British government in his capacity as secretary of state for foreign affairs, expressed the desire "that Belgium should feel that her freedom of action is unfettered and unimpaired and her choice unembarrassed by anything which we have done or are likely to do"; but he added that if Belgium should fail to take action "it will be impossible for us to continue to recognize indefinitely the present state of things without a very close examination of our treaty rights and the treaty obligations of the Congo State."

The debate in the Belgian chamber opened on the 28th of November and was not concluded till the 14th of December. It was largely occupied with the consideration of the relations between Belgium and the Congo State from the constitutional point of view. A resolution was finally adopted by 128 votes to 1, thirty Socialist members abstaining from voting. In this resolution the chamber took note of "the replies of the government, according to which the declarations contained in the letter of the 3rd of June do not constitute conditions but 'solemn recommendations,' while 'the convention of cession will have no other object than to effect the transference and define the measures for its accomplishment, and the Belgian legislature will regulate the régime of its colonial possessions in unrestricted liberty.'" In conclusion the chamber, "desiring without prejudice (*sans préjuger sur le fond*) that the question of the annexation of the Congo should be brought before the chamber in the shortest possible time, in accordance with the intention expressed by the government," recorded its desire that the central committee charged to examine the draft law of the 7th of August 1901 should "hasten its labours and lay its report at an early date." (J. S. K.)

For the purpose of considering the proposed colonial law the central committee was changed into a special commission, which from the number of members constituting it became known as the Commission of XVII. The *Progress of negotiations.* The commission held its first meeting on the 31st of January 1907, and did not complete its labours until the 25th of March 1908. Taking as the basis for discussion the draft *loi organique* of 1901, it elaborated a measure laying down the principles applicable to the Congo State when it should become a Belgian colony. The draft bill of 1901 had left the autocratic power of the sovereign unchanged; the colonial bill as passed by the commission completely reversed the situation, replacing the absolutism of the king by thorough parliamentary control. This result was only achieved after a severe struggle and after an emphatic declaration by Sir E. Grey that the British government would regard any other solution as inadmissible (see *infra*).

While the commission was sitting, further evidence was forthcoming that the system complained of on the Congo remained unaltered, and that the "reforms" of June 1906 were illusory. Various revolts of the natives also occurred, and in some parts of the state complete anarchy prevailed. Not only in Great Britain and America did the agitation against the administration of the Congo State gain ground, but in Belgium and France reform associations enlightened public opinion. The government of Great Britain let it be known that its patience was not inexhaustible, while the senate of the United States declared that it would support President Roosevelt in his efforts for the amelioration of the condition of the inhabitants of the Congo. The attitude of the powers was at the same time perfectly friendly towards Belgium. In this manner the movement in favour of ending the baneful régime of Leopold II. was strengthened. On the 10th of July 1907 the Belgian premier announced that negotiations with the Congo State would be renewed, and on the 28th of November following a treaty was signed for the cession of the Congo State to Belgium. This treaty stipulated for the maintenance of the *Fondation de la couronne*. This "government within a government" was secured in all its privileges, its profits as heretofore being appropriated to allowances to members of the royal family and the maintenance and development of "works of public utility" in Belgium and the Congo, those works including schemes for the embellishment of the royal palaces and estates in Belgium and others for making Ostend "a bathing city unique in the world." The state was to have the right of redemption on terms which, had the rubber and ivory produce alone been redeemed, would have cost Belgium about £8,500,000.

Even those politicians least disposed to criticize the actions of the king protested vigorously against the provisions concerning the *Fondation*. It was recognized that the chamber would not vote the treaty of cession unless those provisions were modified. Negotiations between Leopold II. and the Belgian premier followed. While they were in progress the British government again expressed its views, and in very monitory language. They were conveyed in a passage in the king's speech at the opening of parliament on the 29th of January, and in a statement by Sir Edward Grey in the House of Commons on the 26th of February. Sir Edward Grey affirmed that the Congo State had "morally forfeited every right to international recognition," and quoted with approval Lord Cromer's statement that the Congo system was the worst he had ever seen. The foreign secretary declared, in reference to the negotiations for the transfer of the Congo to Belgium, that any semi-transfer which left the controlling power in the hands of "the present authorities" would not be considered by Great Britain as a guarantee of treaty rights. On the same day that Sir Edward Grey spoke a parliamentary paper was issued (*Africa No. 1, 1908*) containing consular reports on the state of affairs in the Congo. The most significant of these reports was from Mr W. G. Thesiger, consul at Boma, who in a memorandum on the application of the labour tax, after detailing various abuses, added, "The system which gave rise to these abuses still continues unchanged, and so long as it is unaltered the condition of the natives must remain one of veiled slavery." Eight days later (on the 5th of March) an additional act was signed in Brussels annulling the clauses in the treaty of cession concerning the *Fondation*, which was to cease to exist on the day Belgium assumed the sovereignty of the Congo and its property to be absorbed in the state domains. Leopold II., however, was able to obtain generous compensation for the surrender of the *Fondation*. Certain fragments of the domain, including an estate of 155 sq. m. in Africa, a villa at Ostend, and some land at Laeken, were kept by the king, who further retained a life interest in property on the Riviera and elsewhere. Belgium undertook at her own charges and at an estimated cost of £2,000,000 to complete "the works of embellishment" begun in Belgium with funds derived from the *Fondation* and to create a debt of £2,000,000 chargeable on the funds of the colony, which sum was to be paid to the king in fifteen annual instalments—the money, however, to be expended on objects "connected

with and beneficial to the Congo." The annuities to members of the royal family were to be continued, and other subsidies were promised. But the most important provision was the agreement of Belgium to respect the concessions granted in the lands of the *Fondation* in November 1906 to the American Congo Company and the *Compagnie forestière et minière*, companies in which the Congo State had large holdings.

Both the treaty of cession and the additional act were submitted to the Commission of XVII. That body expressed its approval of both measures. Its report on the treaty and the proposed colonial law were presented to the chamber on the 3rd of April. Neither the treaty, the additional act, nor the colonial law expressly modified the land, commercial and concessionary régime established in the Congo, but article II. of the colonial law provided that laws should be passed as soon as possible to settle the natives' rights to real property and the liberty of the individual, while the Belgian government announced its determination to fulfil scrupulously all the obligations imposed on the Congo by international conventions. Public opinion in Belgium was disturbed and anxious at the prospect of assuming responsibility for a vast, distant, and badly administered country, likely for years to be a severe financial drain upon the resources of the state. But, though those who opposed annexation formed a numerous body, all political parties were agreed that in case of annexation the excesses which had stained the record of the Free State should cease.

On the 15th of April 1908 the chamber began a general debate on the Congo question. The debate made it clear that while the Belgian people did not desire colonial possessions, annexation was the only means of escape from a situation the country found intolerable. The debate closed on the 20th of August, when the treaty of annexation, the additional act and the colonial law were all voted by substantial majorities. Amendments had been made in the colonial law giving parliament fuller control over Congo affairs and securing greater independence for the judicature. On the 9th of September following the three measures were also voted by the senate. Thus at length ended the hesitation of the legislature, fourteen years after the first annexation bill had been submitted to it. On the 14th of November the state ceased to exist, the rights of sovereignty being assumed by Belgium the next day without ceremony of any kind.¹ Administrative control in Brussels was transferred to the newly created ministry of the colonies.

II. THE BELGIAN CONGO

The colony of which Belgium became possessed in the manner narrated in the historical sketch has an area estimated at 900,000 sq. m. It is bounded W. by the Atlantic, N. by French Congo, N.E. by the Anglo-Egyptian Sudan, E. by the Uganda Protectorate, British and German East Africa, S.E. by northern Rhodesia (British), S.W. by Angola (Portuguese). The coast-line is only 25 m long. It extends north from the estuary of the Congo, the northern bank of the estuary belonging to Belgium, the southern to Portugal. The greater part of Belgian Congo lies between the parallels of 4° N. and 10° S. and 18° and 30° E.

Physical Features.—Except for its short coast-line, and for a comparatively small area on its eastern frontier, the colony lies wholly within the geographical basin of the Congo. It may roughly be divided into four zones:—(1) the small coast zone west of the Crystal Mountains, through which the Congo breaks in a succession of rapids to the Atlantic; (2) the great central zone, described below; (3) the smaller zone east of the Mitumba range (including the upper courses of some of the Congo tributaries which have forced their way through the mountains), and west of Lake Mweru and the upper course of the Luapula; and (4) an area which belongs geographically to the Nile valley. The Crystal Mountains form the western edge of the great Central African plateau and run, roughly, parallel to the coast. The

¹ The first power to recognize the transfer of the state to Belgium was Germany, which did so in January 1909.

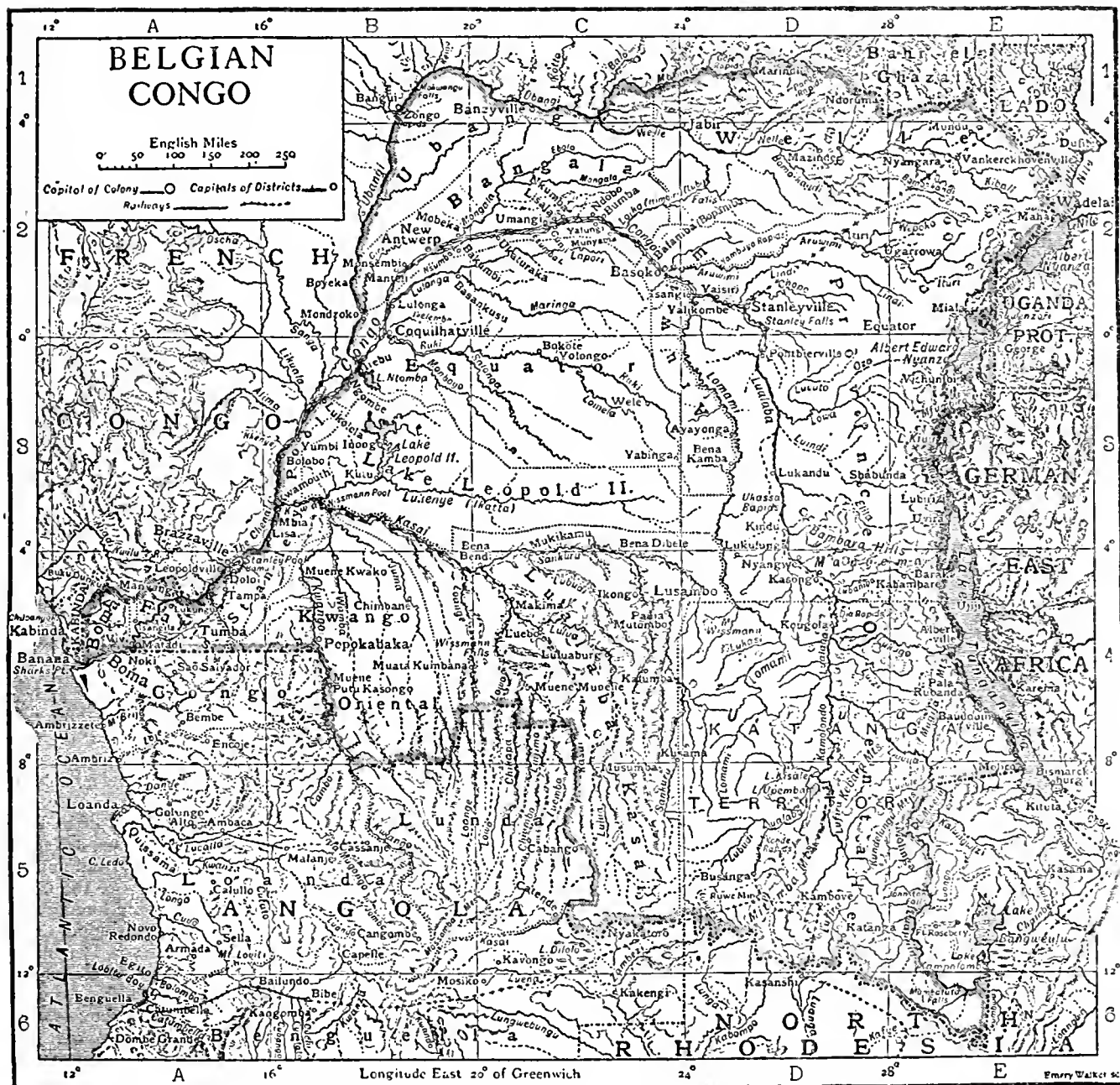

Mitumba range extends from the south-eastern frontier of the colony, in a north-easterly direction towards Lake Tanganyika, and northwards along the western shore of that lake, past lakes Kivu and Albert Edward to Albert Nyanza, forming the western edge of the western or Albertine rift-valley. This long mountain chain has numerous local names. It varies in altitude from 5000 to 10,000 ft. The eastern escarpment is precipitous, but on its western face it slopes more gently into the Congo basin. North of the Lukuga river the main chain throws out into the central zone, in a north-westerly direction, a secondary range known as the Bambara Mountains, which forms one of the boundaries of the Manyema country. The interior or lake zone is a high plateau with an average elevation of 3000 ft. above sea-level.

The central zone dips with a westerly inclination from the Mitumba Mountains towards the western edge of the plateau. It is described as "a country of alluvial plains, without any marked mountain features, very well watered, covered with forests and wooded savannahs" (A. J. Wauters). The forests occupy the river valleys and are denser in the east and north-east

of the state. In these primeval forests the vegetation is excessively rank; passage has to be forced through thick underwood and creeping plants, between giant trees, whose foliage shuts out the sun's rays; and the land teems with animal and insect life of every form and colour. Describing the forests of the Manyema country, west of Lake Tanganyika, David Livingstone wrote: "Into these [primeval forests] the sun, though vertical, cannot penetrate, excepting by sending down at mid-day thin pencils of rays into the gloom. The rain water stands for months in stagnant pools made by the feet of elephants. The climbing plants, from the size of a whipcord to that of a man-of-war's hawser, are so numerous, that the ancient path is the only passage. When one of the giant trees falls across the road, it forms a wall breast high to be climbed over, and the mass of tangled ropes brought down makes cutting a path round it a work of time which travellers never undertake." This description is equally applicable to the forest region extending eastward from the mouth of the Aruwimi almost to Albert Nyanza. This forest covers an area of some 25,000 sq. m., and into a great part of it the sunshine never enters. It is known variously as the

Pygmy Forest (from the races inhabiting it), the Aruwimi or Ituri Forest (from the rivers traversing it), the Stanley Forest (from its discoverer), or the Great Congo Forest. It is the largest fragment within the colony of the immense forest which at one time seems to have covered the whole equatorial region. By the banks of the rivers occur the "gallery" formations; *i.e.* in what appears an impenetrable forest are found avenues of trees "like the colonnades of an Egyptian temple," veiled in leafy shade, and opening "into aisles and corridors musical with many a murmuring fount" (Schweinfurth).

The Congo and its tributary streams are separately noticed. They form, both from the point of view of the physical geography and the commercial development of the colony, its most important feature; but next in importance are the forests. The wooded savannas are mostly situated on the higher lands of the central zone, where the land dips down from the Mitumba Mountains to the Congo.

The part of the colony within the Nile basin is geographically of great interest. It includes some of the volcanic peaks which, north of Lake Kivu, stretch across the rift-valley and attain heights of 13,000 and 14,000 ft.; Albert Edward Nyanza and part of the Semliki river; part of Ruwenzori (*q.v.*), the so-called "Mountains of the Moon," with snow-clad heights exceeding 16,500 ft. The colony also includes the western shores of lakes Tanganyika and Kivu (*q.v.*).

Geology.—The portion of the great basin of the Congo included in the colony is mainly occupied, so far as it has been explored, by sandstones. These are separable into a lower group (Kundelungu) of red felspathic grits and into an upper group (Lubilasch) of white friable sandstones. Both are considered to represent the Karroo formation of South Africa. The basin in which these sandstones were laid down is limited on the east by ancient gneisses and schists overlain by the highly inclined red felspathic grits. The ancient rocks of Katanga form the southern boundary. The northern periphery lies in French Congo: the western boundary is formed by a zone of Archean and metamorphic rocks and a region composed of several rock groups considered to range between the Silurian and Carboniferous periods; but it is only in the limestones of one group that fossils, indicating a Devonian age, have been found. Rocks of Cretaceous and Tertiary ages are confined to the maritime zone.

Flora.—The most valuable of the forest flora are the lianas, notably *Landolphia florida*, which yield the india-rubber of commerce. There are also timber trees such as mahogany, ebony, teak, *lignum vitae*, African cedars and planes, while oil, borassus and bamboo palms are abundant. Other trees are the redwood and camwood. Gum- and resin-yielding trees and plants (such as the acacia) are numerous. Euphorbias attain great size and orchillas are characteristic of the forest weeds. There are innumerable kinds of moss and lichens and ferns with leaves 12 ft. in length. Of the creepers, a crimson-berried variety is known as the pepper climber. Orchids and aloes are common. In the savannas are gigantic baobab trees. In the densest forests the trees, struggling through the tangle of underwood to the light, are often 150 ft. and sometimes 200 ft. in height. The undergrowth itself rises fully 15 ft. above the ground. In many districts the coffee and cotton plants are indigenous and luxuriant. Of fruit trees the banana and plantain are plentiful and of unusual size. Peculiar to the maritime zone are mangoes and the coco-nut palm. Papyrus is found by the river banks.

Fauna.—The forests are the home of several kinds of monkeys, including the chimpanzee in the Aruwimi region; the lion, leopard, wild hog, wolf, hyena, jackal, the python and other snakes, and particularly of the elephant. Among animals peculiar to the forest regions are a tiger-cat about the size of a leopard, the honey badger or black Ituri ratel and the elephant shrew. The zebra, giraffe and the rare okapi are found in the north-eastern borderlands. In the more open districts are troops of antelopes, including a variety armed with tusks, and red buffaloes. Hippopotami and crocodiles abound in the rivers, which are well stocked with many kinds of fish, including varieties resembling perch and bream; and otters make their home in the river banks. The manati is confined to the lower Congo. Bird and insect life is abundant. Among the birds, parrots (especially the grey variety) are common, as are storks and ibises. Herons, hawks, terns, Egyptian geese, fishing eagles (*Gypohierax*), the weaver and the whydah bird are found in the lower and middle Congo. Whenever the crocodile is out of the water the spur-winged plover is its invariable companion. The innumerable butterflies and dragon-flies have gorgeous colourings. White and red ants are very prevalent, as are mosquitos, centipedes, spiders and beetles.

Climate.—Situated in the equatorial zone, Belgian Congo shows, over the greater part of its area, only a slight variation of temperature all the year round. The mean annual temperature is about 90° F. From July to August the heat increases slightly, with a more rapid

rise to November. During December the thermometer remains stationary, and in January begins to rise again, reaching its maximum in February. March is also a month of great heat; in April and May the temperature falls, with a more rapid decline in June, the minimum being reached again in July. The mean temperature is lowered on the seaboard by the coast stream from the south, and the thermometer falls sometimes to little over 50° F. Again in the plateau regions in the south the night temperature is sometimes down to freezing point. There is a marked distinction between the wet and dry seasons in the western districts on the lower Congo, where rains fall regularly from October to May, the dry season being from June to September. But nearer the centre of the continent the seasons are less clearly marked by the amount of precipitation, rain falling more or less regularly at all times of the year. The seasons of greatest heat and of the heavy rains are thus coincident on the lower river, where fever is much more prevalent than on the higher plateau lands nearer the centre of the continent. The amount of the rainfall shows great variations in different years, the records at Banana showing a total fall of 16 in. in 1890-1891 and of 38 in. in 1893-1894. Even in the rainy season on the lower river the rain does not fall continuously for a long period, the storms rarely lasting more than a few hours, but frequently attaining great violence. The greatest fall registered as occurring during a single tornado was 6 in. at Bolobo. In July grass fires are of common occurrence, and frequently sweep over a great expanse of country. M. A. Lancaster, the Belgian meteorologist, formulated, as the result of a study of all the available data, the following rule:—That the rainfall increases in the Congo basin (1) in proportion as one nears the equator from the south, (2) as one passes from the coast to the interior. On the lower Congo the prevailing winds are from the west and the south-west, but this prevalence becomes less and less marked towards the interior, until on the upper river they come from the south-east. The wind, however, rarely attains any exceptional velocity. Storms of extreme violence, accompanied by torrential rain, and in rare instances by hailstones, are of not uncommon occurrence. On the coast and along the course of the lower river fogs are very rare, but in the interior early morning fogs are far from uncommon. Europeans are subject to the usual tropical diseases, and the country is not suited for European colonization. This is due more to the humidity than to the heat of the climate.

Inhabitants.—The population is variously estimated at from 14,000,000 to 30,000,000. The vast bulk of the inhabitants of the Congo basin belong to the Bantu-Negro stock, but there are found, in the great forests, sparsely distributed bands of the Pygmy people, who probably represent the aboriginal inhabitants of Central Africa (see AKKA; BAMBUTE; BAIWA; WOCHUA). In the north-east of the colony, in the upper basin of the Welle and the Mbomu, the Niam-Niam (*q.v.*) or Azandeh, a Negroid race of warriors and hunters with a social, political and military organization superior to that of the Bantu tribes of the Congo basin, have intruded from the north. They were forcing their way southwards when the Belgians appeared in the upper Congo about 1895 and arrested their further progress. Neighbours to the Azandeh are the Mangbettu and Ababwa, who are found chiefly in the country between the Welle and the Aruwimi. The Mangbettu, who formerly established a hegemony over the indigenous population, Mundu, Abisanga, Mambaré, &c., have practically disappeared as a tribe, though their language and customs still survive. The characteristics of the inhabitants of this region are well summed by Casati, who states that the Mege are considered the most skilful in elephant-hunting, the Azandeh in iron-work, the Mangbettu in wood-carving, the Abarambo in ivory-carving, and the Momfu in agriculture. Arab culture and traces of Arab blood are found in the districts where the slave traders from the east coast had established stations. This Arab influence extends, in varying degrees of intensity, over the whole eastern province, that is the region bounded east by Tanganyika, west by the Lualaba, and north by Stanley Falls and the Mangbettu country. It is mainly evident in the adoption of Arab clothing and the building of houses in Arab fashion. In the valley of the Sankuru the population has been slightly modified by Chinese influences. About 1894 a party of coolies from Macao who had been working on the railway in the cataracts region endeavoured to return home overland. They got as far as the Sankuru district, where the survivors settled and married native women.

Of the Bantu tribes several main groups may be distinguished. The lower Congo and coast regions are occupied by the Ba-Kongo (otherwise Ba-Fiot), a division including the Mushi-Kongo, found chiefly in the Congo division of Angola, and the Basundi,

who live on both banks of the river in the cataracts districts, the Kabinda and the Mayumbe—the two last named dwelling in the coast districts and foot-hills immediately north of the mouth of the Congo. A custom prevails among the coast tribes of placing their marriageable maidens on view in little bowers specially built for the purpose—the skin of the girls being stained red. The Ba-Kongo, as a whole, appear to be a degenerate race, the primitive type having been degraded by several centuries of contact with the worst forms of European civilization (see further ANGOLA: *Inhabitants*). Extending from the Kwango affluent of the Kasai to Lake Tanganyika are the Luba-Lunda groups. Of these the most widespread tribe is the Ba-Luba (*q.v.*). The next in importance, the Ba-Lunda, are mostly confined to the western half of this vast region. They have given their name to the Lunda district of Angola. From the 16th century (and possibly earlier) down to the close of the 19th century the Lunda peoples formed a more or less homogeneous state, the successive sovereigns being known as the Muata Yanvo. The Katanga, one of the Luba tribes, also founded a kingdom of some extent and power. They occupy and have given their name to the south-east part of the colony. In southern Katanga a tribe called Bassanga are cave-dwellers, as are also the Balomoto, who live in the Kundelungu hills west of Lake Mweru. Possibly connected with the Luba-Lunda group are the cannibal Manyema (*q.v.*), whose home is the district between Tanganyika and the Lualaba at Nyangwe.

Living north of the Luba-Lunda tribes, and occupying the country enclosed by the great bend of the Congo and bounded west by the Kasai, are a large number of tribes, the chief groups being the Bakuba, Basongo Mino, Balolo, Bakete, Bambala, Bayaka, Bahuana, &c. Of these the Basongo Mino are spread over the country between the Kasai and Lomami. Between the last-named river and the Lualaba dwell the savage and cannibal Batetela and Bakussu. Farther north and largely occupying the valley of the Ruki are the Mongo, a large forest tribe. Along the middle Congo from Stanley Pool to Stanley Falls the more important tribes are the Bateke, in the Stanley Pool district, but chiefly on the north side of the river in French territory; the Bayanzi (Babangi), between the mouths of the Kasai and the Ubangi; the Bangala, one of the most gifted of the Congo tribes, whence are recruited many of the soldiery; the Bapoto and the Basoko. These Bangala are not to be confused with the Bangala of the Kwango, also cannibals, who in marauding bands under leaders styled Jaga were devastating the country in the days of the early Portuguese settlements in the Congo regions. The Banza and Mogwandi are large tribes living in the region between the Congo and the Ubangi.

These Bantu races may be further divided into plain, forest and riverine tribes. With the exception of a few riverine tribes, such as the Wagenia who are fishers only, all are agriculturists and the majority keen traders, going long distances to buy and sell goods, but there are marked differences among them corresponding to their environment. The riverine tribes build excellent canoes and large "fighting" boats, and are almost uniformly expert boatmen and fishermen and live much on the water; so much so that Hermann von Wissmann and other travellers were struck by the insignificant leg development of several of these tribes. In general the physical development of these people is scarcely so great as that of the average northern European, but the majority are well formed. The most savage and truculent of the tribes are those who live in the forest regions; the most advanced in culture, the dwellers in the plains. Nearly all the tribes have tattoo markings on the face and body; to this rule the Ba-Kongo tribes are an exception. Save where the tribes have come under Arab or European influence, the clothing is extremely scanty, but absolute nudity is not known. The villages of the tribes of the lower Congo are usually surrounded by a palisade; the houses or huts are rectangular and about 7 ft. high, fetishes are usually found over the entry. The Bateke build their houses in circular groups opening on a sort of courtyard; the houses in Bangala villages are built in parallel rows about 200 ft. apart; plantations of manioc usually surround the

villages. Two varieties of culture exist among the tribes inhabiting the state: that extending over the western and central area, and that of the Welle district and eastern fringe. In the former the bow with vegetable string is the chief weapon, and clothing is woven from palm fibre; in the east spears are found, and in the Welle district swords and throwing-knives also; clothing made from skins also makes its appearance, and more attention is paid to the shades of departed ancestors.

Some tribes, notably the Ba-Luba, possess considerable skill in working in wood, ivory and metals (chiefly iron and copper). The knives, spears and shields of native workmanship frequently show both ingenuity and skill, alike in design and execution. Musical instruments of crude design are common. Over a great part of the country the natives manufacture cloth from vegetable fibre. They employ four different colours, yellow, the natural colour, black, red and brown, which are obtained by dyeing, and these colours they combine into effective designs. In some tribes a rude form of printing designs on cloth is practised, and on the Sankuru and Lukenye a special kind of cloth, with a heavy pile resembling velvet, is made by Bakuba and other tribes. In several districts the action of the state officials and the concession companies in enforcing the collection of large quantities of rubber caused the tribes to abandon their former habits and industries; on the other hand, cannibalism, formerly widely prevalent and practised by tribes with a comparatively high culture (*e.g.* the Bangala), has been largely stamped out by the rigorous measures adopted by the state. The holding of slaves, and slave-raiding by one tribe upon another, is also prohibited.

In general, each tribe is autonomous, but, as already stated, considerable kingdoms have been created by the Luba-Lunda groups, as also by the Ba-Kongo, the founders of the "Kingdom of Congo" (see ANGOLA). The Balunda "empire" of Muata Yanvo fell to pieces on the death of the chief Muteha, killed in a war with the Kioke, a Bantu tribe of the upper Kasai, in 1892. At one time this "empire" extended from the Kwango to the Lualaba.¹ The Katanga kingdom, then ruled by an Unyamwezi adventurer named Msiri, was overthrown by the Congo State in 1891. The kingdom of the Cazembe (*q.v.*), which was to the south and east of Katanga, has also vanished. Among the Bangala, each village has its chief.

Each tribe speaks a different language or dialect of Bantu, the chief groups being described in the article BANTU LANGUAGES. Swahili, a Bantu tongue with an admixture of Arabic, &c., is understood by many tribes besides those which have been under the direct influence of the Zanzibar Arabs, and it is the most general means of communication. The religion of the Congo tribes is difficult to define. Belief in a Supreme Being is vague but universal, but as this Being is good, or at least neutral, he is disregarded, and the native applies himself to the propitiation and coercion, by magical means, of the countless malignant spirits with which he imagines himself to be surrounded, and which are constantly on the watch to catch him tripping. Elaborate funeral rites, often accompanied by human sacrifice, play a most important part in native life. The idea is that the dead man shall enter the spirit world in a manner befitting his earthly rank, or he would be despised by the other spirits, and also that if proper respect were not shown to his remains, he might bring supernatural punishment on his relations. The point to be recognized is the extremely close connexion in the mind of the native between life in this world and the next, and between the mundane and the supernatural.

The European population, before 1880, consisted of a few traders, Dutch, English, French and Portuguese, having factories in the Congo estuary. By the end of 1886 the Europeans numbered 254, of whom 46 were Belgians. In January 1908 the white population had risen to 2943, 1713 being Belgians.

¹ Later on a chief named Kalambo carved out a new "empire" in the central part of the Kasai basin, his authority extending westward from the upper Sankuru into the Lunda district of Angola. He was in 1909 and for several years previously independent of the Belgians and Portuguese, and had closed the country to Europeans.

Swedes (200) and Italians (197) came next in numbers. The British numbered 145.

Towns.—There are no large towns in the European sense, but a number of government stations have been established. At none of these stations is the total population over 5000. Boma (*q.v.*) is the headquarters of the local administration and the residence of a British consul. It is situated on the right bank of the lower Congo, about 60 m. from its mouth, is one of the principal ports of call for steamers, and the centre of a considerable trade. Banana, close to the mouth of the Congo and Banana Point, possesses one of the best natural harbours on the west coast of Africa, and is capable of sheltering vessels of the largest tonnage. There are a number of European factories, some of them dating from the 16th century, and the place is the centre of a considerable commerce. Matadi is situated on the left bank of the Congo, at the highest point of the lower river which can be reached by sea-going vessels. It is the point of departure of the Congo railway. The railway company has constructed jetties at which steamers can discharge their cargo. Lukungu, situated on the banks of the river of that name, a southern tributary of the Congo, about half-way between Matadi and Stanley Pool, was formerly the capital of the Falls district, and the chief recruiting station for porters on the lower Congo. Tumba, the present capital of the district, is a station on the Congo railway, the half-way house between Matadi and Stanley Pool. It is about 117 m. from Matadi and 143 from Dolo, the terminus of the railway on Stanley Pool. Dolo is situated a short distance from the pool, and has two channels by which vessels can enter and leave the port. Quays and a slip for launching vessels have been constructed. Leopoldville is the capital of the Stanley Pool district. It is situated about 7 m. from Dolo on the flanks of Mount Leopold. Other places of importance are Luluaburg, on the Lulua river; Lusambo, the capital of the Lualaba-Kasai district, on the Sankuru river; Coquilhatville, the capital of the equatorial district, at the mouth of the Ruki; Stanleyville, the principal station of Stanley Falls district; New Antwerp, a thriving little town, the capital of the Bangala district, situated on the right bank of the Congo close to 19° E.; Banzville, the capital of the Ubangi district, on the river of that name; and Basoko, at the junction of the Aruwimi and the Congo. Jabir is the capital of the Welle district, and in the Lado Enclave (*q.v.*) on the upper Nile the principal places are Rejal, Lado and Dufle. Nyangwe, on the Lualaba, a little south of 4° S., was a large native town which, about the middle of the 19th century, came under the dominion of the Zanzibar Arabs. It was visited by David Livingstone in 1871, and from it in 1876 H. M. Stanley began his descent of the Congo. In 1892 the town was taken from the Arabs by the Congo State troops and destroyed. It has since regained considerable importance as a trading centre.

Communications.—There is a regular mail service between Antwerp and the ports of the lower Congo, which are also served by steamers from Liverpool, Hamburg, Rotterdam and Lisbon. The Congo and its affluents afford over 6000 m. of navigable waters (see CONGO). A public transport service on the rivers is maintained by the state. From its mouth to Matadi (85 m.) the Congo is navigable by ocean-going vessels. From Matadi a railway, completed in 1898 at a cost of £2,720,000, and 260 m. long, goes past the cataract region and ends at Stanley Pool, whence the Congo is navigable to Stanley Falls, a distance of 980 m. From Stanley Falls a railway runs towards the Nile. An agreement with Great Britain, concluded in May 1906, provided for the continuation of this line from the Congo State frontier through the Lado Enclave to the navigable channel of the Nile near the station of Lado, a steamboat and railway service across Africa from the Congo mouth to the Red Sea being thus arranged. Another railway (79 m. long), completed in 1906, follows the left bank of the Congo from Stanley Falls, past the rapids to Ponthierville, whence there is a navigable waterway of 300 m. to Nyangwe. From Nyangwe a railway goes towards Lake Tanganyika. Above Nyangwe, on the main stream, another railway is built around the next series of cataracts, thus opening to through communication the upper Lualaba. The total length of steam communication by this route, from Katanga to the mouth of the Congo, is about 2150 m.—1548 by water and 596 by rail. The Katanga region is also served by lines forming a continuation of the Northern Rhodesia railway system. Besides these main lines a railway (about 90 m. long), having its river terminus at Boma, serves the Mayumbe district. The principal stations are connected by telegraph lines, and, by way of Libreville in French Congo, cable communication with Europe was established in 1905. The colony is included in the Postal Union.

Agriculture.—Until the advent of Europeans the natives, except in the immediate neighbourhood of some of the Arab settlements, did little more than cultivate small patches of land close to their villages. They grew bananas, manioc, the sweet potato, the sugarcane, maize, sorghum, rice, millet, eleusine and other fruits and vegetables, as well as tobacco, but the constant state of fear in which they lived, either of their neighbours or of the Arabs, offered small inducement to industry. Nor can it be said that under their white masters the natives have become great agriculturists, though plantations have been established both by the state and private companies, and coffee, cocoa, tobacco, rice and maize are grown for

export. Of domestic animals, sheep and goats are common. Oxen have been introduced from Europe. Horses, asses and mules are comparatively rare.

Minerals.—Gold mines are worked at Kilo in the upper basin of the Ituri river, and some 30 m. W. of the Mboga district, Albert Nyanza, where gold has also been found (in British territory). The Ruwe gold mine is in the Katanga district in the south of the colony. It lies west of the Lualaba on the Mitumba range, in about 11° S., 25° 45' E. Iron is widely distributed, and worked in a primitive fashion. It has been found in the Manyanga country, the Manyema country on the upper Congo, in the Urua country, in the basins of the Kasai and the Lualaba, and in Katanga. Ironstone hills, estimated to contain millions of tons of ironstone of superior quality, have been reported in the south-eastern region. The wealth of Katanga in copper is great, the richest deposits being in the southern districts, adjacent to the Northern Rhodesia border. In this region, watered by the Lualaba, Lufira and other head-streams of the Congo, immense copper ore deposits are found in hills and spurs of rising ground extending over 150 m. east to west. Tin is found on the western edge of the Katanga copper belt and extends north along the banks of the Lualaba. Copper is also reported in other districts, such as Mpala and Uvira on Lake Tanganyika. Lead ore, tin (Ubangi basin), sulphur and mercury have been discovered.

Industries and Trade.—The principal industry is the collection of caoutchouc (see RUBBER) from the rubber vines, which exist in seemingly inexhaustible quantities. The value of the rubber exported, which in 1886 was only £6000, had risen in 1900 to £1,158,000. In 1907 the value was £1,758,000. When the state was founded elephant and hippopotamus ivory formed for some years the most important article of export. When Europeans first entered the Congo basin the natives were found to have large stores of "dead ivory" in their possession. Palm oil, palm nuts, white copal, coffee, cocoa, rice, earth-nuts and timber are next in importance among the exports. The trade of the state was of slow growth until after the completion, in 1898, of the railway between the lower and middle Congo, which greatly reduced the cost of the transport of goods. In 1887 the value of goods exported of native origin was £79,000. In 1898 it had risen to £886,000. In the following year (with the railway open) the native produce exported was valued at £1,442,000. In 1905 the total was £2,120,000. More than 75 % of the native produce, known as "special exports," go to Belgium. The neighbouring Portuguese possessions are the next best customers of the colony. Holland and Great Britain take most of the remainder of the trade. The principal imports are textiles and clothing, foods and drinks, machinery and metals, steamers and arms and ammunition. Two-thirds of the imports are from Belgium; the remainder came from Germany, Great Britain (chiefly cottons), France and Holland. It should be noted that the importation of alcohol, for the use of the natives, is prohibited. Exports greatly exceed the imports in value. Out of a total trade to the value of £3,000,000 in 1905 only £800,000 represented imports. This is due in large measure to the system of forced labour instituted by the state.

Shipping.—As with the trade the largest share of the shipping is Belgian, but it is under 50 % of the whole tonnage. The ports of entry are Banana, Boma and Matadi. In 1904 there entered and cleared these ports 205 sea-going vessels of 421,072 tons. Of the tonnage entered 193,202 was Belgian, 85,934 British, 74,536 French, and 67,400 German. In addition about 500 smaller vessels engaged in the coasting trade enter and clear from Boma and Banana every year.

Constitution.—The Free State, under King Leopold of Belgium, was organized as an absolute monarchy. Civil and criminal codes were promulgated by decrees, and in both cases the laws of Belgium were adopted as the basis of legislation, and "modified to suit the special requirements" of the state; e.g. forced labour (*prestations*) was legalized (law of the 18th of November 1903).¹ This forced labour was to be remunerated and was regarded as in the nature of a tax. Besides the *prestations*, a system of *corvées*, for public works, was enforced. The sovereign was assisted in the task of government by a secretary of state and other high officials, with headquarters at Brussels. The state was represented in Africa by a governor-general, placed at the head both of the civil and military authorities. Under Belgian rule a colonial minister replaced the former secretary of state. The minister has the advice of a colonial council, while the power of legislating for the colony is vested in parliament.

For administrative purposes the colony is divided into thirteen districts and one province, each being governed by a commissary. The districts are Banana, Boma, Matadi, Falls, Stanley Pool, Kwango Oriental, Ubangi, Lualaba-Kasai, Lake Leopold II., Equator, Aruwimi, Bangala and Welle. The region between

¹ Forced labour had, however, been authorized in 1891 and exacted in practice since the foundation of the state.

the Lomami river and the great lakes, and south of the Aruwimi and Welle districts forms the Province Orientale. It is divided into zones, of which the chief are Stanley Falls, Ponthierville, and that administered by the Katanga committee. The districts are also subdivided into zones. In 1898 the territory in the valley of the upper Nile leased from Great Britain was placed for administrative purposes under the same régime as the districts.

Judicial Machinery.—Courts of first instance have been instituted in the various districts, and there is a court of appeal at Boma which revises the decisions of the inferior tribunals. There is a further appeal in all cases where the sum in dispute exceeds a thousand pounds, to a superior council at Brussels, composed of a number of juriconsults who sit as a *cour de cassation*.

Religion and Instruction.—The religion of the native population is that commonly called fetishism (see *supra*, *Inhabitants*). The state makes no provision for their religious teaching, but by the Berlin Act missionaries of all denominations are secured perfect freedom of action. The state has established agricultural and technical colonies for lads up to the age of fourteen. These colonies make provision for the training of boys recruited from those rescued from slavery, from orphans, and from children abandoned or neglected by their parents. Practical instruction is given in various subjects, but the main object is to provide recruits for the armed force of the state, and only such lads as are unfitted to be soldiers are drafted into other occupations. Missionaries have displayed great activity on the Congo. In 1907 there were about 500 missionaries in the colony, divided in about equal proportion between Protestants and Roman Catholics. They maintain over 100 stations. The missionaries do not confine themselves to religious instruction, but have schools for ordinary and technical training. There are two Roman Catholic bishops.

Finance.—Revenue is derived from customs, direct taxes (on Europeans), transport charges, &c., and from the exploitation of the domain lands. (The prohibition of the import of alcohol deprives the state of a ready source of revenue.) Nearly all the funds required in the work of founding the Free State were provided by Leopold II. out of his privy purse, and for some time after the recognition of the state this system was continued. In the first ten years of his work on the Congo King Leopold is reported to have spent £1,200,000 from his private fortune. The first five years of the existence of the state were greatly hampered by the provision of the Berlin Act prohibiting the imposition of any duties on goods imported into the Congo region, but at the Brussels conference, 1890, a declaration was signed by the powers signatory to the Berlin Act, authorizing the imposition of import duties not exceeding 10 % *ad valorem*, except in the case of spirits, which were to be subject to a higher duty. By agreement with France and Portugal, a common tariff (6 % on most goods imported, 10 % on the export of ivory and india-rubber, 5 % on other exports) was adopted by these powers and the Congo Free State.

Funds for the administration were also obtained by loans. In July 1887 bonds bearing interest (from January 1900) at 2½ % were issued to the amount of £443,000 to represent sums advanced to the founders of the state. The bulk of these bonds (£426,000) were issued to King Leopold, but in January 1895 His Majesty cancelled the bonds in his possession. In 1888 and 1889 bearer bonds to the amount of £2,800,000 were issued out of an authorized issue of £6,000,000. The balance of the loan was issued in 1902. The bonds are redeemable in 99 years by annual drawings, and are entitled to an addition of 5 % per annum when drawn. The redemption fund is administered by a committee representing the bondholders. The Belgian government in 1890 advanced a sum of £1,000,000, and in 1895 two further sums of £211,000 and £60,000, the former to enable the state to repay a loan and so prevent the forfeiture of an immense territory which had been pledged as security to an Antwerp banker, and the latter to balance the 1895 budget. In October 1896 a loan of £60,000 was raised at 4 %, and in June 1898 a further sum of £500,000 was raised at the same rate

of interest. In October 1900 a 4 % loan of £2,000,000 was issued for the purpose of public works, including railways, and in February 1904 a decree was issued authorizing the creation of bonds to bearer for £1,200,000, at 3 %. From 1890 to 1900 King Leopold is stated to have made a grant of £40,000 per annum from his private purse to the public funds. In 1901 Belgium renounced the repayment of its loans and the payment of interest, reserving the right to annex the state, whose financial obligations to Belgium would revive only if that kingdom should renounce its rights to annex the Congo. In 1886 the total revenue of the country was under £3000, derived from the state domains. The revenue from this source, obtained almost entirely from rubber and ivory, had risen in 1891 to £52,000, in 1896 to £235,000, in 1900 to £448,000, and in 1905 to £660,000. These figures do not, however, disclose the total profits which accrued to the Free State from its trading operations in the Congo. Official returns placed the public expenditure at a higher figure than the revenue. The totals given for 1905 were: revenue, £1,197,466; expenditure, £1,392,026. The monetary system is based on the gold standard, and the coinage is the same as that of the Latin union. On the lower Congo transactions are in cash, but on the middle and upper Congo the use of coins in place of barter or the native brass wire currency makes but slow progress. Moreover, save in the lower Congo state payments (down to 1908) were made in trade goods.

Defence.—The army consists of African troops officered by Europeans. Some of the men are recruited from the neighbouring territories, but the greater part consists of locally raised levies, recruited partly by voluntary enlistment and partly by the enforced enlistment of a certain number of men in each district, who are selected by the commissary in conjunction with the local chiefs. The effective strength is about 15,000. There are over 200 European officers, and over 300 European sergeants. The term of service for volunteers does not exceed seven years, while the militiamen raised by enforced enlistment serve for five years on active service, and for two years in the reserve. The artillery includes Krupps, Maxims and Nordenfeldts. A fort has been erected at Chinkakassa near Boma, commanding the river below the Falls, and there is another fort at Kinshassa on Stanley Pool to protect Leopoldville and the railway terminus. The governor-general is commander-in-chief of the armed forces of the state, and the commissaries are in command of the military forces in their districts. In the 1891 budget the expenditure on the army was given at £90,000, and by 1900 it had risen to £312,000. In 1905 the charge fell to £221,241.

BIBLIOGRAPHY.—(1) *Official: Protocols and General Act of the West African Conference* (London, 1885). (Annex 1 to Protocol 9 contains copies of the treaties by which the International Assn. of the Congo obtained the recognition of the European governments.) *Documents diplomatiques: Affaires du Congo, 1884-1895* (Paris, 1895) (a French "Yellow Book"). *L'État indépendant du Congo à l'exposition de Bruxelles* (Brussels, 1897). *Bulletin officiel de l'état indépendant du Congo* (Brussels, 1885-1908) (published monthly, and replaced, November 1908, by the *Bulletin officiel du Congo belge*). *Documents concernant le Congo, imprimés par ordre de la chambre des représentants de Belgique (1891-1895)*. *Exposé des motifs du projet de loi approuvant l'annexion du Congo à la Belgique (documents parlementaires, No. 91)* (Brussels, 1895). *Annales du musée du Congo* (flora, fauna, ethnography, &c.) (Brussels, 1898 et seq.). *Despatch . . . in regard to alleged ill-treatment of natives and to the existence of trade monopolies in the . . . Congo* (London, 1903). *Correspondence and report from His Majesty's consul at Boma respecting the administration of the . . . Congo* (London, 1904) contains a lengthy report from Mr Roger Casement, the British consul, condemning in several respects the treatment of natives by the state). Further correspondence respecting the administration of the state is contained in the white papers *Africa*, No. 1 of 1905, 1906, 1907, Nos. 1 and 2 of 1908 and No. 1 of 1909. *Rapport de la commission d'enquête dans les territoires de l'état* (Brussels, Nos. 9 and 10 of the *Bulletin officiel* for 1905; a voluminous document; the tenor of the report is indicated in the section *History*). O. Louwers, *Lois en vigueur dans l'état indépendant du Congo* (Brussels, 1905).

(2) *Non-official: Le Mouvement géographique*, a weekly magazine, founded in 1884 by A. J. Wauters, and devoted chiefly to Congo affairs. A *Bibliographie du Congo, 1880-1895* (a list of 3800 books, pamphlets, maps and notices), compiled by A. J. Wauters and A. Buyl, was published at Brussels in 1895. The most important books in this bibliography are *The Congo and Founding of its Free State*, by (Sir) H. M. Stanley (London, 1885), and *Le Congo, historique, diplomatique, physique, politique, économique, humanitaire et coloniale*, by A. Chapaux (Brussels, 1894). Stanley's book is of historic importance, describing the work he and his helpers accomplished on the Congo between 1879 and 1884; and Chapaux's volume gives the

best general account of the Free State in convenient size. The history section includes a valuable summary of the work of exploration in the Congo basin from the days of David Livingstone up to 1893. *L'État indépendant du Congo*, by A. J. Wauters (Brussels, 1899), is a book of similar character to that of Chapaux. Both Chapaux and Wauters deal with ethnology and zoology. Sir H. H. Johnston, *George Grenfell and the Congo* . . . (2 vols., London, 1908), largely geographical, historical, anthropological and philological studies based on the work of Grenfell. For geology see J. Cornet, "Observations sur la géologie du Congo occidental," *Bull. soc. géol. belg.* vols. x. and xi. (1896-1897); *ibid.* "Les Formations post-primaires du bassin du Congo," *Ann. soc. géol. belg.* vol. xxi. (1893-1894); G. F. J. Preumont, "Notes on the Geological Aspect of some of the North-Eastern Territories of the Congo Free State," *Quart. Journ. Geol. Soc.* vol. lxi. (1905). The economic aspect of the colony is dealt with in *Congo, climat, constitution du sol et hygiène* . . . by Bourguignon and five others (Brussels, 1898). *The Fall of the Congo Arabs*, by S. L. Hinde (London, 1897), is an account of the campaigns of 1892-1893 by an English surgeon who served as a captain in the state forces. *The Congo State*, by D. C. Boulger (London, 1898), *Droit et administration de l'état indépendant du Congo*, by F. Cattier (of Brussels University) (Brussels, 1898), and *L'Afrique nouvelle*, by E. Descamps (professor of droit des gens at Louvain University) (Paris, 1903), are treatises covering all branches of the state's activity, from the standpoint of admirers of the work of Leopold II., in Africa. Professor Cattier in a later work, *Étude sur la situation de l'état indépendant du Congo* (Brussels, 1906), severely criticized the Congo administration. Other indictments of Congo State methods are contained in *La Question congolaise*, by A. Vermeersch (Brussels, 1906); *Il Congo* (Rome, 1908), by Captain Baccari; *Civilization in Congoland*, by H. R. Fox Bourne (London, 1903); and *King Leopold's Rule in Africa* (London, 1904); *Red Rubber* (London, 1906); and *A Memorial on Native Rights in the Land* . . . (London, 1909), by E. D. Morel. *Ten Years in Equatoria*, by Major G. Casati (London, 1891), contains much information concerning the peoples, zoology, &c., of the north-eastern parts of the state. (F. R. C.)

CONGREGATION (Lat. *congregatio*, a gathering together, from *cum*, with, *gregis*, *gregis*, a flock, herd), an assembly of persons, especially a body of such persons gathered together for religious worship, or the body of persons habitually attending a particular church, hence the basis of that system of religious organization known as Congregationalism (*q.v.*). Apart from these, the more general meanings of the word, "congregation" is used in the English versions of the Old and New Testaments to translate the Hebrew words 'ēdāh and kāhāl, the whole community of the Israelites and the assembly of the people. The words "assembly" and "congregation" have been to a certain extent distinguished in the Revised Version, "congregation" being kept for 'ēdāh and "assembly" for kāhāl. The Septuagint generally translates the first by συναγωγή, the second by ἐκκλησία (see J. H. Selbie, in *Hastings's Dict. of Bible*, *s.v.* "Congregation," cf. "Assembly," *ib.*). In the Roman Church "congregation" is applied to the committees of cardinals into whose hands the administration of the various departments of the church is given (see CURIA ROMANA). The committees of bishops who regulate the business at a general council of the church are also known as "congregations." In the Roman Church there are several kinds of associations for religious purposes known by the generic name of "congregation"; such are: (1) those branches of a particular order, which, for the stricter practice of the rules of their order, group themselves together under a special form of government and discipline,—thus the Trappists are a congregation of the Cistercians, the monks of Cluny and St Maur are congregations of the Benedictines; (2) communities of religious under a common rule; persons belonging to such communities have either taken no vows, or have not taken "solemn" vows; of the many congregations of this class may be mentioned the Oratorians, the Oblates and the Lazarists; (3) in France religious associations of the laity, male or female, joined together for some religious, charitable or educational purpose (see FRANCE: *Law and Institutions*). Lastly "congregation" in secular usage is applied to two governing bodies at the university of Oxford, viz. the "Ancient House of Congregation," in whom lies the granting and conferring of degrees, consisting of the vice-chancellor, proctors and "regent masters," and secondly the "Congregation of the University of Oxford," created by the University of Oxford Act 1854, and consisting of all members of convocation who are "resident,"

i.e. have passed 141 nights within 2 m. of Carfax during the preceding year. All statutes must be passed by this congregation before introduction in convocation, and it alone has the power of amending statutes (see OXFORD). At Cambridge University congregation is the term used of the meeting of the senate. In Scottish history, from the fact that the word occurs, in the sense of "church," frequently in the national covenant of 1537, the name of "congregation" was used of the Reformers. Generally and similarly the title of "lords of the congregation" was given to the signatories of the covenant.

CONGREGATIONALISM, the name given to that type of church organization in which the autonomy of the local church, or body of persons wont to assemble in Christian fellowship, is fundamental. Varied as are the forms which this idea has assumed under varying conditions of time and place, it remains distinctive enough to constitute one of the three main types of ecclesiastical polity, the others being Episcopacy and Presbyterianism. Episcopacy in the proper sense, *i.e.* diocesan Episcopacy, represents the principle of official rule in a monarchical form: Presbyterianism stands for the rule of an official aristocracy, exercising collective control through an ascending series of ecclesiastical courts. In contrast to both of these, which in different ways express the principle of clerical or official authority, Congregationalism represents the principle of democracy in religion. It regards church authority as inhering, according to the very genius of the Gospel, in each local body of believers, as a miniature realization of the whole Church, which can itself have only an ideal corporate being on earth. But while in practice it is religious democracy, in theory it claims to be the most immediate form of theocracy, God Himself being regarded as ruling His people directly through Christ as Head of the Church, whether Catholic or local. So viewed, Congregationalism is essentially a "high church" theory, as distinct from a high clerical one. It springs from the religious principle that each body of believers in actual church-fellowship must be free of all external human control, in order the more fully to obey the will of God as conveyed to conscience by His Spirit. Here responsibility and privilege are correlatives. This, the negative aspect of the congregational idea, has emerged at certain stages of its history as Independency. Its positive side, with its sense of the wider fellowship of "the Brotherhood" (1 Pet. v. 9, cf. ii. 17), has expressed itself in varying degrees at different times, according as conditions were favourable or the reverse. But catholicity of feeling is inherent in the congregational idea of the church, inasmuch as it knows no valid use of the term intermediate between the local unit of habitual Christian fellowship and the church universal. On such a theory confusion between full Catholicity and loyalty to some partial expression of it is minimized, and the feeling for Christians as such, everywhere and under whatever name, is kept pure.

The Congregationalism of the Apostolic Church was, to begin with, part of its heritage from Judaism. In the record of Christ's own teaching the term "church" occurs only twice, once in the universal sense, as the true or Messianic "Israel of God" (Matt. xvi. 18, cf. Gal. vi. 16), and once in the local sense corresponding to the Jewish synagogue (Matt. xviii. 17). As Christianity passed to Gentile soil, the sovereign assembly (*ecclesia*) of privileged citizens in each Greek city furnished an analogy to the latter usage. These, the two senses recognized by Congregationalism, remained the only ones known to primitive Christianity. Writing of the unity of the church as set forth by Paul in Ephesians, Dr Hort (*The Christian Ecclesia*, p. 168) says: "Not a word in the epistle exhibits the One Ecclesia as made up of many Ecclesiae. To each local Ecclesia St Paul has ascribed a corresponding unity of its own; each is a body of Christ and a sanctuary of God: but there is no grouping of them into partial wholes or into one great whole. The members which make up the One Ecclesia are not communities but individual men. The One Ecclesia includes all members of all partial Ecclesiae; but its relations to them all are direct, not mediate. It is true that . . . St Paul anxiously promoted friendly intercourse and sympathy

*Primitive
Congrega-
tionalism.*

between the scattered Ecclesiae; but the unity of the universal Ecclesia as he contemplated it does not belong to this region: it is a bulk of theology and religion, not a fact of what we call ecclesiastical politics."

Organization corresponded to the life distinctive of the new Ecclesia. This was one of essential equality among "the saints" or "the brethren," turning on common possession of and by the one Spirit of Christ. "The whole congregation of the faithful was responsible for the whole life of the church—for its faith, its worship, and its discipline" (Dale). All alike were "priests unto God" in Christ (Apoc. i. 6; 1 Pet. ii. 9) and entrusted with prerogatives of moral jurisdiction (1 Cor. vi. 1 ff.). "The Ecclesia itself, *i.e.* apparently the sum of all its male adult members, is the primary body, and, it would seem, even the primary authority." So says Dr Hort (p. 229), adding that "the very origin and fundamental nature of the Ecclesia as a community of disciples renders it impossible that the principle should rightly become obsolete." In the Apostolic age local office was determined, on the one hand, by the divine gifts (*charisms*) manifesting themselves in certain persons (1 Cor. xii.; Rom. xii. 3 ff.); and on the other by the recognition of such gifts by the inspired common consciousness of each Ecclesia (1 Cor. xvi. 15-18; 1 Thess. v. 12 ff.). In most cases this took formal effect in a setting-apart by prayer, sometimes with laying-on of hands. Such consecration, however, whatever its form, was a function of the local Ecclesia as a whole, acting through those of its members most fitted by gift or standing to be its representatives on the occasion. As to the specific officers thus called into being, whether for supervision or relief (1 Cor. xii. 28), the New Testament knows none in the local church superior to elders, the ruling order in Judaism also. "Bishop" (overseer) was "mainly, if not always, *not* a title, but a description of the elder's function" (Hort, p. 232). Each church at first had at its head not a single chief pastor, but a plurality of elders (=bishops) acting as a college.

In course of time there emerged from this presbyterial body a *primus inter pares*, *i.e.* a permanent leader, to whom henceforth the description "bishop" tended to be restricted. This is the "monarchical episcopate" which first meets us in the letters of Ignatius, early in the 2nd century (see CHURCH HISTORY). But whatever its exact attributes, as he conceived it, it was still strictly a congregational office. Each normal church had its own bishop or pastor, as well as its presbytery and body of deacons. "One city, one church ('parish' in the ancient sense) with its bishop," was the rule.¹ Hence "if we are to give a name to these primitive communities with their bishops, 'congregational' will describe them better than 'diocesan'" (Sanday, *Expositor*, III. viii. p. 333). Nor did this state of things change so soon as is often supposed. It persisted in the main during the 2nd and 3rd centuries, and only faded before the growing influence of metropolitan or diocesan bishops in the 4th century. These, the bishops in the first instance of provincial capitals, gradually acquired a control over their episcopal brethren in lesser cities, analogous to that of the civil governor over other provincial officials. Indeed the development of the whole hierarchy above the congregational bishop was largely influenced by the imperial system, especially after Church and State came into alliance under Constantine.

This sacrifice of local autonomy was in a measure prepared for by an earlier centralizing movement proper to the churches themselves, whereby those in certain areas met in conference or "synod" to formulate a common policy on local problems. Such inter-church meetings cannot be traced back beyond the latter half of the 2nd century, and were purely *ad hoc* and informal, called to consider specific questions like Montanism and Easter observance. Nor were they at first confined to church officers, much less to bishops, but included "the faithful" of all sorts (Euseb. *Hist. Eccl.* v. 16, p. 10), and were in fact "councils composed of whole churches" (*ex universis ecclesiis*), where

¹ An ancient city generally included a district around it, dwellers in which would go ecclesiastically, as well as politically, with those living within the city proper.

there was a true "representation of the whole Christian name" (Tert. *De Jejun.* 13). In a word, they were "councils of churches" (*id. De Pud.* 10) and not merely of church officers. Naturally, however, as the areas represented increased, the more indirect and partial became the representation possible. Thus far, however, synods were still compatible with local autonomy and so with Congregationalism. But as the idea that bishops were successors of the apostles came to prevail, presbyters, though sharing in the deliberations, gradually ceased to share in the voting; while synods insensibly acquired more and more coercive control over the churches of the area represented. Yet the momentous change which finally crushed out Congregationalism, by substitution of legal coercion for moral suasion as the final means of securing unity, came relatively late in the history of the ancient Catholic Church.

The seat of authority in Discipline, the means by which the church strives to preserve the Christian standard of living from serious dishonour in its own members, is the touch-stone of church politics. The local Ecclesia in the Apostolic age was itself responsible for the conduct of its members (1 Cor. vi. 1 ff. and the Epistles *passim*). "If a man will not hear the church," when the local church-meeting utters the mind of Christ on a moral issue, he has rejected the final court of appeal and is *ipso facto* self-excommunicate (Matt. xviii. 17). This remains the working rule of ante-Nicene Christianity.² Indeed Cyprian plainly lays it down that the church members must withdraw from sinful officers, since "the people itself in the main has power either of choosing worthy priests (bishops) or of refusing unworthy ones" (*Ep.* 67: 3).

On the whole, then, Congregationalism, the self-government of each local church, prevailed for the most part during the first two and a half centuries of Christianity, and with it a church life which, with all its developments of ministry and ritual, remained fundamentally popular in basis (cf. T. M. Lindsay, *The Church and the Ministry in the Early Centuries*, p. 259 and *passim*). The central idea was the sanctity of the church-members as such, rather than of the ministry as a clerical order. This is implied in the oldest ordination rules and forms of prayer, such as those underlying the "Canons of Hippolytus" and related collections. It is also implied in the congregational form and spirit of the earliest liturgies; but most of all in the discipline of the church before Constantine. But from the time of Cyprian (A.D. 250) the idea of the ministry as clergy or priesthood gained ground, parallel with the more mixed quality of those admitted by baptism to the status of "the faithful," and with the increasingly sacramental conception of the means of grace.

In both respects the reflex action of the Novatianist and Donatist controversies upon Catholicism was disastrous to the earlier idea of church-fellowship. Formal and technical tests of membership, such as the reception of sacraments from a duly authorized clergy, came to replace Christ's own test of character. The church ceased even to be thought of as a society of "saints," or to be organized on that basis. The gulf between the "laity" and "clergy" went on widening during the 5th and 6th centuries; and the people, stripped of their old prerogatives (save in form here and there), passed into a spiritual pupillage which was one distinctive note of the medieval Church. In such a Catholic atmosphere Congregationalism could have no being, save among little groups of men who protested against the existing order. These, in proportion as they revived a primitive type of piety, tended to recover also some of its forms of organization. "They bore witness to the loss of the true idea of the Christian church," though they did not avail to restore it. Still, a good deal of semi-congregationalism probably did exist in obscure circles which precluded the wider Reformation and were merged in it. So was it among the Waldenses, who reasserted the priesthood of all believers: still more among the Lollards,³ who produced

² So not only the *Didachē* (xv. 3, cf. xiv. 1, 2), but also Tertullian (*Apol.* ch. 39), and even Cyprian and the 4th-century *Apostolic Constitutions* (ii. 47), as well as the *Didascalica*, its 3rd-century basis.

³ G. M. Trevelyan, *England in the Age of Wycliffe* (1899); W. H. Summers, *Our Lollard Ancestors* (1906), pp. 51, 92, 109 ff.

a "conventicle" type of Christian fellowship, supplementary to attendance at the parish church. This, while far short of theoretic Congregationalism, was a prophecy of it.

Congregationalism proper, as a theory of the organized Christian life contemplated in the New Testament, re-emerges only at the Reformation, with its wide recovery of such aspects of evangelic experience as acceptance with God and constant access to Him through the sole mediation of Christ. The practical corollary of this, "the Priesthood of Believers," though grasped by Luther (cf. Lindsay, *Hist. of the Reformation*, i. 435 ff.) and continental reformers generally, was not fully carried out by them in church organization. This was due partly to a sense that only here and there was there a body of believers ripe for the congregational form of church-fellowship, which Luther himself regarded as the New Testament ideal (Dale, pp. 40-43), partly to fear of Anabaptism, the radical wing of the Reformation movement, which first strove to recover primitive Christianity apart altogether from traditional forms. In certain Anabaptist circles the primitive idea of a "covenant" between believers and God as conditioning all their life, especially one with another, was revived (Champlin Burrage, *The Church-Covenant Idea*, Philadelphia, 1904). Their local church life, as moulded by this idea (found even in the church constitution adopted by Hesse in 1526), was congregational in type. But Anabaptism was not to remain an abiding force on the continent; and though colonies of its exiles settled in England, they did not produce the Congregationalism which sprang up there under Elizabeth. This was continuous rather with the Lollard type of secret congregation existing in various places, especially in London and the adjacent counties, at the opening of the 16th century and later (e.g. the "Known Men" at Amersham and elsewhere, Dale, pp. 58 f. 61). Already in 1550 Strype refers to certain "sectaries" in Essex and Kent, as "the first that made separation from the Reformed Church of England, having gathered congregations of their own." Then, during Mary's reign, secret congregations met under the leadership of Protestant clergy, and, when these were lacking, even of laymen. But these "private assemblies of the professors in these hard times," as Strype calls them, were congregational simply by accident. On Elizabeth's accession they ceased to assemble, until it was plain that she did not intend a radical reformation. Then only did some of their members resume secret assembly, with a more definite view to conformity in all things to the New Testament type and that alone.

Still, the development of congregational churches proper was gradual, the result of constant study of "the Word of God" in the light of experience. The process can be traced most clearly in London.¹ There, owing to measures taken in 1565-1566 to enforce clerical subscription to the authorized order of worship, especially touching vestments, certain persons of humble station began to assemble in houses "for preaching and ministering the sacraments" (Grindal's *Remains*, lxi.). This led in June 1567 to the arrest of some fifteen out of a hundred men and women met in Plumbers' Hall (ostensibly for a wedding), none of whom, to judge from the eight examined, was a minister. Probably they were not long kept in prison, for six of them were among a similar body of 77 persons "found together" in a private house on March 4, 1568, the leaders of whom were imprisoned, and liberated only after "one whole year," early in May 1569 (*ibid.* pp. 316 ff.). Perhaps it was between 1567 and 1568 that they began to organize themselves more fully in conjunction with four or five of the suspended clergy, with elders and deacons of their own appointing (Grindal, *Zürich Letters*, lxxxii.; *Remains*,

¹ Here in 1561 appeared *A Confession of faith, made by common consent of divers reformed Churches beyond the seas; with an Exhortation to the Reformation of the Church*. It advocated "the polity that our Saviour Jesus Christ hath established," with "pastors, superintendes, deacons"; so that "all true pastors have equal power and authority . . . and for this cause, that no church ought to pretend any rule or lordship over other"; and none ought "to thrust himself into the government of the Church [as by ordination at large], but that it ought to be done by election." See Burrage, *The Church-Covenant Idea*, p. 43.

lxi.). This act of ordaining ministers, probably after the Geneva order—which they certainly used from May 1568—and their excommunication of certain deserters from their "church" (so Grindal), clearly mark the fact that this body of some 200 persons had now deliberately taken up a position outside the national church, as being themselves a "church" in a truer sense than any parish church, inasmuch as they conformed to the primitive pattern. Their ideal is embodied in a manifesto set forth about 1570 under the title *The True Marks of Christ's Church, &c.*, and signed by "Richard Fytz, Minister," as being "the order of the Privy Church in London, which by the malice of Satan is falsely slandered."

"The minds of them that by the strength and working of the Almighty, our Lord Jesus Christ, have set their hands and hearts to the pure, unmingled and sincere worshipping of God, according to his blessed and glorious Word in all things, only abolishing and abhorring all traditions and inventions of man whatsoever, in the same Religion and Service of our Lord God, knowing this always, that the true and afflicted Church of our Lord and Saviour Jesus Christ either hath, or else ever more continually under the cross striveth for to have,

"First and foremost, the Glorious word and Evangel preached, not in bondage and subjection [i.e. by episcopal licence], but freely and purely.

"Secondly, to have the Sacraments ministered purely, only and altogether according to the institution and good worde of the Lord Jesus, without any tradition or invention of man.

"And last of all, to have not the filthy Canon law, but discipline only and altogether agreeable to the same heavenly and almighty worde of our good Lord, Jesus Christ."

Here we have essential Congregationalism, formulated for the first time in England as the original and genuine Christian polity, and as such binding on those loyal to the Head of the Church. All turns, as we see from the petition addressed in 1571 to the queen by twenty-seven persons (the majority women, possibly wives in some cases of men in prison), upon the duty of separation with a view to purity of Christian fellowship (2 Cor. vi. 17 f.), and upon moral discipline "by the strength and sure warrant of the Lord's good word, as in Matt. xviii. 15-18 (1 Cor. v.)" were it only in a church of "two or three" gathered in the Name. Whatever may be thought of their application of these principles, there is no mistaking the deeply religious aim of these separatists for conscience' sake, viz. the realizing of the Christian ideal in personal conduct, in a fellowship of souls alike devoted to the Highest; nor can it be doubted that the "mingled" communion of the parish churches made church "fellowship" in the apostolic sense a practical impossibility. This was confessed alike by the bishops (e.g. Whitgift) and by the Puritans, who maintained the paramount duty of remaining within the queen's church and there working for the further reformation which they recognized as sadly needed by English religion. But the radical "Puritans" (the above documents in the State Paper Office are endorsed "Bishop of London: Puritans") felt that this meant treason to the Headship of Christ in His Church; and that until the prince should set aside "the superstition and commandments of men," and "send forth princes and ministers [like another Josiah], and give them the Book of the Lord, that they may bring home the people of God to the purity and truth of the apostolic Church," they could do no other than themselves live after that divine ideal. They were not separated of their own choice, but by the word of God acting on their consciences.

"Reformation without tarrying for Anie" was the burden laid on the heart of the Congregational pioneers in 1567-1571; and it continued to press heavily on many, both "Separatists" and conforming "Puritans" (to use the nicknames used by foes), before it became written theory in Robert Browne's work under that title, published at Middelburg in Holland in 1582 (see BROWNE, ROBERT). The story of the many attempts made in the interval by "forward" or advanced Puritans to secure vital religious fellowship within the queen's Church, and of the few cases in which these shaded off into practical Separatism, is still wrapped in some obscurity.² But tentative efforts within

² See, however, *The Presbyterian Movement in the reign of Queen Elizabeth, as illustrated by the Minute Book of the Dedham Classis, 1582-1589* (Camden Society, 3rd series, vol. viii., 1905).

parochial limits, by accustoming the more godly sort to feel an inner bond peculiar to themselves, prepared many for the congregational idea of the church, and on the other hand made them feel more than ever dissatisfied with the "mixed" services of the parish church. It seemed to them impossible that vital religion could be inculcated, unless there were other guarantee for ministerial fitness than episcopal licensing, unless in fact the godly in each parish had a voice in deciding whether a man was called of God to minister the Word of God (see C. Burrage, *The True Story of Robert Browne*, pp. 7, 11 f.). But this implied the gathering of the earnest "professors" in each locality into a definite body, committed to the Gospel as their law of life. Such a "gathered church" emerges as the great desideratum with Robert Browne, between 1572, when he graduated at Cambridge, and 1580-1581, when he first defined his Separatist theory. It involved for him a definite "covenant" entered into by all members of the church, with God and with God's people, to abide by Christ's laws as ruling all their conduct, individually and collectively.

It has been debated how far Browne derived this idea from Dutch Anabaptists in Norwich and elsewhere. Doubtless the "covenant" idea was most characteristic of Anabaptists. But they connected it closely with adult baptism, whereas Browne enjoined baptism for the children of those already in covenant, and in no case taught re-baptism. Thus he evidently made "the willing covenant" of conscious faith the essence of the matter, and regarded the sign or seal as secondary. Considering, then, his other differences from Anabaptist theories, and the absence of any hint to the contrary in his own autobiographical references, "it is safe to affirm that he had no conscious indebtedness to the Anabaptists" (Williston Walker, *Creeeds and Platforms of Congreg.*, New York, 1893, p. 16). If he adopted ideas then in the air, whether of Anabaptist or other origin (see p. 706, footnote 1), he did so as seeing them in Scripture.

From Browne's idea of a holy people, covenanted to walk after Christ's mind and will, all else flowed, as is set forth in his *Book which sheweth the life and manners of all true Christians*. As it may be called the primary classic of congregational theory, its leading principles must here be summarized. Hearing the word of God unto obedience being due to "the gift of His Spirit to His children," every church member is a spiritual person, with a measure of the spirit and office of King, Priest and Prophet, to be exercised directly under the supreme Headship of Christ. Thus mutual oversight and care are among the duties of the members of Christ's body; while their collective inspiration, enabling them to "try the gifts of godliness" of specially endowed fellow-members, is the divine warrant in election to church office. Thus the "authority and office" of "church governors" is not derived from the people, but from God, "by due consent and agreement of the church." Conference between sister churches for counsel is provided for; so that, while autonomous, they do not live as isolated units. Such were the leading features of Browne's Congregationalism, as a polity distinct from both Episcopacy and Presbyterianism. Any varieties in the congregational genus which emerge later on, keep within his general outlines. To this fact the very nickname "Brownists," usually given to early "Separatists" by accident, but Congregationalists in essence, is itself witness.

"The kingdom of God was not to be begun by whole parishes, but rather of the worthiest, were they never so few." This sentence from Browne's spiritual autobiography contains the root of the whole matter, and explains the title of his other chief work, also of 1582, *A Treatise of Reformation without tarrying for any, and of the wickedness of those Preachers which will not reform till the Magistrate command or compel them*. Here he, first of known English writers, sets forth a doctrine which, while falling short of the Anabaptist theory that the civil ruler has no standing in the affairs of the Church, in that religion is a matter of the individual conscience before God, yet marks a certain advance upon current views. Magistrates "have not that authority over the church as to be . . . spiritual Kings . . . but only to rule the commonwealth in all outward justice. . . . And therefore also because the Church is in a commonwealth, it is of their charge; that is, concerning the outward provision and outward justice, they are to look to it.

But to compel religion, to plant churches by power, and to force a submission to ecclesiastical government by laws and penalties, belongeth not to them . . . neither yet to the Church" (*Treatise*, &c., p. 12). Here Browne distinguishes acceptance of the covenant relation with God (religion) and the forming or "planting" of churches on the basis of God's covenant (with its laws of government), from the enforcing of the covenant voluntarily accepted, whether by church-excommunication or by civil penalties—the latter only in cases of flagrant impiety, such as idolatry, blasphemy or Sabbath-breaking. In virtue of this distinction which implied that the nation was not actually in covenant with God, he taught a relative toleration. In this he was in advance even of most Separatists, who held with Barrow¹ "that the Prince ought to compel all their subjects to the hearing of God's Word in the public exercises of the church." As, however, the prince might approve a false type of Church, in spite of what they² both assumed to be the clear teaching of Scripture, and should so far be resisted, Browne and Barrow found themselves practically in the same attitude towards the prince's religious coercion. It was part of their higher allegiance to the King of kings.

Between 1580 and 1581, when Browne formed in Norwich the first known church of this order on definite scriptural theory, and October 1585, when, being convinced that the times were not yet ripe for the realization of the perfect polity, and taking a more charitable view of the established Church, he yielded to the pressure brought to bear on him by his kinsman Lord Burghley, so far as partially to conform to parochial public worship as defined by law (see BROWNE, ROBERT), the history of Congregationalism is mainly that of Browne and of his writings. Their effect was considerable, to judge from a royal proclamation against them and those of his friend Robert Harrison, issued in June 1583. But the repression of "sectaries" was now, and onwards until the end of the reign, so severe as to prevent much action on these lines. Still Sir Walter Raleigh's rhetorical estimate of "near 20,000" Brownists existing in England in April 1593, at least means something. We hear³ of "Brownists" in London about 1585, while the London petitioners of 1592 refer to their fellows in "other gaols throughout the land"; and the *True Confession* of 1596 specifies Norwich, Gloucester, Bury St Edmunds, as well as "many other places of the land." But of organized churches we can trace none in England, until we come in 1586 to Greenwood and Barrow, the men whose devotion to a cause in which they felt the imperative call of God seems to have rallied into church-fellowship the Separatists in London, whether those of Fytz's day or those later convinced by the failure of the Puritan efforts at reform and by the writings of Browne. At what exact date this London church—which had a more or less continuous history down to and beyond 1624—was actually formed, is open to doubt. It was only in September 1592 that it elected officers, viz. a pastor (Francis Johnson), a teacher (Greenwood), two deacons and two elders. Yet as Barrow held that a church could exist prior to its ministry, this settles nothing.

In 1589 Greenwood and Barrow composed "A true Description out of the Word of God of the visible Church," which represents the ideal entertained in their circle. It was practically identical with that set forth by Browne in 1582, though they were at pains to deny personal connexion with him whom they now regarded as an apostate. "The Brownist and the Barrowist go hand in hand together." So was it said in 1602; and there is no good ground (see Powicke, pp. 105 ff., 126 f.) for distinguishing the theories of the two leaders as to the authority of

¹ See F. J. Powicke, *Henry Barrow* (1900), pp. 128 f., for his views on the topic.

² I.e. to all honest leaders in State, as well as in Church, as it was in Israel when a king like Hezekiah restored the Covenant and then set about enforcing obedience to it. The problem of interpretation of the Divine Will, especially in the case of the "papist" or traditionalist, lay beyond their vision at the time. Hence their doctrine was not really one of freedom of conscience or toleration.

³ S. Bredwell, *The Raising of the Foundations of Brownisme* (1588), p. 135. See also F. J. Powicke, "Lists of the Early Separatists," in *Cong. Hist. Soc. Transactions*, i. 146 ff.

elders. Both equally teach the supremacy of "the whole church" in all discipline, including that upon elders or officers generally, if need arise. Possibly Barrow laid more stress also on the orderly "rules of the Word" to be followed in all church actions, and so conveyed a rather different impression.

After the execution of Greenwood, Barrow and the ex-Puritan Penry (a recent recruit to Separatism), in the spring of 1593, it seemed to some that Separatism was "in effect extinguished." This was largely true for the time as regards England, thanks to the rigour of Archbishop Whitgift, aided by the new act which left deniers of the queen's power in ecclesiastical matters no option but to leave the realm. Even this hard fate the bulk of the London church was ready to endure. Gradually they resumed church-fellowship in Amsterdam, where they chose the learned Henry Ainsworth (*q.v.*) as teacher, in place of Greenwood, but elected no new pastor, as they expected Francis Johnson (1562-1618) soon to be released and to rejoin them. This he did at the end of 1597, after a vain attempt to find asylum under his country's flag¹ in Newfoundland. It was here and now that divergent ideals as to the powers of the eldership really emerged. Johnson, a man autocratic by nature, and leaning to his old Presbyterian ideals on the point, held that the church had no power to control its elders, once elected, in their exercise of discipline, much less to depose them; while Ainsworth, true to Barrow and the "old way" as he claimed, sided with those who made the church itself supreme throughout. The church divided on the issue; but neither section has further historical importance. Far otherwise was it with the church which was formed originally at Gainsborough (?1602), by "professors" trained under zealous Puritan clergy in the district where Nottinghamshire, Yorkshire and Lincolnshire meet, but which about 1606 reorganized itself for reasons of convenience into two distinct churches, meeting at Gainsborough and in Scrooby Manor House. Ere long these were forced to seek refuge, in 1607 and 1608 respectively, at Amsterdam, whence the Scrooby church moved to Leiden in 1609 (Bradford's *History of Plymouth Plantation*, chs. 1-3). The permanent issues of the Gainsborough-Amsterdam church are connected with the origins of the Baptist wing of Congregationalism, through John Smyth and Thomas Helwys. As for the Scrooby-Leiden church under John Robinson (*q.v.*), it was in a sense the direct parent of historical "Congregationalism" alike in England and America (see below, section *American*).

Separatism was now passing into Congregationalism,² both in sentiment and in language. The emphasis changes from protest to calm exposition. In the freer atmosphere of Holland the exiles lose the antithetical attitude, with its narrowing and exaggerative tendency, and gain breadth and balance in the assertion of their distinctive testimony. This comes out in the writings both of Robinson and of Henry Jacob, both of whom passed gradually from Puritanism to Separatism at a time when the silencing of some 300 Puritan clergy by the Canons of 1604, and the exercise of the royal supremacy under Archbishop Bancroft, brought these "brethren of the Second Separation" into closer relations with the earlier Separatists. In a work of 1610, the sequel to his *Divine Beginning and Institution of Christ's true Visible and Ministerial Church*, Jacob describes "an entire and independent³ body-politic," "endued with power immediately under and from Christ, as every proper church is and ought to be." But his claim for "independent" churches no longer denies that true Christianity exists within parish assemblies. Similarly Robinson wrote about 1620 a *Treatise of the Lawfulness of hearing of the Ministers of the Church of England* which shows a larger catholicity of feeling than his

¹ So the Amsterdam church petitioned James, on his accession, to allow them to live in their native land on the same terms as French and Dutch churches on English soil (see Walker, *op. cit.* 75 foll.).

² The abstract term dates only from the 18th century. But "congregational" (due to the rendering of *ecclesia* by "congregation" in early English Bibles) appears about 1642, to judge from the *New English Dictionary*.

³ "Independent" is not yet used technically, as it came to be about 1640.

earlier *Justification of Separation* (1610). These semi-separatists still set great store by the church-covenant, in which they bound themselves "to walk together in all God's ways and ordinances, according as He had already revealed, or should further make them known to them." But they realized that "the Lord had more truth and light yet to break forth of his Holy Word"; and this gave them an open-minded and tolerant spirit, which continued to mark the church in Plymouth Colony, as distinct from the Puritans of Massachusetts Bay. Such, then, was the type of church formed in 1616 by Henry Jacob in London. It was founded under the tolerant Archbishop George Abbot (1562-1633), and would have been content with toleration such as the French and Dutch churches in England enjoyed. But Charles I. and Archbishop Laud would make no terms with deniers of royal supremacy in religion, and in 1632 this church was persecuted.

Besides such regular churches in London and the provinces under the early Stuarts, there were also numerous "conventicles" composed of very humble folk, such as the eleven about London which Bishop Joseph Hall (1574-1656) reports in 1631, and which he states in 1640 had grown to some eighty. In these latter the earlier Brownist or even Anabaptist spirit probably prevailed. Further there was arising a new type of "Independent," to use the term now coming into use. Conjoint repression of civil and religious liberty had made thoughtful men ponder matters of church polity. The majority, indeed, even of determined opponents of personal rule in state and church favoured Presbyterianism, particularly before 1641, when Henry Burton's *Protestation Protested* brought before educated men generally the principles of Congregationalism, as distinct from Puritanism, by applying them to a matter of practical politics. But besides this telling pamphlet and the controversy which ensued, the experience of New England as to the practicability of Congregationalism, at least in that modified form known as the "New England Way," produced a growing impression, especially on parliament. Hence even before the Westminster Assembly met in July 1643, Independency could reckon among its friends men of distinction in the state, like Cromwell, Sir Harry Vane, Lord Saye and Sele; while Milton powerfully pleaded the power of Truth to take care of herself on equal terms. In the Assembly, too, its champions were fit, if few. They included Thomas Goodwin and Philip Nye, who had practised this polity during exile abroad and now strove to avert the substitution of Presbyterian uniformity for the Episcopacy which, as the ally of absolutism, had alienated its own children (see PRESBYTERIANISM). Yet the "Five Dissenting Brethren" would have failed to secure toleration even for themselves as Congregationalists—such was the dread felt by the assembly for Anabaptists, Antinomians, and other "sectaries"—had it not been for the vaguer, but widespread Independency existing in parliament and in the army. Here, then, we meet with a distinction (cf. Dale, p. 374 ff.) of moment for the Commonwealth era, between "Independency" as a principle and "Congregationalism" as an ideal of church polity. Independency, like Nonconformity, is primarily a negative term. "It simply affirms the right of any society of private persons to meet together for worship . . . without being interfered with⁴ by any external authority." Such a right may be asserted on other theories than the congregational or even the Christian. Congregationalism, however, "denotes a positive theory of the organization and powers of Christian churches," having as corollary independency of external control, whether civil or ecclesiastical. "Historically the two terms have been used interchangeably" during the last two hundred years. But under the Commonwealth many professed the one without fully accepting the other.

During the Civil War Congregationalism broadened out into reciprocal relations with the national life and history. Thenceforth "The opposite of this external Independency, admission of civil oversight even for churches enjoying internal ecclesiastical self-government, was also common, being the outcome of the traditional Puritan attitude to the state. See A. Mackennal, *The Evolution of Congregationalism* (1901), pp. 43 ff.

it involves not only the story of Nonconformity and the growth of religious liberty, but also the whole development of modern England. To sketch even in outline "The Evolution of Congregationalism" in correspondence with so complex an environment is here impossible. Only salient points can be indicated.

During the Protectorate, with its practical establishment of Presbyterians, Independents and Baptists, the position of Congregationalism was really anomalous, in so far as any of its pastors became parish ministers,¹ and so received "public maintenance" and were expected to administer the sacraments to all and sundry. But the Restoration soon changed matters, and by forcing Presbyterians and Congregationalists alike into Nonconformity, placed the former, instead of the latter, in the anomalous position. In practice they became Independents, after trying in some cases to create voluntary presbyteries, like Baxter's Associations, adopted partially in 1653-1660, in spite of repressive legislation. But though Presbyterians did not in many instances become Congregationalists also, until a later date, the two types of Puritanism were drawn closer together in the half-century after 1662. The approximation was mutual. Both had given up the strict *jure divino* theory of their polity as apostolic. The Congregationalism of the Savoy Declaration (Oct. 12, 1658), agreed on by representatives—the majority non-ministerial—from 120 churches, is one tempered by experience gained in Holland and New England, as well as in the Westminster Assembly. Hence when, after the Toleration Act of 1689, a serious attempt was made to draw the two types together on the basis of *Heads of Agreement assented to by the United Ministers in and about London, formerly called Presbyterian and Congregational*, the basis partook of both (much after the fashion of the New England Way), though on the whole it favoured Congregationalism (see Dale, pp. 474 ff.). In many trust-deeds of this date (which did not contain doctrinal clauses), and for long after, the phrase "Presbyterian or Independent" occurs. Yet the two gradually drifted apart again owing to doctrinal differences, emerging first on the Calvinistic doctrine of grace, such as broke up the joint "Merchants' Lecture" started in 1672 in Pinners' Hall, and next on Christology. In both cases the Congregationalists took the "high," the Presbyterians the "moderate" view. These specific differences revealed different religious tendencies,² the one type being more warmly Evangelical, the other more "rational" and congenial in temper with 18th-century Deism. The theological division was accentuated by the Salters' Hall Controversy (1717-1719), which, nominally touching religious liberty *versus* subscription, really involved differences as to Trinitarian doctrine. Ere long Arianism and Socinianism were general among English Presbyterians (see UNITARIANISM). Congregationalists, on the other hand, whether Independents or Baptists, remained on the whole Trinitarians, largely perhaps in virtue of their very polity, with its intimate relation between the piety of the people and that of the ministry. Yet the relation of Congregational polity to its religious ideal had already become less intimate and conscious than even half a century before: the system was held simply as one traditionally associated with a serious and unworldly piety. "Church privileges" meant to many only the sacred duty of electing their own ministry and a formal right of veto on the proposals of pastor and deacons. The fusion into one office of the functions of "elders" and "deacons" (still distinguished in the Savoy Declaration of 1658) was partly at least a symptom of the decay of the church-idea in its original fulness, a decay itself connected with the general decline in spiritual intensity which marked 18th-century religion, after the overstrain of the preceding age. Yet long before the Evangelical Revival proper,

¹ For the distinction between "Gathered" and "Re-formed" churches in this connexion, see Dale, p. 376.

² A parallel is afforded by the history of Congregationalism in Scotland, which arose early in the 19th century through the evangelistic fervour of the Haldanes in an era of "moderation"; also by the rise of the kindred Evangelical Union, shortly before the Disruption in 1843. These two movements coalesced in a single Congregational Union in 1897.

partial revivals of a warmer piety occurred in certain circles; and among the Independents in particular the new type of hymnody initiated by Isaac Watts (1707) helped not a little.

The Methodist movement touched all existing types of English religion, but none more than Congregationalism. While the "rational" Presbyterians were repelled by it as "enthusiasm," the Independents had sufficient in common with its spirit to assimilate—after some distrust of its special ways and doctrines—its passion of Christlike pity for "those out of the way," and so to take their share in the wider evangelization of the people and the Christian philanthropy which flowed from the new inspiration. For underneath obvious differences, like the Arminian theology of the Wesleys and the Presbyterian type of their organization, there was latent affinity between a "methodist society" and the original congregational idea of a church; and in practice Methodism, outside the actual control of the Wesleys, in various ways worked out into Congregationalism. (see Mackennal, *op. cit.* pp. 156 ff., Dale, pp. 583 ff.). So was it in the long run with the Countess of Huntingdon's Connexion, springing from Whitefield's Calvinistic wing of the Revival, not to mention the congregational strain in some minor Methodist churches.

But whilst Congregationalism grew thereby in numbers and in a sense of mission to all sorts and conditions of men—lack of which was one of the disabilities³ due in part to its sectarian position before the law (see Mackennal, pp. 142 ff.)—it modified not only its Calvinism but also its old church ideal⁴ in the process. During most of the next century it inclined to an individualism untempered by a sense of mystic union with God and in Him with all men (see Dale, pp. 387 ff., for an estimate of these and other changes). It lost, however, its exclusive spirit. Its pulpit, which had always been the centre of power in the churches, has for a century or more taken a wider range of influence in a succession of notable preachers. Congregationalists generally have been to the fore in attempts to apply Christian principles to matters of social, municipal, national and international importance. They have been steady friends of foreign missions in the most catholic form (supporting the London Missionary Society, founded in 1795 on an inter-denominational basis), of temperance, popular education and international peace. Their weakness as a denomination has lain latterly in their very catholicity of sympathy. Thus it was left to the Oxford Revival, with its emphasis on certain aspects of the Church idea, to help to re-awaken in many Congregationalists a due feeling for specific church-fellowship, which was the main passion with their forefathers. Another influence making in the same direction, but in a different spirit, was the Broad Church ideal represented in various forms by Thomas Erskine of Linlathen, F. W. Robertson of Brighton and F. D. Maurice. In the last of these the conception of Christ's Headship of the human race assumed a specially inspiring form. This conception, in a more definitely Biblical and Christian shape, attained forcible expression in the writings of R. W. Dale of Birmingham, the most influential Congregationalist in the closing decades of the 19th century, in whom lived afresh the high Congregationalism of the early Separatists.

Modern Congregationalism, as highly sensitive to the *Zeitgeist* and its solvent influence on dogma, shared for a time the critical and negative attitude produced by the first impact of a culture determined by the conception of development as applying to the whole realm of experience. But it has largely outgrown this, and is addressing itself to the progressive re-interpretation of Christianity, in an essentially constructive spirit. Similarly its ecclesiastical statesmen have been developing the full possibilities of its polity, to suit the demands of the time for co-ordinated effort. While its principle of congregational autonomy has been gaining ground in the more centralized systems,

³ Another disability, acutely felt by all Nonconformists, created by the act of 1662, viz. exclusion from the national centres of education, they strove earnestly to remedy by their academies, the story of which is sketched by Dale, pp. 499 ff., 559-561.

⁴ The modern use of the term "chapel" seems to date only from Methodism (Mackennal, p. 165).

whether Episcopal or Presbyterian, its own latent capacity for co-operation has been evoked by actual needs to a degree never before realized in England. Association for mutual help and counsel, contemplated in some degree in the early days, from Browne to the Savoy Declaration of 1658, but thereafter forced into abeyance, began early in the 19th century to find expression in County Unions on a voluntary basis, especially for promoting home missionary work. These in turn led on to the Congregational Union of England and Wales, formed in 1832, and consisting at first of "County and District Associations, together with any ministers and churches of the Congregational Order recognized by an Association." Later it was found that an assembly so constituted combined the incompatible functions of a council for the transaction of business and a congress for shaping or expressing common opinion: and its constitution was modified so as to secure the latter object only. But after half a century's further experience, public opinion, stimulated by growing need for common action in relation to certain practical problems of home and foreign work, proved ripe for the realization of the earlier idea in its double form. In 1904 the Union was again modified so as to embrace (1) a council of 300, representative of the county associations, to direct the business for which the Union as such is responsible, and (2) a more popular assembly, made up of the council and a large number of direct representatives of the associated churches. Association, however, remains as before voluntary, and some churches are outside the Union; nor has a resolution of the assembly more than moral authority for any of the constituent churches. As regards the "Declaration of Faith, Church Order and Discipline" adopted in 1833, and still printed in the official Year Book "for general information" as to "what is commonly believed" by members of the Union, what is characteristic is the attitude taken in the preliminary notes to "creeds and articles of religion." These are disallowed as a bond of union or test of communion, much as in the Savoy Declaration of 1658 it is said that constraint "causeth them to degenerate from the name and nature of Confessions," "into Exactions and Impositions of Faith."

Among topics which have exercised the collective mind of modern Congregationalism, and still exercise it, are church-aid and home missions, church extension in the colonies, the conditions of entry into the ministry and sustentation therein, Sunday school work, the social and economic condition of the people (issuing in social settlements and institutional churches), and, last but not least, foreign missions. Indeed the support of the London Missionary Society has come to devolve almost wholly on Congregationalists, a responsibility recognized by the Union in 1889 and again in 1904. To afford a home for the centralized activities of the Union, the Memorial Hall, Farringdon Street, London, was built on the site of the Fleet prison—soil consecrated by sacrifice for conscience under Elizabeth—and opened in 1875. There the Congregational Library, founded a generation before, is housed, as well as a publication department. A congregational hymn-book (including Watts' collection) was issued by the Union in 1836, and again in fresh forms in 1859, 1873 and 1887.

The *theological colleges* which train for the Congregational ministry have themselves an interesting history, going back to the private "academies" formed by ejected ministers. They underwent great extension owing to the Evangelical Revival, and became largely centres of evangelistic activity (Dale, p. 593 ff.). But they were burdened by the necessity of supplying literary as well as theological training, owing to the disabilities of Non-conformists at Oxford and Cambridge till 1871. Even before that, however, owing partly to the impulse given by the university of London after 1836, the standard of learning in some of the colleges had been rising; and the last generation has seen marked advance in this respect. In 1886 Spring Hill College, Birmingham, was transplanted to Oxford, where it was refounded under the title of Mansfield College, purely for the post-graduate study of theology (first principal, Dr. A. M. Fairbairn); in 1905 Cheshunt College, founded by the countess of Huntingdon, was transferred

to Cambridge, to enjoy university teaching; whilst the creation of the university of Wales, the reconstitution of London University, and the creation of Manchester University, led, between 1900 and 1905, to the affiliation to them of one or more of the other colleges. Indeed in all cases the students are now in some sort of touch with a university or university college. There are eight colleges in England, viz., besides Mansfield and Cheshunt, New and Hackney Colleges, London; Western College, Bristol; Yorkshire United College, Bradford; Lancashire Independent College, Manchester; the Congregational Institute, Nottingham. In Wales there are three (one partly Presbyterian), in Scotland one, and in the colonies three. The students number over 400.

Congregational statistics are very uncertain before 1832, when the Union began to make such matters its concern. About 1716 Daniel Neal knew of 1107 dissenting congregations, 860 Presbyterian or Independent (of which perhaps 350 were Independent), and 247 Baptist. During the 18th century, though the Independents increased at the expense of the Presbyterians, it is doubtful whether they kept pace with the increase of population, until the Evangelical Revival. In 1832 they reckoned some 800 churches, the Baptists 532. In 1907 the figures were, for Great Britain¹ as a whole: Churches, branch churches and mission stations, 4928; sittings, 1,801,447; church members, 498,953; Sunday school scholars, 729,347, with 69,575 teachers; ministers (with or without pastoral charge), 3197, together with 299 evangelists and lay pastors; lay preachers, 5603. In other parts of the British empire there are some 1045 churches and mission stations (many native), South Africa, 385; Australia, 311, and Tasmania, 49; British North America, 151; British Guiana, 50, and Jamaica, 48; New Zealand, 35; India, 15; Hongkong, 1. There are also congregational churches in Austria, Bulgaria, Holland, Norway, Portugal, Spain, Sweden and in Japan (93). Apart from these, however, and some 150,000 communicants in its foreign missions, British and American "Congregationalism" reckons more than a million and a quarter church members; while, including those known as Baptists (*q.v.*), the total amounts to several millions more.

The Union of 1832 led indirectly to two further developments. In the first place it fostered the growth of Congregationalism in British colonies. Beginnings had already been made—partly by help of the London Missionary Society—in British North America (from New England), South Africa, Australia and British Guiana. But in 1836 a Colonial Missionary Society was founded in connexion with the Union. Secondly, a medium now existed for drawing closer the bonds between English and American Congregationalists. This gradually led to the idea of "An Ecumenical Council of Congregational Churches," broached in 1874, and first realized in 1891, in the London International Council under the presidency of Dr R. W. Dale (*q.v.*). The second council met in Boston in 1899, and the third in Edinburgh in 1908. Their proceedings were issued in full, and the institution promised to take a permanent place in Congregationalism.

BIBLIOGRAPHY.—The literature bearing on the subject is given with some fulness in the appendix to R. W. Dale's *History of English Congregationalism* (1907), the most authoritative work at present available. For the ancient church the data are collected in T. M. Lindsay's *The Church and the Ministry in the early Centuries* (1902), and in papers by the present writer in the *Contemp. Review* for July 1897 and April 1902. For the modern period in particular see H. M. Dexter's *Congregationalism of the Last Three Hundred Years, as seen in its Literature* (New York, 1880), supplemented by bibliographies in the first vols. of the *Congregational Historical Society's Transactions* (1901—), themselves a growing store of fresh materials. Of the older histories Waddington's *Congregational History* in 5 vols. (1869–1880) contains abundant data; while for more detailed study reference may be made to various county histories, such as T. Coleman, *Independent Churches of Northamptonshire* (1853), T. W. Davids, *Annals of Evangelical Nonconformity in Essex* (1863), R. Halley, *Lancashire, its Puritanism and Nonconformity* (1869); G. H. Pike, *Ancient Meeting-Houses in London* (1870); J. Browne, *History of Cong. in Norfolk and Suffolk* (1877); W. Urwick, *Nonconformity in Hertfordshire* (1884); W. Densham and

¹ In Ireland the oldest existing Congregational church (at Cork) dates from 1760; but most belong to the 19th century. There are now 41 churches, attended by about 10,000 persons. The Channel Islands have 12 churches, the oldest founded in 1803.

J. Ogle, *Congr. Churches of Dorset* (1899); W. H. Summers, *History of the Berks, S. Bucks, and S. Oxon. Cong. Churches* (1905); and F. J. Powicke, *History of the Cheshire Cong. Union, 1806-1906*. The *Victorian County Histories* (Constable) may also be consulted. Important documents for Congregational Faith and Order, with historical introductions, are printed in Williston Walker's *Creeeds and Platforms of Congregationalism* (New York, 1893). A classic exposition of Congregational theory is contained in R. W. Dale's *Manual of Cong. Principles* (1884). (J. V. B.)

In America.—The history of American Congregationalism during its early years is practically that of the origin of New England. It may be said to begin with the arrival in 1620 of a small company including William Brewster, elder of the refugee church in Leiden, which founded Plymouth in the modern Massachusetts in the winter of that year. Strictly speaking the members of this colony were Separatists, *i.e.* they belonged to that small body of British Independents who "separated" from the state church under the leadership of Richard Clifton or Clyfton (d. 1616), rector of Babworth, and Brewster, a layman of Scrooby in Nottinghamshire. By the end of ten years the Plymouth colony numbered about 300. About 1628 the religious troubles in England led to the emigration of a large number of Puritans; the colony of Massachusetts Bay was founded in 1628-1630 by settlers led by John Endecott and John Winthrop, and a church on congregational lines was founded at Salem in 1629, and another soon afterwards at Boston, which became the centre of the colony. The similarity between the two colonies led to a close relationship, and considerable reinforcements continued to arrive until 1640. Certain differences in opinion on franchise questions led to the founding of the colony of Connecticut in 1634-1636 by settlers led by Thomas Hooker (d. 1647), John Haynes (d. 1654), and others, and the colony of New Haven was founded in 1637 by a small company under John Davenport (1597-1670) and Theophilus Eaton (d. 1658). In 1643 these four congregational colonies formed a confederacy with a view to their common safety.

It has been calculated that in the period 1620-1640 upwards of 22,000 Puritan emigrants (the figures have been placed as high as 50,000) sailed from British and Dutch ports. The reasons that compelled their departure determined their quality; they were all men of rigorous consciences, who loved their fatherland much, but religion more, driven from home not by mercantile necessities or ambitions, but solely by their determination to be free to worship God. They were, as Milton said, "faithful and freeborn Englishmen and good Christians constrained to forsake their dearest home, their friends, and kindred, whom nothing but the wide ocean and the savage deserts of America could hide and shelter from the fury of the bishops." Men so moved so to act could hardly be commonplace; and so among them we find characters strong and marked, with equal ability to rule and to obey, as William Bradford (1590-1657) and Brewster, Edward Winslow (1595-1655) and Miles Standish (1584-1656), John Winthrop (1588-1649) and Dr Samuel Fuller, and men so inflexible in their love of liberty and faith in man as Roger Williams and young Harry Vane. As were the people so were their ministers. Of these it is enough to name John Cotton, able both as a divine and as a statesman, potent in England by his expositions and apologies of the "New England way," potent in America for his organizing and administrative power; Thomas Hooker, famed as an exponent and apologist of the "New England way"; John Eliot, famous as the "apostle of the Indians," first of Protestant missionaries to the heathen; Richard Mather, whose influence and work were carried on by his distinguished son, and his still more distinguished grandson, Cotton Mather. The motives and circumstances of the emigrants determined their polity; they went out as churches and settled as church states. They were all Puritans, but not all Independents—indeed, at first only the men from Leiden were, and they were throughout more enlightened and tolerant than the men of the other settlements. Winthrop's company were nonconformists but not separatists, esteemed it "an honour to call the Church of England, from whence we rise, our dear mother," emigrated that they might be divided from her corruptions, not from herself. But the new conditions, backed by the special

influence of the Plymouth settlement, were too much for them; they became Independent,—first, perhaps, of necessity, then of conviction and choice. Only so could they guard their ecclesiastical and their civil liberties. These, indeed, were at first formally as well as really identical. In 1631 the general court of the Massachusetts colony resolved, "that no man shall be admitted to the freedom of this body politic, but such as are members of some of the churches within the limits of the same."

This lasted till 1664. In New Haven the same system prevailed from 1639 till 1665. Church and State, citizenship in the one and membership in the other, thus became identical, and the foundation was laid for those troubles and consequent severities that vexed and shamed the early history of Independency in New England, natural enough when all their circumstances are fairly considered, indefensible when we regard their idea of the relation of the civil power to the conscience and religion, but explicable when their church idea alone is regarded. And this latter was their own standpoint; their acts were more acts of church discipline than those of civil penalty.

The years following the settlement of the four colonies were occupied in the solution of problems in church and civil government and in the preparation for the proper training of ministers. The relation between membership of the church and membership of the civic community has been mentioned. The principal problem which divided the settlers was that known as the "Half Way Covenant," which concerned the status of the children of original church members. The difficulty was that, according to the principles held by the founders of the churches, the admission to membership of a parent involved a similar status in the case of his children; on the other hand, no adult could be admitted unless the church as a whole was convinced that he was a man of proved Christian character. A compromise was arrived at by two assemblies, the first a convention of ministers held at Boston in 1657, the second a general synod of the churches of Massachusetts in 1662. As a result of these assemblies it was decided that those who had become members in childhood simply by virtue of their parents' status could not subsequently join in the celebration of the Lord's Supper nor record votes on ecclesiastical issues, unless they should approve themselves fit; they might, however, in their turn bring their children to baptism and hand on to them the degree of membership which they themselves had received from their own parents. This classification of the members into those who were in full communion and those who belonged only to the "Half Way Covenant" was vigorously attacked by Jonathan Edwards, but it was not abolished until the early years of the 19th century.

Of far greater importance not only to Congregationalism but also to the future of the American colonies was the care taken by the settlers to provide adequate training for their ministers. As early as 1636 they founded Harvard College, and in 1701 Yale College was established. The emphasis laid by the Congregationalists on this branch of their work has been characteristic of their successors both in America and in Great Britain.

Ten years after the foundation of Harvard, missionary work among the Indians was undertaken by John Eliot and Thomas Mayhew. Eliot produced his Indian translation of the Scriptures in 1661-1663, and by about 1675 there were six Indian churches with some 4000 converts.

The enthusiasm which thus marked the early years of American Congregationalists rapidly cooled from one generation to another. It was not until 1734 that a new outburst of zeal was aroused by the "revivalist" work of Jonathan Edwards, followed in 1740-1742 by George Whitefield. This wave of enthusiasm spread from Northampton, Mass., till it swept New England. Unfortunately, however, the solid work achieved was accompanied by much superficial excitement among emotional persons for whom the so-called "Great Awakening" was merely a passing sensation. Moreover there was considerable controversy between the "Old Lights," who regarded the "revival" as positively pernicious, and the "New Lights," who approved it. Partly owing to its own faults and partly owing to the stress of political excitement which followed it, the Edwardean revival

was followed by nearly half a century of lethargy, during which the chief interest centred in the gradual growth of doctrinal controversy. Two new theological schools began to emerge from the old Calvinistic theology of the early settlers. The first owed its origin to Jonathan Edwards (the elder) and was carried on by Samuel Hopkins (1721-1803), Joseph Bellamy (1719-1790), Nathaniel Emmons (1745-1840), Jonathan Edwards (the younger) and Timothy Dwight (1752-1817). This system of thought, known as the "New England Theology," rapidly became predominant, and by the beginning of the 19th century was generally adopted. An equally important school, though numerically smaller, came into existence in eastern Massachusetts under the leadership of Charles Chauncy (1592-1672) and Jonathan Mayhew (1720-1766). During the events which led up to the Declaration of Independence this school, known as the "Liberal" school, was not prominent though the number of its adherents steadily grew. Subsequently, however, largely owing to the activity of men like William Ellery Channing, it acquired great importance. As early as 1805 it was recognized as predominant in Harvard College, and in 1815 it had become a distinct denomination under the new title "Unitarian" (see UNITARIANISM).

When the excitement caused by the Revolution had subsided, Congregationalism entered upon a new period of energy. From 1791 onwards revival work again became prominent with results which far surpassed those of the Edwardean period. The number of church members steadily increased, and activities of wider and more lasting importance were undertaken. The loss of Harvard College compelled the provision of new seminaries, and missionary work both home and foreign was vigorously carried on. The following are the seminaries founded since 1800: Andover (1808), Bangor (1816), Hartford (1834), the theological school of Oberlin College (1835), Chicago (1858), Pacific (1869; now at Berkeley, Cal.), and Atlanta (Georgia), 1901. In 1822 a special theological department was organized at Yale. Up to 1810 missionary work had been carried on at home by several local societies, but in that year the American Board of Commissioners for Foreign Missions was organized. Other societies undertook various departments of work at home: the Congregational Education Society, for assisting candidates for the ministry (1815); the American Missionary Association (1846), founded by the anti-slavery party for the conversion of the negroes, which subsequently devoted its energies to work among the Indians of the west, the negroes of the south, the Chinese of the west coast and the Eskimo in Alaska; to aid in the building of churches and mission rooms the American Congregational Union was formed in 1853 (now called the Congregational Church Building Society). To these last societies is largely due the growth of the Congregational body in the west. In the early days of this expansion Congregationalism and Presbyterianism worked hand in hand, but the so-called "Plan of Union" (1801) was successively abandoned by the Conservative Presbyterians in 1837 and by the Congregationalists through the "Albany Convention" in 1852. It was this decision which for the first time gave to Congregationalists a true feeling of denominational unity (see below).

The 19th century was a period of considerable progress for the Congregational body, and on the whole the same may be said for the first seven years of the 20th century. On the other hand, the numerical increase had not kept pace with the increase of population. The English Congregational Year Book for 1908 said, in reference to the United States: "In spite of phenomenal increase of population Congregationalism in the states, as here in London, is only marking time. If other sister churches were reporting progress, or were simply keeping abreast of the population, these facts would not be so ominous as they undoubtedly are. But we hear no good news of that kind, and gather small comfort from the mere fact that Congregational churches are holding their own as well as any of their neighbours." It must, therefore, be admitted that the great expansion which marked the first half of the 19th century has not been proportionately maintained. None the less, Congregationalism has through its

leading representatives taken an increasingly important part in the theological controversy and scholarship generally. Among the followers of Jonathan Edwards the more prominent have been N. W. Taylor (Yale) and Edwards A. Park (Andover). A new statement of the doctrine of the Atonement, proposed by Horace Bushnell (1802-1876) about 1850, provoked great controversy, but during the later years of the 19th century was widely accepted under the title of the "New Theology." It has not, however, caused a serious division within the denomination.

Congregationalism in America has thus spread from New England, its primitive home, over the West to the Pacific, but has never had more than a slight foothold in the Southern states. The remarkable junction or fusion of the Independents or "Separatists" who emigrated from Leiden to Plymouth, Massachusetts, with the Puritan Nonconformists of Massachusetts Bay, modified Independency by the introduction of positive fraternal relations among the churches. This gave rise to Congregationalism in the more proper sense of the term. Beyond the limits of New England the progress of the denomination as such was, as we have seen, a good deal hindered for a long period by the willingness of New Englanders going West either to join the Presbyterians, with whom they were substantially agreed in doctrine, or to combine with them in a mixed scheme of policy in which the Presbyterian element was uppermost. It was not until about 1850 that American Congregationalists began to draw more closely together, and to propagate in the Western states and territories their own distinctive policy. Meanwhile, without giving up the main principle of the autonomy of the local church, they have developed in various ways an active disposition to co-operate as a united religious body. This tendency to denominational union is manifest partly in the work of the various educational and missionary societies which have been enumerated, but more strikingly in the institution of the National Council, which is convened at intervals of three years, and is composed of ministers and lay delegates representing the churches. The council, like the minor advisory councils which have been from early times called together for the guidance of particular churches on occasions of special difficulty, is each time dissolved at its adjournment. It is possessed of no authority. Its function is to deliberate on subjects of common concern to the entire denomination, and to publish such opinions and counsels as a majority may see fit to send forth to the churches. The first of the National Councils (held at Boston in 1865) issued a brief statement of doctrine (the "Burial Hill Declaration"), descriptive of the religious tenets generally accepted by the denomination. Later (1883) a large committee, previously appointed, framed a more full confession of faith (the "Commission Creed"), with the same end in view. Of course neither of these creeds was in the least binding upon ministers or upon churches, except so far as in each instance they might be voluntarily adopted. The movement in the direction of union has been still further promoted by the International Councils referred to above (section on British Congregationalism *ad fin.*), in which the American Congregationalists have met the representatives of their brethren in Great Britain and its colonies having the same faith and polity. In the different states, conferences, composed likewise of representatives of the several churches and their pastors, have sprung up. These meet at stated intervals for the consideration of practical subjects of moment, and for the promotion of a religious spirit. There is a tendency, moreover, to accord to the conferences the function of determining the tests of ministerial standing in the Congregational denomination. In some of the states the licensing of preachers, which was formerly left to the voluntary associations of ministers in the different localities, has been made a function of the state conferences. At the very first, in New England, the theory was held that a minister, on ceasing to be the pastor of a particular church, falls into the rank of laymen. But the view was very soon adopted, and since has universally prevailed, that a minister in such cases still retains his clerical character. In later times the measure of authority conceded to a pastor as the shepherd of a flock has been much diminished in consequence of the gradual

development of democratic feeling in both minister and congregation. This loss of clerical prestige has been due in no small degree to the increasing habit of dispensing with a form of installation, and of substituting for a permanent pastorate, instituted with the advice and consent of a council, an engagement to serve as a minister for a fixed term of one or more years. Under this custom of "stated supplies" ordination may be granted to those whose ministry in a particular church is made and dissolved by no other process than a mutual agreement. The Congregational churches, as distinct from the churches retaining the same polity, but separated by the adoption of Unitarian opinions, have in times past professed to be Calvinists of stricter or more moderate types. But as early as 1865, Arminians were welcomed to Congregational fellowship. In the last few decades, with the spread in the community of innovations in doctrinal and critical opinions, a wider diversity of belief has come to prevail, so that "Evangelical," in the popular sense of the term, rather than "Calvinistic," is the epithet more suitable to American Congregational preachers and churches.

The *Year-Book* for 1907 reported the total number of communicants in all the states at 708,913 (in 1857, 224,732); Sunday-school scholars, 679,044 (in 1857, 195,572); churches, 5989 (in 1857, 2350); ministers, 5972 (in 1857, 2315); the amount of benevolent contributions by the churches as \$2,591,693, in addition to a total home expenditure of \$8,986,727. In the theological seminaries there were 417 students in 1907-1908, as compared with a maximum of 596 in 1891-1892, and a minimum of 181 in 1864-1865. The American Board of Commissioners for Foreign Missions reported for the year ending August 31, 1907: 579 missionaries and 4135 native workers; 580 churches with 68,000 communicants and 65,000 scholars.

See Williston Walker, *History of the Congregational Churches in the United States* (1894); A. Dunning, *The National Council Digest* (Boston, 1906).

CONGRESS (Lat. *congressus*, coming together, from *congre*; *cum*, with, and *gradus*, step), in diplomacy, a solemn assembly of sovereigns or their plenipotentiaries met together for the purpose of definitely settling international questions of common interest. In this political connotation the word first came into use in the 17th century; an isolated instance occurs in 1636, when it was applied to the meeting of delegates summoned by the pope to Cologne, to attempt to put an end to the Thirty Years' War. In 1647 the meetings of delegates for the conclusion of peace, assembled at Osnabrück and Münster, were termed a congress; and in spite of objections to it on the ground that it was "coarse and inappropriate," based on the physiological sense of the word, it continued thenceforward in use.

The adoption of the name Congress for the national legislative body in the United States (and so for other American countries) was simply a development from this usage, for the "Continental Congresses" of 1774 and 1775-1781, and the "Congress of the Confederation" (1781-1788), were, as inter-state representative deliberative bodies, analogous to international congresses, and the Congress of 1789 onwards ultimately consists of representatives of the sovereign states composing the Union; this body is, however, dealt with under UNITED STATES: *Political Institutions*. The more general analogous use of the term (Church Congress, &c.) is of modern origin.

In its international sense the term "congress" is only applied to gatherings of first-class importance, attended either by the sovereigns themselves or by their secretaries of state for foreign affairs; less important meetings, e.g. either in preparation for a congress or for the settlement of a particular question, are usually termed "conferences." The dividing line between the congress and the conference is, however, historically ill-defined; and though a congress of the first importance, e.g. that of Vienna (1814-1815), is never otherwise described, the two terms have often been used indifferently in official diplomatic correspondence even of such dignified assemblages as the meetings of sovereigns and statesmen at Aix-la-Chapelle (1818), Troppau (1820) and Laibach (1821). The individual sessions of a congress are also sometimes called conferences.

The results of the work done at various international congresses in developing a sense of the common interests of nations are dealt with under INTERNATIONAL LAW and its allied articles.

The more important congresses, e.g. Münster and Osnabrück (Westphalia) in 1648; Breda, 1667; Aix-la-Chapelle, 1668, 1748, 1818; Nijmegen, 1678; Regensburg, 1682; Ryswick, 1697; Utrecht, 1713; Tetschen, 1779; Paris, 1782, 1814, 1815; 1856; Rastadt, 1794; Amiens, 1802; Châtillon, 1814; Vienna, 1814-1815; Troppau, 1820; Laibach, 1821; Verona, 1822; Berlin, 1878, are treated under their topographical headings. The present article is concerned only with the questions of constitution and procedure.

Convocation and constituent Elements of a Congress.—Any sovereign Power has the right to issue invitations to a congress or conference. In principle, moreover, every state directly concerned in the matters to be discussed has the right to be represented. But this principle, though affirmed by the Powers at Aix-la-Chapelle in 1818, has rarely been translated into practice. At the congress of Vienna (1814-1815), the decisions of which affected every state in Europe, a committee of the five great Powers claimed and exercised the right to settle everything of importance; and this set the precedent which has been followed ever since. At the congresses of Paris and Berlin, as at that of Vienna, the great Powers regulated the affairs of lesser states without consulting the representatives of the latter. Similarly, at the conference of 1869 on the affairs of Crete no representative of Greece was present; and at the conference of London (1883), on the international regulation of the Danube, the sovereign state of Rumania, though a Danubian Power, was not represented. It was only with great difficulty that Cavour obtained admission to the congress of Paris in 1856, and the proposal of a congress in 1859 broke down on the refusal of Austria to admit the right of Sardinia to be represented. M. Pradier-Fodéré deplors the consistent breach of the "fundamental rule" in this respect; but since every sovereign state, great and small, once admitted, has an equal voice, it is difficult to see how a principle, equitable in theory, could be established in practice. The failure of the Hague conferences to arrive at any substantial results was in fact due, more than anything else, to the admission on equal terms of a crowd of very unequal Powers. It may then be laid down that all congresses and conferences that have effected settlements of importance have been summoned and dominated by Powers strong enough to enforce respect for their views.

Preliminaries.—Before a congress meets it is customary, not only to agree on the place of meeting (a question often of first-class importance) and on the Powers to whom invitations are to be sent, but to define very carefully the nature and scope of the business to be transacted. This is done sometimes by an elaborate exchange of diplomatic correspondence issuing in preliminary conventions, sometimes by the summoning of conferences, e.g. those at Vienna in 1855 preliminary to the congress of Paris in 1856.

Procedure.—When the congress assembles the first business is the verification of powers, which is done by a commission specially appointed to examine the credentials of the plenipotentiaries. It is usual for the Powers, for obvious practical reasons, to be represented by two or three plenipotentiaries. If the foreign minister himself attend, he needs no credentials; those of his colleagues are countersigned by him. The verification being completed, questions of procedure, of precedence and the like, are settled. In earlier times this was a matter of extreme difficulty and delicacy, since there was no norm by which the respective dignity of the representatives of first-class Powers could be established; an incredible amount of time was wasted in futile questions of precedence, and not seldom negotiations for a peace that every one desired broke down on a point of etiquette. All this has been obviated by the rule observed at the congress of Berlin (1878), according to which the plenipotentiaries took their seats at a horse-shoe table in the alphabetical order of the states they represented, according to the French alphabet.

The presidency of the congress is by courtesy reserved for the minister for foreign affairs of the state in which the meeting is held; if, however, he decline to serve, a president is elected;

or, if there be a mediating Power, the minister representing this presides. At the first session the president takes his seat and delivers a speech welcoming the delegates and sketching the objects of the meeting; the *bureau* of the congress (secretary, assistant secretaries, and archivist) is then elected on the nomination of the president, and its members are introduced to the assembly. Finally the president impresses on all present the obligation of keeping the proceedings secret, and adjourns the session for a day or two, in order that the ministers may have an opportunity of making each others' acquaintance and talking matters over in private. Serious business begins with the second session.

The discussions are governed by carefully defined rules. Thus every proposition must be presented in writing, and all decisions to be binding on all must be unanimous. The secretary keeps the minutes (*procès-verbal*) of each session, which are signed by all present and read at the next meeting. This *protocol*—as it has been called since the congress of Vienna—takes the form of a bald, but very exact résumé of important points discussed, ending with a record of the conclusions and resolutions arrived at. If there be no such results, opinions are recorded. If any plenipotentiary dissent from the general opinion, such dissent must be recorded in the protocol. Sometimes short signed memoranda, known as a *vote* or *opinion*, are attached to the protocol, stating the reasons that have governed the Powers in question in agreeing to a given conclusion. Individual Powers may express their dissent in two ways: either by placing such dissent on record, as Lord Stewart did at Laibach, or by withdrawing altogether from the sessions of the congress, as Spain did at Vienna and Great Britain at Verona. Though the Final Act of Vienna was issued as the act of all the Powers, the subsequent formal adhesion of Spain was considered necessary to complete the "European" character of that treaty; the action of Great Britain at Verona prevented the intervention in Spain from having the sanction of the concert. At Vienna in 1814, owing to the vast range of the questions to be settled, the work of the congress was distributed among committees; but at Paris (1856) and Berlin (1878) all matters were discussed and settled in full session. The conclusions arrived at after the discussion of the various subjects before the congress are usually embodied in separate conventions, duly signed by the Powers who are a party to them. Finally, these separate conventions are brought together in an inclusive treaty, signed by all the plenipotentiaries present, known as the Final Act.

See P. Pradier-Fodéré, *Cours de droit diplomatique* (2 vols., 2nd ed., Paris, 1899).

CONGREVE, RICHARD (1818–1899), English Positivist, was born at Leamington on the 4th of September 1818, and was educated at Rugby under Dr Arnold, who is said to have expressed a higher opinion of him than of any other pupil. After taking first-class honours at Oxford and gaining a fellowship at Wadham College, he spent some time as a master at Rugby, but returned to Oxford as a tutor. Soon after the revolution of 1848 he visited Paris, where he made the acquaintance of Barthélemy St Hilaire and Auguste Comte. He was so attracted by the Positive philosophy that he resigned his fellowship in 1855, and devoted the remainder of his life to the propagation of the Positive philosophy. He took a leading part in the work carried on in Chapel Street, Lamb's Conduit Street. In 1878 he declined to admit the authority of Pierre Laffitte, Comte's official successor, and the result was a split in the ranks of English Positivism, Frederic Harrison, Dr J. H. Bridges and Professor E. Beesly forming a separate society at Newton Hall, Fetter Lane. Congreve translated several of Comte's works, and in 1874 published a large volume of essays, in which he advocated Comte's view that it was the duty of Great Britain to renounce her foreign possessions. He was a man of high character, courtly manners and great intellectual capacity. He died at Hampstead on the 5th of July 1899.

PUBLICATIONS.—*Pagan Empire of the West* (1855); annotated edition of Aristotle's *Politics* (1855; 2nd ed., 1874); *Catechism of the Positive Religion*, translated from the French of A. Comte (1858;

3rd ed., 1891); *Elizabeth of England* (1862), *Essays, political, social, and religious* (1874; 2nd series, 1892); *Historical Lectures* (collected in one volume, 1902).

CONGREVE, WILLIAM (1670–1729), English dramatist, the greatest English master of pure comedy, was born at Bardsey near Leeds, where he was baptized on the 10th of February 1670, although the inscription on his monument gives his date of birth as 1672. He was the son of William Congreve, a soldier who was soon after his son's birth placed in command of the garrison at Youghal. To Ireland, therefore, is due the credit of his education—as a schoolboy at Kilkenny, as an undergraduate at Dublin, where he was a contemporary and friend of Swift. From college he came to London, and was entered as a student of law at the Middle Temple. The first-fruits of his studies appeared under the boyish pseudonym of "Cleophil," in the form of a novel whose existence is now remembered only through the unabashed avowal of so austere a moralist as Dr Johnson, that he "would rather praise it than read it." In 1693 Congreve's real career began, and early enough by the latest computation, with the brilliant appearance and instant success of his first comedy, *The Old Bachelor*, under the generous auspices of Dryden, then as ever a living and immortal witness to the falsehood of the vulgar charge which taxes the greater among poets with jealousy or envy, the natural badge and brand of the smallest that would claim a place among their kind. The dis-crowned laureate had never, he said, seen such a first play; and indeed the graceless grace of the dialogue was as yet only to be matched by the last and best work of Etherege, standing as till then it had done alone among the barefaced brutalities of Wycherley and Shadwell. The types of Congreve's first work were the common conventional properties of stage tradition; but the fine and clear-cut style in which these types were reproduced was his own. The gift of one place and the reversion of another were the solid fruits of his splendid success. Next year a better play from the same hand met with worse fortune on the stage, and with yet higher honour from the first living poet of his nation. The noble verses, as faultless in the expression as reckless in the extravagance of their applause, prefixed by Dryden to *The Double Dealer*, must naturally have supported the younger poet, if indeed such support can have been required, against the momentary annoyance of assailants whose passing clamour left uninjured and secure the fame of his second comedy; for the following year witnessed the crowning triumph of his art and life, in the appearance of *Love for Love* (1695). Two years later his ambition rather than his usual adventure on the foreign ground of tragedy, and *The Mourning Bride* (1697) began such a long career of good fortune as in earlier or later times would have been closed against a far better work. Next year he attempted, without his usual success, a reply to the attack of Jeremy Collier, the nonjuror, "on the immorality and profaneness of the English stage"—an attack for once not discreditable to the assailant, whose honesty and courage were evident enough to approve him incapable alike of the ignominious precaution which might have suppressed his own name, and of the dastardly mendacity which would have stolen the mask of a stranger's. Against this merit must be set the mistake of confounding in one indiscriminate indictment the levities of a writer like Congreve with the brutalities of a writer like Wycherley—an error which ever since has more or less perverted the judgment of succeeding critics. The general case of comedy was then, however, as untenable by the argument as indefensible by the sarcasm of its most brilliant and comparatively blameless champion. Art itself, more than anything else, had been outraged and degraded by the recent school of the Restoration; and the comic work of Congreve, though different rather in kind than in degree from the bestial and blatant licence of his immediate precursors, was inevitably for a time involved in the sentence passed upon the comic work of men in all ways alike his inferiors. The true and triumphant answer to all possible attacks of honest men or liars, brave men or cowards, was then as ever to be given by the production of work unarraignable alike by fair means or foul, by frank impeachment or furtive

imputation. In 1700 Congreve thus replied to Collier with *The Way of the World*—the unequalled and unapproached masterpiece of English comedy, which may fairly claim a place beside or but just beneath the mightiest work of Molière. On the stage which had recently acclaimed with uncritical applause the author's more questionable appearance in the field of tragedy, this final and flawless evidence of his incomparable powers met with a rejection then and ever since inexplicable on any ground of conjecture. During the twenty-eight years which remained to him, Congreve produced little beyond a volume of fugitive verses, published ten years after the miscarriage of his masterpiece. His even course of good fortune under Whig and Tory governments alike was counterweighed by the physical infirmities of gout and failing sight. He died, January 19, 1729, in consequence of an injury received on a journey to Bath by the upsetting of his carriage; was buried in Westminster Abbey, after lying in state in the Jerusalem Chamber; and bequeathed the bulk of his fortune to the chief friend of his last years, Henrietta, duchess of Marlborough, daughter of the great duke, rather than to his family, which, according to Johnson, was then in difficulties, or to Mrs Bracegirdle, the actress, with whom he had lived longer on intimate terms than with any other mistress or friend, but who inherited by his will only £200. The one memorable incident of his later life was the visit of Voltaire, whom he astonished and repelled by his rejection of proffered praise and the expression of his wish to be considered merely as any other gentleman of no literary fame. The great master of well-nigh every province in the empire of letters, except the only one in which his host reigned supreme, replied that in that sad case Congreve would not have received his visit.

The fame of the greatest English comic dramatist is founded wholly or mainly on but three of his five plays. His first comedy was little more than a brilliant study after such models as were eclipsed by this earliest effort of their imitator; and tragedy under his hands appears rouged and wrinkled, in the patches and powder of Lady Wishfort. But his three great comedies are more than enough to sustain a reputation as durable as our language. Were it not for these we should have no samples to show of comedy in its purest and highest form. Ben Jonson, who alone attempted to introduce it by way of reform among the mixed work of a time when comedy and tragedy were as inextricably blended on the stage as in actual life, failed to give the requisite ease and the indispensable grace of comic life and movement to the action and passion of his elaborate and magnificent work. Of Congreve's immediate predecessors, whose aim had been to raise on French foundations a new English fabric of simple and unmixt comedy, Wycherley was of too base metal and Etherege was of metal too light to be weighed against him; and besides theirs no other or finer coin was current than the crude British ore of Shadwell's brutal and burly talent. Borrowing a metaphor from Landor, we may say that a limb of Molière would have sufficed to make a Congreve, a limb of Congreve would have sufficed to make a Sheridan. The broad and robust humour of Vanbrugh's admirable comedies gives him a place on the master's right hand; on the left stands Farquhar, whose bright light genius is to Congreve's as female is to male, or "as moonlight unto sunlight." No English writer, on the whole, has so nearly touched the skirts of Molière; but his splendid intelligence is wanting in the deepest and subtlest quality which has won for Molière from the greatest poet of his country and our age the tribute of exact and final definition conveyed in that perfect phrase which salutes at once and denotes him—"ce moqueur pensif comme un apôtre." Only perhaps in a single part has Congreve half consciously touched a note of almost tragic depth and suggestion; there is something well-nigh akin to the grotesque and piteous figure of Arnolphe himself in the unvenerable old age of Lady Wishfort, set off and relieved as it is, with grace and art worthy of the supreme French master, against the only figure on any stage which need not shun comparison even with that of Céliamène.

The *Works of William Congreve* were published in 1710 (3 vols.). *The Dramatic Works of Wycherley, Congreve . . .* edited by Leigh

Hunt (1840), contains a biographical and critical notice of Congreve. See also *The Comedies of William Congreve* (1895), with an introduction by W. G. S. Street; and *The Best Plays of William Congreve* (1887, 1903), edited for the Mermaid Series by A. C. Ewald. *The Life of William Congreve* (1887) by Edmund Gosse, in E. S. Robertson's *Great Writers*, contains a bibliography by J. P. Anderson. (A. C. S.)

CONGREVE, SIR WILLIAM, Bart. (1772-1828), British artillery and inventor, was born on the 20th of May 1772, being the eldest son of Lieutenant-General Sir William Congreve (d. 1814), comptroller of the Royal Laboratory at Woolwich, who was made a baronet in 1812. He was educated at Singlewell school, Kent, and (1788-1793) at Trinity College, Cambridge, taking the degrees of B.A. in 1793 and M.A. in 1795. In the latter year he entered the Middle Temple, and up to 1808 he lived in Garden Court, at first studying law, later editing a political newspaper, and in the end devoting himself to the development of the war rocket, for which he is chiefly remembered. Through his father he enjoyed many opportunities of experimenting with artillery material, and finally in 1805 he was able to demonstrate to the prince regent, Pitt and others the uses of the new weapon. In 1805 he accompanied Sir Sidney Smith in a naval attack on the French flotilla at Boulogne, but the weather prevented the use of rockets. In another attack on Boulogne in 1806, however, the Congreve rockets, which were fired in salvos from boats of special construction, were very effectual, and in 1807, 1808 and 1809 they were employed with excellent results on land and afloat at the siege of Copenhagen, in Lord Gambier's fight in the Basque Roads and in the Walcheren expedition. Congreve himself was present in all these affairs. In 1810 or 1811 he became equerry to the prince regent, with whom he was a great favourite, and in 1811 he was elected a fellow of the Royal Society; in the same year he at last received military rank, being gazetted lieutenant-colonel in the Hanoverian artillery. In 1812 he became member of parliament for Gatton. In 1813, at the request of the admiralty, he designed a new gun for the armament of frigates, which was adopted and very favourably reported on. In the same year the newly formed "Rocket Troop" of the Royal Artillery was sent to serve with the Allies in Germany, and this troop rendered excellent service at the battle of Leipzig, where its commander Captain Bogue was killed. In recognition of their services Congreve was shortly afterwards decorated by the sovereigns of Russia and Sweden. Many years later the Congreve rocket was superseded by Hale's, which had no stick.

In 1814, on the death of his father, Colonel Congreve succeeded to the baronetcy and also to the office of comptroller of the Royal Laboratory. He also became inspector of military machines, but his Hanoverian commission did not (it seems) entitle him to command troops of the Royal Artillery, and there was a certain amount of friction and jealousy between Congreve and the Royal Artillery officers. During the visit of the allied sovereigns to London in this year, Congreve arranged the fêtes and especially the pyrotechnic displays which the prince regent gave in their honour. In 1817 he became senior equerry to the prince and a K.H., and in 1818 major-general *à la suite* of the Hanoverian army. In 1820 Sir William Congreve was elected M.P. for Plymouth (for which constituency he sat until his death), and in the following year, at the coronation of George IV. (whose senior equerry he remained), he arranged a great pyrotechnic display in Hyde Park. In his later years Congreve took a prominent part in various industrial ventures, such as gas companies, which, however, were for the most part unsuccessful. He died at Toulouse on the 16th of May 1828.

Congreve was an ingenious and versatile man of science. Besides the war rocket he invented a gun-recoil mounting, a time-fuze, a parachute attachment to the rocket, a hydro-pneumatic canal lock and sluice (1813), a perpetual motion machine (see PERPETUAL MOTION), a process of colour printing (1821) which was widely used in Germany, a new form of steam-engine, and a method of consuming smoke (which was applied at the Royal Laboratory); he also took out patents for a clock in which time was measured by a ball rolling on an inclined

plane; for protecting buildings against fire; inlaying and combining metals; unforgeable bank-note paper; a method of killing whales by means of rockets; improvements in the manufacture of gunpowder; stereotype plates; fireworks; gas meters, &c. The first friction matches made in England (1827) were named after him by their inventor, John Walker. He published a number of works, including three treatises on *The Congreve Rocket System* (1807, 1817 and 1821; the last was translated into German, Weimar, 1829); *An Elementary Treatise on the Mounting of Naval Ordnance* (1812); *A Description of the Hydropneumal Lock* (1815); *A New Principle of Steam-Engine* (1819); *Resumption of Cash Payments* (1819); *Systems of Currency* (1819), &c.

See Colonel J. R. J. Jocelyn in *Journal of the Royal Artillery*, vol. 32, No. 11, and sources therein referred to. The account in the *Dictionary of National Biography* is very inaccurate.

CONGRUOUS (from Lat. *congruere*, to agree), that which corresponds to or agrees with anything; the derivation appears in "congruence," a condition of such correspondence or agreement, a term used particularly in mathematics, e.g. for a doubly infinite system of lines (see **SURFACE**), and in the theory of numbers, for the relation of two numbers, which, on being divided by a third number, known as the *modulus*, leave the same remainder (see **NUMBER**). The similar word "congruity" is a term of Scholastic theology in the doctrine of merit. God's recompense for good works, if performed in a state of grace, is based on "condignity," *meritum de condigno*; if before such a state is reached, it should be fit or "congruous" that God should recompense such works by conferring the "first grace," *meritum de congruo*. The term is also used in theology, in reference to the controversy between the Jesuits and the Dominicans on the subject of grace, at the end of the 16th century (see **MOLINA**, **LUIS**, and **SUAREZ**, **FRANCISCO**).

CONIBOS, or **MANOAS**, a tribe of South American Indians inhabiting the Pampa-del Sacramento and the banks of the Ucayali, Peru. Spanish missionaries first visited them in 1683, and in 1685 some Franciscans who had founded a mission among them were massacred. A like fate befell a priest in 1695. They have since been converted and are now a peaceful people.

CONIC SECTION, or briefly **CONIC**, a curve in which a plane intersects a cone. In ancient geometry the name was restricted to the three particular forms now designated the ellipse, parabola and hyperbola, and this sense is still retained in general works. But in modern geometry, especially in the analytical and projective methods, the "principle of continuity" renders advisable the inclusion of the other forms of the section of a cone, viz. the circle, and two lines (and also two points, the reciprocal of two lines) under the general title *conic*. The definition of conics as sections of a cone was employed by the Greek geometers as the fundamental principle of their researches in this subject; but the subsequent development of geometrical methods has brought to light many other means for defining these curves. One definition, which is of especial value in the geometrical treatment of the conic sections (ellipse, parabola and hyperbola) *in plano*, is that a conic is the locus of a point whose distances from a fixed point (termed the *focus*) and a fixed line (the *directrix*) are in constant ratio. This ratio, known as the *eccentricity*, determines the nature of the curve; if it be greater than unity, the conic is a hyperbola; if equal to unity, a parabola; and if less than unity, an ellipse. In the case of the circle, the centre is the focus, and the line at infinity the directrix; we therefore see that a circle is a conic of zero eccentricity.

In projective geometry it is convenient to define a conic section as the projection of a circle. The particular conic into which the circle is projected depends upon the relation of the "vanishing line" to the circle; if it intersects it in real points, then the projection is a hyperbola, if in imaginary points an ellipse, and if it touches the circle, the projection is a parabola. These results may be put in another way, viz. the line at infinity intersects the hyperbola in real points, the ellipse in imaginary points, and the parabola in coincident real points. A conic may also be regarded as the polar reciprocal of a circle for a point;

if the point be without the circle the conic is an ellipse, if on the circle a parabola, and if within the circle a hyperbola. In analytical geometry the conic is represented by an algebraic equation of the second degree, and the species of conic is solely determined by means of certain relations between the coefficients. Confocal conics are conics having the same foci. If one of the foci be at infinity, the conics are confocal parabolas, which may also be regarded as parabolas having a common focus and axis. An important property of confocal systems is that only two confocals can be drawn through a specified point, one being an ellipse, the other a hyperbola, and they intersect orthogonally.

The definitions given above reflect the intimate association of these curves, but it frequently happens that a particular conic is defined by some special property (as the ellipse, which is the locus of a point such that the sum of its distances from two fixed points is constant); such definitions and other special properties are treated in the articles **ELLIPSE**, **HYPERBOLA** and **PARABOLA**. In this article we shall consider the historical development of the geometry of conics, and refer the reader to the article **GEOMETRY: Analytical and Projective**, for the special methods of investigation.

History.—The invention of the conic sections is to be assigned to the school of geometers founded by Plato at Athens about the 4th century B.C. Under the guidance and inspiration of this philosopher much attention was given to the geometry of solids, and it is probable that while investigating the cone, Menaechmus, an associate of Plato, pupil of Eudoxus, and brother of Dinostratus (the inventor of the quadratrix), discovered and investigated the various curves made by truncating a cone. Menaechmus discussed three species of cones (distinguished by the magnitude of the vertical angle as obtuse-angled, right-angled and acute-angled), and the only section he treated was that made by a plane perpendicular to a generator of the cone; according to the species of the cone, he obtained the curves now known as the hyperbola, parabola and ellipse. That he made considerable progress in the study of these curves is evidenced by Eutocius, who flourished about the 6th century A.D., and who assigns to Menaechmus two solutions of the problem of duplicating the cube by means of intersecting conics. On the authority of the two great commentators Pappus and Proclus, Euclid wrote four books on conics, but the originals are now lost, and all we have is chiefly to be found in the works of Apollonius of Perga. Archimedes contributed to the knowledge of these curves by determining the area of the parabola, giving both a geometrical and a mechanical solution, and also by evaluating the ratio of elliptic to circular spaces. He probably wrote a book on conics, but it is now lost. In his extant *Conoids and Spheroids* he defines a conoid to be the solid formed by the revolution of the parabola and hyperbola about its axis, and a spheroid to be formed similarly from the ellipse; these solids he discussed with great acumen, and effected their cubature by his famous "method of exhaustions."

But the greatest Greek writer on the conic sections was Apollonius of Perga, and it is to his *Conic Sections* that we are indebted for a review of the early history of this subject. Of the eight books which made up his original treatise, only seven are certainly known, the first four in the original Greek, the next three are found in Arabic translations, and the eighth was restored by Edmund Halley in 1710 from certain introductory lemmas of Pappus. The first four books, of which the first three are dedicated to Eudemus, a pupil of Aristotle and author of the original *Eudemian Summary*, contain little that is original, and are principally based on the earlier works of Menaechmus, Aristaeus (probably a senior contemporary of Euclid, flourishing about a century later than Menaechmus), Euclid and Archimedes. The remaining books are strikingly original and are to be regarded as embracing Apollonius's own researches.

The first book, which is almost entirely concerned with the construction of the three conic sections, contains one of the most brilliant of all the discoveries of Apollonius. Prior to his time, a right cone of a definite vertical angle was required for the generation of any particular conic; Apollonius showed that the sections could all be produced from one and the same cone, which may be

either right or oblique, by simply varying the inclination of the cutting plane. The importance of this generalization cannot be overestimated; it is of more than historical interest, for it remains the basis upon which certain authorities introduce the study of these curves. To comprehend more exactly the discovery of Apollonius, imagine an oblique cone on a circular base, of which the line joining the vertex to the centre of the base is the axis. The section made by a plane containing the axis and perpendicular to the base is a triangle contained by two generating lines of the cone and a diameter of the basal circle. Apollonius considered sections of the cone made by planes at any inclination to the plane of the circular base and perpendicular to the triangle containing the axis. The points in which the cutting plane intersects the sides of the triangle are the vertices of the curve; and the line joining these points is a diameter which Apollonius named the *latus transversum*. He discriminated the three species of conics as follows:—At one of the two vertices erect a perpendicular (*latus rectum*) of a certain length (which is determined below), and join the extremity of this line to the other vertex. At any point on the *latus transversum* erect an ordinate. Then the square of the ordinate intercepted between the diameter and the curve is equal to the rectangle contained by the portion of the diameter between the first vertex and the foot of the ordinate, and the segment of the ordinate intercepted between the diameter and the line joining the extremity of the *latus rectum* to the second vertex. This property is true for all conics, and it served as the basis of most of the constructions and propositions given by Apollonius. The conics are distinguished by the ratio between the *latus rectum* (which was originally called the *latus erectum*, and now often referred to as the *parameter*) and the segment of the ordinate intercepted between the diameter and the line joining the second vertex with the extremity of the *latus rectum*. When the cutting plane is inclined to the base of the cone at an angle less than that made by the sides of the cone, the *latus rectum* is greater than the intercept on the ordinate, and we obtain the ellipse; if the plane is inclined at an equal angle as the side, the *latus rectum* equals the intercept, and we obtain the parabola; if the inclination of the plane be greater than that of the side, we obtain the hyperbola. In modern notation, if we denote the ordinate by y , the distance of the foot of the ordinate from the vertex (the abscissa) by x , and the *latus rectum* by p , these relations may be expressed as $y^2 < px$ for the ellipse, $y^2 = px$ for the parabola, and $y^2 > px$ for the hyperbola. Pappus in his commentary on Apollonius states that these names were given in virtue of the above relations; but according to Eutocius the curves were named the parabola, ellipse or hyperbola, according as the angle of the cone was equal to, less than, or greater than a right angle. The word parabola was used by Archimedes, who was prior to Apollonius; but this may be an interpolation.

We may now summarize the contents of the *Conics* of Apollonius. The first book deals with the generation of the three conics; the second with the asymptotes, axes and diameters; the third with various metrical relations between transversals, chords, tangents, asymptotes, &c.; the fourth with the theory of the pole and polar, including the harmonic division of a straight line, and with systems of two conics, which he shows to intersect in not more than four points; he also investigates conics having single and double contact. The fifth book contains properties of normals and their envelopes, thus embracing the germs of the theory of evolutes, and also maxima and minima problems, such as to draw the longest and shortest lines from a given point to a conic; the sixth book is concerned with the similarity of conics; the seventh with complementary chords and conjugate diameters; the eighth book, according to the restoration of Edmund Halley, continues the subject of the preceding book. His proofs are generally long and clumsy; this is accounted for in some measure by the absence of symbols and technical terms. Apollonius was ignorant of the directrix of a conic, and although he incidentally discovered the focus of an ellipse and hyperbola, he does not mention the focus of a parabola. He also considered the two branches of a hyperbola, calling the second branch the "opposite" hyperbola, and shows the relation which existed between many metrical properties of the ellipse and hyperbola. The focus of the parabola was discovered by Pappus, who also introduced the notion of the directrix.

The *Conics* of Apollonius was translated into Arabic by Tobit ben Korra in the 9th century, and this edition was followed by Halley in 1710. Although the Arabs were in full possession of the store of knowledge of the geometry of conics which the Greeks had accumulated, they did little to increase it; the only advance made consisted in the application of describing intersecting conics so as to solve algebraic equations. The great

pioneer in this field was Omar Khayyám, who flourished in the 11th century. These discoveries were unknown in western Europe for many centuries, and were re-invented and developed by many European mathematicians. In 1522 there was published an original work on conics by Johann Werner of Nuremberg. This work, the earliest published in Christian Europe, treats the conic sections in relation to the original cone, the procedure differing from that of the Greek geometers. Werner was followed by Franciscus Maurolycus of Messina, who adopted the same method, and added considerably to the discoveries of Apollonius. Claude Mydorge (1585–1647), a French geometer and friend of Descartes, published a work *De sectionibus conicis* in which he greatly simplified the cumbersome proofs of Apollonius, whose method of treatment he followed.

Johann Kepler (1571–1630) made many important discoveries in the geometry of conics. Of supreme importance is the fertile conception of the planets revolving about the sun in elliptic orbits. On this is based the great structure of celestial mechanics and the theory of universal gravitation; and in the elucidation of problems more directly concerned with astronomy, Kepler, Sir Isaac Newton and others discovered many properties of the conic sections (see MECHANICS). Kepler's greatest contribution to geometry lies in his formulation of the "principle of continuity" which enabled him to show that a parabola has a "caecus (or blind) focus" at infinity, and that all lines through this focus are parallel (see GEOMETRICAL CONTINUITY). This assumption (which differentiates ancient from modern geometry) has been developed into one of the most potent methods of geometrical investigation (see GEOMETRY: *Projective*). We may also notice Kepler's approximate value for the circumference of an ellipse (if the semi-axes be a and b , the approximate circumference is $\pi(a+b)$).

An important generalization of the conic sections was developed about the beginning of the 17th century by Girard Desargues and Blaise Pascal. Since all conics derived from a circular cone appear circular when viewed from the apex, they conceived the treatment of the conic sections as projections of a circle. From this conception all the properties of conics can be deduced. Desargues has a special claim to fame on account of his beautiful theorem on the involution of a quadrangle inscribed in a conic. Pascal discovered a striking property of a hexagon inscribed in a conic (the *hexagrammum mysticum*); from this theorem Pascal is said to have deduced over 400 corollaries, including most of the results obtained by earlier geometers. This subject is mathematically discussed in the article GEOMETRY: *Projective*.

While Desargues and Pascal were founding modern synthetic geometry, René Descartes was developing the algebraic representation of geometric relations. The subject of analytical geometry which he virtually created enabled him to view the conic sections as algebraic equations of the second degree; the form of the section depending solely on the coefficients. This method rivals in elegance all other methods; problems are investigated by purely algebraic means, and generalizations discovered which elevate the method to a position of paramount importance. John Wallis, in addition to translating the *Conics* of Apollonius, published in 1655 an original work entitled *De sectionibus conicis nova methodo expositis*, in which he treated the curves by the Cartesian method, and derived their properties from the definition in *plano*, completely ignoring the connexion between the conic sections and a cone. The analytical method was also followed by G. F. A. de l'Hôpital in his *Traité analytique des sections coniques* (1707). A mathematical investigation of the conics by this method is given in the article GEOMETRY: *Analytical*. Philippe de la Hire, a pupil of Desargues, wrote several works on the conic sections, of which the most important is his *Sectiones Conicae* (1685). His treatment is synthetic, and he follows his tutor and Pascal in deducing the properties of conics by projection from a circle.

A method of generating conics essentially the same as our modern method of homographic pencils was discussed by Jan de Witt in his *Elementa linearum curvarum* (1650); but he treated the curves by the Cartesian method, and not synthetically.

Similar methods were devised by Sir Isaac Newton and Colin Maclaurin. In Newton's method, two angles of constant magnitude are caused to revolve about their vertices which are fixed in position, in such a manner that the intersection of two limbs moves along a fixed straight line, then the two remaining limbs envelop a conic. Maclaurin's method, published in his *Geometria organica* (1719), is based on the proposition that the locus of the vertex of a triangle, the sides of which pass through three fixed points, and the base angles move along two fixed lines, is a conic section. Both Newton's and Maclaurin's methods have been developed by Michel Chasles. In modern times the study of the conic sections has proceeded along the lines which we have indicated; for further details reference should be made to the article GEOMETRY.

AUTHORITIES.—For the ancient geometry of conic sections, especially of Apollonius, reference should be made to T. L. Heath's *Apollonius of Perga* (1886); more general accounts are given in James Gow, *A Short History of Greek Mathematics* (1884), and in H. G. Zeuthen, *Die Lehre von dem Kegelschnitten in Alterthum* (1886). Michel Chasles in his *Aperçu historique sur l'origine et le développement des méthodes en géométrie* (1837, a third edition was published in 1889), gives a valuable account of both the ancient and modern geometry of conics; a German translation with the title *Geschichte der Geometrie* was published in 1839 by L. A. Sohncke. A copious list of early works on conic sections is given in Fred. W. A. Murhard, *Bibliotheca mathematica* (Leipzig, 1798). The history is also treated in general historical treatises (see MATHEMATICS).

Geometrical constructions are treated in T. H. Eagles, *Constructive Geometry of Plane Curves* (1886); geometric investigations primarily based on the relation of the conic sections to a cone are given in Hugo Hamilton's *De Sectionibus Conicis* (1758); this method of treatment has been largely replaced by considering the curves from their definition in *plano*, and then passing to their derivation from the cone and cylinder. This method is followed in most modern works. Of such text-books there is an ever-increasing number; here we may notice W. H. Besant, *Geometrical Conic Sections*; C. Smith, *Geometrical Conics*; W. H. Drew, *Geometrical Treatise on Conic Sections*. Reference may also be made to C. Taylor, *An Introduction to Ancient and Modern Geometry of Conics* (1881).

See also list of works under GEOMETRY: *Analytical and Projective*.

CONINE, or **CONIINE** (α -propyl piperidine), $C_8H_{17}N$, an alkaloid occurring, associated with γ -coniceine, conhydrine, pseudoconhydrine and methyl conine, in hemlock (*Conium maculatum*). It is a colourless oily liquid of specific gravity 0.845 (20° C.), boiling at 166° C., almost insoluble in water, soluble in ether and in alcohol. It has a sharp burning taste and a penetrating smell, and acts as a violent poison. It is dextro-rotatory. The alkaloid is a strong base and is very readily oxidized; chromic acid converts it into normal butyric acid and ammonia; hydrogen peroxide gives aminopropylvalerylaldehyde, $NH_2 \cdot CH(C_2H_5) \cdot (CH_2)_3 \cdot CHO$, whilst the benzoyl derivative is oxidized by potassium permanganate to benzoyl- α -aminovaleric acid, $C_6H_5CO \cdot NH \cdot CH(C_2H_5) \cdot (CH_2)_3 \cdot COOH$. It combines directly with methyl iodide to form dimethyl coninium iodide, $C_{10}H_{22}NI$, which by the destructive methylation process of A. W. Hofmann (*Berichte*, 1881, 14, pp. 494, 659) is converted into the hydrocarbon *conylene* C_8H_{14} , a compound that can also be obtained by heating nitrosoconine with phosphoric anhydride to 80–90° C. On heating conine with concentrated hydriodic acid and phosphorus it is decomposed into ammonia and normal octane C_8H_{18} . Conine is a secondary base, forming a nitroso derivative with nitrous acid, a urethane with chlorcarbonic ester and a tertiary base (methyl conine) with methyl iodide, reactions which point to the presence of the =NH group in the molecule.

It was the first alkaloid to be synthesized, a result due to A. Ladenburg (see various papers in the *Berichte* for the years 1881, 1884, 1885, 1886, 1889, 1893, 1894, 1895, and Liebig's *Annalen* for 1888, 1894). A. W. Hofmann had shown that conine on distillation with zinc dust gave α -propyl pyridine (conyrine). This substance when heated with hydriodic acid to 300° C. is converted into α -propyl piperidine, which can also be obtained by the reduction of α -allyl pyridine (formed from α -methyl pyridine and paraldehyde). The α -propyl piperidine so obtained is the inactive (racemic) form of conine, and it can be resolved into the dextro- and laevo-varieties by means of dextro-tartaric acid, the *d*-conine *d*-tartrate with caustic soda giving *d*-conine closely resembling the naturally occurring alkaloid. A. Laden-

burg (*Ber.* 1906, 39, p. 2486) showed that the difference in the rotations of the natural and synthetic *d*-conine is not due to another substance, *iso*-conine, as was originally supposed, but that the artificial product is a stereo-isomer, which yields natural conine on heating for some time to 290°–300°, and then distilling.

γ -Coniceine, $C_8H_{15}N$, is a tetrahydro conyrine, *i.e.* a tetrahydro propyl pyridine. It may be obtained by brominating conine, and then removing the elements of hydrobromic acid with alkalis. Other coniceines have been prepared. Conhydrine, $C_8H_{17}NO$, and pseudoconhydrine are probably stereo-isomers, the latter being converted into the former when boiled with ligroin. Since conhydrine is dehydrated by phosphorus pentoxide into a mixture of α and β coniceines, it may be considered an oxyconine. Methyl conine, $C_9H_{19}N$ or $C_3H_7 \cdot N(CH_3)$, is synthesized from conine and an aqueous solution of potassium methyl sulphate at 100°.

CONINGTON, JOHN (1825–1869), English classical scholar, was born on the 10th of August 1825 at Boston in Lincolnshire. He knew his letters when fourteen months old, and could read well at three and a half. He was educated at Beverley Grammar school, at Rugby and at Oxford, where, after matriculating at University College, he came into residence at Magdalen, where he had been nominated to a demyship. He was Ireland and Hertford scholar in 1844; in March 1846 he was elected to a scholarship at University College, and in December of the same year he obtained a first class in classics; in February 1848 he became a fellow of University. He also obtained the Chancellor's prize for Latin verse (1847), English essay (1848) and Latin essay (1849). He successfully applied for the Eldon law scholarship in 1849, and proceeded to London to keep his terms at Lincoln's Inn. The legal profession, however, proved distasteful, and after six months he resigned the scholarship and returned to Oxford. During his brief residence in London he formed a connexion with the *Morning Chronicle*, which was maintained for some time. He showed no special aptitude for journalism, but a series of articles on university reform (1849–1850) is noteworthy as the first public expression of his views on a subject that always interested him. In 1854 his appointment, as first occupant, to the chair of Latin literature, founded by Corpus Christi College, gave him a congenial position. From this time he confined himself with characteristic conscientiousness almost exclusively to Latin literature. The only important exception was the translation of the last twelve books of the *Iliad* in the Spenserian stanza in completion of the work of P. S. Worsley, and this was undertaken in fulfilment of a promise made to his dying friend. In 1852 he began, in conjunction with Prof. Goldwin Smith, a complete edition of Virgil with a commentary, of which the first volume appeared in 1853, the second in 1864, and the third soon after his death. Prof. Goldwin Smith was compelled to withdraw from the work at an early stage, and in the last volume his place was taken by H. Nettleship. In 1866 Conington published his most famous work, the translation of the *Aeneid* of Virgil into the octosyllabic metre of Scott. The version of Dryden is the work of a stronger artist; but for fidelity of rendering, for happy use of the principle of compensation so as to preserve the general effect of the original, and for beauty as an independent poem, Conington's version is superior. That the measure chosen does not reproduce the majestic sweep of the Virgilian verse is a fault in the conception and not in the execution of the task. Conington died at Boston on the 23rd of October 1869.

His edition of Persius with a commentary and a spirited prose translation was published posthumously in 1872. In the same year appeared his *Miscellaneous Writings*, edited by J. A. Symonds, with a memoir by Professor H. J. S. Smith (see also H. A. J. Munro in *Journal of Philology*, ii., 1869). Among his other editions are Aeschylus, *Agamemnon* (1848), *Choëphori* (1857); English verse translations of Horace, *Odes* and *Carmen Saeculare* (1863), *Satires*, *Epistles* and *Ars Poëtica* (1869).

CONISTERIUM (from Gr. *κόvus*, dust); the name of the room in the ancient palaestra or thermae (baths) where wrestlers, after being anointed with oil, were sprinkled with sand, so as to give them a grip when wrestling.

CONJEEVERAM, KANCHIPURAM, a town of British India, in the Chingleput district of Madras, 45 m. W.S.W. of Madras by rail. Pop. (1901) 46,164. It is esteemed by the Hindus as one of the holiest places in southern India, ranking among the seven sacred cities of India, and is remarkable for the number of its temples and shrines. Of these the old Jain temple, situated in a hamlet some 2 m. south of the Weavers' quarter of the city (Pillalalayam), dates from the time when the Chola power was at its height (12th or 13th century), and is of great importance to the historian by reason of the inscriptions, which contain an almost perfect record of the dynasties who held the country. Older than this temple are the Vaikuntha Perumā temple of Vishnu and the Siva temple of Kailāsanāth, which date from the time of the Pallava kings. The great temple of Siva, dedicated to Ekambara Swami (the god with the single garment) is remarkable for its lofty towers (*gopuram*) and the extreme irregularity of its design, through which it gains in picturesqueness what it loses in dignity. Besides the towers, it has several fine porches, great tanks approached by flights of stone steps, and the "hall of the thousand columns." This latter contains actually 540 columns, most of them elaborately carved, arranged in twenty rows. About 2 m. distant, in Little Conjeeveram, is the Varadaraja-swami Vaishnava temple, also containing a hall of pillars, beautifully carved, and possessing a wonderfully rich treasury of votive jewels. A mark on the wall of the inner enclosure, something like a horseshoe, is held to be the first letter of the name of Vishnu. For a century or more the Tangalai and Vadagalai sects, connected with the worship of the temple, have been quarrelling fiercely as to the form of this symbol; the questions arising out of this led to much litigation, and though final judgment was given by the privy council, the matter still constitutes a danger to the peace. The general aspect of the city is pleasing, with low houses and broad streets lined with fine trees. Its only noteworthy industry is the weaving of the superior silk and cotton *sāris* worn by native women.

Conjeeveram, a British corruption of Kānchīpuram (the golden city), is very ancient, having been in the early centuries of the Christian era the capital of the Pallava dynasty. The Chinese traveller Hsüan Tsang, who visited it in the 7th century, says that it was then 6 m. in circumference and inhabited by a people superior to any he had met in piety and courage, love of justice and reverence for learning. In the 11th century the city was conquered by the Cholas, who held it until their overthrow by the Mussulmans in 1310, after which it fell under the sway of the kings of Vijayanagar. In 1646 it was taken from them by the Mussulmans, who in their turn were ousted by the Mahrattas in 1677. Shortly afterwards the emperor Aurungzeb's forces retook the place, which remained in Mussulman hands until 1752, when it was captured by Clive.

CONJUGAL RIGHTS, those rights which a husband and wife (Lat. *conjux*) have to each other's society. When either party continues to refuse to render these rights to the other, they may be enforced by a suit for the restitution of conjugal rights. In England the jurisdiction which the old ecclesiastical courts exercised to enforce this right was transferred to the divorce court by the Matrimonial Causes Act 1857. The procedure is by citation and petition, but, before a petition can be filed, a written demand must be made to the refusing party for cohabitation. Previous to the Matrimonial Causes Act 1884, disobedience to a decree for the restitution of conjugal rights rendered the refusing party liable to attachment and imprisonment. The act of 1884 substituted for attachment, if the wife be the petitioner, an order for periodical payments by the husband to the wife. Failure to comply with a decree for restitution is deemed to be desertion, and a sentence of judicial separation may be pronounced, although the period of two years prescribed by the act of 1857 may not have expired. Conjugal rights cannot be enforced by the act of either party (*R. v. Jackson*, 1891, 1 Q.B. 671), the proper procedure being to apply to the court for relief.

CONJUNCTION (from Lat. *conjungere*, to join together), a general term signifying the act or state of being joined together. It is used technically in astronomy and grammar. In astronomy,

"conjunction" is the nearest apparent approach of two heavenly bodies which seem to pass each other in their courses—said to be in longitude, right ascension, &c., when they have the *same* longitude, &c. A superior conjunction is one in which the lesser body is beyond the greater, especially when a planet is beyond the sun. An inferior conjunction is one in which a planet is on our side of the sun. In grammar the term "conjunction" is applied to one of the so-called "parts of speech," viz. those words which are used to "join together" words, clauses or sentences. Conjunctions are variously classified according to their specific function, e.g. *adversative* ("but," "though") which contrast, *illative* ("therefore") where the second sentence or clause is an inference from the first, *temporal* where a time-relation is expressed, and so forth.

CONJURING, the art, sometimes called White or Natural Magic, and long associated with the profession of "magician," consisting of the performance of tricks and illusions, with or without apparatus. Historically this art has taken many forms, and has been mixed up with the use of what now are regarded as natural though obscure physical phenomena. The employment of purely manual dexterity without mechanical apparatus may be distinguished as *legerdemain*, *prestidigitation* or *sleight of hand*.

Whether or not the book of Exodus makes the earliest historical reference to this form of natural "magic" when it records how the magicians of Egypt imitated certain miracles of Moses "by their enchantments," it is known that the Egyptian hierophants, as well as the magicians of ancient Greece and Rome, were accustomed to astonish their dupes with optical illusions, visible representations of the divinities and subdivinities passing before the spectators in dark subterranean chambers. The principal optical illusion employed in these effects was the throwing of spectral images upon the smoke of burning incense by means of concave metal mirrors. But according to Hippolytus (*Ref. Om. Haer.* iv. 35), the desired effect was often produced in a simpler way, by causing the dupe to look into a cellar through a basin of water with a glass bottom standing under a sky-blue ceiling, or by figures on a dark wall drawn in inflammable material and suddenly ignited. The flashes of lightning and the rolling thunders which sometimes accompanied these manifestations were easy tricks, now familiar to everybody as the ignition of lycopodium and the shaking of a sheet of metal. The ancient methods described by Hippolytus (iv. 32) were very similar.

Judging from the accounts which history has handed down to us, the marvels performed by the thaumaturgists of antiquity were very skilfully produced, and must have required a considerable practical knowledge of the art. The Romans were in the habit of giving conjuring exhibitions, the most favourite feat being that of the "cups and balls," the performers of which were called *acetabularii*, and the cups themselves *acetabula*. The balls used, however, instead of being the convenient light cork ones employed by modern conjurers, were simply round white pebbles which must have added greatly to the difficulty of performing the trick. The art survived the barbarism and ignorance of the middle ages; and the earliest professors of the modern school were Italians such as Jonas, Androletti and Antonio Carlotti. But towards the close of Elizabeth's reign conjurers were classed with "ruffians, blasphemers, thieves, vagabonds, Jews, Turks, heretics, pagans and sorcerers."

The history of conjuring by mechanical effects and inventions is full of curious detail. Spectral pictures or reflections of moving objects, similar to those of the camera or magic lantern, were described in the 14th and 16th centuries. Thus, in the *House of Fame*, bk. iii., Chaucer speaks of "appearances such as the subtil tregetours perform at feasts"—pictorial representations of hunting, falconry and knights jousting, with the persons and objects instantaneously disappearing; exhibitions of the same kind are mentioned by Sir John Mandeville, as seen by him at the court of "the Great Chan" in Asia; and in the middle of the 16th century Benvenuto Cellini saw phantasmagoric spectres projected upon smoke at a nocturnal exhibition in the Colosseum at Rome. The existence of a camera obscura at this latter date

is a fact; for the instrument is described by Baptista Porta, the Neapolitan philosopher, in his *Magia Naturalis* (1558). And the doubt how magic lantern effects could have been produced in the 14th century, when the lantern itself is alleged to have been invented by Athanasius Kircher in the middle of the 17th century, is set at rest by the fact that glass lenses were constructed at the earlier of these dates,—Roger Bacon, in his *Discovery of the Miracles of Art, Nature and Magic* (about 1260), writing of glass lenses and perspectives so well made as to give good telescopic and microscopic effects, and to be useful to old men and those who have weak eyes. Towards the end of the 18th century Comus, a French conjuror, included in his entertainment a figure which suddenly appeared and disappeared about three ft. above a table,—a trick explained by the circumstance that a concave mirror was among his properties; and a contemporary performer, Robert, exhibited the raising of the dead by the same agency. Early in the 19th century Philipstal gave a sensation to his magic lantern entertainment by lowering unperceived between the audience and the stage a sheet of gauze upon which fell the vivid moving shadows of phantasmagoria.

A new era in optical tricks began in 1863 when John Nevil Maskelyne (b. 1839), of Cheltenham, invented a wood cabinet in which persons vanished and were made to reappear, although it was placed upon high feet, with no passage through which a person could pass from the cabinet to the stage floor, the scenes, or the ceiling; and this cabinet was examined and measured for concealed space, and watched round by persons from the audience during the whole of the transformations. The general principle was this: if a looking-glass be set upright in the corner of a room, bisecting the right angle formed by the walls, the side wall reflected will appear as if it were the back, and hence an object may be hidden behind the glass, yet the space seem to remain unoccupied. This principle, however, was so carried out that no sign of the existence of any mirror was discernible under the closest inspection. Two years later the same simple principle appeared in "The Cabinet of Proteus," patented by Tobin and Pepper of the Polytechnic Institution, in which two mirrors were employed, meeting in the middle, where an upright pillar concealed their edges. In the same year Stodare exhibited the illusion in an extended form, by placing the pair of mirrors in the centre of the stage, supported between the legs of a three-legged table having the apex towards the audience; and as the side walls of his stage were draped exactly like the back, reflection showed an apparently clear space below the table top, where in reality a man in a sitting position was hidden behind the glasses and exhibited his head ("The Sphinx") above the table. The plane mirror illusion is so effective that it has been reproduced with modifications by various performers. In one case a living bust was shown through an aperture in a looking-glass sloping upward from the front towards the back of a curtained cabinet; in another a person stood half-hidden by a vertical mirror, and imitation limbs placed in front of it were sundered and removed; and in another case a large vertical mirror was pushed forward from a back corner of the stage at an angle of 45 degrees, to cover the entrance of a living "phantom," and then withdrawn. Maskelyne improved upon his original cabinet by taking out a shelf which, in conjunction with a mirror, could enclose a space, and thus left no apparent place in which a person could possibly be hidden. He introduced a further mystification by secretly conveying a person behind a curtain screen, notwithstanding that, during the whole time, the existence of a clear space under the stool upon which the screen is placed is proved by performers continually walking round. The principle of reflecting by means of transparent plate-glass the images of highly-illuminated objects placed in front, so that they appear as if among less brilliantly lighted objects behind the glass, was employed in the "ghost" illusions of Sylvester, of Dircks and Pepper, of Robin, and of some other inventors,—the transparent plate-glass being, in some cases, inclined forwards so as to reflect a lime-lighted object placed below the front of the stage, and in other arrangements set vertically at an angle so as to reflect the object from a lateral position.

Among the acoustic wonders of antiquity were the speaking head of Orpheus, the golden virgins, whose voices resounded through the temple of Delphi, and the like. Hippolytus (iv. 4) explains the trick of the speaking head as practised in his day, the voice being really that of a concealed assistant who spoke through the flexible gullet of a crane. Towards the close of the 10th century Gerbert (Pope Silvester II.) constructed (says William of Malmesbury) a brazen head which answered questions; and similar inventions are ascribed to Roger Bacon, Albertus Magnus, and others. In the first half of the 17th century the philosopher Descartes made a speaking figure which he called his daughter Franchina; but the superstitious captain of a vessel had it thrown overboard. In the latter part of the same century Thomas Irson, an Englishman, exhibited at the court of Charles II. a wooden figure with a speaking-trumpet in its mouth; and questions whispered in its ear were answered through a pipe secretly communicating with an apartment wherein was a learned priest able to converse in various languages. Johann Beckmann, in his *History of Inventions* (about 1770, Eng. transl. by W. Johnston, 4th ed., 1846), relates his inspection of a speaking figure, in which the words really came through a tube from a confederate who held a card of signs by which he received intelligence from the exhibitor. Somewhat later was shown in England the figure of an infant suspended by a ribbon, having a speaking-trumpet in its mouth,—an illusion in which two concave mirrors were employed, one of them concentrating the rays of sound into a focus within the head of the figure; and the mirror nearest the figure was hidden by a portion of the wall-paper which was perforated with pin-holes. In 1783 Giuseppe Pinetti de Wildalle, an Italian conjuror of great originality, exhibited among his many wonders a toy bird perched upon a bottle, which fluttered, blew out a candle, and warbled any melody proposed or improvised by the audience,—doing this also when removed from the bottle to a table, or when held in the performer's hand upon any part of the stage. The sounds were produced by a confederate who imitated song-birds after Rossignol's method by aid of the inner skin of an onion in the mouth; and speaking-trumpets directed the sounds to whatever position was occupied by the bird. About the year 1825 Charles, a Frenchman, exhibited a copper globe, carrying four speaking-trumpets, which was suspended in a light frame in the centre of a room. Whispers uttered near to this apparatus were heard by a confederate in an adjoining room by means of a tube passing through the frame and the floor, and answers issued from the trumpets in a loud tone. Subsequently appeared more than one illusion of a similar order, in which the talking and singing of a distant person issued from an isolated head or figure by aid of ear-trumpets secretly contained within parts in which, from their outside form, the presence of such instruments would not be suspected. It is probable that the automaton trumpeters of Friedrich Kaufmann and of Johann Nepomuk Malzel were clever deceptions of the same kind. As described in the *Journal de Mode*, 1809, Mälzel's life-size figure had the musical instrument fixed in its mouth; the mechanism was wound up, and a set series of marches, army calls, and other compositions was performed, accompaniments being played by a real band. Mechanical counterparts of the human lips, tongue and breath, both in speech and in playing certain musical instruments, have, however, been constructed, as in Jacques de Vaucanson's celebrated automaton flute-player, which was completed in 1736, the same mechanician's tambourine and flageolet player, which was still more ingenious, as, the flageolet having only three holes, some of the notes were produced by half-stopping; Abbé Mical's heads which articulated syllables, and his automata playing upon instruments; Kempelen's and Kratzenstein's speaking-machines, in the latter part of the 18th century; the speaking-machine made by Fabermann of Vienna, closely imitating the human voice, with a fairly good pronunciation of various words; the automaton clarinet-player constructed by Van Oeckelen, a Dutchman, and exhibited in New York in 1860, which played airs from a barrel like that of a crank-organ, and could take the clarinet from its mouth and replace it, and

Maskelyne's two automata, "Fanfare" (1878) playing a cornet, and "Labial" (1879) playing a euphonium, both operated by mechanism inside the figures and supplied with wind from a bellows placed separately upon the stage.

Lucian tells of the magician Alexander in the 2nd century that he received written questions enclosed in sealed envelopes, and a few days afterwards delivered written responses in the same envelopes, with the seals apparently unbroken; and both he and Hippolytus explain several methods by which this could be effected. In this deception we have the germ of "spirit-reading" and "spirit-writing," which, introduced in 1840 by John Henry Anderson, "The Wizard of the North," became common in the *répertoire* of modern conjurers,—embracing a variety of effects from an instantaneous substitution which allows the performer or his confederate to see what has been secretly written by the audience. The so-called "second-sight" trick depends upon a system of signalling between the exhibitor, who moves among the audience collecting questions to be answered and articles to be described, and the performer, who is blindfolded on the stage. As already stated, the speaking figure which Stock showed to Professor Beckmann, at Göttingen, about 1770, was instructed by a code of signals. In 1783 Pinetti had an automaton figure about 18 in. in height, named the Grand Sultan or Wise Little Turk, which answered questions as to chosen cards and many other things by striking upon a bell, intelligence being communicated to a confederate by an ingenious ordering of the words, syllables or vowels in the questions put. The teaching of Mesmer and the feats of clairvoyance suggested to Pinetti a more remarkable performance in 1785, when Signora Pinetti, sitting blindfold in a front box of a theatre, replied to questions and displayed her knowledge of articles in the possession of the audience. Half a century later this was developed with greater elaboration, and the system of telegraphing cloaked by intermixing signals on other methods, first by Robert-Houdin in 1846, then by Hermann in 1848, and by Anderson at a later period. Details of the system of indicating a very large number of answers by slight and unperceived variations in the form of question are given by F. A. Gandon, *La seconde vue dévoilée* (Paris, 1849).

Fire tricks, such as walking on burning coals, breathing flame and smoke from a gall-nut filled with an inflammable composition and wrapped in tow, or dipping the hands in boiling pitch, were known in early times, and are explained by Hippolytus (iv. 33). At the close of the 17th century Richardson astonished the English public by chewing ignited coals, pouring melted lead (really quicksilver) upon his tongue and swallowing melted glass. Strutt, in *Sports and Pastimes of the People of England*, relates how he saw Powel the fire-eater, in 1762, broil a piece of beefsteak laid upon his tongue,—a piece of lighted charcoal being placed under his tongue which a spectator blew upon with a bellows till the meat was sufficiently done. This man also drank a melted mixture of pitch, brimstone and lead out of an iron spoon, the stuff blazing furiously. These performers anointed their mouths and tongues with a protective composition.

Galen speaks of a person in the 2nd century who relighted a blown-out candle by holding it against a wall or a stone which had been rubbed with sulphur and naphtha; and the instantaneous lighting of candles became a famous feat of later times. Baptista Porta gave directions for performing a trick entitled "many candles shall be lighted presently." Thread is boiled in oil with brimstone and orpiment, and when dry bound to the wicks of candles; and, one being lighted, the flame runs to them all. He says that on festival days they are wont to do this among the Turks. "Some call it Hermes his ointment." In 1783 Pinetti showed two figures sketched upon a wall, one of which put out a candle, and the other relighted the hot wick, when the candle was held to their mouths. By wafers he had applied a few grains of gunpowder to the mouth of the first, and a bit of phosphorus to that of the other. A striking trick of this conjuror was to extinguish two wax candles and simultaneously light two others at a distance of 3 ft., by firing a pistol.

The candles were placed in a row, and the pistol fired from the end where the lighted candles were placed; the sudden blast of hot gas from the pistol blew out the flames and lighted the more distant candles, because in the wick of each was placed a millet-grain of phosphorus. A more recent conjuror showed a pretty illusion by appearing to carry a flame invisibly between his hands from a lighted to an unlighted candle. What he did was to hold a piece of wire for a second or two in the flame of the first candle, and then touch with the heated wire a bit of phosphorus which had been inserted in the turpentine-wetted wick of the other. But in 1842 Ludwig Döbler, a German conjuror of much originality, surprised his audience by lighting two hundred candles instantaneously upon the firing of a pistol. This was the earliest application of electricity to stage illusions. The candles were so arranged that each wick, black from previous burning, stood a few inches in front of a fine nozzle gas-burner projecting horizontally from a pipe of hydrogen gas, and the two hundred jets of gas passed through the same number of gaps in a conducting-wire. An electric current leaping in a spark through each jet of gas ignited all simultaneously, and the gas flames fired the candle wicks.

J. E. Robert-Houdin (1805-1871), who opened his "Temple of Magic" at Paris in 1845, originated the application of electromagnetism for secretly working or controlling mechanical apparatus in stage illusions. His *Soirées fantastiques* at Paris gave him such a reputation that the French government actually sent him to Algiers in order to show his superiority to the local marabouts; and he ranks as the founder of modern conjuring. He first exhibited in 1845 his light and heavy chest, which, when placed upon the broad plank or "rake" among the spectators, and exactly over a powerful electromagnet hidden under the cloth covering of the plank, was held fast at pleasure. In order to divert suspicion, Houdin showed a second experiment with the same box, suspending it by a rope which passed over a single small pulley attached to the ceiling; but any person in the audience who took hold of the rope to feel the sudden increase in the weight of the box was unaware that the rope, while appearing to pass simply over the pulley, really passed upward over a winding-barrel worked as required by an assistant. Remarkable ingenuity was displayed in concealing a small electromagnet in the handle of his glass bell, as well as in his drum, the electric current passing through wires hidden within the cord by which these articles were suspended. In one of Houdin's illusions—throwing eight half-crowns into a crystal cash-box previously set swinging—electricity was employed in a different manner. Top, bottom, sides and ends of an oblong casket were of transparent glass, held together at all the edges by a light metal frame. The coins were concealed under an opaque design on the lid, and supported by a false lid of glass, which was tied by cotton thread to a piece of platinum wire. Upon connecting the electric circuit, the platinum, becoming red-hot, severed the thread, letting fall the glass flap, and dropping the coins into the box.

Down to the latter part of the 18th century no means of secretly communicating *ad libitum* motions to apparently isolated pieces of mechanism had superseded the clumsy device of packing a confederate into a box on legs draped to look like an unsophisticated table. Pinetti placed three horizontal levers close beside each other in the top of a thin table, covered by a cloth, these levers being actuated by wires passing through the legs and feet of the table and to the confederate behind a scene or partition. In the pedestal of each piece of apparatus which was to be operated upon when set loosely upon the table were three corresponding levers hidden by cloth; and, after being examined by the audience, the piece of mechanism was placed upon a table in such a position that the two sets of levers exactly coincided, one being superimposed upon the other. In one "effect" the confederate worked a small bellows in the base of a lamp, to blow out the flame; in another he let go a trigger, causing an arrow to fly by a spring from the bow of a doll sportsman; he actuated a double-bellows inside a bottle, which caused flowers and fruit to protrude from among the foliage of an

artificial shrub, by distending with air a number of small bladders shaped and painted to represent them; he opened or shut valves which allowed balls to issue out of various doors in a model house as directed by the audience; and he moved the tiny bellows in the body of a toy bird by which it blew out a candle. Other conjurers added more complicated pieces of apparatus,—one being a clock with small hand moving upon a glass disk as required by the audience. The glass disk carrying the numbers or letters was in reality two, the back one being isolated by ratchet teeth on its periphery hidden by the ring frame which supported it, and, though the pillar-pedestal was separated into three pieces and shown to the spectators, movable rods, worked by the table levers, were in each section duly covered by cloth faces. Another mechanical trick, popular with Torrini, Houdin, Philippe and Robin, and worked in a similar way, was a little harlequin figure which rose out of a box set upon the table, put his legs over the front of the box and sat on the edge, nodded his head, smoked a pipe, blew out a candle, and whistled a one-note obbligato to an orchestra. Robert-Houdin employed, instead of the table levers, vertical rods each arranged to rise and fall in a tube, according as it was drawn down by a spiral spring or pulled up by whip-cord which passed over a pulley at the top of the tube and so down the table-leg to the hiding-place of the confederate. In his centre table he had ten of these "pistons," and the ten cords passing under the floor of the stage terminated at a keyboard. Various ingenious automata were actuated by this means of transmitting motion; but the most elaborate piece of mechanical apparatus constructed by Houdin was his orange tree. The oranges, with one exception, were real, stuck upon small spikes, and concealed by hemispherical screens which were covered with foliage; and the screens, when released by the upward pressure of a piston, made half a turn, and disclosed the fruit. The flowers were hidden behind foliage until raised above the leaves by the action of another piston. Near the top of the tree an artificial orange opened into four portions; while two butterflies attached to two light arms of brass rose up behind the tree, appeared on each side by the spreading of the arms, and drew out of the opened orange a handkerchief which had been borrowed and vanished away.

Many of the illusions regarded as the original inventions of eminent conjurers have been really improvements of older tricks. *Hocus Pocus Junior, The Anatomy of Legerdemain* (4th ed., 1654) gives an explanatory cut of a method of drawing different liquors out of a single tap in a barrel, the barrel being divided into compartments, each having an air-hole at the top, by means of which the liquid in any of the compartments was withheld or permitted to flow. Robert-Houdin applied the principle to a wine-bottle held in his hand from which he could pour four different liquids regulated by the unstopping of any of the four tiny air-holes which were covered by his fingers. A large number of very small liqueur glasses being provided on trays, and containing drops of certain flavouring essences, enabled him to supply imitations of various wines and liquors, according to the glasses into which he poured syrup from the bottle; while by a skilful substitution of a full bottle for an emptied one, or by secretly refilling in the act of wiping the bottle with a cloth, he produced the impression that the bottle was "inexhaustible." In 1835 was first exhibited in England a trick which a Brahman had been seen to perform at Madras several years before. Ching Lau Lauro sat cross-legged upon nothing,—one of his hands only just touching some beads hung upon a genuine hollow bamboo which was set upright in a hole on the top of a wooden stool. The placing of the performer in position was done behind a screen; and the explanation of the mysterious suspension is that he passed through the bamboo a strong iron bar, to which he connected a support which, concealed by the beads, his hand and his dress, upheld his body. In 1849 Robert-Houdin reproduced the idea under the title of ethereal suspension,—professedly rendering his son's body devoid of weight by administering vapour of ether to his nose, and then, in sight of the audience, laying him in a horizontal position in the air with one elbow resting upon a staff resembling

a long walking-stick. The support was a jointed iron frame under the boy's dress, with cushions and belts passing round and under the body. Subsequently the trick was improved upon by Sylvester—the suspended person being shown in several changes of position, while the sole supporting upright was finally removed. For the latter deception the steel upright was made with polished angular faces, apex towards the spectators, and acted in a dim light on the same principle as the mirrors of a Sphinx table. Before lowering the light, the reflector bar is covered by the wood staff set up before it.

The mysterious vanishing or appearing of a person under a large extinguisher upon the top of a table, and without the use of mirrors, was first performed by Comus, a French conjuror very expert in the cups-and-balls sleight-of-hand, who, appearing in London in 1789, announced that he would convey his wife under a cup in the same manner as he would balls. The feat was accomplished by means of a trap in a box table. Early in the 19th century Chalons, a Swiss conjuror, transformed a bird into a young lady, on the same principle. In 1836 Sutton varied the feat by causing the vanished body to reappear under the crust of a great pie. Houdin "vanished" a person standing upon a table top which was shown to be only a few inches thick; but there was a false top which was let down like the side of a bellows, this distension being hidden by a table-cloth hanging sufficiently low for the purpose, and the person, when covered by the extinguisher, entered the table through a trap-door opening upwards. Robin, in 1851, added to the wonder of the trick by vanishing two persons in succession, without any possibility of either escaping from the table,—the two persons really packing themselves into a space which, without clever arrangement and practice, could not hold more than one. The sword-and-basket trick was common in India many years ago. In one form it consisted in inverting an empty basket over a child upon the ground; after the child had secreted himself between the basket-bottom and a belt concealed by a curtain painted to look like the actual wicker bottom, a sword was thrust through both sides of the basket, the child screaming, and squeezing upon the sword and upon the ground a blood-coloured liquid from a sponge. When the performer upset the basket, the child could not be seen; but another child similarly costumed suddenly appeared among the spectators, having been up to that time supported by a pair of stirrups under the cloak of a confederate among the bystanders. In another form an oblong basket is used large at the bottom and tapering to the top, with the lid occupying only the central portion of the top, and the child is so disposed round the basket that the sword plunged downward avoids him, and the performer can step inside and stamp upon the bottom to prove that the basket is empty. In 1865 Stodare introduced the trick into England, but in a new manner. Upon light trestles he placed a large oblong basket; and after a lady attired in a profuse muslin dress had composed herself and her abundance of skirt within, and the lid had been shut and the sword plunged through the sides, the basket was tilted towards the audience to show that it was empty, and the lady reappeared in a gallery of the hall. The basket was formed with an outer shell to turn down, leaving the lady with her dress packed together lying upon the basket bottom and behind what had formed a false front side,—the principle being the same as in the clown's box, which, when containing a man, is rolled over to display the inside empty. The reappearing lady was a double, or twin sister.

Among the most meritorious and celebrated mechanical illusions have been automaton figures secretly influenced in their movements by concealed operators. In the 17th century M. Raisin, organist of Troyes, took to the French court a harpsichord which played airs as directed by the audience; but, upon opening the instrument, Louis XIV. discovered a youthful performer inside. In 1769 Baron Kempelen, of Pressburg, in Hungary, completed his chess-player, which for a long time remained the puzzle of Europe. It was an illusion,—the merit consisting in the devices by which the confederate player was hidden in the cabinet and body of the figure, while the interior

was opened in successive instalments to the scrutiny of the spectators. The first player was a Polish patriot, Worousky, who had lost both legs in a campaign; as he was furnished with artificial limbs when in public, his appearance, together with the fact that no dwarf or child travelled in Kempelen's company, dispelled the suspicion that any person could be employed inside the machine. This automaton, which made more than one tour to the capitals and courts of Europe, and was owned for a short time by Napoleon I., was exhibited by Mälzel after the death of Kempelen in 1819, and ultimately perished in a fire at Philadelphia in 1854. A revival of the trick appeared soon afterwards in Hooper's "Ajeeb," shown at the Sydenham Crystal Palace and elsewhere. A chess-playing figure, "Mephisto," designed by Gumpel, was also exhibited. No space existed for the accommodation of a living player within; but, as there was no attempt at isolating the apparatus from mechanical communication through the carpet or the floor, there was nothing to preclude the moving arm and gripping finger and thumb of the figure from being worked by any convenient connexion of threads, wires, rods and levers. In 1875 Maskelyne and Cooke produced at the Egyptian Hall, in London, an automaton whist-player, "Psycho," which, from the manner in which it was placed upon the stage, appeared to be perfectly isolated from any mechanical communication from without; there was no room within for the concealment of a living player by aid of any optical or other illusion, and yet the free motions of both arms, especially of the right arm and hand in finding any card, taking hold of it, and raising it or lowering it to any position and at any speed as demanded by the audience, indicated that the actions were directed from without. The arm had all the complicated movements necessary for chess or draught playing; and "Psycho" calculated any sum up to a total of 99,000,000. A still more original automaton was Maskelyne's figure "Zoe," constructed in 1877, which wrote and drew pictures at dictation of the audience. "Zoe," a nearly life-size but very light doll, sat loose upon a cushioned skeleton-stand, of which the solid feet of the plinth rested upon a thick plate of clear glass laid upon the floorcloth or carpet of the stage. "Psycho," a smaller oriental figure, sitting cross-legged on a box, was supported by a single glass cylinder of clear glass, which, as originally exhibited, stood upon the carpet of the stage, but was afterwards set loose upon a small stool, having solid wood feet.

That a mysterious and apparently elaborate mechanical movement may, after all, possess the utmost simplicity is illustrated by the familiar conjuring trick known as "rising cards." Four cards having been chosen by the audience and returned to the pack, this is placed end upwards in a glass goblet, or in a thin case not deep enough to hide the pack, upon the top of a decanter or upon a stick. At command, the cards rise, one at a time, out of the pack; one rises part of the way and sinks back again; one rises quickly or slowly as directed; one comes out feet first, and, on being put back, rises head upwards like the others; and one dances in time to music, and finally jumps out of the pack. At the conclusion there remain only the goblet or the case and the cards, subject to the minutest examination of any one from the audience, without a trace of moving mechanism visible. This was one of the chief *jeux* of Louis Christian Comte, the French conjuror and ventriloquist, at the end of the 18th century, and in varied forms has been popular to the present day. Probably it was suggested by the earlier device of the golden head dancing in a glass tumbler, which is described in *The Conjuror Unmasked* (1790). Several crown pieces were put in the glass, a small gilded head above them, and a plate or other flat cover laid upon the mouth of the glass; yet the head thus isolated jumped inside the glass so as to count numbers and answer questions. The secret communicator of motion was a fine silk thread attached to the head and passing through a tiny notch cut in the lip of the glass, and so to a confederate who pulls it. In the case of the rising cards the whole of the movements are effected by arranging a single silk thread in the previously prepared pack, passing over some cards and under others, and led behind the decanter or other

support to the stage and thence to the confederate. As this infinitely simple mechanical agent is drawn altogether out of the pack after the last card has risen, literally no trace remains of any means of communicating motion to the cards.

Oriental ingenuity, which furnished the original idea of the ethereal suspension trick, contributed the Chinese rings introduced into England in 1834; also the Chinese feat of producing a bowl of water with gold-fish out of a shawl, first seen in England in 1845, and the Indian rope-tying and sack feats upon which the American brothers Davenport founded a distinct order of performances in 1859. Their quick escape from rope bonds in which they were tied by representatives of the audience, the instantaneous removal of their coats in a dark séance, leaving themselves still bound, and their various other so-called "phenomena" were exposed and imitated by Maskelyne, who, in 1860, greatly surpassed any feats which they had accomplished. He proceeded to exhibit himself floating in the air, to show "materialized spirit forms," and to present a succession of wonders of the spirit mediums in novel performances. One of Maskelyne's cleverest inventions was the box which he constructed in 1860; it closely fitted when he packed himself in a cramped position within; it was enclosed in a canvas wrapper, corded with any length and complicated meshing of rope, and the knot sealed, yet his escape was effected in seven seconds. Taking more time, he performed the converse of these operations except the sealing. Provided with the wrapper and the open box, himself standing outside, he drew a curtain before him to conceal the *modus operandi*, and in a few minutes was found in the box, which, though so small as to permit no limb to be moved more than a few inches, he nevertheless wrapped and corded as exactly as if he had operated from the outside.

Modern conjuring has given rise to many interesting developments, but none perhaps attracted a larger share of public attention than the legal battle in the last years of the century over this box-trick. The case had a special interest in England, from the fact that it was the only one in which a trick had ever occupied the attention of the House of Lords. The litigation arose in this way. Mr Maskelyne had been in the habit of offering a considerable reward to any one who could produce a correct imitation of his box-trick. The offer was a direct challenge to imitators, and was intended to show—as nothing else could have done—that the tricks sold and exhibited as "correct imitations" were not what they professed to be. Two amateur mechanicians, having made or procured a box externally resembling Mr Maskelyne's, gave a private performance before a few friends, and then claimed the reward. Mr Maskelyne refused to pay, his contention being that hundreds of people had already escaped from locked and corded boxes resembling his in appearance. Indeed, it was for that very reason that he had been compelled to make the offer. The claimants then brought an action to recover £500—the amount offered. Mr Maskelyne produced his box in court, and challenged the plaintiffs to expose the secret, contending that they could not possibly imitate correctly a trick of which they did not know the secret. Their point, however, was that they had nothing to do with the secret, and that a box-trick was not a trick-box. The jury, being unable to decide whether a mechanical trick is a piece of mechanism or the effect it produces, could not agree, and were discharged. In a second trial, the jury, after much deliberation, found for the plaintiffs. Mr Maskelyne appealed against the verdict. His appeal occupied the court for three days, and was dismissed. Finally he carried the case to the House of Lords, and lost it. The majority of the law lords, while fully admitting that the secret had never been discovered, were of opinion that the trick had been correctly "imitated." To people dealing with mechanical devices this decision is bound to appear not a little curious. A mechanical trick is a mechanical invention, and when we have two absolutely different inventions, although they may produce more or less similar results, one is by no means an *imitation* of the other—to say nothing of a "correct imitation." Applied to inventions generally, such a ruling would produce disastrous results.

To those interested in magic, however, one effect of the

litigation was to intensify the mystery surrounding the original box-trick. The whole matter has been publicly thrashed out. It has been learned that the trick, generally, consists of a movable panel fastened by a secret catch. Provided that the rope be not too severely knotted over that panel, the performer can escape; but otherwise failure is inevitable. Further, it is known that the original trick has never failed, even under the most severe tests, whereas the imitations have failed repeatedly. There can only be one reason for this—a great difference in the mechanical principles employed.

Like most forms of refined entertainment the conjuror's magic appears to have kept well abreast of the times. Certainly, at no period of the world's history has it ever been so popular as at present. As a natural consequence, so many skilled exponents of the art have never before existed. Yet there is one respect in which at the present day conjuring shows no advance upon the records of earlier times. The one great peculiarity in connexion with magic, at every period, has been the limited number of those who prove themselves capable of originating magical effects. This peculiarity has never been more thoroughly emphasized than at present. Since the days of Robert-Houdin, only two men have attained any remarkable degree of prominence—Mr Maskelyne and M. Buatier de Kolta. There are many who, as entertainers, are entitled to rank with the highest, but to those two only can prominence be justly given as originators. The only logical conclusion to be drawn is that to invent original illusions is a matter of no ordinary difficulty, and, indeed, all who have attempted work of that kind will admit that such is the case. When, however, an original principle has been invented, it may be utilized in producing many and apparently quite distinct effects. As an example of this, Maskelyne's "Cleopatra's Needle," invented in 1879, may be mentioned. The trick consisted of a piece of mechanism representing an exceedingly light model of the famous obelisk. So light was it, in fact, that it could easily be lifted with one hand. Upon an isolated stand, previously examined by the audience, a sheet of ordinary brown paper was laid, and on this the "needle" was placed. Thus during the performance communication with the obelisk was obviously impossible. Yet from within it human beings emerged in a most startling manner. The secret consisted in the fact that the "needle" was capable of being lifted by invisible means, and from the outset contained two or three persons concealed within it. Notwithstanding the fact that this illusion was one of Mr Maskelyne's simplest devices, it puzzled even experts for a considerable time. When at last the secret leaked out, the principle was seized upon with avidity and utilized in a variety of ways—for example, by M. Buatier de Kolta in his beautiful illusion, "The Cocoon," first produced at the Egyptian Hall, London, in 1887. In this case de Kolta had the advantage of Mr Maskelyne's assistance in perfecting the mechanical details. De Kolta's smaller tricks have for years supplied the whole army of ordinary conjurors with novelties. In 1886, at the Eden Theatre, Paris, he introduced his famous illusion known as "The Vanishing Lady." This mystery, performed as he alone could perform it, was one of the most effective tricks ever exhibited. Hundreds of "imitations" were, of course, produced; but, like the imitations of Mr Maskelyne's box, they sink into insignificance when compared with the original; and in this case, unfortunately for the originator, the reputation of the original was speedily ruined by clumsy exponents, who only succeeded in exposing the principle. The effect produced by de Kolta was as follows:—Taking from his pocket what appeared to be an ordinary newspaper, folded, he opened it out and laid it upon the stage. Then a chair was shown, front and back, to the audience, and placed upon the paper. Madame de Kolta, in ordinary evening dress, then took her seat upon the chair, and a large piece of black silk was thrown over her, enveloping her from head to foot. Then de Kolta would shout, "I'll throw you in the air!"—or words to that effect—and to all appearance he grasped her round the waist, lifted her above his head, and she vanished, covering and all, at his finger-tips.

Among the illusions depending for their effect upon sudden

disappearance, perhaps the most inexplicable was that produced by Mr Maskelyne in 1891 under the appropriate title of "Oh!"—that being an expression frequently used by spectators upon witnessing the startling effect. In the illusion the performer whose disappearance was to be effected seated himself upon a raised couch, above which a kind of canopy was supported upon brass rods. From the canopy depended curtains capable of being raised or lowered. The right hand of the performer was strapped to one end of this couch, and the left hand was secured by means of a strap attached to one end of a stout cord. The other end of the cord, having been passed through a hole in the framework of the canopy, was securely held by a member of the audience. The curtains were then lowered to within 18 in. of the ground, and through an aperture in the front curtain the performer's right hand was passed. This hand, again, was held by a second member of the audience. Finally, a sheet of iron was placed beneath the couch, to prevent any possibility of the performer's escape being effected through a trap in the stage. Thus, with the performer's right hand in full view, his left drawn upwards by the cord attached to it, and a clear space below the couch, escape seemed impossible; yet, upon the word "Go!" the right hand disappeared, the cord became slack in the hands of the holder, the curtains were instantly raised, and the performer had vanished.

In 1886 M. Buatier de Kolta, in conjunction with Mr Maskelyne, presented at the Egyptian Hall, London, a series of illusionary effects upon an entirely novel principle, to which they gave the name of "Black Magic." The main idea was based upon the fact—obvious when once it is pointed out—that visible form cannot exist in the absence of shadow or varying tint. In other words, we can only distinguish forms when they exhibit either variations in colour or shade. Absolute uniformity must, necessarily, mean invisibility. To bring about this uniformity, the entire stage was draped in black velvet, giving it the appearance of a dark and immensely deep cavern. There were no lights within it, though from the front it was brilliantly illuminated. Upon the stage, thus prepared, the most startling appearances and disappearances took place, within a few feet of the footlights. The illusions were produced by the simple method of covering anything to be concealed by screens of black velvet. These could be brought almost to the front of the stage, and yet would remain invisible; thus, in an instant, persons or articles would appear, apparently from space, or would disappear into it. The principle involved in the production of these illusions was adopted subsequently by many conjurors, and has served to produce an almost endless variety of effects.

The production of innumerable blossoms from a sheet of paper was undoubtedly the prettiest of M. Buatier de Kolta's smaller tricks. A small sheet of cartridge-paper is twisted into a cone, which is shown to be empty, but immediately artificial blossoms begin to pour out of it, until quite a bushel of them are piled up. Unfortunately for the inventor, the first time he introduced the trick at the Eden Theatre, Paris, one or two of the "blossoms" were carried by a draught of air into the auditorium. These were at once sold to a manufacturer of conjuring appliances, and within a few days de Kolta's "Spring Blossoms" were upon the market.

Another startling trick, by the same inventor, is "The Flying Cage." A live bird is imprisoned within a small cage, held between the performer's hands, when suddenly, by a quick movement of the arms, both bird and cage vanish. The cage simply collapses, and is drawn by a string up the coat-sleeve, the unfortunate bird being sometimes maimed, if not killed outright. The Society for the Prevention of Cruelty to Animals once took action in the matter, and sought to prevent the performance of the trick at one of the London music-halls; but the conjuror in this case invited the officials to witness a private demonstration, and was clever enough to convince them that there was no cruelty. Conjuring with animals has a great charm for young folk, and happily it is very seldom that a trick involves any cruelty whatever. The animals, as a rule, quickly

become accustomed to the business, and appear thoroughly to understand what is required of them.

In recent years the mystery known as "Second Sight" has been vastly improved. The old system, invented by Pinetti in 1785, and brought to great perfection by Robert-Houdin, has almost disappeared. It consisted of an elaborate code of signals, given by means of subtle variations in the questions put to the supposed clairvoyant; the form in which the question was put conveying the appropriate answer. Now it is customary to avoid speech altogether. The information is conveyed by means of gesture or slight sounds at varying intervals. This business requires an enormous amount of practice, and an abnormal memory on the part of those who become expert.

But there are certain tricks of this class which require little or no skill and a very small amount of practice. These are generally introduced by impostors who claim or tacitly suggest the possession of supernatural powers. The following is a very familiar example of the kind of trick employed by such persons. The performers are usually a man and a woman. The man first appears, and informs the audience that he will shortly introduce a lady possessing extraordinary powers. Not only can she read the thoughts of any person whose mind is *en rapport* with hers, but also she can foretell the future, trace missing friends, discover lost property, &c. In order to display the lady's capabilities, he requests that any members of the audience who have questions they would like answered will write them secretly. For convenience in writing, slips of paper, pencils and squares of thick millboard are passed round, the millboard squares being for use as writing-desks. The writers are particularly cautioned to allow no one to see what is written, but to fold up the papers and retain them in their own possession. Further, the writers are instructed that, when the clairvoyant appears, the thoughts of each must be kept intently fixed upon what he has written. The pencils and millboards are then collected, and the preparations being so far complete, other portions of the entertainment are proceeded with. Finally, as the last item in the programme, the clairvoyant is introduced. A handkerchief, upon which some liquid has been poured, is held over the lady's nose and mouth, and apparently she falls into a trance. Then she proceeds to describe the appearance of certain of the writers, the position they occupy in the room, and the nature of the questions they have written, giving to those questions more or less plausible answers. The trick never fails to produce the most profound astonishment, and by its means several persons have made rapid strides to fortune. But the whole business is an impudent imposture. Therefore it cannot be too often or too thoroughly exposed. It is accomplished as follows. Some of the millboards passed round for convenience in writing are built up of a number of thicknesses, fastened together at the edges only. Beneath the outer layer a sheet of carbon paper is concealed, so that the pressure of the pencil causes a reproduction in duplicate to be impressed upon an inner layer of cardboard. These prepared pads are handed round by attendants, who note the dress and appearance of the persons by whom the questions are written. That information, together with the prepared pads, is subsequently conveyed to the clairvoyant. She requires a certain amount of time in order to memorize the questions and the description of the writers; consequently she is not introduced to the audience until, say, an hour has elapsed. Of course, it would not be discreet to have all the millboards prepared. Many of them, perhaps the majority, are really what they appear to be; but, needless to say, the questions written upon these are never answered. It is carefully pointed out beforehand that the clairvoyant can only read the questions of those whose minds are in sympathy with hers. That statement, naturally, serves to account for her inability to read or answer questions written by those who have used the plain millboards.

In connexion with this trick a further imposture is carried out by inviting strangers to send, by post, any questions they wish to have answered. Such an invitation appears to be quite straightforward and genuine, but those who are sufficiently credulous or sufficiently curious to respond to it lend themselves

to the perpetration of an ingenious fraud. In reply to any such communication, the writer is informed that it is necessary for him to attend one of the public performances, and endeavour to bring his mind into harmony with that of the clairvoyant. Enclosed is a complimentary ticket entitling him to attend any performance he pleases. The procedure, then, is simply this. Each ticket bears a private mark, and a corresponding mark is put upon the letter written by the person to whom it is sent. When any marked ticket is presented, the attendant notes the dress and appearance of the visitor and the seat he occupies. That information is given to the clairvoyant, together with the ticket. She refers to the letter bearing the mark corresponding to the ticket, and ascertains what that particular visitor wishes to know. Thus to the public she appears to read and answer a question which has not been written down, but merely thought of by a total stranger. There are numerous methods of obtaining information by means similar to those already described. Sufficient, however, has been said to show that such devices are of the simplest, and require nothing more than a callous effrontery to carry them into effect. Of course, all kinds of mishances are bound to occur. But, when one is supposed to be dealing with undiscovered laws of nature, it does not require much ingenuity to wriggle out of any situation, however difficult.

Modern magic calls to its aid all the appliances of modern science—electricity, magnetism, optics and mechanics; but the most successful adepts in the art look down upon all such aids and rely upon address and sleight of hand alone. The prestidigitator's motto is "The quickness of the hand deceives the eye"; but this very phrase, which is always in a performer's mouth, is in itself one of the innocent frauds which the conjuror employs as part and parcel of his exhibition. The truth is that it is not so much upon the quickness with which a feat is performed as upon the adroitness with which the time and means of performing it are concealed that its success depends. The right opportunity for executing the required movement is technically called a *temps*. This is defined to be any act or movement which distracts the attention of the audience while something is being "vanished" or "produced." Experiment will readily convince any one that it is absolutely impossible to move the hand so quickly as to abstract or replace any object without being perceived, so long as the eyes of the audience are upon the performer. But it is very easy to do so unnoticed, provided the audience are looking another way at the time; and the faculty of thus diverting their attention is at once the most difficult and the most necessary accomplishment for a conjuror to acquire. It does not suffice to point, or ask them to look in another direction, because they will obviously suspect the truth and look with all the more persistence. The great requisite is to "have a good eye"—in French conjuring parlance *avoir de l'œil*; an earnest, convinced look of the performer in a particular direction will carry every one's glances with it, while a furtive glance at the hand which is performing some function that should be kept secret will ruin all.

The motto prefixed by Robert-Houdin to his chapter on the "Art of Conjuring" is—"to succeed as a conjuror, three things are essential: first, dexterity; second, dexterity; and third, dexterity"; and this is not a mere trick of language, for triple dexterity is required, not only to train the hand to the needful adroitness, but to acquire the requisite command of eye and tongue. Unfortunately this dexterity may be applied not only to conjuring but to cheating, particularly in the case of card-sharps. It takes various forms: (1) marking the cards; (2) abstracting certain cards during the game for clandestine use; (3) previously concealing cards about the person; (4) packing the cards; (5) substituting marked or prepared packs; (6) confederacy; (7) false shuffles. All these methods are thoroughly exposed in Robert-Houdin's work *Les Tricheries des Grecs*. The successful card-sharp must have qualities which, if applied in a legitimate direction, would ensure distinction in almost any profession.

In the case of purely dexterical tricks, little advance has been made. Recently some new sleights were introduced from

America. These consist in an amplification of the method of concealing coins and cards at the back of the fingers. The principle has received the incongruous title of "back-palming." By means of this method both back and front of the hand alternately can be shown empty, while, notwithstanding its apparent emptiness, the hand nevertheless conceals a coin or card. The first and fourth fingers are caused to act as pivots, upon which the concealed articles are turned from front to back, and vice versa, the turning being performed by the second and third fingers. The movement is very rapid, and is accomplished in the act of turning over the hand to show the two sides alternately. The sleight requires an enormous amount of practice. It has been brought to the highest state of perfection by Herr Valadon.

In all ages a very popular magical effect has been the apparent floating of a person in empty space. An endless variety of ingenious apparatus has been invented for the purpose of producing such effects, and the present article would be incomplete without some reference to one or two of the more modern examples. A very pretty illusion of this kind is that originally produced under the title of "Astarte." A lady is brought forward, and after making her bow to the audience she retires to the back of the stage, the whole of which is draped with black velvet and kept in deep shadow. There she is caused to rise in the air, to move from side to side, to advance and retire, and to revolve in all directions. The secret consists in an iron lever, covered with velvet to match the background, and therefore invisible to the audience. This lever is passed through an opening in the back curtain and attached to a socket upon the metal girdle worn by the performer. The girdle consists of two rings, one inside the other, the inner one being capable of turning about its axis. By means of this main lever and a spindle passing through it and gearing into the inner ring of the girdle, the various movements are produced. A hoop is passed over the performer with a view to demonstrate her complete isolation, but the audience is not allowed to examine it. It has a spring joint which allows it to pass the supporting lever. Among illusions of this class there is probably none that will bear comparison with the "levitation" mystery produced by Mr Maskelyne. A performer, in a recumbent position, is caused to rise several feet from the stage, and to remain suspended in space while an intensely brilliant light is thrown upon him, illuminating the entire surroundings. Persons walk completely round him, and a solid steel hoop, examined by the audience, is passed over him, backwards and forwards, to prove the absence of any tangible connexion.

The secrets of conjuring were for a long time jealously guarded by its professors, but in 1793 a work appeared in Paris, by M. Decremps, entitled *Testament de Jérôme Sharpe, professeur de physique amusante*, which gives a very fair account of the methods then in vogue. In 1858 a still more important and accurate book was published—*Sorcellerie ancienne et moderne expliquée*, by J. N. Pousin; and in 1868 J. E. Robert-Houdin issued his *Secrets de la prestidigitation et de la magie*, which is a masterly exposition of the entire art and mystery of conjuring. The last-mentioned book was translated into English by Professor Louis Hoffman, the author of *Modern Magic*. See also Hoffman, *More Magic*, and *Later Magic*; Edwin Sachs, *Sleight of Hand*; and J. N. Maskelyne, *Sharps and Flats*. (J. A. CL.; G. FA.; J. N. M.)

CONKLING, ROSCOE (1829-1888), American lawyer and political leader, was born in Albany, New York, on the 30th of October 1829. He was the son of Alfred Conkling (1789-1874), who was a representative in Congress from New York in 1821-1823, a Federal district judge in 1825-1852, and U.S. minister to Mexico in 1852-1853. Roscoe Conkling was admitted to the bar at Utica, New York, in 1850, was appointed district-attorney of Oneida county in the same year, and soon attained success in the practice of his profession. At first a Whig, he joined the Republican party at its formation, and was a Republican representative in Congress from 1859 to 1863. He refused to follow the financial policy of his party in 1862, and delivered a notable speech against the passage of the Legal Tender Act, which made a certain class of treasury notes receivable for all public and private debts. In this opposition he was joined by his brother,

Frederick Augustus Conkling (1816-1891), at that time also a Republican member of Congress. In 1863 he resumed the practice of law, and in April 1865 was appointed a special judge advocate by the secretary of war to investigate alleged frauds in the recruiting service in western New York. He was again a representative in Congress from December 1865 until 1867, when he entered the Senate. After the war he allied himself with the radical wing of his party, was a member of the joint committee that outlined the congressional plan of reconstructing the late Confederate States, and laboured for the impeachment of President Johnson. During President Grant's administration he was a member of the senatorial coterie that influenced most of the president's policies, and in 1873 Grant urged him to accept an appointment as chief justice of the Supreme Court, but he declined. In the Republican national convention of 1876 Conkling sought nomination for the presidency, and after the disputed election of this year he took a prominent part in devising and securing the passage of a bill creating an electoral commission. In 1880 he was one of the leaders of the unsuccessful movement to nominate Grant for a third presidential term. With Grant's successors, Hayes and Garfield, his relations were not cordial; an opponent of civil service reform, he came into conflict with President Hayes over the removal of Chester A. Arthur and other federal office-holders in New York; and when in 1881 President Garfield, without consulting him, appointed William H. Robertson, a political opponent of Conkling, as collector of the port of New York, and when this appointment was confirmed by the Senate in spite of Conkling's opposition, Conkling and his associate senator from New York, Thomas C. Platt, resigned their seats in the Senate and sought re-election as a personal vindication. Being unsuccessful, Conkling took up the practice of law in New York city, again declining, in 1882, a place on the bench of the Supreme Court, and appeared in a number of important cases. While in public life Conkling always attracted attention by his abilities, his keenness and eloquence in debate, his aggressive leadership and his striking personality. Though always a strenuous worker in Congress, he was not the originator of any great legislative measures, and his efficiency as a law-maker is thought to have been much impaired by his personal animosities. His hostility to James G. Blaine, a fellow Republican senator, was especially marked. He died in New York city on the 18th of April 1888.

See A. R. Conkling (ed.), *The Life and Letters of Roscoe Conkling* (New York, 1889).

CONN, LOUGH, a lake of western Ireland, in Co. Mayo. Its length (N.N.W. to S.S.E.) is 9 m. and its extreme breadth rather over 4 m., but two promontories projecting from opposite shores about the centre narrow it to less than 1 m. On the south a passage so narrow as to be bridged communicates with Lough Cullin; the current through this channel, normally from Conn to Cullin, is sometimes reversed. The total length of the two loughs is nearly 12 m. They drain eastward by a short channel tributary to the Moy, and the principal affluents are the Deel and the Manulla. Lough Conn lies 42 ft. above sea-level. It contains a few islands, and its shores are generally low, but the isolated mass of Nephin (2646 ft.) rises finely on the west. The lake is in favour with anglers.

CONNAUGHT, ARTHUR WILLIAM PATRICK ALBERT, DUKE OF (1850-), third son and seventh child of Queen Victoria, was born at Buckingham Palace on the 1st of May 1850. Being destined for the army, the young prince was entered at the Royal Military Academy, Woolwich, in 1866, and gazetted to the Royal Engineers on the 19th of June 1868. In the following November he was transferred to the Royal Artillery, and on the 3rd of August 1869 to the Rifle Brigade. He became captain in 1871, and, transferred to the 7th Hussars in 1874, was promoted major in 1875, and returned to the Rifle Brigade as lieutenant-colonel in September 1876. He was promoted colonel and major-general in 1880, lieutenant-general in 1889, and general in 1893. He accompanied the expeditionary force to Egypt in 1882, and commanded the Guards brigade at the battle of Tel-el-Kebir. He was mentioned three times in despatches, received the C.B.

and was thanked by parliament. In 1886 the duke went to India and commanded the Bombay army until 1890, when he returned home. He commanded the southern district from 1890 to 1893, and that of Aldershot from 1893 to 1898. On the departure of Lord Roberts for South Africa the duke succeeded him as commander-in-chief of the forces in Ireland, 9th of January 1900. On attaining his majority in 1871 an annuity of £15,000 was granted to Prince Arthur by parliament, and in 1874 he was created duke of Connaught and Strathearn and earl of Sussex. On the 13th of March 1879 he married Princess Louise Marguerite of Prussia, third daughter of Prince Frederick Charles, and received an additional annuity of £10,000. The duke and duchess represented Queen Victoria at the coronation of the tsar Nicholas II. at Moscow in 1896. On the reorganization of the war office and the higher commands in 1904, the duke was appointed to the new office of inspector-general to the forces, from which he retired in 1907, being then given the new post of commander-in-chief in the Mediterranean, stationed at Malta, which he held until 1909.

CONNAUGHT, a province of Ireland occupying the mid-western portion of the island, and having as the greater part of its eastern boundary the river Shannon, over its middle course. It includes the counties Mayo, Sligo, Leitrim, Galway and Roscommon (*qq.v.* for topography, &c.). According to the legendary chronicles of Ireland, Connaught (Connacht) was given by the Milesian conquerors of the country to the Damnonians, and the *Book of Leinster* gives Tinne mac Conrath (20 B.C.) as the first of the list of the kings of all Connaught, whose realm at its greatest extent included also the district of Brenny or Breffny, corresponding to the modern county of Cavan. The Damnonian dynasty held its own till the 4th century A.D., when it was ousted by the Milesian Muireadbach Tireach, king paramount (*airdriugh*) of Ireland from 331 to 357. Henceforth the annals of Connaught are of little interest until the end of the 12th century, when William de Burgh received a grant of lands in Connaught from King John as lord paramount of Ireland. In the quarrel between Cathal Carrach and Cathal Crovderg for the throne he supported either side in turn, with the result that he lost his Connaught estates in 1203. In 1207, however, his son Richard received a grant from King Henry III. of the forfeited lands of the king of Connaught, and thenceforth the history of the province is closely bound up with that of the great family of Burgh (*q.v.*). In 1461 Connaught, with Ulster, fell nominally to the crown, in the person of Edward IV., as heir of Lionel, duke of Clarence, and his wife, daughter and heiress of William de Burgh, 3rd earl of Ulster (d. 1333). In the wild districts of the west of Ireland, however, legal titles were easier to claim than to enforce, and from 1333 onward Connaught was in fact divided between the de Burghs, Bourcks or Burkes (MacWilliam "Oughters" and MacWilliam "Eighters"), assimilated now to the Irish in dress and manners, and the native kings of the ancient Milesian dynasty, which survived till 1464. It was not till the 16th century that Connaught began to be effectively brought under English rule. A stage in this direction was marked by the conversion in 1543 of the MacWilliam Eighter, Ulick Bourck, into a noble on the English model as earl of Clanricarde; though it was not till 1603 that the MacWilliam Oughter became Viscount Mayo. Meanwhile, about 1580, Connaught was for the most part divided into shires by Sir Henry Sidney, who also brought into existence the administration of Connaught and Munster by presidents, which continued for seventy years. The county Clare (hitherto Thomond or North Munster) was now annexed to Connaught, and continued to belong to it down to the Restoration.

CONNEAUT, a city of Ashtabula county, Ohio, U.S.A., on Lake Erie at the mouth of Conneaut Creek, and about 68 m. N.E. of Cleveland. Pop. (1890) 3,241; (1900) 7,133 (1,227 foreign-born); (1910) 8,319. It is served by the New York, Chicago & St. Louis (which has railway repair shops here), the Lake Shore & Michigan Southern, and the Bessemer & Lake Erie railways, and by car ferries which ply between Conneaut and Rondeau and Port Stanley on the Canadian side of Lake Erie. There is a beautiful public park of 20 acres on the lake shore. Conneaut

is situated in a grain-growing and dairying region; it has an excellent harbour to and from which coal and ore are shipped, and is a sub-port of entry. The city has planing mills, flour mills, brick works, tanneries, canneries and manufactories of electric and gas fixtures, electric lamps and tungsten gas lamps. The municipality owns and operates its electric-lighting plant. In 1796 surveyors for the Connecticut Land Co. built a log storehouse here, but the permanent settlement dates from 1798; in 1832 Conneaut was incorporated, and it became a city in 1898.

CONNECTICUT, one of the thirteen original states of the United States of America, and one of the New England group of states. It is bounded N. by Massachusetts, E. by Rhode Island, S. by Long Island Sound, and W. by New York; the S.W. corner projects along the Sound S. of New York for about 13 m. Situated between 40° 54' and 42° 3' N. lat., and 71° 47' and 73° 43' W. long., its total area is 4965 sq. m., of which 145 are water surface: only two states of the Union, Rhode Island and Delaware, are smaller in area.

Physiography.—Connecticut lies in the S. portion of the peneplain region of New England. Its surface is in general that of a gently undulating upland divided near the middle by the lowland of the Connecticut valley, the most striking physiographic feature of the state. The upland rises from the low S. shore at an average rate of about 20 ft. in a mile until it has a mean elevation along the N. border of the state of 1000 ft. or more, and a few points in the N.W. rise to a height of about 2000 ft. above the sea. The lowland dips under the waters of Long Island Sound at the S. and rises slowly to a height of only 100 ft. above them where it crosses the N. border. At the N. this lowland is about 15 m. wide; at the S. it narrows to only 5 m. and its total area is about 600 sq. m. Its formation was caused by the removal of a band of weak rocks by erosion after the general upland surface had been first formed near sea-level and then elevated and tilted gently S. or S.E.; in this band of weak rocks were several sheets of hard igneous rock (trap) inclined from the horizontal several degrees, and so resistant that they were not removed but remained to form the "trap ridges" such as West Rock Ridge near New Haven and the Hanging Hills of Meriden. These are identical in origin and structure with Mt. Tom Range and Holyoke Range of Massachusetts, being the S. continuation of those structures. The ridges are generally deeply notched, but their highest points rise to the upland heights, directly to the E. or W. The W. section of the upland is more broken than the E. section, for in the W. are several isolated peaks lying in line with the S. continuation of the Green and the Housatonic mountain ranges of Vermont and Massachusetts, the highest among them being: Bear Mountain (Salisbury) 2355 ft.; Gridley Mountain (Salisbury), 2200 ft.; Mt. Riga (Salisbury), 2000 ft.; Mt. Ball (Norfolk) and Lion's Head (Salisbury), each 1760 ft.; Canaan Mountain (North Canaan), 1680 ft.; and Ivy Mountain (Goshen), 1640 ft. Just as the surface of the lowland is broken by the notched trap-ridges, so that of the upland is often interrupted by rather narrow deep valleys, or gorges, extending usually from N. to S. or to the S.E. The lowland is drained by the Connecticut river as far S. as Middletown, but here this river turns to the S.E. into one of the narrow valleys in the E. section of the upland, the turn being due to the fact that the river acquired its present course when the land was at a lower level and before the lowland on the soft rocks was excavated. The principal rivers in the W. section of the upland are the Housatonic and its affluent, the Naugatuck; in the E. section is the Thames which is really an outlet for three other rivers (the Yantic, the Shetucket and the Quinebaug). In the central and N. regions of the state the course of the rivers is rapid, owing to a relatively recent tilting of the surface. The Connecticut river is navigable as far as Hartford, and the Thames as far as Norwich. The Housatonic river, which in its picturesque course traverses the whole breadth of the state, has a short stretch of tide-water navigation. The lakes which are found in all parts of the state and the rapids and waterfalls along the rivers are largely due to disturbances of the drainage lines by the ice invasion of the glacial period.

To the glacial action is also due the extensive removal of the original soil from the uplands, and the accumulation of morainic hills in many localities. The sea-coast, about 100 m. in length, has a number of bays which have been created by a depression of small valleys making several good harbours.

The climate of Connecticut, though temperate, is subject to sudden changes, yet the extremes of cold and heat are less than in the other New England states. The mean annual temperature is 49° F., the average temperature of winter being 27°, and that of summer 72°. Since the general direction of the winter winds is from the N.W. the extreme of cold (-10° or -15°) is felt in the north-western part of the state, while the prevailing summer winds, which are from the S.W., temper the heat of summer in the coast region, the extreme heat (100°) being found in the central part of the state. The annual rainfall varies from 45 to 50 in.

Agriculture.—Connecticut is not an agricultural state. Although three-fourths of the land surface is included in farms, only 7% of this three-fourths is cultivated; but agriculture is of considerable economic and historic interest. The accounts of the fertility of the Connecticut valley were among the causes leading to the English colonization, and until the middle of the nineteenth century agriculture was the principal occupation. The soils, which are composed largely of sands, except in the upland valleys where alluvial loams with the sub-soils of clay are found, were not suitable for tillage. However, a thrifty, industrious, self-reliant agricultural life developed, labour was native-born, the women of the household worked in the fields with the men, some employment was found for every season, and a system of neighbourly barter of food products took the place of other modes of exchange. But the development of manufactures in the first half of the 19th century, the competition of the new western states in farm products, and the change in the character of the population incident to the growth of cities, caused a great change in agriculture after 1860. Indeed, during every decade from 1860 to 1890 the total value of farm property and products declined; and the increase of products from 1890 to 1900 was due to the growth of dairy farms, which yielded almost one-third of the total farm product of the state. In the same decade Indian corn, potatoes and tobacco were the only staples whose acreage increased and the production of all cereals except Indian corn and buckwheat declined. Tobacco, which was first grown here between 1640 and 1660, because of a law restricting the use of tobacco to that grown in the colony, was in the decade 1890-1900 the only crop raised for consumption outside the state; its average yield per acre (1673 lb) was exceeded in the continental United States only in Vermont (1844 lb) and Massachusetts (1674 lb) in 1899, and in 1907 (1510 lb) by New Hampshire (1650 lb), Vermont (1625 lb) and Massachusetts (1525 lb). The total value of Connecticut tobacco in 1907 was \$2,501,000 (1906, \$4,415,922; 1905, \$3,911,933), and the average farm price was 11.5 cents per lb (in 1906, 18 cents; 1905, 17 cents). But the cultivation of tobacco is confined almost exclusively to the valleys of the Connecticut and Housatonic rivers, and these lands are constantly and expensively treated with nitrogenous fertilizers; the grades raised are the broad-leaf and the Habana seed-leaf wrappers, which, excepting the Florida growth from Sumatra seed, are the nearest domestic approach to the imported Sumatra. The manufacture of cigars was begun in South Windsor, Connecticut, in 1801. Dairying was responsible for the increased production between 1889 and 1899 of Indian corn and the large acreage in hay, which surpassed that of any other crop, but many hay and grain farms were afterwards abandoned. The production of orchard fruits and market vegetables, however, increased during the decade 1890-1900. Other evidences of the transition in agricultural life are that in Tolland and Windham counties the value of farm buildings exceeded that of farm land, that in Middlesex and Fairfield counties the acreage as well as the value of the farms declined, that native farm labour and ownership were being replaced by foreign labour and ownership; while dependent land tenure is insignificant, 87% of the farms being worked by

their owners. The state board of agriculture holds annual conventions for the discussion of agricultural problems.

Minerals.—The mineral industries of Connecticut have had a fortune very similar to that of agriculture. The early settlers soon discovered metals in the soil and began to work them. About 1730 the production of iron became an important industry in the vicinity of Salisbury, and from Connecticut iron many of the American military supplies in the War of Independence were manufactured. Copper was mined in East Granby as early as 1705 and furnished material for early colonial and United States coins. Gold, silver and lead have also been produced, but the discovery of larger deposits of these metals in other states has caused the abandonment of all metal mines in Connecticut, except those of iron and tungsten. The quarries of granite near Long Island Sound, those of sandstone at Portland, and of feldspar at Branchville and South Glastonbury, however, have furnished building and paving materials for other states; the stone product of the state was valued at \$1,386,540 in 1906. Limestone, for the reduction of lime, is also mined; and beryl, clays and mineral springs yield products of minor importance.

On account of the importations from Canada, Chesapeake Bay and the Great Lakes, the mackerel, cod and menhaden fisheries declined, especially after 1860, and the oyster and lobster fisheries are not as important as formerly. In 1905, according to the U.S. Bureau of Fisheries, the fisheries' products of the state were valued at \$3,173,948, market oysters being valued at \$1,206,217 and seed oysters at \$1,603,615.

Manufactures.—Manufacturing, however, has encountered none of the vicissitudes of other industries. Manufactures form the principal source of Connecticut's wealth,—manufacturing gave occupation in 1900 to about one-fifth of the total population, and the products in that year ranked the state eleventh among the states of the American Union. Indeed, manufacturing in Connecticut is notable for its early beginning and its development of certain branches beyond that of the other states. Iron products were manufactured throughout the 18th century, nails were made before 1716 and were exported from the colony, and it was in Connecticut that cannon were cast for the Continental troops and the chains were made to block the channel of the Hudson river to British ships. Tinware was manufactured in Berlin, Hartford county, as early as 1770, and tin, steel and iron goods were peddled from Connecticut through the colonies. The Connecticut clock maker and clock peddler was the 18th-century embodiment of Yankee ingenuity; the most famous of the next generation of clock makers were Eli Terry (1772-1852), who made a great success of his wooden clocks; Chauncey Jerome, who first used brass wheels in 1837 and founded in 1844 the works of the New Haven Clock Co.; Gideon Roberts; and Terry's pupil and successor, Seth Thomas (1786-1859), who built the factory at Thomaston carried on by his son Seth Thomas (1816-1888). In 1732 the London hatters complained of the competition of Connecticut hats in their trade. Before 1749 brass works were in operation at Waterbury—the great brass manufacturing business there growing out of the making of metal buttons. In 1768 paper mills were erected at Norwich, and in 1776 at East Hartford. In 1788 the first woollen mills in New England were established at Hartford, and about 1803 one hundred merino sheep were imported by David Humphreys, who in 1806 built a mill in that part of Derby which is now Seymour and which was practically the first New England factory town; in 1812 steam was first used by the Middletown Woollen Manufacturing Company. In 1804 the manufacture of cotton was begun at Vernon, Hartford county; mills at Pomfret and Jewett City were established in 1806 and 1810 respectively. Silk culture was successfully introduced about 1732; and there was a silk factory at Mansfield, Tolland county, in 1758. The period of greatest development of manufactures began after the war of 1812. The decade of greatest relative development was that of 1860-1870, during which the value of the products increased 96.6%. During the period 1850-1900, when the population increased 145%, the average number of wage-earners

CONNECTICUT

English Miles 10 15 20

County Seats
County Boundaries
Railroads

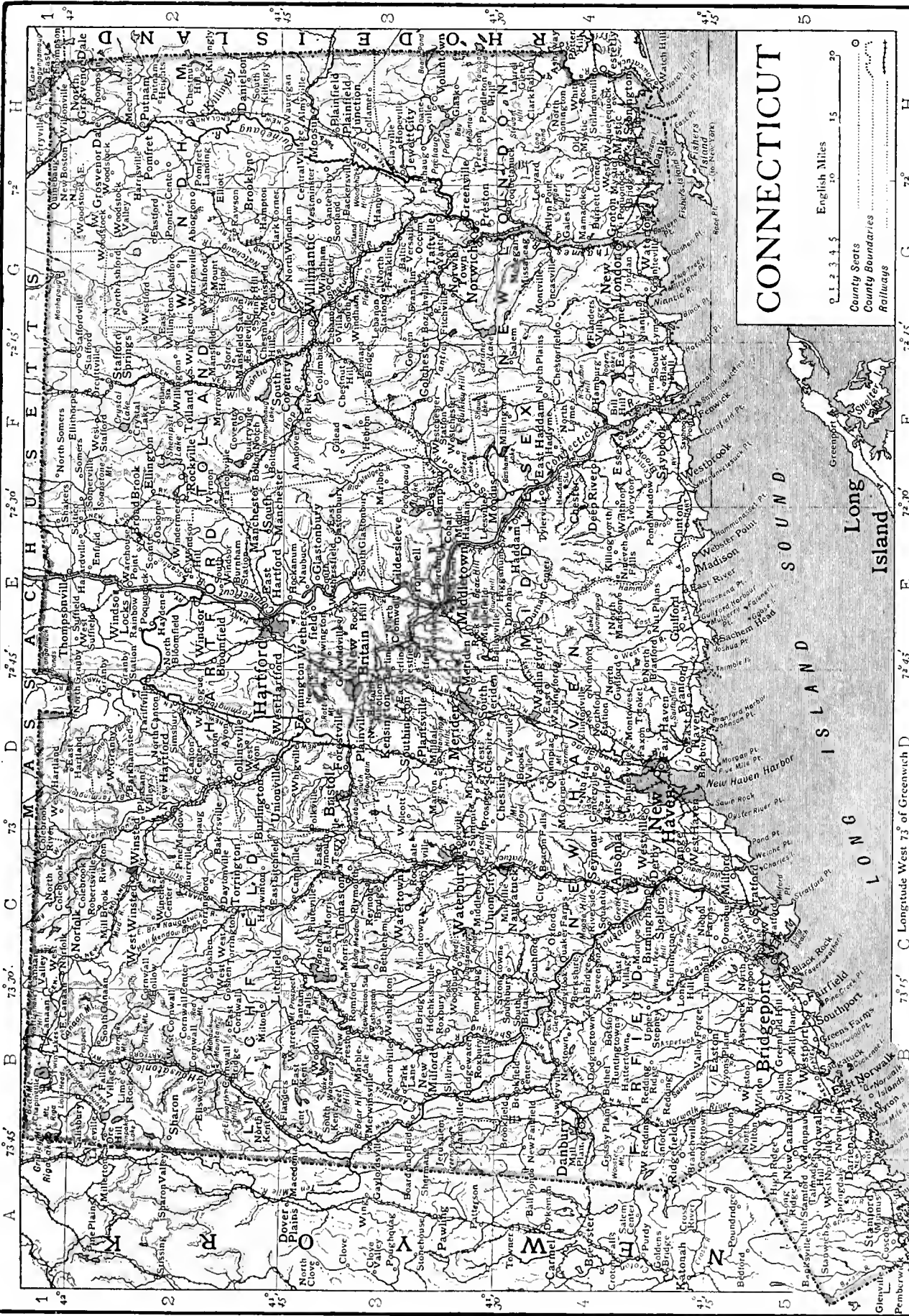

1
2
3
4
5
A
B
C
D
E
F
G
H
C Longitude West 73° of Greenwich D
73° 15' 73° 30' 73° 45' 73° 00' 73° 15'

Emery Walker SC.

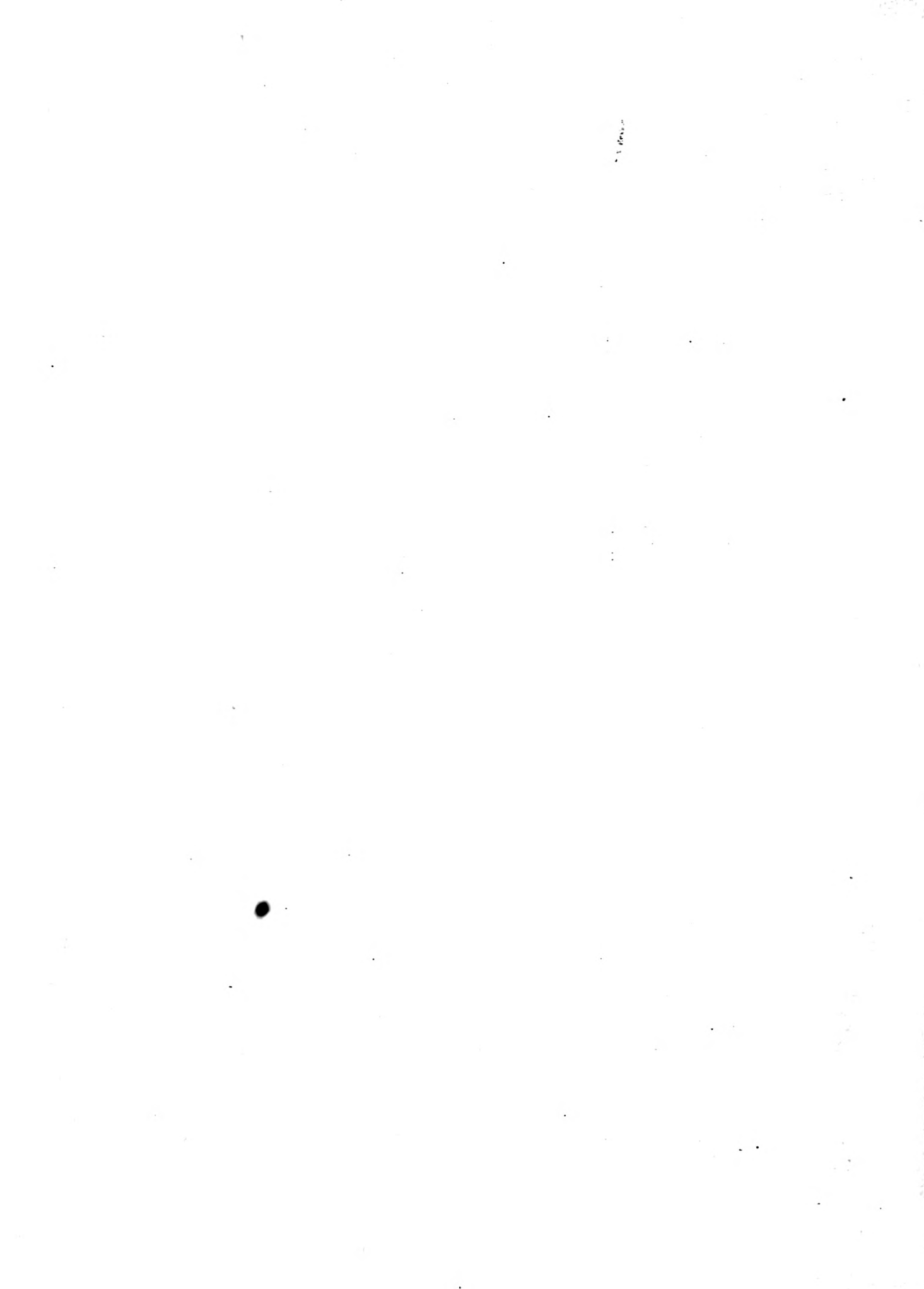

employed in manufacturing establishments increased 248.3%, the number so employed constituting 13.7% of the state's total population in 1850 and 19.5% of that in 1900. The average number of wage-earners employed in establishments conducted under the factory system alone was 13.7% greater in 1905 than in 1900. In 1900 Connecticut led the United States in the manufacture of ammunition, bells, brass and copper (rolled), brass castings and finishings, brass ware and needles and pins. In the automobile industry the state in 1905 ranked second (to Michigan) in capital invested; and was sixth in value of product, but first in the average value per car, which was \$2354 (\$2917 for gasoline; \$2343 for electric; \$673 for steam cars). Connecticut has long ranked high in textile manufactures, but the product of cotton goods in 1900 (\$15,489,442) and in 1905 (\$18,239,155) had not materially advanced beyond that of 1890 (\$15,409,476), this being due to the increase in cotton manufacturing in the South. Between 1890 and 1900 Connecticut's products in dyeing and finishing of textiles, industries which have as yet not developed in the South, increased 217.3% from \$715,388 in 1890 to \$2,269,967 in 1900, in 1905 their value was \$2,215,314. The manufacture of woollen goods and silk also increased respectively 33% and 26.5% between 1890 and 1900; the returns for 1900, however, include the fur hat product (\$7,546,882), which was not included in the returns for 1890. In 1905 the value of the woollen goods manufactured in the state was \$11,166,965; of the silk goods, \$15,623,693. The value of the products of all the textile industries combined increased from \$46,819,399 in 1900 to \$56,933,113 in 1905, when the combined textile product value was greater than that of any other manufactured product in the state. The most important single industry in 1905 was the manufacture of rolled brass and copper with a product value of \$41,911,903 (in 1900, \$36,325,178)—80.7% of the total for the United States; the value of the product of the other brass industries was brass ware (1905) \$9,022,427,—51.6% of the total for the United States,—(1900) \$8,947,451; and brass castings and brass finishing (1905) \$2,982,115, (1900) \$3,254,239. Hardware ranks next in importance, the output of 1905 being valued at \$21,480,652,—which was 46.9% of the total product value of hardware for the entire United States,—as against \$16,301,198 in 1900. Then come in rank of product value for 1905: foundry and machine shop products (1905) \$20,189,384, (1900) \$18,991,079; cotton goods; silk and silk goods; ammunition (1905) \$15,394,485,—being 77.2% of the value of all ammunition made in the United States,—(1900) \$9,823,712; and rubber boots and shoes (1905) \$12,829,346, (1900) \$11,999,038. In 1905 the state ranked first in the United States in the value of clocks manufactured,—\$6,158,034, or 69.4% of the total product value of the industry for that year in the United States,—and also in the value of plated ware—\$8,125,881, being 66.9% of the product value of the United States.

The decade of greatest absolute increase in the value of manufactures was that ending in 1900, the value of manufactured products in that year being \$352,284,116, an increase of \$104,487,742 over that of 1890.¹ The general tendency was towards the centralization of industry, the number of establishments in the leading industries increasing less than 5%, while the capital and the value of the products increased respectively 33.5% and 42%. Among the new manufactories were a ship-building establishment at Groton near New London, which undertook contracts for the United States government, and a compressed-air plant near Norwich. Of the 359 manufactured products classified by the United States census, 249, or almost seven-tenths, were produced in Connecticut.

This prominence in manufactures is due to excellent transportation facilities, to good water powers, to the ease with which labour is got from large cities, to plentiful capital (furnished by the large

¹ The figure given above as the gross value of all manufactured products in 1900 includes that of all manufacturing and mechanical establishments. The value of the products of factories alone was \$315,106,150. By 1905 this had increased to \$369,082,091 or 17.1%.

insurance and banking concerns of the state), and to Connecticut's liberal Joint Stock Act of 1837 (copied in Great Britain and elsewhere), permitting small sums to be capitalized in manufactures; and even to a larger extent, possibly it is the result of the ingenuity of the Connecticut people. In the two decades 1880-1900 more patents were secured in Connecticut in proportion to its population than in any other state. It was in Connecticut that Elias Howe and Allen B. Wilson developed the sewing machine; that Charles Goodyear discovered the process of vulcanising rubber; that Samuel Colt began the manufacture of the Colt fire-arms; and it was from near New Haven that Eli Whitney went to Georgia where he invented the cotton gin. The earliest form of manufacturing was that of household industries, nails, clocks, tin ware and other useful articles being made by hand, and then peddled from town to town. Hence Connecticut became known as the "Land of Yankee Notions"; and small wares are still manufactured, the patents granted to inventors in one city ranging from bottle-top handles, bread toasters and lamp holders, to head-rests for church pews and scissors-sharpeners. Then, after a long schooling in ingenuity by the system of household industries, came the division of labour, the introduction of machinery and the modern factory. Transportation of products is facilitated by water routes (chiefly coasting), for which there are ports of entry at New Haven, Hartford, Stonington, New London and Bridgeport, and by 1013 m. (on the 1st of January 1908) of steam railways. One company, the New York, New Haven & Hartford, controlled 87% of this railway mileage in 1904, and practically all the steamboat lines on Long Island Sound. Since 1895 electric railways operated by the trolley system have steadily developed, their mileage in 1909 approximating 895 m. By their influence the rural districts have been brought into close touch with the cities, and many centres of population have been so connected as to make them practically one community.

Population.—The population of Connecticut in 1880 was 622,700; in 1890, 746,258—an increase of 19.8%; in 1900, 908,420—an increase of 21.7% over that of 1890, and in 1910, 1,114,756. Of the 1900 population 98.2% were white, 26.2% were foreign born, and 31.1% of the native whites were of foreign parentage. Of the foreign-born element, 29.8% were Irish; there were also many Germans and Austrians, English, and French- and English-Canadians. In 1900 there were 24 incorporated cities or boroughs with a population of more than 5000, and on this basis almost three-fifths of the total population of the state was urban. The principal cities, having a population of more than 20,000, were New Haven (108,027), Hartford (79,850), Bridgeport (70,966), Waterbury (45,859), New Britain (25,998), and Meriden (24,296). The industrial development has affected religious conditions. In the early part of the 19th century the Congregational church had the largest number of communicants; in 1906 more than three-fifths of the church population was Roman Catholic; the Congregationalists composed about one-third of the remainder, and next ranked the Episcopalians, Methodists and Baptists.

Government.—The present constitution of Connecticut is that framed and adopted in 1818 with subsequent amendments (33 up to 1909). Amendments are adopted after approval by a majority vote of the lower house of the general assembly, a two-thirds majority of both houses of the next general assembly, and ratification by the townships. The executive and legislative officials are chosen by the electors for a term of two years; the attorney general for four years; the judges of the supreme court of errors and the superior court, appointed by the general assembly on nomination by the governor, serve for eight, and the judges of the courts of common pleas (in Hartford, New London, New Haven, Litchfield and Fairfield counties) and of the district courts, chosen in like manner, serve for four years. In providing for the judicial system, the constitution says: "the powers and jurisdiction of which courts shall be defined by law." The general assembly has interpreted this as a justification for interference in legal matters. It has at various times granted divorces, confirmed faulty titles, annulled decisions

of the justices of the peace, and validated contracts against which judgment by default had been secured. Qualifications for suffrage are: the age of twenty-one years, citizenship in the United States, residence in the state for one year and in the township for six months preceding the election, a good moral character, and ability "to read in the English language any article of the Constitution or any section of the Statutes of this State."¹ Women may vote for school officials. The right to decide upon a citizen's qualifications for suffrage is vested in the selectmen and clerk of each township. A property qualification, found in the original constitution, was removed in 1845. The Fifteenth Amendment of the Federal Constitution was ratified (1869) by Connecticut, but negroes were excluded from the suffrage by the state constitution until 1876.

The jurisprudence of Connecticut, since the 17th century, has been notable for its divergence from the common law of England. In 1639 inheritance by primogeniture was abolished, and this resulted in conflict with the British courts in the 18th century.² At an early date, also, the office of public prosecutor was created to conduct prosecutions, which until then had been left to the aggrieved party. The right of bastards to inherit the mother's property is recognized, and the age of consent has been placed at sixteen years. Neither husband nor wife acquires by marriage any interest in the property of the other; the earnings of the wife are her sole property and she has the right to make contracts as if unmarried. After residence in the state for three years divorce may be obtained on grounds of fraudulent contract, desertion, neglect for three years, adultery, cruelty, intemperance, imprisonment for life and certain crimes. The Joint Stock Act of 1837 furnished the precedent and the principle for similar legislation in other American states and (it is said) for the English Joint Stock Companies Act of 1856. The relations between capital and labour are the subject of a series of statutes, which prohibit the employment of children under fourteen years of age in any mechanical, mercantile or manufacturing establishment, punish with fine or imprisonment any attempt by an employer to influence his employee's vote or to prevent him from joining a labour union, and in cases of insolvency give preference over general liabilities to debts of \$100 or less for labour. A homestead entered upon record and occupied by the owner is exempt to the extent of \$1000 in value from liability for debts.

The government of Connecticut is also notable for the variety of its administrative boards. Among these are a board of pardons, a state library committee, a board of mediation and arbitration for adjustment of labour disputes, a board of education and a railway commission. The bureau of labour statistics has among its duties the giving of information to immigrant labourers regarding their legal rights: it has free employment agencies at Bridgeport, Norwich, Hartford, New Haven and Waterbury. A state board of charities has supervision over all philanthropic and penal institutions in the state, including hospitals, which numbered 103 in 1907; and the board visits the almshouses supported by seventy-eight (of the 168) towns of the state, and investigates and supervises the provision made for the town poor in the other ninety towns of the state; some, as late as 1906, were, with the few paupers maintained by the state, cared for in a private almshouse at Tariffville, which was commonly known as the "state almshouse." The institutions supported by the state are: a state prison at Wethersfield, the Connecticut industrial school for girls (reformatory) at Middletown and a similar institution for boys at Meriden, the Connecticut hospital for the insane at Middletown, and the Norwich hospital for the insane at Norwich. The state almost entirely supports the Connecticut school for imbeciles, at Lakeville; the American school for the deaf, in Hartford; the oral school for the deaf,

¹ The constitution prescribes that "the privileges of an elector shall be forfeited by a conviction of bribery, forgery, perjury, duelling, fraudulent bankruptcy, theft or other offense for which an infamous punishment is inflicted," but this disability may in any case be removed by a two-thirds vote of each house of the general assembly.

² See an article, "The Connecticut Intestacy Law," by Charles M. Andrews in the *Yale Review*, vol. iii.

at Mystic; the Connecticut institute and industrial home for the blind, at Hartford; Fitch's home for soldiers, at Noroton; ten county jails in the eight counties, and eight county temporary homes for dependent and neglected children.

Education.—Education has always been a matter of public interest in Connecticut. Soon after the foundation of the colonies of Connecticut and New Haven, schools similar to the English Latin schools were established. The Connecticut Code of 1650 required all parents to educate their children, and every township of 50 householders (later 30) to have a teacher supported by the men of family, while the New Haven Code of 1656 also encouraged education. In 1672 the general court granted 600 acres of land to each county for educational purposes; in 1794 the general assembly appropriated the proceeds from the sale of western lands to education, and in 1837 made a similar disposition of funds received from the Federal treasury. The existing organization and methods in school work began in 1838, when the state board of commissioners of common schools (later replaced by a board of education) was organized, with Henry Barnard at its head. In 1900, 5.9% of the population at least 10 years of age was illiterate. All children between 7 and 16 are required to attend school, but those over 14 are excused if they labour; every township of more than 10,000 inhabitants must support an evening school for those over 14; and textbooks are provided by the townships for those unable to purchase them. In 1907-1908 the total school revenue was \$5,027,877 or \$22.35 for each child enrolled, the enrolment being 78.51% of the total number of children enumerated of school age. Of the school revenue about 2.81% was derived from a permanent school fund, 10.96% from state taxation, 80.43% from local taxation and 5.8% from other sources. The average school term was 186.73 days (in 1899-1900 it was 189.01 days), and the average monthly salary of male teachers \$115.07, that of female teachers, \$50.5. Supplementing the educative influence of the schools are the public libraries (161 in number in 1907); the state appropriates \$200 to establish, and \$100 per annum to maintain, a public library (provided the town in which the library is to be established contributes an equal amount), and the Public Library Committee has for its duty the study of library problems. Higher education is provided by Yale University (*q.v.*); by Trinity College, at Hartford (non-sectarian), founded in 1823; by Wesleyan University, at Middletown, the oldest college of the Methodist Church in the United States, founded in 1831, by the Hartford Theological Seminary (1834); by the Connecticut Agricultural College, at Storrs (founded 1881), which has a two years' course of preparation for rural teachers and has an experiment station; by the Connecticut Experiment Station at New Haven, which was established in 1875 at Middletown and was the first in the United States; and by normal schools at New Britain (established 1881), Willimantic (1890), New Haven (1894) and Danbury (1903).

Finance.—In the year ending on the 30th of September 1908 the receipts of the state treasury were \$3,925,492, the expenditure \$4,741,549, and the funded debt, deducting a Civil List Fund of \$325,513 in the treasury, was \$548,586. The debt was increased in April 1909 by the issue of bonds for \$1,000,000 (out of \$7,000,000 authorized in 1907). The principal source of revenue was an indirect tax on corporations, the tax on railways, savings banks and life insurance companies, yielding 70% of the state's income. A tax on inheritances ranked next. There is a military commutation tax of \$2, and all persons neglecting to pay it or to pay the poll tax are liable to imprisonment. A state board of equalization has been established to insure equitable taxation. More than 130 underwriting institutions have been chartered in the state since 1794. The insurance business centres at Hartford. The legal rate of interest is 6%, and days of grace are not allowed.

History.—The first settlement by Europeans in Connecticut was made on the site of the present Hartford in 1633, by a party of Dutch from New Netherland. In the same year a trading post was established on the Connecticut river, near Windsor, by members of the Plymouth Colony, and John Oldham

(1600-1636) of Massachusetts explored the valley and made a good report of its resources. Encouraged by Oldham's account of the country, the inhabitants of three Massachusetts towns, Dorchester, Watertown and New Town (now Cambridge), left that colony for the Connecticut valley. The emigrants from Watertown founded Wethersfield in the winter of 1634-1635; those from New Town (now Cambridge) settled at Windsor in the summer of 1635; and in the autumn of the same year people from Dorchester settled at Hartford. These early colonists had come to Massachusetts in the Puritan migration of 1630; their removal to Connecticut, in which they were led principally by Thomas Hooker (q.v.), Roger Ludlow (c. 1590-1665) and John Haynes (d. 1654), was caused by their discontent with the autocratic character of the government in Massachusetts; but the instrument of government which they framed in 1639, known as the Fundamental Orders of Connecticut, reveals no radical departure from the institutions of Massachusetts. The general court—the supreme civil authority—was composed of deputies from the towns, and a governor and magistrates who were chosen at a session of the court attended by all freemen of the towns. Its powers were not clearly defined, there was also no separation of the executive, legislative and judicial functions, and the authority of the governor was limited to that of a presiding officer.

The government thus established was not the product of a federation of townships, as has often been stated; indeed, the townships had been governed during the first year by commissioners deriving authority from Massachusetts, and the first general court was probably convened by them. In 1638 the celebrated Fundamental Orders were drawn up, and in 1639 they were adopted. Their most original feature was the omission of a religious test for citizenship, though a precedent for this is to be found in the Plymouth Colony; on the other hand, the union of church and state was presumed in the preamble, and in 1659 a property qualification (the possession of an estate of £30) for suffrage was imposed by the general court.

In the meantime another migration to the Connecticut country had begun in 1638, when a party of Puritans who had arrived in Massachusetts the preceding year sailed from Boston for the Connecticut coast and there founded New Haven. The leaders in this movement were John Davenport (1597-1670) and Theophilus Eaton, and their followers were drawn from the English middle class. Soon after their arrival these colonists drew up a "plantation covenant" which made the Scriptures the supreme guide in civil as well as religious affairs; but no copy of this is now extant. In June 1639, however, a more definite statement of political principles was framed, in which it was clearly stated that the rules of Scripture should determine the ordering of the church, the choice of magistrates, the making and repeal of laws, the dividing of inheritances, and all other matters of public import; that only church members could become free burgesses and officials of the colony; that the free burgesses should choose twelve men who should choose seven others, and that these should organize the church and the civil government. In 1643 the jurisdiction of the New Haven colony was extended by the admission of the townships of Milford, Guilford and Stamford to equal rights with New Haven, the recognition of their local governments, and the formation of two courts for the whole jurisdiction, a court of magistrates to try important cases and hear appeals from "plantation" courts, and a general court with legislative powers, the highest court of appeals, which was similar in composition to the general court of the Connecticut Colony. Two other townships were afterwards added to the colony, Southold, on Long Island, and Branford, Conn.

The religious test for citizenship was continued (except in the case of six citizens of Milford), and in 1644 the general court decided that the "judicial laws of God as they were declared by Moses" should constitute a rule for all courts "till they be branched out into particulars hereafter." The theocratic character of the government thus established is clearly revealed in the series of strict enactments and decisions which constituted the

famous "Blue Laws." Of the laws (45 in number) given by Peters, more than one-half really existed in New Haven, and more than four-fifths existed in some form in the New England colonies. Among those of New Haven are the prohibition of trial by jury, the infliction of the death penalty for adultery, and of the same penalty for conspiracy against the jurisdiction, the strict observance of the Sabbath enjoined, and heavy fines for "concealing or entertaining Quaker or other blasphemous hereticks."¹

A third Puritan settlement was established in 1635 at the mouth of the Connecticut river, under the auspices of an English company whose leading members were William Fiennes, Lord Say and Sele (1582-1662) and Robert Greville, Lord Brooke (1608-1643). In their honour the colony was named Saybrook. In 1639 George Fenwick (d. 1657), a member of the company, arrived, and as immigration from England soon afterwards greatly declined on account of the Puritan Revolution, he sold the colony to Connecticut in 1644. This early experiment in colonization at Saybrook and the sale by Fenwick are important on account of their relation to a fictitious land title. The Say and Sele Company secured in 1631 from Robert Rich, earl of Warwick (1587-1658), a quit claim to his interest in the territory lying between the Narragansett river and the Pacific Ocean. The nature of Warwick's right to the land is not stated in any extant document, and no title of his to it was ever shown. But the Connecticut authorities in their effort to establish a legal claim to the country and to thwart the efforts of the Hamilton family to assert its claims to the territory between the Connecticut river and Narragansett Bay—claims derived from a grant of the Plymouth Company to James, marquis of Hamilton (1606-1649) in 1635—elaborated the theory that the Plymouth Company had made a grant to Warwick, and that consequently his quit claim conferred jurisdiction upon the Say and Sele Company; but even in this event, Fenwick had no right to make his sale, for which he never secured confirmation.

The next step in the formation of modern Connecticut was the union of the New Haven colony with the older colony. This was accomplished by the royal charter of 1662, which defined the boundaries of Connecticut as extending from Massachusetts south to the sea, and from Narragansett bay west to the South Sea (Pacific Ocean). This charter had been secured without the knowledge or consent of the New Haven colonists and they naturally protested against the union with Connecticut. But on account of the threatened absorption of a part of the Connecticut territory by the Colony of New York granted to the duke of York in 1664, and the news that a commission had been appointed in England to settle intercolonial disputes, they finally assented to the union in 1665. Hartford then became the capital of the united colonies, but shared that honour with New Haven from 1701 until 1873.

The charter was liberal in its provisions. It created a corporation under the name of the Governor and Company of the English Colony of Connecticut in New England in America, sanctioned the system of government already existing, provided that all acts of the general court should be valid upon being issued under the seal of the colony, and made no reservation of royal or parliamentary control over legislation or the administration of justice. Consequently there developed in Connecticut an independent, self-reliant colonial government, which looked to its chartered privileges as the supreme source of authority.

Although the governmental and religious influences which moulded Connecticut were similar to those which moulded New England at large, the colony developed certain distinctive characteristics. Its policy "was to avoid notoriety and public attitudes; to secure privileges without attracting needless

¹ A collection of these laws was published in his *General History of Connecticut* (London, 1781), by the Rev. Samuel Peters (1735-1826), a Loyalist clergyman of the Church of England, who in 1774 was forced by the patriots or whigs to flee from Connecticut. The most extreme (and most quoted) of these laws were never in force in Connecticut, but the substantial genuineness of others was conclusively shown by Walter F. Prince, in *The Report of the American Historical Association for 1898*.

notice; to act as intensely and vigorously as possible when action seemed necessary and promising; but to say as little as possible, and evade as much as possible when open resistance was evident folly."¹

The relations of Connecticut with neighbouring colonies were notable for numerous and continuous quarrels in the 17th century. Soon after the first settlements were made, a dispute arose with Massachusetts regarding the boundary between the two colonies; after the brief war with the Pequot Indians in 1637 a similar quarrel followed regarding Connecticut's right to the Pequot lands, and in the New England Confederation (established in 1643) friction between Massachusetts and Connecticut continued. Difficulty with Rhode Island was caused by the conflict between that colony's charter and the Connecticut charter regarding the western boundary of Rhode Island; and the encroachment of outlying Connecticut settlements on Dutch territory, and the attempt to extend the boundaries of New York to the Connecticut river, gave rise to other disputes. These questions of boundary were a source of continuous discord, the last of them not being settled until 1881. The attempts of Governors Joseph Dudley (1647-1720), of Massachusetts, and Thomas Dongan (1634-1715) of New York, to unite Connecticut with their colonies also caused difficulty.

The relations of Connecticut and New Haven with the mother country were similar to those of the other New England colonies. The period of most serious friction was that during the administration of the New England colonies by Sir Edmund Andros (*q.v.*), who in pursuance of the later Stuart policy both in England and in her American colonies visited Hartford on the 31st of October 1687 to execute *quo warranto* proceedings against the charter of 1662. It is said that during a discussion at night over the surrender of the charter the candles were extinguished, and the document itself (which had been brought to the meeting) was removed from the table where it had been placed. According to tradition it was hidden in a large oak tree, afterwards known as the "Charter Oak."² But though Andros thus failed to secure the charter, he dissolved the existing government. After the Revolution of 1688, however, government under the charter was resumed, and the crown lawyers decided that the charter had not been invalidated by the *quo warranto* proceedings.

Religious affairs formed one of the most important problems in the life of the colony. The established ecclesiastical system was the Congregational. The Code of 1650 (Connecticut) taxed all persons for its support, provided for the collection of church taxes, if necessary, by civil distraint, and forbade the formation of new churches without the consent of the general court. The New England Half Way Covenant of 1657, which extended church membership so as to include all baptized persons, was sanctioned by the general court in 1664. The custom by which neighbouring churches sought mutual aid and advice, prepared the way for the Presbyterian system of church government, which was established by an ecclesiastical assembly held at Saybrook in 1708, the church constitution there framed being known as the "Saybrook Platform." At that time, however, a liberal policy towards dissent was adopted, the general court granting permission for churches "soberly to differ or dissent" from the establishment. Hence a large number of new churches soon sprang into being. In 1727 the Church of England was permitted to organize in the colony, and in 1729 a similar privilege was granted to the Baptists and Quakers. A religious revival swept the colony in 1741. The very existence of the establishment seemed threatened; consequently in 1742 the general court forbade any ordained minister to enter another parish than his own without an invitation, and decided that only those were legal ministers who were recognized as such by the general court. Throughout the remaining years of the 18th

century there was constant friction between the establishment and the nonconforming churches; but in 1791 the right of free incorporation was granted to all sects.

In the War of American Independence Connecticut took a prominent part. During the controversy over the Stamp Act the general court instructed the colony's agent in London to insist on "the exclusive right of the colonists to tax themselves, and on the privilege of trial by jury," as rights that could not be surrendered. The patriot sentiment was so strong that Loyalists from other colonies were sent to Connecticut, where it was believed they would have no influence; and the copper mines at Simsbury were converted into a military prison; but among the nonconforming sects, on the other hand, there was considerable sympathy for the British cause. Preparations for war were made in 1774; on the 28th of April 1775 the expedition against Ticonderoga and Crown Point was resolved upon by some of the leading members of the Connecticut assembly, and although they had acted in their private capacity funds were obtained from the colonial treasury to raise the force which on the 8th of May was put under the command of Ethan Allen. Connecticut volunteers were among the first to go to Boston after the battle of Lexington and more than one-half of Washington's army at New York in 1776 was composed of Connecticut soldiers. Yet with the exception of isolated British movements against Stonington in 1775, Danbury in 1777, New Haven in 1779 and New London in 1781 no battles were fought in Connecticut territory.

In 1776 the government of Connecticut was reorganized as a state, the charter of 1662 being adopted by the general court as "the Civil Constitution of this State, under the sole authority of the people thereof, independent of any King or Prince whatever." In the formation of the general government the policy of the state was national. It acquiesced in the loss of western lands through a decision (1782) of a court appointed by the Confederation (see WYOMING VALLEY); favoured the levy of taxes on imports by federal authority; relinquished (1786) its claims to all western lands, except the Western Reserve (see OHIO); and in the constitutional convention of 1787 the present system of national representation in Congress was proposed by the Connecticut delegates as a compromise between the plans presented by Virginia and New Jersey.

For many years the Federalist party controlled the affairs of the state. The opposition to the growth of American nationality which characterized the later years of that party found expression in a resolution of the general assembly that a bill for incorporating state troops in the Federal army would be "utterly subversive of the rights and liberties of the people of the state, and the freedom, sovereignty and independence of the same," and in the prominent part taken by Connecticut in the Hartford Convention (see HARTFORD) and in the advocacy of the radical amendments proposed by it. But the development of manufactures, the discontent of nonconforming religious sects with the establishment, and the confusion of the executive, legislative and judicial branches of the government in the existing constitution opened the way for a political revolution. All the discontented elements united with the Democratic party in 1817 and defeated the Federalists in the state election; and in 1818 the existing constitution was adopted. From 1830 until 1855 there was close rivalry between the Democratic and Whig parties for control of the state administration.

In the Civil War Connecticut was one of the most ardent supporters of the Union cause. When President Lincoln issued his first call, for 75,000 volunteers, there was not a single militia company in the state ready for service. Governor William A. Buckingham (1804-1875), one of the ablest and most zealous of the "war-governors," and afterwards, from 1869 until his death, a member of the United States Senate, issued a call for volunteers in April 1861; and soon 54 companies, more than five times the state's quota, were organized. Corporations, individuals and towns made liberal contributions of money. The general assembly made an appropriation of \$2,000,000; and the state furnished approximately 48,000 men to the army.

¹ Johnston, *Connecticut*, p. 130.

² For a good version of the tradition see *Wadsworth or the Charter Oak* (Hartford, 1904), by W. H. Gocher. The tree was blown down in August 1856; in June 1907 a marble shaft was unveiled on its site by the Society of Colonial Wars, of Connecticut.

Equally important was the moral support given to the Federal government by the people.

After the war the Republicans were more frequently successful at the polls than the Democrats. Representation in the lower house of the general assembly, by the constitution of 1818, was based on the townships, each township having two representatives, except townships created after 1818, which had only one each; this method constituted a serious evil when, in the transition from agriculture to manufacturing as the leading industry, the population became concentrated to a considerable degree in a few large cities, and the relative importance of the various townships was greatly changed. The township of Marlborough, with a population in 1900 of 322, then had one representative, while the city of Hartford, with a population of 79,850, had only two; and the township of Union, with 428 inhabitants, and the city of New Haven, with 108,027, each had two representatives. The apportionment of representation in the state senate had become almost as objectionable. By a constitutional amendment of 1828 it had been provided that senators should be chosen by districts, and that in the apportionment regard should be had to population, no county or township to be divided and no part of one county to be joined to the whole or part of another county, and each county to have at least two senators; but by 1900 any relation that the districts might once have had to population had disappeared. The system of representation had sometimes put in power a political party representing a minority of the voters: in 1878, 1884, 1886, 1888 and 1890 the Democratic candidates for state executive offices received a plurality vote; but, as a majority was not obtained, these elections were referred to the general assembly, and the Republican party in control of the lower house secured the election of its candidates; in 1901 constitutional amendments were adopted making a plurality vote sufficient for election, increasing the number of senatorial districts, and stipulating that "in forming them regard shall be had" to population. But the greater inequalities in township representation subsisted, although in 1874 an amendment had given all townships of 5000 inhabitants two seats in the lower house, every other one "to be entitled to its present representation," and in 1876 another amendment had provided that no township incorporated thereafter should be entitled to a representative "unless it has at least 2500 inhabitants, and unless the town from which the major portion of its territory is taken has also at least 2500 inhabitants." These provisions did not remedy the grosser defects, and as proposals for an amendment of the constitution could be submitted to the people only after receiving a majority vote of the lower house, all further attempts at effective reform seemed to be blocked, owing to the unwillingness of the representatives of the smaller townships to surrender their unusual degree of power. Therefore, the question of calling a constitutional convention, for which the present constitution makes no provision, was submitted to the people in 1901, and was carried. But the act providing for the convention had stipulated that the delegates thereto should be chosen on the basis of township representation instead of population. The small townships thus secured practical control of the convention, and no radical changes were made. A compromise amendment submitted by the convention, providing for two representatives for each township of 2000 inhabitants, and one more for each 5000 above 50,000, satisfied neither side, and when submitted to a popular vote, on the 16th of June 1902, was overwhelmingly defeated.

GOVERNORS OF CONNECTICUT¹

The Colony of Connecticut.

John Haynes	1639-1640
Edward Hopkins	1640-1641
John Haynes	1641-1642
George Wyllys	1642-1643
John Haynes	1643-1644
Edward Hopkins	1644-1645
John Haynes	1645-1646
Edward Hopkins	1646-1647
John Haynes	1647-1648

Edward Hopkins	1648-1649
John Haynes	1649-1650
Edward Hopkins	1650-1651
John Haynes	1651-1652
Edward Hopkins	1652-1653
John Haynes	1653-1654
Edward Hopkins	1654-1655
Thomas Welles	1655-1656
John Webster	1656-1657
John Winthrop	1657-1658
Thomas Welles	1658-1659
John Winthrop	1659-1676
William Leete	1676-1683
Robert Treat	1683-1687
Edmund Andros	1687-1689
Robert Treat	1689-1698
Fitz John Winthrop	1698-1708
Gurdon Saltonstall	1708-1725
Joseph Talcott	1725-1742
Jonathan Law	1742-1751
Roger Wolcott	1751-1754
Thomas Fitch	1754-1766
William Pitkin	1766-1769
Jonathan Trumbull	1769-1776

The New Haven Colony.

Theophilus Eaton	1639-1657
Francis Newman	1658-1660
William Leete	1661-1665

STATE GOVERNORS

Jonathan Trumbull	1776-1784	Federalist
Matthew Griswold	1784-1786	"
Samuel Huntington	1786-1796	"
Oliver Wolcott	1796-1797	"
Jonathan Trumbull	1797-1809	"
John Treadwell	1809-1811	"
Roger Griswold	1811-1812	"
John Cotton Smith	1812-1817	"
Oliver Wolcott	1817-1827	Democrat
Gideon Tomlinson	1827-1831	Federalist
John S. Peters	1831-1833	Whig
Henry W. Edwards	1833-1834	Democrat
Samuel A. Foote	1834-1835	Whig
Henry W. Edwards	1835-1838	Democrat
William W. Ellsworth	1838-1842	Whig
Chauncey F. Cleveland	1842-1844	Democrat
Roger S. Baldwin	1844-1846	Whig
Isaac Toucey	1846-1847	Democrat
Clark Bissell	1847-1849	Whig
Joseph Trumbull	1849-1850	"
Thomas H. Seymour	1850-1853	Democrat
Charles H. Pond (Acting)	1853-1854	"
Henry Dutton	1854-1855	Whig
William T. Minor	1855-1857	Know-Nothing
Alexander H. Holley	1857-1858	Republican
William A. Buckingham	1858-1866	"
Joseph R. Hawley	1866-1867	"
James E. English	1867-1869	Democrat
Marshall Jewell	1869-1870	Republican
James E. English	1870-1871	Democrat
Marshall Jewell	1871-1873	Republican
Charles R. Ingersoll	1873-1877	Democrat
Richard D. Hubbard	1877-1879	Democrat
Charles B. Andrews	1879-1881	Republican
Hobart B. Bigelow	1881-1883	Republican
Thomas M. Waller	1883-1885	Democrat
Henry B. Harrison	1885-1887	Republican
Phineas C. Lounsbury	1887-1889	"
Morgan G. Bulkeley	1889-1893	"
Luzon B. Morris	1893-1895	Democrat
O. Vincent Coffin	1895-1897	Republican
Lorin A. Cooke	1897-1899	"
George E. Lounsbury	1899-1901	"
George P. McLean	1901-1903	"
Abiram Chamberlain	1903-1905	"
Henry Roberts	1905-1907	"
Rollin S. Woodruff	1907-1909	"
George L. Lilley	1909	"
Frank W. Weeks	1909-1911	"

BIBLIOGRAPHY.—The "Acorn Club" has recently published a list of books printed in Connecticut between 1700 and 1800 (Hartford, 1904), and Alexander Johnston's *Connecticut* (Boston, 1887) contains a bibliography of Connecticut's history up to 1886. Information concerning the physical features of the state may be obtained in William M. Davis's *Physical Geography of Southern New England* (National Geographical Society Publications, 1895). For information concerning industries, &c., see the *Twelfth Census of the United States*, and the *Census of Manufactures of 1905*, and a chapter in Johnston's *Connecticut*. For law and administration, consult the last two chapters on

¹ Term of service, one year until 1676; thereafter, two years.

"The Constitution and Laws of Connecticut" in *New England States* (vol. i., Boston, 1897); "Town Rule in Connecticut" in *Political Science Quarterly*, vol. iv.; Bernard Steiner's *History of Education in Connecticut* (Washington, 1893), and the reports of the administrative boards and officials, especially those of the Bureau of Labor Statistics, the Board of Education, the Board of Charities and the Treasurer. There is no completely satisfactory history of the state. Johnston's *Connecticut* is well written, but his theories regarding the relationship between the townships and the state are not generally accepted by historical scholars. There is a good chapter in Herbert L. Osgood's *History of the American Colonies in the Seventeenth Century* (New York, 1904). *Connecticut as a Colony and as a State* (Hartford, 1904; 4 vols.) is written from secondary sources, as also is G. H. Hollister's *History of Connecticut (to 1818)* (2 vols. Hartford, 1857). Perhaps the most satisfactory historical work is that of Benjamin Trumbull, *A Complete History of Connecticut from 1630 to 1704* (New Haven, 1804-1818). E. E. Atwater's *History of the Colony of New Haven* (New Haven, 1881) is also valuable, and the monograph of C. H. Levermore, "The Republic of New Haven," and that of C. M. Andrews "The River Towns of Connecticut" in *The Johns Hopkins University Studies* (Baltimore, 1886 and 1889) should be consulted for the institutions of the colonial period. For the sources, see *Colonial Records of Connecticut* (15 vols., Hartford, 1850-1890); *The Records of the Colony and the Plantation of New Haven* (2 vols., Hartford, 1857-1858) and *Records of the State of Connecticut* (2 vols., Hartford, 1894-1895). The *Collections* (Hartford 1860 et seq.) of the Connecticut Historical Society contain valuable material, especially the papers of Governor Joseph Talcott; and the *Papers* (New Haven, 1865 et seq.) of the New Haven Colony Historical Society are extremely valuable for local history; but a vast number of documents relating to the colonial and state periods, now in the state library at Hartford, have never been published.

CONNECTICUT RIVER, a stream of the New England states, U.S.A. It rises in Connecticut Lake in N. New Hampshire—several branches join in N.E. Vermont, near the Canadian line, about 2000 ft. above the sea—flows S., forming the boundary between Vermont and New Hampshire, crosses Massachusetts and Connecticut, and empties into Long Island Sound. Its course is about 345 m. and its drainage basin 11,085 sq. m. The principal tributary is the Farmington, which rises in the Green Mountains in Massachusetts, and joins the Connecticut above Hartford. From its head to the Massachusetts line the banks are wooded, the bed narrow, the valley slopes cut sharply in crystalline rocks, and the tributaries small and torrential. In the 273 m. of this upper portion of its course the average descent is 15 to 34 ft. a mile. In Massachusetts and Connecticut the river flows through a basin of weaker Triassic shales and sandstones, and the valley consequently broadens out, making the finest agricultural region of large extent in New England. Near Holyoke and at other points rugged hills of harder trap rock rise so high above the valley lowland that they are locally called mountains. From their crests there are beautiful views of the fertile Connecticut valley lowland and of the more distant enclosing hills of crystalline rocks. The river winds over this lowland, for the most part flowing over alluvial bottoms. The valley sides rise from the river channels by a series of steps or terraces. These terraces are noted for their perfection of form, being among the most perfect in the country. They have been cut by the river in its work of removing the heavy deposits of gravel, sand and clay that were laid down in this lowland during the closing stages of the Glacial Period, when great volumes of water, heavily laden with sediment, were poured into this valley from streams issuing from the receding ice front. In the course of this excavation of glacial deposits the river has here and there discovered buried spurs of rock over which the water now tumbles in rapids and falls. For example, 11 m. above Hartford are the Enfield Falls, where a descent of 31.8 ft. in low water (17.6 in highest water) is made in 5.25 m. At Middletown, Conn., the river turns abruptly S.E., leaving the belt of Triassic rocks and again entering the area of crystalline rocks which border the lowland. Therefore, from near Middletown to the sea the valley again narrows. The river valley is a great manufacturing region, especially where there is a good water-power derived from the stream, as at Wilder and Bellows Falls, Vt., at Turners Falls and Holyoke, Mass., and at Windsor Locks, Conn. Five miles below Brattleboro, Vt., a huge power dam was under construction in 1909. Efforts have been made by the United States govern-

ment to open the river to Holyoke, and elaborate surveys were made in 1896-1907. At Enfield Rapids is a privately built canal with locks 80 ft. long and 18 ft. wide, handling boats with a draft of 3 ft. From Hartford seaward the Connecticut is a tidal and navigable stream. Bars form at the mouth and have had to be removed annually by dredging. From 1829-1899 the Federal government expended \$585,640 on the improvement of the river. During the colonial period the Connecticut river played an important part in the settlement of New England. The rival English and Dutch fur traders found it a convenient highway, and English homeseekers were soon attracted to its valley by the fertility of the meadow lands. From the middle of the 17th century until the advent of the railway the stream was a great thoroughfare between the seaboard and the region to the north. Its valley was consequently settled with unusual rapidity, and is now a thickly populated region, with many flourishing towns and cities.

See *Annual Reports of the Chief of Engineers, U.S. Army*, *passim* (index, 1900); E. M. Bacon's *Connecticut River and the Valley of the Connecticut* (New York, 1906); G. S. Roberts's *Historic Towns of the Connecticut River Valley* (Schenectady, New York, 1906); and Martha K. Genth, "Valley Towns of Connecticut," in the *Bulletin of the American Geographical Society*, vol. xxxix. No. 9 (New York, 1907).

CONNECTIVE TISSUES, in anatomy. Very widely distributed throughout the tissues and organs of the animal body, there occur tissues characterized by the presence of a high proportion of intercellular substance. This intercellular substance may be homogeneous in structure, or, as is more commonly the case, it may consist, in whole or in part, of a number of fibrous elements. All these tissues are grouped together under the name Connective Tissues. They comprise the following types:—areolar tissue, adipose tissue, reticular or lymphoid tissue, white fibrous tissue, elastic tissue, cartilage and bone. They are all developed from the same layer of embryonic cells and all perform a somewhat similar function, viz. to connect and support the other tissues and organs. According to the nature of their work the ground substance varies in its texture, being fibrous in some, calcareous and rigid in others. As forming the most typical of these tissues, we will first consider the structure of areolar connective tissue.

Areolar Tissue.—This tissue is found in its most typical form uniting the skin to the deeper lying parts. It varies greatly in its density according to the animal and the position of the body from which it is taken. A piece of the looser variety may be spread out as a thin sheet and then examined microscopically. It is then seen to consist chiefly of bundles of extremely fine fibres running in all directions and interlacing with one another to form a meshwork. The spaces, or areolae thus formed give the name to this tissue (see fig. 1). The constituent fibres of each bundle are termed White Fibres. The bundles vary very much in size, but the fibres of which they are composed are of wonderfully constant size. A bundle may branch by sending off its fibres to unite with similar branches from neighbouring bundles, but the individual fibres do not branch nor do they at any time fuse with one another. They form bundles of greater or less size by being arranged parallel to one another, and in these bundles are bound together by some kind of cement substance. The meshwork formed by these fibres is filled up by a ground substance in the composition of which mucin takes some part. In this ground substance lie the cells of the tissue. In addition to the white fibres a second variety of fibres is also present in this tissue. They can be readily distinguished from the white fibres by their larger and variable size, by their more distinct outline, and by the fact that they, for the most part, run as straight lines through the preparation. Moreover they frequently branch, and the branches unite with those of neighbouring fibres. They are known as Yellow Elastic Fibres. Several of these will be found torn across in any preparation especially at the edges, and the torn ends will be found to be curled up in a very characteristic manner. The two types of fibre further differ from one another both chemically and physically. Thus the white fibre swells up and dissolves in boiling water, yielding a solution of

gelatin, whereas the yellow elastic fibre is quite insoluble under these conditions. The white fibres swell when treated with weak acetic acid, and are readily dissolved by peptic digestion but not by pancreatic. The yellow elastic fibres, on the other hand, are unaffected by acetic acid and resist the action of gastric juice for a long time, but are dissolved by pancreatic juice. In

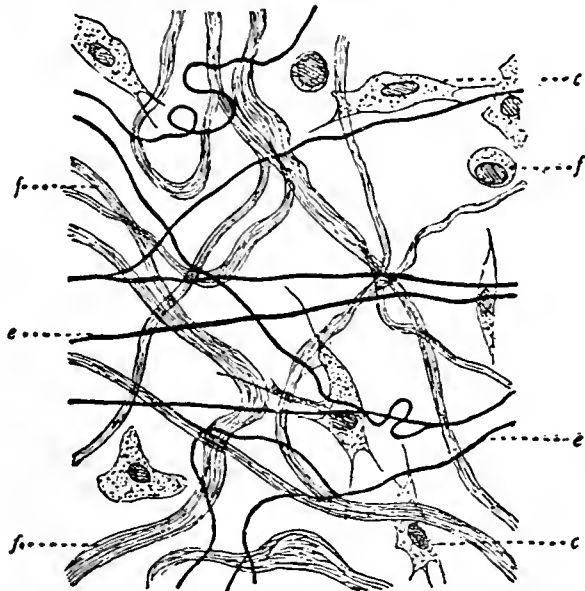

FIG. 1.—Connective tissue, showing cells, fibres and ground-substance. (Szymnowicz.) *c*, Cell; *e*, elastic fibril; *f*, white fibril.

physical properties the white fibres are inextensible and extraordinarily strong, even being able, weight for weight, to carry a greater strain than steel wire. The yellow elastic fibres, on the other hand, are easily extensible and very elastic, but are far less strong than the white fibres. Their elasticity is exhibited by their straight course when viewed in a stretched preparation of areolar tissue, and this contrasts markedly with the wavy course of the bundles of white fibres seen in the same preparation.

The Cells of Areolar Tissue.—Several types of cells are found in the spaces of this tissue and are usually classified as follows. (1) *Lamellar cells*. These are flattened branching cells which usually lie attached to the bundles of white fibres or at the junction of two or more bundles. The branches commonly unite with similar branches of neighbouring cells. (2) *Plasma cells*. These are composed of a highly vacuolated plasma, are not flattened but otherwise vary greatly in shape. (3) *Granular cells*. These are spherical cells densely packed with granules which stain deeply with basic dyes. (4) *Leucocytes*. These are typical blood corpuscles which have left the blood capillaries and gained the tissue spaces. They vary much in amount and in variety.

Adipose or Fatty Tissue.—This consists of rounded vesicles closely packed together to form a dense tissue, found for instance around an organ, along the course of the smaller blood vessels, or in the areolar tissue beneath the skin. This tissue is formed from areolar tissue by an accumulation of fat within certain of the cells of the tissue. These are especially the granular cells, though some regard the fat cells as specific in character, and to be found in large numbers only in certain parts of the body. The fat is either taken in as such by the cell, or, as is more commonly the case, manufactured by the cell from other chemical material (carbohydrate chiefly) and deposited within it in the form of small granules. As these accumulate they run together to form larger granules and this process continuing, the cell at last becomes converted into a thin layer of living material surrounding a single large fat globule. The use of fatty tissue is to serve as a storehouse of food material for future use. In conformity with this it is packed away in parts of the

body where it will not interfere with the working of the different tissues and organs, and in several positions is made use of as packing to fill up irregular spaces, e.g. between the eyeball and the bony socket of the eye.

Reticular Tissue.—This is a variety of connective tissue in which the reticulum of white fibres is built up of very fine strands leaving large interspaces in which the cells typical of the tissue are enclosed. The ground substance of the tissue is reduced to a minimum. Many connective tissue cells lie on the fibres which may in places be completely covered by them. This tissue therefore forms a groundwork holding together the main parts of an organ to form a compact whole. It may thus be demonstrated in lymphatic glands, the spleen, the liver, in mucous membranes and many other cellular organs.

White Fibrous Tissue.—This is the form of tissue in which the white fibres largely preponderate. The fibrous bundles may



FIG. 2.—Tendon of rat's tail, stained with gold chloride and showing cells arranged in rows between the bundles of fibres.

be all arranged parallel to one another to form a dense compact structure as in a tendon. It is found wherever great strength combined with flexibility is required and the fibres are arranged in the direction in which the stress has to be transmitted. In other instances the bundles may be united to form membranes, and in such cases the main number of bundles run in one direction only, which is again that in which the main stress has to be conducted. Such are the ligaments around the joints or the fasciae covering the muscles of the limbs, &c. In other positions, e.g. the dura mater, the fibrous bundles course in all directions, thus forming a very tough membrane. The cells of such tissues lie in the spaces between the bundles and are found

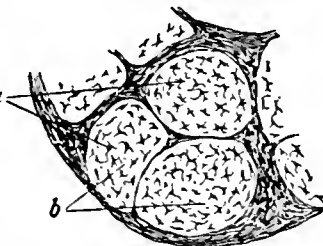

flattened out in two or three directions where they are compressed by the oval fibrous bundles surrounding them (see figs. 2 and 3). The cells thus lie in linear groups running parallel to the bundles, presenting a very characteristic appearance.

Yellow Elastic Tissue.—This is the form of connective tissue mainly composed of elastic fibres. It is found in those positions where a continuous but varying stress has to be supported. In some positions the elastic tissue is in the form of branching

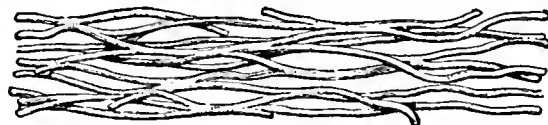

FIG. 4.—Isolated elastic fibres of ligamentum nuchae. Branching fibres of very definite outline with irregularly placed transverse markings.

fibres arranged parallel to one another and bound together by white fibres, e.g. ligamentum nuchae (fig 4). In other cases it may be in the form of thin plates perforated in many directions to form a fenestrated membrane. In this type a series of such plates are arranged round the larger arteries forming a large proportion of the artery wall.

All the connective tissues are vascular structures though as the number of cells present is not great, and further as those cells are not as a rule the seat of a very active metabolism, the number

of blood vessels is quite small. The tissues are also supplied with lymphatics and nerves.

Cartilage.—Cartilage or gristle is a tough and dense tissue possessing a certain degree of flexibility and high elasticity. It is found where a certain amount of flexibility is required but where a fixed shape must be retained, e.g. in the trachea which must always be kept open or in the external ear or pinna which owes its typical and permanent shape to the presence of cartilage. It is largely associated with the bones in the formation of the skeleton. The tissue consists of a number of cells embedded in a solid matrix or ground substance. Three varieties are distinguished according to the nature of the matrix. Thus if the matrix is homogeneous in structure the cartilage is termed *hyaline*. Two other forms occur in which fibrous tissue is embedded in the cartilage matrix. They are therefore termed fibro-cartilages and if the fibres are of the white variety the cartilage is called *white fibro-cartilage*, if of the yellow elastic form, *elastic cartilage*.

Hyaline Cartilage (fig. 5).—This consists of a number of rounded cells enclosed within a homogeneous matrix. The cells possess an oval nucleus and a granular, often vacuolated cell-body. The number of cells present varies considerably in different specimens. In freshly formed cartilage the cells are numerous, the amount of matrix separating them being small. Cartilage grows by a deposition of new matrix by the cartilage cells which thus become more and more separated from one another. After a time the cells divide and subsequently become parted from one another by deposition of fresh matrix between them. The cells are often to be seen in groups of two, three or

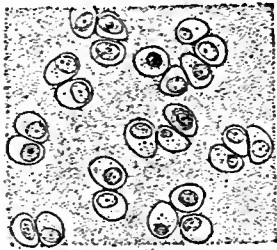

FIG. 5.—Hyaline Cartilage. Homogeneous matrix interspersed with groups of cells whose arrangement shows their development by division of the mother cell.

four cells, indicating the common origin of each group from a parent cell. Towards the surface of the cartilage the cells are often modified in shape tending to become flattened in a direction parallel to the surface. Some of the cells near the surface of a piece of cartilage may be branched, appearing as a transition form between connective tissue corpuscles and typical cartilage cells. This is particularly the case at points where tendon or ligaments are attached. There may often be a deposit of lime salts in the matrix of hyaline cartilage especially in old animals or in the deeper layers of articular cartilage where it is attached to bone. A similar deposit of lime salts is well marked in the superficial parts of the skeleton of the cartilaginous fishes. In the development of animals possessing a bony skeleton, the skeleton is first laid down as hyaline cartilage which subsequently becomes gradually removed, bone being deposited in its place. In the adult, hyaline cartilage is found at the ends of the long bones (articular cartilage), uniting the bony ribs to the sternum (costal cartilage), and forming the cartilages of the nose, trachea and bronchi, &c. This as well as the other forms of cartilage are non-vascular so that the cells must gain their food-stuffs and get rid of their waste products by a process of diffusion through the matrix, a process which must of necessity be slow.

White Fibro-Cartilage.—This is a variety of cartilage in which numerous white fibres ramify in all directions through the matrix (fig. 6). The cells lie separate and not in groups, and the amount of matrix between is commonly small. The white fibres may run in all directions or may chiefly run in one direction only. Under the microscope the tissue closely resembles a dense white fibrous tissue, only the cells enclosed in it are cartilage cells and not connective tissue cells. Owing to the presence of so much fibrous tissue this variety of cartilage is very much tougher than hyaline cartilage and less flexible. It is found in places which have to withstand a considerable amount of compression but where a less rigid structure than bone is demanded. Thus it is

found forming the intervertebral disks, the interarticular cartilages, or at the edges of joint surfaces to deepen the surface.

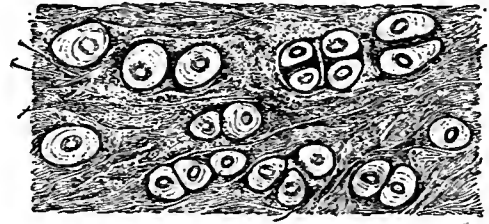

FIG. 6.—White fibro-cartilage of intervertebral disk, with typical cartilage cells, matrix characterized by presence of many white fibres.

Elastic Fibro-Cartilage.—In this variety the matrix is permeated by a complex and well-defined meshwork of elastic fibres (fig. 7). The size of the fibres varies considerably in different parts which have to retain a permanent shape but where a considerable amount of flexibility is requisite, as in the pinna of the ear, the epiglottis, the cartilage of the Eustachian tube, &c.

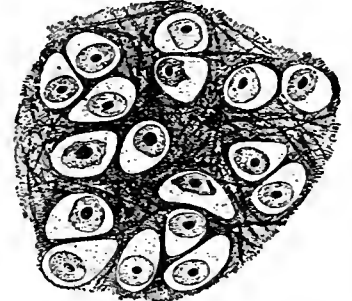

FIG. 7.—Elastic fibro-cartilage of Epiglottis. Abundant cartilage cells in a matrix containing many branching elastic fibres.

Bone.—Bone is a connective tissue in which a considerable amount of mineral matter is deposited in the intercellular matrix whereby it acquires a dense and rigid consistency. If bone be incinerated so that the organic matter is burnt away, a residue of mineral matter is left. This consists chiefly of calcium phosphate, and amounts to as much as two-thirds of the weight of the original bone. If, on the other hand, bone be macerated in hydrochloric or nitric acid for a time the calcium phosphate is dissolved, leaving the organic matter practically unaffected and still showing the microscopic structure of bone. Hence it follows that the organic matrix is uniformly impregnated with the calcium salts.

According to its naked-eye appearance bone is distinguished as being either *compact* or *cancellated*. The former is dense like ivory and forms the outer surface of all bones. The whole of the shaft of a long bone is composed of this compact form. Cancellated bone has a spongy structure and contains large interspaces filled with a fatty tissue rich in blood vessels. This form of bone tissue is found forming the interior of most bones, especially the heads of the long bones, the interior of the ribs, &c. The cavity of the shaft of a long bone is filled, just as in the case of the smaller cavities in cancellated bone, with a fatty tissue, the Bone Marrow (see below).

The histological structure of bone may be made out from a piece of dried bone which has been ground down between grinding stones until it is sufficiently thin for microscopic purposes. If such a section be prepared from a thin transverse slice of a long bone the appearance pictured in fig. 8 will be seen. The section comprises a number of circular units bound into a compact whole by intervening material showing in the main the same structural details. Each of these circular structures is termed an Haversian system. In the centre of each is seen a dark area, the Haversian canal, around which the bone matrix is deposited in the form of a number of concentric laminae. Enclosed between the laminae are a number of small spaces also appearing black in this preparation. These are the bone lacunae and spreading away from them in directions generally transverse to the laminae are seen a large number of fine branching lines—the canaliculi. All parts of a preparation such as this which appear dark in reality represent spaces in the bone matrix. In the course of the preparation of the

specimen all these cavities have been filled up with finely divided débris and hence appear opaque. In the living bone these spaces are filled with a tissue or a cell or with fine protoplasmic processes. Thus the Haversian canal contains an artery and vein, some capillaries, a flattened lymph space, fine medullated nerve fibres—the whole being supported in a fine fatty tissue. Each lacuna is filled with a cell—the bone corpuscle—and the canaliculi contain fine branching processes of these cells. On comparing such a section with one taken parallel to the long axis of the shaft of a bone it is seen that the Haversian canals run some distance along the length of the bone, and that they frequently unite with one another or communicate by obliquely coursing channels. The spaces between the Haversian systems are filled in with further bony tissues which may or may not be arranged in laminae. Finally, the systems are as it were bound together by other laminae running parallel to the surface of the bone. If a piece of fresh bone be decalcified so that a thin section can be cut from it, the bone corpuscles can be seen filling up the lacunae but the section does not give so typical a picture as that already examined because it is not possible to make the protoplasmic structures filling the lacunae and canaliculi stand out in marked contrast with the surrounding matrix.

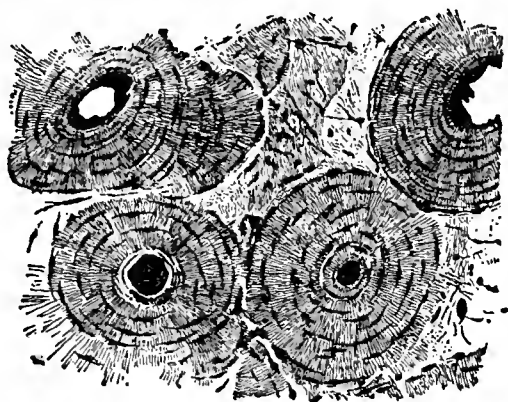

FIG. 8.—Section of Bone. Showing four Haversian systems and interlying bone material. This is a dry preparation, hence all the cavities (such as the Haversian Canals, the lacunae and canaliculi), being filled with débris from the grinding, appear dark.

Cancellous bone only differs from compact bone in the arrangement of the bone tissue. This encloses a number of irregular spaces which communicate with one another to form a kind of spongework. Commonly the framework is so constructed that a number of trabeculae running parallel to one another are produced. This is for the purpose of especially strengthening the bone in that direction. This direction is in all cases found to be that in which the bone has to support its maximum strain while in position within the body. Usually the bone trabeculae are so narrow that there is no need for Haversian systems within them, and they therefore usually consist of a few laminae arranged parallel to the surface. These laminae include bone corpuscles as in the rest of the bone tissue.

Bone Marrow.—Filling the central cavity of the tubular bones and the cavities of the spongy bone tissue is a tissue largely composed of fat cells. This is the bone marrow. Two varieties are distinguished, the one being red in colour, the other yellow. Red marrow is composed of a number of fat cells lying in a tissue made up of large and small marrow cells and typical giant cells or myeloplaxes (fig. 9). The whole of these elements are supported in a delicate connective tissue. The marrow cells exhibit manifold forms. Some are typical leucocytes and lymphocytes as found in circulating blood. Others named myelocytes are slightly larger than leucocytes, with round or oval nuclei, and a protoplasm containing neutrophile granules. Yet another variety contains large eosinophile granules in the protoplasm. These different types of cell probably develop into leucocytes. The giant cells are large spherical cells with several nuclei.

In addition to fully developed red blood corpuscles there are also present numerous nucleated red blood cells (erythro-

blasts or haematoblasts). These are red blood corpuscles in an early stage of formation. They reach the blood after they have lost their nuclei.

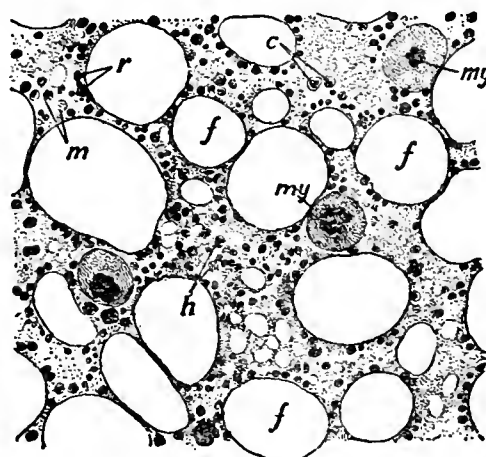

FIG. 9.—Section of Bone Marrow.

- | | |
|------------------|-------------------------------------|
| f, Fat vacuole. | e, Eosinophile cells. |
| my, Myeloplaxes. | r, Red corpuscles. |
| m, Marrow cells. | h, Haematoblasts or erythro-blasts. |

Development of Bone.—The formation of new bone always takes place from connective tissue, but we may distinguish two different modes. In the first the bone is preceded by cartilage (development from cartilage), in the second the bone is laid down directly from a vascular fibrous membrane (development from membrane). The development of bone from cartilage is the more complicated of the two because in it bone formation is taking place in two positions at the same time and in two rather different manners. Thus bone is being laid down from the outside (perichondral formation) from the fibrous membrane surrounding the cartilage, the perichondrium and also within the substance of the cartilage (endochondral formation). Perichondral formation takes place somewhat earlier than endochondral and in the case of a long bone is first observed around the centre of the shaft, *i.e.* in that portion of the bone which forms the diaphysis. Here the perichondrium is vascular and carries on the surface next to the cartilage an almost continuous layer of typical cells cuboid in shape, the *osteoblasts* or bone-formers. Calcium salts are deposited in the matrix of the immediately subjacent cartilage and the cell spaces of the cartilage increase in size while the cartilage cells shrink. Further growth of cartilage ceases in this region so that at one time the shaft of the cartilage may appear constricted in the middle. The formation of bone endochondrally is ushered in by the ingrowth of blood vessels from the perichondrium. A way through the calcified matrix of the cartilage is made for them by a process of erosion. This is effected by a number of polynucleated giant cells, the *osteoclasts*, which apply themselves to the matrix and gradually dissolve it away. The enlarged cartilage spaces are thus opened to one another, and soon the only remnants of the matrix consist of a number of irregular trabeculae of calcified matrix. In this way the primary marrow spaces are produced, the whole structure representing the future spongy portion of the bone. The next step in both perichondral and endochondral bone formation consists in the deposition of bone matrix. This is effected by the osteoblasts. In the spongy portion they deposit a layer upon the surfaces of the calcified cartilage matrix, and thus in newly formed bone we find a central framework of cartilage matrix enclosed in a layer of bone matrix (see fig. 10). In the perichondral formation the deposition is effected in the same manner but is not uniformly spread over the whole surface, but trabeculae are formed. These become confluent at places, thus leaving spaces through which blood vessels and osteogenetic tissue pass to reach the interior of the bone. As the deposition of bone matrix proceeds, some of the osteoblasts become included within the matrix. These cease to form fresh matrix and in

fact become bone corpuscles. Increase in thickness of the new bone is effected by the deposition of fresh matrix followed again by the inclusion of further osteoblasts. The spaces within the trabeculae become in this way gradually narrowed by the deposition of matrix until at last only a narrow centre is left large enough to contain the blood vessels and their accompanying nerves, lymphatics and a small number of osteoblasts. Bone formation then ceases. In this manner the Haversian systems are produced.

Growth of the bone proceeds by the deposition of more matrix on the exterior, but simultaneously a process of absorption is also taking place. This is most typically seen within the spongy portion of the bone. The absorption of the trabeculae is effected by the osteoclasts. These become applied to the trabeculae and gradually eat their way into the matrix thus coming to lie within lacunae. They possess the power of dissolving both bone and cartilage matrix. Side by side with this solution process we may often see new formation taking place by the activity of the osteoblasts (fig. 10). In this manner the whole framework of the bone may be gradually replaced. The process is most active in embryos and very young animals, but also continues during the whole life of an animal, thus effecting alterations in shape and structure of the whole bone. Growth in the length of a bone is effected by formation of new bone at either end of the shaft. After the ossification centre has been formed in the shaft (diaphysis) of the bone subsidiary centres make their appearance in the heads of the bones. These

form, by a similar process of bone formation, fresh bone masses which, however, are not continuous with the bone tissue of the shaft. They form the epiphyses. They are attached to the diaphysis by an intermediate piece of cartilage, and it is by a process of growth of this cartilage and its subsequent replacement by bone that growth in length of the whole bone is effected (fig. 10). This piece of intervening cartilage can be easily seen in a young bone and persists as long as the bone can increase in length. Thus in man the last junction of epiphysis to diaphysis may not take place until the 28th year.

Development of bone in membrane shows a course in all respects very similar to perichondral bone formation. A layer of osteogenic tissue makes its appearance in the membrane from which the bone is to be formed. In this tissue a number of stiff fibres are deposited which soon become covered and impregnated with calcium salts. Around these bundles of fibres numbers of osteoblasts are deposited and by them bone matrix is deposited in irregular trabeculae. The bone increases by the deposition of fresh matrix just as in perichondral bone formation and Haversian systems are formed after precisely the same manner as in that position. The factor determining the position of one of these systems is of course the presence of a blood vessel penetrating towards the deeper part of the bone.

Muscle.—Muscle is the contractile tissue of the body, that tissue by which the various parts of the body are moved. Thus

it forms the main bulk of the limbs, back, neck and body wall. Most of the viscera too possess well-developed muscular coats. When separated into its constituent parts it is seen that muscle in all instances is built up of a number of long fibres. These are of three well-defined types. Those forming the skeletal muscles are of large size, even in some instances up to 12 cms. in length, their diameter varying from 0.01 to 0.1 mm. When these are examined under the microscope they are found to be characterized by possessing a decided transverse marking, and they are therefore known as *striated muscle* fibres. From the fact that they comprise those muscles which are under the control of the will they are also called *voluntary muscle* fibres. The second variety of muscle is made up of much smaller fibres varying in different parts from 0.05 to 0.15 mm. in length and about 0.005 mm. in diameter. These fibres show no transverse striations nor are they directly under the control of the will. They are therefore termed *smooth* or *involuntary muscle*. Lastly, there is a third type of muscle found in the heart which lies intermediate in structure between these two varieties. In this the fibres are small and show distinct transverse striations. Longitudinal striations are also present though somewhat less marked. In most respects this form of muscle fibre resembles smooth muscle more closely than striated muscle.

Voluntary or Striated Muscle.—Each muscle fibre of which this is composed is what is known as a syncytium or plasmodium, i.e. a structure containing a number of nuclei, which has been formed from a single cell by proliferation of its nucleus without subdivision of the protoplasm. It is thus an assemblage of cells possessing a common protoplasm. Each fibre generally runs parallel to the length of the muscle and if that muscle is short extends the whole length. Thus the one end of the fibre may be attached to tendon when the end is rounded off. The other end may also terminate in tendon or in the fibrous covering of bone in which case it is again rounded. In long muscles, however, the fibre may only extend a certain distance along the muscle, and it is then found to terminate in a tapering or bevelled end. In some of the long muscles some of the fibres may both arise and terminate in the substance of the muscles. In such a case both ends are bevelled. All the fibres in a muscle are arranged parallel to one another.

The outer surface of each muscle fibre consists of a tough homogeneous membrane, the *sarcolemma*. The main muscle substance (see fig. 11) is composed of several parts, viz. the *fibrillae*, the sarcoplasm and the nuclei. Under the action of reagents the muscle fibre may be split into a number of longitudinal elements. These are the fibrillae. They possess alternate bands of light and dark substance which give them a striated appearance. When viewed under polarized light the dark substance is found to be doubly refracting or anisotropic, the light band is singly refracting or isotropic. According to many observers, in the centre of each isotropic segment there is a thin transverse disk of anisotropic material and in the centre of each anisotropic segment a thin disk of isotropic substance.

The fibrillae are arranged in the muscle fibre parallel to one another and with the alternate light and dark bands at approximately the same level across the fibre, thus giving to the whole muscle fibre its typical transverse striation. The fibrillae are united to one another by interfibrillar substance to form bundles, of which there may be a considerable number in each muscle fibre. The bundles lie in a surrounding layer of sarcoplasm which apparently represents the remaining portion of unaltered protoplasm of the syncytium. This structure of muscle is best seen in the transverse sections of the fibres. A number of areas separated by a clear protoplasm are then to be seen. The areas are formed by the bundles of fibrillae seen in transverse section,

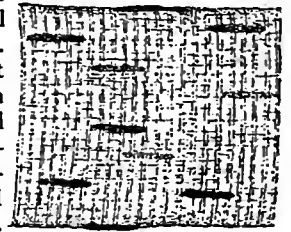

FIG. 11.—Striated or Voluntary muscle fibre, with alternate light and dark bands and many nuclei immediately beneath the sarcolemma.

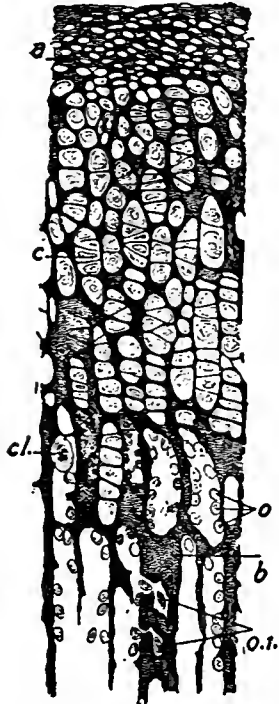

FIG. 10.—A part of bone developing from cartilage showing enlarged cartilage spaces.

- o*, Osteoblasts lining a cavity and depositing bone matrix on the wall of that cavity.
- o.l*, Osteoblasts which have become included in the deposited bone to form bone corpuscles.
- b*, Freshly laid down bone matrix.
- d*, Giant cells or osteoclasts.
- c*, Cartilage cells arranged in rows.
- a*, Unaltered matrix of hyaline cartilage.

the intermediate substance is the sarcoplasm. In some muscles, apparently, each fibrilla is surrounded by a considerable amount of sarcoplasm, in which case the fibrillae are easily isolated from one another and can be readily examined. This is the case in the wing muscles of insects. The nuclei of the fibre are arranged close

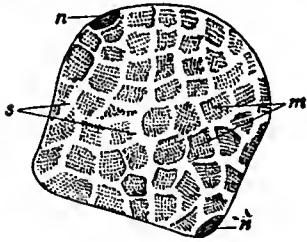

FIG. 12.—Transverse section of a striated muscle fibre.
n, Nucleus.
s, Sarcoplasm.
m, Bundle of fibrillae forming a muscle column.



FIG. 13.—Isolated smooth muscle fibres. Very much contracted. Fibres tapering at each end, with nucleus in centre of cell.

under the sarcolemma. Each is surrounded by a small quantity of sarcoplasm and in shape is an elongated ellipse. In most cases the muscle fibres do not branch, though in a few instances, such as the superficial muscles of the tongue, branching is found.

Involuntary or Smooth Muscle (figs. 13 and 14).—This form of muscle tissue when separated into its single constituents is seen to consist of fibres possessing a typical long spindle shape. The central part is somewhat swollen and contains an elongated nucleus centrally placed. The ends of the fibres are drawn out and pointed sharply. There is no definite surrounding membrane to each cell. In most of the cells, especially the larger, a distinct longitudinal marking can be seen. This is due to the presence of the fibrils which run the length of the fibre and in all probability are the essential contractile elements.

In most instances the cells are arranged with one another in a tissue to form bundles or sheets of contractile substance. In each bundle or sheet the cells are cemented to one another so that they may all act in unison. The cementing material is apparently of a membranous character and is so arranged that contiguous fibres are only separated by a single layer of membrane. According to some, neighbouring fibres are connected to one another by minute offshoots, and these communications

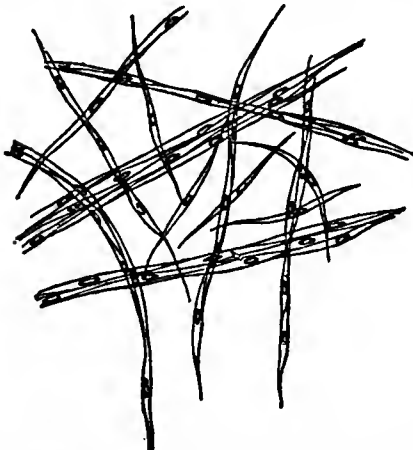

FIG. 14.—Preparation of Frog's Bladder showing smooth muscle *in situ* forming a network.

serve to explain the manner in which the contraction is observed to pass from fibre to fibre along a sheet composed of the muscles. Involuntary muscle is the variety of muscle tissue found in the walls of the hollow viscera, such as stomach, intestines, ureter, bladder, uterus, &c., and of the respiratory passages, in the middle coats of arteries, in the skin and the muscular trabeculae of the spleen. The arrangement is very typical, for instance, in the small intestine. Here the muscular coat consists of two layers of muscle. Each is in the form of a sheet which varies greatly in thickness in different animals. In the inner sheet the fibres, which are all parallel to one another, are disposed with their long axis transverse to the direction of the gut. In the outer layer, the direction of the fibres is at right angles to this. In a viscus with thick muscle walls the fibres are bound into bundles and the bundles may run in all directions. In some

instances the bundles may form branching systems, thus constituting a network, as in the bladder (fig. 14). In other instances, e.g. the villi of the small intestine, the muscle fibres are separate, forming a felt-work with wide meshes.

Heart Muscle.—The fibres of which the muscular walls of the heart are composed though cross striated are not voluntary, for they are not under the control of the will. Each fibre is an oblong cell possessing distinct transverse and less distinct longitudinal striations (fig. 15). There is no sarcolemma, and the nucleus of each fibre is placed in the centre. The longitudinal striation is due to the presence of fibrillae, each of which is cross striated. These lie parallel to one another in the cell, the sarcoplasm surrounding them being much more abundant in these fibres than is striated muscle. The fibrillae are arranged in rows, and when a transverse section of one of these fibres is examined it is seen that the rows radiate away from the centre of the cell. A further distinctive character of cardiac muscle fibres is that they frequently branch, the branches uniting with others from neighbouring cells. Moreover, the ends of the fibres are attached to corresponding faces of other cells, and through these attached faces the fibrillae pass, so that there is an approximation to the formation of a syncytium. (T. G. Br.)

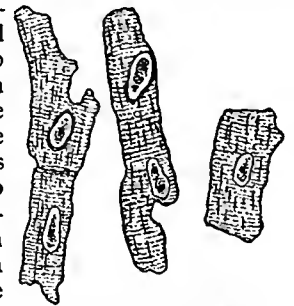

FIG. 15.—Cardiac Muscle. Isolated cells.

CONNELLITE, a rare mineral species, a hydrous copper chloro-sulphate, $Cu_{15}(Cl,OH)_4SO_{16} \cdot 15H_2O$, crystallizing in the hexagonal system. It occurs as tufts of very delicate acicular crystals of a fine blue colour, and is associated with other copper minerals of secondary origin, such as cuprite and malachite. Its occurrence in Cornwall was noted by Philip Rashleigh in 1802, and it was first examined chemically by Arthur Connell in 1847. Outside Cornwall it has been found only in Namaqualand in South Africa.

CONNELLSVILLE, a borough of Fayette county, Pennsylvania, U.S.A., on the Youghiogheny river, about 60 m. S.S.E. of Pittsburgh. Pop. (1890) 5629; (1900) 7160, including 800 foreign-born; (1910) 12,845. It is served by the Pennsylvania, the Pittsburg and Lake Erie, and the Baltimore & Ohio railways, and by the interurban electric system of the West Penn Railway Co., which has a large power plant near Connellsville. Connellsville is the centre of the Connellsville coke district (in Fayette and Westmoreland counties), which has the largest production in the United States, the output in 1907 (13,089,427 tons) being 32.1% of that of the whole country. Connellsville coke is the standard grade. What is called the Lower Connellsville coke region lies in Fayette county S.W. of the Connellsville district. It is richest near Uniontown, and in 1907 produced 6,310,900 tons of coke, making it second only to Connellsville. The so-called Upper Connellsville (or Latrobe) district, near Latrobe, produced in 1907, 1,030,260 tons of coke. The combined output of these three districts in 1907 was 50.1% of the total of the entire country. The borough of Connellsville has various manufactures including iron, tin plate, automobiles and various kinds of machinery; and a state hospital for the treatment of persons injured in mines is located here. Connellsville was first settled in 1770, was laid out as a town by Zachariah Connell, in whose honour it was named, in 1793, and was incorporated in 1806. The borough of New Haven (pop. in 1900, 1532) was annexed to Connellsville after the census enumeration of 1900.

CONNEMARA, a wild and picturesque district in the west of Co. Galway, Ireland. (See GALWAY.)

CONNERSVILLE, a city and the county-seat of Fayette county, Indiana, U.S.A., situated on White Water river, in the east central part of the state, about 50 m. E. by S. of Indianapolis. Pop. (1900) 6836; (1910) 7738. It is served by the Cincinnati, Hamilton & Dayton, the Cleveland, Cincinnati, Chicago & St

Louis, the Fort Wayne, Cincinnati & Louisville railways, and by the Indianapolis & Cincinnati Traction line (electric). It has a good water-power, and among its manufactures are wagons and carriages, axles, furniture, flour and electric signs. The water-works are owned and operated by the city. Connersville was first settled about the close of the war of 1812; was laid out in 1817 by John Conner, in whose honour it was named; and received a city charter in 1869.

CONNOR (or O'CONNOR), **BERNARD** (1666-1698), English physician, was born in Kerry, Ireland, and after studying at Montpellier and Paris, graduated at Reims in 1691. Having travelled through Italy with the two sons of the high chancellor of Poland, he was introduced at the court of Warsaw, and appointed physician to John Sobieski, king of Poland. In 1695 he went to England, where he lectured at Oxford, London and Cambridge, and became a member of the Royal Society and of the College of Physicians. He was the author of a treatise entitled *Evangelium Medici* (1697), in which he endeavoured to explain the Christian miracles as due to natural causes, and of a *History of Poland* (1698). He died in London in 1698.

CONNOTATION, in logic, a term (largely due to J. S. Mill) equivalent to Intension, which is used to describe the sum of the qualities regarded as belonging to any given thing and involved in the name by which it is known; thus the term "elephant" connotes the having a trunk, a certain shape of body, texture of skin, and so on. It is clear that as scientific knowledge advances the Connotation or Intension of terms increases, and, therefore, that the Connotation of the same term may vary considerably according to the knowledge of the person who uses it. Again, if a limiting adjective is added to a noun (e.g. African elephant), the Connotation obviously increases. In all argument it is essential that the speakers should be in agreement as to the Intension of the words they use. General terms such as "Socialism," "Slavery," "Liberty," and technical terms in philosophy and theology are frequently the cause of controversies which would not arise if the disputants were agreed as to the Intension or Connotation of the terms. In addition *Connotative* terms, as those which imply attributes, are opposed to *Non-Connotative*, which merely denote things without implying attributes. See also DENOTATION; and any text-books on elementary logic, e.g. T. Fowler or W. S. Jevons.

CONOID (Gr. κώνος, cone, and εἶδος, form), in geometry, the solids (or surfaces) formed by the revolution of a conic section about one of its principal axes. If the conic be a circle the conoid is a sphere (*q.v.*); if an ellipse a spheroid (*q.v.*); if a parabola a paraboloid; if a hyperbola the surface is a hyperboloid of either one or two sheets according as the revolution takes place about the conjugate or transverse axis, and the surface generated by the asymptotes is called the "asymptotic cone." If two intersecting straight lines be regarded as a conic, then the principal axes are the bisectors of the angles between the lines; consequently the corresponding conoid is a right circular cone. It is to be noted that all these surfaces are surfaces of revolution; and they, therefore, differ from the surfaces discussed under the same names in the article **GEOMETRY: Analytical**.

The spheroid has for its cartesian equation $(x^2+y^2)/a^2+z^2/b^2=1$; the hyperboloid of one sheet (of revolution) is $(x^2+y^2)/a^2-z^2/b^2=1$; the hyperboloid of two sheets is $z^2/c^2-(x^2+y^2)/a^2=1$; and the paraboloid of revolution is $x^2+y^2=4az$.

CONOLLY, JOHN (1794-1866), English physician, was born at Market Rasen, Lincolnshire, of an Irish family, on the 27th of May 1794. He graduated M.D. at Edinburgh in 1821. After practising at Lewes, Chichester and Stratford-on-Avon successively, he was appointed professor of the practice of medicine at University College, London, in 1828. In 1830 he published a work on the *Indications of Insanity*, and soon afterwards settled at Warwick. In 1832 in co-operation with Sir Charles Hastings and Sir John Forbes, he founded a small medical association with a view to raising the standard of provincial practice. In later years this grew in importance and membership, and finally became the British Medical Association. In 1839 he was elected

resident physician to the Middlesex County Asylum at Hanwell. In this capacity he made his name famous by carrying out in its entirety and on a large scale the principle of non-restraint in the treatment of the insane. This principle had been acted on in two small asylums—William Tuke's Retreat near York, and the Lincoln Asylum; but it was due to the energy of Conolly in sweeping away all mechanical restraint in the great metropolitan lunatic hospital, in the face of strong opposition, that the principle became diffused over the whole kingdom, and accepted as fundamental. In 1844 he ceased to be resident physician at Hanwell, but remained visiting physician until 1852. He died on the 5th of March 1866 at Hanwell, where in the later part of his life he had a private asylum. His works include *Construction and Government of Lunatic Asylums* (1847); *The Treatment of the Insane without Mechanical Restraints* (1856); and an *Essay on Hamlet* (1863).

CONON, son of Timotheus, Athenian general. After having held several commands during the Peloponnesian War, he was chosen as one of the ten generals who superseded Alcibiades in 406 B.C. He was defeated by the Spartan Callicratidas and shut up in Mytilene. The Athenian victory at Arginusae rescued him from his dangerous situation, and as he had not been present at the battle, he was not tried with the other generals, and was allowed to retain his command. In 405, however, the Athenian fleet was surprised by Lysander, at Aegospotami, and Conon with difficulty managed to escape with eight ships to his friend Evagoras, king of Cyprus. On the outbreak of the war between Sparta and the Persians (400) he obtained from King Artaxerxes joint command with Pharnabazus of a Persian fleet. In 394 he defeated the Lacedaemonians near Cnidus, and thus deprived them of the empire of the sea, which they had held since the taking of Athens. Sailing down the Aegean to Athens, he expelled the Lacedaemonian harmosts from most of the maritime towns, and finally completed his services to his country by restoring the long walls and the fortifications of the Peiraeus. According to one account, he was put to death by Tiribazus, when on an embassy from Athens to the Persian court to counteract the intrigues of Sparta; but it seems more probable that he escaped to Cyprus and died there about 390.

See Xenophon, *Hellenica*, iv. 3. 8; Justin vi. 3; Cornelius Nepos, *Conon*; Lysias, *De bonis Aristophanis*, 41-44; Isocrates, *Panegyricus*, 41; M. Schmidt, *Das Leben Konons* (1873), with notes and references to authorities.

CONON, Greek astronomer and geometrician, flourished at Samos in the 3rd century B.C. He was the friend of Archimedes, who survived him. Conon is best known in connexion with the *Coma Berenices* (Hair of Berenice). Berenice, the wife of Ptolemy Euergetes, had dedicated her hair in the temple of Arsinoë of Zephyrium (Aphrodite Zephyritis) as an offering to secure the safe return of her husband from his Syrian expedition. It disappeared from the temple, and was declared by Conon to have been placed among the stars. The incident formed the subject of a poem by Callimachus, of which only a few lines are preserved, but we still possess the imitation of it by Catullus. Conon is also considered the inventor of the curve known as the "Spiral of Archimedes." He wrote a work on astronomy, which contained a collection of the observations of solar eclipses made by the Chaldaeans, and drew up a parapegma, or meteorological calendar, from his own observations. He also investigated the question of the number of points of intersection of two conics, and his researches probably formed the basis of the 4th book of the *Conics* of Apollonius of Perga.

CONON, grammarian and mythographer, flourished at Rome in the time of Caesar and Augustus. He was the author of a collection of myths and legends, relating chiefly to the foundation of colonics. The work, dedicated to Archelaus Philopator, king of Cappadocia, contained 50 *Narratives* (*Διηγήματα, Narrationes*); an epitome, accompanied by brief criticisms, has been preserved in Photius (*cod.* 186). The style is good, being founded on the best Attic models, and the whole is agreeable to read. Nicolaus of Damascus is said to have made considerable use of the work (edition by U. Höfer, 1890).

CONQUEST, in international law, the subjugation of an enemy in war. International law recognizes a "right of conquest";¹ that is to say, neutral powers accept the *de facto* result of a war of conquest, or of a war which has led to conquest, without reference to any questions of justice or morality the war may involve. Neutral states, however, have often intervened to prevent the exercise of the right, on the ground that some interest of theirs was implicated. Two comparatively recent cases of this were the intervention of neutral European powers after the signing of the Russo-Turkish treaty of San Stefano in 1878, and that which took place after the Chino-Japanese War (1899). The theory of the balance of power, which long swayed the diplomacy of Europe, was also a restriction placed upon the right of conquest (see **BALANCE OF POWER**). Where, however, no neutral interest is involved, as in the case of the South African War (1899-1902), or where any neutral interest involved is not backed by sufficient physical or moral support among the powers to ensure success to any joint action among them, the conquering state deals with the conquered state in such way as it has the power to enforce, subject only to the possible moral reproval of public opinion in case of any ruthless abuse of the latter's impotency.

Conquest may or may not be followed by annexation (*q.v.*) in part, as in the case of the Franco-German War when Germany exercised her overwhelming strength to force France into transferring to her a portion of her territory, or as in the case of the South African War, in which Great Britain annexed to her dominions the whole territory of the subjugated republics.

Among European states any attempt to disturb the balance of the political distribution of Europe might still be held to involve the common interests of the other powers. The suppression of an independent European state and its incorporation into another state, as a termination to a war, in fact has only occurred in recent times in Italy and Germany, and these were cases in which that balance has rather been promoted than disturbed.

It is sometimes difficult to say when a conquest is complete, and the consequences of annexation may be rightfully enforced. A time necessarily comes, in the course of a war of conquest, when the conqueror may rightfully declare that the laws of peace shall be applicable from a certain moment, and that further resistance will not entitle the combatants to the treatment prescribed for regular combatants by the laws of war. To carry on warfare after the entire territory is in the hands of the enemy, after all means of government by the dispossessed authority are at an end, after all hope of recovery of its territorial sovereignty is absolutely gone, is obviously mere wanton bloodshed. A war is practically at an end when the position of the one belligerent renders the contest manifestly hopeless for the other belligerent.²

¹ "The rights of conquest," says Halleck (*Int. Law*, 3rd ed., ch. 33), explaining the nature of the right, "are derived from force alone. They begin with possession and end in the loss of possession. The possession is acquired by force, either from its actual exercise or from the intimidation it produces. There can be no antecedent claim or title from which any right of possession is derived, for if so it would not be a conquest. The assertion and enforcement of a right to possess a particular territory do not constitute a conquest of that territory. By the term conquest we understand the forcible acquisition of territory admitted to belong to the enemy. It expresses, not a right, but a fact, from which rights are derived. Until the fact of conquest occurs, there can be no rights of conquest. A title acquired by a conquest cannot, therefore, relate back to a period anterior to the conquest. That would involve a contradiction of terms. The title of the original owner prior to the conquest is, by the very nature of the case, admitted to be valid. His rights are therefore suspended by force alone. If that force be overcome, and the original owner resumes his possession, his rights revive and are deemed to have been uninterrupted. It, therefore, cannot be said that the original owner loses any of his rights of sovereignty, or that the conqueror acquires any rights whatever in the conquered territory anterior to actual conquest."

² "There is subjugation," says Rivier (*Droit des gens*, vol. ii, p. 436), "when a war is terminated by the complete defeat of one of the belligerents, so that all his territory is taken, the authority of his government suppressed, and he ceases in consequence to exist as a state."

"The extinction of a state by conquest," says Westlake (*Int.*

From that moment it is the duty of the conqueror to organize the regular government of the conquered territory on a footing of peace. As soon as this regular government has been established, to take human life, destroy property or otherwise disturb public order entails the penalties of the criminal law. A government which is strong enough to maintain its authority, which is in possession of and is *de facto* administering a country, is the government of that country, and, however just or interesting may be the cause of those who have been dispossessed, they are not entitled to treatment as belligerents. Thus in the South African War of 1899-1902 the British authorities, when the whole territory was occupied, manifestly beyond hope of recovery, might have ceased to treat the roving bands of armed men, who were still carrying on war, as belligerents. This, however, would probably have entailed reprisals; and when the Dutch government offered its good offices in January 1902, with a view to bringing the war to an end, the offer, though not accepted in the form of mediation, nevertheless led to negotiations which resulted in "terms of surrender" between delegates of the burghers "acting as the government" of the two republics (31st of May 1902), which gave finality to the conquest and made individual resistance thereafter unquestionably an act of rebellion. The position of the remains of a regular force roving over a conquered country, in fact, is one which it is difficult to deal with under principles of law, men who have been fighting for the retention of their national independence differing essentially from insurgents (T. BA.)

CONRAD, or **KONRAD** (M. H. Ger. *Kuonrât*, *i.e.* "keen in counsel," Lat. *Conradus*, It. *Corrado*, cf. the A.S. *Cænred*), a German masculine proper name, borne by four German kings and emperors. The last of the Hohenstaufen, Conrad the younger, duke of Swabia, is known in history by the diminutive form *Conradin* (*q.v.*).

CONRAD I. (d. 918), German king, son of Conrad, count of Lahngau, was a member of an influential Franconian family, and was probably related to the German king Arnulf. He took part in the feud between his family and that of the Babenbergs, and after his father's death in 906 passed much of his time at the court of Louis the Child, and assumed the title of "duke in Franconia." When Louis died in 911, Conrad was chosen German king at Forchheim on the 8th of November 911 owing to the efforts of Hatto I., archbishop of Mainz, and to the reputation he appears to have won in war and peace alike. Coming to the throne he found the unity of Germany threatened by the Magyars and the Normans from without, and by the growing power of the stem-duchies from within. He failed, however, to bring Lorraine into subjection, and was equally unsuccessful in his struggle with Henry, duke of Saxony, afterwards King Henry the Fowler. His subsequent years were mainly spent in warfare in Swabia and Bavaria, but owing to ill-health and the feebleness of his forces he was only partially successful in his attempts to restore peace. He died on the 23rd of September 918, and was buried at Fulda. About 914 Conrad married Kunigunde, a sister of Erchanger, count palatine in Swabia, and widow of Liutpold, margrave of Carinthia. He had no sons, and named his former enemy, Henry of Saxony, as his successor.

See E. Dümmler, *Geschichte des ostfränkischen Reichs* (Leipzig, 1887-1888); F. Stein, *Geschichte des Königs Konrad I. von Franken und seines Hauses* (Nördlingen, 1872). F. Löher, *König Konrad I. und Herzog Heinrich von Sachsen* (Munich, 1857); *Die Urkunde des deutschen Königs Konrad I.*, edited by Th. von Sickingen in the *Monumenta Germaniae historica. Diplomata* (Hanover, 1879).

CONRAD II. (c. 990-1039), Roman emperor, founder of the Franconian or Salian dynasty, was a son of Henry, count of Spire, grandson of Otto I., duke of Carinthia, and through his great-grandmother Liutgarde, wife of Conrad the Red, duke of Lorraine, a descendant of the emperor Otto the Great. He was *Law*, 1904, pt. i. p. 64), "will take place when the conquering power has declared its will to annex it, and has established its authority throughout the territory, any opposition still made being on the scale of brigandage rather than of war, and no corner remains in which the ordinary functions of government are carried on in the name of the old state."

a member of the family of the Conradines, counts in Franconia, but the family estates had passed to another branch, and were held at this time by another Conrad, called the "younger" to distinguish him from his elder relative. He appears to have been a man of strong character, and owing to his skill in warfare, and especially to his marriage in 1016 with Gisela, widow of Ernest I., duke of Swabia, won position and influence in Germany. When the emperor Henry II. died in 1024, the two Conrads were the most prominent candidates for the throne, and are said to have mutually agreed to abide by the decision of the electors. After some delay the elder Conrad was elected German king early in September 1024. He owed his election to the support of the German bishops, especially that of Aribo, archbishop of Mainz, who crowned him in his cathedral on the 8th of September 1024; and the king's biographer, Wipo, remarks that Charlemagne himself could not have been welcomed more gladly by the people. Aribo, however, refused to perform this ceremony for Gisela, as she was within the prohibited degrees of affinity, and she was crowned some days later at Aix-la-Chapelle by Pilgrim, archbishop of Cologne. Conrad then travelled through his dominions, received tribute from tribes dwelling east of Saxony, and by his journey "bound the kingdom most firmly in the bond of peace, and the kingly protection." His position, however, was full of difficulty, and the various elements of discontent tended to unite. Boleslaus, duke of the Poles, took the title of king, and assumed a threatening attitude; Rudolph III., king of Burgundy or Arles, who had arranged that the emperor Henry II. should succeed him, refused to make a similar arrangement with Conrad; many of the Italians were hoping to obtain a king from France; and some German princes, including Conrad the younger, and the king's step-son Ernest II., duke of Swabia, showed signs of revolt.

The death of Boleslaus in 1025, and a cession of some lands north of the Eider to Canute, king of Denmark and England, secured the northern and eastern frontiers of Germany from attack, and the king's domestic enemies were soon crushed. In 1026 Conrad set out for Italy, and supported by Heribert, archbishop of Milan, assumed the Lombard crown in that city, and afterwards overcame the resistance which was offered by Pavia and Ravenna. Travelling to Rome, he was crowned emperor in the presence of the kings of Burgundy and Denmark by Pope John XIX., on the 26th of March 1027. The emperor then visited southern Italy, where by mingling justice with severity he secured respect for the imperial authority; and returned to Germany to find Ernest of Swabia, the younger Conrad, and their associates again in arms. One cause of this rising was the claim put forward by Ernest to the Burgundian succession, as King Rudolph was his great-uncle. But his efforts were unsuccessful, and in 1028 the revolt was suppressed; while in the meantime the emperor had met Rudolph of Burgundy at Basel, and had secured for himself a promise of the succession. The emperor's presence was soon needed in the east, where Mesislaus, duke of the Poles, and Stephen I., king of Hungary, were ravaging the borders of Germany. An expedition against Stephen in 1029 was only partially successful, but he submitted in 1031, and in 1032 Mesislaus was compelled to cede Lusatia to Conrad. In 1030 Ernest of Swabia was killed in battle; and in September 1032 the king of Burgundy died, and his kingdom was at once seized by his nephew Odo, count of Champagne. Collecting an army, Conrad marched into Burgundy in 1033, was chosen and crowned king of Peterlingen, and after driving his rival from the land was again crowned at Geneva in 1034. Having asserted his authority over the Bohemians and other Slavonic tribes, Conrad went a second time to Italy in 1036 in response to an appeal from Heribert of Milan, whose oppressions had led to a general rising of the smaller vassals against their lords. An assembly was held at Pavia, and when Heribert refused to obey the commands of the emperor he was seized and imprisoned; but he escaped to Milan, where the citizens took up arms in his favour. Unable to take Milan, Conrad issued in May 1037 an *edictum de beneficiis*, by which he decreed that the principle of heredity should apply in Italy to lands held by sub-

vassals, and that this class of tenants should not be deprived of their lands except by the sentence of their peers, and should retain the right of appeal to the emperor. Having crushed a rising at Parma and left the city in flames, Conrad restored Pope Benedict IX. to Rome, and marched into southern Italy, where he invested the Norman Rainulf with the county of Aversa, and gave the principality of Capua to Waimar IV., prince of Salerno. Returning to Germany, the emperor handed over the kingdom of Burgundy to his son Henry, afterwards the emperor Henry III., and proceeded to Utrecht, where he died on the 4th of June 1039. He was buried in the cathedral which he had begun to build at Spire.

Conrad did much for the strengthening of the German kingdom. Its boundaries were extended by the acquisition of Burgundy and the reconquest of Lusatia; disturbances of the peace became fewer and were more easily suppressed than heretofore; and three of the duchies, Bavaria, Franconia and Swabia, were made apanages of the royal house. Although he did not decree that German fiefs should be hereditary, he favoured the tendency in this direction, and so attempted to make the smaller vassals a check on the power of the nobles. He endeavoured to unite Italy and Germany by inter-marriages between the families of the two countries, governed Italy to a large extent by German officials, and ordered that the law of Justinian should supersede Lombard law in the Roman territories. He ruled the church with a firm hand; appointed his own supporters, regardless of their individual fitness, to bishoprics and abbeys; and sought by inquiry to restore to the royal domain the estates granted to the church by his predecessors.

See Wipo, *Gesta Chuonradi II. imperatoris*, Herimann of Reichenau, *Chronicon*, *Annales Sangallenses majores*, *Annales Hildisheimenses*, all in the *Monumenta Germaniae historica. Scriptores* (Hanover and Berlin, 1826-1892). An edition of Wipo, together with parts of the *Chronicon* and the *Annales Sangallenses*, edited by H. Bresslau, was published at Hanover in 1878.

H. Bresslau, *Jahrbücher des deutschen Reichs unter Konrad II.* (Leipzig, 1879-1884); H. Bresslau, *Die Kanzlei Kaiser Konrads II.* (Berlin, 1869); W. Arndt, *Die Wahl Konrad II.* (Göttingen, 1861); J. von Pflugk-Harttung, *Untersuchungen zur Geschichte Kaiser Konrads II.* (Stuttgart, 1890); G. A. H. Stenzel, *Geschichte Deutschlands unter den fränkischen Kaisern* (Leipzig, 1827-1828); M. Pfenninger, *Die kirchliche Politik Kaiser Konrads II.* (Halle, 1880); M. Pfenninger, *Kaiser Konrad II. Beziehungen zu Aribo von Mainz Pilgrim von Köln, und Aribert von Mailand* (Breslau, 1891); O. Blümcke, *Burgund unter Rudolf III. und der Heimfall der burgundischen Krone an Kaiser Konrad II.* (Greifswald, 1869); W. von Giesebrecht, *Geschichte der deutschen Kaiserzeit* (Leipzig, 1881-1890); H. Pabst, "Frankreich und Konrad II. in den Jahren 1024 und 1025," in the *Forschungen zur deutschen Geschichte*, Band v. (Göttingen, 1862-1886).

CONRAD III. (1093-1152), German king; second son of Frederick I., duke of Swabia, and Agnes, daughter of the emperor Henry IV., was the first king of the Hohenstaufen family. His father died in 1105, and his mother married secondly Leopold III., margrave of Austria; but little is known of his early life until 1115 when his uncle the emperor Henry V. appointed him duke of Franconia. In 1116, together with his elder brother Frederick II., duke of Swabia, he was left by Henry as regent of Germany; and when the emperor died in 1125 he became titular king of Burgundy, or Arles. Returning from the Holy Land in 1126, he took part in the war which during his absence had broken out between his brother Frederick and the new king, Lothair the Saxon; and was chosen king in opposition to Lothair on the 18th of December 1127. His election in preference to Frederick was possibly due to the fact that owing to his absence from Germany he had not taken the oath of fealty to the new king. Hastening across the Alps he was crowned king of Italy at Monza in June 1128, and in spite of the papal ban was generally acknowledged in northern Italy. His position, however, rapidly weakened. The rival popes, Innocent II. and Anacletus II., both declared against him; the Romans repudiated him; and after failing to seize the extensive possessions left by Matilda, marchioness of Tuscany, he returned to Germany in 1132. He continued the struggle against Lothair till October 1135, when he submitted, was pardoned, and recovered his estates; owing this generous treatment, it is said, to the good offices of

St Bernard, abbot of Clairvaux. In 1136 he accompanied the imperial forces to Italy in the capacity of standard-bearer, distinguished himself by his soldierly skill, and in view of the increasing age and infirmity of Lothair, sought to win the favour of Pope Innocent II.

In December 1137 Lothair died, and some of the princes met at Coblenz, and chose Conrad for a second time as German king on the 7th of March 1138, in presence of the papal legate. Crowned at Aix-la-Chapelle six days later, he was acknowledged at Bamberg by several of the South German princes; but his position could not be strong while Henry the Proud, the powerful duke of Bavaria and Saxony, refused his allegiance. Attempts at a peaceful settlement of this rivalry failed, and Henry was placed under the ban in July 1138, when war broke out in Bavaria and Saxony. The king was unable to make much headway, in spite of the death of Duke Henry, which occurred in October 1139; and his half-brother Leopold IV., margrave of Austria, to whom Bavaria had been entrusted, was defeated by Henry's brother Welf, afterwards duke of Spoleto and margrave of Tuscany. Conrad, however, captured the fortress of Weinsberg from Welf in December 1140, and is said to have allowed the women to leave the town, each with as much of her property as she could carry on her back. To his surprise, so the story runs, each woman came out bearing on her back a husband, a father or a brother, who thus escaped the vengeance of the conquerors. This tale is now regarded as legendary, and the same remark also applies to the tradition that the cries *Hi Welfen, hi Wibelingen*, were first raised at this siege. Peace was made at Frankfort in May 1142, when Henry the Lion, son of Henry the Proud, was confirmed in the duchy of Saxony, while Bavaria was given to Conrad's step-brother Henry Jasomirgott, margrave of Austria, who married Gertrude, the widow of Henry the Proud.

Affairs in Italy demanded the attention of the king, as Roger I., king of Sicily, had won considerable authority on the mainland, and refused to recognize the German king, whose help Pope Lucius II. implored against the rebellious Romans. This state of affairs drove Conrad into alliance with the East Roman emperor, Manuel Comnenus, who in 1146 married his step-sister; but the condition of Germany prevented the contemplated campaign against Roger. The solitary success amid the general disorder in the Empire was the expedition undertaken in 1142 by Conrad into Bohemia, where he restored his brother-in-law Ladislaus to this throne. An attempt, however, to perform the same service for another brother-in-law, also called Ladislaus, who had been driven from his Polish dukedom, ended in failure. Meanwhile Germany was ravaged and devastated by civil war, which Conrad was unable to repress. Disorder was rampant in Saxony, Bavaria and Burgundy; and in 1146 war broke out between the Bavarians and the Hungarians. A term was placed to this condition of affairs by the preaching of Bernard of Clairvaux, and the consequent departure of many turbulent nobles on crusade. In December 1146 the king himself took the cross, secured the election and coronation of his young son Henry as his successor, appointed Henry I., archbishop of Mainz, as his guardian, and set out for Palestine in the autumn of 1147. Marching with a large and splendid army through Hungary, he reached Asia Minor, where his forces were decimated by disease and by the sword. Stricken by illness, Conrad returned to Constantinople at Christmas 1147, but in March 1148 set out to rejoin his troops. Having shared in the fruitless attack on Damascus, he left Palestine in September 1148, and passed the ensuing winter at Constantinople, where he made fresh plans for an attack on Roger of Sicily. He reached Italy by sea; but the news that Roger had allied himself with Louis VII., king of France, and his old opponent Welf of Bavaria, compelled him to return hastily to Germany, which was again in disorder. He was obliged to neglect repeated invitations from the Romans, who sent him a specially urgent letter in 1149, and consequently never received the imperial crown.

Conrad died on the 15th of February 1152 at Bamberg, where he was buried. By his wife, Gertrude, daughter of Berenger,

count of Sulzbach, he had two sons, the elder of whom, Henry, died in 1150. Passing over his younger son Frederick on account of his youth, he appointed as his successor his nephew Frederick III., duke of Swabia, afterwards the emperor Frederick I. Conrad possessed military talents, and had many estimable qualities, but he lacked perseverance and foresight, and was hampered by his obligations to the church.

The chief authority for Conrad's life and reign is Otto of Freising, "Chronicon," in the *Monumenta Germaniae historica*. *Scriptores*, Band xx. (Hanover and Berlin, 1826-1892). The best modern authorities are L. von Ranke, *Weltgeschichte*, achter Teil (Leipzig, 1887-1888); W. von Giesebrecht, *Geschichte der deutschen Kaiserzeit*, Band iv. (Brunswick, 1877); J. Jastrow, *Deutsche Geschichte im Zeitalter der Hohenstaufen* (Berlin, 1893); Ph. Jaffé, *Geschichte des deutschen Reiches unter Lothar dem Sachsen* (Berlin, 1843); W. Bernhardt, *Konrad III.* (Leipzig, 1883); O. von Heinemann, *Lothar der Sachse und Konrad III.* (Halle, 1869).

CONRAD IV. (1128-1154), German king, son of the emperor Frederick II. and Isabella of Brienne, was born at Andria in Apulia on the 26th of April 1128. In 1135 he was made duke of Swabia and in 1137 was chosen king of the Romans, or German king, at Vienna, in place of his half-brother Henry, an election which was subsequently confirmed by the diet at Spire. After spending some time in Italy he returned to Germany and began to take part in the quarrel which had arisen between the emperor and the pope. In 1140 he called an assembly to Eger, where many of the princes declared openly against the pope, and was soon in arms against Siegfried, archbishop of Mainz, the leader of the papal party in Germany. Although defeated near Frankfort in August 1146 by the anti-king, Henry Raspe, landgrave of Thuringia, he obtained help from the towns and from his father-in-law Otto II., duke of Bavaria, and drove Henry Raspe to Thuringia. He was carrying on the struggle against Henry Raspe's successor, William II., count of Holland, when the emperor died in December 1150, and a few days later Conrad narrowly escaped assassination at Regensburg. Assuming the title of king of Jerusalem and Sicily, he raised an army by pledging his Swabian estates and marched to Italy in 1151, where with the help of his illegitimate half-brother, Manfred, he overran Apulia and took Capua and Naples. He was preparing to return to Germany at the head of a large army when he died at Lavello on the 21st of May 1154. In September 1146 he married Elizabeth (d. 1173), daughter of Otto of Bavaria, by whom he left a son, Conradin, whom he had never seen.

See F. W. Schirrmacher, *Die letzten Hohenstaufen* (Göttingen, 1871); C. Rodenberg, *Innocenz IV. und das Königthum Sicilien, 1245-1254* (Halle, 1892); J. Kempl, *Geschichte des deutschen Reiches während des grossen Interregnums* (Würzburg, 1893); and E. Winkelmann, *Kaiser Friedrich I.* (Leipzig, 1889).

CONRAD (d. 955), surnamed the "Red," duke of Lorraine, was a son of a Franconian count named Werner, who had possessions on both banks of the Rhine. He rendered valuable assistance to the German king Otto, afterwards the emperor Otto the Great, and in 944 was made duke of Lorraine. In 947 he married Otto's daughter Liutgarde (d. 953), and afterwards took a prominent part in the struggle between Louis IV., king of France, and Hugh the Great, duke of Paris. He accompanied his father-in-law to Italy in 951, and when Otto returned to Germany in 952, Conrad remained behind as his representative, and signed a treaty with Berengar II., king of Italy, which brought about an estrangement between the German king and himself. He entered into alliance with his brother-in-law Ludolf, and taking up arms against Otto, seized the person of the king, afterwards resisting successfully an attack on Mainz. He then ravaged the lands of his enemies in Lorraine; treated with the Magyars for support, but submitted to Otto in June 954, when he was deprived of his duchy, though permitted to retain his hereditary possessions. He was killed on the Lechfeld on the 10th of August 955, while fighting loyally for Otto against the Magyars, and was buried at Worms. He left a son Otto, who was the grandfather of the emperor Conrad II. Conrad is greatly lauded for his valour by contemporary writers, and the historian Widukind speaks very highly of his qualities both of mind and of body.

See Widukind, "Res gestae Saxonicae," in the *Monumenta Germaniae historica. Scriptores*, Band iii. (Hanover and Berlin, 1826-1892); W. von Giesebrecht, *Geschichte der deutschen Kaiserzeit* (Leipzig, 1881); R. Köpke and E. Dümmler, *Jahrbücher des deutschen Reichs unter Kaiser Otto I.* (Leipzig, 1876); K. Köstler, *Die Ungarnschlacht auf dem Lechfelde* (Augsburg, 1884).

CONRAD OF MARBURG (c. 1180-1233), German inquisitor, was born probably at Marburg, and received a good education, possibly at the university of Bologna. It is not certain that he belonged to any of the religious orders, although he has been claimed both by the Franciscans and the Dominicans. Early in the 13th century he appears to have won some celebrity as a preacher, and in 1214 was commissioned by Pope Innocent III. to arouse interest in the proposed crusade. After continuing this work for two or three years Conrad vanishes from history until 1226, when he is found occupying a position of influence at the court of Louis IV., landgrave of Thuringia. He became confessor to the landgrave's wife St Elizabeth of Hungary (*q.v.*), and exercised the landgrave's rights of clerical patronage during his absence on crusade. In 1227 he was employed by Pope Gregory IX. to extirpate heresy in Germany, to denounce the marriage of the clergy, and to visit the monasteries. He carried on the crusade against heretics with great zeal in Hesse and Thuringia, but especially in the district around the mouth of the Weser inhabited by a people called the Stedinger. In 1233 he accused Henry II., count of Sayn, of heresy, a charge which was indignantly repudiated. An assembly at Mainz of bishops and princes declared Henry innocent, but Conrad demanded that this sentence should be reversed. This was his last work, for as he rode from Mainz he was murdered near Marburg on the 30th of July 1233. He left an *Epistola ad papam de miraculis Sanctae Elisabethae*, which was first published at Cologne in 1653. Conrad is chiefly known to English readers through Charles Kingsley's *Saint's Tragedy*, in which he is a prominent character.

See E. L. T. Henke, *Konrad von Marburg* (Marburg, 1861), B. Kaltner, *Konrad von Marburg und die Inquisition in Deutschland* (Prague, 1882); A. Hausrath, *Der Ketzermeister Konrad von Marburg* (Leipzig, 1883); J. Beck, *Konrad von Marburg* (Breslau, 1871).

CONRAD OF WÜRZBURG (d. 1287), the chief German poet of the second half of the 13th century. As little is known of his life as that of any other epic poet of the age. By birth probably a native of Würzburg, he seems to have spent part of his life in Strassburg and his later years in Basel, where he died on the 31st of August 1287. Like his master, Gottfried of Strassburg, Conrad did not belong to the nobility, from which most of the poets of the time sprang. His varied and voluminous literary work is comparatively free from the degeneration which set in so rapidly in Middle High German poetry during the 13th century. His style, although occasionally diffuse, is dignified in tone; his metre is clearly influenced by Gottfried's tendency to relieve the monotony of the epic-metre with ingenious variations, but it is always correct; his narratives—if we except *Die halbe Birn*, of which the authorship is doubtful—are free from coarseness, to which the popular poets at this time were prone, and, although mysticism and allegory bulk largely in his works, they were not allowed, as in so many of his contemporaries, to usurp the place of poetry. Conrad has written a number of legends (*Alexius, Silvester, Pantaleon*) illustrating Christian virtues and dogmas; *Der Welt Lohn*, a didactic allegory on the familiar theme of "Frau Welt," the woman beautiful in front, unsightly and loathsome behind. *Die goldene Schmiede* is a panegyric of the Virgin; in *Klage der Kunst*, an allegorical defence of poetry. His most ambitious works are two enormously long epics, *Der trojanische Krieg* (of more than 40,000 verses and unfinished at that) and *Partenopier und Meliur*, both of which are based on French originals. Conrad's powers are to be seen to best advantage in his shorter verse romances, such as *Engelhart und Engeltrut, Kaiser Otto* and *Das Herzezaere*; the last mentioned, the theme of which has been made familiar to modern readers by Uhland in his *Kastellan von Coucy*, is one of the best poems of its kind in Middle High German literature.

There is no uniform edition of Conrad's works. *Der trojanische Krieg* was edited by A. von Keller for the Stuttgart *Literarische Verein* (1858); *Partenopier und Meliur*, by K. Bartsch (1871);

Die goldene Schmiede and Silvester, by W. Grimm (1840 and 1841); *Alexius*, by H. F. Massmann (1843) and R. Henczynski (1898); *Der Welt Lohn*, by F. Roth (1843); *Engelhart und Engeltrut*, by M. Haupt (1844, 2nd ed., 1890); *Klage der Kunst*, by E. Joseph (1885). The shorter poems, *Otto* and *Herzezaere*, will be found most conveniently in *Erzählungen und Schwänke des Mittelalters*, edited by H. Lambel (2nd ed., 1883). Modern German translations of Conrad's most popular poems have been published by K. Pannier and H. Krüger in Reclam's *Universalbibliothek* (1879-1891). On Conrad see F. Pfeiffer in *Germania*, iii. (1867), and W. Golther in the *Allgemeine deutsche Biographie*, vol. 44 (1898), s.v. "Würzburg, Konrad von."

CONRAD, JOSEPH (1856-), English novelist, was born in Poland, his full name having been Joseph Conrad Korzeniowski. He learnt French in infancy, but did not learn English until he was nearly twenty. At Constantinople, where he had gone with the intention of joining the Russians against the Turks, he joined the French merchant navy. Later on he found his way to Lowestoft in England, and, after obtaining his mate's certificate, he sailed for the East in an English ship. The story of this voyage is told in *Youth, and other Tales* (1902). His chief other volumes are *Almayr's Folly* (1895), *An Outcast of the Islands* (1896), *The Nigger of the Narcissus* (1897), *Tales of Unrest* (1898), *Lord Jim* (1900), *Typhoon* (1903), *The Mirror of the Sea* (1906), and, with F. M. Hueffer, *Romance* (1903). All these are remarkable for their vigorous English style, and the vivid description of exotic scenes; the author being especially successful in tracing the effects of tropical surroundings and the contact with Asiatics on European sailors and traders. His play *One Day More* was produced by the Stage Society in June 1905.

CONRADIN, or **CONRAD THE YOUNGER** (1252-1268), king of Jerusalem and Sicily, son of the German king Conrad IV., and Elizabeth, daughter of Otto II. duke of Bavaria, was born at Wolfstein in Bavaria on the 25th of March 1252. Having lost his father in 1254 he grew up at the court of his uncle and guardian, Louis II. duke of Bavaria; but little is known of his appearance and character except that he was "beautiful as Absalom, and spoke good Latin." Although he had been entrusted by his father to the guardianship of the church, he was pursued with relentless hatred by pope Innocent IV., who sought to bestow the kingdom of Sicily on a foreign prince. Innocent's successor, Alexander IV., continued this policy, offered the Hohenstaufen lands in Germany to Alphonso X. king of Castile, and forbade Conradin's election as king of the Romans. Having assumed the title of king of Jerusalem and Sicily, Conradin took possession of the duchy of Swabia in 1262, and remained for some time in his dukedom. Conradin's first invitation to Italy came from the Guelphs of Florence, by whom he was asked to take arms against Manfred, who had been crowned king of Sicily in 1258. This invitation was refused by Louis on his nephew's behalf, but after Manfred's fall in 1266 envoys from the Ghibelline cities came to Bavaria and urged him to come and free Italy. Pledging his lands, he crossed the Alps and issued a manifesto at Verona setting forth his claim on Sicily. Notwithstanding the defection of his uncle Louis and other companions who returned to Germany, the threatenings of Pope Clement IV., and lack of funds, his cause seemed to prosper. Proclaimed king of Sicily, his partisans both in the north and south of Italy took up arms; his envoy was received with enthusiasm in Rome; and the young king himself was welcomed at Pavia and Pisa. In November 1267 he was excommunicated; but his fleet was victorious over that of Charles duke of Anjou, who had taken possession of Sicily on Manfred's death; and in July 1268 he was himself greeted with immense enthusiasm at Rome. Having strengthened his forces, he marched towards Lucera to join the Saracens. On the 23rd of August 1268 he encountered the troops of Charles at Tagliacozzo, but the eagerness of his soldiers to obtain plunder gave the victory to the French. Escaping from the field of battle Conradin reached Rome, but acting on advice to leave the city he reached Astura, where he was seized and handed over to Charles of Anjou. At Naples he was tried as a traitor, and on the 29th of October was beheaded with his friend and companion Frederick

of Baden, titular duke of Austria. With his death the Hohenstaufen race became extinct. His remains, with those of Frederick of Baden, still rest in the church of the monastery of Santa Maria del Carmine at Naples, founded by his mother for the good of his soul; and here in 1847 a marble statue, by Thorwaldsen, was erected to his memory by Maximilian, crown prince of Bavaria. In the great 14th century "Manesse" MS. (c) collection of medieval German lyrics, preserved at Heidelberg, there are two songs written by Conradin, and his fate has formed the subject of several dramas.

See F. W. Schirrmacher, *Die letzten Hohenstaufen* (Göttingen, 1871); K. Hampe, *Geschichte Konradins von Hohenstaufen* (Berlin, 1893); del Giudice, *Il Giudizio e la condanna di Corradino* (Naples, 1876); E. Miller, *Konradin von Hohenstaufen* (Berlin, 1897).

CONRART (or **CONRAD**), **VALENTIN** (1603-1675), one of the founders of the French Academy, was born in Paris of Calvinist parents. He was educated for a commercial life, but after his father's death in 1620 he began to come into contact with men of letters, and soon acquired a literary reputation, though he wrote nothing for many years. He was made councillor and secretary to the king; and in 1629 his house became the resort of men of letters, who met to talk over literary subjects, and to read and mutually criticize their works. Cardinal Richelieu offered the society his protection, and in this way (1635) the French Academy was created. Its first meetings were held in the house of Conrart, who was unanimously elected secretary, and discharged the duties of his post for forty-three years, till his death on the 23rd of September 1675. The most important of Conrart's works is his *Mémoires sur l'histoire de son temps* published by L. J. N. de Monmerqué in 1825.

See also R. Kerviler and Édouard de Barthélemy, *Conrart, sa vie et sa correspondance* (1881); C. B. Petitot, *Mémoires relatifs à l'histoire de France*, tome xlviii.; and Sainte-Beuve, *Causeries du lundi* (19 juillet 1858).

CONSALVI, ERCOLE (1757-1824), Italian cardinal and statesman, was born at Rome on the 8th of June 1757. His grandfather, Gregorio Brunacci, of an ancient family of Pisa, had changed his name in order to become heir to a certain marchese di Consalvi. Ercole, who was the eldest of five children early left orphans, began his education at the Piarist college at Urbino. Removed thence on account of the cruel treatment he and his brother received, he went to the college opened at that time by Cardinal Henry of York at Frascati. Here Consalvi soon became one of the cardinal's favourite protégés. In 1776 he entered the Academia Ecclesiastica at Rome, in which Pope Pius VI. took a strong personal interest. This led to his being appointed in 1783 *camariere segreto* to the pope, an office which involved the duty of receiving those who desired an audience. Next year he was made a domestic prelate and shortly afterwards a member of the Congregation *del buon governo*. His further promotion was rapid; at the instance of Pope Pius, who thought his talents would be best employed at the bar, he became *rotante di segnatura*, and, on the first vacancy, auditor of the Rota for Rome. This last post left him plenty of leisure, which he used for travelling and cultivating the society of interesting people, a taste which earned him the title of *Monsignore Ubique*. When the outbreak of the French Revolution made a reorganization of the papal army necessary, this was carried out by Consalvi as assessor to the new military Congregation.

In 1798, when the French occupied Rome, Consalvi was imprisoned in the castle of St Angelo, together with other papal officials, in retaliation for the murder of General Duphot; a proposal to whip him through the streets was defeated by the French general in command, but, after three months' confinement, he was deported with a crowd of galley slaves to Naples, and his property was confiscated as that of "an enemy of the Roman republic." He managed with difficulty to reach Pius VI., who had sought refuge in the Certosa of the Val d' Ema, and was present at his death-bed.

As secretary to the conclave which assembled in the monastery of San Giorgio Maggiore at Venice, Consalvi had the difficult task of corresponding with the various governments and organizing the assembly at a time when the Revolution had confused all

issues and reduced the individual cardinals to beggary. In this his diplomatic ability was conspicuously evident, and it was also largely owing to his influence that Cardinal Chiaramonte was elected as Pius VII. (March 14, 1800). On the 3rd of June the new pope re-entered Rome; on the 11th of August Consalvi was appointed cardinal-deacon and secretary of state, or prime minister. The appointment was an admirable one; for Consalvi possessed just the qualities necessary to supplement those of Pius. The pope was above all a religious man, of a gentle and contemplative character; the cardinal was pre-eminently a man of affairs. Their personal sympathy for each other continued to the end, though at the outset at least their political views differed. Pius, who had openly expressed sympathy with the new liberties of France, was accused of "Jacobinism"; Consalvi, brought up in the legitimist atmosphere of the entourage of Cardinal York, was a convinced supporter of the divine right of kings generally and of Louis XVIII. in particular. But, though opposed to the principles of the Revolution, Consalvi was far from being a blind obscurantist, and he recognized the urgent need for reform in the system of papal government. In this, despite bitter opposition, he made many significant changes. He permitted laymen to hold certain public offices, under surveillance of the prelates, organized a guard from among the Roman nobility, decreed a plan for redeeming the base coinage, permitted the communes a certain degree of municipal liberty, and promised the liquidation of the public debt. In the long debates between Rome and France about the Concordat Consalvi took the leading part. In June 1801 he arrived in Paris, where his handsome presence, urbane manners, and conspicuous ability made him a general favourite. Even Napoleon, though enraged at the firmness with which he maintained the papal claims, could not resist his personal fascination. It was largely owing to Consalvi's combined firmness and tact that the Concordat, as ultimately signed, was free from the objectionable clauses on which the First Consul had at first insisted. During the pope's absence in Paris, at the coronation of Napoleon, Consalvi remained as virtual sovereign in Rome; and his regency was rendered remarkable by a great inundation, caused by the overflow of the Tiber, during which he exposed himself with heroic humanity for the preservation of the sufferers. Not long after the return of the pope the amity between the Vatican and the Tuileries was again broken. Rome was full of anti-revolutionary and anti-Napoleonic strangers from all parts of Europe. The emperor was irritated; and his ambassador, Cardinal Fesch, kept up the irritation by perpetual complaints directed more especially against Consalvi himself. "Tell Consalvi," wrote the conqueror, still flushed with Austerlitz, "that if he loves his country he must either resign or do what I demand." Consalvi did accordingly resign on the 17th of June 1807, and when in 1808 General Miollis entered Rome, and the temporal power of the pope was formally abolished, he broke off all relations with the French, though several of them were his intimate friends. In 1809 he was at Paris, and, in a remarkable interview, received from Napoleon's own lips an apology for the treatment he had received. With unbending dignity, however, he retained his antagonism; and shortly afterwards he was one of the thirteen cardinals who refused to attend the ceremony of the emperor's marriage with Marie Louise. For this display of independence he was imprisoned at Reims, and not released till some three years later, when Napoleon had extorted terms from the captive pope at Fontainebleau. On his release Consalvi hastened to his master's assistance; and he was soon after allowed to resume his functions under the restored pontificate at Rome.

In 1814 Consalvi went, as the pope's representative, to England to meet and confer with the allied sovereigns, and later in the year was sent as papal plenipotentiary to the congress of Vienna. Here he was successful in obtaining the restitution to the pope of the Marches (Ancona, Treviso and Fermo) and Legations (Bologna, Ferrara and Ravenna), but he failed to prevent Austria from annexing the ancient papal possessions on the left bank of the Po and obtaining the right to garrison Ferrara and Comacchio. This led to his presenting at the close of the congress

a formal *protestatio*, in which he not only denounced the failure of the Powers to do justice to the church, but also their refusal to re-establish that "centre of political unity," the Holy Roman Empire.

The rest of Consalvi's life was devoted to the work of reorganizing the States of the Church, and bringing back the allegiance of Europe to the papal throne. He was practically governor of Rome; and Pius was so much under his control that "Pasquin" said the pope would have to wait at the gates of paradise till the cardinal came from purgatory with the keys. Nor was the affectionate confidence of the pope misplaced. Consalvi's rule, in times of singular difficulty and unrest, was characterized by wisdom and moderation. He had to steer a middle course between the extremes represented by the Carbonari on the one hand and the Sanfedisti on the other, and he consistently refused to employ the cruel and inquisitorial methods in vogue under his successors. His foreign policy was guided by the traditional antagonism of the papacy to German domination in Italy, and generally by a desire to free the Holy See as far as possible from the political entanglements of the age. Thus he resisted all Metternich's efforts to draw him into his "system"; stoutly maintained the doctrine of non-intervention against the majority of the Powers of the continental alliance; protested at the congress of Troppau against the suggested application of the principle of intervention to the States of the Church; and at Verona joined with Tuscany in procuring the rejection of Metternich's proposal for a central committee, on the model of the Mainz Commission, to discover and punish political offences in Italy.

On the death of Pius VII. (August 21, 1823), Consalvi retired to his villa of Porto d' Anzio; and, though he accepted from the new pope the honorary office of prefect of the college *De Propaganda Fide*, his political career was closed. He died on the 24th of January 1824. By his will he directed that all the presents he had received should be sold, and the proceeds applied to the completion of Thorwaldsen's monument of Pius VII. in St Peter's.

Consalvi, besides being a statesman, was a man of wide and varied interests. As a young *abate* he had followed the fashion of writing verses, and to the end he remained a notable patron of the arts and sciences, music being his main passion. For the city of Rome he did much; ancient buildings were excavated and preserved by his direction; chairs of natural science and archaeology were founded in the university; and extensive purchases were made for the Vatican museum, which was augmented by the addition of the beautiful Braccio Nuovo, or new wing.

Cardinal Consalvi's *Mémoires* were published in two vols. by S. Crétineau-Joly (Paris, 1864). Other collections of documents are:—C. von Duern, *Correspondance du Cardinal Consalvi avec le Prince C. de Metternich, 1815* (Louvain and Brussels, 1899); S. Rinieri, *Correspondenza inedita dei Cardinali Consalvi e Pacca, 1814-1815* (Turin, 1903). See J. L. Bartholdy, *Züge aus dem Leben des Cardinal Hercule Consalvi* (Stuttgart, 1824); Cardinal Wiseman, *Recollections of the Last Four Popes* (London, 1853); Crétineau-Joly, *L'Église romaine en face de la Révolution* (1859); Ernest Daudet, *Le Cardinal Consalvi* (Paris, 1866); E. L. Fischer, *Cardinal Consalvi* (Mainz, 1890); Dr Fredrik Nielsen, bishop of Aarhus, *Hist. of the Papacy in the 19th Century* (2 vols., Eng. trans. by A. J. Mason, D.D., London, 1906), which treats of Consalvi's work in great detail. For other general authorities see *Cambridge Modern History*, bibliographies to vol. ix. chap. vii., by L. G. Wickham-Legg, and vol. x. chap. v., by Lady Blennerhassett.

CONSANGUINITY, or **KINDRED**, in law, the connexion or relation of persons descended from the same stock or common ancestor (*vinculum personarum ab eodem stipite descendentium*). This consanguinity is either lineal or collateral. Lineal consanguinity is that which subsists between persons of whom one is descended in a direct line from the other, while collateral relations descend from the same stock or ancestor, but do not descend the one from the other. Collateral kinsmen, then, are such as lineally spring from one and the same ancestor, who is the *stirps*, or root, as well as the *stipes*, trunk or common stock, whence these relations branch out. It will be seen that the modern idea of consanguinity is larger than that of *agnatio* in the civil law, which was limited to connexion through males,

and was modified by the ceremonies of adoption and emancipation, and also than that of *cognatio*, which did not go beyond the sixth generation, and was made the basis of Justinian's law of succession. The more limited meaning of *consanguinei* was brothers or sisters by the same father, as opposed to *ulerini*, brothers or sisters by the same mother. The degrees of collateral consanguinity were differently reckoned in the civil and in the canon law. "The civil law reckons the number of descents between the persons on both sides from the common ancestor. The canon law counts the number of descents between the common ancestor and the two persons on one side only," and always on the side of the person who is more distant from the common ancestor. English law follows the canon law in beginning at the common ancestor and reckoning downwards. The question of consanguinity owes its great importance to the relationship it bears to the laws of marriage and inheritance. For instance, the law forbids marriage between persons within certain degrees of consanguinity and affinity, a prohibition which applies with equal force to a bastard as well as to those born in wedlock. The laws of inheritance and descent are regulated in a great measure according to consanguinity, however much they may vary in different jurisdictions.

Apart from those countries which have made either the civil or the canon law the basis of reckoning degrees of consanguinity (and practically all civilized countries adopt one or other), it is impossible to describe any method or system, for they are as various as the countries and tribes. See, however, the article **INDIAN LAW**; and consult Lewis H. Morgan, *Systems of Consanguinity and Affinity of the Human Family* (Washington, 1870); J. F. McLennan, *On Primitive Marriage* (Edinburgh, 1865); E. A. Westermarck, *History of Human Marriage* (2nd ed., London, 1894); E. Crawley, *The Mystic Rose* (1902); A. Lang and J. J. Atkinson, *Social Origins and Primal Law* (1903); E. B. Tylor, *Primitive Culture* (4th ed., 1903). See also **AFFINITY**; **MARRIAGE**; **INHERITANCE**.

CONSCIENCE, HENDRIK (1812-1883), Flemish writer, was born at Antwerp on the 3rd of December 1812. Although he invariably signed his name Hendrik, his baptismal name was Henri. He was the son of a Frenchman, Pierre Conscience, from Besancon, who had been *chef de limonerie* in the navy of Napoleon, and who was appointed under-harbourmaster at Antwerp in 1811, when that city formed part of France. Hendrik's mother was a Fleming, Cornelia Balieu. When, in 1815, the French abandoned Antwerp after the Congress of Vienna, they left Pierre Conscience behind them. He was a very eccentric person, and he took up the business of buying and breaking-up worn-out vessels, of which the port of Antwerp was full after the peace. The child grew up in an old shop stocked with marine stores, to which the father afterwards added a collection of unsaleable books; among them were old romances which inflamed the fancy of the child. His mother died in 1820, and the boy and his younger brother had no other companion than their grim and somewhat sinister father. In 1826 Pierre Conscience married again, this time a widow much younger than himself, Anna Catherina Bogaerts, Hendrik had long before this developed an insatiable passion for reading, and revelled all day long among the ancient, torn and dusty tomes which passed through the garret of "The Green Corner" on their way to destruction. Soon after his second marriage Pierre took a violent dislike to the town, sold the shop, and retired to that Kempen or Campine which Hendrik Conscience so often describes in his books—the desolate flat land that stretches between Antwerp and Venloo. Here Pierre bought a little farm, with a great garden round it, and here, while their father was buying ships in distant havens, the boys would spend weeks, and even months, with no companion but their stepmother.

At the age of seventeen Hendrik left the paternal house in Kempen to become a tutor in Antwerp, and to prosecute his studies, which were soon broken in upon by the revolution of 1830. He volunteered as a private in the new Belgian army, and served in barracks at Venloo, and afterwards at Dendermonde, until 1837, when he retired with the grade of sergeant-major. Thrown in this way with Flemings of every class, and made a close observer of their mental habits, the young man formed the idea of writing in the despised idiom of the country,

an idiom which was then considered too vulgar to be spoken, and much less written in, by educated Belgians. Although, close by, across the Scheldt, the Dutch possessed a rich and honoured literature, many centuries old, written in a language scarcely to be distinguished from Flemish, a foolish prejudice denied recognition to the language of the Flemish provinces of Belgium. As a matter of fact, nothing had been written in it for many years, when the separation in 1831 served to make the chasm between the nations and the languages one which could never be bridged over. It was therefore with the foresight of a prophet that Conscience wrote, in 1830 itself, "I do not know how it is, but I confess I find in the real Flemish something indescribably romantic, mysterious, profound, energetic, even savage. If I ever gain the power to write, I shall throw myself head over ears into Flemish composition." His poems, however, written while he was a soldier, were all in French. He received no pension when he was discharged, and going back idle to his father's house, he determined to do the impossible, and write a Flemish book for sale. A passage in Guicciardini fired his fancy, and straightway he wrote off that series of scenes in the War of Dutch Independence which lives in Belgian literature under the title of *In't Wonderjaar 1566*; this was published in Ghent in 1837. His father thought it so vulgar of his son to write a book in Flemish that he turned him out of doors, and the celebrated novelist of the future started for Antwerp, with a fortune which was strictly confined to two francs and a bundle of clothes. An old schoolfellow found him in the street and took him to his home; and soon various people of position, amongst them the eminent painter, Wappers, interested themselves in the brilliant and unfortunate young man. Wappers even gave him a suit of clothes, and presented him to the king, who expressed a wish, which was not immediately carried out in consequence of some red tape, that the *Wonderjaar* should be added to the library of every Belgian school. But it was under the patronage of Leopold I. that Conscience published his second work, *Fantasy*, in the same year, 1837. A small appointment in the provincial archives relieved him from the actual pressure of want, and in 1838 he made his first great success with the historical romance called *The Lion of Flanders*, which still holds its place as one of his masterpieces. To this followed *How to become a Painter* (1843), *What a Mother can Suffer* (1843), *Siska van Roosemael* (1844), *Lambrecht Hensmans* (1847), *Jacob van Artevelde* (1849), and *The Conscript* (1850). During these years he lived a variegated existence, for some thirteen months actually as an undergardener in a country house, but finally as secretary to the Academy of Fine Arts in Antwerp. It was long before the sale of his books, greatly praised but seldom bought, made him in any degree independent. His ideas, however, began to be generally accepted. At a Flemish congress which met at Ghent so early as 1841, the writings of Conscience were mentioned as the seed which was most likely to yield a crop of national literature. Accordingly the patriotic party undertook to encourage their circulation, and each fresh contribution from the pen of Conscience was welcomed as an honour to Belgium. In 1845 Conscience was made a knight of the Order of Leopold. To write in Flemish had now ceased to be regarded as a proof of vulgarity; on the contrary, the tongue of the common people became almost fashionable, and Flemish literature began to live. In 1845 Conscience published a *History of Belgium*, but he was well advised to return to those exquisite pictures of Flemish home-life which must always form the most valuable portion of his repertory. He was now at the height of his genius, and *Blind Rosa* (1850), *Rikkeltikketak* (1851), *The Decayed Gentleman* (1851), and *The Miser* (1853) rank among the most important of the long list of his novels. These had an instant effect upon contemporary fiction, and Conscience had many imitators. Nevertheless, not one of the latter has approached Conscience in popularity, or has deserved to approach him. In 1855 the earliest translations of his tales began to appear in English, French, German and Italian, and his fame became universal. In 1867 the post of keeper of the Royal Belgian museums was created, and this important sinecure was given

to Conscience. He continued to produce novels with great regularity, and his separate publications amounted at last to nearly eighty in number. He was now the most eminent of the citizens of Antwerp, and his seventieth birthday was celebrated by public festivities. After a long illness he died, in his house in Antwerp, on the 10th of September 1883; he was awarded a public funeral.

The portraits of Conscience present to us a countenance rather French than Flemish in type, with long smooth hair, contemplative dark eyes under heavy brows, a pointed nose, and a humorous broad mouth; in late life he wore the ornament of a long white beard. Whether the historical romances of Conscience will retain the enormous popularity which they have enjoyed is much less than certain, but far more likely to live are the novels in which he undertook to be the genre-painter of the life of his own day. In spite of too rhetorical a use of soliloquizing, and of a key of sentiment often pitched too high for modern taste, the stories of Conscience are animated by a real spirit of genius, mildly lustrous, perhaps, rather than startlingly brilliant. Whatever glories may be in store for the literature of Flanders, Conscience is always sure of a distinguished place as its forerunner and its earliest classic. (E. G.)

CONSCIENCE (Lat. *con-scientia*, literally "knowledge of a thing shared with another person" or "complete knowledge," and derivatively "consciousness" in general), a philosophical term used both popularly and technically in many different senses for that mental faculty which decides between right and wrong. In popular usage "conscience" is generally understood to give intuitively authoritative decisions as regards the moral quality of single actions; this usage implicitly assumes that every action has an objective or intrinsic goodness or badness, which "conscience" may be said to discern much in the same way as the eye sees or the ear hears. Moralists generally, however, are agreed that in all moral judgments of this character there is an implied reference to moral laws, the validity of which is in some ethical systems the true subject matter of conscience. The part played by conscience in relation to general moral laws and particular cases will vary according to the view taken of the character of the general laws. If, on what is called the "jural" theory, these laws are regarded as deriving their authority from an external source, the operation of conscience is so far limited. It may be held to recognize the validity of divine laws, for example; or it may be confined to the deductive process of applying those laws to particular cases, known as "cases of conscience" (see **CASUISTRY**). If, on the other hand, the general laws are regarded as intuitive, then the discernment of them may be taken as the true function of conscience. In either theory, conscience may be understood as the active principle in the soul which, in face of two alternatives, tells a man that he ought to select the one which is in conformity with the moral law. Apart from the two functions of discerning between right and wrong, and actively predisposing the agent to moral action, conscience has further a retrospective action whereby remorse falls upon the man who recognizes that he has broken a moral law. See **ETHICS**; also **BUTLER, JOSEPH**; and compare the "moral sense" doctrine of Shaftesbury.

There are certain special uses of the word "conscience." A *Conscience clause* is the term given to a special provision often inserted in an English act of parliament to enable persons having religious scruples to absent themselves from certain services, or to abstain from certain duties, otherwise prescribed by the act. *Conscience money* is the name given to a payment voluntarily made by a person who has evaded his obligations, especially in respect of taxes and the like. This usage derives from the last function of conscience mentioned above. *Conscience Courts* were local courts, established by acts of parliament in London and various provincial towns, for the recovery of small debts, usually sums under £5. They were superseded by county courts (*q.v.*).

CONSCRIPTION (from Lat. *con-*, together, and *scribere*, to write), the selection, by lot or otherwise, of a proportion of the men of military age for compulsory service in the naval and

military forces of their country; or, more widely, compulsory military service in any form. For a discussion of the military features of conscription and of other forms of recruiting see ARMY, §§ 40 ff. The present article deals with the economic and social aspects of compulsory military service, for which, generally and non-technically, the word "conscription" is used more commonly than any other. The word occurs for the first time in France in the law of the 19th Fructidor (1798), which prescribes the liability of *les défenseurs conscrits* to serve if required from their twentieth to twenty-fifth year of age.

There is perhaps no law on the statute-books of any nation which has exercised and is destined in the future to exercise a more far-reaching influence on the future of humanity than this little-known French act of 1798, introduced by General Jourdan to the Council of the Five Hundred, for it was the power thus conferred upon the French government which alone rendered the Napoleonic policy of conquest possible. "I can afford to expend thirty thousand men a month"; this boast of Napoleon's, made to Metternich at Schönbrunn in 1805, has determined the trend of events from that day forward, not only on the battlefield, but also in the workshops, and forms even at the present day the chief guarantee for peace, stability and economic development upon the continent of Europe.

The idea in itself was not new. The principle that every able-bodied male is liable to be called on for the defence of the state dates from the earliest times. The essential importance of the event lies in this, that at a critical moment this law passed by an obscure body of men—absolutely in defiance of the opinion of the greatest reformer that France at that moment had discovered, Carnot, and of the feelings of a very large proportion of the whole community—became permanent by the action of causes set in motion by Napoleon, which ultimately compelled all Europe to adopt similar legislation.

To understand its full significance we must trace the line of evolution of the then existing armies of Europe.

In almost any state, in proportion as the central executive power prevailed over internal disturbance, the able-bodied males of each country ceased to have opportunities and incentives for training themselves to arms. Trade became more profitable than plunder, and men began to specialize in various directions. Wealth began to accumulate and fortresses sprang into existence for its protection, but the new fortifications required specialists for their reduction, and above all things an abundance of time. Militia forces (corresponding to the former feudal levies) neither could find the specialized labour nor would afford the time—hence the necessity arose of enlisting men who had made the use of arms their special study and were content to abide by the rules of conduct their maintenance as organized bodies imposed. But wherever Europe happened to enjoy a few years of peace, the supply of men who had trained themselves to arms naturally decreased, and the state itself was compelled to assume the task of training its recruits. This, with the exceedingly complicated nature of the weapons in use, was a very long process, and though even in the 16th century the idea of universal service was put forward by such statesmen as Machiavelli and Maurice of Nassau, practically it could not be put into force, because in the time the male population could economically give to their training, satisfactory results could not be obtained.

As Motley has pointed out in his *Rise of the Dutch Republic*, in the time of Alva 5000 disciplined Spaniards were a match for 20,000 and more burghers, though the latter were fighting with the courage of desperation, and were of necessity more or less inured to the horrors of warfare. But with every improvement in the nature of hand firearms this ratio of superiority of the trained soldiers tended to disappear, whilst as campaigns became fewer and shorter the difficulty of obtaining war-trained soldiers, accustomed to fighting as the Spaniards had been, always increased.

Moreover, after the peace of Westphalia—the close of the great era of religious wars—wars were made for dynastic reasons and primarily for the acquisition of territory; and since the territory was of no use without inhabitants to pay revenue, the "principle

of moderation was introduced into the conduct of hostilities, altogether foreign to their nature" (Clausewitz). Men were no longer allowed to live at free quarters or to pillage towns. On the contrary, even in an enemy's country, they had to submit to the severest restraints, and thus soldiering, being no longer remunerative, ceased to attract the more daring spirits.

Thus in the decade preceding the French Revolution soldiering had reached the very nadir of degradation all over Europe, and, though the Prussians, for instance, still retained a great relative superiority when fighting in closed bodies under the eyes of their leaders, the spirit which had led them to victory when fighting in and for their own country had entirely disappeared from their ranks when they had to face the French in their great struggle for existence.

Amongst the earliest problems of the French Revolution was the question of army reform, and compulsory service was at once proposed, and though for the time the opposition of most of the principal soldiers prevailed, ultimately a proposal was accepted by which voluntary enlistment was retained for the line, all unmarried citizens between eighteen and forty years of age constituted the militia, and the rest of the men the national guards for home defence.

The latter proved so popular that over 2,571,000 names were obtained. At once the militia was given up, and reliance was placed upon the national guard, which was called upon to furnish 169 battalions of volunteers. The result was disappointing. Only 60 incomplete battalions were furnished, and these (except for the few hundreds of enthusiasts amongst them from whom came many of the marshals, generals and colonels of the empire) were recruited from the least trustworthy sections of the community. These were the celebrated *Volontaires* and proved a positive scourge wherever they were quartered. It was clear that they could not meet the invaders, and the assembly decreed^d on the 11th of July 1792 "La patrie en danger," and ordered every able-bodied man to consider himself liable for active service, but left it to the communes and districts to select representatives to proceed to the front. These men were called *Fédérés*, and seem to have been principally those whom the communes desired to get rid of.

But, though the idea of compulsion was present, the means of enforcing the law at the time were so imperfect that the result of this effort was only 60,000 men, of whom not more than half ever reached the field armies. Further, the law had announced that the liability extended only for the duration of the particular campaign, which in accordance with the prevalent idea of war was considered to terminate when winter quarters were taken up. In December, therefore, most of the men raised during the year took their discharge, and with the new year the work had to begin all over again. To fill the gaps caused by this sudden defection, and in view of the addition of Great Britain to the list of their enemies, the Convention decreed on the 20th of February 1793 a fresh compulsory levy of 500,000 men. Quotas were assigned to each department and commune, and three days' grace was allowed to each to find their contingents by volunteering; failing this recourse was had to compulsion, all unmarried national guards between the ages of eighteen and forty being held liable. Thereupon thousands fled from their homes, and Vendée (*q.v.*) rose in open revolt.

Then on the 18th of March came the disaster of Neerwinden, and again the danger of invasion loomed near. In this emergency the Committee of Public Safety replaced the existing recruiting agents by special commissioners with unlimited power, and these ruthlessly hunted down those who attempted to evade their liability. Still the result was inadequate to meet the danger arising from the fall of Valenciennes and Condé. The Jacobins appeared before the Convention on the 12th of August and demanded the *Levée en masse*, and, using the popular outcry as a fulcrum, Carnot at length succeeded in introducing a workable scheme of compulsion, which limited the liability to service to all able-bodied men between eighteen and twenty-five, but within these limits allowed no exemptions. This became law on the 23rd of August, and it at once began to operate satis-

factorily, because it was limited to a class who were neither sufficiently numerous, nor sufficiently important politically, to resist coercion. Meanwhile other factors had intervened to render military service more popular. Famine was spreading, political persecution was at its highest, and the ranks of the army became almost the only refuge where men could escape the terrors of secret denunciation. Moreover, experience in the Netherlands and the Palatinate had shown that men could live very comfortably at their enemy's expense. All these causes combined made an immense increase in the yield of the new law, and, according to the careful estimate of the duc d'Aumâle (1867), by the 1st of January 1794 there were no less than 770,000 men under arms and available for active service. The tide of success in the north of France now definitely turned against the Allies, for they were powerless against the mobility and numbers produced by hunger and political terrorism. Bonaparte's successes of 1796 were the highest expression of the "new French" method thus developed.

But with the respite which his victories in Italy immediately secured, a reaction against the severity of the conscription soon made itself felt, and the obvious need for internal development gave the discontented a lever for extorting concessions from the government.

To the political economists of the period it seemed a deliberate waste of productive energy to take the young merchant or clerk from his work and force a musket into his hands, whilst other men already trained were willing to renew their contract to defend the state. To regulate this question and also to define more clearly the obligations of the citizen, Jourdan introduced before the Five Hundred a report calling for a reorganization of the army. This ultimately, in the autumn of 1798, became the law of the country and remained practically unaltered as the basis of the French military organization down to 1870. The law definitely laid down the liability of every able-bodied French citizen to serve from his twentieth to his twenty-fifth year, leaving it to circumstances to determine how many classes or what proportion of each should be called up for service. Finally, after much discussion the right of exemption by payment of a substitute was conceded, and therein lay the germ of the disaster of 1870.

Meanwhile, with the assumption of the imperial title by Napoleon, the era of conquest recommenced, and as each fresh slice of territory was absorbed the French law of conscription was immediately enforced. This still further swelled the numerical preponderance against which the other nations had to contend, and each in turn was compelled to follow the French example. Prussia, however, alone pursued the idea to its logical conclusion, and in the law of 1808 definitely affirmed the principle of universal service without distinction of class or right of exemption by purchase.

Under the restrictions as to numbers imposed on Prussia by Napoleon after Tilsit, and also as a consequence of exceeding poverty, this law found only partial fulfilment, and voluntary organization had to be called into existence to meet the demand for numbers during the Wars of Liberation; but when after 1815 peace was at length assured, the system came into full operation, and it is to this that Prussia owed her phenomenal recovery from the depths of exhaustion into which the catastrophe of Jena had plunged her.

Army expenditure became the fly-wheel which steadied her disorganized finance. The troops had to be fed, clothed, equipped and housed; and the several occupations and trades involved in these processes gave profitable employment both to intellect, which was required to invent, devise and control, and to capital, which would have shirked the risks attending any but government contracts, and remained in private hoards, to the detriment of the reproductive power of the nation.

The compulsory intercourse of all ranks compelled the classes to educate the masses—using the term "education" in its broadest sense. Free book-education itself had been forced on the nation as a military necessity of the moment, for without a certain degree of intellectual development in the recruits it was

impossible to make soldiers of them within the short time available. But the practical value and application of the book teaching had, in sheer self-defence, to be imparted by the better-class recruits to their social inferiors, and, in the unconscious exercise of these functions as teachers of one another, all found themselves strengthened in character and universal sympathies.

The intelligence of the men reacted on the officers, who could no longer exercise authority by mere word of command, but were compelled, if they wished to survive, to teach by intelligent methods; and they were compelled to struggle for survival because outside of the army absolute ruin and destitution awaited them.

The duration of service being limited to three years, it followed that each year brought with it an influx of recruits to each battalion beyond the power of a few specialists to cope with. Hence the work had to be delegated to the captains and sub-alterns, who thus were compelled to become the teachers as well as the leaders of their men. The results from a military point of view were incalculable.

Perhaps the greatest benefit Prussia derived from her system during the first two generations—*i.e.* from 1810 to 1860—of its continuance was the insensible fusion which took place between the aristocracy and the people as a consequence of their enforced co-operation in a common task. Freed from the fear of French oppression, the court and the older men of the nobility would have swung back to the full exercise of their old feudal privileges; for as they still retained the bulk of the executive power, all the legal reforms and restrictions initiated by von Stein would have proved but paper safeguards; but the army compelled the opposing classes to understand and appreciate one another better, and the younger generation, living always with the threat of invasion impending over them, learnt by emulation from their seniors, who had led their men in battle, the true secret of command, the art of awakening the higher instincts of the men entrusted to them. If it seems to British readers that their progress was slow and that much remains to be accomplished, their starting-point at the outbreak of the French Revolution must be recalled and contrasted with that of the British army; indeed, we must go back to the time of Henry VII. to find a fair parallel.

It must be remembered too that we are speaking of Prussia only. In the other states of Germany which retained conscription with paid substitutes progress was far slower. The whole of Bavaria, Württemberg, and the districts along the Rhine had been saturated with French socialistic theories, and here the task of regeneration fell into other hands, and freedom, of a relative kind, had to be extorted by revolutionary means. To these reformers—many of them both devoted and enlightened thinkers—the armies of their own little states necessarily appeared as merely authorized oppressors of the people; and they may well be pardoned for failing to appreciate the essential differences involved in the two systems.

As the years went by, the Prussian military machine was turning out year by year an ever-increasing number of men, who by reason of the physical and moral training they had undergone were head and shoulders above the class whence they had sprung. These men soon asserted their superiority in the labour market and drove their weaker comrades to the wall. The men thus displaced, being obviously less fitted to maintain wives and families, found themselves supplanted by their stronger rivals in the affections of the women, and jealousy being thus evoked, they became as it were a nidus for revolutionary bacilli. This partly explains the temporary recrudescence of revolutionary tendencies during the 'forties and 'fifties. But the growing wealth-producing power of the nation, due to the higher average physique and power of concentration (the consequence of the military training), began to attract the attention of capitalists, and an era of railway construction set in, distributing wealth and employment about the country. This for a time relieved the congestion of the labour market, and, long before the victories of 1866 and 1870 had definitely removed the

last fears of invasion, industries were beginning to spring up around the great trading centres of Germany.

With the treaty of Frankfurt the last fears of the investors vanished, and capital, hitherto dammed back by the uncertainty of land tenure, particularly in the Rhine districts, literally poured into the country, inducing an era of expansion and prosperity for which one can hardly find a parallel, even in America.

That such a period of evolution should have been attended by fluctuations lies in the nature of things. Men accustomed to deal only in hundreds find it difficult to adapt themselves to the business methods requisite to deal securely with millions, and there have been many severe crises due to over-production and speculation, which displaced large masses of workmen and brought misery to thousands of homes.

The remarkable increase of population, the direct consequence of the broader understanding of elementary hygienic principles instilled into the men during their service with the colours, brought a fresh complication into the problem. The strength of the army being definitely fixed by financial considerations, the proportion of men taken for service to the total number annually becoming liable fell off, during the 'eighties, to a very marked degree, and the men who escaped service, being as a consequence of their want of training less fitted for employment in the organized industries which were in process of evolution, swelled the ranks of the unemployed and thus afforded fresh material for the socialist propagandists to work upon. If the proportion of men escaping service rose materially above one-half of the total yearly contingent of men becoming available for service, the danger lay very near that the socialist vote might soon exceed all other interests put together, thus threatening the stability of all existing institutions. To meet this danger it was determined in 1893 to increase the annual contingent whilst diminishing the duration of colour service, so that approximately two-thirds of the men available should pass through the ranks, it being held that the habit of obedience to constituted authority acquired in the army, together with the silent influence which could be exercised on the ex-soldiers and reservists by the sympathy and example of their former commanders of all ranks, formed the best possible guarantee against the undue spread of socialistic doctrine. It was never anticipated that all men who had served their two years would become partisans of constituted authority, but only that, whilst all would learn the hopelessness of armed resistance against the force which held control of the solid-drawn cartridges and artillery material, the bulk at least would recognize the substantial advantages that accrued to them personally from their previous connexion with the services, and would form a solid bulwark against the spread of subversive doctrines.

To realize the whole situation, the attitude of the leading thinkers amongst the statesmen and soldiers of Germany must be borne in mind. Socialism is to them a necessary lever to extort from capital fairer conditions for labour, capital must be fairly dealt with if the labourers' reasonable demands are to be satisfied, and the army is the compensating lever which secures the necessary adjustments. Capital is attracted by the security of tenure ensured by a strong army, and the working classes are encouraged to put forward reasonable demands by the habits of self-respect and the sense of individuality they acquire in the army, whilst the possible danger of any abuse of the offensive power the army embodies is curbed by the fact, well known and realized by all continental soldiers, that though one may order men on to the battlefield, one cannot guarantee that they will fight when they get there unless the cause they are called on to defend appeals to the hereditary instincts of self-preservation in the race itself. It is unfortunate that sufficient attention has not yet been paid to the statistical side of this question, and concrete figures are not forthcoming to demonstrate the material benefits which have flowed from compulsory service.

Briefly, however, it may be pointed out that under modern conditions of industry the greatest national wealth-producing power resides, not as formerly in the technical skill of the individual, which machinery is gradually superseding, but in the

power of continuous collective effort of organized bodies, and that physical health and the power of mental concentration are the principal qualities required by the units of such bodies. Now these are the two essential factors which modern methods of military training aim at developing, and these methods in turn evolved naturally from the conditions of service which compulsion introduced. The men who have undergone this training leave the ranks with bodies steeled to resist disease, and minds capable of prolonged concentrated effort. Hence they not only remain capable of work for a considerably longer period of time, but they also do better work throughout the whole time. It has been estimated that on the average the trained German soldier's expectation of life is about five years better than the normal of his own class. Hence altogether about one million men are still alive and doing good work who without such training would be dead and buried; similarly there are in all some seven millions more, all doing better work day for day than they otherwise would have done.

On the whole the armies of the German states absorbed in taxation some 1500 million sterling from Waterloo (1815) up to 1906; hence if we assume the increment of wealth-producing power due to training as only two shillings a week per man, the net return on the capital invested must be regarded as enormous, and that some such economic process has been in action is sufficiently indicated by the almost incredible growth in national credit during the same period.

At the close of the Napoleonic wars, German (including Prussian) credit was actually *nil*, and there was hardly a town or hamlet throughout the area swept over by the French armies that was not paying heavy interest on loans raised to satisfy the rapacity of its conquerors. Many of these loans still remained unliquidated at the close of the 1870 campaign. Yet since then the credit, both of the individual states and of the empire as a whole, has risen to a point rivalling that of Great Britain, in spite of the fact that in geographical position and in material resources the country is by no means favourably situated.

These advantages have followed on the introduction of compulsory service in Germany—not because there is any inherent virtue in the principle of compulsion in itself, but because it happened that, at the moment compulsion became necessary, the idea was exactly adapted to its environment, and the driving forces necessary to ensure its permanency remained in full activity. Primarily there existed an aristocracy numerically sufficient to fill the offices of instructorship to the masses, and poverty compelled this aristocracy to accept the new responsibility. In the second place there was the knowledge of what war really means, sufficiently vivid and fresh in the minds of the masses to induce them to submit to the necessary restraints of military discipline. When these causes were no longer in full activity, there remained, as sufficient incentive to those still in the active phase of their training, the knowledge that the nation at large, and more particularly the women, fully appreciated the sacrifices that all ranks were compelled to make.

In other nations these driving forces have been absent. Thus in Russia the aristocracy was both numerically and intellectually inadequate to the tasks compulsion entailed upon it. But generally it can be seen that the success or failure of the system has been in exact proportion to the degree in which these driving forces have been available. The failure of compulsion if applied in the British Isles would be due to the fact that the principal factor of its success—the knowledge of what war must mean and the risk of immediate invasion—cannot be brought home to the people as long as the British navy retains its predominance. If the navy is adequate to prevent invasion, then compulsion is unnecessary; if it is inadequate, then the only way to make good its inadequacy is to bring home to the electors by a course of partial training the consequences which must ensue if they continue to neglect it.

(F. N. M.)

CONSECRATION (Lat. *consecratio*, from *con* and *sacrare*, "to make sacred"), the separating or setting apart of certain persons, animals, things, places and seasons as sacred, so as to hallow and sanctify them in themselves or adapt them to a

religious rôle and purpose. Thus we consecrate a king, a priest, a deacon; a temple or a church and any part of church furniture; we also consecrate water for use in lustrations, bread and wine in the sacrament; a season or day is consecrated, as a feast or fast. We consecrate ourselves either in a ritual act, as of baptism or ordination, vows or monkish initiation; or, without any implication of particular ceremonies, a man is said to consecrate himself to good works or learning.

The above are good senses of the word, but it is also used in the sense of devoting things and persons to destruction; and in this sense it is tantamount to cursing. Holiness is dangerous and may even involve degradation, as in the case of the Burmese *para-gyoon* or servitor of the pagoda who is by heredity for ever a slave and outcast, unclean of the unclean, with whom none may eat or intermarry, yet ever tending and keeping clean the shrine. Particular sites, rivers, springs, hills, meadows, caves, rocks, trees or groves, are holy and from time immemorial have been so, as the natural homes or haunts of gods or spirits. Here God has appeared to men, and will again. Such sites in the Old Testament were Hebron with its tree, Sinai with its burning bush, Bethel, Shechem, Beersheba, Mount Gerizim. As a rule their initial consecration goes back beyond memory and tradition; we can rarely seize it in the making, as in the case of a Roman *puteal*, or spot struck by lightning, which was walled round like a well (*puteus*) against profanation, being thenceforth a shrine of Semo Sancus, the god of lightning. In ancient society certain animals, plants, kins, families, were also holy and bound up with the god by blood-ties or otherwise. A priestly kin owned perhaps the spot haunted by the god, and so became holy. Plants and animals were often hallowed as totems (*q.v.*). Among the Australian-natives we catch the consecrating agency at work. Their babies are incarnations of spirits which quitted a bush or rock passed by the mothers at the moment of conception. Each spirit, as it quits its *nanja* or natural haunt to enter the mother, drops a *churinga*, a slab of stone or wood marked with the child's totem and containing its spirit attributes. These are collected and treasured up for ever.

We also catch the god himself at the work of consecration in tales of voices heard from heaven or of birds alighting on favoured heads. In the *Talmud* the voice from heaven, called *Bath Kol*, attested Rabbi Hillel, as he walked in Jericho, to be worthy of the holy spirit's descent and in-dwelling. At his baptism a dove descended upon Jesus, and one quitted Polycarp's body at the moment of his death. In Philo the wild pigeon symbolizes the holy spirit. A dove also descended out of a pillar of light on the occasion of the baptism in Jordan of the saintly Basil, bishop of Caesarea; and an eagle lit down upon King Tarquin. Most birds for the primitive man are souls, and the Polynesians hold that birds convey from and into their idols the spirits which live therein. A natural consecration also hallows objects fallen from heaven, like the holy shield of the Sabii, or the holy *ikons* or pictures "not made with hands" which abound in Russia.

In such cases the holiness or *taboo* (*q.v.*) is traditional, or anyhow not imparted at a given moment by human intervention. The god has not been constrained or invited to enter in. The Fetish religions afford examples of such constraint or invitation. Spirits capable of being confined in matter and made useful are in various ways sung or coaxed into the tenements prepared for them. Thus a West African native who wants a *suhman* takes a rudely-cut wooden image or a stone, a root of a plant, or some red earth placed in a pan, and then he calls on a spirit of Sasa-bonsum ("a genus of deities, every member of which possesses identical characteristics") to enter the object prepared, promising it offerings and worship. If a spirit consents to take up its residence in the object, a low hissing sound is heard, and the *suhman* is complete. It receives a small portion of the daily food of its owner, and is treated with reverence, and mainly used to bring evil on some one else.¹ This is a typical case of a human consecration. Invocation of a name, with sacrifice and anointing, consecrated the Semitic *massebas* or *nosbs*,—erect pillars of stone

¹ From A. B. Ellis, *The Tshi-speaking Peoples of the Gold Coast* (1887), cited in A. C. Haddon's *Fetichism and Magic*.

in which the god really lived, and which were no mere images or symbols of him. Two such still remain hard by the ruins of the royal sanctuary of Edom, overlooking Petra, and are obelisks in form, 18 ft. high. They were usually set up under a holy tree to commemorate a divine epiphany and were mostly unwrought (Exod. xx. 25), lest the hand of human craftsman should introduce another *numen* or divine power than what the votaries wished to tenant them. The consecration consisted of a smearing with fat of victims or with oil of vegetable offering (Gen. xxviii. 18), and the life or soul inherent in these passed into the stone. Such stones were familiar objects in the streets of an old Greek city, where Theophrastus (*Characters*, ch. 16) saw the "superstitious" man, as he passed by, take out his phial of oil, pour it over them, and kneel down before them to say his prayers. In a street of Benares similar devotions meet the eye, as dainty maidens pour out phials of holy water over erect stones of the same obscure pattern that was common also in Greece and Italy. The Semitic word for a stone tenanted by the numen was *Beth-el*, house of god, in Greek *βαίτυλος*. It was often small and portable, and known as a "stone ensouled." Such stone pillars were usually two in number, as in Solomon's temple (1 Kings vii. 15, 21) or in Melkarth's shrine at Tyre, described by Herodotus (ii. 44). Sometimes twelve stood together, e.g. in Jos. iv. 20 and Exod. xxiv. 4, which passages may have suggested that Armenian rite of founding a church, in which we witness the transition from a stonehenge to a church building. The bishop and clergy choose a suitable spot, and erect twelve large stones unwrought and unpolished around the central rock of the altar, and on these the walls of the church are laid. In Armenia and the Caucasus the cult of such sacred trees and pillars passed without break into that of the cross, which was hallowed as follows. By popular preference made of the wood of a sacred tree, it was brought into church, and washed first with water and then with wine, or anciently perhaps with blood of a victim. The people pray "for the sending of the grace of the Holy Spirit into this image of His all-powerful and uplifted arm" into the holy oil, with which he then makes the sign of the cross first on the eye and afterwards on the four wings of the cross, saying: "May this cross be blessed, anointed and hallowed in the name of Father and Son and Holy Spirit." He then lays his right hand on it and ordains it, with the prayer: "Lay, O Lord, Thy holy hand upon this emblem of the cross and bless it." The people kiss the cross and bow down to it; and ever after Christ's spirit is enshrined in it; it cures disease, drives off demons, and wards off wind and hail. Animal victims are sacrificed before it, as in old days before the sacred pole or pillar, and it is worshipped and adored. He that dies in defence of it is a holy martyr. Thus Christ ousted in the stocks and stones the old evil spirits that tenanted them, and took their place. Among the Greeks cruciform shape sufficed of itself to hallow wood or stone.

In Hinduism the various implements of sacrifice are similarly personified and worshipped, especially the sacrificial post to which the victim is bound, and which, under the name of *vanaspati* and *svaru*, is deified and invoked. It is a survival of tree-worship and comparable to the Semitic *ashera*. The *Rigveda* (3, 8) describes it as a tree well lopped with axe, anointed and adorned by the priest. Such a post set up by the priests is a god, is thrice anointed with *ghee* (or holy butter), and being set up beside the fire is invoked to let the offering go up to the gods.²

It is not always easy to mark off consecration from inspiration. Thus in New Zealand "a priest by repeating charms can cause the spirit to enter into the idol . . . it is the same *atua* or spirit which will at times enter not the image but the priest himself, throw him into convulsions and deliver oracles through him."³ It is, however, best to restrict the term "consecration" to cases where the spirit falls on a person, not automatically or unexpectedly, but by invitation, in response to prayer, through laying-on of hands and greasing, after a formal fast, continence, ritual

² "Vedic Mythology," by A. A. Macdonnell, in *Grundris der indo-arischen Philologie* (Strassburg, 1897).

³ Tylor, *Primitive Culture*, ii. 174.

washing, and so forth. Thus in 1 Sam. x., Samuel ordaining Saul "took the vial of oil and poured it upon his head and kissed him," and soon afterwards "God gave Saul another heart"; so that when he met the band of prophets the contagion flew from them to him, "and the spirit of God came mightily upon him, and he prophesied among them."

The recognized modes of communicating the afflatus, power or *numen* to a person or thing to be consecrated are many, and only a few can be enumerated. (1) Blowing. The risen Jesus (John xx. 22) breathed on his disciples and said, "Receive ye the Holy Ghost." The Roman priest, in consecrating the water of the font for baptism, blows over it and signs it twice with the cross. He also begins the rite of baptism by blowing in the catechumen's face. In the rite of laying hands on an elect the bishop of the Armenian Paulicians blows three times in the face of the newly ordained. The impure spirit is blown out and the pure blown in. (2) Laying-on of hands. The particular persons whose virtue is to be transmitted lay their hands on the head or shoulders of the consecrand, e.g. three bishops in episcopal consecration. (3) Branding or signing the person, especially on the forehead, with the sacred emblem. So a Hindu paints his caste emblem on his forehead, and a fugitive slave in ancient Egypt, once marked with sacred stigmata in a temple, could not be reclaimed by the master. He belonged to the god. Roman recruits when they took the *sacramentum*, or oath of fealty, were tattooed with the "sign" or "seal." So in Christian initiations the sign of the cross is made on the brow, and in Revelation the redeemed are so marked. Mexican peasants regularly paint or tattoo a cross on their foreheads, and the old Armenian equivalent for destiny or fate is *žakatalgir* or forehead-writing. An inanimate object is similarly consecrated. The "soldiers" of Mithras, says Tertullian, were signed or sealed on their foreheads. (4) Use of a name. The invocation of a powerful name over a thing or person brings him or it within its sphere of influence, and actually communicates thereto the demoniac or supernatural power wielded by the owner of the name.

Amulets, seals, talismans, relics, ear or nose rings stamped with divine emblems or otherwise hallowed, communicate their holiness to the wearers and protect from the Adversary. Personal ornaments and decorations of dwellings, furniture, vehicles and pottery had once a consecrating, or—what often comes to the same thing—a prophylactic value and significance. Mutilations, such as circumcision, violation of chastity in the case of maidens hallowed to certain gods, ritual cutting of hair and nails, and their deposition in a sanctuary, rather belong to the category of sacrifice, as also the burial of a living victim under the foundations of a new building or bridge (see SACRIFICE). Cursing is, equally with consecration, a *taboo* imposed on a thing or person. It may be noted in consecration how nicely the taboo or contagion, whether of holiness or unholiness, can be localized. An Arab's curse is escaped by falling flat on the face, for it then shoots over the head; and recently the following case was referred from French Canada before the judicial committee of the privy council. A man buried his wife in a plot he had bought in a Catholic cemetery. Presently he died also, but without the sacraments, for he had changed his religion. His executors ignored the protests of the Catholic clergy and buried him in the same grave. Ultimately the bishop of Quebec, unable to get a mandamus from the English privy council to dig him up, solemnly deconsecrated the ground down to the estimated depth of the lid of the wife's coffin. The use of specially consecrating cemeteries among Christians is first mentioned by Gregory of Tours (c. 570); but under the Roman law they had, like those of the Pagans, been held inviolable by pagan emperors like Gordian and Julian and defined as "*res religioni destinatae quin immo (iam) religionis effectae*" (*Cod. Justin.*, lib. ix. tit. 19).

Lastly, a classical mode of consecrating persons, or winning or reinforcing their holiness or kinship with the god, is the sacrificial meal at which sacred animals or the god himself are eaten. (See SACRAMENT and SACRIFICE.) Consecration is so frequently the counterpart of PURIFICATION that the article thereon should be read in connexion with this. For the con-

secration of bishops, see BISHOP; for that of churches, see DEDICATION.

AUTHORITIES.—E. B. Tylor, *Primitive Culture* (London, 1903); Robertson Smith, *Religion of the Semites* (London, 1901); Mary H. Kingsley, *West African Studies* (London, 1901), and *Notes on the Folklore of the Fjort* (London, 1898); W. Warde Fowler, *The Roman Festivals* (London, 1905); L. R. Farnell, *The Evolution of Religion* (London, 1905); J. G. Frazer, *The Golden Bough* (London, 1900); A. C. Haddon, *Fetichism and Magic*, containing a good bibliography (London, 1906). For Christian rites of consecration, see J. Goar's *Euchologion* (1647); H. A. Wilson, *The Gelasian Sacramentary* (Oxford, 1894); F. C. Conybeare's *Rituale Armenorum* (Oxford, 1905); L. Duchesne, *Origines du culte chrétien* (1889); M. Magistretti, *Monumenta veteris Liturgiae Ambrosianae, Pontificale* (Milan, 1897). (F. C. C.)

CONSEIL DE FAMILLE ("family council"), in France, an institution for the protection of the interests of minors. By the Code Civil (art. 407-410) it is composed of seven members. The local justice of the peace (*juge de paix*) is the presiding officer. The other six members must be relations of the minor, chosen from the mother's and father's side of the family respectively (three on each side). The Code gives in minute detail rules for choosing these relations. Meetings of the family council are held in private, five of the members constituting a quorum. The council has power to appoint a guardian to the minor; to authorize marriage or oppose it; to audit the accounts and decide questions concerning the minor's estate. The French family council is founded on the Roman law of tutelage, and has a long and useful history.

CONSERVATIVE PARTY, in Great Britain, the name of the successors of the Tories (see WHIG AND TORY) as one of the great political parties, representing the opposition to the Liberal party (*q.v.*), championing stability rather than innovation, or the advantages of preserving inherited conditions so far as possible rather than adopting changes which are founded on theoretical ideals. J. W. Croker suggested the term (*Quarterly Rev.*, Jan. 1830) as more appropriate than "Tory," but for some time it was only used sporadically, and many of the old Tory régime disliked it. The term "Tory" has in fact never quite fallen out of use, and has been commonly retained by many modern Conservatives who wish to emphasize that theirs is a constructive and positive policy of constitutional as opposed to radical reform, and not merely one of letting things remain simply "as they are." Similarly attempts were made in the 'eighties to substitute "Constitutionalist," but without its becoming current coin; and Lord Randolph Churchill called himself a "Tory democrat."

Sir Robert Peel, in a speech in the House of Commons, protested against the "un-English name of Conservative." Yet Peel himself shattered the old Tory and Protectionist party in 1846, and soon after called himself a Conservative, and the Peelites were commonly spoken of as "Liberal Conservatives." And when "Liberal" came into regular use for one party, "Conservative" became the recognized term for its opposite, Toryism being popularly regarded as the reactionary creed of the supporters of "vested interests" and opponents of reform of any kind. The character of any British Conservative party, in the widest sense of the term, has naturally changed, and was bound continually to change, with the progress of events. The successive Reform Acts, which put political power into the hands of new classes of the electorate, made it necessary to make a new sort of appeal to them, in order to support the causes of the church establishment, the House of Lords, and the main features of the constitution. The history of this movement cannot be summarized here, but the salient details may be found in the biographical articles on such leading Conservative statesmen as Lord Beaconsfield, Lord Salisbury and Mr A. J. Balfour (*qq.v.*). In organization the party followed much on the lines of the Liberal party. After 1832 associations known as "Constitutional" or "Conservative" multiplied throughout the country; and a "National Union of Conservative and Constitutional Associations" formed a confederation in 1867, in alliance with the work of the Central Conservative Office under the party whips. It was, however, unlike the similar Liberal

"National Liberal Federation," under the control of influential people who were loyal to the Central Office. In this respect the Conservative party, as an internally loyal party, had some advantage in organization; and such independent outbreaks as that of the "Fourth Party" (in the parliament of 1880), while stimulating to the Central Office, may be said to have applied a useful *massage* rather than to have led to any breaking of bones; while the Primrose League and similar new bodies acted as co-operating agencies. Mr Gladstone's proposal of Home Rule for Ireland in 1886 resulted in a great accession of strength to the party, owing to the splitting off of the Liberal Unionists from the Liberal party. From this time the term "Unionists" began to come into use, to signify both the Conservative and the Liberal Unionist parties; the distinction between the two wings gradually grew smaller; and by degrees the name of "Conservative party," though officially maintained, became more and more vague, as politics centred round Ireland, Imperialism or Tariff Reform.

See also M. Ostrogorski, *Democracy and the Organization of Political Parties* (Eng. trans., 1902); T. E. Kebbel, *History of Toryism* (1886).

CONSERVATOIRE (the Fr. equivalent of Ital. *Conservatorio*, Ger. *Conservatorium*, from Med. Lat. *conservatorjūm*, a place where anything is preserved, Lat. *conservare*, to preserve), a public institution for instruction in music and declamation. The name Conservatoire is generally used not only of the French institutions to which it properly applies, but also of the Italian Conservatorio and the German Conservatorium, and even sometimes of English schools of music. In the United States, however, the anglicized form "Conservatory" is used, a form far more satisfactory from the point of view of linguistic purity, but difficult to establish in England owing to its common application to a particular kind of green-house (see **HORTICULTURE**). The Italian conservatorios were the earliest, and originated in hospitals for the rearing of foundlings and orphans (whence the name) in which a musical education was given. When fully equipped, each conservatorio had two *maestri* or principals, one for composition and one for singing, besides professors for the various instruments. Though St Ambrose and Pope Leo I., in the 4th and 5th centuries respectively, are sometimes named in connexion with the subject, the historic continuity of the conservatoire in its modern sense cannot be traced farther back than the 16th century. The first to which a definite date can be assigned is the Conservatorio di Santa Maria di Loreto, at Naples, founded by Giovanni di Tappia in 1537. Three other similar schools were afterwards established in the city, of which the Conservatorio di Sant' Onofrio deserves special mention on account of the fame of its teachers, such as Alessandro Scarlatti, Leo, Durante and Porpora. There were thus for a considerable time four flourishing conservatorios in Naples. Two of them, however, ceased to exist in the course of the 18th century, and on the French occupation of the city the other two were united by Murat in a new institution under the title Reale Collegio di Musica, which admitted pupils of both sexes, the earlier conservatorios having been exclusively for boys. In Venice, on the other hand, there were from an early date four conservatorios conducted on a similar plan to those in Naples, but exclusively for girls. These died out with the decay of the Venetian republic, and the centre of musical instruction for northern Italy was transferred to Milan, where a conservatorio on a large scale was established by Prince Eugène Beauharnais in 1808. The celebrated conservatoire of Paris owes its origin to the École Royale de Chant et de Declamation, founded by Baron de Breteuil in 1784, for the purpose of training singers for the opera. Suspended during the stormy period of the Revolution, its place was taken by the Conservatoire de Musique, established in 1795 on the basis of a school for gratuitous instruction in military music, founded by the mayor of Paris in 1792. The plan and scale on which it was founded had to be modified more than once in succeeding years, but it continued to flourish, and in the interval between 1820 and 1840, under the direction of Cherubini, may be said to have led the van of musical progress in Europe. In more recent years that place of honour belongs decidedly to the

Conservatorium at Leipzig, founded by Mendelssohn in 1843, which, for composition and instrumental music, became the chief resort of those who wished to rise to eminence in the art. Of other European conservatoires of the first rank may be named those of Prague, founded in 1810; of Brussels, founded in 1833 and long presided over by the celebrated Fétis; of Cologne, founded in 1849; and those instituted more recently at Munich and Berlin, the instrumental school in the latter long enjoying the direction of Joachim. In England the functions of a conservatoire have been discharged by the Royal Academy of Music of London, founded in 1822, which received a charter of incorporation in 1830, the Royal College of Music (1882), the Guildhall school, and similar institutions. The chief public institution for teaching music in the United States is the National Conservatory of Music of America, founded in New York in 1885. The famous Dvořák was for a time its director. Other well-known American establishments are the Peabody Conservatory in Baltimore (1868), the Cincinnati College of Music (1878), and the New England Conservatory of Music in Boston (1867).

CONSERVATOR (Lat. *conservare*, to preserve), one who preserves from injury, a guardian or custodian. In the middle ages the title of conservator was given to various officers, such as those appointed by the council of Würzburg in 1287 to protect the privileges of certain religious persons, the guardians of academic rights in the university of Paris, certain Roman magistrates as late as the 16th century, or the *conservator Judaeorum* who was enjoined to look after the Jews of the county of Provence in 1424. By the 2 Henry V. there was appointed a conservator of truce and safe conducts in each English seaport "to enquire of all offences done against the king's truce and safe conducts, upon the main sea, out of the liberties of the cinque ports." In Scotland the conservator of the realm (c. 1503) had jurisdiction to settle the disputes and protect the rights of Scottish merchants in foreign ports or places of trade. In England the conservators of the peace (*custodes pacis*) were the precursors of the modern justices of the peace. Stubbs traces their origin to the assignment of knights, in 1195, to enforce the oath to preserve the peace which Richard I. ordered to be taken by all persons above the age of 15. By the 1 Edward III. conservators of the peace were appointed for each county to guard the peace and to hear and determine felonies. The office was reconstituted by the parliament of 1327, and its powers were extended in 1360. From the sovereign and the lord chancellor down to the justice and the village constable, all who have to do with the repression of crime are included within the general term of conservators of the peace. As commonly used nowadays in England, the term conservator is applied only to the guardian of a museum or of a river (see **THAMES**).

CONSETT, an urban district in the north-western parliamentary division of Durham, England, 20 m. S.E. of Newcastle-upon-Tyne by a branch of the North Eastern railway. Pop. (1901) 9694. It is the centre of a populous industrial district. At Shotley Bridge (where there is a small spa) a colony of German metal-workers, making swords and knives, was established in the 17th century; but this industry has now been replaced by paper mills. There are extensive collieries and ironworks in the district.

CONSHOHOCKEN, a borough of Montgomery county, Pennsylvania, U.S.A., on the Schuylkill river, 12 m. N.W. of Philadelphia. Pop. (1890) 5470; (1900) 5762 (932 being foreign-born); (1910) 7480. It is served by the Pennsylvania and the Philadelphia & Reading railways. The borough is built on land which rises gradually from the river-bank for about $\frac{1}{4}$ m. and then becomes quite level, but the surrounding country is for the most part occupied by hills, several of which rise to considerable height. It has a variety of manufacturing establishments, among which are cotton and woollen mills, rolling mills, steel mills, foundries, boiler shops, tube works, and works for making surgical instruments and artificial stone. The place was first settled about 1820, and was for several years known as Matson's Ford; in 1830 it was laid out as a town and received its present name, an

Indian word meaning "pleasant valley." It was incorporated in 1850. Immediately across the Schuylkill is West Conshohocken (pop. in 1900, 1958), where carpets and woollen goods are manufactured.

CONSIDÉRANT, VICTOR PROSPER (1808–1893), French socialist, was born at Salins (Jura) on the 12th of October 1808. Educated at the École Polytechnique in Paris, he entered the French army as an engineer, rising to the rank of captain. Becoming imbued, however, with the phalansterian ideas of François Fourier, he resigned his commission in 1831, in order to devote himself to advancing the doctrines of his master. On the death of Fourier in 1837 he became the acknowledged head of the movement, and took charge of *La Phalange*, the organ of Fourierism. He also established *phalanges* at Condé-sur-Vesgres and elsewhere, but they had little success and soon died of inanition. During this period he published his *Destinée sociale* (1834–1838), undoubtedly the most able and most important work of the Fourierist school. After the revolution of 1848 he was elected to the Constituent Assembly for the department of Loiret, and in 1849 to the Legislative Assembly for the department of the Seine. Considérant's share in the "demonstration" under the leadership of Ledru-Rollin on the 13th of June 1849 caused his compulsory flight to Belgium. Thence he went (1852) to Texas, but soon returned to Brussels, where he suffered a short imprisonment for alleged conspiracy against the peace of a neighbouring state. On his release he again set out for Texas, and founded at San Antonio the communistic colony of La Réunion. This experiment met with little more success than his former attempts, and in 1869 he returned to Paris, where he lived in retirement, needy and forgotten, till his death in 1893. The most important of Considérant's other writings were *Exposition du système de Fourier* (1845), *Principes du socialisme* (1847), *Théorie du droit de propriété et du droit au travail* (1848).

CONSIDERATION (from Lat. *considerare*, to look at closely, examine, generally taken to be from *con-*, and the base seen in *sidus, sideris*, a star, the word being supposed to be originally an astrological or astronomical term), observation, attention, regard or taking into account, hence the fact taken into account, and especially something given as an equivalent or reward or in payment; in the law of contract, an act or forbearance, or the promise thereof, offered by one party to an agreement, and accepted by the other as an inducement to that other's act or promise (Pollock on *Contract*). Consideration in the legal sense is essential to the validity of every contract unless it is made in writing under seal. The meaning of the word is quite accurately expressed by a phrase used in one of the earliest cases on the subject—it is strictly a *quid pro quo*. Something, whether it be in the nature of an act or a forbearance, must move from one of the parties in order to support a promise made by the other. A mere promise by A to give something to B cannot be enforced unless there is some consideration "moving from B." While every contract requires a consideration, it is held that the court will not inquire into the adequacy thereof, but it must be of some value in the eye of the law. It must also be legal, and it must be either present or future, not past. See further **CONTRACT**.

CONSIGNMENT (from *consign*, Fr. *consigner*, Lat. *consignare*, to affix a *signum*, seal; whence, in Late Lat., to hand over, transmit), generally, the delivery or transmission of any person or thing for safe custody, e.g. of a malefactor to prison, or of a horse to the care of a groom. In law, consignment is used of the sending or transmitting of goods to a merchant or factor for sale. The person who consigns the goods is called the consignor, and the person residing at the port of delivery or elsewhere to whom the goods are to be delivered when they arrive there is called the consignee. See further **AFFREIGHTMENT**.

CONSISTORY (Lat. *consistorium*, literally, a standing place, hence meeting place, waiting or audience chamber), a term which, like many other expressions, has undergone a regular evolution in the course of centuries. It was first applied to the audience-chamber in which the emperors received petitions and gave judgment; it soon came to mean also the persons who took part in the deliberation, and, by an extension of meaning, a tribunal

or jurisdiction (see Du Cange, *Glossarium*, s.v.). But the expression has now long been exclusively applied to gatherings of ecclesiastical persons for the purpose of administering justice or transacting business.

In the Western Church the episcopal consistory was simply the bishops' tribunal, the proceedings of which took a more or less strictly judicial form. But the name has disappeared almost everywhere; the only episcopal consistories outside England (see **CONSISTORY COURTS**) which survive are in Austria and in certain dioceses of Bavaria and Germany (see Vering, *Kirchenrecht*, § 149). Thus the name consistory has come to be applied almost exclusively to meetings of the college of cardinals with the pope as president, formerly for deliberative purposes, but nowadays purely formal. These meetings used to be frequent, but are now held very seldom, taking place only three or four times a year.

The cardinals (*q.v.*) form the pope's council and senate; before it became the custom to entrust the management of various kinds of business, grouped according to their nature, to commissions composed of cardinals, the pope used to consider and discuss with the whole sacred college matters of general interest or those which were specially referred to him, notably the questions submitted to him by bishops from all parts of Christendom. To this are due a good number of the decretals which have found a place in the *Corpus juris canonici*. In the middle ages, when the cardinals were few in number, consistories were held very often. Thus the *Gesta* of Innocent III. tell us that this great pope "held publicly, three times a week, according to the usage then established, a solemn consistory; in it he heard complaints from all men, and examined in person even affairs of the least importance with a prudence and perspicacity which were the admiration of all." Later we have recorded only one consistory a week; in the 16th century, according to Cardinal De Luca, it usually took place only twice in a month; and soon the consistories were held at still greater intervals; they were held more or less regularly during the Ember weeks, but now they have no longer a fixed date.

Whatever be their form, they are nowadays merely ceremonial, the business upon which they are supposed to meet being discussed and decided previously; consequently, they are merely a kind of solemn promulgation. The preparation of the business is entrusted to the commission of cardinals known as the Consistorial Congregation.

There are three kinds of consistory: the secret consistory, in which only the cardinals take part; the public consistory, to which are admitted persons from outside and a fairly large audience; and finally, the semi-public consistory, in which the bishops present in Rome take part with the cardinals, and are allowed to state their opinion. The last form is only used in the case of the consistory preceding a canonization. The public consistory is now only held for the ceremony of conferring the hat on newly created cardinals; formerly the popes used to receive in public consistory sovereigns and certain other great persons, but in this case the consistory was not deliberative in form.

Finally, in secret consistories were discussed matters of general interest, such as the creation of cardinals, the provision of cathedral churches and other higher benefices,—hence called consistorial,—the creation, union or division of dioceses, the conferring of the pallium (*q.v.*), and other matters of importance. In these consistories takes place the "preconization" of bishops appointed since the last consistory. The custom is for the pope to open the meeting by a discourse, or "consistorial allocution," in which he deals with the position of the Church, either in general or in some particular country; or again, he may denounce some danger which is threatening at the time either the faith or discipline, or protest against attacks upon the rights of the Church. Such, for example, were the allocutions of Pius IX. against the successive invasions of his temporal domain, or that of Pius X. against the breaking of the Concordat by the French government.

In the consistory, the cardinals are seated in a circle around the pope; on his right sits the chief cardinal bishop, after whom

are placed in order all the others; on the left of the pope stands the chief cardinal deacon; the chief cardinal priest comes next to the last cardinal bishop, and the last cardinal priest next to the last cardinal deacon. As in the old imperial consistorium, the cardinals assemble in the hall of the consistory, and there await the pope, who takes his place upon his throne; in former days he used first to give audience to those cardinals who had to submit certain matters to him, after which the doors were shut and the consistory became secret.

AUTHORITIES.—Bouix, *De Curia romana*, pt. ii. c. 1 (Paris, 1859); Plattenberg, *Notitia congregationum*, cap. 3 (Hildesheim, 1693); Cardinal de Luca, *Theatrum veritatis*, lib. xv. p. 2 (Rome, 1671). (A. Bo.)*

CONSISTORY COURTS, those ecclesiastical courts wherein the ordinary jurisdiction of the bishop is exercised (see **CONSISTORY**). They exist in every diocese of England. Consistory courts were established by a charter of William I., which appointed the cognizance of ecclesiastical causes in a distinct place or court from the temporal. The officer who exercises jurisdiction in a consistory court is known as the chancellor (*q.v.*), and he is appointed by patent from the bishop or archbishop. All jurisdiction, both contentious and voluntary, is committed to him under two separate offices, those of official principal and vicar-general; the distinction between the two offices is that the official principal usually exercises contentious jurisdiction and the vicar-general voluntary jurisdiction. (In the province of York there is an official principal of the chancery court and a vicar-general of the diocese.) Since about the middle of the 19th century consistory courts have been shorn of much of their importance. Before the year 1858 consistory courts exercised concurrently with the courts of their respective provinces jurisdiction over matrimonial and testamentary matters. This jurisdiction was taken away by the Court of Probate Act 1857 and the Matrimonial Causes Act 1857. They had also corrective jurisdiction over criminous clerks, but this was abrogated by the Church Discipline Act 1840. The principal business of consistory courts is now the dispensing of faculties. The procedure in such is strictly forensic, for all applications for faculties, though they may be unopposed, are commenced by citation, calling on all who may have an interest to oppose. From the consistory courts an appeal lies to the provincial courts, *i.e.* the arches court of Canterbury and the chancery court of York. Also, by the Clergy Discipline Act 1892, a clergyman may be prosecuted and tried in a consistory court for immoral acts or conduct. Under this act, either party may appeal either to the provincial court or to the king in council against any judgment of a consistory court.

CONSOLATION (Fr. *consolation*, Lat. *consolatio*, from *consolari*, to assuage, comfort, console), in general, the soothing of disappointment or grief. The word is applied equally to the action of consoling, to the state of being consoled, and to the instruments by which comfort is brought. Thus we speak of a person making attempts at consolation, of receiving consolation, and *e.g.* of the consolations of religion. In the sense of compensation for loss, the word "consolation" has had a variety of adaptations. Of its use in ecclesiastical Latin, in this sense, Du Cange gives various instances. Thus the synod of Angers (453) decreed that those clerics "qui sunt caelibes, nonnisi a sororibus aut amatis aut matribus consolentur"; *consolatio* was also the name given, *e.g.*, to the evening meal given to monks after the regular collation "by way of consolation" and to certain payments made to members of chapters over and above the revenues of their benefices. In an analogous sense we use the word in such combinations as "consolation prize," "consolation race," "consolation stakes," meaning such as are open only to competitors who have not won in any preceding "event." *Consolation* is also the name of a French gambling game, so called because it is usually played on and about race-courses after the races have been run and the players have presumably lost. The necessary implements are a board divided into sections numbered from 1 to 6, upon which the players place their stakes, and a die which is shaken in a box and thrown on

the board. The banker, usually a professional gambler, pays five times the money on the winning number and pockets the rest. His chances of winning are overwhelming, as the die is never thrown until a stake has been placed upon all six compartments.

CONSOLE (a French form, supposed to be an abbreviation of *consolidé*, from Lat. *consolidare*, to strengthen), the architectural term given to a corbel (*q.v.*) placed on end, *i.e.* in which the height is greater than the projection. The console brackets which carry the cornice of a Roman doorway, and are described by Vitruvius as *ancones* (see **ANCON**), are among the best examples. The word is, however, more familiar in its connexion with furniture. The console-table was originally so called because the slab was supported upon a scroll-shaped bracket, or upon legs which in form and contour answered roughly to the idea of a bracket. A console-table has a front and two sides; the back, which remains unornamented, always stands against the wall. Since this piece of furniture was first introduced in the 17th century it has undergone many mutations of form. It has been flat and oblong, oval and bombé; but, save during the Empire period, it has rarely been severe. The console-table—the slab of which is often of marble—lends itself with peculiar adaptability to ornament, and, especially during the first half of the 18th century which was its most distinguished and, artistically, its most satisfactory period, it was often of extreme grace and elegance. France was always its natural home, and the Mobilier National and the great French palaces still contain many extremely ornate examples, in which fruits and flowers, wreaths and scrolls, gildings and inlayings produce gorgeous yet homogeneous effects. Until the reign of Louis XVI. console-tables were almost invariably gilded, but they then began to be painted usually in *gris-perle*, and by degrees they came to be manufactured in rose-wood and mahogany. Although much used in England the console has never been thoroughly acclimatized there; that it has always retained a foreign flavour is indicated by the fact that, unlike most other pieces of furniture, it has failed to commend itself to any but the richer classes.

CONSOLIDATION ACTS. To "consolidate" (Lat. *consolidare*, from *con-*, together, and *solidus*, firm) is to press compactly together, put on a firm basis, and especially bring together into one strong whole. The practice of legislating for small portions of a subject only at a time, which is characteristic of the English parliament, produces as a necessary consequence great confusion in the statute law. The acts relating to any subject of importance or difficulty will be found to be scattered over many years, and through the operation of clauses partially repealing or amending former acts, the final sense of the legislature becomes enveloped in unintelligible or contradictory expressions. Where opportunity offers, the law thus expressed in many statutes is sometimes recast in a single statute, called a Consolidation Act. Among such are acts dealing with the customs, stamps and stamp duties, public health, weights and measures, sheriffs, coroners, county courts, housing, municipal corporations, libraries, trustees, copyhold, diseases of animals, merchant shipping, friendly societies, &c. These observations apply to the public general acts of the legislature. On the other hand, in settling private acts, such as those relating to railway and canal enterprise, the legislature always inserted certain clauses founded on reasons of public policy applicable to the business in question. To avoid the necessity of constantly re-enacting the same principles in private acts, their common clauses were embodied in separate statutes, and their provisions are ordered to be incorporated in any private act of the description mentioned therein. Such are the Lands Clauses Acts, the Companies Clauses Acts and the Railways Clauses Acts.

CONSOLS, an abbreviation of *consolidated annuities*, a form of British government stock which originated in 1751. Consols now form the larger portion of the funded debt of the United Kingdom. In the progress of the national debt it was deemed expedient, on grounds which have been much questioned, instead of borrowing at various rates of interest, according to the state of the market or the need and credit of the government, to offer

a fixed rate of interest, usually 3 or 3½%, and as the market required to give the lenders an advantage in the principal funded. Thus subscribers of £100 would sometimes receive £150 of 3% stock. In 1815, at the close of the French wars, a large loan was raised at as much as £174 3% stock for £100. The low rate of interest was thus purely nominal, while the principal of the debt was increased beyond all due proportion. This practice began in the reign of George II., when some portions of the debt on which the interest had been successfully reduced were consolidated into 3% annuities, and consols, as the annuities were called, and other stocks of nominally low interest, rapidly increased under the same practice during the great wars. In times of peace, when the rate of money has enabled portions of the debt at a higher interest to be commuted into stock of lower interest, it has usually been into consols that the conversion has been effected. Temporary deficits of the revenue have been covered by an issue of consols; exchequer bills when funded have taken the same form, though not constantly or exclusively; and some government loans for special purposes, such as the relief of the Irish famine and the expenditure in the Crimean and Boer Wars have been wholly or partly raised in consols. The consequence has been to give this stock a pre-eminence in the amount of the funded debt. See further under NATIONAL DEBT: *United Kingdom*.

CONSORT (Lat. *consors*, a companion), in general, a partner or associate; but more particularly a husband or wife. The word is also used in conjunction with some titles, as "queen consort," "prince consort." Under the law of the United Kingdom, the queen consort is a subject, but has certain privileges. By the Treason Act 1351, the compassing and imagining her death is high treason, as is also the commission of adultery with her. With regard to the acquisition and disposal of property, the incurring of rights and liabilities under contract, suing and being sued, a queen consort is regarded as a *feme sole* (32 Henry VIII. c. 51, 1540; Private Property of the Sovereign Act 1800). The queen consort has her own ceremonial officers and appears in the courts by her attorney- and solicitor-general. At one time she had a revenue out of the demesne lands of the crown and a portion of any sum paid by a subject to the king in return for a grant of any office or franchise; this was termed *aurum reginae* or queen-gold. Provision is now made for the queen consort by statute. When the husband of a queen consort dies she becomes a queen dowager. A queen dowager is not under the protection of the law of treason. It is said (Blackstone, *Commentaries*) that she cannot marry without the king's licence, but this is doubtful. A queen regnant, holding the crown in her own right, has all the prerogatives of a sovereign. In the four cases of queens regnant in English history, the husbands' positions have each been different. When Queen Mary I. married Philip of Spain it was provided by every safeguard that words could suggest that the queen alone should exercise all the powers of the crown; official documents, however, were to issue in their joint names. William III. occupied the throne jointly with his wife, Mary II. The husband of Queen Anne, George of Denmark, who was naturalized by act of parliament in 1689, occupied no definite position, and differed only from other subjects of the queen in the conditions of his naturalization. The position of Prince Albert of Saxe-Coburg-Gotha, the husband of Queen Victoria, was somewhat like that of Prince George of Denmark. A few days before his marriage he had been naturalized as a British subject, and immediately after his marriage letters patent were issued, giving him precedence next to the queen. He had, however, no distinctive title, and the privileges and precedence he received were only by courtesy. As the patent which gave him precedence was inoperative outside the United Kingdom, certain difficulties occurred at foreign courts, and in order to settle these, the formal title of "Prince Consort" was conferred upon him by letters patent in 1857.

CONSPIRACY (from Lat. *conspirare*, literally to breathe together, to agree, combine, and especially to form a secret plot), in English law, an agreement between two or more persons to do certain wrongful acts, which may not, however, be punishable

when committed by a single person, not acting in concert with others. The following are enumerated in text-books as the things, an agreement to do which, made between several persons, constitutes the offence of conspiracy:—(1) Falsely to charge another with a crime punishable by law, either from a malicious or vindictive motive or feeling towards the party, or for the purpose of extorting money from him; (2) wrongfully to injure or prejudice a third person or any body of men in any other manner; (3) to commit any offence punishable by law; (4) to do any act with intent to pervert the course of justice; (5) to effect a legal purpose with a corrupt intent or by improper means; to which are added (6) conspiracies or combinations among workmen to raise wages.

The division is not a perfect one, but a few examples under each of the heads will indicate the nature of the offence in English law. First, a conspiracy to charge a man falsely with any felony or misdemeanour is criminal; but an agreement to prosecute a man who is guilty, or against whom there are reasonable grounds for suspicion, is not. Under the second head the text-books give a great variety of examples,—e.g. mock auctions, where sham bidders cause the goods to go off at prices grossly above their worth; a conspiracy to raise the price of goods by spreading false rumours; a conspiracy by persons to cause themselves to be reputed men of property, in order to deceive tradesmen. These examples show how wide the law stretches its conception of criminal agreement. The third head requires no explanation. A conspiracy to murder is expressly made punishable by penal servitude and imprisonment (The Offences against the Person Act 1861). A curious example of conspiracy under the fourth head is the case in which several persons were convicted of conspiracy to procure another to rob one of them, so that by convicting the robber they might obtain the reward given in such cases. The combination to effect a lawful purpose with corrupt intent or by improper means is exemplified by agreements to procure seduction, &c.

The most important question in the law of conspiracy, apart from the statute law affecting labourers, is how far things which may be lawfully done by individuals can become criminal when done by individuals acting in concert, and some light may be thrown on it by a short statement of the history of the law. In the early period of the law down to the 17th century, conspiracy was defined by the Ordinance of Conspirators of 1305:—"Conspirators be they that do confedr or bind themselves by oath, covenant, or other alliance, that every of them shall aid the other falsely and maliciously to indite, or cause to indite, or falsely to move or maintain pleas, and also such as cause children within age to appeal men of felony, whereby they are imprisoned and sore grieved, and such as retain men in the country with liveries or fees to maintain their malicious enterprizes, and this extendeth as well to the takers as to the givers." The offence aimed at here is conspiracy to indict or to maintain suits falsely; and it was held that a conspiracy under the act was not complete, unless some suit had been maintained or some person had been falsely indicted and acquitted. A doctrine, however, grew up that the agreement was in itself criminal, although the conspiracy was not actually completed (Poulterer's case, 1611). This developed into the rule that any agreement to commit a crime might be prosecuted as a conspiracy. A still further development of this doctrine is that a combination might be criminal, although the object apart from combination would not be criminal. The cases bearing on this question will be found arranged under the following heads, and in chronological order, in the *Law of Criminal Conspiracies and Agreements*, by R. S. Wright (London, 1873):—Combinations against government; combinations to defeat or pervert justice; combinations against public morals or decency; combination to defraud; combination to injure otherwise than by fraud; trade combinations. "It is conceived," says the author, "that on a review of all the decisions, there is a great preponderance of authority in favour of the proposition that, as a rule, an agreement or combination is not criminal unless it be for acts or omissions (whether as ends or means) which would be criminal apart from agreement." A dictum of

Lord Denman's is often quoted as supplying a definition of conspiracy. It is, he says, either a combination to procure an unlawful object, or to procure a lawful object by unlawful means; but the exact meaning to be given to the word "lawful" in this antithesis has nowhere been precisely stated. A thing may be unlawful in the sense that the law will not aid it, although it may not expressly punish it. The extreme limit of the doctrine is reached in the suggestion that a combination to hiss an actor at a theatre is a punishable conspiracy.

The application of the wide conception of conspiracy to trade disputes and to civil questions arising out of contracts for service is dealt with under the headings LABOUR LEGISLATION, STRIKES AND LOCK-OUTS and TRADE UNIONS. The criminal side is regulated by the Conspiracy and Protection to Property Act 1875, which enacted that "an agreement or combination by two or more persons to do, or procure to be done, any act in contemplation or furtherance of a trade dispute between employers and workmen shall not be indictable as a conspiracy, if such act committed by one person would not be punishable as a crime. When a person is convicted of any such agreement or combination to do an act which is punishable only on summary conviction, and is sentenced to imprisonment, the imprisonment shall not exceed three months, or such longer period, if any, as may have been prescribed by the statute for the punishment of the said act when committed by one person." The effect of the act of 1875 in conjunction with the Employers and Workmen Act of the same year is that breach of contract between master and workmen is to be dealt with as a civil and not as a criminal case, with two exceptions. A person employed on the supply of gas and water, breaking his contract with his employer, and knowing, or having reasonable cause to believe, that the consequence of his doing so, either alone or in combination with others, will be to deprive the inhabitants of the place wholly or to a great extent of their supply of gas or water, shall be liable on conviction to a penalty not exceeding £20, or a term of imprisonment not exceeding three months. And generally any person wilfully and maliciously breaking a contract of service or hiring, knowing or having reasonable cause to believe that the probable consequences of his so doing either alone or in combination with others will be to endanger human life or cause serious bodily injury, or to expose valuable property whether real or personal to destruction or serious injury, shall be liable to the same penalty. By section 7 every person who, with a view to compel any other person to abstain from doing or to do any act which such other person has a legal right to do or abstain from doing, wrongfully and without legal authority, (1) uses violence to or intimidates such other person, or his wife and children, or injures his property; or (2) persistently follows such other person about from place to place; or (3) hides any tools, clothes or other property owned or used by such other person, or deprives him of or hinders him in the use thereof; or (4) watches or besets the house or other place where such other person resides, or works, or carries on business, or happens to be, or the approach to such house or place; or (5) follows such other person with two or more other persons, in a disorderly manner, in or through any street or road, shall be liable to the before-mentioned penalties. Of course a combination to do any of these acts would be punishable as a conspiracy, as mentioned in section 3 above.

Seamen are expressly exempted from the operation of this act. The exceptions as to contracts of service for the supply of gas and water, &c., were supported by the circumstances of the London gas stokers' case in 1872.

Conspiracy at common law is a misdemeanour, and the punishment is fine or imprisonment, or both, to which may be added hard labour in the case of any conspiracy to cheat and defraud, or to extort money or goods, or falsely to accuse of any crime, and to obstruct, pervert, prevent or defeat the cause of justice. Conspiracy to murder, whether the victim be a subject of the king or resident in his dominions or not, is, by the Offences against the Person Act 1861, punishable by penal servitude.

United States.—The most generally accepted definition of conspiracy in the United States is "a combination of two or

more persons by some concerted action to accomplish some criminal or unlawful purpose, or to accomplish some purpose not in itself criminal or unlawful by criminal or unlawful means"; though in some states, e.g. Colorado, it is not conspiracy under the statute to do a lawful act in an unlawful way (*Lipschitz v. People* [1898] 25 Col. 261). In some states an overt act must be shown (N.Y. Pen. Code, § 171). This is so in the Federal Courts, *United States v. McCord* (72 Fed. R. 159). Conspiracy out of the state to do any act which if done within the state would be treason is punishable by imprisonment not exceeding ten years (*ibid.* § 169). The United States Revised Statutes, § 5440, make any conspiracy to commit an act, declared by any law of the United States to be a crime, an offence against the United States, e.g. a conspiracy to plunder a wrecked vessel within the admiralty and maritime jurisdiction of the United States (*U.S. v. Sanche*, 7 Fed. R. 715), conspiracy to violate the postal laws (*Re Renkle* [1903] 125 Fed. R. 996), to violate the revenue laws (*U.S. v. Cohn* [1904] 128 Fed. R. 615). It is not essential that the object be accomplished (*Radford v. U.S.* [1904] 129 Fed. R. 49). A conspiracy to depress the market price of stock by circulating false reports that the company was going into the hands of a receiver is indictable under N.Y. Pen. Code, § 168 (*People v. Goslin* [1901] 67 N.Y. App. D. 16, affirmed 171 N.Y. 627).

CONSTABLE, ARCHIBALD (1774–1827), Scottish publisher, was born on the 24th of February 1774 at Carnbee, Fife. His father was land steward to the earl of Kellie. In 1788 Archibald was apprenticed to Peter Hill, bookseller, of Edinburgh, but in 1795 he started in business for himself as a dealer in rare and curious books. He bought the *Scots Magazine* in 1801, and John Leyden, the orientalist, became its editor. In 1800 Constable began the *Farmer's Magazine*, and in November 1802 he issued the first number of the *Edinburgh Review*, under the nominal editorship of Sydney Smith; Lord Jeffrey, was, however, the guiding spirit of the review, having as his associates Lord Brougham, Sir Walter Scott, Henry Hallam, John Playfair and afterwards Macaulay. Constable made a new departure in publishing by the generosity of his terms to authors. The writers for the *Edinburgh Review* were paid at an unprecedented rate, and Constable offered Scott 1000 guineas in advance for *Marmion*. In 1804 A. G. Hunter joined Constable as partner, bringing considerable capital into the firm, styled from that time Archibald Constable & Co. In 1805, jointly with Longman & Co., Constable published Scott's *Lay of the Last Minstrel*, and in 1807 *Marmion*. In 1808 a split took place between Constable and Sir Walter Scott, who transferred his business to the publishing firm of John Ballantyne & Co., for which he supplied the greater part of the capital. In 1813, however, a reconciliation took place. The publishing firm of Ballantyne was in difficulties, and Constable again became Scott's publisher, a condition being that the firm of John Ballantyne & Co. should be wound up at an early date, though Scott retained his interest in the printing business of James Ballantyne & Co. In 1812 Constable, who had admitted Robert Cathcart and Robert Cadell as partners on the retirement of A. G. Hunter, purchased the copyright of the *Encyclopaedia Britannica*, adding the supplement (6 vols., 1816–1824) to the 4th, 5th and 6th editions (see ENCYCLOPAEDIA). In 1814 he bought the copyright of *Waverley*. This was issued anonymously; but in a short time 12,000 copies were disposed of, Scott's other novels following in quick succession. The firm also published the *Annual Register*. Through over-speculation, complications in Constable's business arose, and in 1826 a crash came. Constable's London agents stopped payment, and he failed for over £250,000, while James Ballantyne & Co. also went bankrupt for nearly £90,000. Sir Walter Scott was involved in the failure of both firms. Constable started business afresh, and began in 1827 *Constable's Miscellany of original and selected works* . . . consisting of a series of original works, and of standard books republished in a cheap form, thus making one of the earliest and most famous attempts to popularize wholesome literature. He died on the 21st of July 1827. After Constable's bankruptcy, Robert Cadell (1788–1849), who

had been his partner, in conjunction with Sir Walter Scott, bought from the various publishers in whose hands they were, all Scott's novels which had been issued up to that time, and began the issue of the forty-eight volume edition (1829-1833). The result of its publication was that the debt on Abbotsford was redeemed, and that Cadell bought the estate of Ratho near Edinburgh, which he owned till his death on the 21st of January 1849.

Archibald Constable's son, Thomas (1812-1881), was appointed in 1839 printer and publisher in Edinburgh to Queen Victoria, and issued, among other notable series, *Constable's Educational Series*, and *Constable's Foreign Miscellany*. In 1865 his son Archibald became a partner, and when he retired in 1893 the firm continued under the name of T. & A. Constable.

See also *Archibald Constable and his Literary Correspondents*, by his son Thomas Constable (3 vols., 1873). This book contains numerous contemporary notices of Archibald Constable, and vindicates him from the exaggeration of J. G. Lockhart and others.

CONSTABLE, HENRY (1562-1613), English poet, was born in 1562. His father, Sir Robert Constable, was knighted by the earl of Essex in Scotland in 1570, and was the author of a work *On the Ordering of a Camp*. The poet went to St John's College, Cambridge, where he took his degree of B.A. in 1580. He was (or now became) a Roman Catholic, and we hear of him next in Paris, whence in 1584 and 1585 he wrote to Walsingham letters which still exist, and which prove Constable to have been in the secret service of the English government. A later correspondence with Essex contains protestations of his loyalty. He was probably still abroad, when, in the autumn of 1592, a London publisher issued *Diana, the praises of his Mistress in certain sweet sonnets*, by H. C., containing 23 poems. A reissue of this pamphlet in 1594 (misprinted 1584) was greatly enlarged, not merely by more sonnets which may or may not be Constable's, but by eight poems which were certainly the work of Sir Philip Sidney. Published a few weeks after the *Delia* of Daniel, the original *Diana* of 1592 claims a very early place in the evolution of the Elizabethan sonnet. In 1598 Constable was sent on a mission from the Pope to Scotland, the idea being that James VI. was to be supported in his claim to the English succession on condition of his setting English Romanists free from the existing disabilities. Constable's mission came to nothing, and he entered the service of the king of France. Later he asked for permission to return to England, but it was refused. In consequence of a surreptitious excursion to London, he was captured and imprisoned in the Tower in 1604. After a manhood spent in almost continuous exile, Henry Constable died at Liège on the 9th of October 1613. The *Diana* was the only work printed in the poet's life-time; it was augmented from MS. sources by H. J. Todd, in 1813. His *Spiritual Sonnets* first appeared in 1815, edited by Thomas Park. Almost the only known pieces by Constable which are not sonnets are the song of "Diaphenia," and the beautiful pastoral canzone on "Venus and Adonis," contained in the *England's Helicon* of 1600. In 1594 he prefixed four sonnets, addressed to the soul of Sir Philip Sidney, to that writer's *Apology of Poetry*. A prose work of devotion, *The Catholic Moderator* (1623), has been attributed to Constable. Who *Diana* was has never been determined, but it has been conjectured that she may have been Mary, countess of Shrewsbury, who was a distant cousin of the poet. The body of Constable's writing is so small, and its authenticity so little supported by evidence, that it is rash to give a very definite opinion as to its character. But it is evident, from his undoubted productions, that he was much under the influence of the French poets of his time, particularly of Desportes, as well as of Petrarch and Sidney. That Shakespeare was acquainted with Constable's poetry and admired it seems to be certain, and that he borrowed from it, "gives it," as Mr Sidney Lee has said, "its most lasting interest." In the arrangement of his rhymes, Constable usually keeps closer to the Petrarchan model than Daniel and the other contemporary sonneteers are accustomed to do. (E. G.)

CONSTABLE, JOHN (1776-1837), English landscape painter, was born at East Bergholt in Suffolk on the 11th of June 1776.

His father was a man of some property, including water-mills at Dedham and Flatford, and two windmills, in which John, the second son, was set to work at the age of seventeen, after leaving Dedham grammar school. From boyhood he was devoted to painting, which he studied in his spare time in company with John Dunthorne, a local plumber and glazier. While working thus he made the acquaintance of Sir George Beaumont, a mediocre painter but a keen patron of the arts, and was inspired by the sight of Claude's "Hagar and Ishmael" and by some drawings of Girtin which Sir George possessed. His passion for art increasing, he was allowed by his father to visit London in 1795 to consult the landscape-painter Joseph Farington, R. A. (1747-1821), who recognized his originality and gave him some technical hints. He also made the acquaintance of the engraver J. T. Smith, who taught him etching, and corresponded with him during the next few years, which were spent partly in London and partly in Suffolk. In 1797 he was recalled to work in his father's counting-house at Bergholt, and it was not till February 1799 that he definitely adopted the profession of painting, and became a student at the Royal Academy. The few existing works of this period are heavy, clumsy and amateurish. Recognizing their faults, Constable worked hard at copying old masters "to acquire execution." The remedy was effective, for his sketches on a tour in Derbyshire in 1801 show considerable freshness and accomplishment. In 1802 he exhibited at the Royal Academy, and was much helped and encouraged by the president, Benjamin West, who did him a further service by preventing him from accepting a drawing-mastership (offered by Archdeacon Fisher, of Salisbury), and thereby greatly stimulating his efforts. The manner of West appears strongly in the altarpiece painted by Constable for Brantham church in 1804, but Gainsborough, the Dutch masters and Girtin are the predominant influences upon his landscape, especially Girtin in the year 1805, and in 1806, when he visited the Lake District. From 1806 to 1809 Constable was frequently engaged in painting portraits or in copying portraits by Reynolds and Hoppner. The effect on his landscape was great. He learned how to construct an oil painting, and the efforts of the next few years were devoted to combining this knowledge with his innate love of the fresh colour of nature.

With the year 1811 began a critical period. He exhibited a large view of Dedham Vale, in which the characteristic features of his art appear for the first time almost fully developed, and he became attached to Miss Maria Bicknell. His suit was opposed by the lady's relatives, and Constable's apparently hopeless prospects drove him again to portrait-painting, in which he acquired considerable skill. It was not till the death of his father in 1816 that he was able to marry and settle in No. 1 Keppel Street, Russell Square, where a succession of works now well known were painted: "Flatford Mill" (1817), "A Cottage in a Cornfield," and in 1819 "The White Horse," which was bought by his great friend Archdeacon Fisher for £105, as was the "Stratford Mill" of 1820. In 1819 two legacies each of £4000 diminished his domestic anxieties, and his talent was recognized by his election in November to the associateship of the Royal Academy. The series of important works was continued by "The Haywain" (1821), "A View on the Stour" (1822), "Salisbury Cathedral from the Bishop's Garden" (1823), and "The Lock" (1824). This last year was a memorable one. "The Haywain" was sold to a Frenchman, was exhibited at the Louvre, and, after creating a profound sensation among French artists, was awarded a gold medal. In the following year "The White Horse" won a similar distinction at Lille. In 1825 he exhibited "The Leaping Horse" (perhaps his masterpiece), in 1826 "The Cornfield," in 1827 "The Marine Parade and Chain Pier, Brighton," and in 1828 "Dedham Vale."

In 1822 Constable had taken Farington's house, 35 Charlotte Street, Fitzroy Square, but his wife's failing health made him turn his attention to Hampstead, and after temporary occupation first of 2 Lower Terrace and then of a house on Downshire Hill, he took No. 6 Well Walk, in 1827, letting the greater part of his London house. In 1828 his financial position was made

secure by a legacy of £20,000 from Mr Bicknell, but the death of his wife towards the end of the year was a shock from which he never wholly recovered. His election to membership of the Academy in the following year did not lessen his distress: he felt that the honour had been delayed too long. His chief exhibit in 1829 was "Hadleigh Castle," and this was succeeded by the great "Salisbury Cathedral from the Meadows" (1831), "The Opening of Waterloo Bridge" (1832), which had been begun in 1817, "Englefield House" (1833), "The Valley Farm" (1835), "The Cenotaph" (1836), and "Arundel Mill and Castle" (1837). Constable had long suffered from rheumatism and nervous depression, but his sudden death on the 31st of March 1837 could be traced to no definite disease. He was buried in Hampstead churchyard, where his tomb may still be seen.

In May 1838 his remaining works were sold at auction, but fetched very small prices. Many were bought in by his children, and through their generosity have passed to the English nation, as the national collections at Trafalgar Square, Millbank and South Kensington testify. Nowhere else can Constable's art be studied completely or safely, since forgeries and imitations are common and have crept into the Louvre and other famous galleries. Much of the power of his work survives in the noble series of mezzotints made after his sketches by David Lucas, and first issued in 1833. Though a commercial failure at the time of publication, this *English Landscape* series is now deservedly prized, as are the other plates which Lucas engraved after Constable. Constable himself made a few desultory experiments in etching, but they are of no importance.

As already indicated, the mature art of Constable did not develop till after the year 1811, when he began to combine the fresh colour of nature, which he had learned to depict by working in the open air, with the art of making a picture, which he had learned from painting portraits and copying those of other masters. His development was unusually slow, and his finest work, with but few exceptions, was done between his fortieth and fiftieth years (1816-1826). During the last twelve years of his life his manner became more free, and the palette knife was constantly used to apply spots and splashes of pure colour, so that his technique often suggests that afterwards employed by the Impressionists. Yet his direct influence upon French landscape has sometimes been overrated. When Constable first exhibited at the Salon in 1825 Théodore Rousseau, the pioneer of French naturalism, was only twelve years old, and the movement of 1830 was really originated in France by Gros and Géricault, while in England the water-colour painters led the way. Constable's death in 1837 removed the man and most of his work from the public eye for another generation, and he became a famous shadow rather than a living force. So Monet and the Impressionists, when they sought after the secret of painting air and sunshine, looked to Turner rather than to Constable, and in England the eloquence of Ruskin pointed in the same direction.

Since the British nation came into the possession of a large portion of Constable's pictures and sketches, his work has been better understood. Though limited in range of subject to the scenery of Suffolk, Hampstead, Salisbury and Brighton, his sketches express the tone, colour, movement and atmosphere of the scenes represented with unrivalled force and truthfulness, and modern criticism tends to rate their spontaneity above the deliberate accomplishment of his large finished works. His treatment of skies is specially notable. Here his early experience as a miller told in his favour. No one has painted English cloud effects so truthfully, or used them as a compositional quantity with so much skill. Though in looking at nature he was determined to see with his own eyes and not with those of any former master, he found that the science of his predecessors was necessary to him before his sketches could be translated into large pictures. In these pictures his vivid tones and fresh colour are grafted upon the formulae of Claude and Rubens, and it is a common error to regard Constable as an opponent of the great old masters. His pictures, like his writings and lectures, prove just the reverse. His dislike was reserved for the painters

who took their ideas from other painters instead of getting them directly from nature.

AUTHORITIES.—Among older books see C. R. Leslie, *Memoirs of the Life of John Constable*, R. A. (London, 2nd ed. 1845, 3rd ed. 1896) (the classical work on the subject); and *English Landscape Scenery, a Series of Forty Mezzotint Engravings on Steel*, by David Lucas, from pictures painted by John Constable, R. A. (London, folio, 1855). The large work on Constable and his influence on Landscape Painting, by C. J. Holmes (1902), contains the only chronological catalogue of Constable's paintings and sketches. Leslie's biography has been admirably rendered into French by M. Léon Bazalgette (Paris, H. Floury, 1905). (C. J. H.)

CONSTABLE, SIR MARMADUKE (c. 1455-1518), English soldier, was descended from a certain Robert (d. 1216), lord of Flamborough, who was related to the Lacys, hereditary constables of Chester, hence the surname of the family. A son of Sir Robert Constable (d. 1488), Marmaduke was in France with Edward IV. in 1475 and with Henry VII. in 1492. He was sheriff of Staffordshire and Yorkshire, was in high favour with Henry VII. and Henry VIII., and led his kinsmen and retainers to the battle of Flodden in 1513. He was twice married, and left several sons when he died on the 20th of November 1518. In Flamborough church one may still read a rhyming epitaph describing Constable's life and prowess.

Sir Marmaduke's eldest son, Sir Robert Constable (c. 1478-1537), helped Henry VII. to defeat the Cornish rebels at Blackheath in 1497. In 1536, when the rising known as the Pilgrimage of Grace broke out in the north of England, Constable was one of the insurgent leaders, but towards the close of the year he submitted at Doncaster and was pardoned. He did not share in the renewal of the rising which took place in January 1537; but he refused the king's invitation to proceed to London, and was arrested. Tried for treason, he was hanged at Hull in the following June.

Sir Marmaduke's second son, Sir Marmaduke Constable (c. 1480-1545), was knighted after the battle of Flodden, and was at the Field of the Cloth of Gold in 1520. He was a knight of the shire for Yorkshire and then for Warwickshire, and was a member of the Council of the North from 1537 until his death.

Another noteworthy member of this family was the regicide, Sir William Constable (d. 1655), who was created a baronet in 1611. A member of the Long Parliament, he fought with distinction among the parliamentarians at Edgehill; in 1644 his military enterprises in north Yorkshire were very successful, and later he guarded the king at Carisbrooke, and was governor of Gloucester. He was one of the king's judges, was a member of the council of state under Cromwell, and died in London on the 15th of June 1655.

CONSTABLE (O. Fr. *conestable*, Fr. *connétable*, Med. Lat. *comestabilis*, *conestabilis*, *constabularius*, from the Lat. *comes stabuli*, count of the stable), a title now confined to the lord high constable of England, the lord constable of Scotland, the constables of some royal castles in England, and to certain executive legal officials of inferior rank in Great Britain and the United States.

The history of the constable is closely analogous to that of the marshal (*q.v.*); for just as the modern marshals, whatever their rank or office, are traceable both as to their title and functions to the *marescalcus*, or master of the horse, of the Frankish kings, so the constable, whether he be a high dignitary of the royal court or a "petty constable" in a village, is derived by a logical evolution from the counts of the stable of the East Roman Emperors.

The Byzantine *comes stabuli* (κόμης τοῦ σταβλοῦ) was in his origin simply the imperial master of the horse, the head of the imperial stables, and a great officer of state. From the East the title was borrowed by the Frankish kings, and during the Carolingian epoch a *comes stabuli* was at the head of the royal stud, the marshals (*marescalci*) being under his orders. The office survived and expanded in France under the Capetian dynasty; in the 11th century the constable has not only the general superintendence of the royal stud, but an important command in the army—though still under the orders of the seneschal,—and certain limited powers of jurisdiction. From

this time onward the office of constable tended, in France, continually to increase in importance. On the abolition of the seneschalship by King Philip Augustus in 1191, the constable succeeded to many of his powers and privileges. Thus in the 13th century he claimed as of right the privilege of leading the vanguard of the army. Under Philip the Fair (1268-1314) he begins to be invested with the military government of certain provinces as lieutenant of the king (*locum tenens regis*); and, finally, in the 14th century, owing to the confusion of his high prerogatives as the royal lieutenant with his functions as constable, he is, as constable, recognized as commander-in-chief of the army. The French kings never allowed the office of constable to become hereditary, and in January 1627, after the death of François de Bonne, duc de Lesdiguières, the office was suppressed by royal edict. Napoleon created the office of grand constable for his brother Louis, and that of vice-constable for Marshal Berthier, but these were suppressed at the Restoration.

The jurisdiction of the constable, known as the *connétable et maréchaussée de France*, was held in fee until the abolition of the office of constable, when it became a royal court, without, however, changing its name. Henceforth it was nominally under the senior marshal of France, and all marshals had the right of sitting as judges; but actually it was presided over by the *lieutenant général* with the *lieutenant particulier* and the *procureur du roi* as assessors. At first peripatetic, its seat was ultimately fixed at Paris, as part of the organization of the parlement. Its jurisdiction, which included all military persons and causes, was somewhat vaguely extended to embrace all crimes of violence, &c., committed outside the jurisdiction of the towns; it thus came often into conflict with that of the other royal courts.

The office of constable was not confined on the continent to France. The Gothic kings of Spain had their *comites stabuli*; so did, later on, the kings of Naples, where the functions of this officer were much the same as in France. The great vassals of the French crown, moreover, arranging their households on the model of that of the king, had their constables, whose office tended for the most part to become hereditary. Thus the constablership of the county of Toulouse was hereditary in the family of Sabran, that of Normandy in the house of Crespin.

In England the title of constable was unknown before the Conquest, though the functions of the office were practically those of the English *staller*. In the laws of Edward the Confessor the title constable is mentioned as the French equivalent for the English *heretoga*, or military commander (*ductor exercitus*). But among the great officers of the Norman-English court the constable duly makes his appearance as "quartermaster-general of the court and of the army." In England, however, where the office soon became hereditary, the constable never attained the same commanding position as in France, though the military duties attached to his office prevented its sinking into a mere grand serjeanty. He was not the superior of the marshal, the functions of the two offices being in fact hardly distinguishable. From the first, moreover, the title of constable was not confined to the constable proper, whose office in the reign of Stephen was made hereditary under the style of high constable (see LORD HIGH CONSTABLE); for every command held under the supreme *constabularia* was designated by this name, and there were constables of troops, of castles, of garrisons and even of ships (*constabularia navigii regis*). Under the Norman and Angevin kings, then, the title had come to be loosely applied to any high military command. Its extension to officials exercising civil jurisdiction is not difficult to account for. In feudal society, based as this was on a military organization, it is easy to see how the military jurisdiction of the constables would tend to encroach on that of the civil magistrates. The origin of the modern chief and petty constables, however, is to be traced to the Statute of Winchester of 1285, by which the national militia was organized by a blending of the military system with the constitution of the shires. Under this act a chief or high constable was appointed in every hundred; while in the old tithings and *villatae* the *village* bailiff was generally appointed a petty constable, receiving in addition to his old magisterial functions a new military office.

From the time of Edward III. the old title of reeve or tithing-man is lost in that of constable, which represents his character as an officer of the peace as well as of the militia. The high and petty constables continued to be the executive legal officers in the counties until the County-Police Acts of 1839 and 1840 reorganized the county police. In 1842 an important statute was passed enacting that for the future no appointment of a petty constable, headborough, borsholder, tithing-man, or peace officer of the like description should be made for any parish at any court leet, except for purposes unconnected with the preservation of the peace, and providing, as a means of increasing the security of persons and property, for the appointment by justices of the peace in divisional petty sessions of fit persons or their substitutes to act as constables in the several parishes of England, and giving vestries an optional power of providing paid constables. Under the acts of 1839 and 1840 the establishment of a paid county police force was optional with the justices. With the Police Act of 1856 this optional power became compulsory, and thenceforth the history of the petty constable in England is that of the police. In 1869 provision was made for the abolition of the old office of high constable (the High Constables Act 1869) and, as the establishment of an efficient police force rendered the general appointment of parish constables unnecessary, the appointment ceased, subject to the appointment by vestries of paid constables under the chief constable of the county (Parish Constables Act 1872). See further POLICE.

"Special constables" are peace officers appointed to act on occasional emergencies when the ordinary police force is thought to be deficient. The appointment of special constables is for the most part regulated by an act of 1831. In the absence of volunteers the office is compulsory, on the appointment of two justices. The lord-lieutenant may also appoint special constables and the statutory exemptions may be disregarded, but voters cannot be made to serve during a parliamentary election. While in office special constables have all the powers of a common law constable, and in London those of a metropolitan police officer.

In the United States, outside the larger towns, the petty constable retains much the same status as in England before the act of 1842. He still has a limited judicial power as conservator of the peace, and often exercises various additional functions, such as that of tax-collector or overseer of the roads or other duties, as may be decided for him by the community which appoints him. In the old colonial days the office, borrowed from England, was of much importance. The office of high constable existed also in Philadelphia and New York, in the latter town until 1830, and in some towns the title has been retained for the chief of the police force.

See Du Cange, *Glossarium* (ed. Niort, 1883), s. "Comes Stabuli"; R. Gneist, *Hist. of the Eng. Constitution* (trs. London, 1891); W. L. Melville Lee, *Hist. of Police in England* (London, 1901); *Encycl. of the Laws of England*, s. "Constable" (London, 1907); W. Stubbs, *Constitutional Hist. of England* (Oxford, 1875-1878); A. Luchaire, *Manuel des institutions françaises* (Paris, 1892). (W. A. P.)

CONSTANCE (Ger. *Konstanz* or *Costnitz*), a town in the grand-duchy of Baden. It is built, at a height of 1303 ft. above the sea, on the S. or left bank of the Rhine, just as it issues from the Lake of Constance to form the Untersee. The town communicates by steamer with all the places situated on the shores of the Lake of Constance, while by rail it is 30 or 31 m. by one or other bank of the Rhine from Schaffhausen (on the W.) and 22½ m. along the S.W. shore of the lake from Rorschach (S.E.). In 1905 it numbered 24,818 inhabitants, mostly German-speaking and Romanists. A fine bridge leads north over the Rhine to one suburb, Petershausen, while to the south the town gradually merges into the Swiss suburb of Kreuzlingen. It is a picturesque little town, with several noteworthy medieval buildings. The former cathedral church was mainly built 1069-1089, but was later gothicized; near the west end of the nave a plate in the floor marks the spot where Huss stood when condemned to death, while in the midst of the choir is the brass which covered the grave of Robert Hallam, bishop of Salisbury, who died here in 1417, during the council. The old Dominican

convent, on an island east of the town, is now turned into a hotel, but the buildings (especially the cloisters) are well preserved. The 14th century *Kaufhaus* (warehouse for goods) was the scene of the conclave that elected Martin V., but the council really sat in the cathedral church. The town-hall dates from 1592, and has many points of interest. In the market-place, side by side, are two houses wherein two important historical events are said to have taken place—in the "Gasthaus zum Barbarossa" Frederick Barbarossa signed the peace of Constance (1183), while in the house named "zum Hohen Hafen" the emperor Sigismund invested Frederick of Hohenzollern with the mark of Brandenburg (1417). On the outskirts of the town, to the west, in the Brühl suburb, a stone marks the spot where Hus and Jerome of Prague were burnt to death. The Rosgarten museum contains various interesting collections. Constance is the centre of a brisk transit trade, while it has various factories and other industrial establishments.

Constance owes its fame, not to the Roman station that existed here, but to the fact that it was a bishop's see from the 6th century (when it was transferred hither from Vindonissa, near Brugg, in the Aargau) till its suppression in 1821, after having been secularized in 1803 and having lost, in 1814-1815, its Swiss portions. The bishop was a prince of the Holy Roman Empire, while his diocese was one of the largest in Germany, including (shortly before the Reformation) most of Baden and Württemberg, and 12 out of the 22 Swiss cantons (all the region on the right bank of the Aar, save the portions included in the diocese of Coire)—in it were comprised 350 monasteries, 1760 benefices and 17,000 priests. It was owing to this important position that the see city of the diocese was selected as the scene of the great reforming council, 1414-1418 (see below), which deposed all three rival popes, elected a new one, Martin V., and condemned to death by fire John Huss (6th of July 1415) and Jerome of Prague (23rd of May 1416). In 1192 (some writers say in 1255) the city became an imperial free city, but the bishop and his chapter practically ruled it till the time of the Reformation. Constance is the natural capital of the Thurgau, so that when in 1460 the Swiss wrested that region from the Austrians, the town and the Swiss Confederation should have been naturally drawn together. But Constance refused to give up to the Swiss the right of exercising criminal jurisdiction in the Thurgau, which it had obtained from the emperor in 1417, while the Austrians, having bought Bregenz (in two parts, 1451 and 1523), were very desirous of securing the well-placed city for themselves. In 1530 Constance (whose bishop had been forced to flee in 1527 to Meersburg, on the other side of the lake, and from that time the episcopal residence) joined, with Strassburg, Memmingen and Lindau, the Schmalkalden League. But after the great defeat of the Protestants in 1547, in the battle of Mühlberg, the city found itself quite isolated in southern Germany. The Austrians had long tried to obtain influence in the town, especially when its support of the Protestant cause attracted the sympathy of the Swiss. Hence Charles V. lost no time, and in 1548 forced it, after a bloody, though unsuccessful, fight on the bridge over the Rhine, not merely to surrender to the imperial authority and to receive the bishop again, but also to consent to annexation to the Austrian family dominions. Protestantism was then vigorously stamped out. In 1633 Constance resisted successfully an attempt of the Swedes to take it, and, in 1805, by the treaty of Pressburg, was handed over by Austria to Baden.

See S. J. Capper, *The Shores and Cities of the Bodensee* (London, 1881); G. Gsell-Fels, *Der Bodensee* (Munich, 1893); Bruckmann's illustrierte Reiseführer; E. Issel, *Die Reformation in Konstanz* (Freiburg i/B., 1898); F. X. Kraus, *Die Kunstdenkmäler des Kreises Konstanz* (Freiburg i/B., 1887); J. Laible, *Geschichte der Stadt Konstanz* (Konstanz, 1896); A. Maurer, *Der Übergang der Stadt Konstanz an das Haus Österreich* (Frauenfeld, 1904). (W. A. B. C.)

CONSTANCE, COUNCIL OF. This council, convoked at the instance of the emperor Sigismund by Pope John XXIII.—one of the three popes between whom Christendom was at the time divided—with the object of putting an end to the Great Schism of the West and reforming the church, was opened on

the 5th of November 1414 and did not close until the 22nd of April 1418. In spite of his reluctance to go to Constance, John XXIII., who succeeded Alexander V. (the pope elected by the council of Pisa), hoped that the new council, while confirming the work of the council of Pisa, would proclaim him sole legitimate pope and definitely condemn his two rivals, Gregory XII. and Benedict XIII. But he was soon forced to renounce this hope. So urgent was the need of restoring union at any cost that even prelates who had taken an active part in the work of the council of Pisa, such as Pierre d'Ailly, cardinal bishop of Cambrai, were forced to admit, in view of the fact that the decisions of that council had been and were still contested, that the only possible course was to reconsider the question of the union *de novo*, entirely disregarding all previous deliberations on the subject, and treating the claims of John and his two competitors with the strictest impartiality. Feebly supported by the Italians, by the majority of the cardinals, and by the representatives of the king of France, John soon found himself in danger of being driven to abdicate. With the connivance of the duke of Austria he fled, first to Schaffhausen, then to Laufenburg, Freiburg, and finally to Breisach, in the hope of escaping in Burgundian territory the pressure exerted upon him by the emperor and the fathers of the council. His flight, however, only precipitated events. Sigismund declared war on the duke of Austria, and the fathers, determined to have their will carried out, drew up in their 4th and 5th sessions (30th of March and 6th of April 1415) a set of decrees with the intention of justifying their attitude and putting the fugitive pope at their mercy. Interpreted in the most general sense, these decrees, which enacted that the council of Constance derived its power immediately from Jesus Christ, and that every one, even the pope, was bound to obey it and every legitimately assembled general council in all that concerned faith, reform, union, &c., were tantamount to the overturning of the constitution of the church by establishing the superiority of the council over the pope. Their terms, however, could not fail to give rise to some ambiguity, and their validity was especially contested on the ground that the council was not ecumenical, since it represented at that date the obedience of only one of three rival popes. Nevertheless, John, who had been abandoned by the duke of Austria and imprisoned in the castle of Radolfzell, near Constance, was arraigned, suspended and deposed (May 29th), and himself ratified the sentence of the council.

Pope Gregory XII. was next required to renounce his rights, and this he did, with as much independence as dignity, through a legate, who previously convoked the council in the name of his master, and thus in some sort gave it the necessary confirmed authority. This was the regular extinction of the line of pontiffs who, if the validity of the election of Urban VI. on the 8th of April 1378 be admitted, had held the legitimate papacy for thirty-seven years.

All that remained was to obtain the abdication of Benedict XIII., the successor of the Avignon pope Clement VII., but the combined efforts of the council and the emperor were powerless to overcome the obstinacy of the Aragonese pope. It was in vain that Sigismund journeyed to Perpignan, and that the kings of Aragon, Castile and Navarre ceased to obey the aged pontiff. Abandoned by almost all his adherents Benedict found refuge in the castle of Peñíscola on an impregnable rock overlooking the Mediterranean, and remained intractable. At the council proceedings were instituted against him, which ended at last on the 26th of July 1417 in his deposition. In this sentence it is to be noted that the council of Constance was careful not to base itself upon the former decision of the council of Pisa. The action of the council of Constance in renewing the condemnation of the doctrines of Wycliffe pronounced at Rome in 1413, and in condemning and executing John Huss and Jerome of Prague, is dealt with elsewhere (see WYCLIFFE; HUSS; JEROME OF PRAGUE). Nor is it possible to mention here all the intrigues and quarrels that arose during three and a half years among the crowd of prelates, monks, doctors, simple clerks, princes and ambassadors composing this tumultuous assembly—perhaps

the greatest congress of people the world has ever seen. From the outset, voting by count of heads had been superseded by voting according to nations, *i.e.* all questions were deliberated and settled in four distinct assemblies—the Italian, the French, the German and the English,¹—the decisions of the nations being merely ratified afterwards *pro forma* by the council in general congregation, and also, if occasion arose, in public session. These four groups, however, were of unequal importance, and thanks to this arrangement the English, although weakest in point of numbers, were able to exercise the same influence in the council as if they had formed a fourth of the voters—the same influence, for instance, as the Italians, who had an imposing numerical force. This anomaly aroused lively protests, especially in the French group, after the battle of Agincourt had rekindled national animosity on both sides. The arrival of the Spaniards at Constance necessitating the formation of a fifth nation, Pierre d'Ailly availed himself of the opportunity to ask either that the English nation might be merged in the German, or that each great nation might be allowed to divide itself into little groups each equivalent to the English nation. It is not difficult to imagine the storms aroused by this indiscreet proposal; and had not the majority of the Frenchmen assembled at Constance had the sagacity to refuse to uphold the cardinal of Cambrai on this point, the upshot would have been a premature dissolution of the council.

Another source of trouble was the attitude of the emperor Sigismund, who, not content with protecting by his presence and as far as possible directing the deliberations of the "Universal Church," followed on more than one occasion a policy of violence and threats, a policy all the more irritating since, weary of his previously assumed rôle of peacemaker between the Christian powers, he had abruptly allied himself with the king of England, and adopted an extremely hostile attitude towards the king of France.

The reform which the council had set itself to effect was a subject the fathers could not broach without stirring up disension: some stood out obstinately for preserving the *status quo*, while others contemplated nothing less than the transformation of the monarchical administration of the church into a parliamentary democracy, the subordination of the sovereign pontiff, and the annihilation of the Sacred College. In view of these difficulties, the opinion which tended to assure the success of one at least of the great tasks before the council, *viz.* the re-establishment of unity by the election of a single pope, finally prevailed in despite of Sigismund. The general reform on which the council had failed to come to an understanding had to be adjourned, and the council contented itself with promulgating, on the 9th of October 1417, the only reforming decrees on which an agreement could be reached. The principle of the periodicity of the councils was admitted; the first was to assemble after the lapse of five years, the second within the next seven years, and subsequent councils were to meet decennially. In the event of a fresh schism, the council, which bound itself to assemble immediately, even without formal convocation, was to remain sole judge of the conflict. After his election the pope had to make a profession of the Catholic faith, and give guarantees against arbitrary translations. Finally, the council pronounced in favour of the pope's renunciation of the right to the movable property of deceased prelates (*spolium*) as well as of the right of procurations. The execution of the surplus of the general reform of the church in its head and members was left in the hands of the future pope, who had to proceed conjointly with the council, or rather with a commission appointed by the nations—in other words, once the new pope was elected, the fathers, conscious of their impotence, were disinclined to postpone their dispersion until the laborious achievement of the reform. They were weary of the business, and wished to be done with it.

In order to rebuild the see of St Peter on a basis now cleared of obstacles, an attempt was made to surround the election of

¹The English, who had hitherto been considered to form part of the German "nation," were recognized as a separate nation at this council for the first time.

the future pope with all the necessary guarantees. The authority of the cardinals, who were the only persons judicially invested with the right of electing the pope, emerged from the crisis through which the church had just passed in far too feeble and contested a condition to carry by its own weight the general assent. It was therefore decided that with the cardinals each nation should associate six delegates, and that the successful candidate should be required to poll two-thirds of the suffrages, not only in the Sacred College, but also in each of these five groups. The advantage of this arrangement was that the choice of the future pope would depend, not only on the vote of the cardinals, thus safeguarding tradition, but at the same time on the unanimous consent of the various nations, by which the adhesion of the whole Catholic world to the election would be guaranteed. There was, indeed, a danger lest the rivalries in the assembly might render it exceedingly difficult, not to say impossible, to obtain such unanimity. But at the end of three days the conclave resulted in the election of Cardinal Otto Colonna, who took the name of Martin V. (11th of November 1417), and the Great Schism of the West was at an end.

To conform to the decrees of the council, the new pope drew up a project of reform with the concurrence of the fathers still remaining at Constance, and subsequently made various reforming treaties or concordats with the nations of the council, which finally broke up after the 45th session, held on the 22nd of April 1418. To all seeming the pope had admitted the canonicity of several of the decrees of Constance—for instance, he had submitted to the necessity of the periodical convocation of other councils; but from his reticence on some points, as well as from his general attitude and some of his constitutions, it appeared that the whole of the decrees of Constance did not receive his unqualified approval, and without any definite pronouncement he made some reservations in the case of decrees which were detrimental to the rights and pre-eminence of the Holy See.

See H. von der Hardt, *Magnum oecumenicum Constantiense concilium* (Frankfort, 1700); Ulrich von Richental, *Das Concilium-buch zu Konstanz*, ed. by Buck in the *Bibliothek des liter. Vereins* (Stuttgart, 1882); H. Finke, *Forschungen und Quellen zur Gesch. des Konstanzer Konzils* (Paderborn, 1889), and *Acta concilii Constantiensis*, vol. i. (Münster, 1896), N. Valois, *La France et le grand schisme d'Occident*, vol. iv. (Paris, 1902). (N. V.)

CONSTANCE, LAKE OF (called by the Romans *Lacus Brigantinus* or lake of Bregenz, and now usually named in German *Bodensee*, as well as the "Swabian Sea"), the most extensive sheet of water in the Alpine region, after the Lake of Geneva. It is situated on the north-east frontier of Switzerland, and is formed by the Rhine. Its shape is oblong, while at its north-western extremity it divides into two arms, the *Untersee* (from Constance to Stein-am-Rhein) and the *Überlingersee* (running up to Ludwigshafen). The length of the lake from Bregenz to Stein-am-Rhein is 46½ m., while that from Bregenz to Ludwigshafen is but 40 m. Its surface is 1309 ft. above sea-level, the greatest width is 10½ m., and the greatest depth 827 ft. The area of the lake is 204¼ sq. m., of which 81¼ sq. m. have belonged to Switzerland since 1803, the canton of Thurgau holding 59¼ sq. m. and that of St Gall 21½ sq. m. Austria has held Bregenz, at the south-eastern angle of the lake, since 1451, while the north end of the lake belongs to Baden (Constance held since 1805), and bits of its eastern shore form part of Württemberg (Friedrichshafen, formerly called Buchhorn, since 1810) and of Bavaria (Lindau since 1805). The first steamer was placed on its waters in 1824. Numerous remains of lake-dwellings have been found on the shores of this lake (see E. von Tröltzsch, *Die Pfahlbauten des Bodenseegebietes*, Stuttgart, 1902). (W. A. B. C.)

CONSTANS, JEAN ANTOINE ERNEST (1833–), French statesman, was born at Béziers. He began his career as professor of law, and in 1876 was elected deputy for Toulouse. He sat in the Left Centre and was one of the 363 of the 16th of May 1877. Re-elected in October 1877, he joined Freycinet as minister of the interior in May 1880, holding this portfolio until the 14th of November 1881. On the 22nd of February 1889 he again assumed the same office in the Tirard cabinet. He became prominent as a stalwart opponent of the Boulangist party,

constituting the senate a high court of justice, and taking police measures against the Ligue des patriotes. He resigned on the 1st of March 1890, but his resignation involved the fall of the cabinet, and he resumed his portfolio in the Freycinet cabinet on the 17th of March. On the 29th of December 1889 he had been elected senator by the department of the Haute-Garonne. He was violently attacked by the press and the Boulangist deputies, but did not resign until the whole cabinet withdrew, on the 26th of February 1892. In December 1898 he was appointed ambassador at Constantinople.

CONSTANT, BENJAMIN (1845-1902), French painter, was born in Paris, and studied under Cabanel. His first Salon picture, "Hamlet et le Roi," was hung in 1869, and he became at once one of the recognized modern masters in France. In addition to a number of subject-pictures, such as "Trop Tard" (1870), "Samson et Délilah" (1871), and others taken from Moroccan studies, he was an eminent painter of portraits of some of the most prominent men and women of the day, one of his last being that of Queen Victoria (1900). He was a member of the Institut de France and received several French and foreign decorations.

CONSTANT DE REBECQUE, HENRI BENJAMIN (1767-1830), French writer and politician, was born at Lausanne on the 25th of October 1767. His mother, Henriette de Chandieu, died at his birth, and his father, Juste Arnold de Constant, commanded a regiment in the Dutch service. After a good private education at Brussels, he was sent to Oxford, and thence to Erlangen; a subsequent residence at Edinburgh and the relations there formed with prominent Whigs profoundly influenced his political views. He returned to Switzerland in 1786, and in the next year visited Paris, where he met Madame de Charrière, a Dutchwoman who had married into a Swiss family with which his own was connected. Madame de Charrière, although twenty-seven years older than Constant, became his mistress, and the *liaison*, an affair possibly more of the intellect than of the heart, lasted until 1796, when Constant became intimate with Madame de Staël. After an escapade in England in 1787, he spent two months with her at Colomber before becoming, in deference to his father's wishes, chamberlain at the court of Charles William, duke of Brunswick, where in 1789 he married one of the ladies-in-waiting, Wilhelmina, Baroness Chramm. The duke's share in the coalition against France made his service incompatible with Constant's political opinions, which were already definitely republican, and, on the dissolution of his marriage in 1794, he resigned his post. Meanwhile his father had been accused of malversation of the funds of his regiment; Benjamin helped him with his defence, with the result that he was finally exonerated and restored to the service with the rank of general.

Constant, who had met Madame de Staël at Lausanne in 1794, followed her in the next year to Paris, where he rapidly became a personage in the moderate republican circle which met in her salon; and by 1796 he had established with her intimate relations, which, in spite of many storms, endured for ten years. In 1796 he published two pamphlets in defence of the Directory and against the counter-revolution, "*De la force du gouvernement actuel et de la nécessité de se rallier*" and "*Des réactions politiques*." He was one of the promoters of the constitutional club of Salm, formed to counterbalance the royalist club of Clichy, and he supported Barras in 1797 and 1799 in the *coups d'état* of 18 Fructidor, and of 18 Brumaire. In December 1799, he was nominated a member of the Tribunate, where he showed from the outset an independence quite unacceptable to Napoleon, by whom he was removed in the "creaming" of that assembly in 1802. His incessant opposition was attributed partly to his association with Madame de Staël, whose salon was a centre for those disaffected from the Napoleonic régime, and in 1803 he followed her into exile. After M. de Staël's death in 1802, there was no longer any obstacle to their marriage, but Madame de Staël was apparently unwilling to change her name. Much of Constant's time was spent with her at Coppet; but he also made long sojourns at Weimar, where he mixed in the Goethe-Schiller circle, and accumulated material for the great work on religion which he had begun, so far back as 1787, at Colom-

bier. His relations with Madame de Staël became more and more difficult, and in 1808 he secretly married Charlotte von Hardenberg, whom he had known at Brunswick, and whose divorce from her second husband, General Dutertre, he had secured. Even his marriage, which did not prove a happy one, was insufficient to cause an entire breach with Corinne, who insisted on his return to Coppet for a short time. In 1811, while residing with his wife's relations at Hardenberg, near Göttingen, he was brought into contact with German mysticism, which considerably modified his earlier sceptical views on religion.

The Napoleonic reverses of 1813 brought him back to politics, and in November he published at Hanover his *De l'esprit de conquête et de l'usurpation dans leurs rapports avec la civilisation européenne*, directed against Napoleon. He also entered into relations with the crown prince of Sweden (Bernadotte), who conferred on him the order of the Polar Star. On his return to Paris, during its occupation by the allied sovereigns, he was well received by the emperor Alexander I of Russia, and resumed his old place in the Liberal salon of Madame de Staël. In a series of pamphlets he advocated the principles of a Liberal monarchy and the freedom of the press. At this point began the second great attachment of his life, his unfortunate infatuation for Madame Récamier, under whose influence he committed the worst blunder of his political career. At the beginning of the Hundred Days he had violently asserted in the *Journal des débats* his resolution not to be a political turncoat, and had left Paris. Attracted by Madame Récamier, he soon returned, and after an interview with Napoleon on the 10th of April, he became a supporter of his government and drew up the *Acte constitutionnel*. The return of Louis XVIII. drove him into exile. In London in 1815 he published *Adolphe*, one of the earliest examples of the psychological novel. It had been written in 1807, and is intrinsically autobiographical; that Adolphe represents Constant himself there is no dispute, but Ellénore probably owes something both to Madame de Charrière and Madame de Staël. In 1816 he was again in Paris, advocating Liberal constitutional principles. He founded in 1818 with other Liberal journalists the *Minerve française* and in 1820 *La Renommée*. In 1819 he was returned to the Chamber of Deputies, and proved so formidable an opponent that the government made a vain attempt to exclude him from the Chamber on the ground of his Swiss birth. Perhaps the greatest service he rendered to his party was his consistent advocacy of the freedom of the press. At the outbreak of the revolution of 1830 he was absent from Paris, having undergone an operation, but he returned at the request of Lafayette to take his share in the elevation of Louis Philippe to the throne. On the 27th of August he was made president of the council of state, but he died on the 8th of December of the same year. During his later years he had been a cripple in consequence of a fall in the Chamber of Deputies, and he fought the last of his many duels sitting in a chair. After the death, in 1817, of Madame de Staël, whom he continued to visit daily until the end, he had ceased to go into society, giving himself up to his passion for play. To pay his gambling debts he accepted a gift of 200,000 francs from Louis Philippe, thus affording a ready handle to his enemies. The failure of his candidature for the Academy in 1830 is said to have been a shock to his enfeebled health.

Constant's political career was spoiled by his *liaison* with Madame de Staël, and at the Restoration was further disturbed by his unreturned passion for Madame Récamier. His defects as a debater were not compensated entirely by the excellence of his set speeches; but his wide culture and powerful intellect were bound to leave their mark on affairs. His political inconsistencies were more apparent than real, for there was no break in his advocacy of Liberal principles. His best writing is to be found in his journalism and correspondence (only a small part of which has been published), rather than in his more pretentious political pamphlets.

In the most important of his writings, *De la religion considérée dans sa source, ses formes, et ses développements* (5 vols., 1825-1831), he traces the successive transformations of the religious

sentiment imperishable under its varying forms. Besides *Adolphe*, in its way as important as Chateaubriand's *René*, he left two other sketches of novels in MS., which are apparently lost. His political tracts were collected by himself as, *Collection complète des ouvrages publiés sur . . . la France, formant une espèce de cours de politique constitutionnelle* (4 vols., 1818-1820), as were his *Discours à la Chambre des Députés* (2 vols., 1827).

AUTHORITIES.—See Constant's *Cahier rouge*, published first in 1907, containing his autobiography from 1767 to 1787; *Journal intime* (1804-1816), re-edited with the *Lettres à sa famille* by D. Melegari in 1895; the semi-autobiographical *Adolphe*; his letters to Madame de Charrière; to Madame Récamier, edited by Madame Lenormant in 1882. His ordinary diary has disappeared, with his letters to his wife and to Madame de Staël. See further an article by Loève-Weimars in the *Revue des deux mondes* (1st January 1833); H. Castille, *B. Constant* (1859); the *Réminiscences* of J. J. Coulmann (3 vols., 1862-1869); Ed. Herriot, *Madame de Récamier et ses amis* (1904); Sainte-Beuve in *Derniers portraits littéraires* (B. Constant and Madame de Charrière), *Causeries du lundi* (vol. xi.), *Nouveaux lundis* (vol. i.); É. Faguet, *Politiques et moralistes du XIX^e siècle* (1^{ère} série, 1891); P. Godet, *Madame de Charrière et ses amis* (Geneva, 1905); L. Michon, *Le Gouvernement parlementaire sous la Restauration* (1905), containing an analysis of the more important of Constant's political writings; V. Glachant, *Benjamin Constant sous l'œil ud guet* (1906), containing an account of his relations with the police, also his correspondence with Fauriel; G. Rudler, *La Jeunesse de B. Constant*, and *Bibliographie critique* (1909).

CONSTANTIA, a district of Cape Colony, in the Cape peninsula, noted for the excellent quality of its wines, the best produced in South Africa. The government wine farm, Groot Constantia, 10 m. S. of Cape Town, contains over 150,000 vines. This and the adjacent farm of High Constantia are the only farms on which the vines yielding the finest wines flourish. The district is also celebrated for the excellence of the fruit it yields. Groot Constantia House is a good example of the Dutch colonial dwelling-houses of the 17th century. It was built (c. 1684) by the governor Simon van der Stell, and named in honour of his wife Constance. Van der Stell also laid out the vineyard, which soon attained a wide reputation. *Old Cape Colony*, by Mrs A. F. Trotter (London, 1903), contains a plan and sketches of Groot Constantia.

CONSTANTINE, the name of several Roman and Later Roman emperors.

CONSTANTINE I., known as "The Great" (288?-337), Roman emperor—Flavius Valerius Constantinus,—was born on the 27th of February, probably in A. D. 288,² at Naissus (the modern Nish) in Upper Moesia (Servia). He was the illegitimate son of Constantius I. and Flavia Helena (described by St Ambrose as an innkeeper). His father, already a distinguished officer, soon afterwards became *praefectus praetorio*, and in 293 was raised to the rank of Caesar and placed in command of the western provinces. While still a boy, Constantine was sent—practically as a hostage—to the Eastern court. He accompanied Diocletian to the East in 302, was invested with the rank of *tribunus primi ordinis* and served under Galerius on the Danube. In 305 Diocletian and Maximianus abdicated, and Constantius and Galerius became Augusti, while Severus and Maximinus Daia attained the rank of Caesars. Constantius now demanded from Galerius the restoration of his son, which was unwillingly granted; indeed, we are told that Constantine only escaped from the court of Galerius by flight, and evaded pursuit by carrying off all the post-horses! He traversed Europe with the greatest possible speed and found his father at Bononia (Boulogne), on the point of crossing to Britain to repel an invasion of Picts and Scots. After gaining a victory, Constantius died at Eboracum (York), and on the 25th of July 306, the army acclaimed his son as Augustus. Constantine, however, displayed that union of determination and prudence which the occasion required. He accepted the nomination of the army with feigned reluctance and wrote a carefully-worded letter to Galerius, disclaiming responsi-

¹ The *praenomina* Lucius, Marcus and Gaius are found in various inscriptions. In reality Constantine, like his father and successors, bore no *praenomina*.

² His age at death is variously stated at 62 (Aur. Vict.), 63 (Epit. de Caes.), 64 (Euseb.), 65 (Zonaras and Socrates) and 66 (Eutrop.) years. Seeck has shown that these statements are false, and that Constantine was born in or about the year 288 A.D.

bility for the action of the troops, but requesting recognition as Caesar—a position to which he might naturally aspire on the elevation of Severus to the rank of Augustus. Galerius was not in a position to refuse the request, in view of the temper of the western army, and for a year Constantine bore the title of Caesar not only in his own provinces, but in those of the East as well. He fought with success against the Franks and Alamanni, and reorganized the defences of the Rhine, building a bridge at Colonia Agrippina (Cologne). The rising of Maxentius (q.v.) at Rome (Oct. 28), supported by his father Maximianus (q.v.), led to the defeat and capture of the western Augustus, Severus (q.v.). Maximianus thereupon recognized Constantine as Augustus (A.D. 307), their alliance was confirmed by the marriage of Constantine with Fausta, the daughter of Maximianus, and the father and son-in-law held the consulship, which, however, was not recognized in the East. Galerius now invaded Italy, but was forced by a mutiny of his troops to retire from the gates of Rome. Maximianus urged Constantine to fall upon the flank of his retreating army, but he once more showed his determination to tread the strict path of legitimacy. Maximianus, after the failure of his attempt to depose his son Maxentius, was forced to seek refuge with Constantine, and became a *quantité négligeable*. In 308 Diocletian and Galerius held a conference at Carnuntum and determined to annul the actions of the Western rulers. Maximianus was set aside, Licinius invested with the purple as Augustus of the West (Nov. 11), while the title *filius Augustorum* was conferred upon Constantine and Maximinus Daia, and the former was destined for a *first* consulship (that of 307 being passed over) for 309. Constantine, with his customary union of prudence and decision, tacitly ignored this arrangement; he continued to bear the title of Augustus, and in 309, when he himself was proclaimed consul (with Licinius) in the East, no consuls were recognized in his dominions. In 310, while Constantine was engaged in repelling an inroad of the Franks, Maximianus endeavoured to resume the purple at Arles (Arles). Constantine returned in haste from the Rhine, and pursued Maximianus to Massilia, where he was captured and put to death.³ Since Constantine's legal title to the Empire of the West rested on his recognition by Maximianus, he had now to seek for a new ground of legitimacy, and found it in the assertion of his descent from Claudius Gothicus (q.v.), who was represented as the father of Constantius Chlorus.⁴

Constantine's patience was soon rewarded. In 311 Galerius died, and Maximinus Daia (who had assumed the style of Augustus in 310) at once marched to the shores of the Bosphorus and at the same time entered into negotiations with Maxentius. This threw Licinius into the arms of Constantine, who entered into alliance with him and betrothed his half-sister Constantia to him. In the spring of 312 Constantine crossed the Alps, before Maxentius, who had been obliged to suppress the rebellion of Domitius Alexander in Africa, had completed his preparations. The force he commanded was of uncertain strength, according to his Panegyrist (who may have underrated it) it consisted of about 25,000, according to Zonaras of nearly 100,000 men. He stormed Susa, defeated Maxentius's generals at Turin and Verona, and marched straight for Rome. This bold and almost desperate move, which contrasted strongly with Constantine's usual caution, and seemed to court the failure which had befallen Severus and Galerius, was, it would seem, the result of an event which, as told in Eusebius's *Life of Constantine*, takes the form of a conspicuous miracle—the Vision of the Flaming Cross which appeared in the sky at noonday with the legend 'Εν ροις ω νικα ("By this conquer"), and led to Constantine's conversion to Christianity. Eusebius professes to have heard the story from the lips of Constantine; but he wrote after the emperor's

³ The story told in the *De mortibus persecutorum* (cap. 30) of a later conspiracy of Maximianus, which failed owing to the fidelity of Fausta, is most probably a fiction.

⁴ Such is the primary version of the story, implied in the Seventh Panegyric of Eunemius, delivered at Trier in A.D. 310. It would seem that when Christian sentiment was offended by the illegitimate origin ascribed to Constantius, the story was modified and Claudius became his uncle.

death, and it was evidently unknown to him in the shape given above when he wrote the *Ecclesiastical History*. The author of the *De mortibus persecutorum*, whether Lactantius or another, was a well-informed contemporary, and he tells us that the sign was seen by Constantine in a dream; and even Eusebius supplements the vision by day with a dream in the following night. In any case, Constantine, who may have been impressed by the misfortunes which had befallen the more strenuous opponents of Christianity, adopted the monogram χ as his device¹ and staked his all on the issue.

Maxentius, trusting in superiority of numbers,—he is said to have had 170,000 infantry and 18,000 cavalry at his disposal, but this total probably includes the forces defeated by Constantine in Northern Italy—marched out of Rome and prepared to dispute the passage of the Tiber at the Pons Mulvius (Ponte Molle), beside which a bridge of boats was constructed. Our authorities give no satisfactory account of the battle which followed, and Aurelius Victor places it at Saxa Rubra, a statement accepted by Moltke and other modern authorities. It is more probable, as Seeck has shown, that while the head of Maxentius's column may have reached Saxa Rubra (which is some miles to the north of the Mulvian Bridge on the Via Flaminia), Constantine, by a rapid turning movement, reached the Via Cassia and attacked Maxentius's rearguard at the bridge,² forcing him to fight in the narrow space between the hills and the Tiber. The army which Constantine had been training for six years at once proved its superiority. The Gallic cavalry swept the left wing of the enemy into the Tiber, swollen with autumn rains, and with it perished Maxentius, owing, as was said, to the collapse of the bridge of boats (Oct. 28). The remainder of his troops surrendered at discretion and were incorporated by Constantine in the ranks of his army, with the exception of the praetorian guard, which was finally disbanded.

Thus Constantine became undisputed master of Rome and the West, and Christianity, although not as yet adopted as the official religion, secured by the edict of Milan toleration throughout the Empire. This edict was the result of a conference between Constantine and Licinius in 313 at Milan, where the marriage of the latter with Constantia took place. Constantine was forced to recognize Licinius's natural son as his heir. In the course of the same year Licinius defeated Maximinus Daia, who perished at Tarsus by his own hand. In 314 war broke out between the two Augusti, owing, as we are told, to the treachery of Bassianus, the husband of Constantine's sister Anastasia, for whom he had claimed the rank of Caesar. After two hard-won victories Constantine made peace, Illyricum and Greece being added to his dominions. Constantine and Licinius held the consulship in 315, in which year the former celebrated his *decennalia*, and on the 1st of March 317 Constantine's two sons and Licinius's bastard were proclaimed Caesars.

Peace was preserved for nearly nine years, during which the wise government of Constantine strengthened his position, while Licinius (who resumed the persecution of the Christians in 321) steadily lost ground through his indolence and cruelty. Great armaments, both military and naval, were called into being by both emperors, and in the spring of 324³ Licinius (whose forces are said to have been superior in numbers) declared war. He was twice defeated, first at Adrianople (July 1) and afterwards at Chrysopolis (Sept. 18), when endeavouring to raise the siege of Byzantium, and was finally captured at Nicomedia. His life was spared on the intercession of Constantia and he was interned at Thessalonica, where he was executed in the following year on the charge of treasonable correspondence with the barbarians.

¹ The name *labarum*, given to the military standards bearing the monogram, is of unexplained origin. Lactantius says that the symbol was used on the shields of Constantine's troops.

² That the battle was called after the Milvian bridge is indicated by a relief and inscription from Cherchel (*C.I.L.* viii. 9356).

³ It has been disputed whether the final struggle between Constantine and Licinius took place in A.D. 323 or 324; but the *formulae* employed in the dating of Egyptian papyri seem to point to the latter year (see *Comptes-rendus de l'académie des inscriptions*, 1906, p. 221 ff.).

Constantine now reigned as sole emperor in East and West. He presided at the council of Nicaea (see under NICAEA and COUNCIL) in 325; in the same year he celebrated his *Vicennalia* in the East, and in 326 repeated the celebration in Rome. Whilst he was in Rome his eldest son, Crispus, was banished to Pola and there put to death on a charge brought against him by Fausta. Shortly afterwards, as it would seem, Constantine became convinced of his innocence, and ordered Fausta to be executed. The precise nature of the circumstances remains a mystery.

In 326 Constantine determined to remove the seat of empire from Rome to the East, and before the close of the year the foundation-stone of Constantinople was laid. At least two other sites—Sardica and Troy—were considered before the emperor's choice fell on Byzantium. It is very probable that this step was connected with Constantine's decision to make Christianity the official religion of the empire. Rome was naturally the stronghold of paganism, to which the great majority of the senate clung with fervent devotion. Constantine did not wish to do open violence to this sentiment, and therefore resolved to found a new capital for the new empire of his creation. He announced that the site had been revealed to him in a dream; the ceremony of inauguration was performed by Christian ecclesiastics on the 11th of May 330, when the city was dedicated to the Blessed Virgin.

In 332 Constantine was called in to aid the Sarmatians against the Goths over whom his son gained a great victory on the 20th of April. Two years later there was again fighting on the Danube, when 300,000 Sarmatians were settled in Roman territory. In 335 a rebellion in Cyprus gave Constantine an excuse for executing the younger Licinius. In the same year he carried out a partition of the empire between his three sons and his two nephews, Delmatius and Hannibalianus. The last named received the vassal-kingdom of Pontus with the title of *rex regum*, while the others ruled as Caesars in their several provinces. Constantine, however, retained the supreme government, and in 335 celebrated his *tricennalia*. Finally, in 337, Shapur (Sapor) II. of Persia asserted his claim to the provinces conquered by Diocletian, and war broke out. Constantine was preparing to lead his army in person, when he was taken ill, and after a vain trial of the baths at Helenopolis, died at Ancyrona, a suburb of Nicomedia, on the 22nd of May, having received Christian baptism shortly before at the hands of Eusebius. He was buried in the church of the Apostles at Constantinople.

It has been said by Stanley that Constantine was entitled to be called "Great" in virtue rather of what he did than of what he was; and it is true that neither his intellectual nor his moral qualities were such as to earn the title. His claim to greatness rests mainly on the fact that he divined the future which lay before Christianity, and determined to enlist it in the service of his empire, and also on his achievement in completing the work begun by Aurelian and Diocletian, by which the quasi-constitutional monarchy or "Principate" of Augustus was transformed into the naked absolutism sometimes called the "Dominate." There is no reason to doubt the sincerity of Constantine's conversion to Christianity, although we may not attribute to him the fervent piety which Eusebius ascribes to him, nor accept as genuine the discourses which pass under his name. The moral precepts of the new religion were not without influence upon his life, and he caused his sons to receive a Christian education. Motives of political expediency, however, caused him to delay the full recognition of Christianity as the religion of the state until he became sole ruler of the empire, although he not merely secured toleration for it immediately after his victory over Maxentius, but intervened in the Donatist controversy as early as 313, and presided at the council of Arles in the following year. By a series of enactments immunities and privileges of various kinds were conferred on the Catholic Church and clergy—heretics being specifically excluded—and the emperor's attitude towards paganism gradually revealed itself as one of contemptuous toleration. From being the established religion of the state it sank into a mere *superstitio*.

At the same time its rites were allowed to subsist except where they were held to be subversive of morality, and even in the closing years of Constantine's reign we find legislation in favour of the municipal *flamines* and *collegia*. In 333, or later, a cult of the *Gens Flavia*, as the Imperial family was called, was established at Hispellum (Spello); the offering of sacrifices in the new temple was, however, strictly prohibited. Nor was it until after Constantine's final triumph over Licinius that pagan symbols disappeared from the coinage and the Christian monogram (which had already been used as a mint mark) became a prominent device. From this time forward the Arian controversy demanded the emperor's constant attention, and by his action in presiding at the council of Nicaea and afterwards pronouncing sentence of banishment against Athanasius he not only identified himself more openly than ever with Christianity, but showed a determination to assert his supremacy in ecclesiastical affairs, holding no doubt that, as the office of *pontifex maximus* gave him the supreme control of religious matters throughout the empire, the regulation of Christianity fell within his province. In this matter his discernment failed him. It had been comparatively easy to apply coercion to the Donatists, whose resistance to the temporal power was not wholly due to spiritual considerations,¹ but was largely the result of less pure motives; but the Arian controversy raised fundamental issues, which to the mind of Constantine appeared capable of compromise, but in reality, as Athanasius rightly discerned, disclosed vital differences of doctrine. The result foreshadowed the process by which the church which Constantine hoped to mould into an instrument of absolutism became its most determined opponent. It is unnecessary to give more than a passing mention to the legend according to which Constantine, smitten with leprosy after the execution of Crispus and Fausta, received absolution and baptism from Silvester I. and by his Donation to the bishop of Rome laid the foundation of the temporal power of the papacy (see DONATION OF CONSTANTINE).

The political system of Constantine was the final result of a process which, though it had lasted as long as the empire, had assumed a marked form under Aurelian. It was Aurelian who surrounded the imperial person with oriental pomp, wearing the diadem and the jewelled robe, and assuming the style of *dominus* and even *dcus*, who assimilated Italy to the condition of the provinces and gave official furtherance to the economic process by which a régime of status replaced a régime of contract. Diocletian endeavoured to secure the new despotism against military usurpation by an elaborate system of co-regency with two lines of succession, bearing the names of *Jovii* and *Herculii*, but maintained by adoption and not by hereditary succession. This artificial system was destroyed by Constantine, who established dynastic absolutism in favour of his own family, the *gens Flavia*, evidence of whose cult is found both in Italy and in Africa. To form a court he created a new official aristocracy to replace the senatorial order, which the military emperors of the 3rd century A.D. had reduced to practical insignificance. Upon this aristocracy he showered titles and distinctions, such as the revised patriciate, which carried with them the coveted immunity from fiscal burdens.² As the senate was now a *quantité négligeable*, Constantine could afford to readmit its members freely to the career of provincial administration, which had been almost closed to them since the reign of Gallienus, and to accord to it certain empty privileges such as the free election of quaestors and praetors, while on the other hand the right of the senator to be tried by his peers was taken away and he was placed under the jurisdiction of the provincial governor.

In the administration of the empire Constantine completed the work of Diocletian by effecting the separation of civil from military functions. Under him the *praefecti praetorio* cease entirely to perform military duties and become the heads of the

civil administration, more especially in the matter of jurisdiction: in 331 their decisions were made final and no appeal to the emperor was permitted. The civil governors of the provinces (*vicarii* and *praesides*) had no control of the military forces, which were commanded by *duces*; and not content with the security against usurpation which was afforded by this division of power, Constantine employed the *comites* who formed a large element in the official aristocracy to supervise and report upon their conduct of affairs (see COUNT), as well as an army of so-called *agentes in rebus* who, under colour of inspecting the Imperial posting service, carried on a wholesale system of espionage. In the organization of the army the creation of a field force (*comitatenses*) beside the permanent frontier-garrisons (*limitanei*) was probably the work of Diocletian; to Constantine is due the creation of the great commands under the *magistri peditum* and *equitum*. He also introduced the practice, afterwards increasingly common, of placing barbarians, especially Germans, in posts of high responsibility.

The organization of society in strictly hereditary corporations or professions was no doubt partly completed before the accession of Constantine; but his legislation contributed to rivet the fetters which bound each individual to the caste from which he sprang. Such *originales* are mentioned in Constantine's earliest laws, and in 332 the hereditary status of the agricultural *colonus* was recognized and enforced. Above all, the municipal *decuriones* on whom the responsibility for raising taxation rested saw every avenue of escape closed against them. In 326 they were forbidden to acquire immunity by joining the ranks of the Christian clergy. It was the interest of the government by such means to secure the regular payment of the heavy fiscal burdens both in money and in kind which had been laid on the subjects of the empire by Diocletian and were certainly not diminished by Constantine. One of our ancient authorities speaks of him as having been for ten years an excellent ruler, for twelve a robber and for ten a spendthrift, and he was constantly forced to have recourse to fresh exactions in order to enrich his favourites and to carry out such extravagant projects as the building of a new capital. To him are due the taxes known as *collatio glebalis*, levied on the estates of senators, and *collatio lustralis*, levied on the profits of trade.

In general legislation the reign of Constantine was a time of feverish activity. Nearly three hundred of his enactments are preserved to us in the Codes, especially that of Theodosius. They display a genuine desire for reform and distinct traces of Christian influence, e.g. in their humane provisions as to the treatment of prisoners and slaves and the penalties imposed on offences against morality. Nevertheless they are in many instances singularly crude in conception as well as turgid in style, and were manifestly drafted by official rhetoricians rather than by trained *legists*. Like Diocletian, Constantine believed that the time had come for society to be remodelled by the fiat of despotic authority, and it is significant that from henceforth we meet with the undisguised assertion that the will of the emperor, in whatever form expressed, is the sole fountain of law. Constantine, in fact, embodies the spirit of absolute authority which, both in church and state, was to prevail for many centuries.

¹ The watchword *Quid est imperatori cum ecclesia?* belongs to a later period.

² These titles were so freely bestowed that in A.D. 326 Constantine found it necessary in the interest of the treasury to enact that the fiscal immunity which they carried should no longer be hereditary.

AUTHORITIES.—The principal ancient sources for the life of Constantine are the biography of Eusebius, which is, however, partial and untrustworthy owing to the ecclesiastical bias of its author (whose *Ecclesiastical History* is also of importance), the tract *de moribus persecutorum* ascribed to Lactantius, the orations of the *Panegyrici*, Nos. vi.-x., the second book of the history of Zosimus (which is written from the pagan standpoint), the so-called *Excerpta Valesiana* and the writings of Aurelius Victor and Eutropius. The laws of Constantine contained in the *Codex Theodosianus* have been treated chronologically by Otto K. Seeck, *Zeitschrift der Savigny-Stiftung (Romanische Abteilung)*, x. p. i. ff. and 177 ff. Amongst modern books may be named J. C. F. Manso, *Das Leben Constantins des Grossen* (1817), Jacob Burckhardt, *Die Zeit Constantins des Grossen* (2nd ed., 1880), H. Schiller, *Geschichte der römischen Kaiserzeit*, ii. 2, 164 ff. (1887), and above all Seeck, *Geschichte des Untergangs der antiken Welt*, vol. i (2nd ed., 1897). For a short account in English C. H. Firth's *Constantine the Great* (1905) may be consulted. (H. S. J.)

CONSTANTINE II. (317-340), son of Constantine the Great, Roman emperor (337-340), was born at Arelate (Arles) in February 317. On the 1st of March in the same year he was created Caesar, and was consul in 320, 321, 324 and 329. The fifth anniversary of his Caesarship was celebrated by the panegyrist Nazarius (*q.v.*). He gained the credit of the victories of his generals over the Alamanni (331, for which he received the title Alamannicus), and over the Goths (332). From 335 he administered the Gallic portion of the empire as Caesar till his father's death (22nd of May 337). On the 9th of September in the same year he assumed the title of Augustus, together with his brothers Constans and Constantius, and in 338 a meeting was held at Viminacium, on the borders of Pannonia, to arrange the distribution of the empire. In accordance with the arrangements made by his father, Constantine received Britain, Spain and the Gauls; Pontus, Asia, the East, and Egypt fell to Constantius; Africa, Pannonia and the Italies to the youngest brother Constans, whose dominions were further increased by the addition of Macedonia, Dalmatia and Thrace, originally intended for Delmatius, a nephew of Constantine I. and one of the victims of the general massacre of that emperor's kinsmen. By virtue of his seniority, Constantine claimed a kind of control over his brothers. Constans, an ambitious youth encouraged by intriguing advisers, declined to submit; and Constantine, jealous of his prerogatives and dissatisfied with his share in the empire, demanded from Constans the cession of Africa and equal authority in Italy. After protracted but unavailing negotiations, Constantine in 340 invaded Italy. He had advanced as far as Aquileia, when he fell into an ambush and lost his life. His body was thrown into the little river Elsa, but subsequently recovered and buried with royal honours.

See Zosimus ii. xii.; Aurelius Victor, *Epit.* 41; Eusebius, *Vita Constantini*, iv.; O. Seeck in Pauly-Wissowa's *Realencyclopädie*, iv. pt. 1 (1900); Gibbon, *Decline and Fall*, ch. 18.

CONSTANTINE III., son of the emperor Heraclius (d. 641) by his first wife Eudocia, succeeded his father as joint-emperor with Heraclonas, the son of Heraclius by his second wife Martina. Court intrigues nearly led to a civil war, which was prevented by the death of Constantine (May 641), after a brief reign of 103 days. He was supposed to have been poisoned by order of his step-mother Martina.

CONSTANTINE IV. *Pogonatus* (the "bearded"), son of Constans II., was emperor from 668 to 685. After his father's death he set out for Sicily, where an Armenian named Mizizius had been declared emperor. Having defeated and put the usurper to death, he returned to the capital. For six years (672-677) the Arabs under the caliph Moawiya (see CALIPHATE) besieged Constantinople, but the ravages caused amongst them by the so-called "Greek fire," heavy losses by land and sea, and the inroads of the Christian Mardaites (or Maronites, *q.v.*) of Mount Lebanon, obliged Moawiya to make peace and agree to pay tribute for thirty years. The attacks of the Slavs and Avars upon Thessalonica were heroically repulsed by the inhabitants. But Constantine, exhausted by the war with the Arabs, was unable to prevent the Bulgars, a tribe of Finno-Ugrian race, from crossing the Danube and settling in the district where their name still survives. The Bulgarian kingdom was established under its first king Iserich in 679. The tribute paid by the Arabs was used to purchase the good will of the new settlers. In order to restore peace in the church, Constantine summoned an ecumenical council (the sixth) at Constantinople, which held its sittings from the 7th of November 680 to the 16th of September 681. The result was the condemnation of the Monothelites and a recognition of the doctrine that two wills, neither opposed nor intermingled, were united in the person of Christ, in accordance with his twofold nature (see under CONSTANTINOPLE, COUNCILS OF).

CONSTANTINE V. *Copronymus* (Gr. κόπρος), son of Leo III. the iconoclast, was emperor 740-775. Immediately after his accession, while he was engaged in a campaign against the Arabs, his brother-in-law, an Armenian named Artavasdus, a supporter of the image-worshippers, had been proclaimed emperor, and

it was not till the end of 743 that Constantine re-entered Constantinople. When he felt his position secure, he determined to settle the religious controversy once for all. In 754 he assembled at the palace of Hiereion 338 bishops, by whom the worship of images was forbidden as opposed to all Christian doctrine and a curse pronounced upon all those who upheld it. But in spite of the severity with which the resolution was enforced, the resistance to iconoclasm continued, chiefly owing to the attitude of the monks, who exercised great influence over the common people. A vigorous campaign against monasticism took place; the monasteries were closed, and many of them pulled down or converted into barracks; monks and nuns were compelled to marry, and exiled in large numbers to Cyprus; the literary and artistic treasures were sold for the benefit of the imperial treasury. One of the most important results of the struggle was the defection of the pope, who sought and obtained protection from Pippin, king of the Franks. All attempts to induce Pippin to throw over his new protégé failed, and from this time onward the nominal dependence of Rome and the papacy on emperors at Constantinople ceased. Constantine has been described by the orthodox historians of his time as a monster of iniquity; but, in spite of the harshness and occasional cruelty with which he treated his religious opponents, for which an excuse may be found in the obstinate fanaticism of the monks, it is now generally admitted that he was one of the most capable rulers who ever occupied the Byzantine throne. He restored the aqueduct built by Valens and destroyed by the barbarians in the reign of Heraclius, re-peopled Constantinople (after it had been devastated by a great plague) and some of the cities of Thrace, revived commercial prosperity, and carried on a number of wars, in which, on the whole, he was successful, against the Arabs, Slavs and Bulgarians. In the year of his death he set out on an expedition against the last-named, but a violent attack of fever obliged him to discontinue his journey. He died on board his fleet on his way home.

CONSTANTINE VI., grandson of Constantine V., was emperor 780-797. At ten years of age he succeeded his father, Leo IV., under the guardianship of his mother Irene (*q.v.*), who held the reins of government for ten years. In 782 the Arabs under Harun al-Rashid penetrated as far as the Bosphorus, and exacted an annual tribute at the price of an inglorious peace (see CALIPHATE, § C, 3 *ad fin.*). Even when Constantine came of age, Irene practically retained the supreme power. At length Constantine had her arrested, but foolishly pardoned her shortly afterwards. Disastrous campaigns against the Bulgarians and Arabs afforded her an opportunity of rousing the contempt and hatred of the people against their ruler. On his return to Constantinople, Constantine managed to escape to the Asiatic coast, but being brought back practically by force he was seized and blinded. According to some, he died on the same day; according to others, he survived for several years. With Constantine VI. the Syrian (Isaurian) dynasty became extinct.

See Theophanes, and the biographies of the patriarch Tarasius and Theodore of Studium; also F. C. Schlosser, *Geschichte der bilderstürmenden Kaiser des oströmischen Reichs* (Frankfurt am Main, 1812); other works *s.v.* IRENE.

CONSTANTINE VII. *Porphyrogenitus* (Gr. *Porphyrogennētos*, "born in the purple") (905-959), East Roman emperor, author and patron of literature, was the son of Leo VI. the Wise. Though nominally emperor from 912-959, it was not until 945 that Constantine could really be called sole ruler. During this period he had been practically excluded from all real share in the government by ambitious relatives. Though wanting in strength of will, Constantine possessed intelligence and many other good qualities, and his reign on the whole was not unsatisfactory. He was poisoned by his son Romanus in 959. Constantine was a painter and a patron of art, a literary man and a patron of literature; and herein consists his real importance, since it is to works written by or directly inspired by him that we are indebted for our chief knowledge of his times. He was the author or inspirer of several works of considerable length. (1) *De Thematis*, an account of the military districts (Themata)

of the empire during the time of Justinian, chiefly borrowed from Hierocles and Stephanus of Byzantium. (2) *De administrando imperio*, an account of the condition of the empire, and an exposition of the author's view of government, written for the use of his son Romanus; it also contains most valuable information as to the condition and history of various foreign nations with which the Byzantine empire had been brought into contact on the east, west and north. (3) *De cerimoniis aulae Byzantinae*, which describes the customs of the Eastern Church and court. (4) A life of Basilus I., his grandfather, based on the work of Genesis. (5) Two treatises on military subjects are attributed to him; one on tactics, which, as the title shows, was really written by his grandson Constantine VIII., the other a description of the different methods of fighting in fashion amongst different peoples. (6) A speech on the despatch of an image of Christ to Abgar, king of Edessa. Of works undertaken by his instructions the most important were the Encyclopaedic Excerpts from all available treatises on various branches of learning. (1) *Historica*, in 53 sections, each devoted to a special subject; of these the sections *De legationibus*, *De virtutibus et vitiis*, *De sententiis*, *De insidiis*, have been wholly or partly preserved. (2) *Basilica*, a compilation from the different parts of the Justinian Corpus Juris, subsequently the text-book for the study of law. (3) *Geoponica*, agricultural treatises, for which see GEOPONICI and BASSUS, CASSIANUS. (4) *Iatrica*, a medical handbook compiled by one Theophanes Nonnus, chiefly from Oribasius. (5) *Hippiatrica*, on veterinary surgery, the connexion of which with Constantine is, however, disputed. (6) *Historia animalium*, a compilation from the epitome of Aristotle's work on the subject by Aristophanes of Byzantium, with additions from other writers such as Aelian and Timotheus of Gaza.

On Constantine VII. generally the most important work is A. Rambaud, *L'Empire grec au dixième siècle* (1870); see also Gibbon, *Decline and Fall*, ch. 53, and G. Finlay, *Hist. of Greece*, ii. 294 (1877). Many of his works will be found in Migne, *Patrologia Graeca*, cix., cxii., cxiii.; for editions of the rest, C. Krumbacher, *Geschichte der byzantinischen Literatur* (1897), and the article by Cohn in Pauly-Wissowa's *Realencyclopädie der classischen Altertumswissenschaft* (1900) should be consulted. The former contains a valuable note on the "Gothic Christmas" described in detail in the *De cerimoniis*; see also Bury in *Eng. Hist. Rev.* xxii. (1907).

CONSTANTINE VIII. This title is given by Gibbon to the son of Romanus I. Lecapenus, one of the colleagues of Constantine VII. Porphyrogenitus, but it is now generally bestowed upon Constantine, the brother and colleague of Basil II. from 976-1025, sole ruler 1025-1028. An absolute contrast to his brother, he gave himself up to a life of pleasure and allowed the administration to fall into the hands of six eunuchs.

CONSTANTINE IX. *Monomachus*, emperor 1042-1054, owed his elevation to an old admirer, Zoë, the widow of Romanus III. Argyrus (1028-1034) and of Michael IV. the Paphlagonian (1034-1041), who, after the brief reign of Michael V. *Calaphates* (December 1041-April 1042), was proclaimed empress with her sister, Theodora. Quarrels broke out between the sisters, and, in order to secure her position, Zoë married Constantine, with whom she shared the throne till her death in 1050. In his old age Constantine, who had once been a famous warrior, utterly neglected the defences of the empire and reduced his army by disbanding 50,000 of his best troops; on the other hand, he spent extravagant sums on luxuries and the erection of magnificent buildings. Rebellions broke out at home and abroad; the Normans conquered Lombardy, which subsequently (1055) became the duchy of Apulia, and thus Italy was lost to the empire; the Petchenegs (Patzinaks) crossed the Danube and

attacked Thrace and Macedonia; and the Seljuk Turks made their appearance on the Armenian frontier.

CONSTANTINE X. *Ducas*; emperor 1059-1067, succeeded Isaac I. Comnenus (*q.v.*). But the choice was not justified, for Constantine, who as the friend and minister of Isaac had shown himself a capable statesman and financier, proved incompetent as an emperor. He devoted himself to philosophical trifling, petty administrative and judicial details, while his craze for economy developed into avarice. He reduced the army, cut down the soldiers' pay, failed to keep up the supply of war material, and neglected the frontier fortresses at a time when the Seljuk Turks were pressing hard upon the eastern portion of the empire. Alp Arslan, the successor of Toghrul Beg, overran Armenia in 1064, and destroyed its capital Ani. The Magyars occupied Belgrade, the Petchenegs (Patzinaks) continued their inroads, and in 1065 the Uzes (called by the Greeks Comani), a Turkish tribe from the shores of the Euxine, crossed the Danube in vast numbers, ravaged Thrace and Macedonia, and penetrated as far as Thessalonica. The empire was only saved by an outbreak of plague amongst the invaders and the bravery of the Bulgarian peasants. In the year before Constantine's death the remnant of the Byzantine possessions in Italy was finally lost to the empire, and the chief town, Bari, taken by the Normans.

For the later Constantines references to general authorities will be found under ROMAN EMPIRE, LATER; see also CALIPHATE and SELJUKS for the wars of the period.

CONSTANTINE [FLAVIUS CLAUDIUS CONSTANTINUS], usurper in Britain, Gaul and Spain (A.D. 407-410) during the reign of Honorius, was a common soldier, invested with the purple by his comrades in Britain by reason of his alleged descent from Constantine the Great. He at once crossed over to Bononia (Boulogne), and with the support of the Gallic troops soon made himself master of the country as far as the Alps and Pyrenees, and established his capital at Arelate (Arles). In Spain two kinsmen of Honorius, who offered considerable resistance, were finally defeated by Constans, the son of Constantine. The downfall of Stilicho caused an alteration in the policy of Honorius, who, hard pressed by the barbarians, pardoned Constantine, recognized him as joint ruler, and permitted him to confer the title of Caesar upon Constans. This gave Constantine his opportunity. With a large army he marched into Italy, avowedly to assist Honorius, in reality with the intention of making himself ruler of the West. But his plans were upset by the revolt of Gerontius. This capable general, who had been appointed commander in Spain during the absence of Constans on a visit to his father, indignant at being superseded, set up one of his own adherents as emperor, invaded Gaul, and put Constans to death at Vienna (*Vienna*). He then besieged Constantine himself in Arelate, but the advance of an Italian army under Constantius and Ulphilas forced him to retire. The generals of Honorius themselves continued the siege and completely defeated a body of German troops on their way to assist Constantine. The latter, seeing that further resistance was useless, took refuge in a church, laid down the imperial insignia, took orders as a priest, and surrendered the city on condition that his life should be spared. He and his younger son Julian were sent to Honorius, by whose orders they were put to death on the way to Ravenna. The revolt of Constantine materially influenced the subsequent history of Britain, since the virtual abandonment by Honorius of any claim to sovereignty over it cleared the way for the Saxon conquest of the island.

See Zosimus *v. ad fin.* and vi.; Sozomen, *Ecclesiastical History*, ix. 11 foll.; Gibbon's *Decline and Fall*, ed. J. B. Bury, pp. 272, 340, 502; E. A. Freeman, "Tyrants of Britain, Gaul and Spain" in *English Historical Review*, i. (1886); O. Seock in Pauly-Wissowa's *Realencyclopädie*, iv. pt. 1 (1900).

END OF SIXTH VOLUME.

